

**ES-50/ES-60W/ES-55R/ES-65WR
User's Guide**

Contents

ES-50/ES-60W/ES-55R/ES-65WR User's Guide	7
Scanner Basics	8
Scanner Parts Locations	8
Scanner Parts.....	8
Scanner Buttons and Lights.....	9
User Replaceable Epson Scanner Accessories	10
Changing the Power Save Settings.....	10
Charging the Battery (ES-60W/ES-65WR).....	12
Loading Originals	13
Loading Originals in the Input Slot.....	13
Original Document Specifications	20
Receipt Specifications	21
Special Original Specifications	22
Plastic Card Specifications.....	22
Wi-Fi Networking	23
Network Security Recommendations	23
Connecting to an Existing Wi-Fi Network	24
Manually Connecting to a Wi-Fi Network.....	25
Wi-Fi Protected Setup (WPS).....	25
Using WPS to Connect to a Network.....	25
Using WPS PIN Mode to Connect to a Network.....	26
Direct Wi-Fi Mode Setup	27
Enabling a Direct Wi-Fi Connection.....	28
Disabling Wi-Fi	28
Restoring Default Network Settings.....	28
Epson DocumentScan App for iOS/Android.....	29
Scanning	30
Scanning a Document in Epson ScanSmart.....	30
Saving a Scan	33
Attaching a Scan to E-mail	34

Sending a Scan to a Cloud Service	35
Printing a Scan	36
Saving a Scan as a Microsoft Office Format File	38
Selecting Epson ScanSmart Settings.....	39
Changing the Scanner	39
Changing the Scan Settings	41
Changing the File Name Settings	43
Changing the Save Settings	44
Save Settings	46
Customizing Action Icons	47
Scanning Receipts and Using Receipt Manager	49
Exporting Receipts to QuickBooks	53
Saving Receipt Data as a CSV File	54
Scanning Receipts as Image Files	54
Selecting Receipt Manager Settings	55
Exporting or Importing the Receipt Database	55
Changing Column Settings.....	56
Changing Currency and Language Settings.....	57
Scan Resolution Guidelines	59
Cleaning and Transporting Your Scanner.....	61
Cleaning Your Scanner	61
Cleaning Inside Your Scanner.....	61
Calibrating Your Scanner	63
Transporting Your Scanner	64
Solving Problems	65
Scanner Light Status	65
Solving Scanning Problems	68
Scanner Does Not Turn On or Off or Turns Off Unexpectedly	69
Scanner Button Does Not Start Scanning.....	70
Scanning Software Does Not Operate Correctly	70
Original Feeds Incorrectly in Scanner.....	71
Original Jams in Scanner.....	72
Scanning is Slow	73

Cannot Send Scans to a Cloud Service	73
Solving Network Scanning Problems	73
Cannot Scan Over a Network	74
Scanner Cannot Connect to a Wireless Router	74
Solving Scanned Image Quality Problems	76
Back of Original Image Appears in Scanned Image	76
Scanned Characters are Blurry	76
Characters are not Recognized During Conversion to Editable Text (OCR)	77
Ripple Patterns Appear in an Image	78
Spots or Lines Appear in All Scanned Images	78
Straight Lines in an Image Appear Crooked	78
Scanned Image is Cropped	78
Resetting the Epson Scan 2 Settings	79
Uninstall Your Scanner Software.....	79
Uninstalling Scanner Software - Windows	80
Uninstalling Scanner Software - Mac.....	80
Where to Get Help.....	81
Technical Specifications	83
Windows System Requirements	83
Mac System Requirements	83
General Specifications	84
Dimension Specifications	85
Electrical Specifications	86
Environmental Specifications	87
Network Interface Specifications (ES-60W/ES-65WR)	87
Safety and Approvals Specifications	88
Notices	89
Important Safety Instructions.....	89
Battery Safety Instructions (ES-60W/ES-65WR).....	91
Restrictions on Copying	91
Default Delay Times for Power Management for Epson Products.....	92
Binding Arbitration and Class Waiver	92
Trademarks	95

Copyright Notice.....	96
libTIFF Software Acknowledgment.....	96
A Note Concerning Responsible Use of Copyrighted Materials.....	97
Copyright Attribution	97

ES-50/ES-60W/ES-55R/ES-65WR User's Guide

Welcome to the ES-50/ES-60W/ES-55R/ES-65WR *User's Guide*.

For a printable PDF copy of this guide, [click here](#).

Scanner Basics

See these sections to learn about the basic features of your scanner.

[Scanner Parts Locations](#)

[Changing the Power Save Settings](#)

[Charging the Battery \(ES-60W/ES-65WR\)](#)

Scanner Parts Locations

See these sections to identify the parts on your scanner.

[Scanner Parts](#)

[Scanner Buttons and Lights](#)

[User Replaceable Epson Scanner Accessories](#)

Parent topic: [Scanner Basics](#)

Scanner Parts

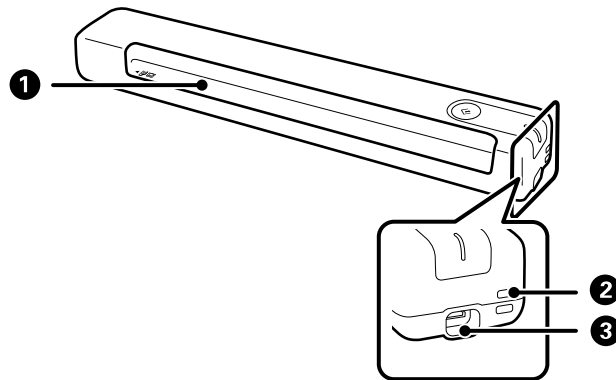

Note: The illustrations show the ES-50/ES-55R, but the parts are the same for the ES-60W/ES-65WR.



- 1 Input slot
- 2 Loop hole
- 3 USB port

Parent topic: [Scanner Parts Locations](#)

Scanner Buttons and Lights

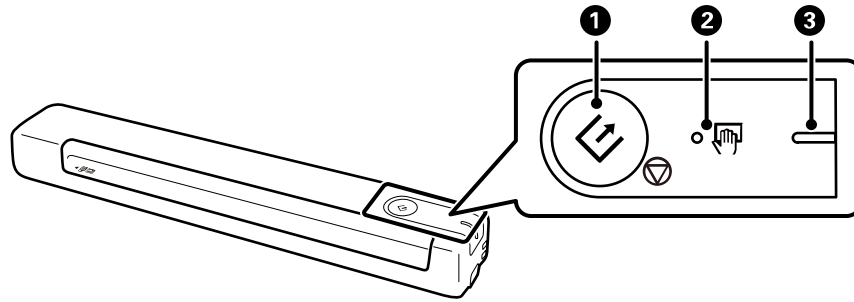





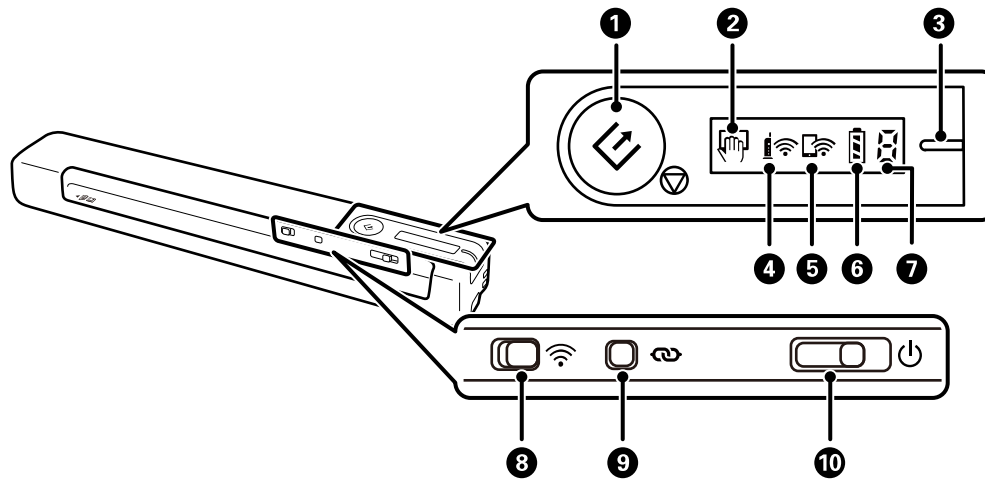

ES-50/ES-55R



- 1  start button
- 2  automatic feeding mode light
- 3 Ready light

ES-60W/ES-65WR



- 1  start button
- 2  automatic feeding mode light
- 3 Ready light
- 4  Wi-Fi light
- 5  Wi-Fi AP light
- 6  battery light
- 7 Error status light
- 8  Wi-Fi switch
- 9  Wi-Fi connect button
- 10  power switch

Parent topic: [Scanner Parts Locations](#)

User Replaceable Epson Scanner Accessories

You can purchase genuine Epson accessories at epson.com (U.S. sales), epson.ca (Canadian sales), or epson.com.jm (Caribbean sales). You can also purchase accessories from an Epson authorized reseller. To find the nearest one, call 800-GO-EPSON (800-463-7766) in the U.S. or 800-807-7766 in Canada.

Part	Part number
Carrier sheet for portable scanners	B12B819451
Maintenance sheet kit 2	B12B819481

Parent topic: [Scanner Parts Locations](#)

Changing the Power Save Settings

You can use the Epson Scan 2 Utility to change the time period before the scanner enters sleep mode and turns off automatically.

1. Do one of the following to access the Epson Scan 2 Utility:
 - **Windows 10:** Click  and select **EPSON > Epson Scan 2 Utility**.
 - **Windows 8.x:** Navigate to the **Apps** screen and select **Epson Scan 2 Utility**.

- **Windows (other versions):** Click  or **Start**, and select **All Programs** or **Programs**. Select **EPSON > Epson Scan 2 Utility**.
- **Mac:** Open the **Applications** folder, open the **Epson Software** folder, and select **Epson Scan 2 Utility**.

2. Click the **Power Save** tab.

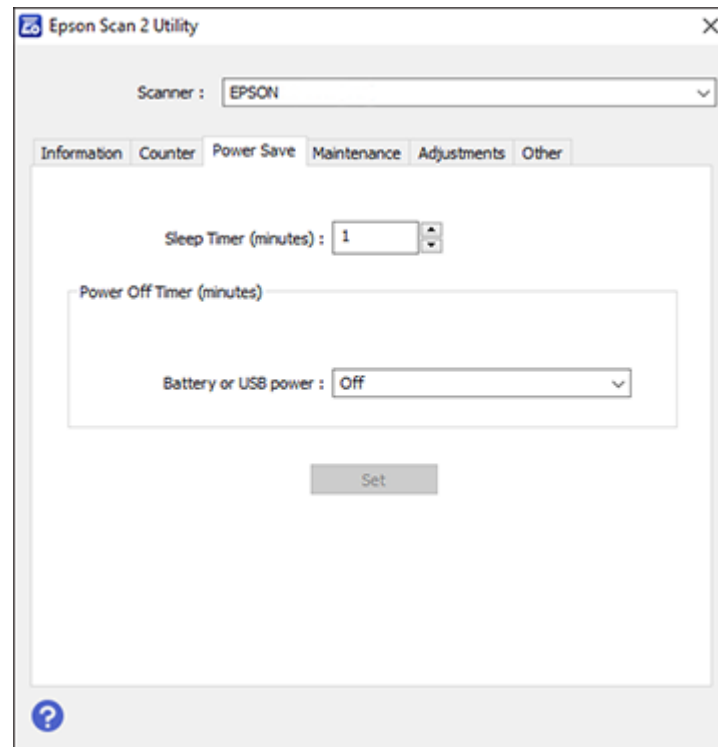

3. Select the length of time after which you want the scanner to go to sleep as the **Sleep Timer** setting.
4. Select a power off timer setting for the **Battery or USB power** setting (ES-60W/ES-65WR).
5. Click **Set**.
6. Close the Epson Scan 2 Utility.

Parent topic: [Scanner Basics](#)

Charging the Battery (ES-60W/ES-65WR)

The scanner runs on battery power when it is not connected to the computer with a USB cable, or if it is connected via Wi-Fi. You can charge the battery from a computer with a USB connection to the scanner.

1. Make sure that the computer is turned on and not in sleep mode.
2. Connect the scanner to the computer using the micro USB cable that came with the scanner.

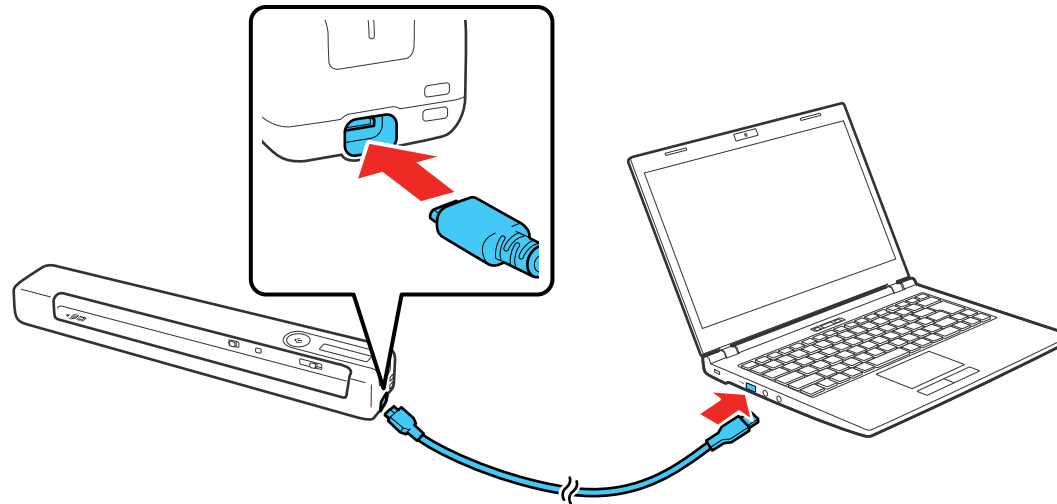

3. Slide the  power switch to turn on the scanner.

The  battery light flashes and shows the battery level while the battery is charging. When charging is complete, the battery level is shown as full. If the scanner is off when charging completes, the battery light turns off.

Note: The battery takes about 3.5 hours to fully charge. Charging times increase if the scanner is on during the charging process.

Parent topic: [Scanner Basics](#)

Loading Originals

Follow the instructions here to load your originals into the scanner.

[Loading Originals in the Input Slot](#)

[Original Document Specifications](#)

[Receipt Specifications](#)

[Special Original Specifications](#)

[Plastic Card Specifications](#)

Loading Originals in the Input Slot

You can load an original that meets the document specifications in the input slot.

Caution: Do not load photos, or valuable original documents or artwork, directly into the scanner. This may wrinkle or damage the original.

Note: The illustrations show the ES-50/ES-55R model, but the steps are the same for the ES-60W/ES-65WR.

- For standard size originals, slide your original into the input slot against the left side as shown until it meets resistance. Make sure the printed side is faceup and top edge first.

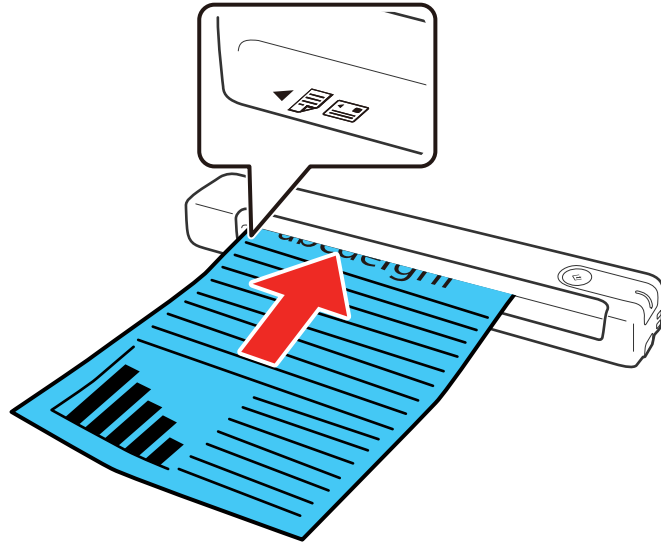

- For longer originals, slide your original into the input slot against the left side as shown until it meets resistance. Make sure the printed side is faceup and top edge first. Set the paper size in the scanning program and support the original as it enters into and ejects from the scanner.

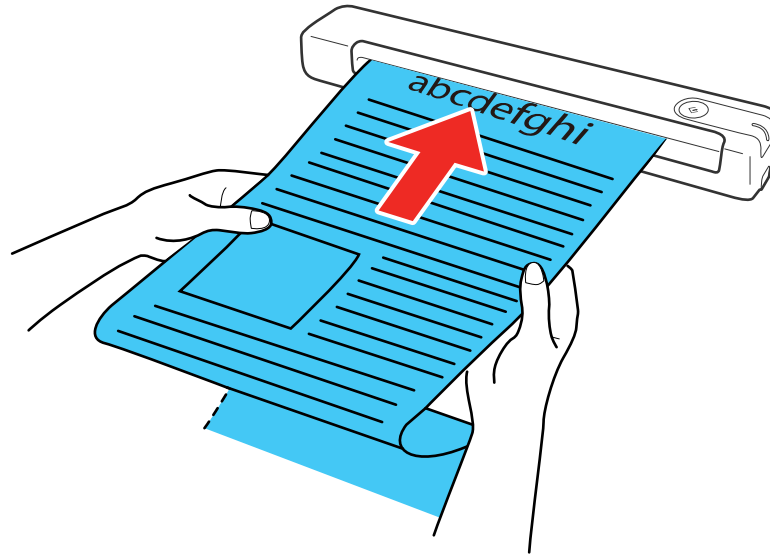

- For receipts, support the original by hand and load it into the input slot against the left side as shown until it meets resistance. Make sure the printed side is faceup and top edge first.

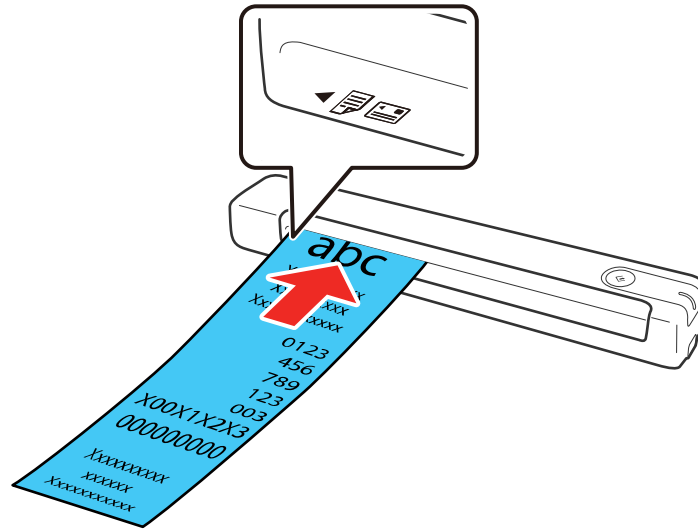

- For envelopes, slide the original into the input slot against the left side as shown until it meets resistance. Make sure the printed side is faceup and the flap is facing as shown. For envelopes with the flap on the shorter side, load the envelope with the flap side last.

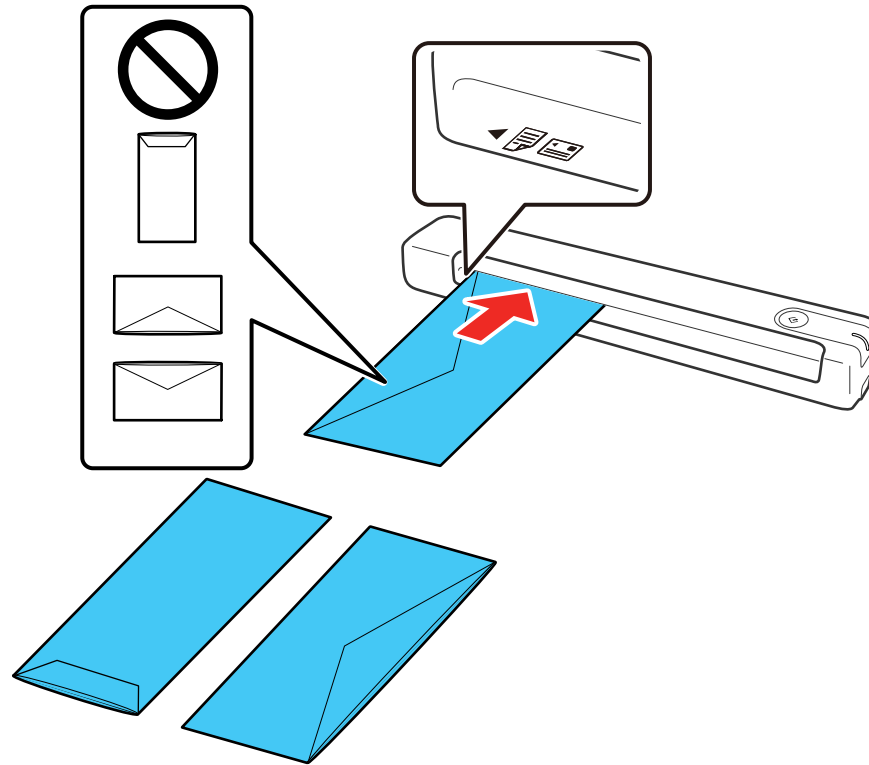

Caution: Do not load envelopes with adhesives on them.

- For plastic cards, load the card horizontally into the input slot against the left side as shown until it meets resistance. Make sure the printed side is faceup.

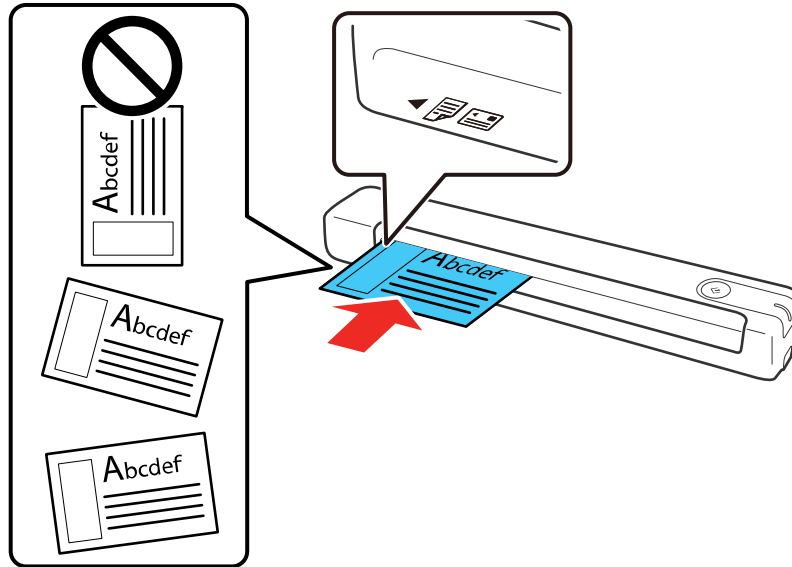

Caution: Do not load plastic cards vertically or at an angle.

- For irregularly shaped originals, use an optional carrier sheet (part number B12B819451). Make sure the illustration on the front edge of the carrier sheet is faceup with the original faceup against the left

side. Slide the carrier sheet top edge first into the input slot against the left side as shown until it meets resistance.

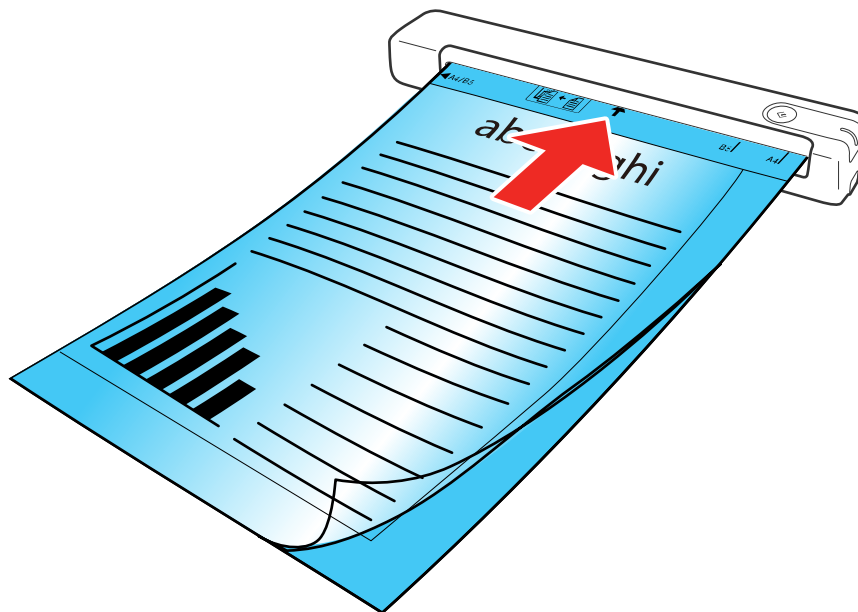
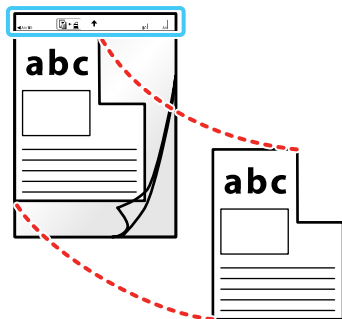

Note: Only use the carrier sheet designed for your scanner. If the carrier sheet is scratched or has been scanned more than 3,000 times, stop using it and obtain a new one.

Parent topic: [Loading Originals](#)

Related references[Original Document Specifications](#)[Receipt Specifications](#)[Special Original Specifications](#)[Plastic Card Specifications](#)[User Replaceable Epson Scanner Accessories](#)**Original Document Specifications**

You can load original documents that meet these specifications in your scanner.

Note: To scan delicate originals or originals that are easily wrinkled, use an optional carrier sheet (part number B12B819451).

Paper type	Paper size	Paper weight
Plain paper Fine paper Recycled paper	Letter (8.5 × 11 inches [216 × 279 mm])	9 to 72 lb (35 to 270 g/m ²)
	Legal (8.5 × 14 inches [216 × 356 mm])	
	A4 (8.3 × 11.7 inches [210 × 297 mm])	
	A5 (5.8 × 8.2 inches [148 × 210 mm])	
	B5 (7.2 × 10.1 inches [182 × 257 mm])	
	B6 (5 × 7.2 inches [128 × 182 mm])	
	A6 (4.1 × 5.8 inches [105 × 148 mm]) A7 (2.9 × 4.1 inches [74 × 105 mm]) A8 (2.1 × 2.9 inches [52 × 74 mm])	12 to 72 lb (46 to 270 g/m ²)
Long paper	Width: 2.0 to 8.5 inches (50.8 to 216 mm) Height: 2.0 to 72 inches (50.8 to 1828.8 mm)	9 to 72 lb (35 to 270 g/m ²)
Postcards	3.9 × 5.8 inches (100 × 148 mm)	9 to 72 lb (35 to 270 g/m ²)
Paper business cards	2.1 × 3.4 inches (55 × 89 mm)	12 to 72 lb (46 to 270 g/m ²)

Caution: Do not load the following types of originals in the scanner, or they may be damaged or may damage the scanner:

- Originals with an uneven surface such as letterhead paper
- Originals with crinkles or fold lines
- Curled originals
- Coated paper
- Originals with punch holes
- Originals with folded corners
- Photos or photo paper*
- Originals with labels or stickers*
- Originals with staples or paper clips
- Originals with sticky notes attached*
- Ripped originals*
- Originals with carbon paper backing*
- Perforated originals*
- Booklets
- Non-paper originals such as clear files, fabric, and metal foil
- Originals with glue attached
- Heavily wrinkled or curled originals
- Transparent originals such as overhead projector film
- Originals with wet ink

*You can only scan these originals by using the carrier sheet.

Parent topic: [Loading Originals](#)

Receipt Specifications

You can load 1 receipt at a time that meets these specifications in your scanner.

Paper type	Paper size	Paper thickness
Receipts (plain paper, fine paper, or recycled paper)	3 × 3 inches (76.2 × 76.2 mm) to 3 × 14 inches (76.2 × 355.6 mm)	12 to 72 lb (46 to 270 g/m ²)

Note: Scan receipts one at a time using automatic feeding mode. Support a long original receipt by hand as it enters and exits the scanner.

Parent topic: [Loading Originals](#)

Special Original Specifications

You can load 1 envelope or irregularly shaped original that meets these specifications in your scanner.

Paper type	Paper size	Paper thickness
Envelopes	4.72 × 9.25 inches (120 × 235 mm) 3.62 × 6.50 inches (92 × 165 mm)	0.015 inch (0.38 mm) or less
Irregularly shaped original (in carrier sheet)	Up to A4 (8.3 × 11.7 inches [210 × 297 mm])	0.012 inch (0.3 mm) or less (excluding the thickness of the carrier sheet)

Parent topic: [Loading Originals](#)

Plastic Card Specifications

You can load 1 plastic card that meets these specifications in your scanner.

Card type	Card size	Card thickness
With embossing	ISO7810 ID-1 compliant: 2.1 × 3.3 inches (54 × 85.6 mm)	0.05 inch (1.24 mm) or less
Without embossing		0.04 inch (1.0 mm) or less

Note: ISO7810 ID-1 size laminated cards (thickness of 0.02 inch [0.6 mm] or less) may not be scanned successfully.

Parent topic: [Loading Originals](#)

Wi-Fi Networking

See these sections to use your scanner over a Wi-Fi network (ES-60W/ES-65WR).

[Network Security Recommendations](#)

[Connecting to an Existing Wi-Fi Network](#)

[Direct Wi-Fi Mode Setup](#)

[Epson DocumentScan App for iOS/Android](#)

Network Security Recommendations

To help deter unauthorized access to your product over a network, you should protect your network environment using appropriate security measures.

Security measures such as these can help deter threats such as loss of user data, use of telephone and fax lines, and other intrusions:

- **Enable security on your wireless LAN**

Enable the appropriate security on the wireless LAN you plan to use with your product. Network security such as a network password can deter interception of traffic over the wireless LAN. Your router may already have a default password enabled by your Internet service provider (ISP). See your ISP and router documentation for instructions on how to change the default password and better secure your network.

- **Connect your product only to a network protected by a firewall**

Connecting your product directly to the Internet may leave it vulnerable to security threats. Instead, connect it to a router or other network connection protected by a firewall. Your router may already have a firewall set up by your Internet service provider; check with your ISP for confirmation. For best results, set up and use a private IP address for your network connection.

- **Change the default administrator password on your product**

If your product has an option to set an administrator password, change the default administrator password to deter access by unauthorized users to personal data stored on your product, such as IDs, passwords, and contact lists.

Parent topic: [Wi-Fi Networking](#)

Connecting to an Existing Wi-Fi Network

You can set up your scanner to communicate with your computer using a wireless router. The wireless router can be connected to your computer over a wireless or wired network.

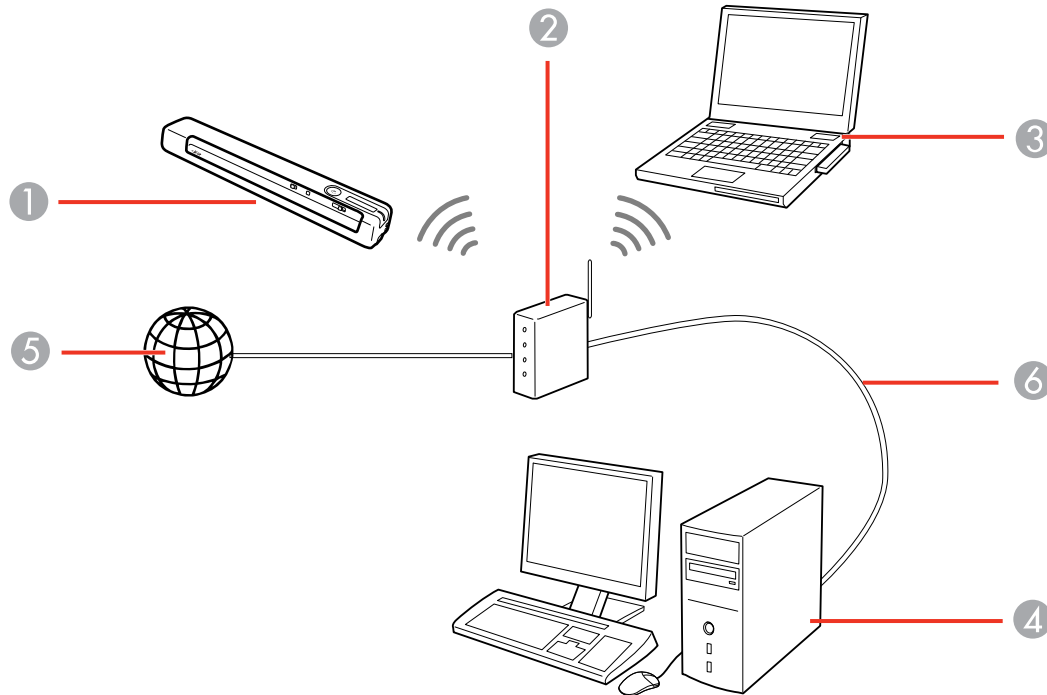

- 1 Epson scanner
- 2 Wireless router
- 3 Computer with a wireless interface
- 4 Computer
- 5 Internet
- 6 Ethernet cable (used only for wired connection from the computer to the wireless router)

[Manually Connecting to a Wi-Fi Network](#)
[Wi-Fi Protected Setup \(WPS\)](#)

Parent topic: [Wi-Fi Networking](#)

Manually Connecting to a Wi-Fi Network

You can use your product's software installer to connect the scanner to a Wi-Fi network.

Note: You must have a computer with a wireless adapter to set up the connection.

1. See the *Start Here* sheet for instructions on downloading and installing your scanner's software.

Note: The scanner powers off after 1 minute of inactivity. If the scanner turns off during the procedure, you may need to repeat some of the steps.

2. Select the wireless connection method for the scanner when prompted.

The scanner is added to the network and connected to the computer for network scanning.

Parent topic: [Connecting to an Existing Wi-Fi Network](#)

Wi-Fi Protected Setup (WPS)

If your network uses a WPS-enabled wireless router, you can quickly connect your scanner to the network using Wi-Fi Protected Setup (WPS).

Note: To check if your router is WPS-enabled, look for a button labeled **WPS** on your router. If there is no hardware button, there may be a WPS setting in the software for the device. Check your network product documentation for details.



[Using WPS to Connect to a Network](#)

[Using WPS PIN Mode to Connect to a Network](#)

Parent topic: [Connecting to an Existing Wi-Fi Network](#)



Using WPS to Connect to a Network

If you have a WPS-enabled wireless router, you can use Wi-Fi Protected Setup (WPS) to connect your scanner to the network.



1. Follow the instructions on the *Start Here* sheet to install the scanner software on your computer.
2. Make sure the scanner is turned on.
3. Set the  Wi-Fi switch to the  Wi-Fi position.



4. Enable WPS on your router by pressing the **WPS** button or enabling the WPS setting in your router firmware.

The router enters WPS discovery mode for 2 minutes.

5. Press and hold the  Wi-Fi connect button on the scanner until the ready,  Wi-Fi, and  Wi-Fi AP lights flash alternately.

Note: If you do not complete this step within 2 minutes, repeat these steps to try again.







When the ready,  Wi-Fi, and  Wi-Fi AP lights on the scanner stay on, the scanner is connected to the network.

Note: If the ready light stays on, but the  Wi-Fi and  Wi-Fi AP lights flash simultaneously, connection has failed. Restart the scanner and router, move them closer together, and repeat these steps to try again.

Parent topic: [Wi-Fi Protected Setup \(WPS\)](#)

Using WPS PIN Mode to Connect to a Network

If you have a WPS-enabled wireless router that supports PIN mode, you can use Wi-Fi Protected Setup (WPS) PIN mode to connect your scanner to the network.



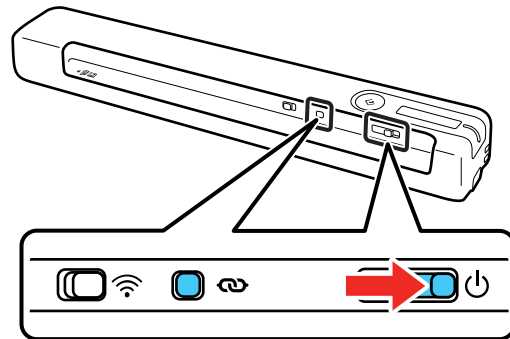

1. Follow the instructions on the *Start Here* sheet to install the scanner software on your computer.
2. Find the WPS PIN number setting in your router's firmware.
3. Make sure the scanner is turned off and set the  Wi-Fi switch to the  Wi-Fi position.
4. Press and hold the  Wi-Fi connect button and slide and hold the  power switch for about ten seconds until the ready,  Wi-Fi and  Wi-Fi AP lights flash alternately.



The scanner enters WPS discovery mode for two minutes.

5. Use your computer to enter the PIN code **01234565** into the WPS PIN number setting in the router firmware within two minutes.

Note: If you do not enter the code within 2 minutes, repeat the steps to try again.

Connection setup starts when the ready light flashes, and the  Wi-Fi and  Wi-Fi AP lights flash alternately. When the ready,  Wi-Fi, and  Wi-Fi AP lights on the scanner stay on, the scanner is connected to the network.

Parent topic: [Wi-Fi Protected Setup \(WPS\)](#)

Direct Wi-Fi Mode Setup

You can set up your scanner to communicate directly with your computer or another device without requiring a wireless router. If your product is not already connected to a wireless network, it enters access point mode and the scanner itself acts as the network access point.

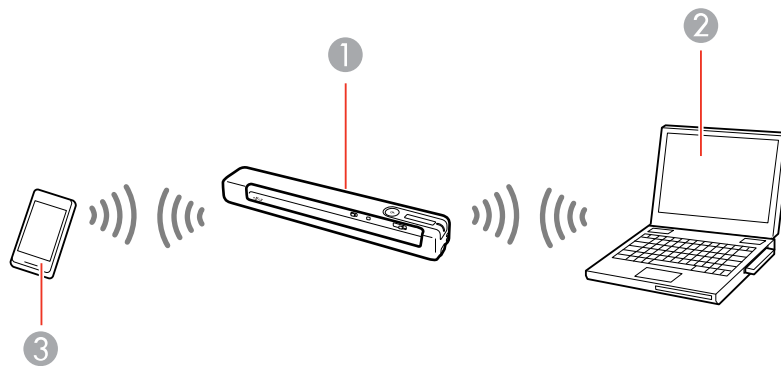

- 1 Epson scanner
- 2 Computer with a wireless interface
- 3 Other wireless device

[Enabling a Direct Wi-Fi Connection](#)

[Disabling Wi-Fi](#)



[Restoring Default Network Settings](#)

Parent topic: [Wi-Fi Networking](#)

Enabling a Direct Wi-Fi Connection

You can enable a direct Wi-Fi connection to allow direct communication between your scanner and computer or other devices without a wireless router.

Note: While you are connected to the scanner, your computer cannot access the internet.

1. Set the  Wi-Fi switch on the scanner to the  Wi-Fi position.
2. Turn on the scanner.
3. From your computer or device, search for and select the SSID shown on the label on the bottom of the scanner.

Note: It may take a few minutes for the scanner SSID to appear in the list.

4. Enter the password shown on the label on the bottom of the scanner.

The computer connects to the scanner's wireless network. If the connection is unsuccessful, make sure you entered the password correctly.

Parent topic: [Direct Wi-Fi Mode Setup](#)

Disabling Wi-Fi

You may need to disable your product's Wi-Fi if you need to solve a problem with your network connection.



Note: Before disabling Wi-Fi, make a note of any network settings selected for Epson DocumentScan.



Set the  Wi-Fi switch on the scanner to the off position.

Parent topic: [Direct Wi-Fi Mode Setup](#)



Restoring Default Network Settings

If you need to solve a problem with your network connection, you can restore all network settings to their defaults.

1. Make sure the scanner is turned off.
2. Set the  Wi-Fi switch on the scanner to the  Wi-Fi position.

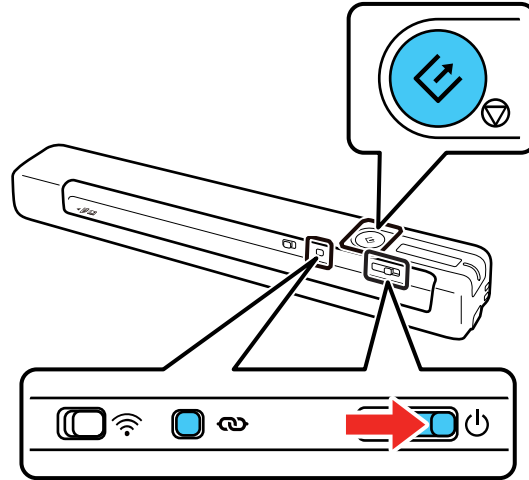
3. Press and hold the  Wi-Fi connect and  start buttons and slide and hold the  power switch for about ten seconds to turn on the scanner.



The  Wi-Fi and  Wi-Fi AP lights flash alternately and the ready light flashes. The default network settings are restored when the lights stop flashing.

Parent topic: [Direct Wi-Fi Mode Setup](#)

Epson DocumentScan App for iOS/Android

You can use the Epson DocumentScan app to scan from a network scanner to an iOS or Android device over a direct Wi-Fi connection (ES-60W/ES-65WR).

For more information about Epson DocumentScan, search for the app on the App Store (iOS) or Google Play (Android).

Parent topic: [Wi-Fi Networking](#)

Scanning

You can scan your originals and save them as digital files.

[Scanning a Document in Epson ScanSmart](#)

[Selecting Epson ScanSmart Settings](#)

[Scanning Receipts and Using Receipt Manager](#)

[Selecting Receipt Manager Settings](#)

[Scan Resolution Guidelines](#)



Scanning a Document in Epson ScanSmart

You can scan and review documents in Epson ScanSmart.

Note: The images show Windows screens; Mac screens may be slightly different.

1. Load your original into the scanner.
2. Start the scan by doing one of the following:
 - Press the  start button on the scanner. Epson ScanSmart automatically opens on your computer and the scan job begins.

Note: You can change the scanning button default in the  **Settings** menu.

- Open Epson ScanSmart on your computer. Do one of the following:
 - **Windows 10:** Click  > **Epson Software** > **Epson ScanSmart**.
 - **Windows 8.x:** Navigate to the **Apps** screen and select **Epson ScanSmart**.
 - **Windows (other versions):** Click  or **Start**, and select **All Programs** or **Programs**. Select **Epson Software** > **Epson ScanSmart**.
 - **Mac:** Open the **Applications** folder, open the **Epson Software** folder, and select **Epson ScanSmart**.

You see a screen like this:

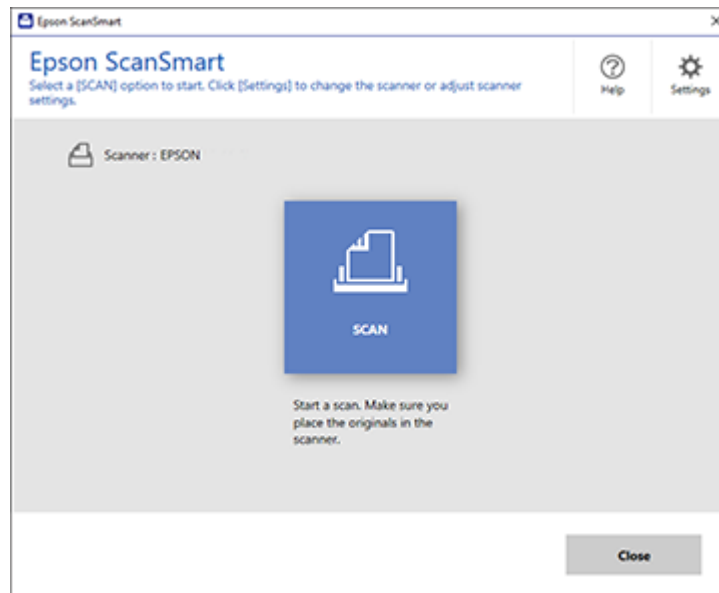

3. Select the scan option.

The scan job begins and your original feeds through the scanner. When scanning is complete, you see a screen like this:

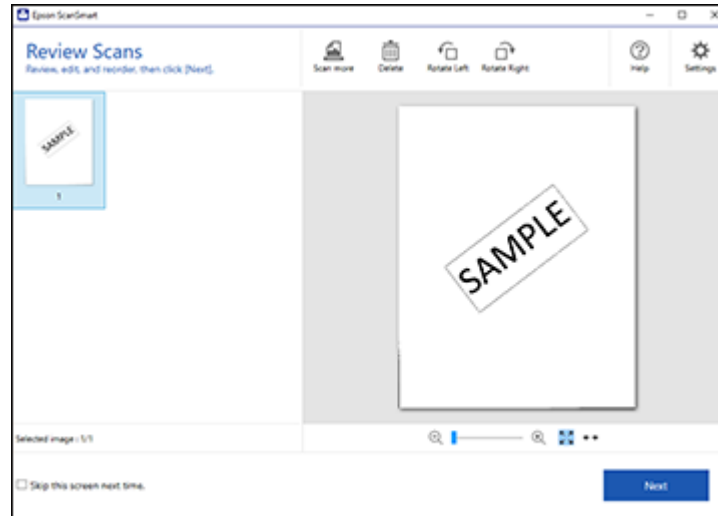

4. You can review, edit, or reorder the scanned image(s) as follows:
 - Select **Scan more** to scan more originals.
 - Select **Delete** to delete selected scanned images.
 - Select a rotate option to rotate each scanned image.
5. When you are finished reviewing the scanned images, click **Next**.

You see a screen like this:

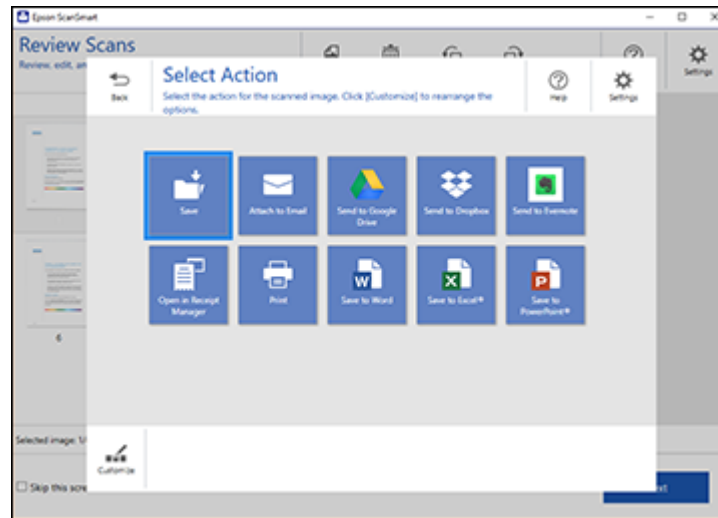

6. Select an option to save, send, or print the scanned images. See the links below.

[Saving a Scan](#)

[Attaching a Scan to E-mail](#)

[Sending a Scan to a Cloud Service](#)

[Printing a Scan](#)

[Saving a Scan as a Microsoft Office Format File](#)

Parent topic: [Scanning](#)

Related tasks

[Customizing Action Icons](#)

[Loading Originals in the Input Slot](#)

Saving a Scan

You can save a scanned image to your computer as a PDF, searchable PDF, or JPEG file.

1. Make sure your originals are scanned and reviewed. See the link below.
2. In the **Select Action** window, click **Save**.

You see a screen like this:

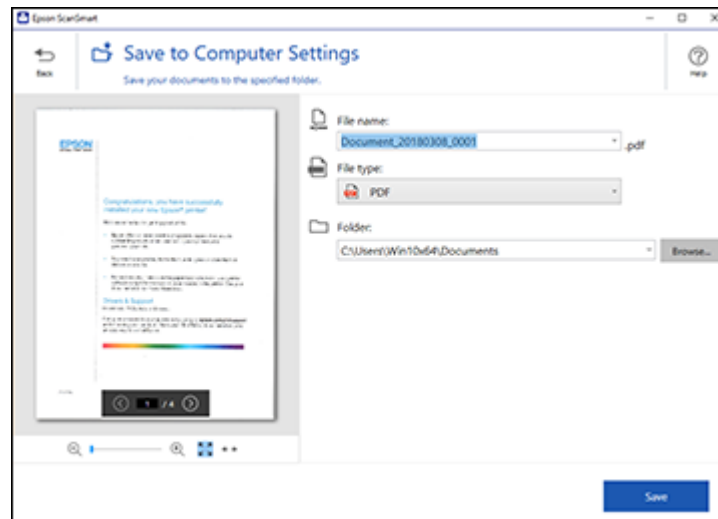

3. Change the settings as follows:
 - The document type and scan date for the file name are automatically detected. You can change them as necessary.
 - You can save the scanned image as a PDF, JPEG, or searchable PDF file. If you select searchable PDF, you can select the OCR (Optical Character Recognition) language.
 - Select the folder on your computer where the document is saved.
4. Click **Save**.

Parent topic: [Scanning a Document in Epson ScanSmart](#)

Attaching a Scan to E-mail

You can attach a scanned image to an e-mail as a PDF or JPEG file attachment.

Note: Your e-mail app and account settings should be configured before scanning.

1. Make sure your originals are scanned and reviewed. See the link below.
2. In the **Select Action** window, click **Attach to Email**.

You see a screen like this:

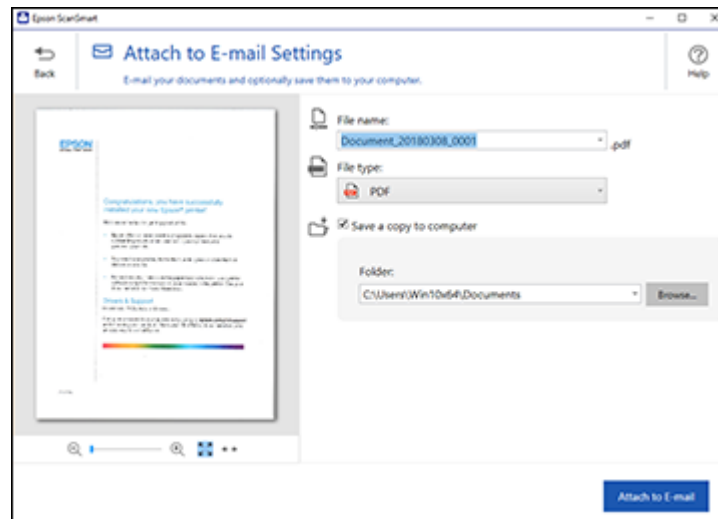

3. Change the settings as follows:
 - The document type and scan date for the file name are automatically detected. You can change them as necessary.
 - You can save the scanned image as a PDF, JPEG, or searchable PDF file. If you select searchable PDF, you can select the OCR language.
 - If you also want to save a copy of the scanned image to your computer, click the checkbox. Select the folder on your computer where the document is saved.

4. Click **Attach to E-mail**.

Your e-mail program opens with the file attached to a new e-mail.

Parent topic: [Scanning a Document in Epson ScanSmart](#)

Sending a Scan to a Cloud Service

You can upload scanned images to a cloud service.

1. Make sure your originals are scanned and reviewed. See the link below.
2. In the **Select Action** window, click one of the cloud service send options.

You see a screen like this:

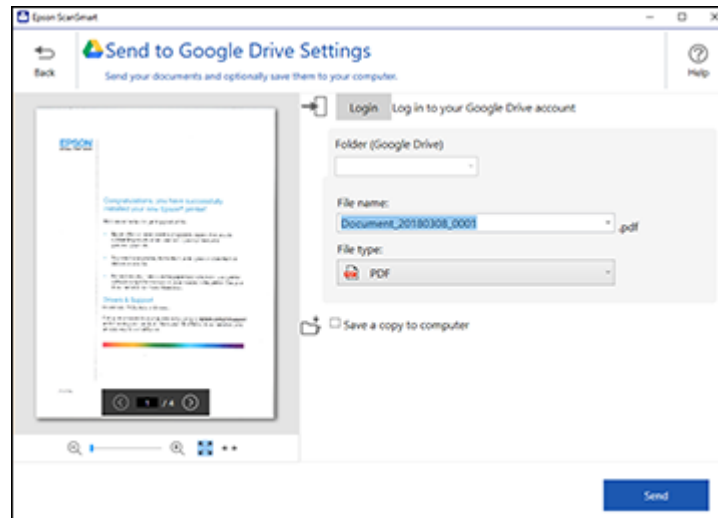

3. Log in to your account.

Note: You may need to allow Epson ScanSmart access to your account. The first time you log in, you may be prompted to enter an authentication code.

4. Change the settings as follows:
 - Select the folder in your account where you want to send the document.
 - The document type and scan date for the file name are automatically detected. You can change them as necessary.
 - You can save the scanned image as a PDF, JPEG, or searchable PDF file. If you select searchable PDF, you can select the OCR language.
 - If you also want to save a copy of the scanned image to your computer, click the checkbox.
5. Click **Send**.

Parent topic: [Scanning a Document in Epson ScanSmart](#)

Printing a Scan

You can print your scanned image and save the scanned file to your computer.

Note: Printing scanned images is available only with Epson printers.

1. Make sure your originals are scanned and reviewed. See the link below.
2. In the **Select Action** window, click **Print**.

You see a screen like this:

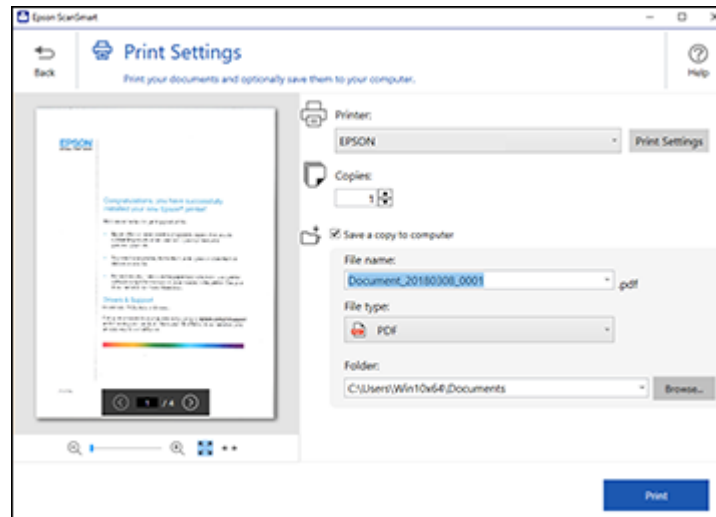

3. Change the settings as follows:
 - Select the Epson printer and change the print settings, if necessary.
 - Select the number of copies you want to print.
 - If you also want to save a copy of the scanned image to your computer, click the checkbox.
 - The document type and scan date for the file name are automatically detected. You can change them as necessary.
 - You can save the scanned image as a PDF, JPEG, or searchable PDF file. If you select searchable PDF, you can select the OCR language.
 - Select the folder on your computer where the document is saved.
4. Click **Print**.

Parent topic: [Scanning a Document in Epson ScanSmart](#)

Saving a Scan as a Microsoft Office Format File

You can save your scans in one of the following editable Microsoft Office file formats: Microsoft Word (.docx), Microsoft Excel (.xlsx), or Microsoft PowerPoint (.pptx).

Note: The **Save to PowerPoint** option is only available for Windows.

1. Make sure your originals are scanned and reviewed. See the link below.
2. In the **Select Action** window, click one of the save to options.

Note: A first-time prompt may appear asking you to download a Microsoft Office plug-in. Click **Yes** and follow any on-screen instructions.

You see a screen like this:

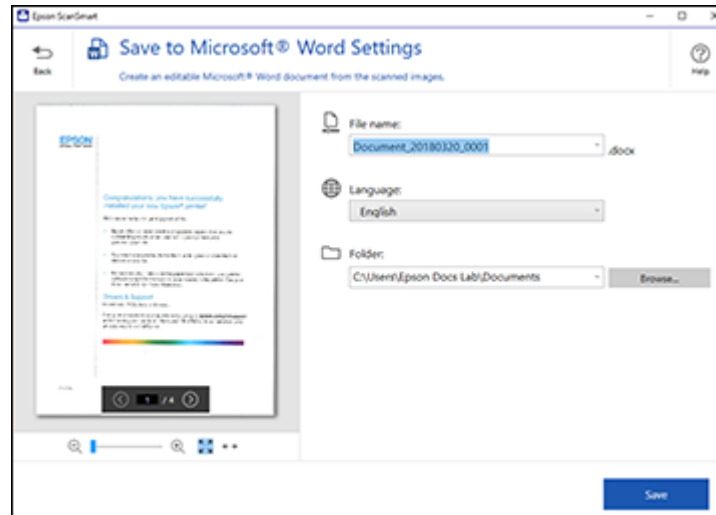

3. Change the settings as follows:
 - The document type and scan date for the file name are automatically detected. You can change them as necessary.
 - Select the OCR language (the default is English).
 - Select the folder on your computer where the document is saved.

4. Click **Save**.

Parent topic: [Scanning a Document in Epson ScanSmart](#)

Selecting Epson ScanSmart Settings

After starting Epson ScanSmart, you can change various scanning settings.

[Changing the Scanner](#)

[Changing the Scan Settings](#)

[Changing the File Name Settings](#)

[Changing the Save Settings](#)

[Save Settings](#)

[Customizing Action Icons](#)

Parent topic: [Scanning](#)

Changing the Scanner

If you are using more than one scanner, you can change the scanner that you are using with your computer.

Note: A scanner connected to your computer via USB takes priority over a scanner with a Wi-Fi connection.

1. Click the  **Settings** button.

You see a screen like this:

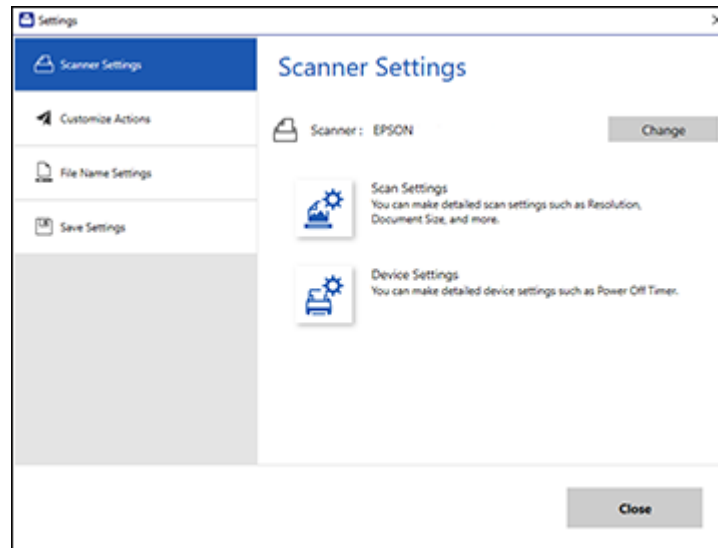

2. On the **Scanner Settings** tab, click **Change**.

You see a screen like this:

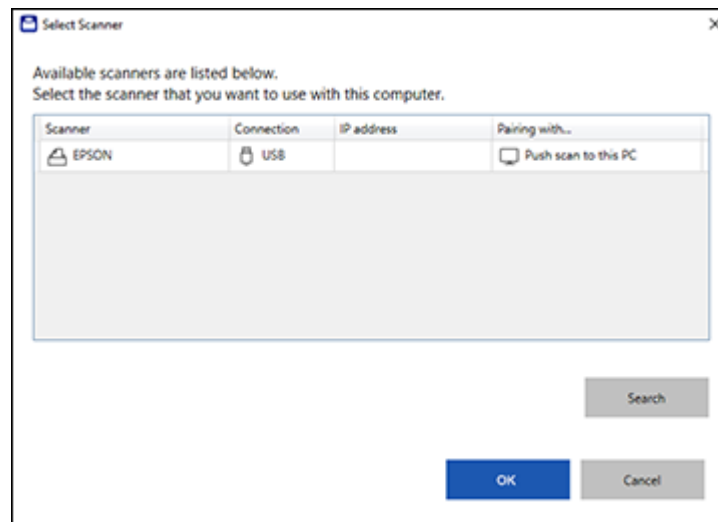

3. Select the scanner you want to use with your computer and click **OK**.

Parent topic: [Selecting Epson ScanSmart Settings](#)

Changing the Scan Settings

You can change detailed scan settings such as the resolution, document size, and more.

1. Click the  **Settings** button.

You see a screen like this:

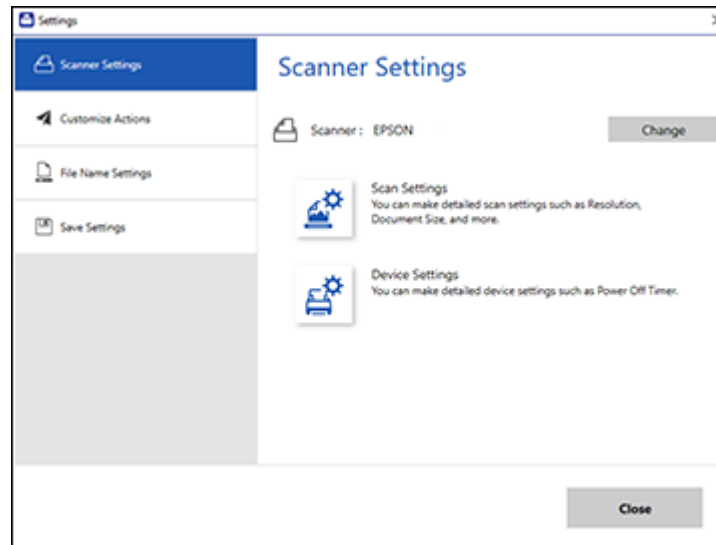

2. On the **Scanner Settings** tab, click **Scan Settings**.

You see a screen like this:

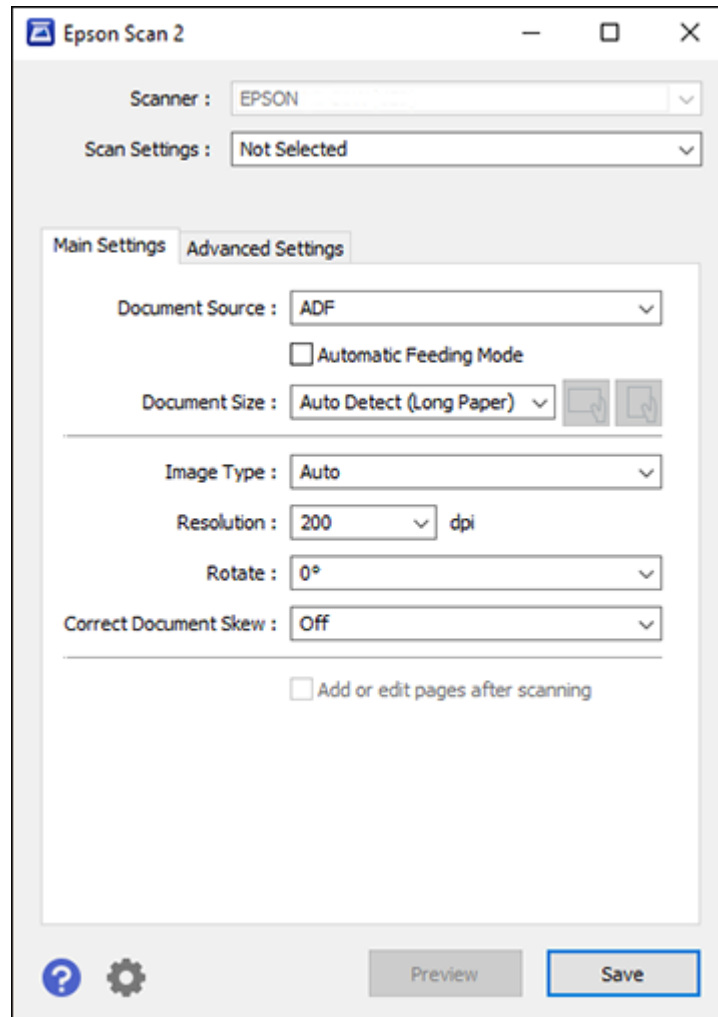

3. Change the settings as necessary and click **Save**.

Parent topic: [Selecting Epson ScanSmart Settings](#)

Changing the File Name Settings

You can change the default file naming method for your scans.

1. Click the  **Settings** button.

You see a screen like this:

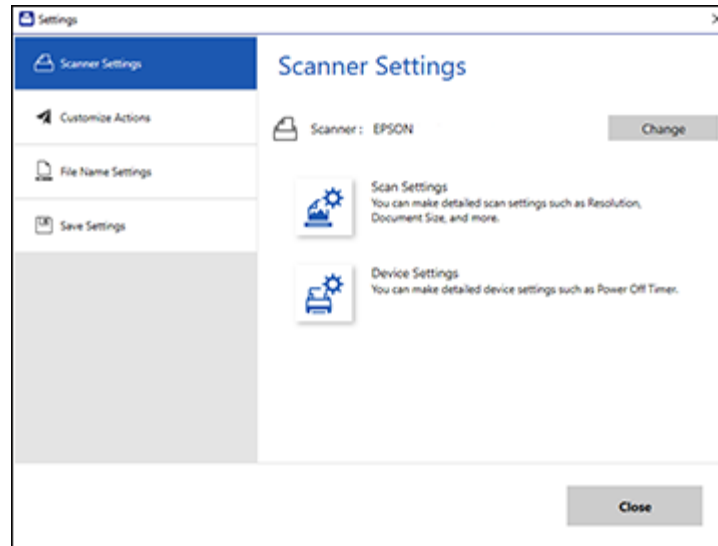

2. Click the **File Name Settings** tab.

You see a screen like this:

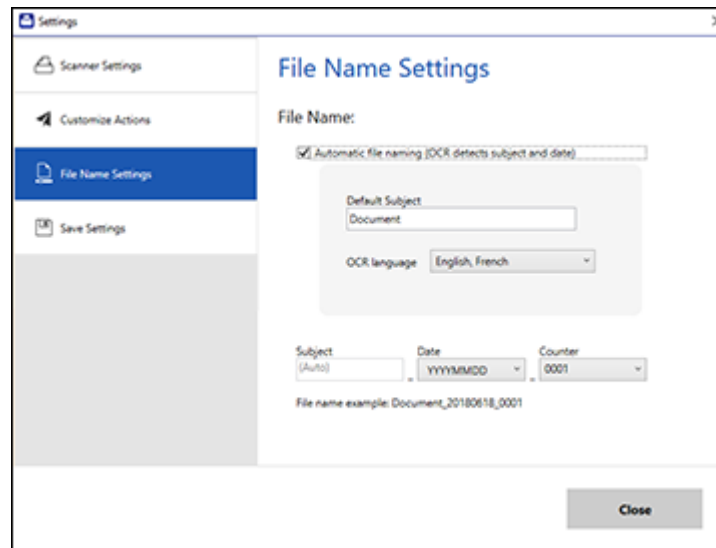

3. Change the settings as necessary:

- Make sure the **Automatic file naming** checkbox is selected if you want OCR to automatically detect the subject and date and add them to the file name. You can enter a file name that will be used if OCR cannot detect the subject.
- Select the OCR language.
- Select the date format.

4. Click **Close**.

Parent topic: [Selecting Epson ScanSmart Settings](#)

Changing the Save Settings

You can change the file type options for saving your scans.

1. Click the  **Settings** button.

You see a screen like this:

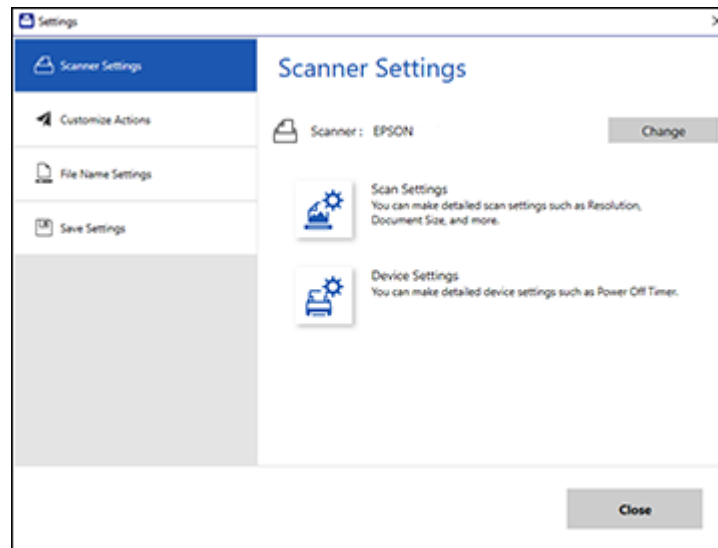

2. Click the **Save Settings** tab.

You see a screen like this:

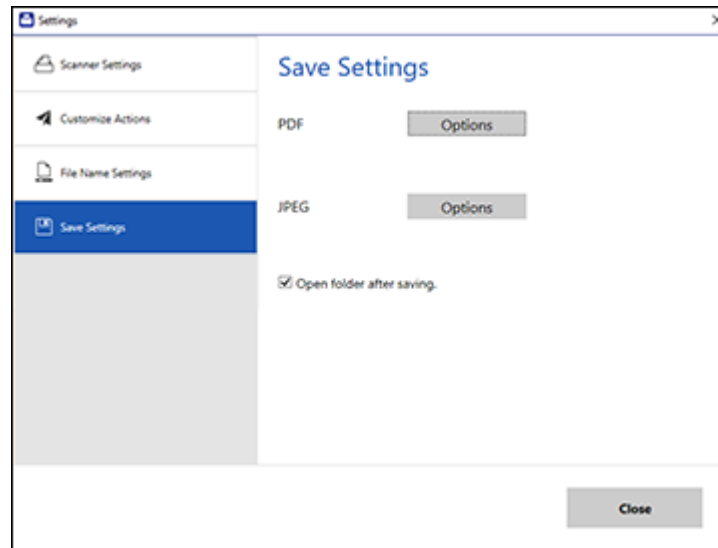

3. Click **Options** for PDF or JPEG and change the settings as necessary.
4. Click **Close**.

Parent topic: [Selecting Epson ScanSmart Settings](#)

Save Settings

You can change the settings for how scanned images are saved as PDFs or JPEGs.

PDF Options

Setting	Options	Description
General	Generate PDF/A File	Creates a PDF that conforms to PDF/A-1 standards
	Create file with all pages	Saves all pages as one file
	Compression Level	Selects the compression level for color or grayscale images

Setting	Options	Description
Security	Open File Password	Sets a password to open the file
	Protect Property Settings	Sets a password to protect file properties and allows for restrictions on file editing and printing

JPEG Options

Setting	Options	Description
Image Quality Options	—	Sets a compression level by moving a slider or entering a value. File size increases when high resolution is selected.
Encoding (Windows only)	Standard	Images load from top to bottom in a web browser. It takes longer to load the entire image.
	Progressive	Images first load completely at low resolution and then adjust to high resolution in a web browser
Embed ICC Profile (Windows only)	—	Allows you to add ICC profiles to the image

Parent topic: [Selecting Epson ScanSmart Settings](#)

Customizing Action Icons

You can customize how the scan action icons are displayed on the **Select Action** window.

Note: You can also customize them by clicking the **Customize** icon on the **Select Action** screen.

1. Click the  **Settings** button.

You see a screen like this:

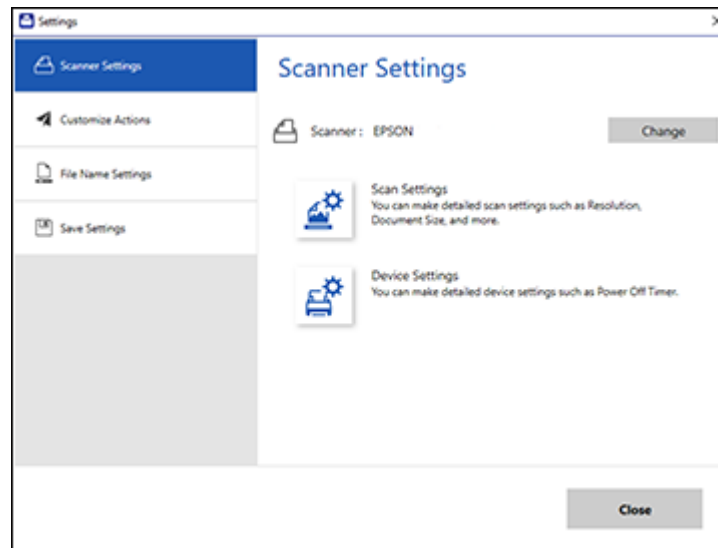

2. Click the **Customize Actions** tab.

You see a screen like this:

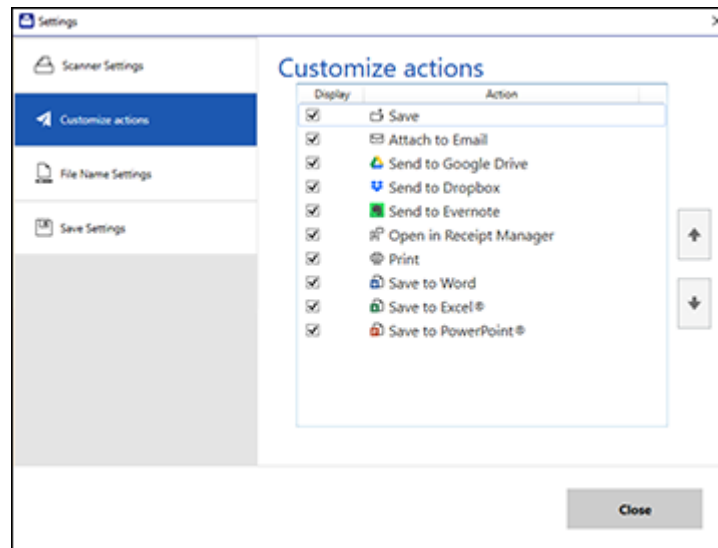

3. Choose which action icons to display by selecting or deselecting each checkbox. Click the arrow icons to move the icons up or down in the display order you want.
4. Click **Close**.

Parent topic: [Selecting Epson ScanSmart Settings](#)

Scanning Receipts and Using Receipt Manager

You can scan receipts and manage the data in Receipt Manager.

Note: Receipt Manager is available only for the ES-55R and ES-65WR.

1. Load your original receipts into the scanner.
2. Press the  start button on the scanner.

Epson ScanSmart automatically opens on your computer and the scan job begins. The receipts feed through the scanner. When scanning is complete, you see a screen like this:

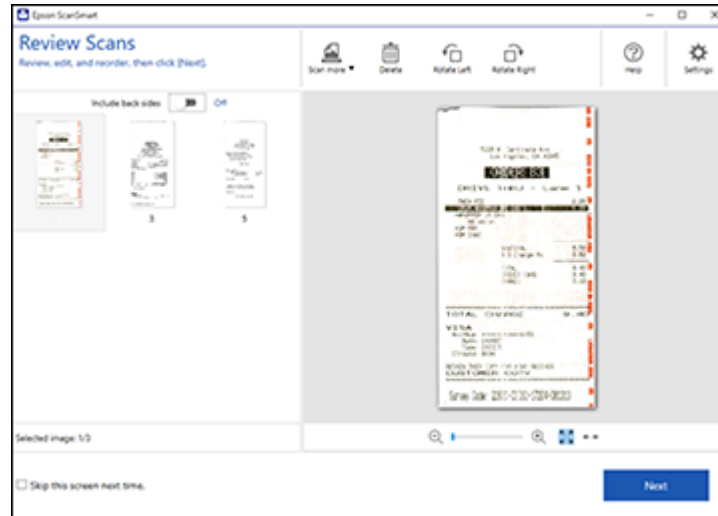

3. You can review or reorder the scanned images as follows:
 - Select **Scan more** to scan more receipts.
 - Select **Delete** to delete selected scanned images.
 - Select a rotate option to rotate scanned images.
4. When you are finished reviewing the scanned images, click **Next**.

You see a screen like this:

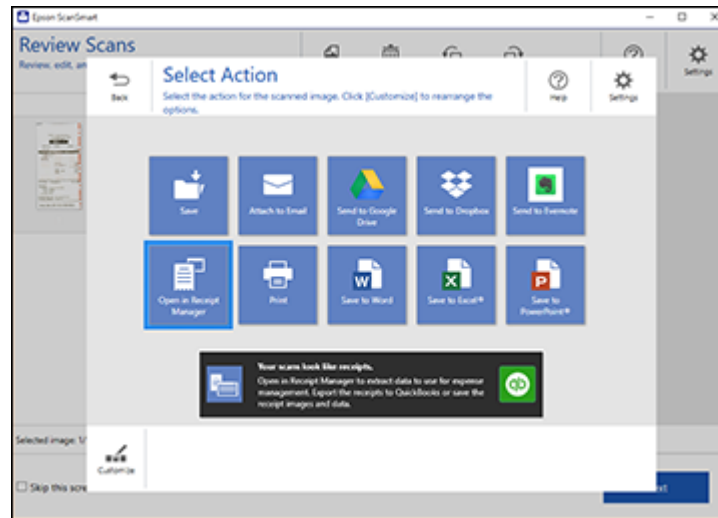

5. Click **Open in Receipt Manager**.

You see a screen like this:

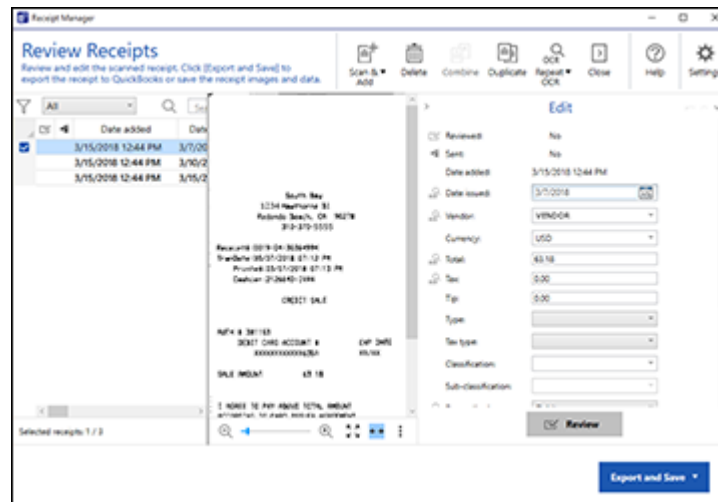

Note: You can also click **OPEN Receipt Manager** from the main Epson ScanSmart screen to begin scanning receipts.

6. In the **Edit** window, review the receipt data against the scanned image and make sure it is correct. Make changes to any of the information as follows:
 - Select **Scan & Add** to scan more receipts.
 - Select **Delete** to delete selected scanned images. Make sure the blue checkbox in the receipt list is selected for the receipts you want to delete.
 - Select **Combine** to combine receipt data. Make sure the blue checkboxes in the receipt list are selected for the receipts you want to combine.

Note: You cannot separate receipts once they are combined. You must delete and re-scan them if you need to separate them.

- Select **Duplicate** to duplicate receipts. Make sure the blue checkboxes in the receipt list are selected for the receipts you want to duplicate.

7. When you are finished reviewing the data for the first receipt, click **Mark Reviewed**. The next receipt appears and you can review the data. Repeat for each receipt.

Note: Make sure the blue checkboxes in the receipt list are selected for the receipts you want to export or save.

8. When you have finished reviewing data for all receipts, click **Export and Save**.

You see a screen like this:

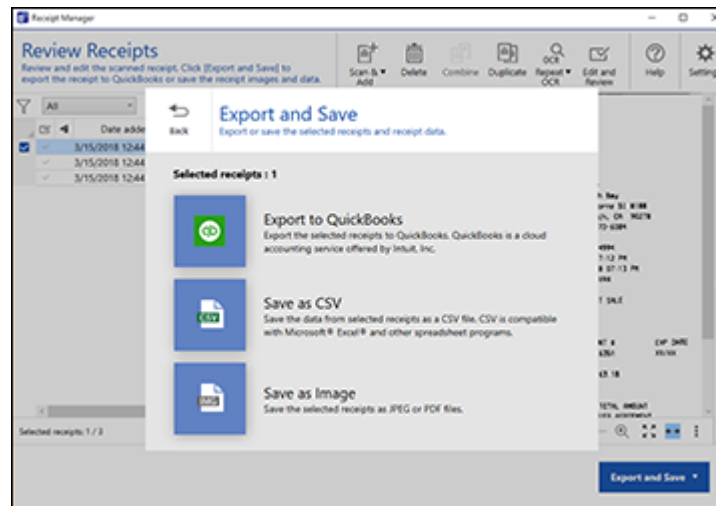

9. Select an export or save option. See the links below.

[Exporting Receipts to QuickBooks](#)

[Saving Receipt Data as a CSV File](#)

[Scanning Receipts as Image Files](#)

Parent topic: [Scanning](#)

Exporting Receipts to QuickBooks

You can export receipt data to QuickBooks.

Note: Make sure you have a current QuickBooks account and your login information is available.

1. Make sure your receipts are scanned and reviewed. See the link below.

2. In the **Export and Save** window, click **Export to Quickbooks**.

The QuickBooks window appears.

3. Enter your QuickBooks login information. Follow the on-screen instructions to continue.

Parent topic: [Scanning Receipts and Using Receipt Manager](#)

Saving Receipt Data as a CSV File

You can save receipt data as a CSV file to use in a spreadsheet program.

1. Make sure your receipts are scanned and reviewed. See the link below.
2. In the **Export and Save** window, click **Save as CSV**.
3. Choose the folder on your computer where you want to save the CSV file.

Parent topic: [Scanning Receipts and Using Receipt Manager](#)

Scanning Receipts as Image Files

You can save scanned receipts as image files.

1. Make sure your receipts are scanned and reviewed. See the link below.
2. In the **Export and Save** window, click **Save as Image**.

You see a screen like this:

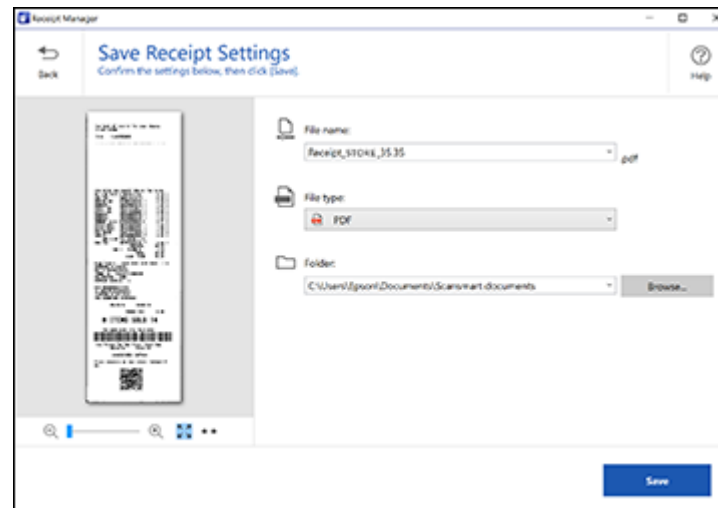

3. Review the file naming fields, select the file type (JPEG or PDF), select the destination folder, and click **Save**.

Parent topic: [Scanning Receipts and Using Receipt Manager](#)

Selecting Receipt Manager Settings

After starting Receipt Manager, you can export or import the receipt database and change various settings.

Note: Receipt Manager is available only for the ES-55R and ES-65WR.

[Exporting or Importing the Receipt Database](#)

[Changing Column Settings](#)

[Changing Currency and Language Settings](#)

Parent topic: [Scanning](#)

Exporting or Importing the Receipt Database

You can export or import the receipt database. This is useful if you change computers.

Note: Make sure each computer has the same version of Epson ScanSmart installed.

1. Click the  **Settings** button in Receipt Manager.

You see a screen like this:

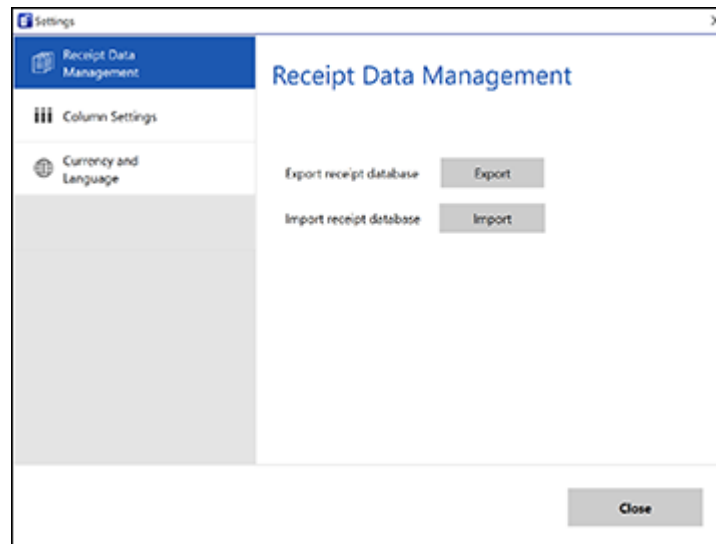

2. Choose one of these options:
 - Click **Export** to export the receipt database. A file is created that can be saved to a folder on your computer.
 - Click **Import** to import the receipt database. Choose the file that was created when you exported the database. The current database is overwritten.
3. Click **Close**.

Parent topic: [Selecting Receipt Manager Settings](#)

Related tasks

[Scanning Receipts and Using Receipt Manager](#)

Changing Column Settings

You can choose which columns are displayed in the receipt list.

1. Click the  **Settings** button in Receipt Manager.

You see a screen like this:

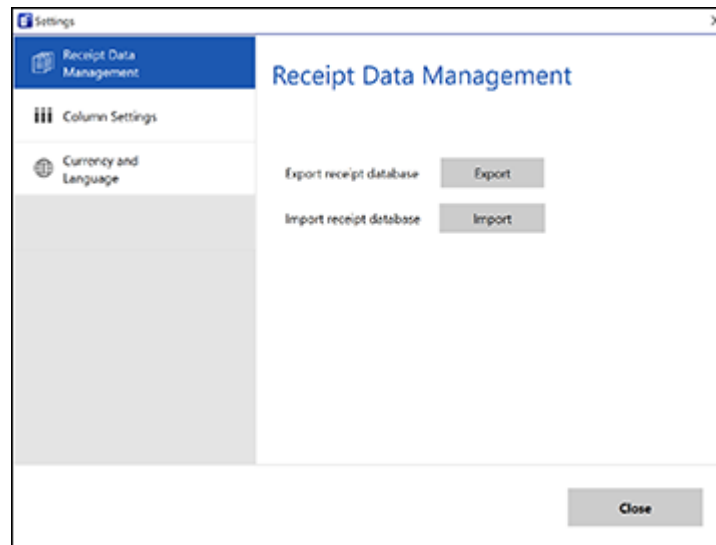

2. Click **Column Settings**.

You see a screen like this:

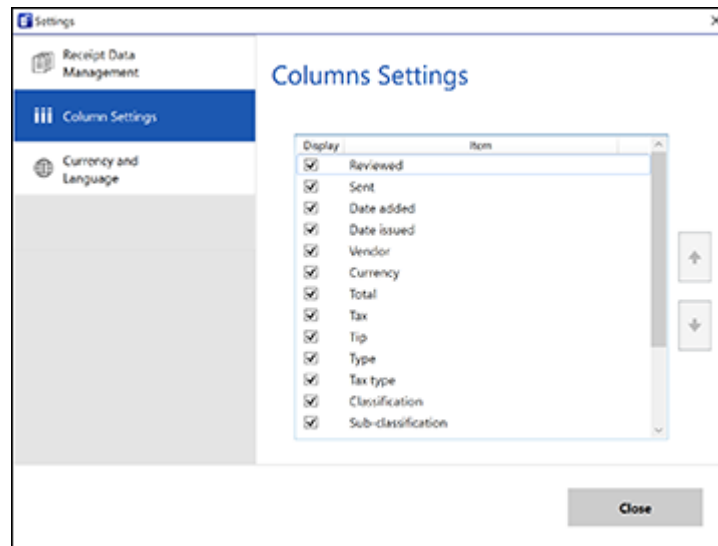

3. Choose which columns to display by selecting or deselecting each checkbox. Click the arrow icons to move the items up or down in the display order you want.
4. Click **Close**.

Parent topic: [Selecting Receipt Manager Settings](#)

Related tasks

[Scanning Receipts and Using Receipt Manager](#)

Changing Currency and Language Settings

You can change the currency and OCR language for data in Receipt Manager.

1. Click the  **Settings** button in Receipt Manager.

You see a screen like this:

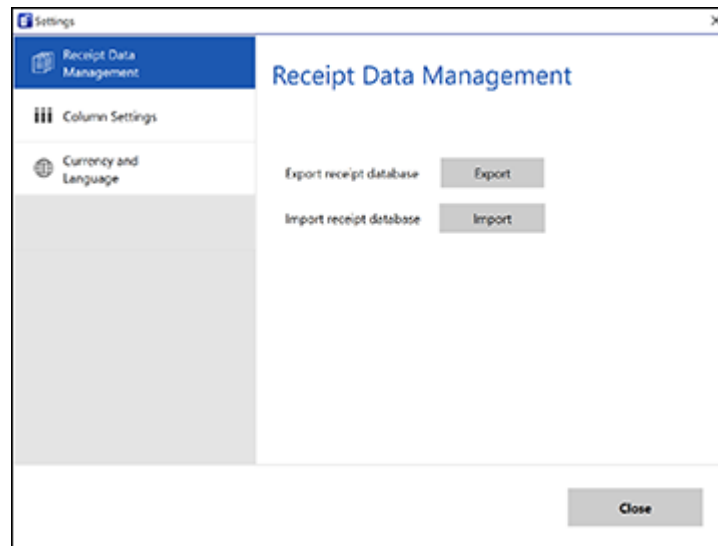

2. Click **Currency and Language**.

You see a screen like this:

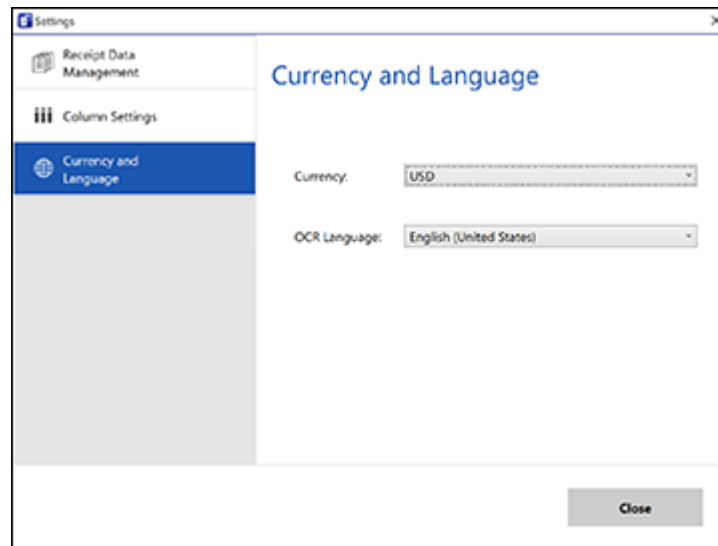

3. Select a currency type and OCR language.
4. Click **Close**.

Parent topic: [Selecting Receipt Manager Settings](#)

Related tasks

[Scanning Receipts and Using Receipt Manager](#)

Scan Resolution Guidelines

The resolution setting in your scanning software, measured in dpi (dots per inch), controls the amount of detail captured in your scans. Increasing the resolution raises the amount of detailed captured but comes with the following disadvantages:

- Larger file sizes
- It takes longer to scan your originals, send/receive your scans by email or fax, and to print your scans
- The image may become too large to fit on your display or print on paper

If you plan to enlarge a scanned image so you can print it at a larger size, you may need to increase the resolution from the default resolution set by the software. Follow these guidelines to determine the resolution setting you need:

- You will scan the image at its original size but enlarge it later in an image-editing program.

Increase the resolution setting in your scanning software. Increase the resolution by the same amount you will increase the image size to retain a high image quality. For example, if the resolution is 300 dpi (dots per inch) and you will double the image size later, change the resolution setting to 600 dpi.

- You will scan the image at 100% or smaller size.

Select the resolution setting based on how you will use the scanned image:

- Email/view on a computer screen/post on the web: 96 to 200 dpi
- Print/fax/convert to editable text (OCR)/create searchable PDF: 200 to 300 dpi

Parent topic: [Scanning](#)

Cleaning and Transporting Your Scanner

See these sections if you need to clean or transport your scanner.

[Cleaning Your Scanner](#)

[Cleaning Inside Your Scanner](#)

[Calibrating Your Scanner](#)

[Transporting Your Scanner](#)

Cleaning Your Scanner

To keep your product working at its best, you should clean it several times a year.

Caution: Do not use a hard brush, alcohol, or paint thinner to clean the product or you may damage it. Do not use oil or other lubricants inside the product or let water get inside it. Do not open the product's outer case.

1. Turn off the scanner (ES-60W/ES-65WR).
2. Disconnect the USB cable, if connected.
3. Clean the outer case with a soft, dry cloth. Do not use liquid or chemical cleansers.

Note: If the outer case still requires additional cleaning, use a slightly damp cloth to wipe the outer case. Then wipe the case with a soft, dry cloth.

Parent topic: [Cleaning and Transporting Your Scanner](#)

Cleaning Inside Your Scanner

Clean your scanner regularly using the dry cleaning sheet that came with your scanner. Dust on the scanning surface can cause spots or lines in your scanned images. If spots or lines remain, a wet cleaning sheet is available as part of the optional maintenance sheet kit (part number B12B819481).



Note: The illustration shows the ES-50/ES-55R, but the steps are the same for the ES-60W/ES-65WR.

Caution: Use the dry or wet cleaning sheets to clean your scanner. Do not disassemble your product and do not use a hard brush, alcohol, or paint thinner to clean the product or you may damage it. Do not use oil or other lubricants inside the product or let water get inside it.

You can purchase genuine Epson accessories at epson.com (U.S. sales), epson.ca (Canadian sales), or epson.com.jm (Caribbean sales). You can also purchase accessories from an Epson authorized reseller. To find the nearest one, call 800-GO-EPSON (800-463-7766) in the U.S. or 800-807-7766 in Canada.

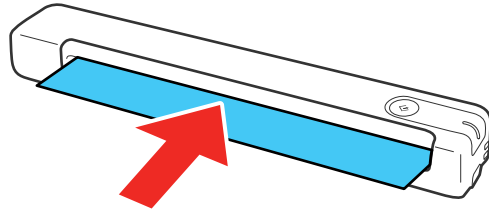
1. Turn on the scanner and make sure it is connected to the computer.
2. Load the dry cleaning sheet into the scanner.



3. Do one of the following to start the Epson Scan 2 Utility:
 - **Windows 10:** Click  > **EPSON** > **Epson Scan 2 Utility**
 - **Windows 8.x:** Navigate to the **Apps** screen and select **Epson Scan 2 Utility**.
 - **Windows (other versions):** Click  or **Start** > **All Programs** or **Programs** > **EPSON** > **Epson Scan 2** > **Epson Scan 2 Utility**.
 - **Mac:** Open the **Applications** folder, click **Epson Software**, and click **Epson Scan 2 Utility**.
4. Click **Maintenance**.
5. Click **Cleaning**.

Note: Cleaning does not start if the battery level is low (ES-60W/ES-65WR).

The scanner feeds and ejects the cleaning sheet. Cleaning takes about 30 seconds.

6. If spots or lines remain, repeat these steps to clean it again.

Note: You can use the same dry cleaning sheet multiple times.

7. If the scanner is not clean after multiple cleanings with the dry cleaning sheet, repeat these steps using the wet cleaning sheet from the optional maintenance sheet kit.

Note: You can use the wet cleaning sheet only once. If the scanner is still not clean after using the wet cleaning sheet, contact Epson for support.

Parent topic: [Cleaning and Transporting Your Scanner](#)

Related references

[User Replaceable Epson Scanner Accessories](#)

Calibrating Your Scanner

If you notice any of the following image quality problems, you can calibrate the scanner using the calibration sheet that came with it:

- Scanned images are blurry.
- Scanned colors differ from the colors in the original.
- Scanned images are darker or lighter than the original.
- Scanned images contain vertical lines.



Note: The illustration shows the ES-50/ES-55R, but the steps are the same for the ES-60W/ES-65WR.

1. Turn on the scanner and make sure it is connected to the computer.

Note: Make sure the scanner battery is not low or calibration will not start (ES-60W/ES-65WR).

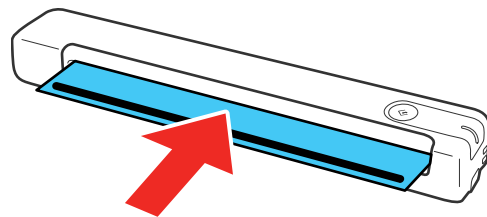
2. Load the calibration sheet into the scanner with the arrows at the trailing edge of the sheet pointing into the input slot.



3. Do one of the following to start the Epson Scan 2 Utility:
 - **Windows 10:** Click  > **EPSON** > **Epson Scan 2 Utility**.
 - **Windows 8.x:** Navigate to the **Apps** screen and select **Epson Scan 2 Utility**.
 - **Windows (other versions):** Click  or **Start** > **All Programs** or **Programs** > **EPSON** > **Epson Scan 2** > **Epson Scan 2 Utility**.
 - **Mac:** Open the **Applications** folder, click **Epson Software**, and click **Epson Scan 2 Utility**.
4. Click **Maintenance**.
5. Click **Calibration**.

The scanner feeds and ejects the calibration sheet. Calibration takes about 20 seconds.

Note: You can use the calibration sheet multiple times. If calibrating the scanner does not improve the image quality, contact Epson for support.

Parent topic: [Cleaning and Transporting Your Scanner](#)

Transporting Your Scanner

If you need to ship your product, transport it a long distance, or store it for an extended period, prepare it for transportation as described here.

1. Turn off the scanner (ES-60W/ES-65WR).
2. Disconnect the USB cable, if connected.
3. Place the scanner in its original packing materials, if possible, or use equivalent materials with cushioning around the product.

Caution: Strong impacts may damage the scanner. Do not expose the scanner to direct sunlight or leave it near heaters or in locations subject to high temperatures. Heat may cause the body to deform.

Note: If you are taking the scanner with you on a flight, first confirm with the airline if you can take the scanner on the airplane. We recommend you take the scanner in your carry-on luggage as the scanner can be damaged by a strong impact depending on how your checked luggage is handled at the airport.

Parent topic: [Cleaning and Transporting Your Scanner](#)

Solving Problems

Check these sections for solutions to problems you may have using your product.

[Scanner Light Status](#)

[Solving Scanning Problems](#)

[Solving Network Scanning Problems](#)

[Solving Scanned Image Quality Problems](#)

[Uninstall Your Scanner Software](#)

[Where to Get Help](#)

Scanner Light Status

You can often diagnose problems with your scanner by checking its lights.

ES-50/ES-55R

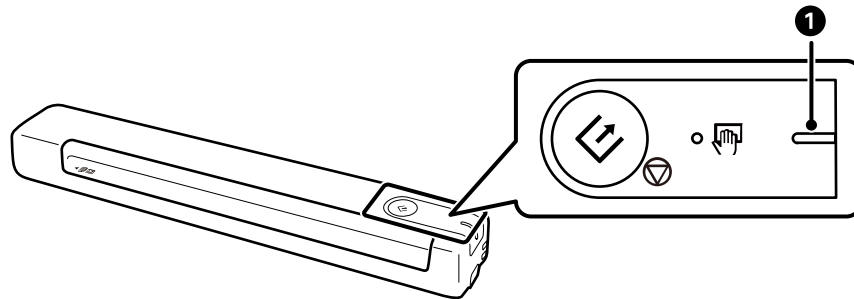





1 Ready light

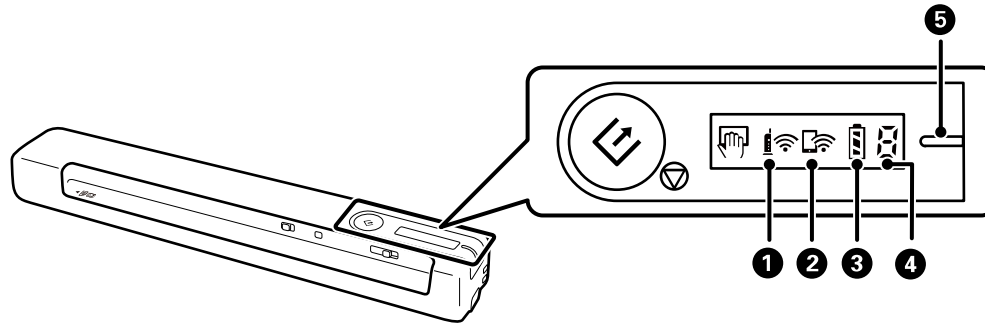

Light status	Condition/solution
The ready light is orange	<p>Check the following:</p> <ul style="list-style-type: none"> • Make sure there are no originals jammed in the scanner. • Make sure the scanner is connected to your computer securely. • If a firmware update fails and the scanner enters recovery mode, update the firmware again using a USB connection. • Disconnect and re-connect the USB cable to the computer. If this does not solve the problem, the scanner may be malfunctioning or the light source in the scanner unit may need to be replaced. Contact Epson for support.

ES-60W/ES-65WR



- 1  Wi-Fi light
- 2  Wi-Fi AP light
- 3  battery light
- 4 Error status light
- 5 Ready light

Light status	Condition/solution
The error status light shows the letter J and the ready light is orange	A paper jam has occurred. Remove and reload the original.
The error status light shows the letter F and the ready light is orange	<p>One of the following has occurred:</p> <ul style="list-style-type: none"> • A fatal error has occurred. Turn the scanner off and on again. If the error continues, contact Epson for support. • The battery cannot be fully charged even if you are charging the battery within the guaranteed charging temperature range. It may be damaged or has reached the end of its service life. Contact Epson for support.
The error status light shows the letter U and the ready light is orange	<p>The firmware update has failed.</p> <ul style="list-style-type: none"> • Connect the computer and the scanner with a USB cable (during recovery mode, you cannot update the firmware over a network connection) • Contact Epson for instructions on updating the firmware again.
The error status light shows the letter P and the ready light is orange	<p>The scanner has started in recovery mode.</p> <ul style="list-style-type: none"> • Connect the computer and the scanner with a USB cable (during recovery mode, you cannot update the firmware over a network connection) • Contact Epson for instructions on updating the firmware again.
The error status light shows the letter H, and all other lights are on	The battery stopped charging because it became too hot. Charge the battery within an ambient temperature range of 46 to 95 °F (8 to 35 °C).
The error status light shows the letter C, and all other lights are on	The battery stopped charging because it became too cold. Charge the battery within an ambient temperature range of 46 to 95 °F (8 to 35 °C).
The  Wi-Fi and  Wi-Fi AP lights flash simultaneously	An access point settings error has occurred. Restart the scanner and router, move them closer together, and connect to the network again.

Light status	Condition/solution
<p>The error status light shows three horizontal lines and the  Wi-Fi and  Wi-Fi AP lights flash simultaneously.</p>	<p>Epson ScanSmart did not launch after pressing the scanner's  start button while connected over a network.</p> <ul style="list-style-type: none"> • Check the Wi-Fi connection. Try turning the wireless router off and on again. • Make sure the correct scanner is selected in Epson ScanSmart. • Make sure another computer is not connected to the scanner using a USB cable. A USB connection takes priority over a Wi-Fi connection. If another computer is connected by USB, disconnect it. • If you are using a Mac computer, make sure you select the network that has priority on it.

Parent topic: [Solving Problems](#)

Related references

[Original Jams in Scanner](#)

[Where to Get Help](#)

Related tasks

[Loading Originals in the Input Slot](#)

[Charging the Battery \(ES-60W/ES-65WR\)](#)

Related topics

[Scanning](#)

[Wi-Fi Networking](#)

Solving Scanning Problems

Check these solutions if you have problems scanning with your product.

[Scanner Does Not Turn On or Off or Turns Off Unexpectedly](#)

[Scanner Button Does Not Start Scanning](#)

[Scanning Software Does Not Operate Correctly](#)

[Original Feeds Incorrectly in Scanner](#)

[Original Jams in Scanner](#)



[Scanning is Slow](#)

[Cannot Send Scans to a Cloud Service](#)

Parent topic: [Solving Problems](#)

Scanner Does Not Turn On or Off or Turns Off Unexpectedly

If the scanner does not turn on or off or if it turns off unexpectedly, try these solutions:

- Wait a second after connecting the USB cable. It may take a few seconds until the scanner turns on.
- If the scanner turns off unexpectedly, you may need to adjust the **Power Save** settings.
- Use the scanner within the operating temperature range. The scanner may turn off suddenly under low or high temperatures.
- Use the USB cable that came with the scanner.
- Make sure the USB cable is securely connected to the scanner and the computer.
- Connect the scanner directly to the computer. The scanner may not work properly when connected through a USB hub.
- If the scanner is running on the battery under temperatures that are too low or too high, the scanner will not turn on. Use the scanner within the operating temperature range (ES-60W/ES-65WR).
- Make sure the battery has enough power (ES-60W/ES-65WR).
- Make sure the  Wi-Fi switch is in the  Wi-Fi position or connect to the computer using the USB cable. Otherwise, the scanner may turn off (ES-60W/ES-65WR).
- If the scanner does not turn off when running on the battery, disconnect the USB cable and press the reset button on the bottom of the scanner (ES-60W/ES-65WR).

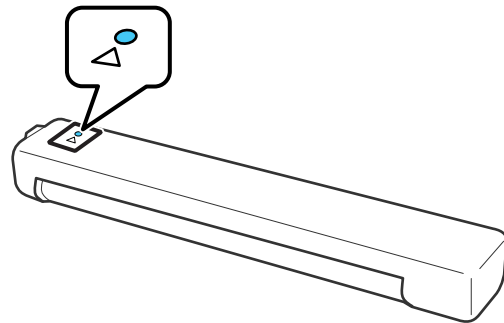

Parent topic: [Solving Scanning Problems](#)

Related tasks

[Changing the Power Save Settings](#)

Scanner Button Does Not Start Scanning

If pressing the  start button on your scanner does not start a scan, try these solutions:

- Restart your computer.
- Make sure your scanner is turned on and any interface cables are securely connected at both ends.
- If you are connecting your scanner over a network, make sure the Wi-Fi connection is working correctly. Try turning the wireless router off and on again, and make sure the router cable is securely connected.
- If you are connecting your scanner via USB, use only the USB cable that came with the scanner. Make sure it is connected directly to your computer and not to a USB hub.
- For Wi-Fi scanning, confirm that your scanner is paired with your computer. In Epson ScanSmart, click **Settings > Scanner Settings > Change** and select the scanner you want to use.
- Make sure your scanner is not connected to another computer via USB. A USB connection takes priority over a Wi-Fi connection.
- Make sure Epson ScanSmart and Epson Scan 2 are installed correctly. Reinstall the software, if necessary.

Parent topic: [Solving Scanning Problems](#)

Related references

[Scanner Light Status](#)

Related tasks

[Customizing Action Icons](#)

Scanning Software Does Not Operate Correctly

If your scanning software does not operate correctly, try these solutions:

- Make sure your computer has adequate memory and meets the system requirements for your operating system.
- Make sure your computer is not running in a power-saving mode, such as sleep or standby. If so, wake your system and restart your scanning software.
- Make sure the scanner is turned on.
- Make sure the connection between the scanner and your computer is secure.
- If you upgraded your operating system but did not reinstall your scanning software, try reinstalling it.

- In Windows, be sure that the scanner is listed under **Imaging Devices** in the Device Manager.
- Make sure the scanning software is installed.
- Use the USB cable that came with the scanner.
- Connect the scanner directly to the computer. The scanner may not work properly when connected through a USB hub.
- If you are using a TWAIN-compliant program, make sure that the correct product is selected as the **Scanner** or **Source** setting.
- Check that the Wi-Fi connection is working correctly. Try turning the wireless router off and on (ES-60W/ES-65WR).
- Make sure another computer is not connected to the scanner using a USB cable. A USB connection takes priority over a Wi-Fi connection. If another computer is connected by USB, disconnect it.
- If you are using a Mac computer, make sure you select the network that has priority on it.

Parent topic: [Solving Scanning Problems](#)

Related references

[Windows System Requirements](#)

[Mac System Requirements](#)

Related tasks

[Uninstalling Scanner Software - Windows](#)

[Uninstalling Scanner Software - Mac](#)

Original Feeds Incorrectly in Scanner

If you have problems feeding originals in your scanner, try these solutions:

- Load only an original that meets the specifications for your scanner.
- Clean inside the scanner using a cleaning sheet.

Parent topic: [Solving Scanning Problems](#)

Related references

[Original Document Specifications](#)

[Receipt Specifications](#)

[Special Original Specifications](#)

[Plastic Card Specifications](#)

Related tasks

[Loading Originals in the Input Slot](#)

[Cleaning Inside Your Scanner](#)

Original Jams in Scanner

If an original has jammed inside the scanner, follow these steps:

1. Gently pull out the jammed original in the direction that offers the least resistance.

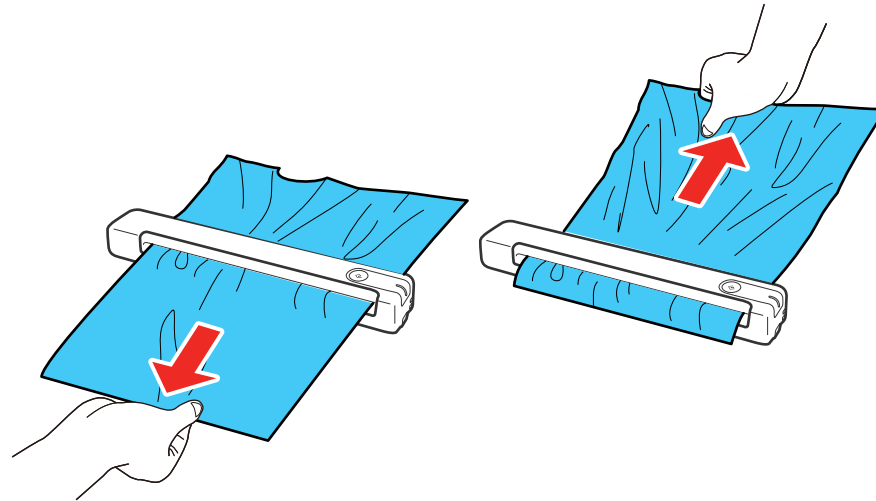

Note: If paper gets stuck in the roller and remains inside the scanner, carefully remove it with a pair of tweezers in the direction of the output slot. If you cannot remove it, contact Epson for support.

2. Carefully follow all loading instructions when you reload your original.

Parent topic: [Solving Scanning Problems](#)

Related references

[Original Document Specifications](#)

[Receipt Specifications](#)

[Special Original Specifications](#)

[Plastic Card Specifications](#)

[Where to Get Help](#)

Related tasks

- [Loading Originals in the Input Slot](#)
- [Cleaning Inside Your Scanner](#)

Scanning is Slow

If scanning becomes slow, try these solutions:

- Scan your original at a lower resolution, if possible.
- Make sure your system meets the requirements for your operating system. If you are scanning a high-resolution image, you may need more than the minimum requirements. If necessary, increase your system's memory or reduce the resolution.
- If you are scanning over a wireless network, factors such as interference, network traffic, or weak signal strength may affect your scanning speed (ES-60W/ES-65WR).
- Computers with USB 2.0 (Hi-Speed) ports can scan faster than those with USB 1.1 ports. If you are using a USB 2.0 port with the scanner, make sure it meets the system requirements.
- Scanning may take longer if the battery is low. Charge the battery from a computer with a USB connection (ES-60W/ES-65WR).

Parent topic: [Solving Scanning Problems](#)

Related references

- [Windows System Requirements](#)
- [Mac System Requirements](#)

Cannot Send Scans to a Cloud Service

If you cannot send a scan to a cloud service, try these solutions:

- Make sure the login information you entered for the cloud service is correct.
- Make sure the cloud service is not down for system maintenance. Check the cloud service website for more information.

Parent topic: [Solving Scanning Problems](#)

Solving Network Scanning Problems



Check these solutions if you have problems scanning over a network (ES-60W/ES-65WR).

- [Cannot Scan Over a Network](#)
- [Scanner Cannot Connect to a Wireless Router](#)

Parent topic: [Solving Problems](#)

Cannot Scan Over a Network

If you cannot scan over a network (ES-60W/ES-65WR) with Epson ScanSmart or start the Epson Scan 2 Utility, try these solutions:

- Make sure the  Wi-Fi switch is set to the  Wi-Fi position.
- Make sure the computer and scanner are connected to the same network (or network segment/VLAN).
- Move the scanner and computer or smart device closer to the router or access point.
- If you cannot scan using the  start button on the scanner, make sure you restarted your computer after installing the scanning software.
- If you are scanning a large original at a high resolution, a network communication error may occur. Try scanning again at a lower resolution.
- Check the network connection setting in the Epson Scan 2 Utility.
- You may need to disable the firewall and any anti-virus software on your wireless router or access point.
- If you see the message "Network product is not available: currently being used by user", there may be a communication error between the scanner and computer. Restart the scanner.
- If the Firewall function is active, the scanner may not be discovered by the Epson Scan 2 Utility. Open the Epson Scan 2 Utility, enter the IP address for your scanner, and click **Add**.
- If the scanner and computer cannot communicate and are connected to the same network (or network segment/VLAN), the privacy separator on your router must be disabled. Follow the instructions in your router documentation to disable the privacy separator.

Parent topic: [Solving Network Scanning Problems](#)

Related topics

[Wi-Fi Networking](#)

Scanner Cannot Connect to a Wireless Router

If your scanner has trouble finding or connecting to a wireless router (ES-60W/ES-65WR), try these solutions:

- If you did not successfully connect to a network while installing your product software, select the link at the end of this topic and follow the steps in "Manually Connecting to a Wi-Fi Network".

- If you are connecting the scanner via Wi-Fi Protected Setup (WPS), make sure you activate WPS on your scanner within 2 minutes of activating WPS discovery mode on the router by pressing the WPS button or enabling the WPS setting in your router firmware.
- Make sure to place your scanner within contact range of your router. Avoid placing your scanner near a microwave oven, 2.4 GHz cordless phone, or large metal object, such as a filing cabinet.

Note: If you are using a 5 GHz wireless router, set the router to operate in dual band (2.4 GHz and 5 GHz) mode. If your router uses a single network name (SSID) for both the 2.4 GHz and 5 GHz band, give each band its own network name (SSID) instead, such as Home Network 2.4 GHz and Home Network 5 GHz. See your router documentation or contact your internet service provider for instructions. Be sure to connect your computer and scanner only to a 2.4 GHz network name (SSID).

- Verify that your router is operating correctly by connecting to it from your computer or another device.
- You may need to temporarily disable your firewall and any anti-virus software on your wireless router. Then try scanning again. You can also unblock your scanner driver or network address in your firewall or anti-virus software.
- Check to see if access restrictions, such as MAC address filtering, are set on the router. If access restrictions are set, add your scanner's MAC address to your router's address list. To obtain your scanner's MAC address, check the label on the back or bottom of your scanner. Then follow the instructions in your router documentation to add the address to the list.
- If your router does not broadcast its network name (SSID), follow the instructions that came with your scanner to enter your wireless network name manually.
- If your router has security enabled, determine the kind of security it is using and any required password or passphrase for connection. Then make sure to enter the exact WEP key or WPA passphrase correctly.
- Check if your computer is restricting the available wireless channels. If so, verify that your wireless access point is using one of the usable channels and change to a usable channel, if necessary.
- The scanner may not be able to communicate with a computer with multiple network interfaces. Disable all network interfaces except for the interface connected to the scanner.
- Enable the DHCP function on the access point or router.
- Check that the scanner's IP address is set correctly.

Parent topic: [Solving Network Scanning Problems](#)

Related tasks

[Manually Connecting to a Wi-Fi Network](#)

Related topics

[Wi-Fi Networking](#)

Solving Scanned Image Quality Problems

Check these sections if a scanned image on your computer screen has a quality problem.

[Back of Original Image Appears in Scanned Image](#)

[Scanned Characters are Blurry](#)

[Characters are not Recognized During Conversion to Editable Text \(OCR\)](#)

[Ripple Patterns Appear in an Image](#)

[Spots or Lines Appear in All Scanned Images](#)

[Straight Lines in an Image Appear Crooked](#)

[Scanned Image is Cropped](#)

[Resetting the Epson Scan 2 Settings](#)

Parent topic: [Solving Problems](#)

Back of Original Image Appears in Scanned Image

If an image from the back of a thin original appears in your scanned image, make sure you selected the correct Image Type setting for your original and select the **Text Enhancement** setting in Epson Scan 2. You can also select the **Remove Background** setting in Epson Scan 2.

Note: If you select **Color** as the Image Type setting, you can change the level from Standard to High to remove more of the background.

Parent topic: [Solving Scanned Image Quality Problems](#)

Related tasks

[Changing the Scan Settings](#)

Scanned Characters are Blurry

If characters in your scanned images are blurry, try these solutions:

- Make sure you do not move the scanner or original while scanning.
- Operate the scanner on a flat, stable surface.
- Make sure the originals are ejecting properly.

- In Epson ScanSmart, click **Settings > Scanner Settings > Scan Settings** and try adjusting these settings and scanning again:
 - On the **Main Settings** tab, make sure you select the correct **Image Type** for your original.
 - On the **Main Settings** tab, try increasing the **Resolution** setting.
 - On the **Advanced Settings** tab, select **Text Enhancement** and choose a setting.

Note: The **Text Enhancement** setting depends on the selected **Image Type**.

- If the **Image Type** is set to **Black & White**, adjust the **Threshold** setting on the **Advanced Settings** tab. (The **Image Option** must be set to **None**.)

Parent topic: [Solving Scanned Image Quality Problems](#)

Related tasks

[Changing the Scan Settings](#)

Characters are not Recognized During Conversion to Editable Text (OCR)

If characters in your scanned images are not recognized during OCR conversion, try these solutions:

- Make sure your original is loaded straight on your product.
- Use an original with clear text.
- Adjust these Epson Scan 2 settings (if available) and try scanning again:
 - Select the correct **Image Type** setting.
 - If the **Image Type** is set to **Black & White**, adjust the **Threshold** setting.
 - Set the **Image Type** to **Grayscale**.
- Set the scanning resolution between 200 and 600 dpi.
- If the original document is in landscape mode, set the **Rotate** setting to **Auto** in Epson Scan 2.
- If you are using OCR software, check the manual for any additional adjustments.

Parent topic: [Solving Scanned Image Quality Problems](#)

Related tasks

[Changing the Scan Settings](#)

Ripple Patterns Appear in an Image

You may see a ripple pattern (called a moiré) in scanned images of printed documents. This is caused by interference from differing pitches in the scanner's screen and your original's halftone screen. To reduce this effect, adjust these Epson Scan 2 settings (if available) and try scanning again:

- Select the **Descreening** setting.
- Select a lower **Resolution** setting.

Parent topic: [Solving Scanned Image Quality Problems](#)

Spots or Lines Appear in All Scanned Images

If spots or lines appear in all your scanned images, try these solutions:

- Clean inside the scanner using a cleaning sheet.
- Calibrate the scanner using a calibration sheet.
- Make sure the surface of your original is clean.
- Avoid scanning in direct sunlight.

Note: If you are scanning a plastic card with a shiny surface, a line may appear in the scan.

Parent topic: [Solving Scanned Image Quality Problems](#)

Related tasks

[Cleaning Inside Your Scanner](#)

[Calibrating Your Scanner](#)

Straight Lines in an Image Appear Crooked

If straight lines in an original appear crooked in a scanned image, try these solutions:

- Make sure to load your original straight when you scan it.
- Clean inside the scanner using a cleaning sheet.

Parent topic: [Solving Scanned Image Quality Problems](#)

Scanned Image is Cropped

If the edges of a scanned image are cropped, try the following solutions:



- Select **Auto Detect** as the Document Size setting in Epson Scan 2.

- In Epson Scan 2, select the **Main Settings** tab. Select **Document Size > Settings** and adjust the cropping area shown in the **Crop Margins for Size "Auto"** setting.
- In Epson Scan 2, select the **Advanced Settings** tab. Set the **Edge Fill** setting to **None**.

Parent topic: [Solving Scanned Image Quality Problems](#)

Resetting the Epson Scan 2 Settings

If you continue to experience image quality problems after trying all possible solutions, you may need to reset the Epson Scan 2 settings using the Epson Scan 2 Utility.

1. Do one of the following to start the Epson Scan 2 Utility:
 - **Windows 10:** Click  > **EPSON > Epson Scan 2 Utility**.
 - **Windows 8.x:** Navigate to the **Apps** screen and select **Epson Scan 2 Utility**.
 - **Windows (other versions):** Click  or **Start**, and select **All Programs** or **Programs**. Select **EPSON > Epson Scan 2 Utility**.
 - **Mac:** Open the **Applications** folder, open the **Epson Software** folder, and select **Epson Scan 2 Utility**.
2. Click the **Other** tab.
3. Click **Reset**.

Note: If resetting the Epson Scan 2 settings does not solve your problem, uninstall your scanner software and re-install it.

Parent topic: [Solving Scanned Image Quality Problems](#)

Related concepts

[Uninstall Your Scanner Software](#)

Uninstall Your Scanner Software

If you have a problem that requires you to uninstall and re-install your software, follow the instructions for your operating system.



[Uninstalling Scanner Software - Windows](#)

[Uninstalling Scanner Software - Mac](#)

Parent topic: [Solving Problems](#)

Uninstalling Scanner Software - Windows

You can uninstall and then re-install your scanner software to solve certain problems.

1. Exit all applications currently running on your computer.
2. Turn off the scanner (ES-60W/ES-65WR).
3. Disconnect any interface cables.
4. Do the following to uninstall each of your scanning software programs and follow any on-screen instructions:
 - **Windows 10:** Click  and select  (Settings) > **Apps > Apps & features**. Select the scanner software program and click **Uninstall**.
 - **Windows 8.x:** Navigate to the **Apps** screen and select **Control Panel > Programs > Programs and Features**. Select the scanner software program and click **Uninstall/Change**.
 - **Windows 7:** Open the Windows **Control Panel** utility. Select **Programs and Features**. (In Classic view, select **Programs** and click **Uninstall a program**.) Select the scanner software program and click **Uninstall/Change**.
5. Restart your computer, then see the *Start Here* sheet to re-install your software.

Note: If you find that re-installing your scanner software does not solve a problem, contact Epson.

Parent topic: [Uninstall Your Scanner Software](#)

Uninstalling Scanner Software - Mac

In most cases, you do not need to uninstall your scanner software before re-installing it. However, you can download the Uninstaller utility from the Epson support website to uninstall your scanner software as described here.

1. To download the Uninstaller utility, visit epson.com/support (U.S.), epson.ca/support (Canada), or epson.com.jm/support (Caribbean) and select your product.
2. Follow the instructions on the screen to install the Uninstaller utility.
3. Quit all applications currently running on your Mac.
4. Double-click the **Uninstaller** icon.
5. In the Epson Uninstaller screen, select the checkbox for each software program you want to uninstall.
6. Click **Uninstall**.

7. Follow the on-screen instructions to uninstall the software.
8. To reinstall your scanner software, see the *Start Here* sheet for instructions.

Note: If you find that re-installing your scanner software does not solve a problem, contact Epson.

Parent topic: [Uninstall Your Scanner Software](#)

Where to Get Help

If you need to contact Epson for technical support services, use the following support options.

Internet Support

Visit Epson's support website at epson.com/support (U.S.), epson.ca/support (Canada), or epson.com.jm/support (Caribbean) and select your product for solutions to common problems with your product. You can download utilities and documentation, get FAQs and troubleshooting advice, or e-mail Epson with your questions.

Speak to a Support Representative

Before you call Epson for support, please have the following information ready:

- Product name
- Product serial number (located on a label on the product)
- Proof of purchase (such as a store receipt) and date of purchase
- Computer configuration
- Description of the problem

Then call:

- U.S.: (562) 276-4382, 6 AM to 8 PM, Pacific Time, Monday through Friday, and 7 AM to 4 PM, Pacific Time, Saturday
- Canada: (905) 709-3839, 6 AM to 8 PM, Pacific Time, Monday through Friday, and 7 AM to 4 PM, Pacific Time, Saturday

Days and hours of support are subject to change without notice. Toll or long distance charges may apply.

Note: For help using any other software on your system, see the documentation for that software for technical support.

Purchase Supplies and Accessories

You can purchase genuine Epson accessories at epson.com (U.S. sales), epson.ca (Canadian sales), or epson.com.jm (Caribbean sales). You can also purchase accessories from an Epson authorized reseller. To find the nearest one, call 800-GO-EPSON (800-463-7766) in the U.S. or 800-807-7766 in Canada.

Parent topic: [Solving Problems](#)

Technical Specifications

These sections list the technical specifications for your scanner.

Note: Epson offers a recycling program for end of life Epson products. Please go to [this site](#) (U.S) or [this site](#) (Canada) for information on how to return your Epson products for proper disposal.

[Windows System Requirements](#)

[Mac System Requirements](#)

[General Specifications](#)

[Dimension Specifications](#)

[Electrical Specifications](#)

[Environmental Specifications](#)

[Network Interface Specifications \(ES-60W/ES-65WR\)](#)

[Safety and Approvals Specifications](#)

Windows System Requirements

To use your product and its software, your computer should use one of these Microsoft operating systems:

- Windows 10
- Windows 8.x
- Windows 7

Note: For the latest product software available for your operating system, visit the Epson support site at [epson.com/support](#) (U.S.), [epson.ca/support](#) (Canada), or [epson.com.jm/support](#) (Caribbean), select your product, and select **Downloads**.

Parent topic: [Technical Specifications](#)

Mac System Requirements

To use your product and its software, your Mac should use one of these operating systems:

- macOS 10.13.x
- macOS 10.12.x

- OS X 10.11.x

Note: The UNIX File System (UFS) for OS X is not supported.

Note: For the latest product software available for your operating system, visit the Epson support site at epson.com/support (U.S.), epson.ca/support (Canada), or epson.com.jm/support (Caribbean), select your product, and select **Downloads**.

Parent topic: [Technical Specifications](#)

General Specifications

Scanner type	Portable, sheet feed, simplex color A4
Photoelectric device	CIS
Effective pixels	5100 × 8400 pixels at 600 dpi (maximum) 2550 × 21600 pixels at 300 dpi (maximum - long paper)
Document size	Maximum: 8.5 × 72 inches (215.9 × 1828.8 mm) Documents scanned at 301 dpi or more: up to 8.5 × 14 inches (215.9 × 355.6 mm) Minimum: 2 × 2 inches (50.8 × 50.8 mm)
Paper input	Faceup loading
Paper output	Faceup ejection
Paper capacity	1 sheet of paper at up to 21 lb (80 g/m ²) weight
Scanning resolution	600 dpi (main scan) 600 dpi (sub scan)
Output resolution	50 to 1200 dpi (in 1 dpi increments) 50 to 300 dpi for scans from 14 to 72 inches (355.6 to 1828.8 mm)

Color depth

Color

- 48 bits per pixel internal (16 bits per pixel per color internal)
- 24 bits per pixel external (8 bits per pixel per color external)

Grayscale

- 16 bits per pixel internal
- 8 bits per pixel external

Black and white

- 16 bits per pixel internal
- 1 bit per pixel external

Interface

One USB 2.0 port (Hi-Speed)

IEEE802.11b/g/n (ES-60W/ES-65WR)

(You cannot use a USB and network connection at the same time [ES-60W/ES-65WR].)

Light source

RGB LED

Parent topic: [Technical Specifications](#)

Dimension Specifications

Height

1.4 inches (34.3 mm)

Width

10.7 inches (272 mm)

Depth

1.9 inches (47 mm)

Weight**ES-50/ES-55R:**

0.6 lb (270 g)

ES-60W/ES-65WR:

0.7 lb (300 g)

Parent topic: [Technical Specifications](#)

Electrical Specifications

Scanner

Note: Check the label on the scanner for voltage information. Power consumption varies depending on operating conditions.

Rated input voltage	DC 5 V
Rated input current	0.5 A
Power consumption (approximate)	ES-50/ES-55R: Operating: 2.1 W or less Ready mode: 1.1 W Sleep mode: 0.4 W Power off mode: 0.1 W or less ES-60W/ES-65WR (connected via USB): Operating: 2.7 W or less Ready mode: 1.6 W Sleep mode: 1.0 W Power off mode: 0.2 W or less ES-60W/ES-65WR (connected via Wi-Fi with fully charged battery): Operating: 3.1 W or less Ready mode: 2.4 W Sleep mode: 1.9 W Power off mode: 0.2 W or less

Battery (ES-60W/ES-65WR)

Type	Li-ion
Rated voltage	3.6 V
Rated capacity	1140mAh

Charging time	USB 2.0 port: 3.5 hours (approximately) (USB charging time with scanner turned off; if the scanner is turned on, charging takes longer.)
Number of scans (fully charged battery)	300 (continuous feed in automatic feeding mode at 300 dpi [color] via Wi-Fi)

Parent topic: [Technical Specifications](#)

Environmental Specifications

Temperature	Operating: 41 to 95 °F (5 to 35 °C) Charging: 46 to 95 °F (8 to 35 °C) [ES-60W/ES-65WR] Storage: –13 to 140 °F (–25 to 60 °C)
Humidity (non-condensing)	Operating: 10 to 85% RH Storage: 10 to 90% RH
Operating conditions	Ordinary office or home conditions

Note: Avoid operating the scanner in direct sunlight, near a strong light source, in locations subject to high temperatures, or in extremely dusty conditions.

Parent topic: [Technical Specifications](#)

Network Interface Specifications (ES-60W/ES-65WR)

Wireless LAN standard	IEEE 802.11 b/g/n
Wireless security	WPA2-PSK (AES); WPA2 compliant with support for WPA/WPA2 Personal WEP (64/128 bit)
Frequency range	2.4 GHz
Coordination modes	Infrastructure mode AP mode; not supported for IEEE802.11b

Maximum radio-frequency power transmitted 20 dBm (EIRP)

Note: AP mode connection and Wi-Fi connection can be used at the same time.

Parent topic: [Technical Specifications](#)

Safety and Approvals Specifications

Scanner

United States	Safety: UL60950-1 EMC: FCC part 15 Subpart B class B
Canada	Safety: CAN/CSA C22.2 No. 60950-1 EMC: ICES-003 Class B

ES-60W/ES-65WR:

This equipment contains the following wireless module:

- Manufacturer: Foxlink Image Technology
- Type: WM294V2-E01

This product conforms to Part 15 of FCC Rules and RSS-210 of the IC Rules. Epson cannot accept responsibility for any failure to satisfy the protection requirements resulting from a non-recommended modification of the product. Operation is subject to the following two conditions: (1) this device may not cause harmful interference, and (2) this device must accept any interference received, including interference that may cause undesired operation of the device.

To prevent radio interference to the licensed service, this device is intended to be operated indoors and away from windows to provide maximum shielding. Equipment (or its transmit antenna) that is installed outdoors is subject to licensing.

This equipment complies with FCC/IC radiation exposure limits set forth for an uncontrolled environment and meets the FCC radio frequency (RF) Exposure Guidelines in Supplement C to OET65 and RSS-102 of the IC radio frequency (RF) Exposure rules. This equipment should be installed and operated so that the radiator is kept at least 7.9 inches (20 cm) or more away from a person's body (excluding extremities: hands, wrists, feet and ankles).

Parent topic: [Technical Specifications](#)

Notices

Check these sections for important notices about your scanner.

Note: Epson offers a recycling program for end of life Epson products. Please go to [this site](#) (U.S) or [this site](#) (Canada) for information on how to return your Epson products for proper disposal.

[Important Safety Instructions](#)

[Battery Safety Instructions \(ES-60W/ES-65WR\)](#)

[Restrictions on Copying](#)

[Default Delay Times for Power Management for Epson Products](#)

[Binding Arbitration and Class Waiver](#)

[Trademarks](#)

[Copyright Notice](#)

Important Safety Instructions

Follow these safety instructions when setting up and using the scanner:

- Read all these instructions, and follow all warnings and instructions marked on the scanner.
- Place the scanner close enough to the computer for the interface cable to reach it easily.
- Do not use with wet hands.
- When connecting this product to a computer or other device with a cable, ensure the correct orientation of the connectors. Each connector has only one correct orientation. Inserting a connector in the wrong orientation may damage both devices connected by the cable.
- Do not insert objects into any opening as they may touch dangerous voltage points or short out parts. Beware of electrical shock hazards.
- Place the product on a flat, stable surface that extends beyond the base of the product in all directions. If you place the product by the wall, leave at least 3.9 inches (10 cm) between the back of the product and the wall.
- Do not subject the scanner to physical impacts or drop the scanner.
- Do not place or store the scanner outdoors, in a car, near excessive dirt or dust, water, heat sources, or in locations subject to shocks, vibrations, condensation, high temperature or humidity, direct sunlight, strong light sources, or rapid changes in temperature or humidity.

- Never disassemble, modify, or attempt to repair the scanner or a scanner option by yourself except as specifically explained in this guide.

Caution: Radio waves from this product may adversely affect the operation of medical equipment, airplanes, or automatically controlled devices, such as pacemakers, automatic doors, or fire alarms. When using this product near such devices or inside a medical facility, follow the directions from authorized staff members at the facility, and follow all posted warnings and directions on the device to avoid causing an accident (ES-60W/ES-65WR).

USB

- Use only the USB cable supplied with your product. Using any other USB cable could cause fire, electrical shock, or injury.
- The USB cable is designed for use with the product with which it was included. Do not attempt to use it with other electrical devices unless specified.
- The USB cable should be placed to avoid abrasions, cuts, fraying, crimping, and kinking.
- Do not place objects on top of the USB cable and do not allow the cable to be stepped on or run over. Be particularly careful to keep the USB cable straight at the end.
- If you are not going to use the product for a long period, unplug the USB cable from the computer.
- Unplug the scanner and the USB cable, and refer servicing to qualified service personnel under the following conditions: Liquid has entered the scanner; the scanner has been dropped or the case has been damaged; the scanner does not operate normally or exhibits a distinct change in performance. (Do not adjust controls that are not covered by the operating instructions.)

LCD Screen

- The LCD screen may have uneven brightness or a few small bright or dark spots. This is normal and does not indicate damage.
- Use only a dry, soft cloth to clean the LCD screen. Do not use liquid or chemical cleansers.
- If the LCD screen is damaged, contact Epson. If the liquid crystal solution gets on your hands, wash them thoroughly with soap and water. If the liquid crystal solution gets into your eyes, flush them immediately with water. If discomfort or vision problems remain after a thorough flushing, see a doctor immediately.
- Do not press too hard on the LCD screen or subject it to heavy impacts.
- Do not use a pointy or sharp object, such as a pen or your fingernail, to operate the LCD screen.
- If the LCD screen chips or cracks, do not touch or attempt to remove the broken pieces; contact Epson for support.

- Do not subject your product to sudden changes in temperature or humidity; this may cause condensation to develop inside the LCD screen and degrade its performance.

Parent topic: [Notices](#)

Battery Safety Instructions (ES-60W/ES-65WR)

- If the battery is not fully charged within the specified time, stop charging. Otherwise, the battery could become hot, emit smoke, rupture, or catch fire.
- Do not place the product in a microwave oven or a high-pressure container. Otherwise, the battery could become hot, emit smoke, rupture, or catch fire.
- If battery acid gets into your eyes or on your skin, immediately rinse the affected area thoroughly with water without rubbing and seek medical treatment.
- If battery acid leaks from a battery, or the product emits a bad odor, move the product away from flammable objects immediately. If the product is not moved, electrolytes leaking from the battery become hot, emit smoke, rupture, or catch fire.
- Do not subject the scanner to physical impacts or drop the scanner. Otherwise, the battery could leak or the protection circuit in the battery could be damaged. As a result, the battery could become hot, emit smoke, rupture, or catch fire.
- Do not use or place the product in temperatures exceeding 140°F (60°C), such as near a fire or a heater. Otherwise, the plastic separator could melt and the individual cells could short-circuit. As a result, the battery could become hot, emit smoke, rupture, or catch fire.
- Do not use the product if it is leaking or damaged in any way. Otherwise, the battery could become hot, emit smoke, rupture, or catch fire.
- Do not leave the product in a vehicle. Otherwise, the battery could overheat.
- Always charge the battery within an ambient temperature range of 46°F to 95°F (8°C to 35°C).

Parent topic: [Notices](#)

Restrictions on Copying

Observe the following restrictions to ensure responsible and legal use of your scanner.

Copying of the following items is prohibited by law:

- Bank bills, coins, government-issued marketable securities, government bond securities, and municipal securities
- Unused postage stamps, pre-stamped postcards, and other official postal items bearing valid postage
- Government-issued revenue stamps, and securities issued according to legal procedure

Exercise caution when copying the following items:

- Private marketable securities (stock certificates, negotiable notes, checks, etc.), monthly passes, concession tickets, etc.
- Passports, driver's licenses, warrants of fitness, road passes, food stamps, tickets, etc.

Note: Copying these items may also be prohibited by law.

Restriction on disassembling and decompiling

You may not disassemble, decompile, or otherwise attempt to derive the source code of any software included with this product.

Parent topic: [Notices](#)

Default Delay Times for Power Management for Epson Products

This product will enter sleep mode after a period of nonuse. This is to ensure that the product meets Energy Star standards of energy efficiency. More energy savings can be achieved by setting the time to sleep to a shorter interval.

Parent topic: [Notices](#)

Binding Arbitration and Class Waiver

1. DISPUTES, BINDING INDIVIDUAL ARBITRATION, AND WAIVER OF CLASS ACTIONS AND CLASS ARBITRATIONS

1.1 Disputes. The terms of this Section 1 shall apply to all Disputes between you and Epson. The term "Dispute" is meant to have the broadest meaning permissible under law and includes any dispute, claim, controversy or action between you and Epson arising out of or relating to this Agreement, Epson branded products (hardware and including any related software), or other transaction involving you and Epson, whether in contract, warranty, misrepresentation, fraud, tort, intentional tort, statute, regulation, ordinance, or any other legal or equitable basis. "DISPUTE" DOES NOT INCLUDE IP CLAIMS, or more specifically, a claim or cause of action for (a) trademark infringement or dilution, (b) patent infringement, (c) copyright infringement or misuse, or (d) trade secret misappropriation (an "IP Claim"). You and Epson also agree, notwithstanding Section 1.6, that a court, not an arbitrator, may decide if a claim or cause of action is for an IP Claim.

1.2 Binding Arbitration. You and Epson agree that all Disputes shall be resolved by binding arbitration according to this Agreement. **ARBITRATION MEANS THAT YOU WAIVE YOUR RIGHT TO A JUDGE OR JURY IN A COURT PROCEEDING AND YOUR GROUNDS FOR APPEAL ARE LIMITED.**

Pursuant to this Agreement, binding arbitration shall be administered by JAMS, a nationally recognized

arbitration authority, pursuant to its code of procedures then in effect for consumer related disputes, but excluding any rules that permit joinder or class actions in arbitration (for more detail on procedure, see Section 1.6 below). You and Epson understand and agree that (a) the Federal Arbitration Act (9 U.S.C. §1, et seq.) governs the interpretation and enforcement of this Section 1, (b) this Agreement memorializes a transaction in interstate commerce, and (c) this Section 1 shall survive termination of this Agreement.

1.3 Pre-Arbitration Steps and Notice. Before submitting a claim for arbitration, you and Epson agree to try, for sixty (60) days, to resolve any Dispute informally. If Epson and you do not reach an agreement to resolve the Dispute within the sixty (60) days, you or Epson may commence an arbitration. Notice to Epson must be addressed to: Epson America, Inc., ATTN: Legal Department, 3840 Kilroy Airport Way, Long Beach, CA 90806 (the "Epson Address"). The Dispute Notice to you will be sent to the most recent address Epson has in its records for you. For this reason, it is important to notify us if your address changes by emailing us at EAlegal@ea.epson.com or writing us at the Epson Address above. Notice of the Dispute shall include the sender's name, address and contact information, the facts giving rise to the Dispute, and the relief requested (the "Dispute Notice"). Following receipt of the Dispute Notice, Epson and you agree to act in good faith to resolve the Dispute before commencing arbitration.

1.4 Small Claims Court. Notwithstanding the foregoing, you may bring an individual action in the small claims court of your state or municipality if the action is within that court's jurisdiction and is pending only in that court.

1.5 WAIVER OF CLASS ACTIONS AND CLASS ARBITRATIONS. YOU AND EPSON AGREE THAT EACH PARTY MAY BRING DISPUTES AGAINST THE OTHER PARTY ONLY IN AN INDIVIDUAL CAPACITY, AND NOT AS A PLAINTIFF OR CLASS MEMBER IN ANY CLASS OR REPRESENTATIVE PROCEEDING, INCLUDING WITHOUT LIMITATION FEDERAL OR STATE CLASS ACTIONS, OR CLASS ARBITRATIONS. CLASS ACTION LAWSUITS, CLASS-WIDE ARBITRATIONS, PRIVATE ATTORNEY-GENERAL ACTIONS, AND ANY OTHER PROCEEDING WHERE SOMEONE ACTS IN A REPRESENTATIVE CAPACITY ARE NOT ALLOWED. ACCORDINGLY, UNDER THE ARBITRATION PROCEDURES OUTLINED IN THIS SECTION, AN ARBITRATOR SHALL NOT COMBINE OR CONSOLIDATE MORE THAN ONE PARTY'S CLAIMS WITHOUT THE WRITTEN CONSENT OF ALL AFFECTED PARTIES TO AN ARBITRATION PROCEEDING.

1.6 Arbitration Procedure. If you or Epson commences arbitration, the arbitration shall be governed by the rules of JAMS that are in effect when the arbitration is filed, excluding any rules that permit arbitration on a class or representative basis (the "JAMS Rules"), available at <http://www.jamsadr.com> or by calling 1-800-352-5267, and under the rules set forth in this Agreement. All Disputes shall be resolved by a single neutral arbitrator, and both parties shall have a reasonable opportunity to participate in the selection of the arbitrator. The arbitrator is bound by the terms of this Agreement. The arbitrator, and not any federal, state or local court or agency, shall have exclusive authority to resolve all disputes arising out of or relating to the interpretation, applicability, enforceability or formation of this Agreement, including any claim that all or any part of this Agreement is void or voidable. Notwithstanding this broad

delegation of authority to the arbitrator, a court may determine the limited question of whether a claim or cause of action is for an IP Claim, which is excluded from the definition of "Disputes" in Section 1.1 above. The arbitrator shall be empowered to grant whatever relief would be available in a court under law or in equity. The arbitrator may award you the same damages as a court could, and may award declaratory or injunctive relief only in favor of the individual party seeking relief and only to the extent necessary to provide relief warranted by that party's individual claim. In some instances, the costs of arbitration can exceed the costs of litigation and the right to discovery may be more limited in arbitration than in court. The arbitrator's award is binding and may be entered as a judgment in any court of competent jurisdiction.

You may choose to engage in arbitration hearings by telephone. Arbitration hearings not conducted by telephone shall take place in a location reasonably accessible from your primary residence, or in Orange County, California, at your option.

a) Initiation of Arbitration Proceeding. If either you or Epson decides to arbitrate a Dispute, both parties agree to the following procedure:

(i) Write a Demand for Arbitration. The demand must include a description of the Dispute and the amount of damages sought to be recovered. You can find a copy of a Demand for Arbitration at <http://www.jamsadr.com> ("Demand for Arbitration").

(ii) Send three copies of the Demand for Arbitration, plus the appropriate filing fee, to: JAMS, 500 North State College Blvd., Suite 600 Orange, CA 92868, U.S.A.

(iii) Send one copy of the Demand for Arbitration to the other party (same address as the Dispute Notice), or as otherwise agreed by the parties.

b) Hearing Format. During the arbitration, the amount of any settlement offer made shall not be disclosed to the arbitrator until after the arbitrator determines the amount, if any, to which you or Epson is entitled. The discovery or exchange of non-privileged information relevant to the Dispute may be allowed during the arbitration.

c) Arbitration Fees. Epson shall pay, or (if applicable) reimburse you for, all JAMS filings and arbitrator fees for any arbitration commenced (by you or Epson) pursuant to provisions of this Agreement.

d) Award in Your Favor. For Disputes in which you or Epson seeks \$75,000 or less in damages exclusive of attorney's fees and costs, if the arbitrator's decision results in an award to you in an amount greater than Epson's last written offer, if any, to settle the Dispute, Epson will: (i) pay you \$1,000 or the amount of the award, whichever is greater; (ii) pay you twice the amount of your reasonable attorney's fees, if any; and (iii) reimburse you for any expenses (including expert witness fees and costs) that your attorney reasonably accrues for investigating, preparing, and pursuing the Dispute in arbitration. Except as agreed upon by you and Epson in writing, the arbitrator shall determine the amount of fees, costs, and expenses to be paid by Epson pursuant to this Section 1.6d).

e) Attorney's Fees. Epson will not seek its attorney's fees and expenses for any arbitration commenced involving a Dispute under this Agreement. Your right to attorney's fees and expenses under Section

1.6d) above does not limit your rights to attorney's fees and expenses under applicable law; notwithstanding the foregoing, the arbitrator may not award duplicative awards of attorney's fees and expenses.

1.7 Opt-out. You may elect to opt-out (exclude yourself) from the final, binding, individual arbitration procedure and waiver of class and representative proceedings specified in this Agreement by sending a written letter to the Epson Address within thirty (30) days of your assent to this Agreement (including without limitation the purchase, download, installation of the Software or other applicable use of Epson Hardware, products and services) that specifies (i) your name, (ii) your mailing address, and (iii) your request to be excluded from the final, binding individual arbitration procedure and waiver of class and representative proceedings specified in this Section 1. In the event that you opt-out consistent with the procedure set forth above, all other terms shall continue to apply, including the requirement to provide notice prior to litigation.

1.8 Amendments to Section 1. Notwithstanding any provision in this Agreement to the contrary, you and Epson agree that if Epson makes any future amendments to the dispute resolution procedure and class action waiver provisions (other than a change to Epson's address) in this Agreement, Epson will obtain your affirmative assent to the applicable amendment. If you do not affirmatively assent to the applicable amendment, you are agreeing that you will arbitrate any Dispute between the parties in accordance with the language of this Section 1 (or resolve disputes as provided for in Section 1.7, if you timely elected to opt-out when you first assented to this Agreement).

1.9 Severability. If any provision in this Section 1 is found to be unenforceable, that provision shall be severed with the remainder of this Agreement remaining in full force and effect. **The foregoing shall not apply to the prohibition against class or representative actions as provided in Section 1.5. This means that if Section 1.5 is found to be unenforceable, the entire Section 1 (but only Section 1) shall be null and void.**

Parent topic: [Notices](#)

Trademarks

EPSON® is a registered trademark and EPSON Exceed Your Vision is a registered logomark of Seiko Epson Corporation.

Windows is a registered trademark of Microsoft Corporation in the United States and/or other countries.

Apple, App Store, Mac, macOS, and OS X are trademarks of Apple Inc., registered in the U.S. and other countries.

Google® is a registered trademark, and Android™ and Google Play™ are trademarks of Google LLC.

General Notice: Other product names used herein are for identification purposes only and may be trademarks of their respective owners. Epson disclaims any and all rights in those marks.



Parent topic: [Notices](#)

Copyright Notice

All rights reserved. No part of this publication may be reproduced, stored in a retrieval system, or transmitted in any form or by any means, electronic, mechanical, photocopying, recording, or otherwise, without the prior written permission of Seiko Epson Corporation. The information contained herein is designed only for use with this Epson product. Epson is not responsible for any use of this information as applied to other products.

Neither Seiko Epson Corporation nor its affiliates shall be liable to the purchaser of this product or third parties for damages, losses, costs, or expenses incurred by purchaser or third parties as a result of: accident, misuse, or abuse of this product or unauthorized modifications, repairs, or alterations to this product, or (excluding the U.S.) failure to strictly comply with Seiko Epson Corporation's operating and maintenance instructions.

Seiko Epson Corporation shall not be liable for any damages or problems arising from the use of any options or any consumable products other than those designated as Original Epson Products or Epson Approved Products by Seiko Epson Corporation.

Seiko Epson Corporation shall not be held liable for any damage resulting from electromagnetic interference that occurs from the use of any interface cables other than those designated as Epson approved Products by Seiko Epson Corporation.

This information is subject to change without notice.

[libTIFF Software Acknowledgment](#)

[A Note Concerning Responsible Use of Copyrighted Materials](#)

[Copyright Attribution](#)

Parent topic: [Notices](#)

libTIFF Software Acknowledgment

Copyright © 1988-1997 Sam Leffler

Copyright © 1991-1997 Silicon Graphics, Inc.

Permission to use, copy, modify, distribute, and sell this software and its documentation for any purpose is hereby granted without fee, provided that (i) the above copyright notices and this permission notice appear in all copies of the software and related documentation, and (ii) the names of Sam Leffler and Silicon Graphics may not be used in any advertising or publicity relating to the software without the specific, prior written permission of Sam Leffler and Silicon Graphics.

THE SOFTWARE IS PROVIDED "AS-IS" AND WITHOUT WARRANTY OF ANY KIND, EXPRESS, IMPLIED OR OTHERWISE, INCLUDING WITHOUT LIMITATION, ANY WARRANTY OF MERCHANTABILITY OR FITNESS FOR A PARTICULAR PURPOSE.

IN NO EVENT SHALL SAM LEFFLER OR SILICON GRAPHICS BE LIABLE FOR ANY SPECIAL, INCIDENTAL, INDIRECT OR CONSEQUENTIAL DAMAGES OF ANY KIND, OR ANY DAMAGES WHATSOEVER RESULTING FROM LOSS OF USE, DATA OR PROFITS, WHETHER OR NOT ADVISED OF THE POSSIBILITY OF DAMAGE, AND ON ANY THEORY OF LIABILITY, ARISING OUT OF OR IN CONNECTION WITH THE USE OR PERFORMANCE OF THIS SOFTWARE.

Parent topic: [Copyright Notice](#)

A Note Concerning Responsible Use of Copyrighted Materials

Epson encourages each user to be responsible and respectful of the copyright laws when using any Epson product. While some countries' laws permit limited copying or reuse of copyrighted material in certain circumstances, those circumstances may not be as broad as some people assume. Contact your legal advisor for any questions regarding copyright law.

Parent topic: [Copyright Notice](#)

Copyright Attribution

© 2018 Epson America, Inc.

10/18

CPD-56105

Parent topic: [Copyright Notice](#)

Free Manuals Download Website

<http://myh66.com>

<http://usermanuals.us>

<http://www.somanuals.com>

<http://www.4manuals.cc>

<http://www.manual-lib.com>

<http://www.404manual.com>

<http://www.luxmanual.com>

<http://aubethermostatmanual.com>

Golf course search by state

<http://golfingnear.com>

Email search by domain

<http://emailbydomain.com>

Auto manuals search

<http://auto.somanuals.com>

TV manuals search

<http://tv.somanuals.com>