

ES-580W/RR-600W User's Guide

Contents

ES-580W/RR-600W User's Guide	9
Scanner Basics.....	10
Using the Control Panel	10
Control Panel Buttons and Lights	11
LCD Screen.....	11
Status Icon Information.....	12
Navigating the LCD Screen	13
Entering Characters on the LCD Screen	13
Viewing Animations	14
Adjusting the Screen Brightness	16
Adjusting Control Panel Sounds.....	16
Selecting the Date and Time	17
Changing LCD Screen Language	17
Changing the Keyboard Layout.....	18
Adjusting the Operation Time Out Setting	18
Preventing PC Connection via USB	18
Setting Direct Power On.....	19
Customizing the Control Panel Display	19
Registering Presets	19
Customizing the Home Screen	21
Changing Regular Cleaning Alert Settings	24
Changing Roller Replacement Alert Settings	25
Setting User Access Restrictions (Access Control)	25
Setting Up Epson Connect Services	27
Scanner Parts Locations	27
Scanner Parts.....	28
User Replaceable Epson Scanner Parts	30
Using Power Saving Settings	31
Changing the Sleep Timer Settings	31
Changing the Power Off Timer Settings	31

Using the Epson Smart Panel Mobile App.....	32
Loading Originals	33
Loading Originals in the Input Tray.....	33
Loading Multiple Sizes of Originals in the Input Tray	41
Original Document Specifications.....	44
Loading Plastic and Laminated Cards in the Input Tray	47
Plastic and Laminated Card Specifications	51
Loading Special Originals.....	52
Special Original Specifications	59
Wi-Fi Networking	61
Network Security Recommendations	61
Connecting to an Existing Wi-Fi Network	62
Selecting Wireless Network Settings from the Control Panel	63
Direct Wi-Fi Mode (AP Mode) Setup	65
Connecting to a Mobile Device	66
Setting Up Wireless Scanning from a Smart Device Using Epson Smart Panel	66
Wi-Fi Protected Setup (WPS).....	67
Using WPS to Connect to a Network	68
Using WPS PIN Mode to Connect to a Network	68
Setting Up Network Scanning	69
Determining the Scanner's IP Address	72
Disabling Wi-Fi Features	72
Scanning	73
Starting a Scan.....	73
Starting a Scan Using the Product Control Panel	73
Scanning to a Network Folder	74
Scanning to an Email.....	75
Scanning to the Cloud	76
Scanning to an External USB Device	77
Setting Up a WSD Port (Windows 7)	78
Scanning Using WSD - Windows	79
Scanning Using Presets	79
Starting a Scan from a Smart Device	80

Scanning a Document in Epson ScanSmart.....	80
Saving a Scan	83
Attaching a Scan to Email.....	84
Sending a Scan to a Cloud Service	85
Printing a Scan	86
Saving a Scan as a Microsoft Office Format File	88
Selecting Epson ScanSmart Settings.....	89
Changing the Epson Product.....	89
Changing the Scan Settings	90
Changing the File Name Settings	93
Changing the Save Settings	94
Save Settings.....	96
Customizing Action Icons	98
Scanning Using Invoice/Receipt Manager.....	99
Starting a Free Trial	100
Hiding the Receipt Manager Trial Icons	103
Activating Receipt Manager.....	104
Scanning Receipts and Using Receipt Manager	108
Exporting Invoices or Receipts to QuickBooks Online	111
Exporting Invoices or Receipts to QuickBooks Desktop.....	112
Saving or Exporting Receipts to Quicken.....	113
Saving Receipt Data as a TurboTax File.....	114
Saving Invoice or Receipt Data as a CSV File	115
Scanning Invoices or Receipts as an Image File.....	115
Selecting Invoice/Receipt Manager Settings	116
Exporting or Importing the Invoice/Receipt Database.....	116
Changing Column Settings.....	117
Changing Currency and Language Settings.....	118
Importing Categories from QuickBooks or Quicken	120
Scan Resolution Guidelines	122
Cleaning and Transporting Your Scanner.....	124
Cleaning Your Scanner	124
Cleaning Inside Your Scanner.....	124

Checking the Scanner Roller Counter	134
Replacing the Scanner Rollers	136
Resetting the Scanner Roller Counter	142
Transporting Your Scanner	142
Solving Problems	145
Product Status Messages	145
Solving Scanning Problems	147
Scanner Does Not Turn On or Turns Off Unexpectedly	147
Scanner Button Does Not Work as Expected	147
Scanning Software Does Not Operate Correctly	148
Original Feeds Incorrectly in Scanner	149
Original Jams in Scanner	150
Paper Protection Does Not Work Correctly	152
Scanning is Slow	153
Cannot Send Scans to a Cloud Service	153
Cannot Send Scans to an Email	154
Solving Network Scanning Problems	154
Cannot Scan Over a Network	154
Scanner Cannot Connect to a Wireless Router	155
Solving Scanned Image Quality Problems	156
Back of Original Image Appears in Scanned Image	157
Scanned Characters are Blurry	157
Characters are not Recognized During Conversion to Editable Text (OCR)	158
Ripple Patterns Appear in an Image	158
Spots or Lines Appear in All Scanned Images	159
Scanned Image is Cropped	159
Resetting the Epson Scan 2 Settings	160
Solving Invoice/Receipt Manager Problems	160
Cannot Access an Accounting Service	160
Cannot Import Invoice/Receipt Database	161
License Key is Disabled	161
Uninstall Your Scanner Software	161
Uninstalling Scanner Software - Windows	161

Uninstalling Scanner Software - Mac.....	162
Where to Get Help (U.S. and Canada)	163
Where to Get Help (Latin America).....	164
Technical Specifications	166
Windows System Requirements	166
Mac System Requirements	166
General Specifications	167
Dimension Specifications	168
Electrical Specifications	168
Environmental Specifications	169
Network Interface Specifications	170
Safety and Approvals Specifications	171
Notices	174
Important Safety Instructions.....	174
Restrictions on Copying	177
Default Delay Times for Power Management for Epson Products.....	177
Binding Arbitration and Class Waiver	178
Trademarks	181
Copyright Notice.....	181
libTIFF Software Acknowledgment.....	182
A Note Concerning Responsible Use of Copyrighted Materials.....	182
Copyright Attribution	183

ES-580W/RR-600W User's Guide

Welcome to the ES-580W/RR-600W *User's Guide*.

For a printable PDF copy of this guide, click [here](#).

Note: Availability of products in this guide varies by country.

Note: The illustrations in this guide show the ES-580W, but the instructions are the same for the RR-600W unless otherwise noted.

If you have not already done so, you can download the Epson ScanSmart software for use with your scanner. Visit epson.com/support (U.S.), epson.ca/support (Canada), or latin.epson.com/support (Caribbean) and select your product. Then select the software on the **Downloads** tab.

Scanner Basics

See these sections to learn about the basic features of your scanner.

- [Using the Control Panel](#)
- [Adjusting the Screen Brightness](#)
- [Adjusting Control Panel Sounds](#)
- [Selecting the Date and Time](#)
- [Changing LCD Screen Language](#)
- [Changing the Keyboard Layout](#)
- [Adjusting the Operation Time Out Setting](#)
- [Preventing PC Connection via USB](#)
- [Setting Direct Power On](#)
- [Customizing the Control Panel Display](#)
- [Changing Regular Cleaning Alert Settings](#)
- [Changing Roller Replacement Alert Settings](#)
- [Setting User Access Restrictions \(Access Control\)](#)
- [Setting Up Epson Connect Services](#)
- [Scanner Parts Locations](#)
- [User Replaceable Epson Scanner Parts](#)
- [Using Power Saving Settings](#)
- [Using the Epson Smart Panel Mobile App](#)

Using the Control Panel

See these sections to learn about the control panel and select control panel settings.

- [Control Panel Buttons and Lights](#)
- [LCD Screen](#)
- [Status Icon Information](#)
- [Navigating the LCD Screen](#)
- [Entering Characters on the LCD Screen](#)
- [Viewing Animations](#)

Parent topic: [Scanner Basics](#)

Control Panel Buttons and Lights

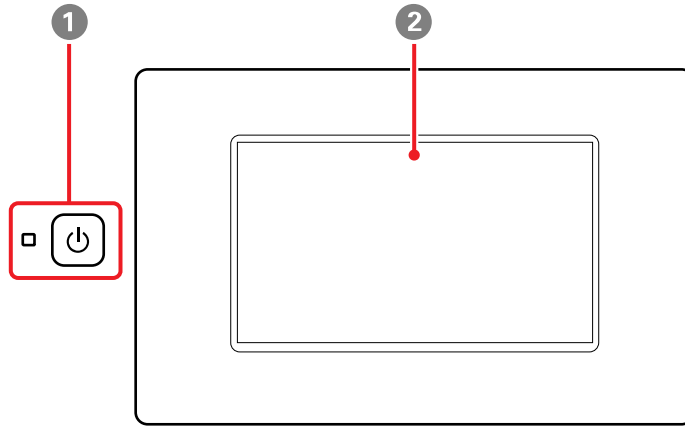

- 1 ⏻ power button and the ⏻ power light
- 2 LCD screen

Parent topic: [Using the Control Panel](#)

LCD Screen

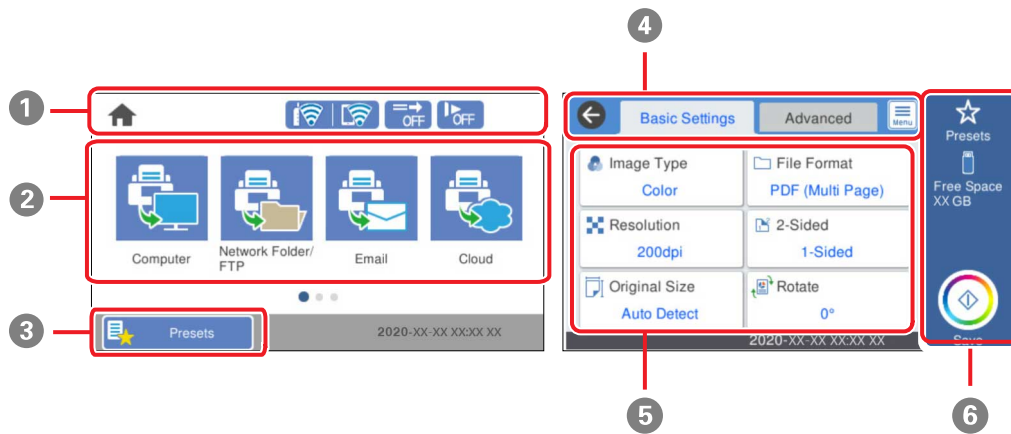















- 1 Displays various status information; select an icon to check its status or adjust its settings
- 2 Menu options
- 3 Displays the presets list; load your presets and register new presets
- 4 Select a tab to view different options and settings
- 5 Setting options
- 6 Select to perform an action

Parent topic: [Using the Control Panel](#)

Status Icon Information

Your product displays status icons on the LCD screen for certain product status conditions.

Icons	Description
	Displays the home screen.
	Returns to the home screen.
	<p>Displays the network connection status; select the icon to set up or change your network connection.</p> <ul style="list-style-type: none"> •  The product is not connected to a wireless network. •  The product is searching for an SSID or experiencing a wireless network connection issue. •  The product is connected to a wireless network; the number of bars indicates the connection's signal strength. •  Wi-Fi Direct is not enabled. •  Wi-Fi Direct is enabled.
	<p>The DFDS Function (Double Feed Detection Skip Function) is enabled or disabled. Select the icon to change the setting.</p> <p>This function skips double feed detection once and continues scanning. Enable DFDS Function to scan originals (plastic cards or envelopes) that are detected as double feeds.</p>
	<p>The Slow function is enabled or disabled. Select the icon to change the setting.</p> <p>This function slows down the scanning speed. Enable this function to scan originals (such as thin paper) that are likely to jam.</p>

Icons	Description
	Displays the previous screen.
	Indicates that the settings have been changed from the user default or the factory default.
	Displays additional information or instructions; select the icon to display the information.
	There is a problem with the indicated setting; select the icon for information on resolving the problem.

Parent topic: [Using the Control Panel](#)

Navigating the LCD Screen

Follow these guidelines to navigate and use the menus on the LCD screen.



Tap or press the screen to select an item or icon



Flick the screen to scroll swiftly



Slide your finger across the screen to move items

To change a setting, tap anywhere on the setting.

To enter a value in a field, tap the field to display the on-screen keyboard.

Parent topic: [Using the Control Panel](#)

Entering Characters on the LCD Screen

Follow these guidelines to enter characters for passwords and other settings.

On-screen keyboard

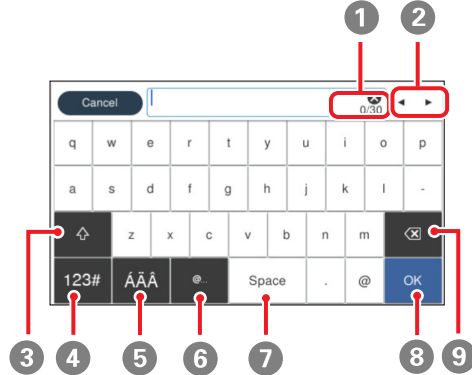

- 1 Displays the character count
- 2 Moves the cursor left or right
- 3 Switches between uppercase and lowercase characters
- 4 Switches between characters and numbers or symbols
- 5 Switches the character type
- 6 Displays a list of common domain names to choose from
- 7 Enters a space
- 8 Select when you are finished
- 9 Deletes the previous character

Parent topic: [Using the Control Panel](#)

Viewing Animations

You can view animations on the LCD screen to help guide you with a procedure or to troubleshoot a problem.

1. Select **Help** on the home screen.

You see a screen like this:

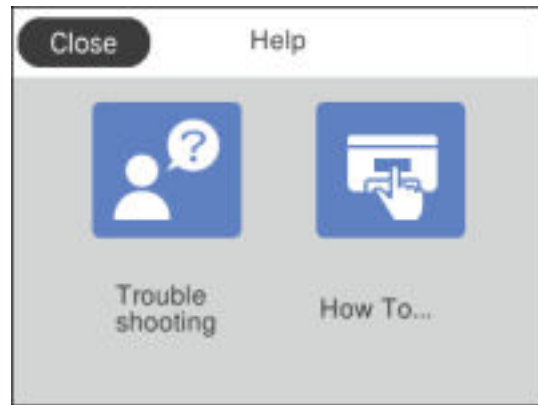

2. Select **Troubleshooting** if you are experiencing a problem or **How To** to view instructions on common procedures.
3. Select a topic from the list of available topics and follow the on-screen instructions.

While viewing the topics, you may see screens like this:

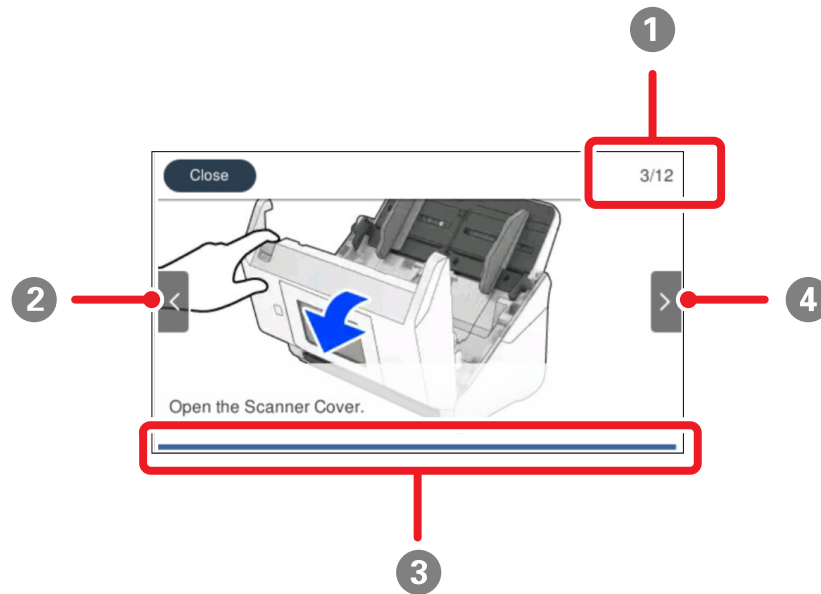



- 1 Displays the current step number and the total number of steps
- 2 Select the left arrow to view the previous step
- 3 Indicates your overall progress through the animation
- 4 Select the right arrow to view the next step

Parent topic: [Using the Control Panel](#)

Adjusting the Screen Brightness



You can adjust the brightness of the LCD screen.

1. Select  home, if necessary.
2. Select **Settings** > **Basic Settings**.
3. Select **LCD Brightness**.
4. Select the – or + icon to decrease or increase the brightness.
5. Select **OK** to exit.
6. Select the  return home icon to return to the home screen.

Parent topic: [Scanner Basics](#)

Adjusting Control Panel Sounds

You can adjust the sound level heard when you press buttons on the control panel.

1. Select  home, if necessary.
2. Select **Settings** > **Basic Settings**.
3. Select **Sounds**.
4. Do one of the following:
 - To mute all control panel sounds, turn the **Button Press** setting off.
 - To adjust the sound level for scanner errors, select **Error Notice** and tap the icons to select the desired level.
5. Select **OK** to exit.
6. Select the  return home icon to return to the home screen.

Parent topic: [Scanner Basics](#)

Selecting the Date and Time

Select the current date, time, and daylight saving phase in your area, and choose your preferred date and time format.

1. Select  home, if necessary.
2. Select **Settings** > **Basic Settings**.
3. Select **Date/Time Settings**.
4. Select **Daylight Saving Time**.
5. Select the setting that applies to your area:
 - **Winter**: it is winter or your region does not use Daylight Saving Time (DST)
 - **Summer**: it is spring or summer and your region uses Daylight Saving Time (DST)

Note: If your region uses Daylight Saving Time (DST), you must change this setting to match the season. When you change from **Winter** to **Summer**, your product automatically sets its clock ahead one hour. When you change from **Summer** to **Winter**, it sets its clock back one hour.

6. Select **Date/Time**.
7. Select the date format you want to use.
8. Use the numeric keypad to enter the current date, then select **OK**.
9. Select the time format you want to use.
10. Use the numeric keypad to enter the current time, then select **OK**.
11. Select **Time Difference**.
12. Use the **+** and **-** buttons to enter the time difference between your time zone and UTC (Coordinated Universal Time), then select **OK**.
13. Select the  return home icon to return to the home screen.

Parent topic: [Scanner Basics](#)

Changing LCD Screen Language

You can change the language used on the LCD screen.



1. Select  home, if necessary.
2. Select **Settings** > **Basic Settings**.

3. Scroll down and select **Language**.
4. Select a language.
5. Select the  return home icon to return to the home screen.

Parent topic: [Scanner Basics](#)

Changing the Keyboard Layout



You can change the layout of the keyboard on the control panel.

1. Select  home, if necessary.
2. Select **Settings > Basic Settings**.
3. Select **Keyboard**.
4. Select the layout you want to use.
5. Select the  return home icon to return to the home screen.

Parent topic: [Scanner Basics](#)

Adjusting the Operation Time Out Setting

The Operation Time Out setting causes the LCD screen to return to the Home screen after a few minutes of inactivity. This feature is enabled by default, but you can turn it off.

1. Select  home, if necessary.
2. Select **Settings > Basic Settings**.
3. Scroll down and select **Operation Time Out**.
4. Tap the setting to toggle it **On** or **Off** (**On** is the default).
5. If you want to increase or decrease the number of minutes, select **Time** and tap the **+** and **-** icons to set the desired number.
6. Select **OK** to exit.
7. Select the  return home icon to return to the home screen.

Parent topic: [Scanner Basics](#)

Preventing PC Connection via USB

You can disable access to your product from a USB-connected computer. This restricts non-network access to the product.



1. Select  home, if necessary.
2. Select **Settings** > **Basic Settings**.
3. Scroll down and select **PC Connection via USB**.
4. Select **Disable**.
5. Select **Yes** to restart the printer.

Parent topic: [Scanner Basics](#)

Setting Direct Power On

You can turn on the scanner directly when the scanner is connected to the power source, without pressing the power button.

Note: This setting can be locked by an administrator. If you cannot access or change this setting, contact your administrator for assistance.

1. Select  home, if necessary.
2. Select **Settings** > **Basic Settings**.
3. Scroll down and select **Direct Power On**.
4. Select **On**.
5. Select the  return home icon to return to the home screen.

Parent topic: [Scanner Basics](#)

Customizing the Control Panel Display

You can register up to 48 frequently used scanning setting as Presets and add the icon of the registered preset to the home screen. See these sections to learn about how to customize the control panel display.

[Registering Presets](#)

[Customizing the Home Screen](#)

Parent topic: [Scanner Basics](#)

Registering Presets

You can register up to 48 frequently used scanning settings as presets.

Note: To register presets using Web Config, select **Presets** on the Scan tab and follow the instructions on the screen.

1. Select 🏠 home, if necessary.
2. Select **Presets**.

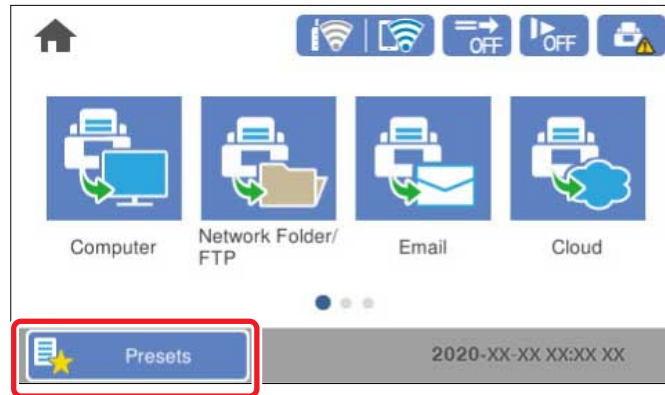



3. Select a + icon.

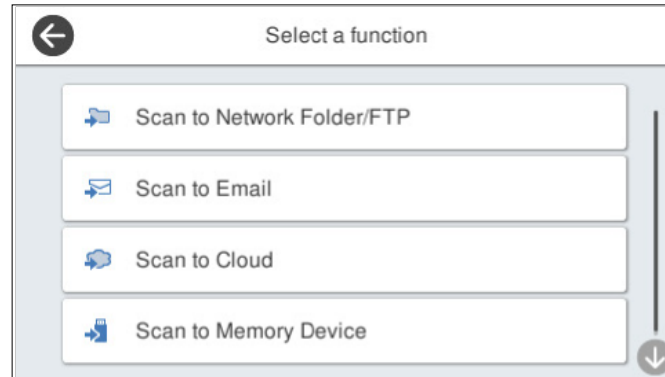

4. Select the scanning option you want to register as a preset.



Note: For some scanning options, it is best to configure the destination information (such as email contacts or network folders) before registering the preset. You can still configure the destination information while registering the preset, but if it is configured beforehand, you can simply make your selections from the existing list.

5. Tap the  **Register** icon to register the preset.
6. Enter the following settings:
 - **Name:** Enter a name for the preset.
 - **Set Icon:** Select an icon and background color for the preset.
 - **Quick Send Setting:** Select **On** to start scanning immediately when the preset is selected.
 - **Contents:** Change scan settings as necessary.
7. Select **OK** to save the preset settings.
8. Select the  return home icon to return to the home screen.

Parent topic: [Customizing the Control Panel Display](#)

Customizing the Home Screen

You can use the **Edit Home** option to customize the layout and appearance of the home screen and add icons to the presets.

Note: This setting can be locked by an administrator. If you cannot access or change this setting, contact your administrator for assistance.

1. Select **🏠** home, if necessary.
2. Select **Settings > Edit Home**.
3. Choose from the following:
 - Select **Layout** to change the layout of the home screen.
Select **Line** to display the icons in a horizontal line across the home screen.



Select **Matrix** to display the icons in a matrix on the home screen.



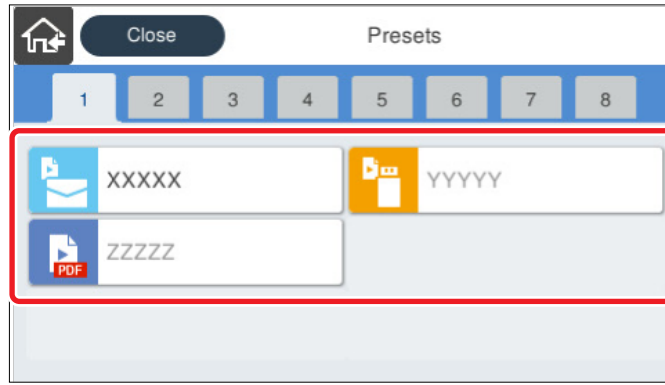

- Select **Add Icon** and choose **Function** to display icons for the default scanner functions, or **Presets** to select a preset icon to display on the home screen.

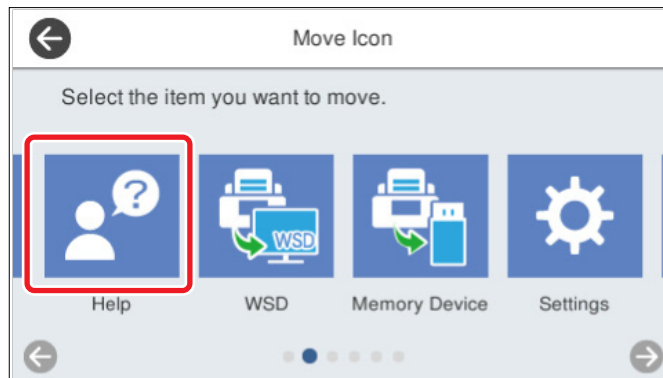
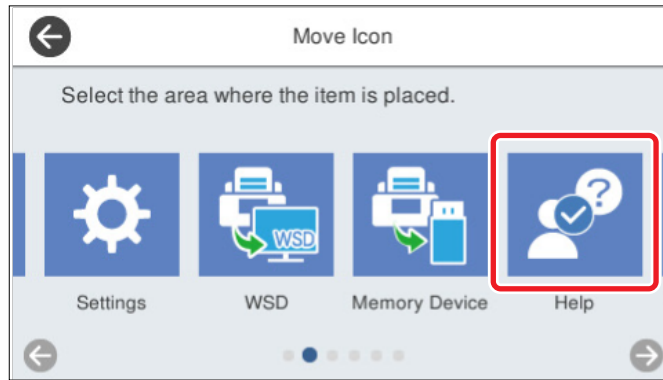

- Select **Remove Icon** and select the preset you want to remove from the home screen.

- Select **Move Icon** to reorder presets on the home screen. Select the icon you want to move, and then select the icon that is occupying the space you want to move the new icon to. The icons switch positions.





4. When you are finished customizing the home screen, select the  return home icon to return to the home screen and view your changes.

Parent topic: [Customizing the Control Panel Display](#)

Changing Regular Cleaning Alert Settings

You can set an alert to appear to remind you to perform regular cleaning after a certain number of scans.

Note: This setting can be locked by an administrator. If you cannot access or change this setting, contact your administrator for assistance.



1. Select  home, if necessary.
2. Scroll down and select **Regular Cleaning Alert Settings**.
3. Do the following:
 - Set the **Warning Alert Setting** to **On** to receive a notification when it is time to clean inside the scanner.
 - On the **Count Alert Setting** screen, use the **+** and **-** icons to change the number of scans before the notification appears.
4. Select **OK** to exit.
5. Select the  return home icon to return to the home screen.

Parent topic: [Scanner Basics](#)

Changing Roller Replacement Alert Settings

You can set an alert to appear to remind you to replace the roller after a certain number of scans.

Note: This setting can be locked by an administrator. If you cannot access or change this setting, contact your administrator for assistance.

1. Select  home, if necessary.
2. Select **Settings > Roller Replacement Alert Setting**.
3. Select **Count Alert Setting**.
4. Use the **+** and **-** icons to change the number of scans (1,000 to 200,000) before the notification appears.
5. Select **OK** to exit.
6. Select the  return home icon to return to the home screen.

Parent topic: [Scanner Basics](#)

Setting User Access Restrictions (Access Control)

You can set an administrator password to lock the following settings and prevent them from being changed:

Note: You should set an administrator password and keep it in a safe place. You must know the administrator password in order to change or delete it. If you forget the password or inadvertently set it, the product will need to be sent to Epson for service.

- Sleep Timer
- Power Off Timer
- Date/Time Settings
- Language
- Operation Time Out
- PC Connection via USB
- Direct Power On
- Double Feed Stop Timing
- Paper Protection
- Detect Glass Dirt
- Ultrasonic Double Feed Detection
- Automatic Feeding Mode Timeout
- Edit Home
- User Settings
- Network Settings
- Web Service Settings
- System Administration
- Regular Cleaning Alert Settings
- Roller Replacement Alert Settings
- Number of Scans After Replacing Roller
- Number of Scans After Regular Cleaning

Note: If your system has an administrator, contact your administrator before enabling restricted access.

1. Select  home, if necessary.
2. Select **Settings**.

3. Select **System Administration**.
4. Select **Admin Settings**.
5. Select **Lock Setting > On**.

Note: An Admin Password needs to be registered to access **Lock Setting**.

To disable access restriction, select **Settings > System Administration > Admin Settings > Lock Setting > Off**.

Parent topic: [Scanner Basics](#)

Setting Up Epson Connect Services

If you did not activate your product's email address for use with Epson Connect when you set up your product, you can activate it using the product control panel.

1. Select  home, if necessary.
2. Select **Settings**.
3. Select **Web Service Settings**.
4. Select **Epson Connect Services**.
5. Select **Registration**.
6. Follow the instructions on the screen to activate your product's email address.

Parent topic: [Scanner Basics](#)

Scanner Parts Locations

See these sections to identify the parts on your scanner.

[Scanner Parts](#)

Parent topic: [Scanner Basics](#)

Scanner Parts

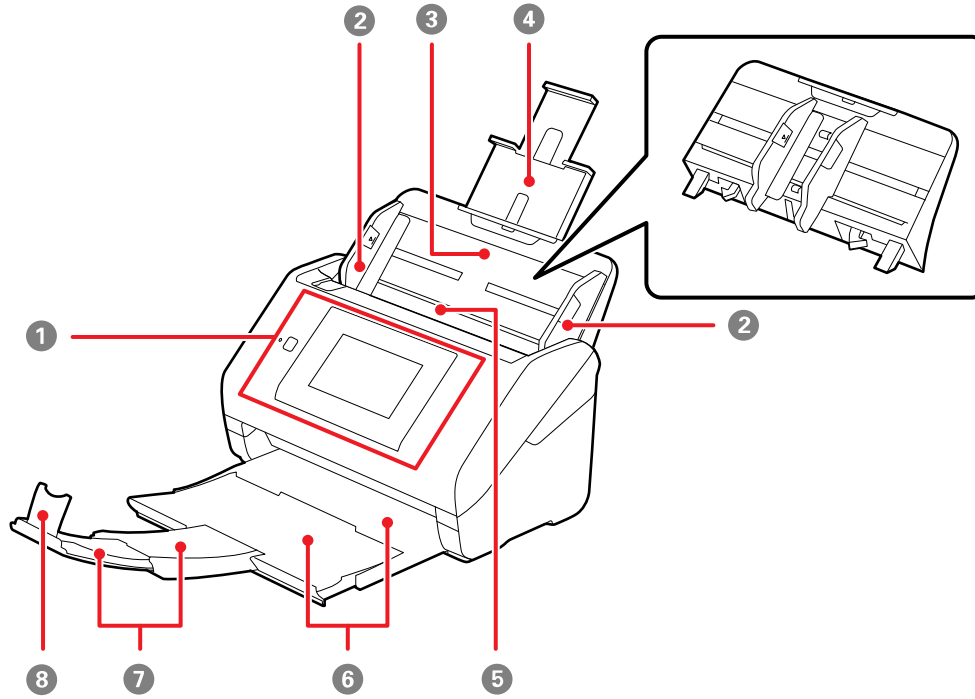

- 1 Control panel
- 2 Edge guides
- 3 Input tray
- 4 Input tray extension
- 5 ADF (Automatic Document Feeder)
- 6 Output tray
- 7 Output tray extensions
- 8 Output tray

8 Stopper

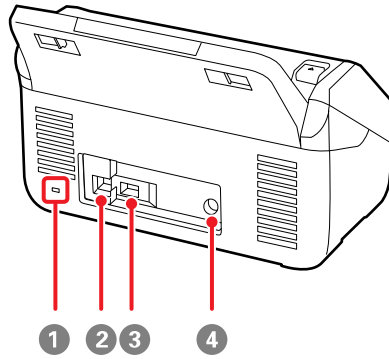

- 1 Kensington security slot
- 2 USB 3.0 port (Type B for computer)
- 3 External USB port (Type A for external USB device)
- 4 Power inlet

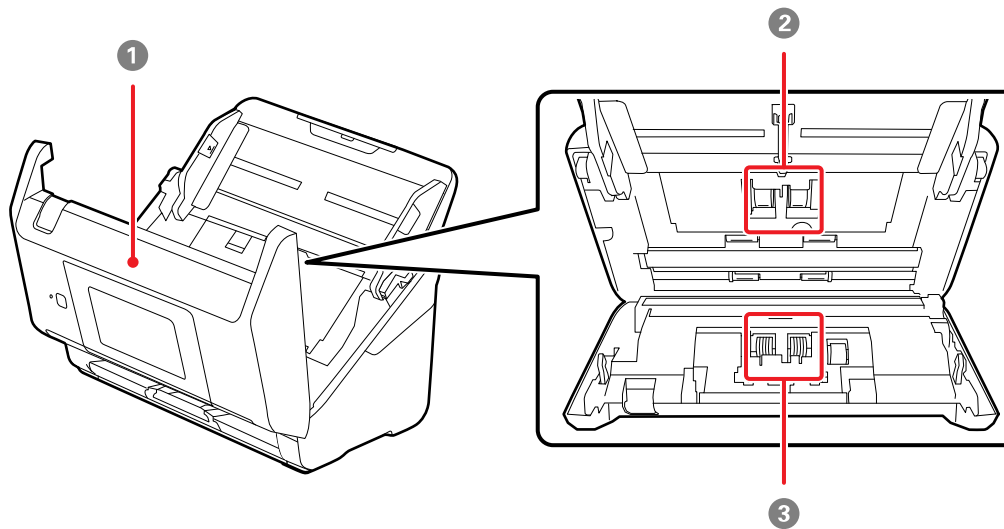

- 1 Scanner cover
- 2 Pickup rollers
- 3 Separation rollers

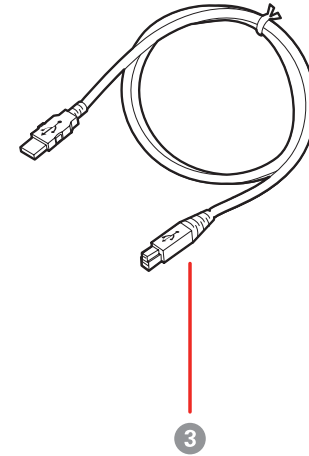
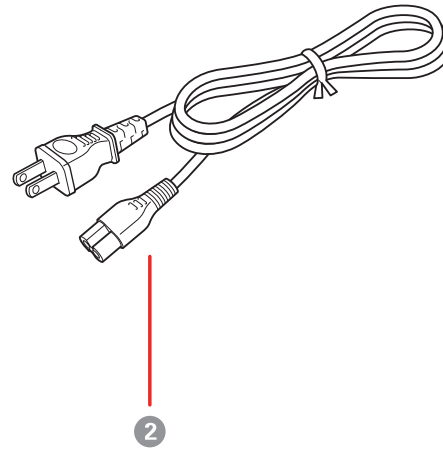
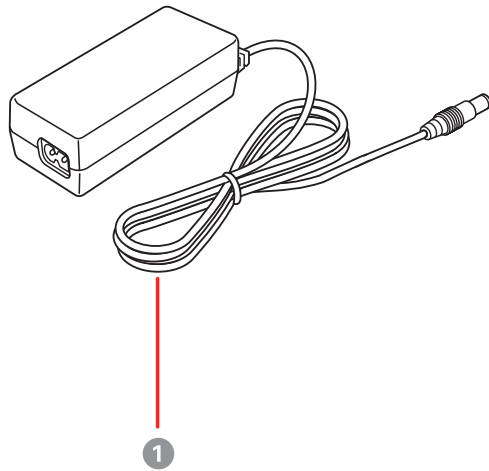

- 1 AC adapter
- 2 Power cord
- 3 USB 3.0 cable

Parent topic: [Scanner Parts Locations](#)

User Replaceable Epson Scanner Parts

U.S. and Canada: You can purchase optional accessories and replacement parts at epson.com (U.S. sales) or epson.ca (Canadian sales). You can also purchase accessories from an Epson authorized reseller. To find the nearest one, call 800-GO-EPSON (800-463-7766) in the U.S. or 800-807-7766 in Canada.

Latin America: You can purchase optional accessories and replacement parts from an Epson authorized reseller. To find the nearest reseller, go to latin.epson.com. Or you can contact your nearest sales office as described in "Where to Get Help".

Note: Availability of accessories varies by country.

Part	Part number
Carrier sheet (5)	B12B819051
Roller assembly kit	B12B819671
Cleaning kit	B12B819291

Parent topic: [Scanner Basics](#)

Using Power Saving Settings

Your scanner enters sleep mode automatically and turns off the LCD screen if it is not used for a period of time. You can make the time period shorter to save energy and resources.

[Changing the Sleep Timer Settings](#)

[Changing the Power Off Timer Settings](#)

Parent topic: [Scanner Basics](#)

Changing the Sleep Timer Settings

You can adjust the time period before your product enters sleep mode and turns off the LCD screen.

1. Select  home, if necessary.
2. Select **Settings** > **Basic Settings**.
3. Select **Sleep Timer**.
4. Select the **+** and **-** icons to increase or decrease the number of minutes.

Note: You can also press the minutes field and use the displayed numeric keypad to enter the number of minutes.

5. Select **OK** to exit.
6. Select the  return home icon to return to the home screen.

Parent topic: [Using Power Saving Settings](#)

Changing the Power Off Timer Settings

You can have the product turn off automatically if it is not used for a specified period of time.

1. Select  home, if necessary.

2. Select **Settings** > **Basic Settings**.
3. Select **Power Off Timer**.
4. Select a time period between **30minutes** and **12h** (12 hours).
5. Select the  return home icon to return to the home screen.

Parent topic: [Using Power Saving Settings](#)

Using the Epson Smart Panel Mobile App

Use this free Apple and Android app to scan with networked Epson products.

Note: For the RR-600W, receipts scanned on the mobile app must be imported into the ScanSmart Accounting Edition software on the connected PC or Mac for data extraction. See the link below.

Note: Epson Smart Panel does not support scanning with a carrier sheet or scanning for originals that are 15.5 inches (393.8 mm) or longer.

1. Connect your product to your wireless network. See the link below.
2. Visit epson.com/connect (U.S), epson.ca/connect (Canada), or latin.epson.com/connect (Caribbean) to learn more about Epson Smart Panel and check the compatibility of your mobile device.
3. Download Epson Smart Panel from the Apple App Store or Google Play.
4. Connect your mobile device to the same wireless network as your product.
5. Open Epson Smart Panel and select your Epson product, if necessary.

Now you are ready to scan with your mobile device and your Epson product.

Parent topic: [Scanner Basics](#)

Related tasks

[Setting Up Network Scanning](#)

[Starting a Scan from a Smart Device](#)

[Exporting or Importing the Invoice/Receipt Database](#)

Loading Originals

Follow the instructions here to load your originals into the scanner.

[Loading Originals in the Input Tray](#)

[Loading Plastic and Laminated Cards in the Input Tray](#)

[Loading Special Originals](#)

Loading Originals in the Input Tray

You can load originals that meet the document specifications in the input tray.

Caution: Do not load photos, or valuable original documents or artwork, directly into the input tray. This may wrinkle or damage the original. Load these originals using an optional carrier sheet.

Note: Photos scanned using a document scanner may not have the same color depth as the original. Use a flatbed photo scanner to achieve the best color reproduction of photos.

The steps below describe loading originals of the same size. To load originals of multiple sizes at once, see the link at the end of these steps.

1. Pull up the input tray extension.

2. Pull out the output tray and its extension, and open the stopper.

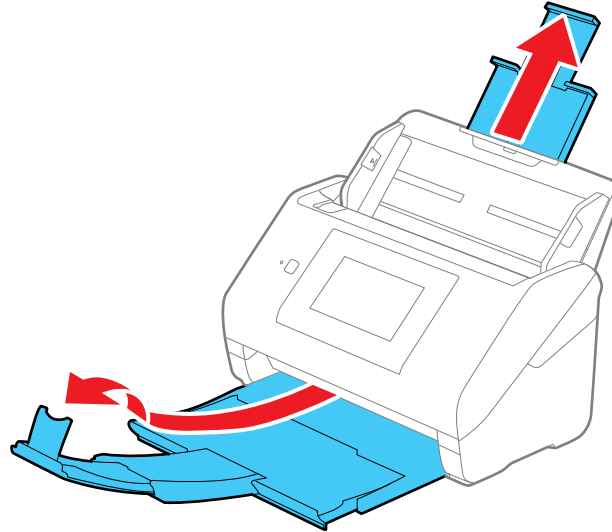

Note: If you are loading an original that is 15.5 inches (393.8 mm) or longer, do not pull out the input or output tray extensions and do not open the stopper.

3. Slide the input tray edge guides all the way out.

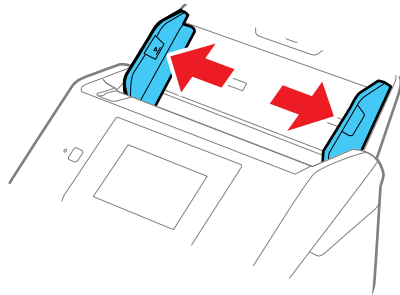

4. If you are loading a multi-page original, fan your stack of originals.

Note: If you are loading an original that is 15.5 inches (393.8 mm) or longer, load only one sheet at a time.

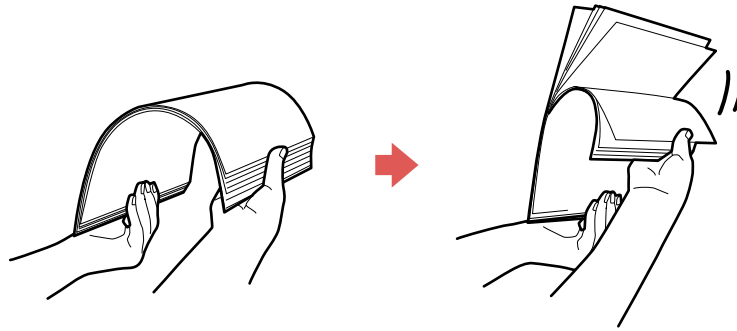

5. Stack the originals with the printed side facing down and slide the stack so the leading edge is at an angle as shown.

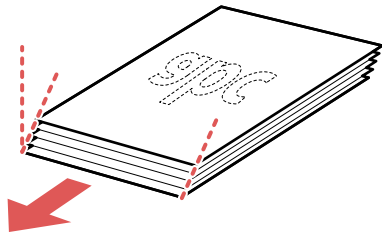

6. Load standard originals into the input tray printed side down and top edge first, and guide them in until they meet resistance.

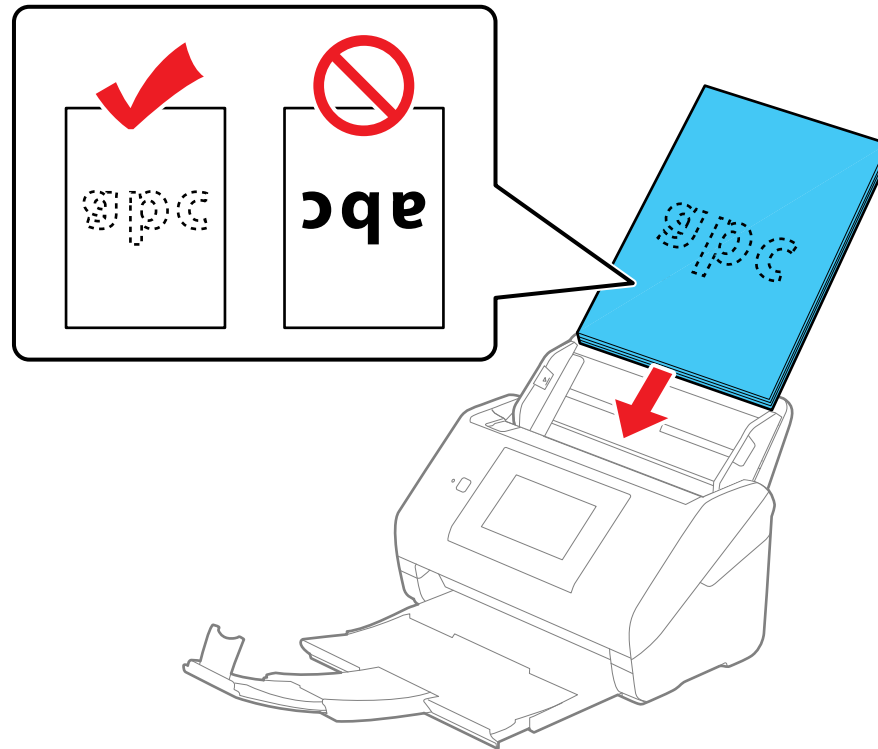

- If you are loading paper business cards, load up to 30 cards (printed side down and long edge first) into the input tray horizontally, and slide them in until they meet resistance.

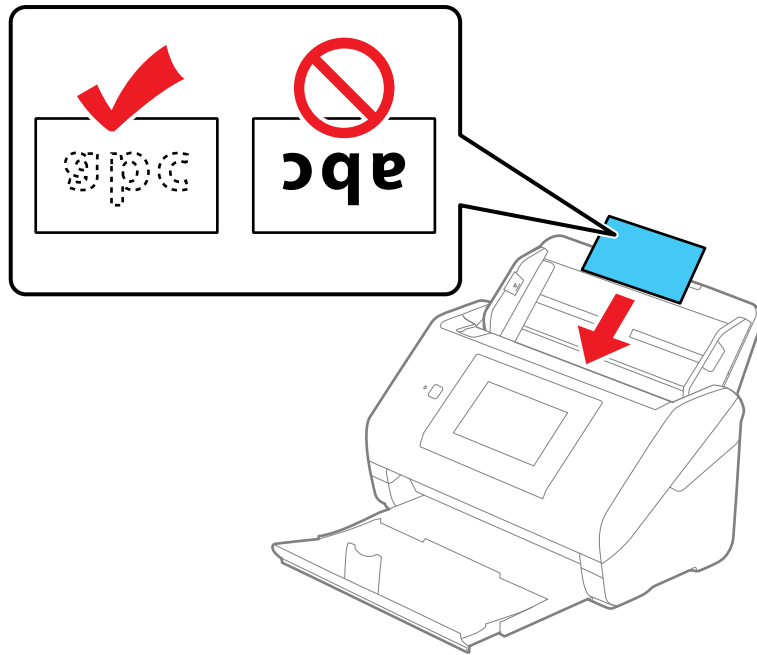

- If you are loading hole-punched originals, load them with the holes facing down or to the side as shown. The holes must be within 1.2 inches (30 mm) of the edge of the originals.

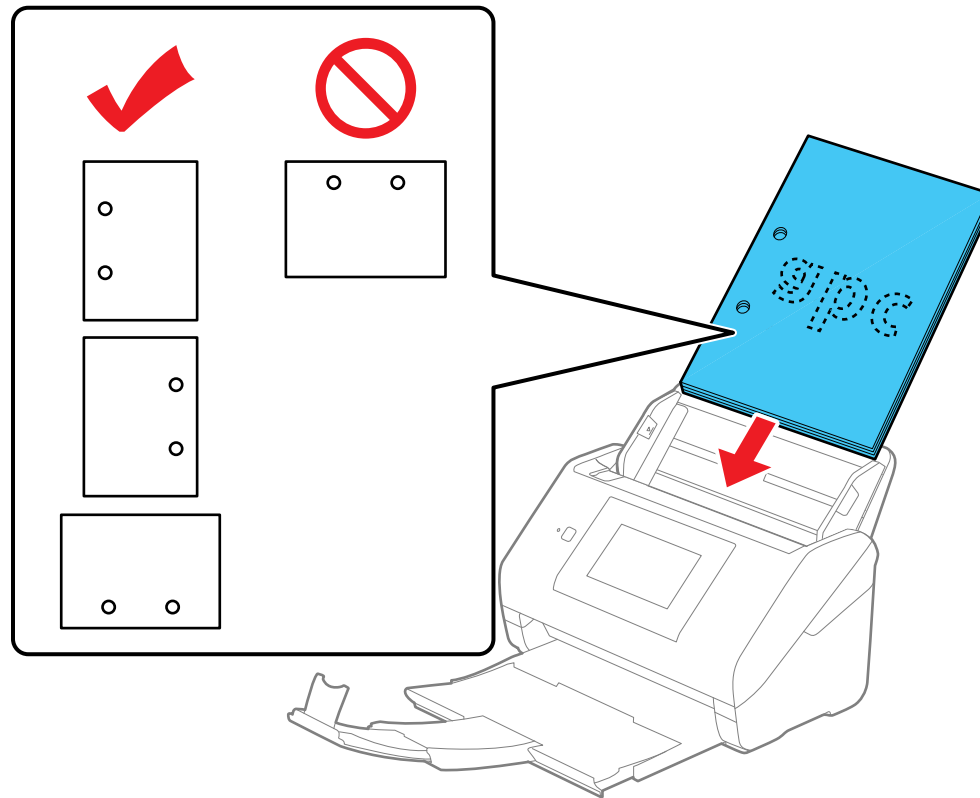

7. Slide the edge guides against the edges of the original.

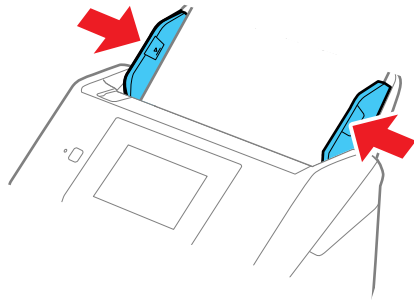

Note: If you are scanning originals that are 15.5 inches (393.8 mm) or longer, support the original as it enters into and ejects from the scanner as shown and use the following resolutions:

- 15.5 to 53 inches (393.8 to 1346.2 mm): 600 dpi or less
- 53 to 215 inches (1346.2 to 5461 mm): 300 dpi or less

- 215 to 240 inches (5461 to 6096 mm): 200 dpi or less

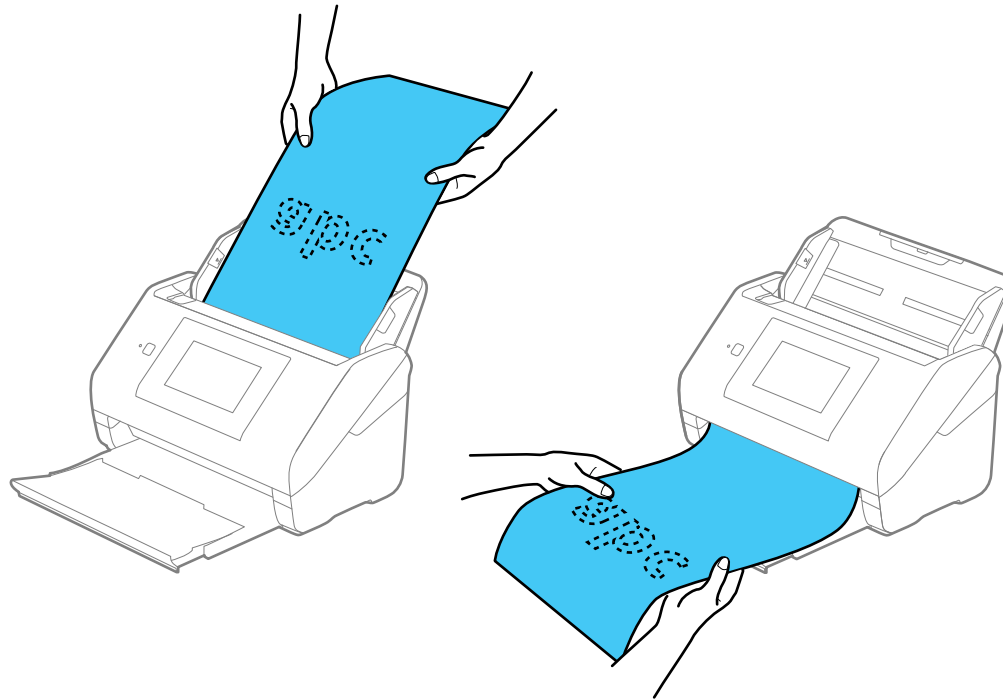

8. If necessary during scanning, adjust the position of the stopper on the output tray extension to fit the ejected originals.

Note: If thicker paper does not eject properly or falls from the output tray, push in the output tray and allow the originals to eject freely onto the surface below the scanner. If the scanned images are affected by the originals ejecting below the scanner, try placing the scanner on the edge of a table where the ejected originals can drop freely.

If scanning thin or wrinkled paper causes paper jams or double feeds, slow down the feeding speed by selecting **Settings > Scanner Settings > Slow > On** on the LCD screen.

If a paper feed error is detected, the Paper Protection feature stops the scanning process automatically to reduce damage to the original. To change the Paper Protection detection level, select **Settings > Scanner Settings > Paper Protection** on the LCD screen and select the desired level.

Note: The Paper Protection feature does not prevent all documents from being damaged. Paper feed errors may not be detected depending on the paper feeding conditions.

[Loading Multiple Sizes of Originals in the Input Tray](#)

[Original Document Specifications](#)

Parent topic: [Loading Originals](#)

Related references

[Original Document Specifications](#)

[Special Original Specifications](#)

[Plastic and Laminated Card Specifications](#)

[User Replaceable Epson Scanner Parts](#)

Related topics

[Scanning](#)

Loading Multiple Sizes of Originals in the Input Tray

You can load originals of different sizes, paper types, and thicknesses at one time in the input tray. Just make sure they meet the original document specifications.

Caution: Do not load photos, or valuable original documents or artwork, directly into the input tray. This may wrinkle or damage the original. Load these originals using an optional carrier sheet.

Note: Photos scanned using a document scanner may not have the same color depth as the original. Use a flatbed photo scanner to achieve the best color reproduction of photos.

1. Pull up the input tray extension.

2. Pull out the output tray and its extension, and open the stopper.

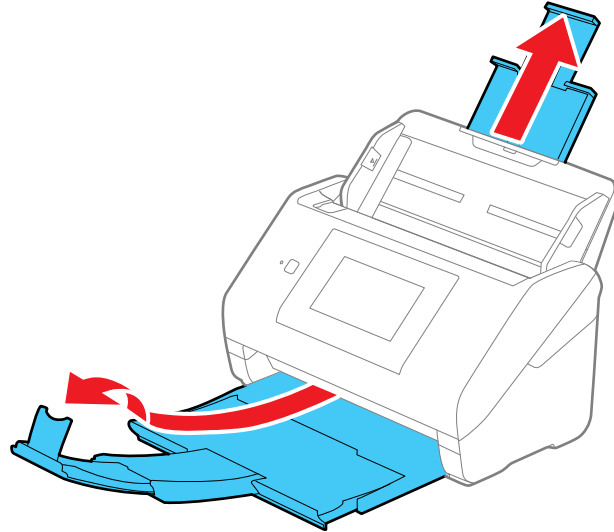

Note: If you are loading originals that are 15.5 inches (393.8 mm) or longer, do not pull out the input or output tray extensions and do not open the stopper.

3. Slide the input tray edge guides all the way out.

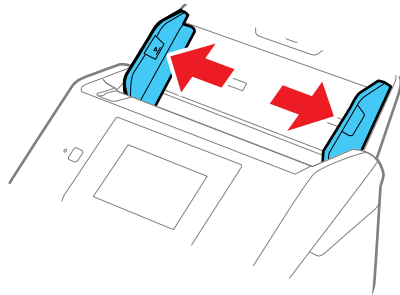

4. Load the originals in the center of the input tray in descending order of paper size with the widest at the back and the narrowest at the front. Slide them in until they meet resistance. Make sure the printed sides are facedown and the top edges are slightly angled in the input tray.

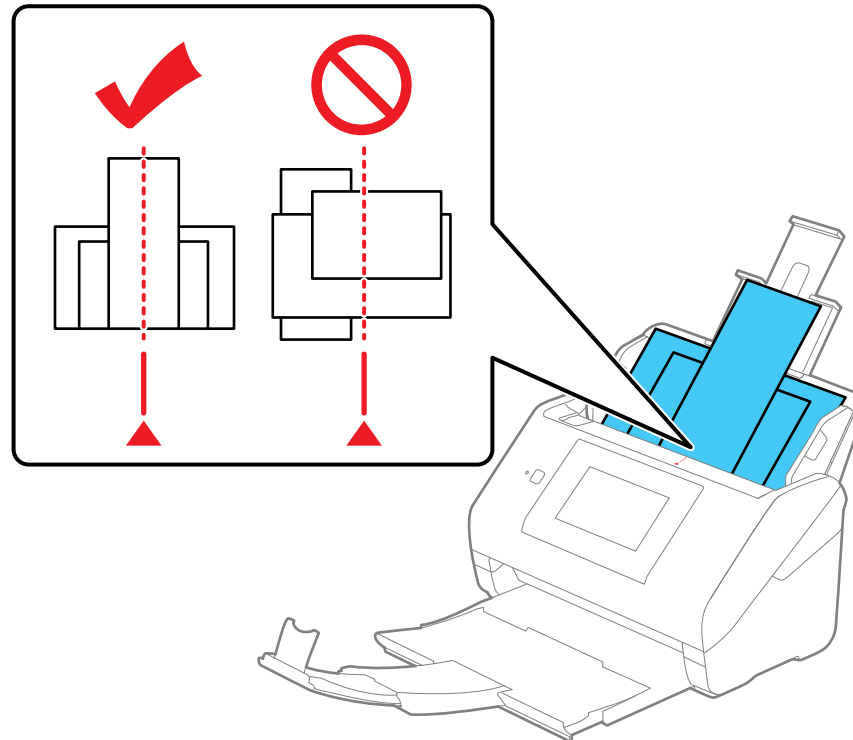

5. Slide the edge guides against the edges of the widest original.
6. If necessary during scanning, adjust the position of the stopper on the output tray extension to fit the ejected originals.

Note: If thicker paper does not eject properly or falls from the output tray, push in the output tray and allow the originals to eject freely onto the surface below the scanner. If the scanned images are affected by the originals ejecting below the scanner, try placing the scanner on the edge of a table where the ejected originals can drop freely.

If scanning thin or wrinkled paper causes paper jams or double feeds, slow down the feeding speed by selecting **Settings** > **Scanner Settings** > **Slow** > **On** on the LCD screen.

If a paper feed error is detected, the Paper Protection feature stops the scanning process automatically to reduce damage to the original. To change the Paper Protection detection level, select **Settings** > **Scanner Settings** > **Paper Protection** on the LCD screen and select the desired level.

Note: The Paper Protection feature does not prevent all documents from being damaged. Paper feed errors may not be detected depending on the paper feeding conditions.

You can also scan originals of multiple sizes by loading them one by one using the **Automatic Feeding Mode** setting in Epson Scan 2.

Parent topic: [Loading Originals in the Input Tray](#)

Related topics

[Scanning](#)

Original Document Specifications

You can load original documents that meet these specifications in your scanner.

Paper type	Paper size	Paper weight	Loading capacity
Plain paper Fine paper Recycled paper	Letter (8.5 × 11 inches [216 × 279 mm])	7 to 110 lb (27 to 413 g/m ²)	21 lb (80 g/m ²): 100 sheets
	A4 (8.3 × 11.7 inches [210 × 297 mm])		24 lb (90 g/m ²): 86 sheets
	A5 (5.8 × 8.2 inches [148 × 210 mm])		28 lb (104 g/m ²): 74 sheets
	A6 (4.1 × 5.8 inches [105 × 148 mm])		34 lb (127 g/m ²): 62 sheets
	B5 (7.2 × 10.1 inches [182 × 257 mm])		42 lb (157 g/m ²): 50 sheets
	B6 (5 × 7.2 inches [128 × 182 mm])		56 lb (209 g/m ²): 38 sheets
	A8 (2.1 × 2.9 inches [52 × 74 mm])		68 lb (256 g/m ²): 30 sheets
		34 to 110 lb (127 to 413 g/m ²)	110 lb (413 g/m ²): 18 sheets Loading capacity may vary depending on the paper type.
	Width: 2.0 to 8.5 inches (50.8 to 215.9 mm) Height: 15.5 to 240 inches (393.8 to 6096 mm)	13 to 35 lb (50 to 130 g/m ²)	1 sheet

Paper type	Paper size	Paper weight	Loading capacity
Plain paper Fine paper Recycled paper	Legal (8.5 × 14 inches [216 × 356 mm])	7 to 110 lb (27 to 413 g/m ²)	21 lb (80 g/m ²): 80 sheets 24 lb (90 g/m ²): 69 sheets 28 lb (104 g/m ²): 59 sheets 34 lb (127 g/m ²): 50 sheets 42 lb (157 g/m ²): 40 sheets 56 lb (209 g/m ²): 30 sheets 68 lb (256 g/m ²): 24 sheets 110 lb (413 g/m ²): 14 sheets Loading capacity may vary depending on the paper type.
Paper business cards	Business cards	Up to 56 lb (210 g/m ²)	30 cards loaded horizontally

Note: You can load originals of different sizes, paper types, and thicknesses up to this size: Letter (8.5 × 11 inches [216 × 279 mm]).

The following types of originals may not be successfully scanned or may require special attention:

- Originals with uneven surfaces, such as embossed documents or letterhead
- Originals with wrinkles or fold lines
- Perforated originals
- Originals with labels or stickers
- Carbonless paper
- Curled originals
- Coated paper

Note: Lightly wrinkled paper may scan better if you slow down the feeding speed during scanning or smooth out the wrinkles before loading. Use a carrier sheet to scan delicate originals or originals that are easily wrinkled. To scan originals that are incorrectly detected as double feeds, select **Settings > Scanner Settings > DFDS Function** on the LCD screen and set it to **On** to disable the **Detect Double Feed** setting for the next scan, or set the **Detect Double Feed** setting to **Off** on the Main Settings tab in the Epson Scan 2 window.

Caution: Do not load the following types of originals directly in the scanner, or they may be damaged or may damage the scanner:

- Photos
- Originals that are bound
- Passports
- Thermal paper
- Fabric or other non-paper originals
- Originals containing staples or paper clips
- Originals with wet ink or glue
- Ripped originals
- Heavily wrinkled or curled originals
- Originals with holes on the bottom of them
- Transparencies
- Originals with carbon paper backing
- Originals with sticky notes attached
- Glossy originals

Note: Photos scanned using a document scanner may not have the same color depth as the original. Use a flatbed photo scanner to achieve the best color reproduction of photos.

Parent topic: [Loading Originals in the Input Tray](#)

Loading Plastic and Laminated Cards in the Input Tray

You can load plastic and laminated cards that meet the card specifications in the input tray.

1. Pull out the output tray and open the stopper. Do not pull out the extensions.

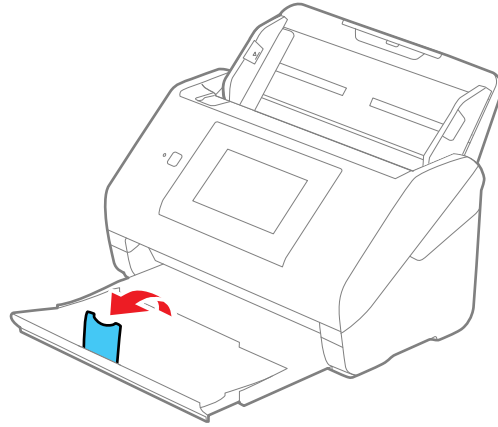

2. Slide the input tray edge guides all the way out.

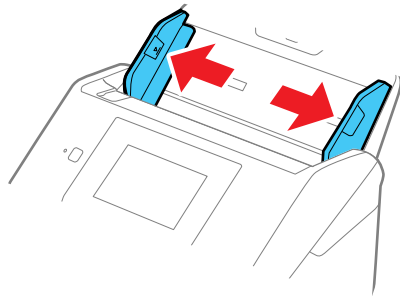

3. Load plastic or laminated cards (printed side down and long edge first) into the input tray horizontally, and slide them in until they meet resistance.

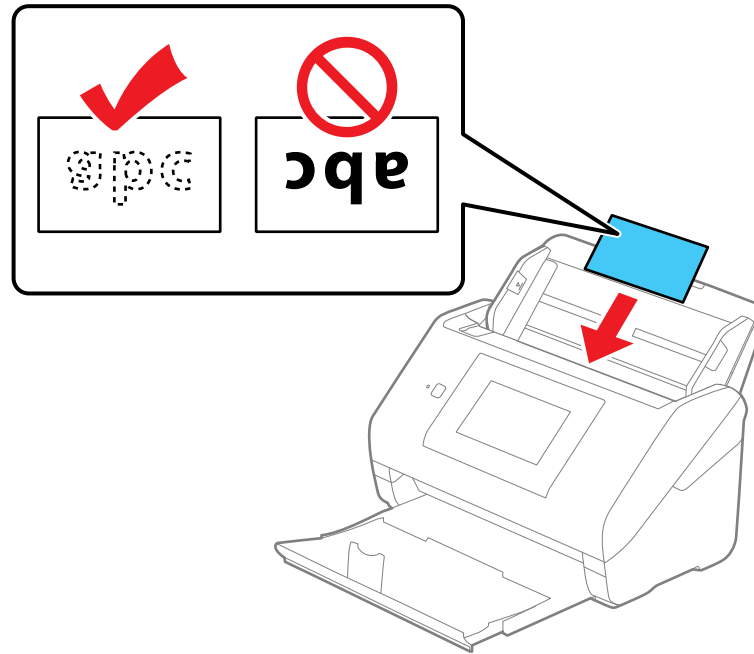

Note: Do not load plastic cards vertically.

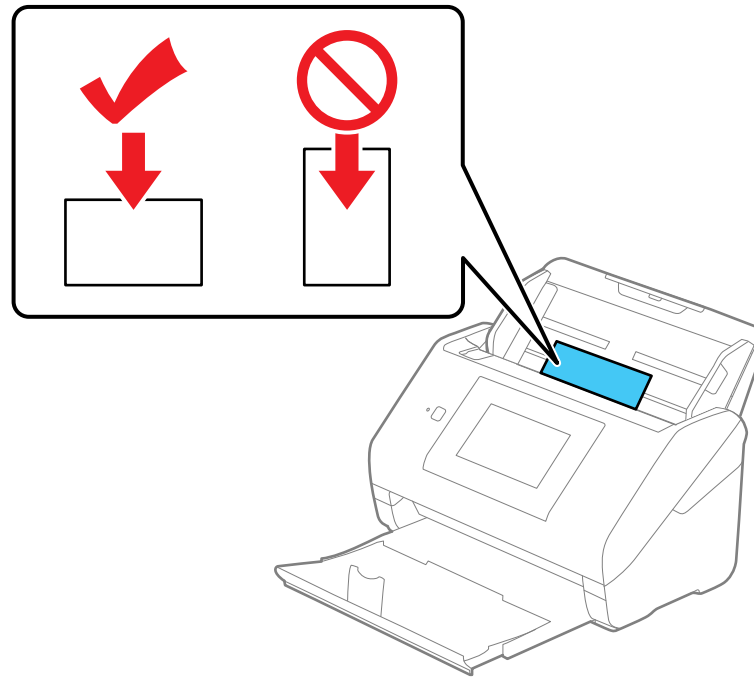

4. Slide the edge guides against the edges of the card.

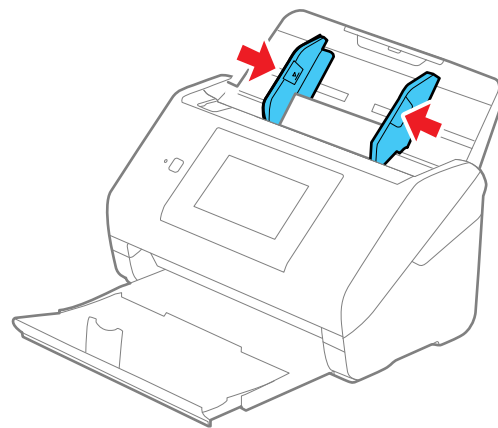

- Turn off the **Detect Double Feed** setting on the Main Settings tab in Epson Scan 2 when scanning the cards.

Note: If you do not disable the **Detect Double Feed** setting and a double feed error occurs, remove the plastic or laminated card from the input tray and reload it. Select **Settings > Scanner Settings > DFDS Function** on the LCD screen and set it to **On** to disable the **Detect Double Feed** setting for the next scan. The DFDS Function setting only disables the **Detect Double Feed** setting for one scan.

[Plastic and Laminated Card Specifications](#)

Parent topic: [Loading Originals](#)

Related references

[Plastic and Laminated Card Specifications](#)

Related topics

[Scanning](#)

Plastic and Laminated Card Specifications

You can load original plastic and laminated cards that meet these specifications in your scanner.

Paper type	Paper size	Paper thickness	Loading capacity
Plastic cards, embossed (ISO7810 ID-1 compliant)	2.1 × 3.3 inches (54 × 85.6 mm)	0.05 inch (1.24 mm) maximum	1 card (horizontal)
Plastic cards, standard (ISO7810 ID-1 compliant)		0.04 inch (1.1 mm) maximum	5 cards (horizontal)
Laminated cards	4.7 × 5.9 inches (120 × 150 mm) or smaller	0.03 inch (0.8 mm) maximum	1 card

Note: Plastic cards with glossy surfaces may not scan properly.

Parent topic: [Loading Plastic and Laminated Cards in the Input Tray](#)

Loading Special Originals

You can load photos or large, thick, or folded originals in the input tray using one or more carrier sheets. You can also load envelopes. Make sure the originals meet the specifications for special originals before loading them.

1. Pull up the input tray extension.
2. Pull out the output tray and its extension, and open the stopper.

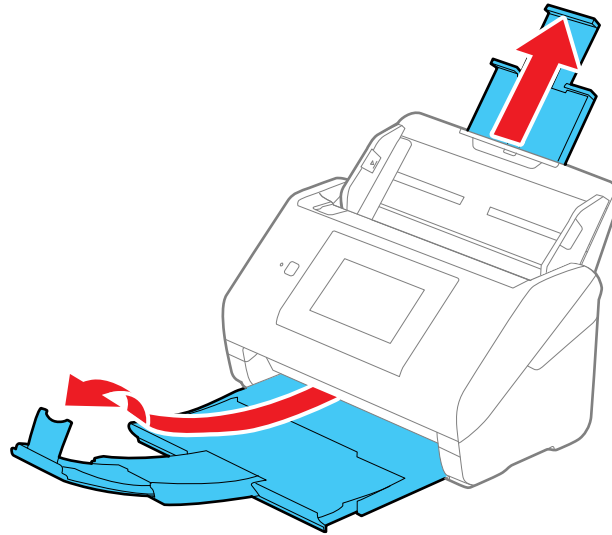

Note: If you are loading originals that are 15.5 inches (393.8 mm) or longer, do not pull out the input or output tray extensions and do not open the stopper.

3. Slide the input tray edge guides all the way out.

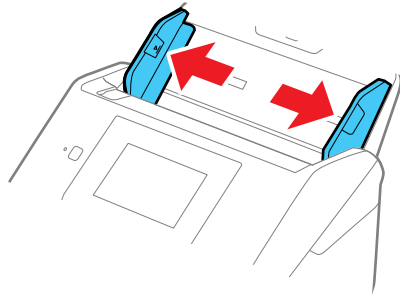

4. Load envelopes vertically in the input tray with the printed side down and the flap facing as shown. Slide in the envelopes until they meet resistance. Skip to step 7.

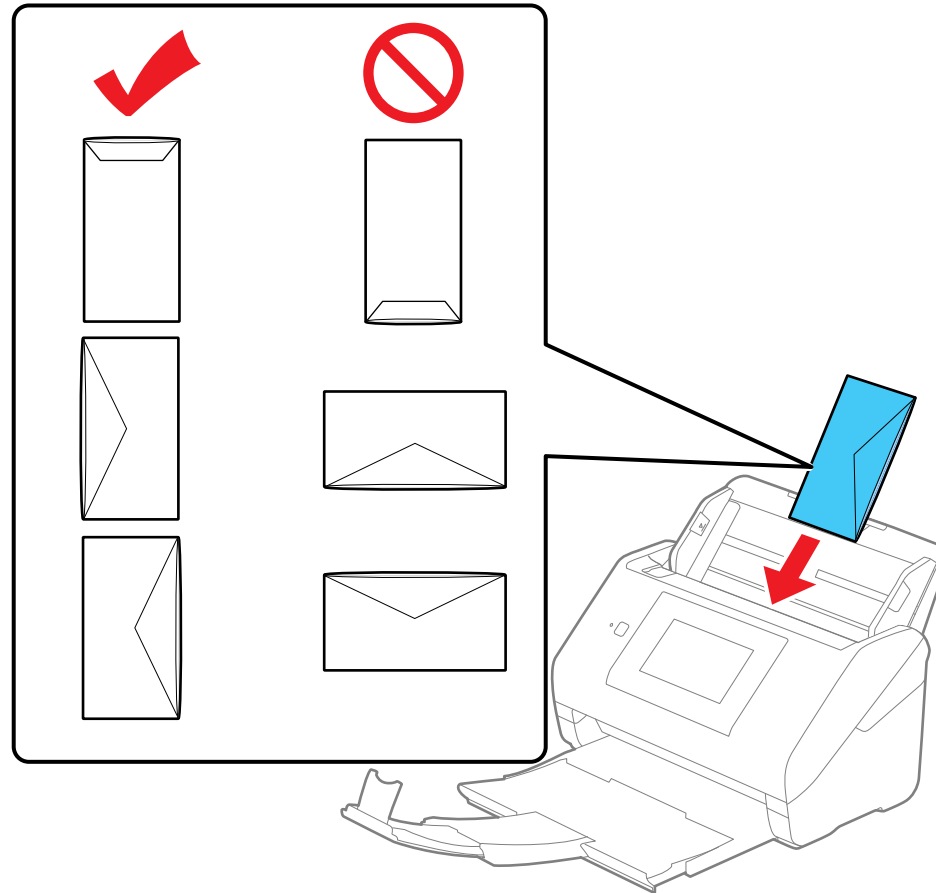

5. Do one of the following to load photos, or folded or irregularly shaped originals using a carrier sheet:

Note: Use only the carrier sheet designed for your scanner. The carrier sheet is automatically recognized by the scanner by the two small rectangular holes on the front edge, as shown. Keep the

holes clean and not covered. Do not load a carrier sheet that has scratches on it or one that has been scanned more than 3,000 times.

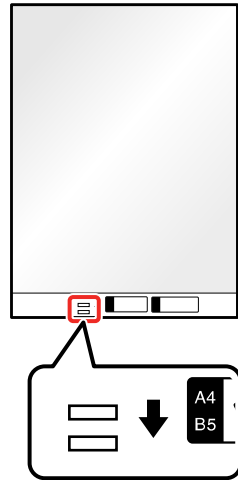

- For a Letter- or A4-size or larger original, fold it as shown and place it in the center of an optional carrier sheet. Make sure the illustration on the front edge of the carrier sheet is facing up.

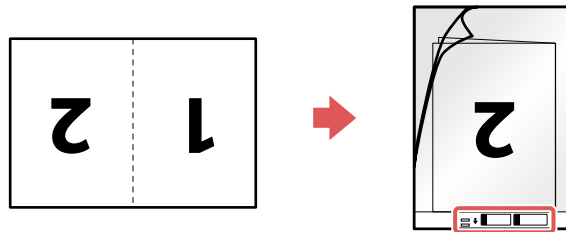

To scan both sides and stitch them together, set the appropriate setting in Epson Scan 2.

- For a photo or an irregularly shaped original, load it in the center of an optional carrier sheet with the printed side face down. Make sure the illustration on the front edge of the carrier sheet is facing up. If you are loading originals that are 11.7 inches (297 mm) or shorter, place the leading

edge of the original against the binding of the carrier sheet, as shown. Otherwise, the scanner may not detect the correct length of the original.

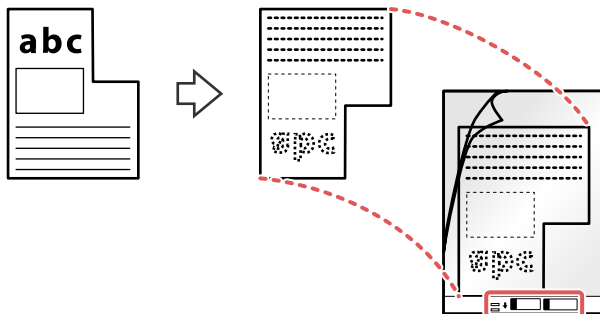

Note: Photos scanned using a document scanner may not have the same color depth as the original. Use a flatbed photo scanner to achieve the best color reproduction of photos.

6. Load the carrier sheet in the input tray as shown until it meets resistance.

Folded original

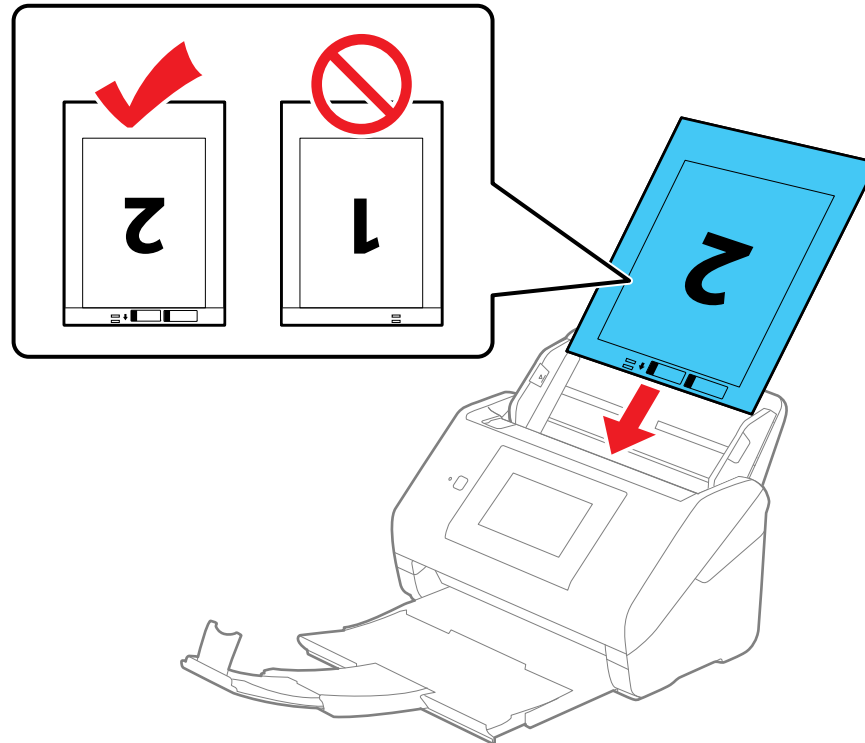
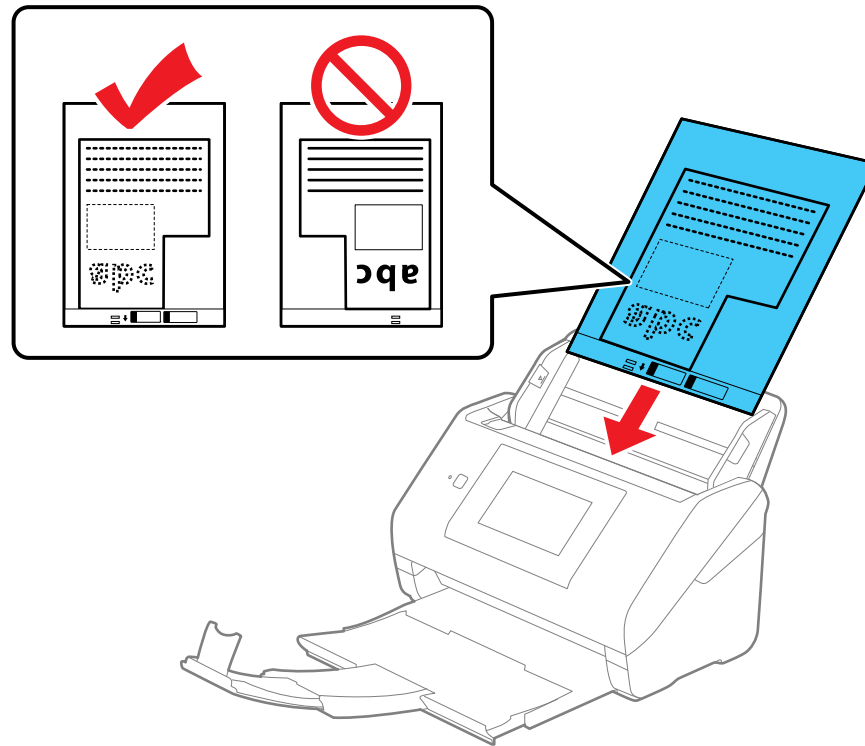
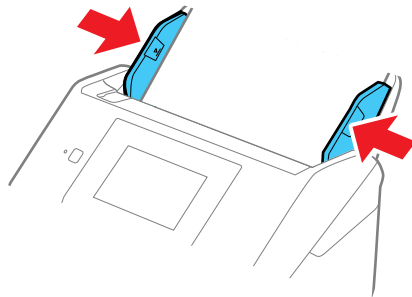

Photo or irregularly shaped original



7. Slide the edge guides against the edges of the envelope or carrier sheet.



8. Turn off the **Detect Double Feed** setting on the Main Settings tab in Epson Scan 2 when scanning special originals.

Note: If the **Document Size** setting on the Main Settings tab in Epson Scan 2 is set to **Auto Detect**, **Paper Skew** is automatically selected as the **Correct Document Skew** setting.

9. If necessary during scanning, adjust the position of the stopper on the output tray extension to fit the ejected originals.

Note: If thicker paper does not eject properly or falls from the output tray, push in the output tray and allow the originals to eject freely onto the surface below the scanner. If the scanned images are affected by the originals ejecting below the scanner, try placing the scanner on the edge of a table where the ejected originals can drop freely.

[Special Original Specifications](#)

Parent topic: [Loading Originals](#)

Related references

[Special Original Specifications](#)

[User Replaceable Epson Scanner Parts](#)

Related topics

[Scanning](#)

Special Original Specifications

You can load photos, envelopes, or large, thick, or folded originals that meet these specifications in your scanner.

Note: Photos scanned using a document scanner may not have the same color depth as the original. Use a flatbed photo scanner to achieve the best color reproduction of photos.

Paper type	Paper size	Paper thickness	Loading capacity
Large originals (plain paper, fine paper, or recycled paper) (load only in a carrier sheet)	Up to this size: A3 (11.7 × 16.5 inches [297 × 420 mm]) B4 (13.9 × 9.84 inches [353 × 250 mm]) Legal (8.5 × 14 inches [216 × 356 mm]); only load above sizes if folded in half Custom sizes up to 17 inches (431.8 mm) wide and 11.7 inches (297 mm) long; originals wider than 8.5 inches (215.9 mm) must be folded in half	0.012 inch (0.3 mm) maximum (excluding the thickness of the carrier sheet)	10 carrier sheets
Photos (load only in a carrier sheet)	Up to this size: A4 (8.3 × 11.7 inches [210 × 297 mm])	0.012 inch (0.3 mm) maximum (excluding the thickness of the carrier sheet)	10 carrier sheets
Envelopes	4.49 × 6.38 inches (114 × 162 mm) 4.33 × 8.66 inches (110 × 220 mm)	0.015 inch (0.38 mm) maximum	10 envelopes
Irregularly shaped originals (load only in a carrier sheet)	Up to this size: A4 (8.3 × 11.7 inches [210 × 297 mm])	0.012 inch (0.3 mm) maximum (excluding the thickness of the carrier sheet)	10 carrier sheets

Parent topic: [Loading Special Originals](#)

Wi-Fi Networking

See these sections to use your scanner over a Wi-Fi network.

[Network Security Recommendations](#)

[Connecting to an Existing Wi-Fi Network](#)

[Direct Wi-Fi Mode \(AP Mode\) Setup](#)

[Wi-Fi Protected Setup \(WPS\)](#)

[Setting Up Network Scanning](#)

[Disabling Wi-Fi Features](#)

Network Security Recommendations

To help deter unauthorized access to your product over a network, you should protect your network environment using appropriate security measures.

Security measures such as these can help deter threats such as loss of user data, use of telephone and fax lines, and other intrusions:

- **Connect your product only to a network protected by a firewall**

Connecting your product directly to the Internet may leave it vulnerable to security threats. Instead, connect it to a router or other network connection protected by a firewall. Your router may already have a firewall set up by your Internet service provider; check with your ISP for confirmation. For best results, set up and use a private IP address for your network connection.

- **Change the default administrator password on your product**

If your product has an option to set an administrator password, change the default administrator password to deter access by unauthorized users to personal data stored on your product, such as IDs, passwords, and contact lists.

Parent topic: [Wi-Fi Networking](#)

Connecting to an Existing Wi-Fi Network

You can set up your scanner to communicate with your computer using a wireless router. The wireless router can be connected to your computer over a wireless or wired network.

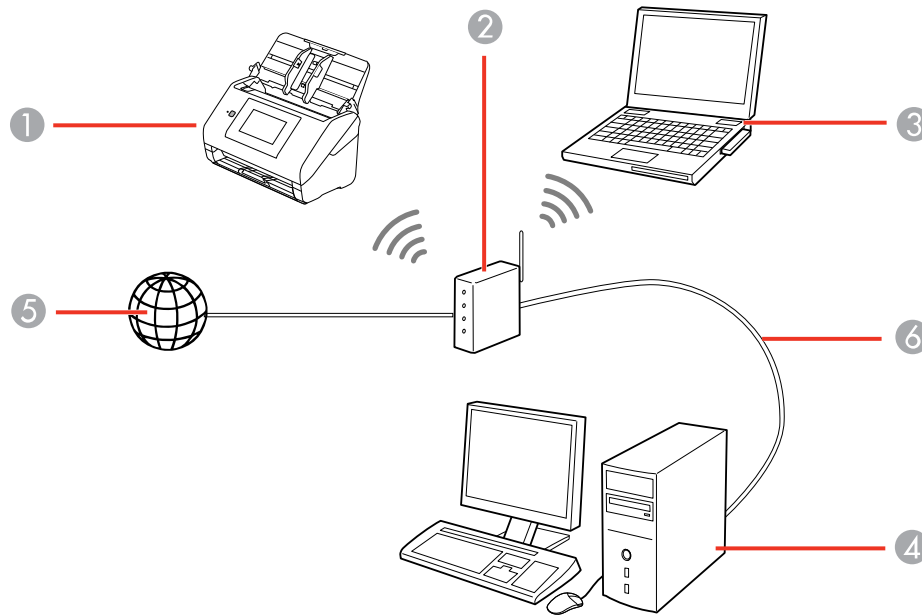

- 1 Epson scanner
- 2 Wireless router
- 3 Computer with a wireless interface
- 4 Computer
- 5 Internet
- 6 Ethernet cable (used only for wired connection to the wireless router)



[Selecting Wireless Network Settings from the Control Panel](#)

Parent topic: [Wi-Fi Networking](#)

Selecting Wireless Network Settings from the Control Panel

You can select or change wireless network settings using your product control panel.

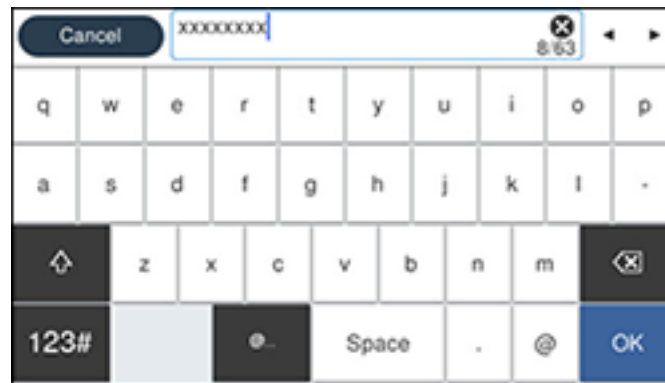

To install your product on a wireless network, follow the instructions on the *Start Here* sheet and install the necessary software by downloading it from the Epson website. The installer program guides you through network setup.

1. Select  home, if necessary.
2. Press the  icon.
3. Select **Router**.
4. Select **Start Setup** or **Change Settings**.
5. Select **Wi-Fi Setup Wizard**.
6. Select the name of your wireless network or select **Enter Manually** to enter the name manually. Use the displayed keypad to enter your network name.
7. Select the **Password** field and enter your wireless password using the displayed keypad.



Note: The network name and password are case sensitive. Be sure to correctly enter uppercase and lowercase letters, and numeric or special characters.

- To move the cursor, press the left or right arrows.
- To change the case of letters, press .

- To delete the previous character, press .
 - To enter numbers and symbols, press **123#**.
 - To enter a space, press **Space**.
8. Select **OK** when you finish entering your password.
 9. Confirm the displayed network settings and select **Start Setup** to save them.
 10. Select the  return home icon to return to the home screen.

You see the  icon on the LCD screen and should be able to connect to your product directly from your computer or device, and then scan. If you are scanning from a computer, make sure you installed the network software.

Note: If you don't see the  icon, you may have selected the wrong network name or entered the password incorrectly. Repeat these steps to try again.

Parent topic: [Connecting to an Existing Wi-Fi Network](#)

Related tasks

[Setting Up Network Scanning](#)

Related topics

[Using the Control Panel](#)

Direct Wi-Fi Mode (AP Mode) Setup

You can set up your scanner to communicate directly with your computer or another device without requiring a wireless router. If your product is not already connected to a wireless network, it enters access point mode and the scanner itself acts as the network access point for up to 4 devices.

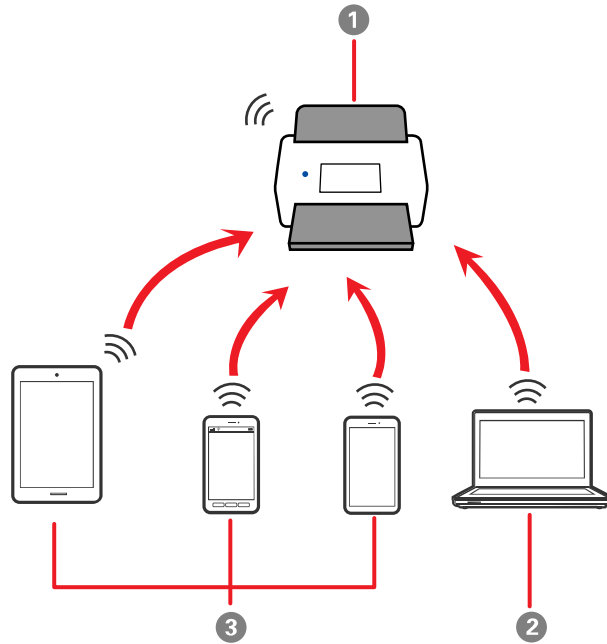

- 1 Epson scanner
- 2 Computer with a wireless interface
- 3 Other wireless devices

Note: Devices directly connected to the scanner cannot communicate with each other through the scanner.

[Connecting to a Mobile Device](#)

[Setting Up Wireless Scanning from a Smart Device Using Epson Smart Panel](#)

Parent topic: [Wi-Fi Networking](#)



Related tasks

[Selecting Wireless Network Settings from the Control Panel](#)

Connecting to a Mobile Device

You can connect a mobile device directly to the printer without a wireless router or access point.

Note: Make sure the Epson Smart Panel app is installed on your mobile device before connecting to the printer.

1. Select  home, if necessary.
2. Press the  icon.
3. Select **Wi-Fi Direct**.
4. Select **Start Setup**.
5. Select your scanner in the Epson Smart Panel app to complete Wi-Fi Direct setup.
6. Select **Complete**.
7. Select the  return home icon to return to the home screen.

Parent topic: [Direct Wi-Fi Mode \(AP Mode\) Setup](#)

Setting Up Wireless Scanning from a Smart Device Using Epson Smart Panel

You can use the Epson Smart Panel app to connect your Epson product to a wireless network or connect your smart device directly to the product. Epson Smart Panel is available on iOS and Android devices.

Make sure you have the following:

- A device that is connected to a wireless network
 - The Epson Smart Panel app installed on the device
 - The wireless network name (SSID) and password
1. Make sure the product is turned on and is ready to scan.

Note: You must perform initial setup before setting up wireless scanning.

2. Open the Epson Smart Panel app on your device.

3. Do one of the following:
 - If the app automatically recognizes the product, follow the on-screen instructions to set up the wireless connection.
 - If the app does not automatically recognize the product, select the **+** icon and continue with the next step.
4. On the next screen, select **Connect to a New Product**.
5. Select your product from the list.

Note: If your product is not listed, move closer to the product and try again. If the product is still not shown, connect your scanner to the wireless network again and then select **Connect to Existing Product** in the Epson Smart Panel app and follow the on-screen instructions. See the link below for wireless setup instructions.

6. Select **Next** to select the current wireless network.

Note: If you want to connect the product to a different wireless network, select **Change another Wi-Fi SSID**.

7. Enter the password for the wireless network and select **OK**.

The app starts configuring the product.

Your product is now connected to a wireless network and set up for use with the Epson Smart Panel app.

Parent topic: [Direct Wi-Fi Mode \(AP Mode\) Setup](#)

Related tasks

[Using the Epson Smart Panel Mobile App](#)

[Starting a Scan from a Smart Device](#)

Wi-Fi Protected Setup (WPS)

If your network uses a WPS-enabled wireless router, you can quickly connect your scanner to the network using Wi-Fi Protected Setup (WPS).

Note: To check if your router is WPS-enabled, look for a button labeled **WPS** on your router. If there is no hardware button, there may be a WPS setting in the software for the device. Check your network product documentation for details.



[Using WPS to Connect to a Network](#)

[Using WPS PIN Mode to Connect to a Network](#)

Parent topic: [Wi-Fi Networking](#)

Using WPS to Connect to a Network

If you have a WPS-enabled wireless router, you can use Wi-Fi Protected Setup (WPS) to connect your scanner to the network.

1. Select  home, if necessary.
2. Press the  icon.
3. Select **Router**.
4. Select **Start Setup** or **Change Settings**.
5. Select **Push Button Setup (WPS)**.
6. Follow the instructions on the LCD screen to complete WPS setup.

Note: Make sure you press **Start Setup** within two minutes of activating WPS on your router.

7. Select the  return home icon to return to the home screen.

The  Wi-Fi icon displayed on the LCD screen indicates your wireless connection status. If the product is not connected to the network, repeat these steps to try again.



Parent topic: [Wi-Fi Protected Setup \(WPS\)](#)

Related tasks

[Setting Up Network Scanning](#)

Using WPS PIN Mode to Connect to a Network

If you have a WPS-enabled wireless router that supports PIN mode, you can use Wi-Fi Protected Setup (WPS) PIN mode to connect your scanner to the network.

1. Select  home, if necessary.
2. Press the  icon.
3. Select **Router**.
4. Select **Start Setup** or **Change Settings**.
5. Select **Others**.

6. Select **PIN Code Setup(WPS)**.
7. Follow the instructions on the LCD screen to complete WPS setup.

Note: Make sure you press **Start Setup** within two minutes of activating WPS on your router.

8. Select the  return home icon to return to the home screen.

The  Wi-Fi icon displayed on the LCD screen indicates your wireless connection status. If the product is not connected to the network, repeat these steps to try again.

Parent topic: [Wi-Fi Protected Setup \(WPS\)](#)

Related tasks



[Setting Up Network Scanning](#)

Setting Up Network Scanning

You can set up network scanning to your scanner through a direct connection to your scanner.

First, manually configure your scanner to connect to your network. Then follow the instructions here to set up your computer for network scanning using the Epson Scan 2 Utility. Your scanner must be turned on and connected to the network.

Note: Make a note of the IP address or host name of the scanner so you can enter it in these steps.

1. Do one of the following to start the Epson Scan 2 Utility:
 - **Windows 10:** Click  > **EPSON** > **Epson Scan 2 Utility**.
 - **Windows 8.x:** Navigate to the **Apps** screen and select **Epson Scan 2 Utility**.
 - **Windows 7:** Click  > **All Programs** > **EPSON** > **Epson Scan 2** > **Epson Scan 2 Utility**.
 - **Mac:** Open the **Applications** folder, click **Epson Software**, and click **Epson Scan 2 Utility**.
2. Select **Settings** from the Scanner drop-down list.

You see a screen like this:

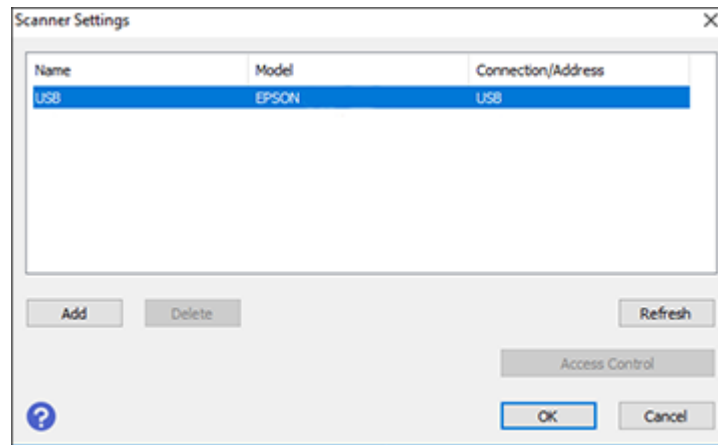

Note: If you see an **Enable Editing** button (Windows) or the lock icon (Mac), click it so that you can modify the scanner settings.

3. Select your scanner and click **Add**.

You see a screen like this:

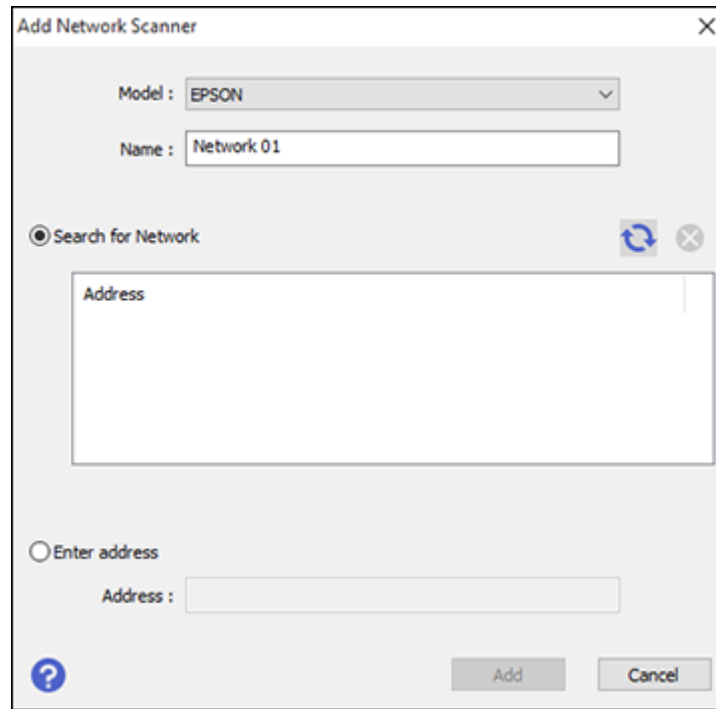

4. Do one of the following:
 - Under **Search for Network**, select the IP address of your Epson scanner and click **Add**.
 - Select the **Enter address** setting, type in the IP address or host name of your Epson scanner, and click **Add**.
5. Click **OK** to check the connection.
You see a confirmation message.
6. Click **OK** to save your settings and close the Epson Scan 2 Utility.

[Determining the Scanner's IP Address](#)

Parent topic: [Wi-Fi Networking](#)



Related tasks

[Selecting Wireless Network Settings from the Control Panel](#)

Determining the Scanner's IP Address

Determining the Scanner's IP Address



If you have multiple scanners on your network, you need to know the IP address of the scanner when setting up network scanning.

1. Do one of the following to start EpsonNet Config:
 - **Windows 10:** Click  > **EpsonNet > EpsonNet Config.**
 - **Windows 8.x:** Navigate to the **Apps** screen and select **EpsonNet Config.**
 - **Windows 7:** Click , and select **All Programs**. Select **EpsonNet > EpsonNet Config > EpsonNet Config.**
 - **Mac:** Open the **Applications** folder and select **Epson Software > EpsonNet > EpsonNet Config > EpsonNet Config.**
2. Locate your scanner in the list and write down the IP address.

Parent topic: [Setting Up Network Scanning](#)

Disabling Wi-Fi Features

You may need to disable your product's Wi-Fi features if you change your network connection type or need to solve a problem with your network connection.

1. Select  home, if necessary.
2. Press the  icon.
3. Select **Router**.
4. Select **Change Settings**.
5. Select **Others**.
6. Select **Disable Wi-Fi**.
7. Select **Start Setup** to disable Wi-Fi.
8. When finished, select the  return home icon to return to the home screen.

Parent topic: [Wi-Fi Networking](#)

Scanning

You can scan your originals and save them as digital files.

[Starting a Scan](#)

[Starting a Scan from a Smart Device](#)

[Scanning a Document in Epson ScanSmart](#)

[Selecting Epson ScanSmart Settings](#)

[Scanning Using Invoice/Receipt Manager](#)

[Selecting Invoice/Receipt Manager Settings](#)

[Scan Resolution Guidelines](#)

Starting a Scan

After placing your originals on your product for scanning, start scanning using one of these methods.

[Starting a Scan Using the Product Control Panel](#)

[Scanning to a Network Folder](#)

[Scanning to an Email](#)

[Scanning to the Cloud](#)

[Scanning to an External USB Device](#)

[Setting Up a WSD Port \(Windows 7\)](#)

[Scanning Using WSD - Windows](#)

[Scanning Using Presets](#)

Parent topic: [Scanning](#)

Starting a Scan Using the Product Control Panel



You can scan an image to a variety of destinations using your product's control panel.

Your product automatically selects default scan settings, but you can view or change them as necessary.

If you are scanning to a computer, you can change the default scan settings using the Event Manager utility on the computer.

1. Make sure you installed the product software and connected the product to your computer or network.

Note: Restart your computer after installing the product software to enable scanning from the control panel. Also make sure the Event Manager program is not being blocked by your firewall or security software.

2. Place your original on the product for scanning.
3. Select  home, if necessary.
4. Select **Computer**.
5. If you see a message about installing the Epson ScanSmart software, select **OK**.
6. Select the computer to which you want to save the scanned images.
7. Select either **1-sided** or **2-sided** as the scanning option.
8. Tap the  icon and select the desired scanner settings.
9. Select the  start icon to start scanning.

Epson ScanSmart opens and your product scans your original and saves the scanned file to your computer.

Note: Click **Help** in Epson ScanSmart for detailed information.

Parent topic: [Starting a Scan](#)

Related topics

[Loading Originals](#)

Scanning to a Network Folder



You can save the scanned image to a specified folder on a network.

Note: Before scanning, make sure you set a network folder or FTP server, and check that the **Date/Time** and **Time Difference** settings are correct.

1. Place your original on the product for scanning.
2. Select  home, if necessary.
3. Select **Network Folder/FTP**.

4. Enter a folder location.
5. Do one of the following:
 - To select frequently used addresses, tap the icons displayed on the screen.
 - To enter the folder path directly, select **Keyboard > Communication Mode**, and enter the folder path in the **Location (Required)** field. Select other options, as necessary.
 - To select a contact from the contacts list, select **Contacts**, select a contact, and then select **Close**. You can tap the  icon to create a new contact, or search for a folder from the contacts list. Enter the search keyword into the box at the top of the screen.
6. Select the **Scan Settings** tab, and select the desired settings.

Note: Tap the  icon if you want to save your settings as a preset.

7. Tap the  icon and check the scanner settings or make changes, if necessary.
8. Select the  start icon to start scanning.

Epson ScanSmart opens and your product scans your original and saves the scanned file to the designated folder.

Note: Click **Help** in Epson ScanSmart for detailed information.

Parent topic: [Starting a Scan](#)

Scanning to an Email

You can send the scanned image by email directly from the scanner.

Note: Before scanning, make sure you configure the email server, and check that the **Date/Time** and **Time Difference** settings are correct.



1. Place your original on the product for scanning.
2. Select  home, if necessary.
3. Select **Email**.
4. Enter a folder location.

5. Do one of the following:
 - To select frequently used addresses, tap the icons displayed on the screen.
 - To enter the folder path directly, select **Keyboard**, enter an email address, and select **OK**.
 - To select a contact from the contacts list, select **Contacts**, select a contact or group, and then select **Close**. You can tap the  icon to create a new contact, or search for a contact in the contacts list. Enter the search keyword into the box at the top of the screen.
 - To select a recently used contact, select **History**, select a contact, and then select **Close**.

Note: The number of recipients you selected is displayed on the right side of the screen. You can send emails to up to 10 contacts and groups. If groups are included in the contacts list, you can select up to 200 individual addresses in total, taking addresses within the groups into account. Select the address box at the top of the screen to display the list of selected addresses.

6. Select the **Scan Settings** tab, and select the desired settings.

Note: Tap the  icon if you want to save your settings as a preset.

7. Tap the  icon and check the scanner settings or make changes, if necessary.
8. Select the  start icon to start scanning.

Parent topic: [Starting a Scan](#)

Scanning to the Cloud

You can use the control panel to send your scanned files to a destination that you have registered with Epson Connect.



Note: Make sure to set up your product using Epson Connect before using this feature.

1. Place your original on the product for scanning.
2. Select  home, if necessary.
3. Select **Cloud**.

Note: You must register your product with Epson Connect to select a destination.

4. Select **Cloud**.
5. Tap the + icon at the top of the screen to select a destination.
6. Change any of the displayed settings on the **Basic Settings** tab as necessary.
7. Select the **Advanced** tab to view and change additional scan settings, if necessary.

Note: Tap the  icon if you want to save your settings as a preset.

8. Tap the  icon and check the scanner settings or make changes, if necessary.
9. Select the  start icon to start scanning.

Your product scans your original and saves the scanned file to the selected destination.

Parent topic: [Starting a Scan](#)

Scanning to an External USB Device

You can save the scanned image to an external USB device.

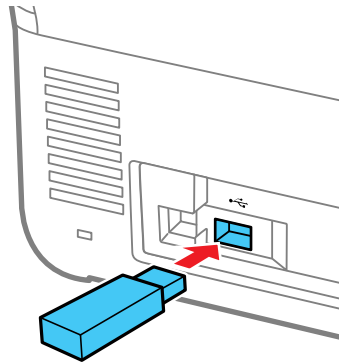

1. Place your original on the product for scanning.
2. Select  home, if necessary.
3. Insert a memory device into the scanner's external interface USB port.



Note: Your USB device must meet the following maximum capacity specification: 2 TB (formatted in FAT, FAT32, or exFAT). Devices with security settings (such as password or encryption), or those requiring a dedicated driver cannot be used.

4. Select **Memory Device**.
5. Change any of the displayed settings on the **Basic Settings** tab as necessary.
6. Select the **Advanced** tab to view and change additional scan settings, if necessary.

Note: Tap the  icon if you want to save your settings as a preset.

7. Tap the  icon and check the scanner settings or make changes, if necessary.
8. Select the  start icon to start scanning.

Your product scans your original and saves the scanned file to the external USB device.

Parent topic: [Starting a Scan](#)

Setting Up a WSD Port (Windows 7)

You can scan to a networked Windows computer using WSD (Web Services for Devices). You must first set up a WSD port on your Windows 7 system (the port is set up automatically on Windows 10 and Windows 8.x).

Before you set up a WSD port, make sure you installed your product software, and connected your product and computer to the same network.

1. Turn on your product.
2. Click  and select **Computer**.
3. On the left side of the window, select **Network**.
4. Locate your product on the Network screen, right-click it, and select **Install**.
5. When you see the User Account Control screen, click **Continue**.

Note: If you see an Uninstall screen, click **Uninstall** and repeat these steps as necessary.

6. When you see the message **Your device is ready to use** in the Windows taskbar, click the message.
7. On the Driver Software Installation screen, make sure your product is listed as **Ready to use**. Then click **Close**.
8. Click  and select **Devices and Printers**.
9. Make sure that an icon appears for your product's name on the network.



When you use WSD, select your product name to scan over the network.

Parent topic: [Starting a Scan](#)

Scanning Using WSD - Windows

You can scan originals to a computer from the product control panel using WSD (Web Services for Devices) for network scanning in Windows.

Note: To use this feature on Windows 7, you must first set up WSD on the computer. See Windows help for instructions.



1. Make sure you installed the product software and connected the product to your computer or network.
2. Place your original on the product for scanning.
3. Select  home, if necessary.
4. Select **WSD**.
5. Select a computer.
6. Select the  start icon to start scanning.

Your product scans your original and saves the scanned file to your computer.

Parent topic: [Starting a Scan](#)

Scanning Using Presets

You can select a registered preset and use it to scan images.

1. Select  home, if necessary.
2. Do one of the following:
 - Select **Presets** on the home screen, and select a setting from the list.
 - Select the  icon on the scan settings screen, and select a preset from the list.
 - If you added the preset icon to the home screen, select the icon.
3. If you see a loading confirmation screen, select **Close**.

Note: If you enabled the **Quick Send Setting** for the selected preset, loading is skipped and scanning starts immediately.

4. Verify the settings for the selected preset and select the  start icon to start scanning.

Parent topic: [Starting a Scan](#)

Related tasks

[Registering Presets](#)

Starting a Scan from a Smart Device

You can use the Epson Smart Panel app to scan from a network scanner to an iOS or Android device over a direct Wi-Fi connection.

Note: Epson Smart Panel does not support scanning with a carrier sheet or scanning for originals that are 15.5 inches (393.8 mm) or longer.

1. Download the Epson Smart Panel app from your device's app store or from Epson's website. See the link below.
2. Place your original on the product for scanning.
3. Open the Epson Smart Panel app and select a scan menu on the home screen.
4. Follow the on-screen instructions to scan and save your original.

Parent topic: [Scanning](#)

Related tasks

[Using the Epson Smart Panel Mobile App](#)



Scanning a Document in Epson ScanSmart

You can scan and review documents in Epson ScanSmart.

Note: The images show Windows screens for the ES-580W; Mac screens and those for the RR-600W model may be slightly different. Depending on your product model and software version, not all options may be available.

1. Load your original into the scanner.
2. Start the scan by doing one of the following:
 - Press the  start button on the scanner. Epson ScanSmart automatically opens on your computer and the scan job begins. (The default is double-sided scanning.)

Note: You can change the scanning button default in the  **Settings** menu.

- Open Epson ScanSmart on your computer. Do one of the following:
 - **Windows 10:** Click  > **Epson Software** > **Epson ScanSmart**.
 - **Windows 8.x:** Navigate to the **Apps** screen and select **Epson ScanSmart**.
 - **Windows 7:** Click , and select **All Programs**. Select **Epson Software** > **Epson ScanSmart**.
 - **Mac:** Open the **Applications** folder, open the **Epson Software** folder, and select **Epson ScanSmart**.

You see a screen like this:

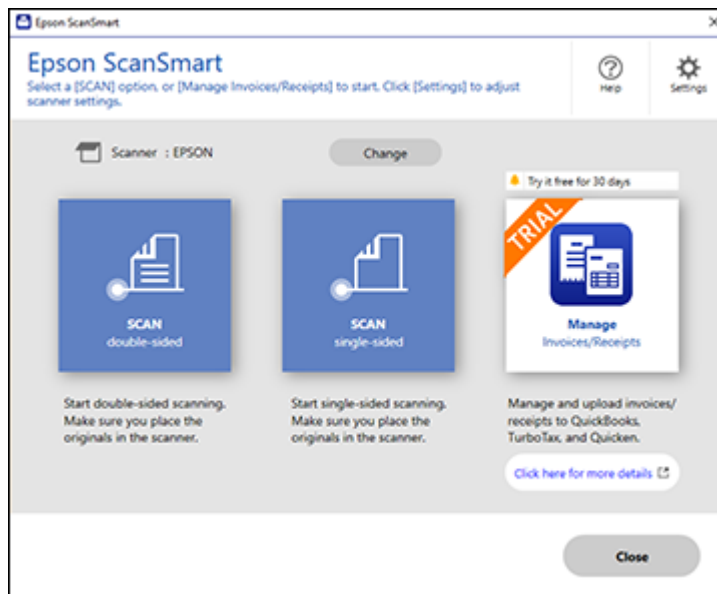

Note: Trial software offer not available for all models in all regions.

3. Select a scan option.

The scan job begins and your original feeds through the scanner. When scanning is complete, you see a screen like this:

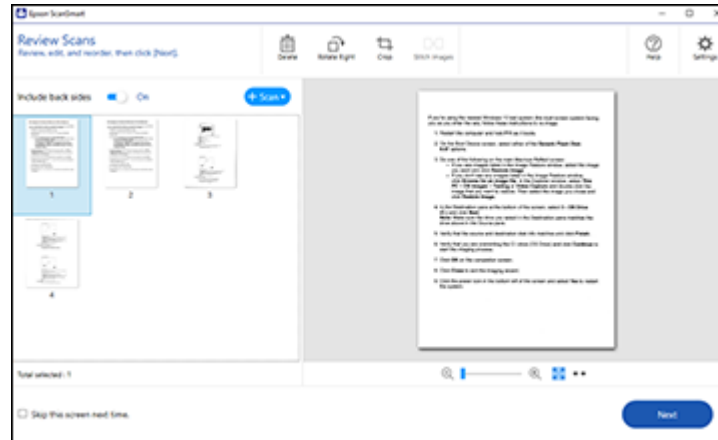

4. You can review, edit, or reorder the scanned images as follows:
 - Select **Scan** to scan more originals.
 - Select **Delete** to delete selected scanned images.
 - Select **Rotate Right** to rotate each scanned image.
 - Select **Crop** to crop the selected image.
 - Select **Stitch Images** to combine two selected images into one image.
 - If you scanned double-sided, select **On** or **Off** for **Include back sides** if you want to keep or discard the back sides of scanned images.
 - Select **Skip this screen next time** if you do not want to preview images each time.
5. When you are finished reviewing the scanned images, click **Next**.

You see a screen like this:

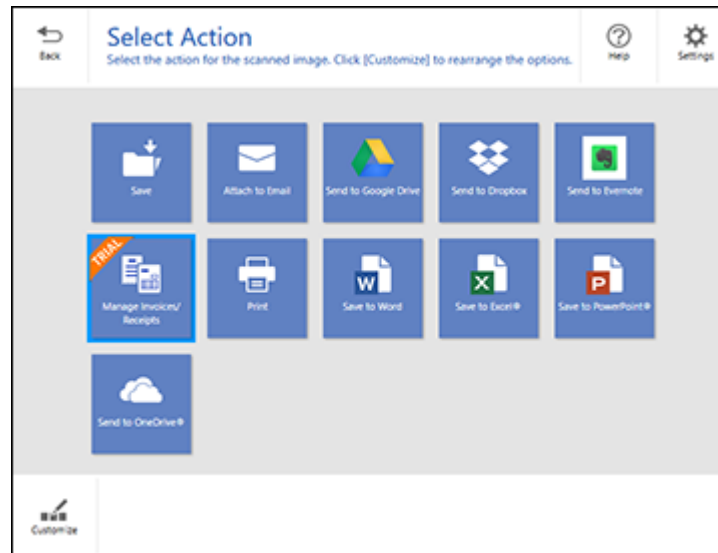

6. Select an option to save, send, or print the scanned images. See the links below.

[Saving a Scan](#)

[Attaching a Scan to Email](#)

[Sending a Scan to a Cloud Service](#)

[Printing a Scan](#)

[Saving a Scan as a Microsoft Office Format File](#)

Parent topic: [Scanning](#)

Related tasks

[Customizing Action Icons](#)

Related topics

[Loading Originals](#)

Saving a Scan

You can save a scanned image to your computer in a variety of formats.

1. Make sure your originals are scanned and reviewed. See the link below.

2. In the **Select Action** window, click **Save**.

You see a screen like this:

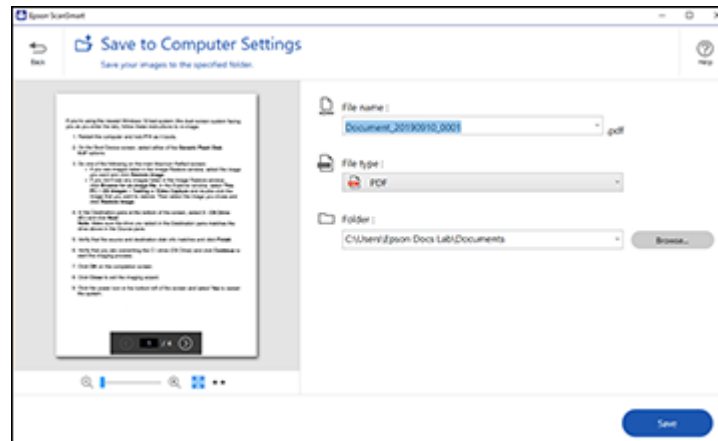

3. Change the settings as follows:
 - The document type and scan date for the file name are automatically detected. You can change them as necessary.
 - You can save the scanned image in a variety of formats. If you select Searchable PDF as the **File type** setting, you can select the OCR (Optical Character Recognition) language.
 - Select the folder on your computer in which to save the file.
4. Click **Save**.

Parent topic: [Scanning a Document in Epson ScanSmart](#)

Attaching a Scan to Email

You can attach a scanned image to an email as a file attachment.

Note: Your email app and account settings should be configured before scanning. You must install a MAPI-type email program such as Outlook Express, Windows Live Mail, Entourage, or Mac Mail. Attach to Email only supports 32-bit MAPI-compatible mail apps. Web-based email services such as Gmail are not supported. If you see an error message, your email app may not be compatible and you will need to save the scans and manually attach the file to an email.

1. Make sure your originals are scanned and reviewed. See the link below.
2. In the **Select Action** window, click **Attach to Email**.

You see a screen like this:

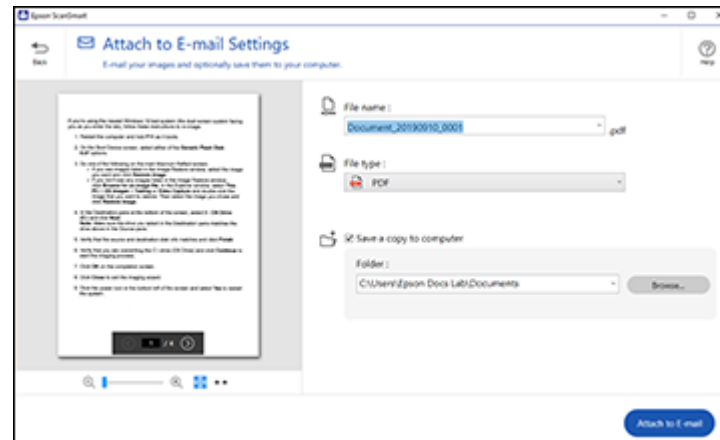

3. Change the settings as follows:
 - The document type and scan date for the file name are automatically detected. You can change them as necessary.
 - You can save the scanned image in a variety of formats. If you select Searchable PDF as the **File type** setting, you can select the OCR (Optical Character Recognition) language.
 - If you also want to save a copy of the scanned image to your computer, make sure the checkbox is selected and select the folder on your computer in which to save the file.
4. Click **Attach to E-mail**.

Your email program opens with the file attached to a new email.

Parent topic: [Scanning a Document in Epson ScanSmart](#)

Sending a Scan to a Cloud Service

You can upload scanned images to a cloud service.

1. Make sure your originals are scanned and reviewed. See the link below.
2. In the **Select Action** window, click one of the cloud service send options.

You see a screen like this:

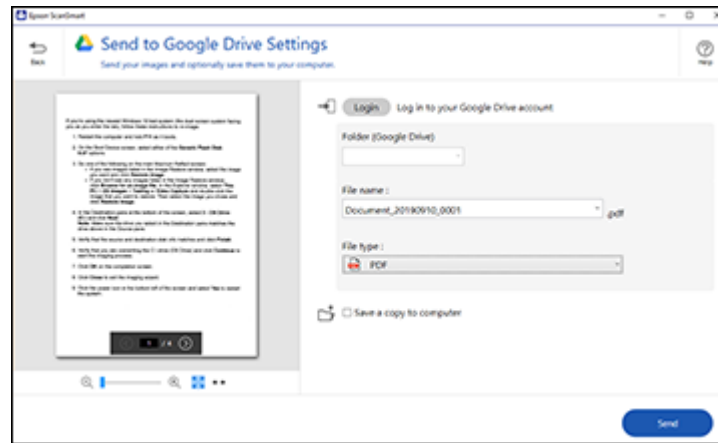

3. Log in to your account.

Note: You may need to allow Epson ScanSmart access to your account. The first time you log in, you may be prompted to enter an authentication code.

4. Change the settings as follows:
 - Select the folder in your account where you want to send the document.
 - The document type and scan date for the file name are automatically detected. You can change them as necessary.
 - You can save the scanned image in a variety of formats. If you select Searchable PDF as the **File type** setting, you can select the OCR (Optical Character Recognition) language.
 - If you also want to save a copy of the scanned image to your computer, click the checkbox.
5. Click **Send**.

Parent topic: [Scanning a Document in Epson ScanSmart](#)

Printing a Scan

You can print your scanned image and save the scanned file to your computer.

Note: Printing scanned images is available only with Epson printers. If you do not have an Epson printer, save the file and print it from an application that can open the file.

1. Make sure your originals are scanned and reviewed. See the link below.
2. In the **Select Action** window, click **Print**.

You see a screen like this:

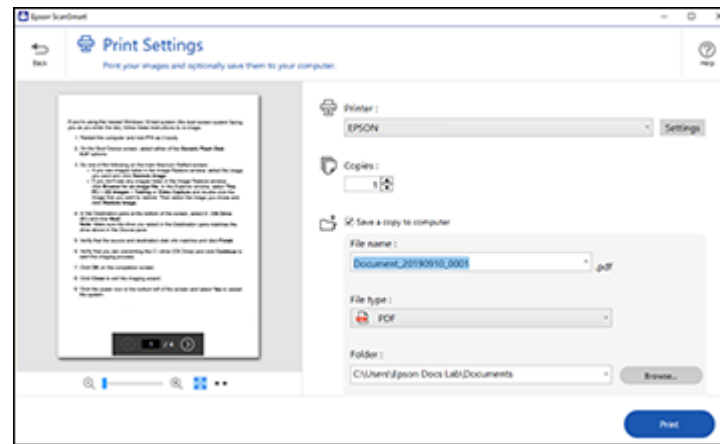

3. Change the settings as follows:
 - Select the Epson printer and change the print settings, if necessary.
 - Select the number of copies you want to print.
 - If you also want to save a copy of the scanned image to your computer, click the checkbox.
 - The document type and scan date for the file name are automatically detected. You can change them as necessary.
 - You can save the scanned image in a variety of formats. If you select Searchable PDF as the **File type** setting, you can select the OCR (Optical Character Recognition) language.
 - Select the folder on your computer in which to save the file.
4. Click **Print**.

Parent topic: [Scanning a Document in Epson ScanSmart](#)

Saving a Scan as a Microsoft Office Format File

You can save your scans in one of the following editable Microsoft Office file formats: Microsoft Word (.docx), Microsoft Excel (.xlsx), or Microsoft PowerPoint (.pptx).

Note: The **Save to PowerPoint** option is only available for Windows.

1. Make sure your originals are scanned and reviewed. See the link below.
2. In the **Select Action** window, click one of the save to options.

Note: A first-time prompt may appear asking you to download a Microsoft Office plug-in. Click **Yes** and follow any on-screen instructions.

You see a screen like this:

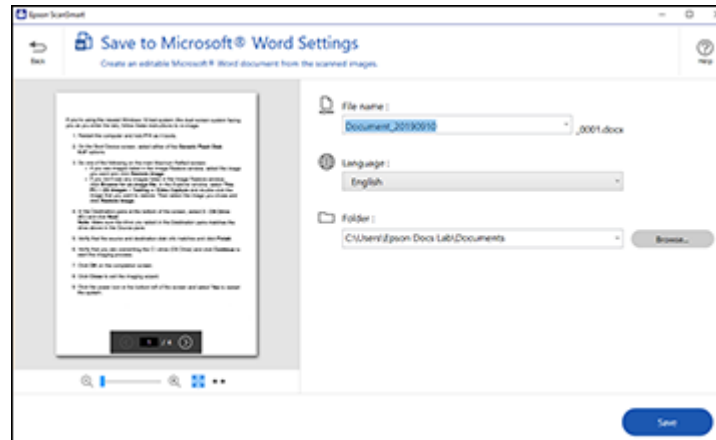

3. Change the settings as follows:
 - The document type and scan date for the file name are automatically detected. You can change them as necessary.
 - Select the OCR language (the default is English).
 - Select the folder on your computer in which to save the file.
4. Click **Save**.

Parent topic: [Scanning a Document in Epson ScanSmart](#)

Related topics

[Loading Originals](#)

Selecting Epson ScanSmart Settings

After starting Epson ScanSmart, you can change various scanning settings.

[Changing the Epson Product](#)

[Changing the Scan Settings](#)

[Changing the File Name Settings](#)

[Changing the Save Settings](#)

[Customizing Action Icons](#)

Parent topic: [Scanning](#)

Changing the Epson Product

If you are using more than one Epson product with Epson ScanSmart, you can change the product that you are using with your computer.

Note: A product connected to your computer via USB takes priority over a product with a Wi-Fi connection.

1. On the main screen, click **Change**.

You see a screen like this:

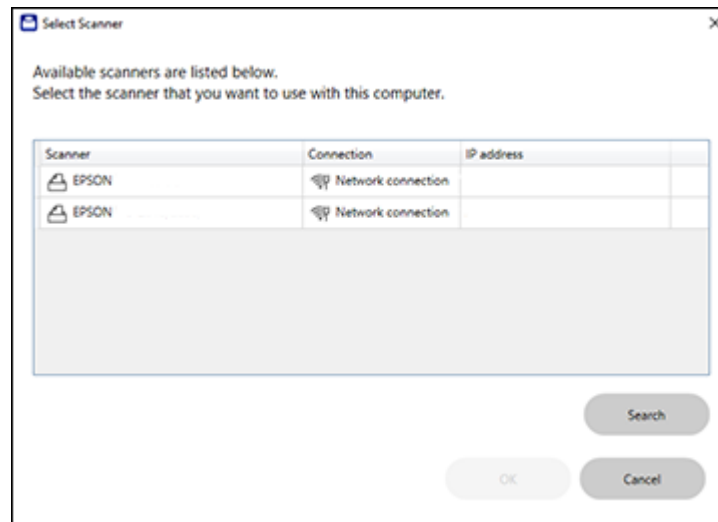

2. Select the Epson product you want to use with your computer and click **OK**.

Parent topic: [Selecting Epson ScanSmart Settings](#)

Changing the Scan Settings

You can change detailed scan settings such as the resolution, document size, and more.

1. Click the  **Settings** button.

You see a screen like this:

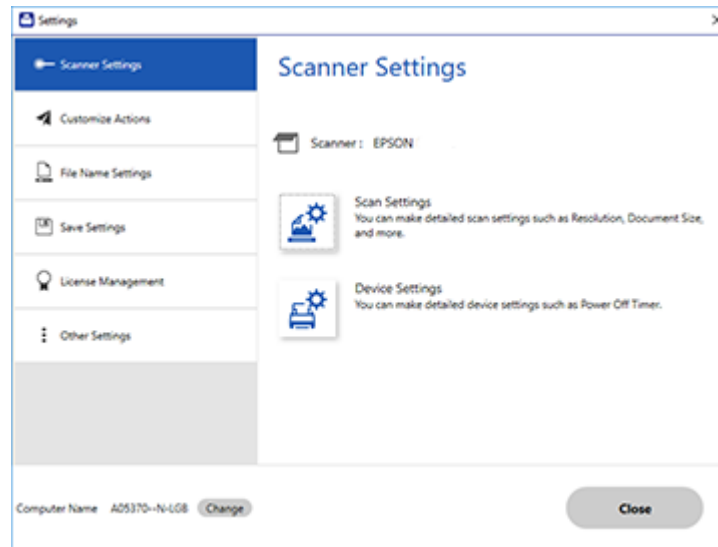

2. On the **Scanner Settings** tab, click **Scan Settings**.

You see a screen like this:

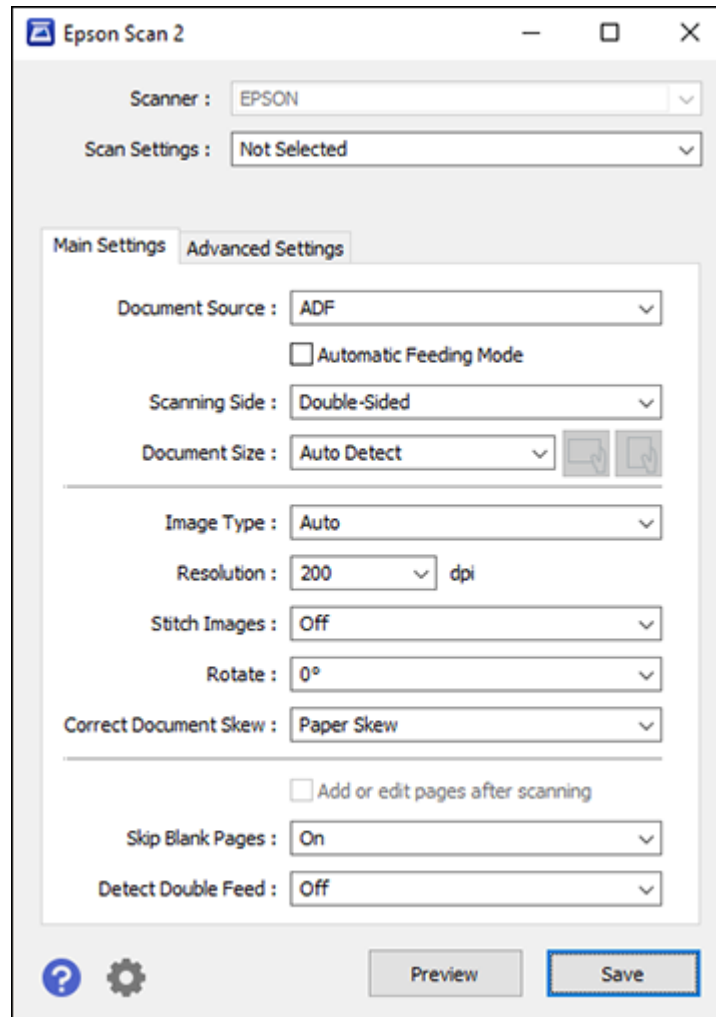

3. Change the settings as necessary and click **Save**.

Parent topic: [Selecting Epson ScanSmart Settings](#)

Changing the File Name Settings

You can change the default file naming method for your scans.

1. Click the  **Settings** button.

You see a screen like this:

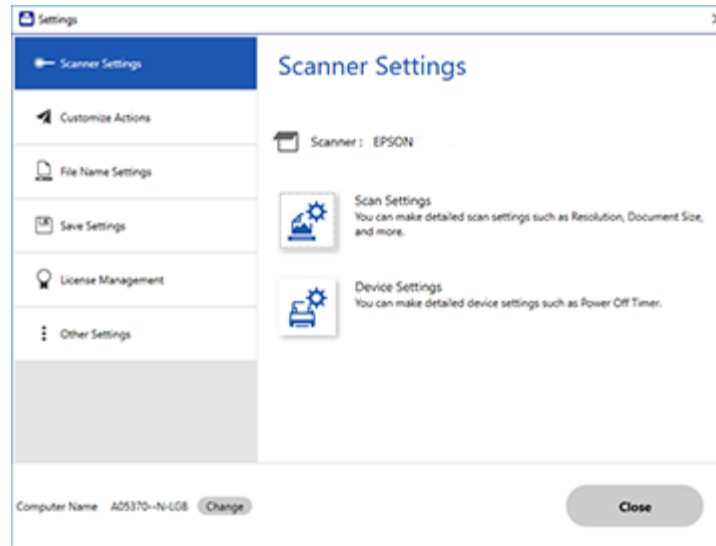

2. Click the **File Name Settings** tab.

You see a screen like this:

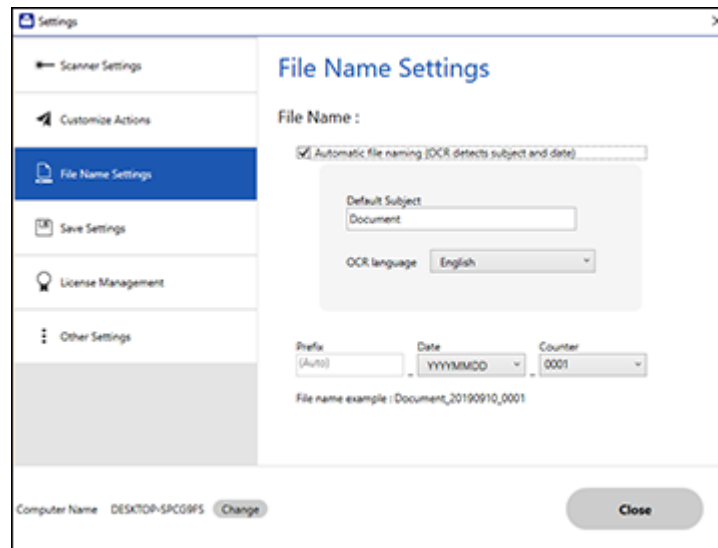

3. Change the settings as necessary:

- Make sure the **Automatic file naming** checkbox is selected if you want OCR to automatically detect the subject and date and add them to the file name. You can enter a default file name that will be used if OCR cannot detect the subject.
- Select the OCR language (the default language is English).
- Select the date format.

4. Click **Close**.

Parent topic: [Selecting Epson ScanSmart Settings](#)

Changing the Save Settings

You can change the file type options for saving your scans.

1. Click the  **Settings** button.

You see a screen like this:

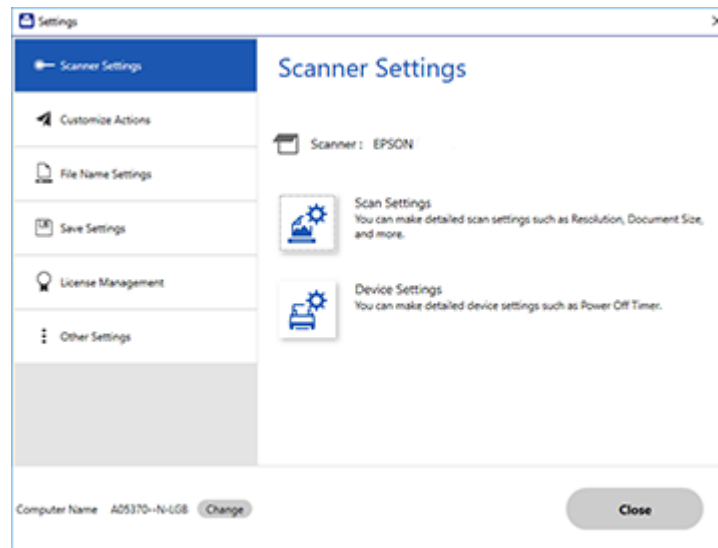

2. Click the **Save Settings** tab.

You see a screen like this:

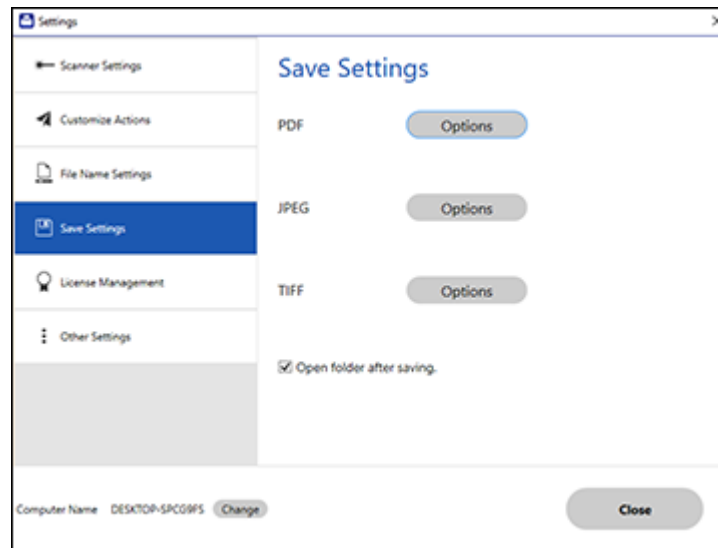

3. Click **Options** for a file format and change the settings as necessary.

Note: If you want the folder to open after the file is saved, click the checkbox.

4. Click **Close**.

[Save Settings](#)

Parent topic: [Selecting Epson ScanSmart Settings](#)

Save Settings

You can change the settings for how scanned images are saved as PDFs or JPEGs.

PDF Options

Setting	Options	Description
General	Generate PDF/A File	Creates a PDF that conforms to PDF/A-1 standards
	Create file with all pages	Saves all pages as one file
	Compression Level	Selects the compression level for color or grayscale images
Security	Open File Password	Set a password to open the file
	Protect Property Settings	Sets a password to protect file properties and allows for restrictions on file editing and printing

JPEG Options

Setting	Options	Description
Image Quality Options	—	Sets a compression level by moving a slider or entering a value. File size increases when high resolution is selected.
Encoding (Windows only)	Standard	Images load from top to bottom in a web browser. It takes longer to load the entire image.
	Progressive	Images first load completely at low resolution and then adjust to high resolution in a web browser
Embed ICC Profile (Windows only)	—	Allows you to add ICC profiles to the image

TIFF Options

Setting	Options	Description
Byte Order	Windows Macintosh	Specifies the operating system format in which the scanned image is saved

Setting	Options	Description
Compression (Windows only)	—	Specifies the compression format and level for Color/Grayscale and B&W images. File size increases with higher quality.
Embed ICC Profile (Windows only)	—	Allows you to add ICC profiles to the image

Parent topic: [Changing the Save Settings](#)

Customizing Action Icons

You can customize how the scan action icons are displayed on the **Select Action** screen.

Note: You can also customize them by clicking the **Customize** icon on the **Select Action** screen.

1. Click the  **Settings** button.

You see a screen like this:

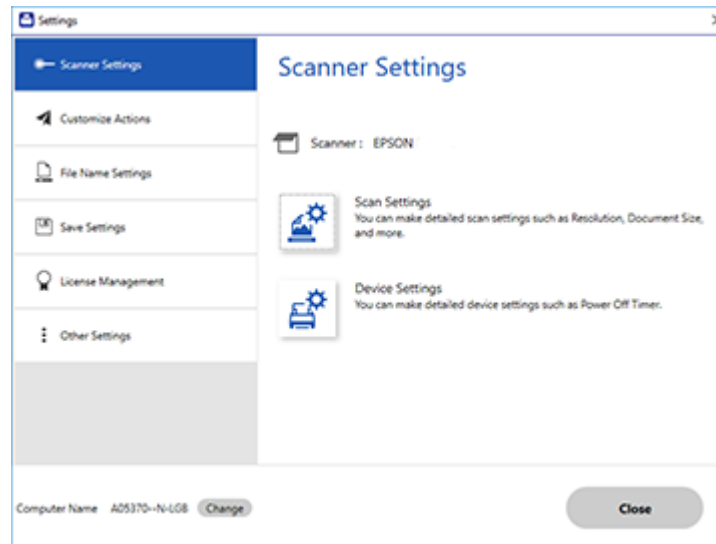

2. Click the **Customize Actions** tab.

You see a screen like this:

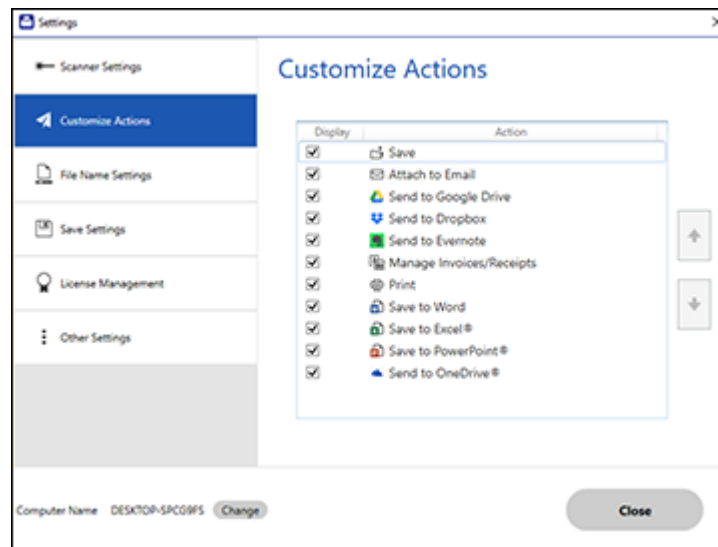

3. Choose which action icons to display by selecting or deselecting each checkbox. Click the arrow icons to move the icons up or down in the display order you want.
4. Click **Close**.

Parent topic: [Selecting Epson ScanSmart Settings](#)

Scanning Using Invoice/Receipt Manager

See these sections to activate Invoice/Receipt Manager and start scanning invoices and receipts (RR-600W).

Note: Receipt Manager availability varies by model and region.

[Starting a Free Trial](#)

[Activating Receipt Manager](#)

[Scanning Receipts and Using Receipt Manager](#)

Parent topic: [Scanning](#)

Starting a Free Trial

You can start a 30-day free trial of Receipt Manager.

Note: Trial offer not available for all models in all regions.

Note: The images show Windows screens for the ES-580W; Mac screens and those for the RR-600W model may be slightly different. Depending on your product model and software version, not all options may be available.

1. Click the **Manage Invoices/Receipts** icon on the main Epson ScanSmart screen.

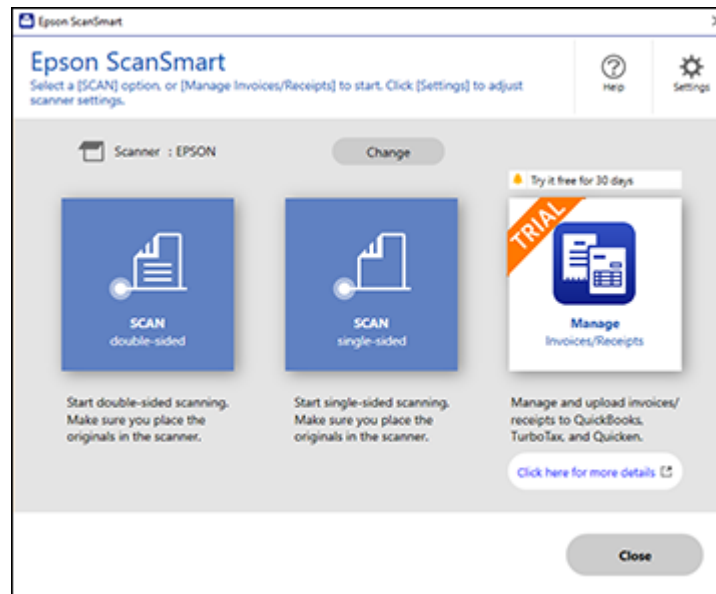

2. Click **Start Trial**.

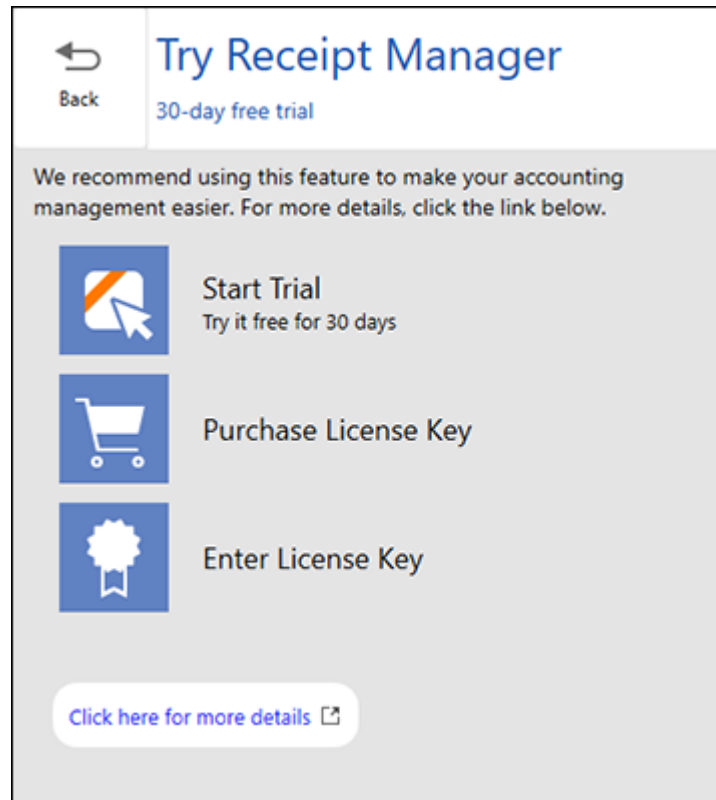

Note: If you are ready to purchase a license key now, click **Purchase License Key**. The Epson support page opens in your web browser. When you receive the license key, click **Enter License Key** and enter it on the screen that appears, then click **Activate**. You can also click the link below for instructions on activating Receipt Manager from the Settings menu.

3. Make sure the scanner and serial number listed match your product and click **OK**.

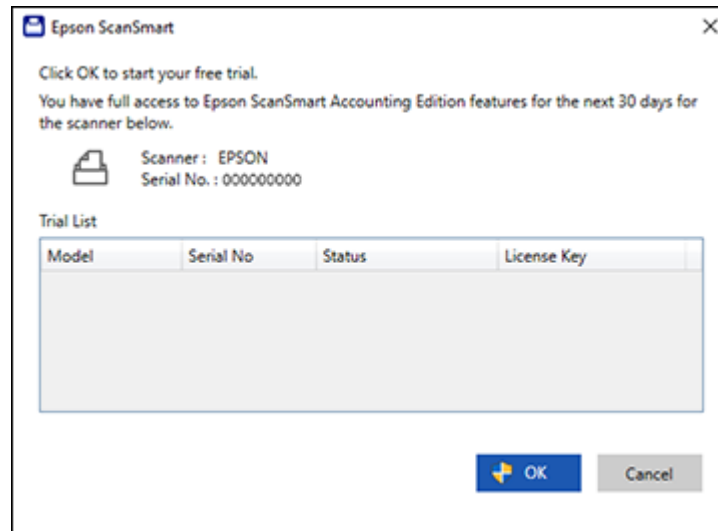

4. Receipt Manager opens and you can begin using its features.

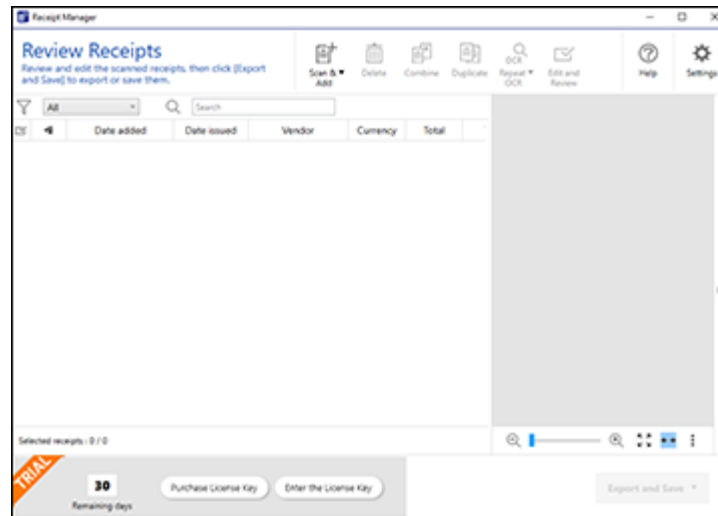

When the 30-day trial expires, you can purchase a license key to continue using Receipt Manager features.

[Hiding the Receipt Manager Trial Icons](#)

Parent topic: [Scanning Using Invoice/Receipt Manager](#)

Hiding the Receipt Manager Trial Icons

You can hide the Receipt Manager trial icons from the Epson ScanSmart screens.

1. Click the  **Settings** button in Epson ScanSmart.

You see a screen like this:

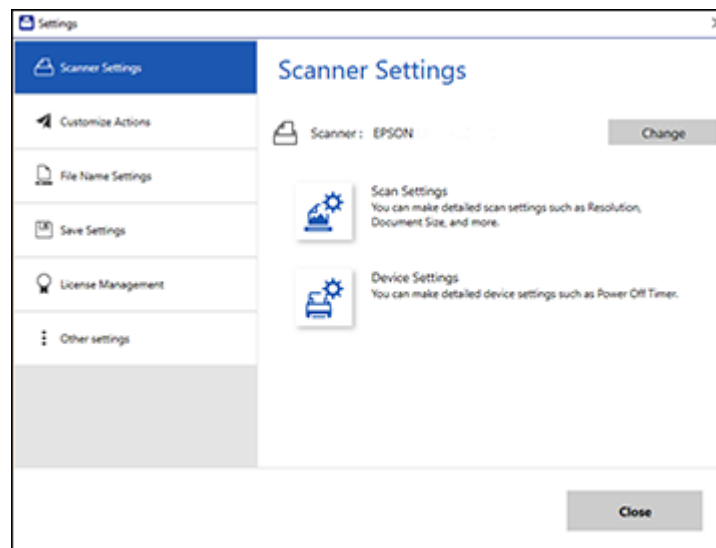

2. Click the **Other Settings** tab.

You see a screen like this:

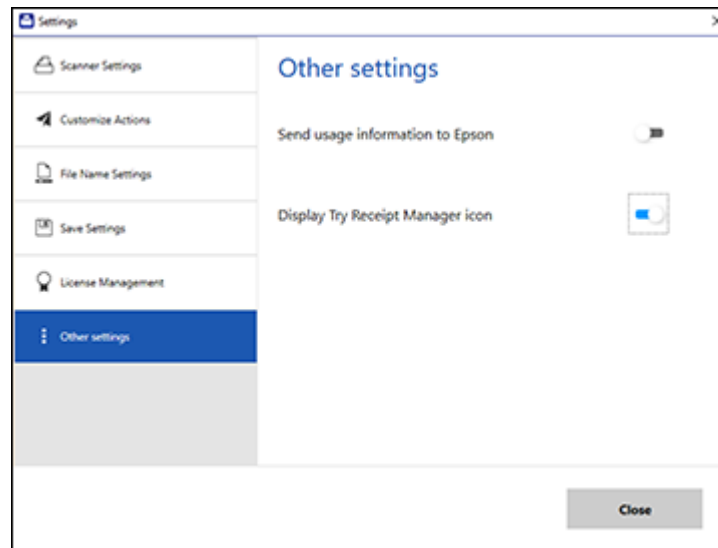

3. Click the **Display Try Receipt Manager icon** toggle button to hide or display the trial icon on the main Epson ScanSmart screen.

Note: You can also hide or display the trial icon from the **Select Action** screen on the **Customize Actions** tab.

4. Click **Close**.

Parent topic: [Starting a Free Trial](#)

Activating Receipt Manager

You can purchase a license key to activate Receipt Manager.

Note: The license key can only activate one scanner.

Note: Entering a license key is not required for all models in all regions.

1. Click the **Settings** button.

You see a screen like this:

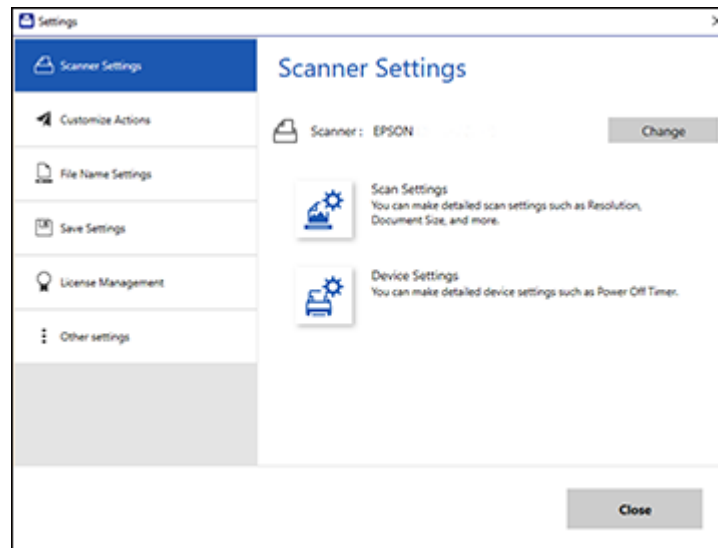

2. Click the **License Management** tab.

You see a screen like this:

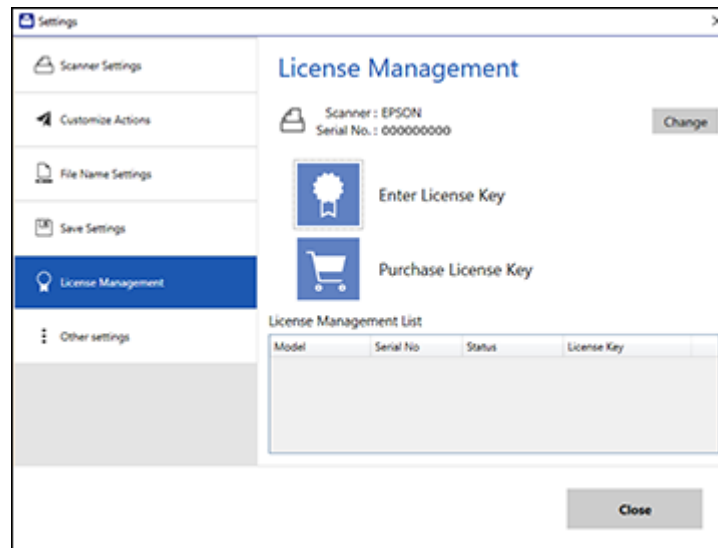

3. To purchase a new license key, click **Purchase License Key**.
The Epson support page opens in your web browser where you can purchase the license key. If you already have a license key, go to step 4.
4. Make sure the scanner you want to activate the license key for is displayed at the top of the screen. Click **Change** if you want to select a different scanner.
5. Click **Enter License Key**.

You see a screen like this:

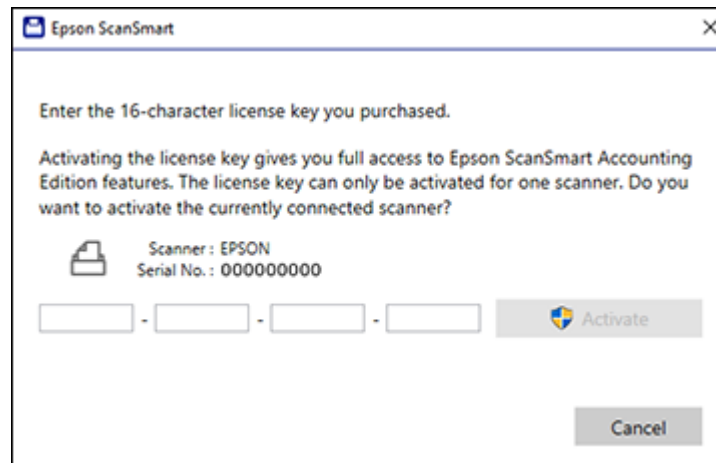

6. Enter the license key you purchased and click **Activate**.
7. Click **Yes** on the next screen (Windows only).
8. When you see a message indicating that activation was successful, click **OK**.

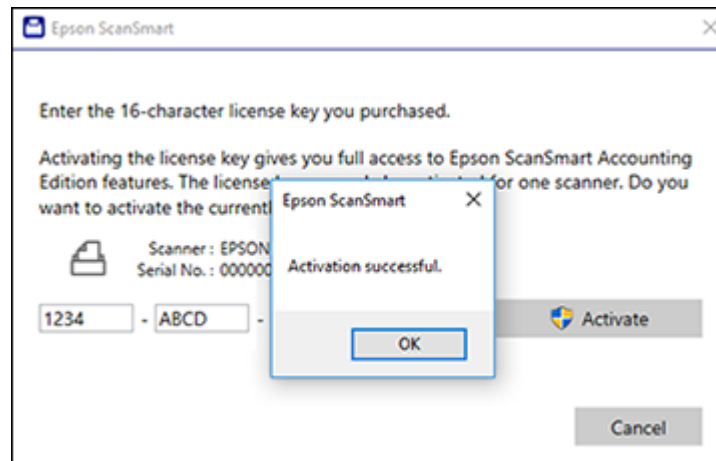

The activated scanner and license key appear in the License Management List.

Parent topic: [Scanning Using Invoice/Receipt Manager](#)

Scanning Receipts and Using Receipt Manager

You can scan receipts and manage the data in Receipt Manager.

1. Load your original receipts into the scanner.
2. Select **Home**, if necessary.
3. Select **Computer** and press **Start**.

Epson ScanSmart automatically opens on your computer and the scan job begins. The receipts feed through the scanner. When scanning is complete, you see a screen like this:

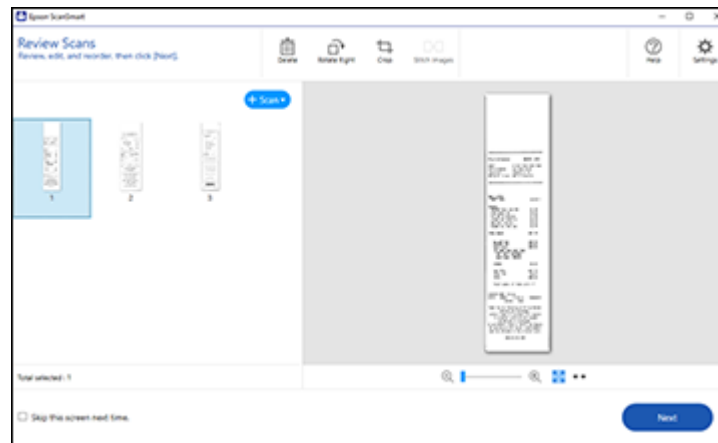

4. You can review or reorder the scanned images as follows:
 - Select **+ Scan** to scan more receipts.
 - Select **Delete** to delete selected scanned images.
 - Select **Rotate Right** to rotate scanned images.
 - Select **Crop** to crop the selected image.
 - Select **Stitch Images** to combine two selected images into one image.
5. When you are finished reviewing the scanned images, click **Next**.

You see a screen like this:

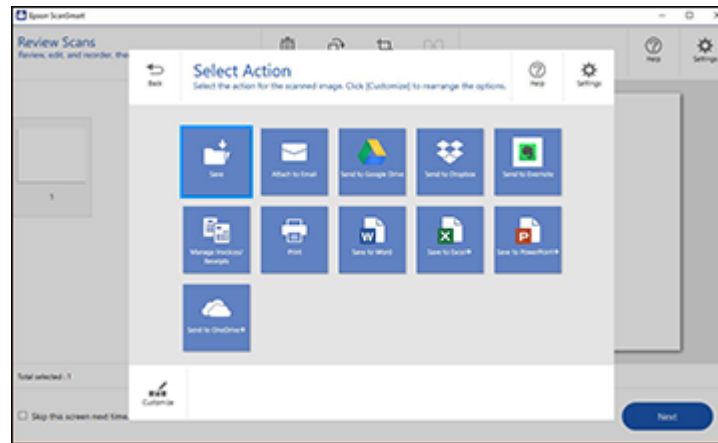

6. Click **Manage Invoices/Receipts**.

You see a screen like this:

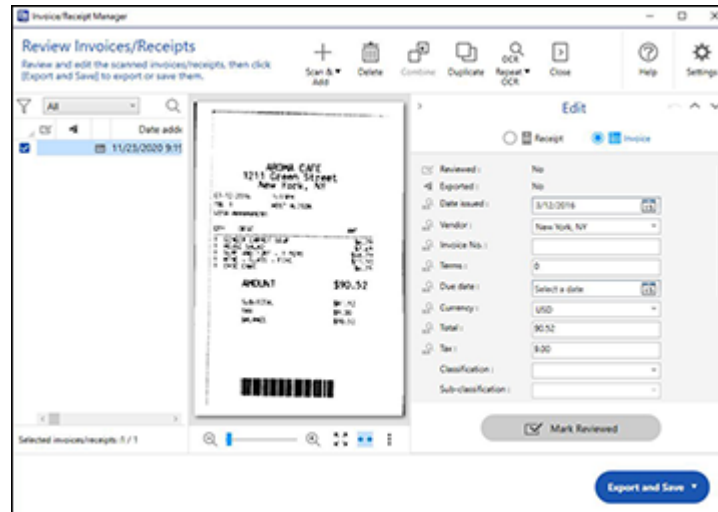

Note: You can also click **Manage Invoices/Receipts** from the main Epson ScanSmart screen to begin scanning receipts.

Note: If you are using the trial version of Receipt Manager, you must click **Continue Trial** each time you click **Manage Receipts**.

7. In the **Edit** window, review the receipt data against the scanned image and make sure it is correct. You can also choose the following options:
 - Select **Scan & Add** to scan more receipts.
 - Select **Delete** to delete selected scanned images. Make sure the blue checkbox in the receipt list is selected for the receipts you want to delete.
 - Select **Combine** to combine receipt data. Make sure the blue checkboxes in the receipt list are selected for the receipts you want to combine.

Note: You cannot separate receipts once they are combined. You must delete and re-scan them if you need to separate them.

- Select **Duplicate** to duplicate receipts. You can only duplicate one receipt at a time. Make sure the receipt you want to duplicate is selected.
- Select **Repeat OCR** and select a language if the data fields were not populated.

Note: Some fields may need to be entered manually.

8. When you are finished reviewing the data for the first receipt, click **Mark Reviewed**. The next receipt appears and you can review the data. Repeat for each receipt.

Note: Make sure the blue checkboxes in the receipt list are selected for the receipts you want to export or save.

9. When you have finished reviewing data for all receipts, click **Export and Save**.

You see a screen like this:

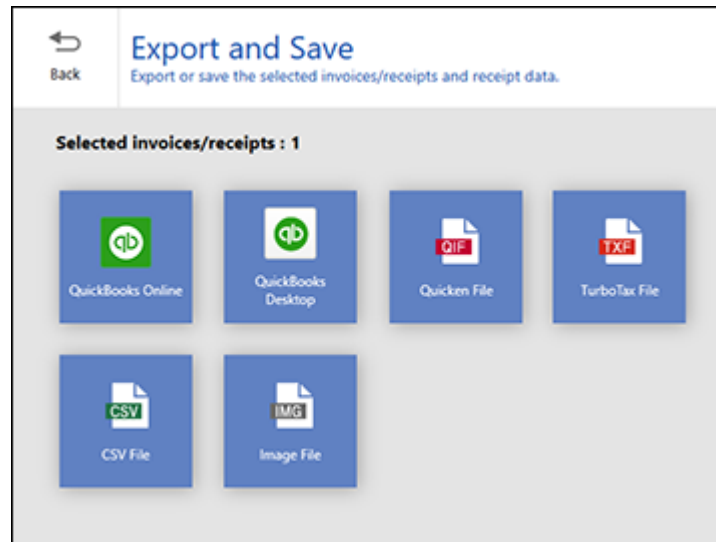

10. Select an option. See the links below.

[Exporting Invoices or Receipts to QuickBooks Online](#)

[Exporting Invoices or Receipts to QuickBooks Desktop](#)

[Saving or Exporting Receipts to Quicken](#)

[Saving Receipt Data as a TurboTax File](#)

[Saving Invoice or Receipt Data as a CSV File](#)

[Scanning Invoices or Receipts as an Image File](#)

Parent topic: [Scanning Using Invoice/Receipt Manager](#)

Related references

[Characters are not Recognized During Conversion to Editable Text \(OCR\)](#)

Exporting Invoices or Receipts to QuickBooks Online

You can export invoice or receipt data to QuickBooks Online.

Note: Make sure you have a current QuickBooks account and your login information is available.

1. Make sure your invoices or receipts are scanned and reviewed. See the link below.

2. In the **Export and Save** window, click **QuickBooks Online**.

You see a screen like this:

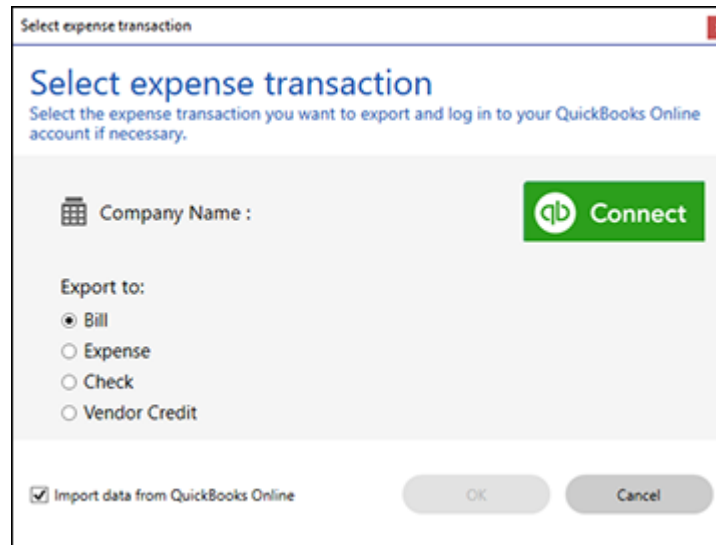

3. Click **Connect** and enter your QuickBooks Online information.
4. Select the expense transaction you want to export the data to and click **OK**.

Note: If you want to import data such as vendors, categories, or payment methods from QuickBooks Online into Invoice/Receipt Manager, select the checkbox.

The invoice or receipt data is exported to QuickBooks Online.

Parent topic: [Scanning Receipts and Using Receipt Manager](#)

Exporting Invoices or Receipts to QuickBooks Desktop

You can export invoice or receipt data to QuickBooks Desktop (Windows only).

Note: Make sure the QuickBooks Desktop software is installed and opened on your computer.

1. Make sure your invoices or receipts are scanned and reviewed. See the link below.
2. In the **Export and Save** window, click **QuickBooks Desktop**.

You see a screen like this:

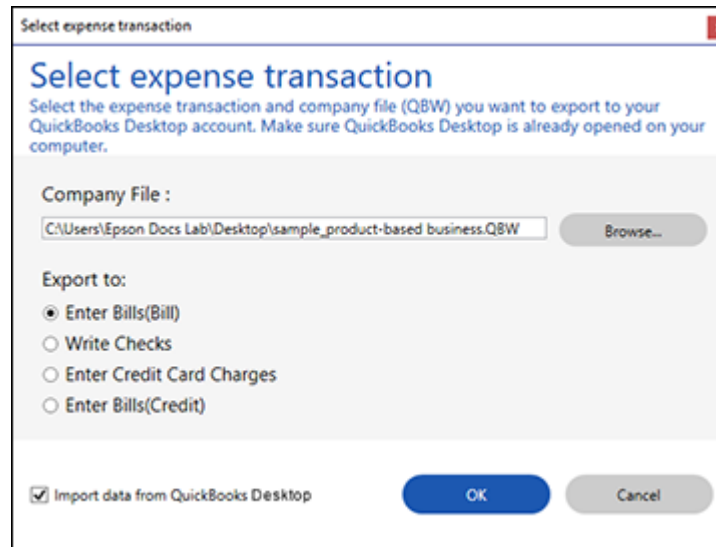

3. Click **Browse** and select the QBW company file that you want to export the data to.

Note: The QBW company file must already be created.

4. Select the expense transaction you want to export the data to and click **OK**.

Note: If you want to import data such as vendors or payment methods from QuickBooks Desktop into Invoice/Receipt Manager, select the checkbox.

The invoice or receipt data is exported to QuickBooks Desktop.

Parent topic: [Scanning Receipts and Using Receipt Manager](#)

Saving or Exporting Receipts to Quicken

You can save receipt data as a QIF file or export it for use in Quicken.

Note: Invoice data cannot be saved or exported in Quicken.

1. Make sure your receipts are scanned and reviewed. See the link below.

2. In the **Export and Save** window, click **Quicken File**.

You see a screen like this:

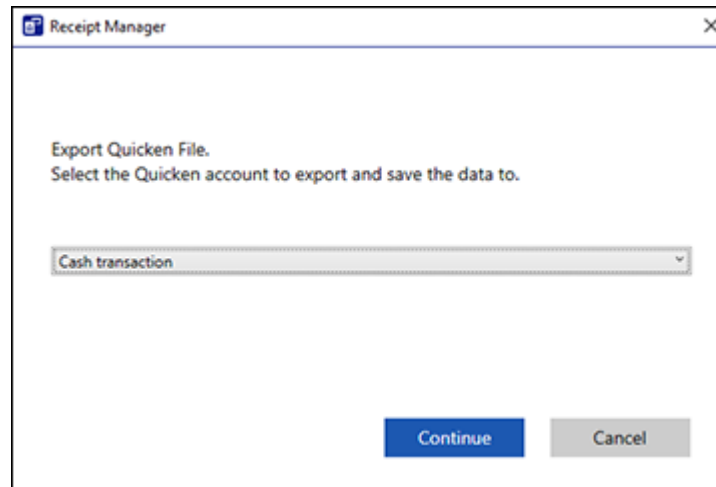

3. Do one of the following:
 - Select **Cash transaction** and click **Continue** to save the receipt data as a QIF file.
 - Select **Select the Quicken account** and click **Continue** to export the receipt data to a QIF file previously saved on your computer.

The scanned receipt data is saved or exported.

Parent topic: [Scanning Receipts and Using Receipt Manager](#)

Saving Receipt Data as a TurboTax File

You can save receipt data as a TurboTax file.

Note: Invoice data cannot be saved or exported in TurboTax.

1. Make sure your receipts are scanned and reviewed. See the link below.

Note: The tax category needs to be selected for each receipt to be recognized by TurboTax.

2. In the **Export and Save** window, click **TurboTax File**.

3. Save the file as a TXF file to your computer.

Parent topic: [Scanning Receipts and Using Receipt Manager](#)

Saving Invoice or Receipt Data as a CSV File

You can save invoice or receipt data as a CSV file to use in a spreadsheet program such as Microsoft Excel.

1. Make sure your invoices or receipts are scanned and reviewed. See the link below.
2. In the **Export and Save** window, click **CSV File**.
3. Choose the folder on your computer where you want to save the CSV file and click **Save**.

Parent topic: [Scanning Receipts and Using Receipt Manager](#)

Scanning Invoices or Receipts as an Image File

You can save scanned invoices or receipts as an image file.

1. Make sure your invoices or receipts are scanned and reviewed. See the link below.
2. In the **Export and Save** window, click **Image File**.

You see a screen like this:

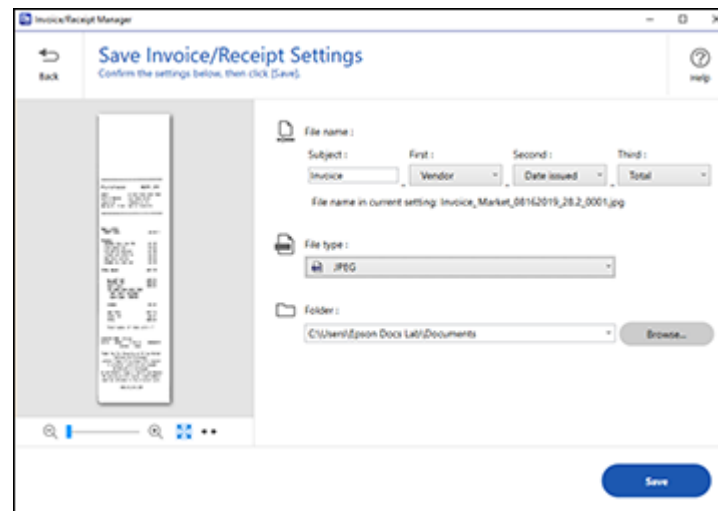

3. Review the file naming fields, select the file type (JPEG or PDF), select the destination folder, and click **Save**.

Parent topic: [Scanning Receipts and Using Receipt Manager](#)

Selecting Invoice/Receipt Manager Settings

After starting Invoice/Receipt Manager, you can export or import the database and change various settings.

[Exporting or Importing the Invoice/Receipt Database](#)

[Changing Column Settings](#)

[Changing Currency and Language Settings](#)

[Importing Categories from QuickBooks or Quicken](#)

Parent topic: [Scanning](#)

Exporting or Importing the Invoice/Receipt Database

You can export or import the invoice/receipt database. This is useful if you change computers.

Note: Make sure each computer has the same version of Epson ScanSmart installed.

1. Click the  **Settings** button in Invoice/Receipt Manager.

You see a screen like this:

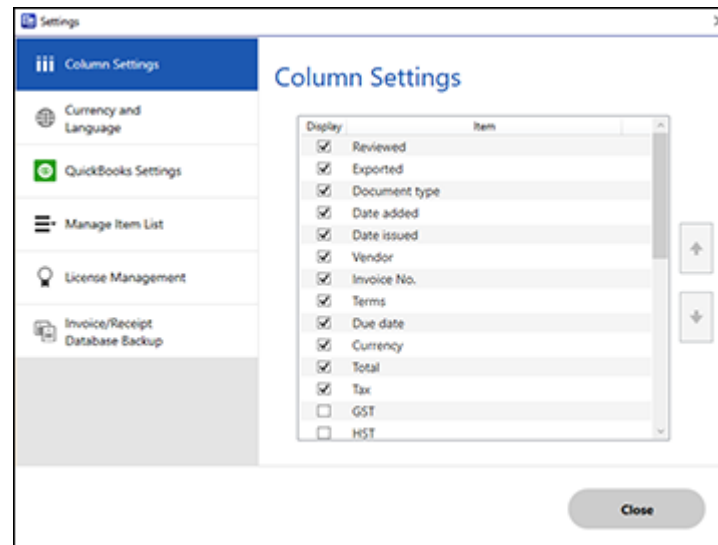

2. Select the **Invoice/Receipt Database Backup** tab.

You see a screen like this:

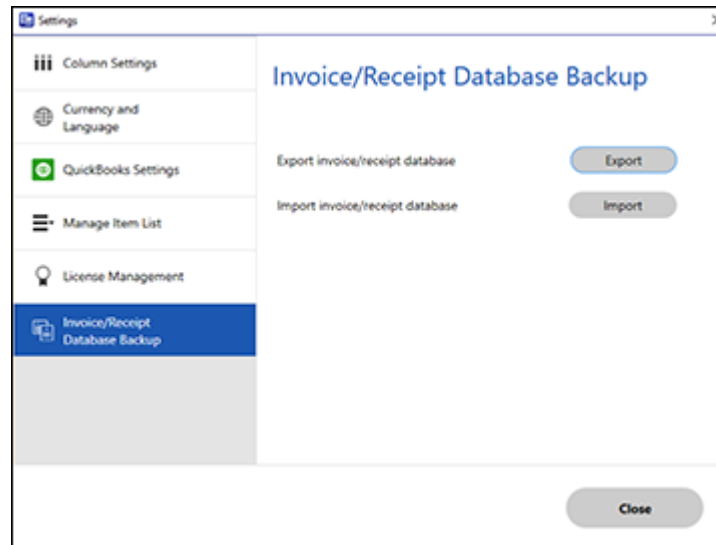

3. Choose one of these options:
 - Click **Export** to export the invoice/receipt database. A file is created that can be saved to a folder on your computer.
 - Click **Import** to import an invoice/receipt database. Choose the file that was created when you exported the database. The current database is overwritten.
4. Click **Close**.

Parent topic: [Selecting Invoice/Receipt Manager Settings](#)

Related tasks

[Scanning Receipts and Using Receipt Manager](#)

Changing Column Settings

You can choose which columns are displayed in the receipt list.

1. Click the  **Settings** button in Invoice/Receipt Manager.

You see a screen like this:

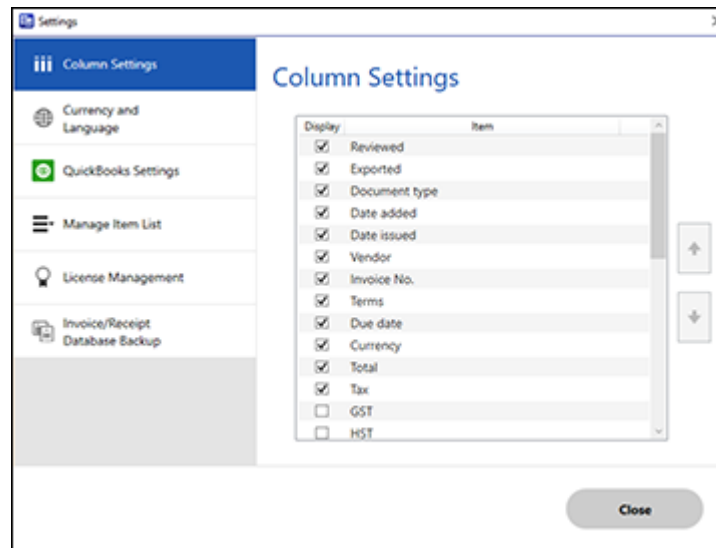

2. Choose which columns to display by selecting or deselecting each checkbox. Click the arrow icons to move the items up or down in the display order you want.
3. Click **Close**.

Parent topic: [Selecting Invoice/Receipt Manager Settings](#)

Related tasks

[Scanning Receipts and Using Receipt Manager](#)

Changing Currency and Language Settings

You can change the currency and OCR language for data in Invoice/Receipt Manager.

1. Click the  **Settings** button in Invoice/Receipt Manager.

You see a screen like this:

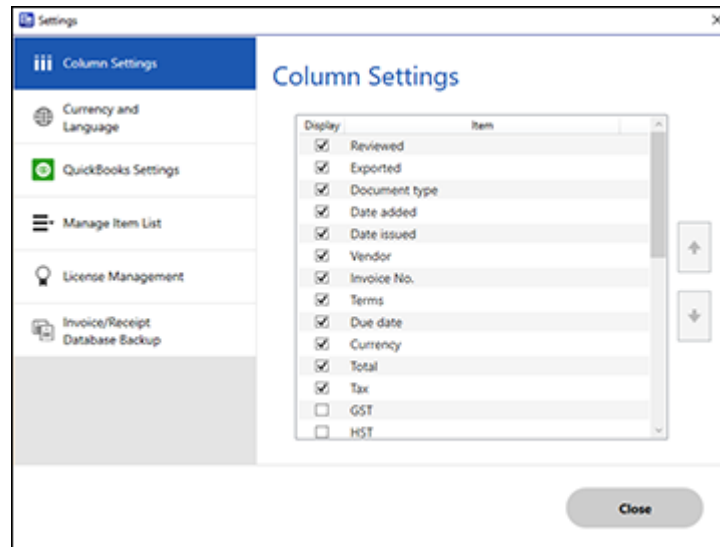

2. Click the **Currency and Language** tab.

You see a screen like this:

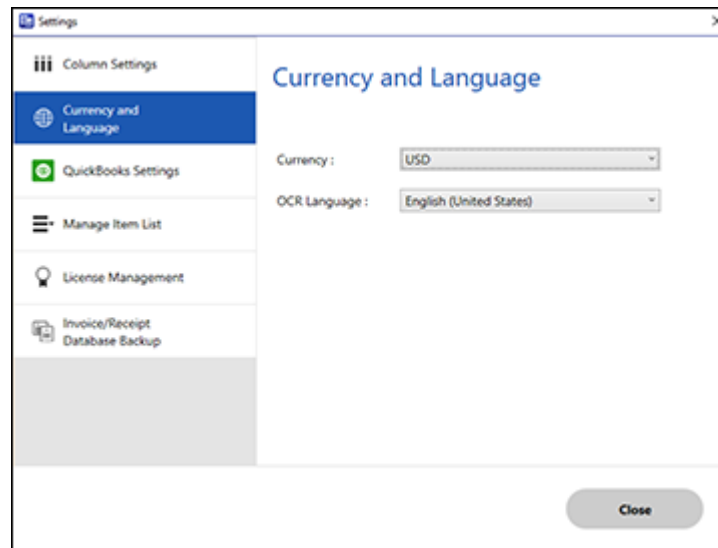

3. Select a currency type and OCR language.
4. Click **Close**.

Parent topic: [Selecting Invoice/Receipt Manager Settings](#)

Related tasks

[Scanning Receipts and Using Receipt Manager](#)

Importing Categories from QuickBooks or Quicken

You can import categories from QuickBooks Online, QuickBooks Desktop, or Quicken to use in Invoice/Receipt Manager.

1. Click the  **Settings** button in Invoice/Receipt Manager.

You see a screen like this:

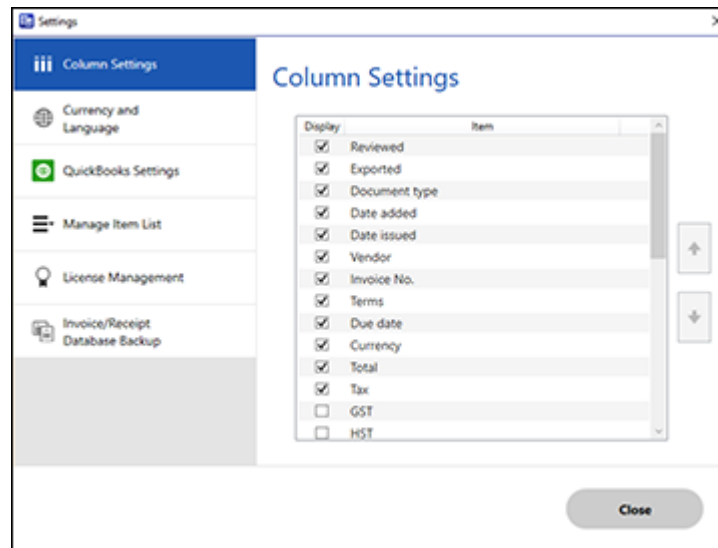

2. Click the **Manage Item List** tab.

You see a screen like this:

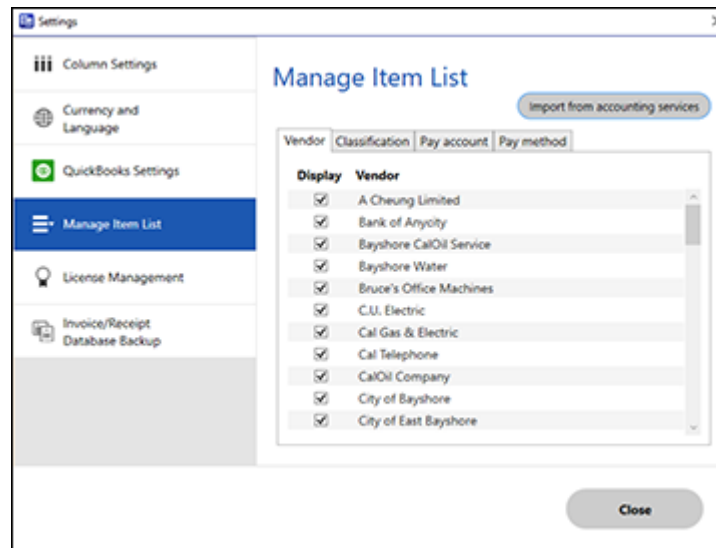

3. Click **Import from accounting services**.
4. Select one of the import options and follow the on-screen instructions.
5. Click the checkboxes for the categories that you want to be displayed in the Invoice/Receipt Manager Edit window and click **Close**.

Note: Imported items depend on the selected accounting service.

Parent topic: [Selecting Invoice/Receipt Manager Settings](#)

Related tasks

[Scanning Receipts and Using Receipt Manager](#)

Scan Resolution Guidelines

The resolution setting in your scanning software, measured in dpi (dots per inch), controls the amount of detail captured in your scans. Increasing the resolution raises the amount of detail captured but comes with the following disadvantages:

- Larger file sizes

- It takes longer to scan your originals, send/receive your scans by email or fax, and to print your scans
- The image may become too large to fit on your display or print on paper

If you plan to enlarge a scanned image so you can print it at a larger size, you may need to increase the resolution from the default resolution set by the software. Follow these guidelines to determine the resolution setting you need:

- You will scan the image at its original size but enlarge it later in an image-editing program.

Increase the resolution setting in your scanning software. Increase the resolution by the same amount you will increase the image size to retain a high image quality. For example, if the resolution is 300 dpi (dots per inch) and you will double the image size later, change the resolution setting to 600 dpi.

- You will scan the image at 100% or smaller size.

Select the resolution setting based on how you will use the scanned image:

- Email/view on a computer screen/post on the web: 96 to 200 dpi
- Print/fax/convert to editable text (OCR)/create searchable PDF: 200 to 300 dpi

Parent topic: [Scanning](#)

Cleaning and Transporting Your Scanner

See these sections if you need to clean or transport your scanner.

[Cleaning Your Scanner](#)

[Cleaning Inside Your Scanner](#)

[Checking the Scanner Roller Counter](#)

[Replacing the Scanner Rollers](#)

[Transporting Your Scanner](#)

Cleaning Your Scanner

To keep your product working at its best, you should clean it several times a year.

Caution: Do not use a hard brush, alcohol, or paint thinner to clean the product or you may damage it. Do not use oil or other lubricants inside the product or let water get inside it. Do not open the product's outer case.

1. Turn off the scanner and unplug the AC adapter.
2. Disconnect any connected cables.
3. Clean the outer case with a soft, dry cloth. Do not use liquid or chemical cleansers.

Note: If the outer case still requires additional cleaning, use a slightly damp cloth to wipe the outer case. Then wipe the case with a soft, dry cloth.

4. Clean the LCD screen with a soft, dry cloth.

Parent topic: [Cleaning and Transporting Your Scanner](#)

Cleaning Inside Your Scanner

Clean your scanner regularly to make sure that no dust builds up on the glass scanning surfaces. Dust can cause spots or lines in your scanned images. Clean the inside of the scanner every 5,000 scans. You can check the latest number of scans using the Epson Scan 2 Utility.

Caution: Do not use a hard brush, alcohol, or paint thinner to clean the product or you may damage it. Do not use oil or other lubricants inside the product or let water get inside it.

1. Turn off the scanner and unplug the AC adapter.
2. Disconnect any connected cables.
3. Pull down on the cover open lever and open the scanner cover.

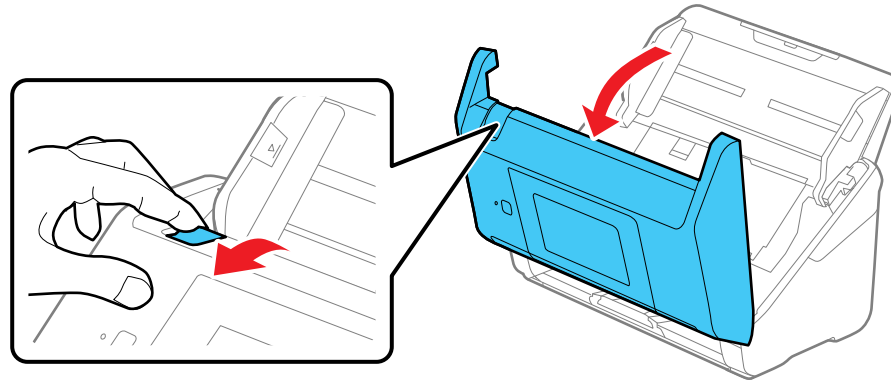

4. Use a genuine Epson cleaning kit or a soft, moist cloth to wipe off any dust or dirt on the glass scanning surfaces and the rollers inside the scanner cover. If the glass surface is stained with grease or some other hard-to-remove material, use a genuine Epson cleaning kit to remove stains. Use a small amount of cleaner on the cleaning cloth to remove the stains. Wipe off all remaining liquid.

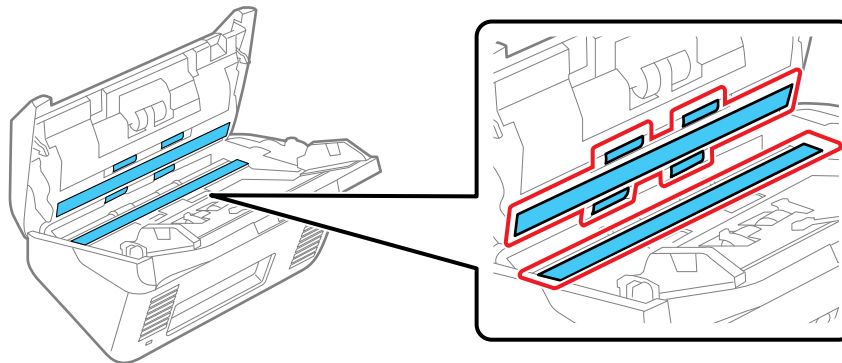

Caution: Do not spray glass cleaner directly on the scanning surfaces. Be careful not to place too much force on the glass.

5. Use a cotton swab to wipe off any dust or dirt on the sensors shown here.

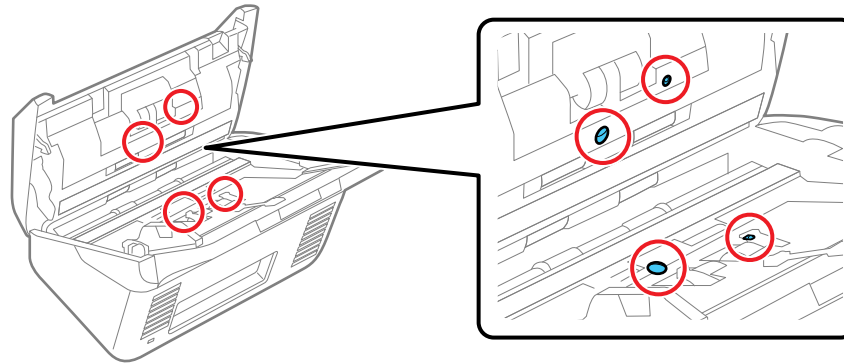

Caution: Do not use liquid or glass cleaner on the cotton swab.

6. Locate the separation roller.

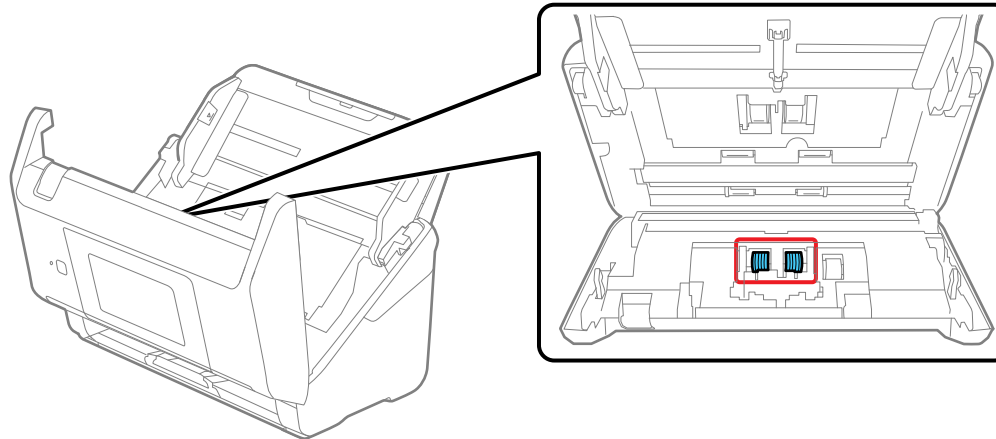

7. Squeeze the tabs on the sides of the separation roller cover and open the cover.

Caution: Be careful not to apply too much force when opening the cover.

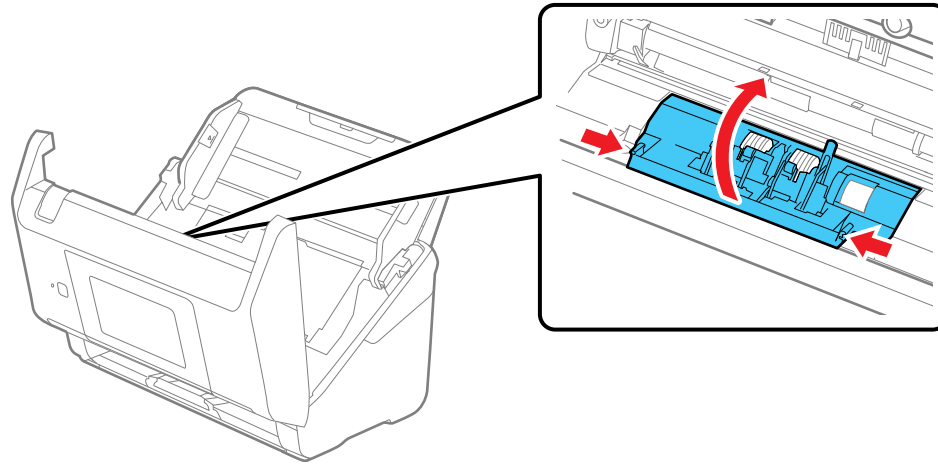

8. Slide the separation roller to the left and remove it.

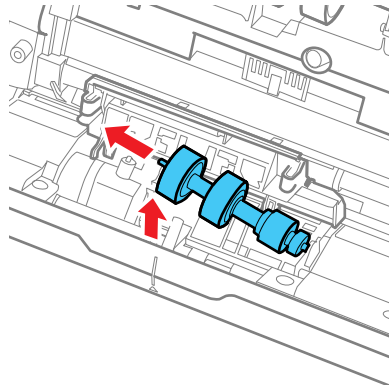

9. Wipe off any dust or dirt on the separation roller using a genuine Epson cleaning kit or a soft, moist cloth.

Caution: Use only a genuine Epson cleaning kit or soft, moist cloth to clean the roller; using a dry cloth may damage the surface of the roller.

10. To replace the separation roller, insert the end of the roller into the hole on the right side and lower the other end of the roller into place.

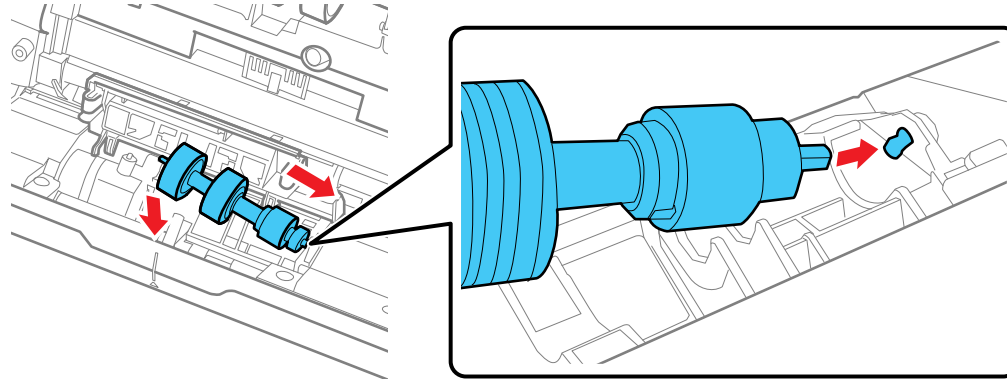

11. Close the separation roller cover until you hear it click into place.

Note: If you are not able to close the cover, the roller is not installed correctly. Remove the roller and reinstall it, then try to close the cover again.

12. Locate the pickup roller.

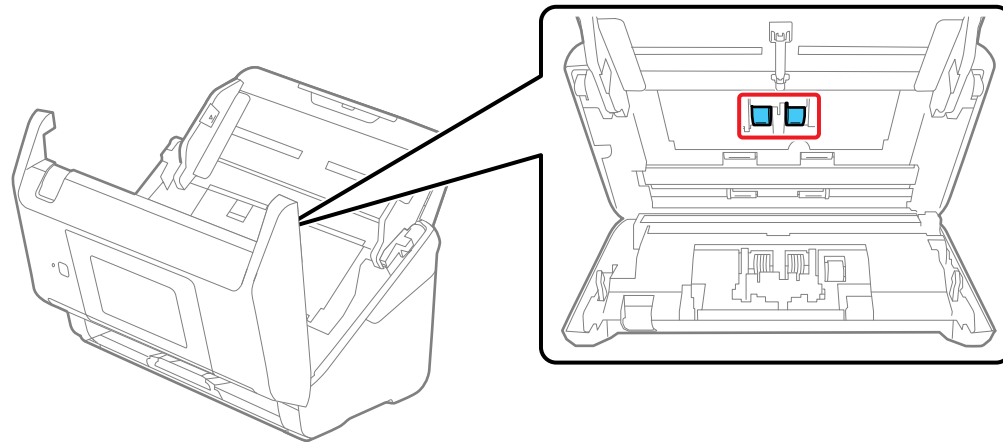

13. Press down on the pickup roller cover latch and pull up the cover to remove it.

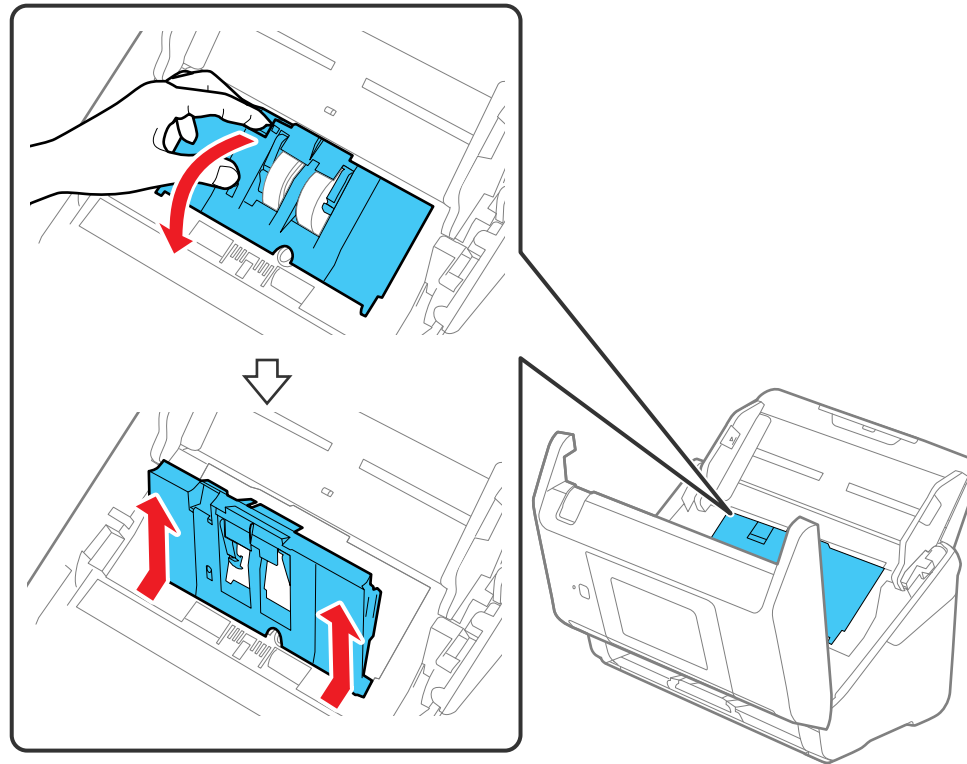

14. Pull down the tab on the pickup roller and slide the roller to the right to remove it.

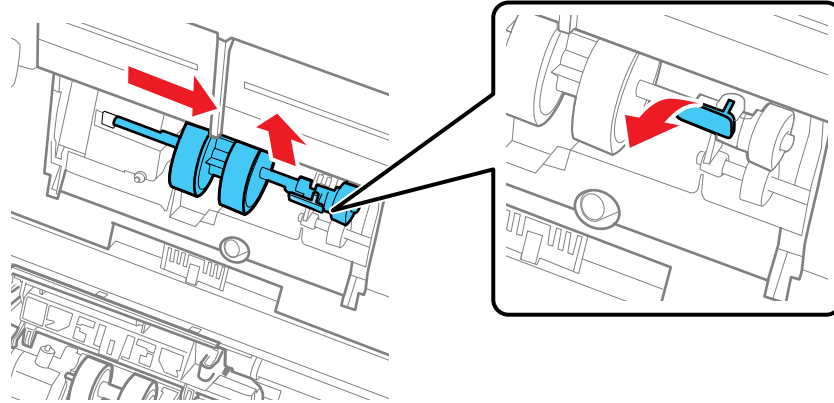

15. Wipe off any dust or dirt on the pickup roller using a genuine Epson cleaning kit or a soft, moist cloth.

Caution: Use only a genuine Epson cleaning kit or soft, moist cloth to clean the roller; using a dry cloth may damage the surface of the roller.

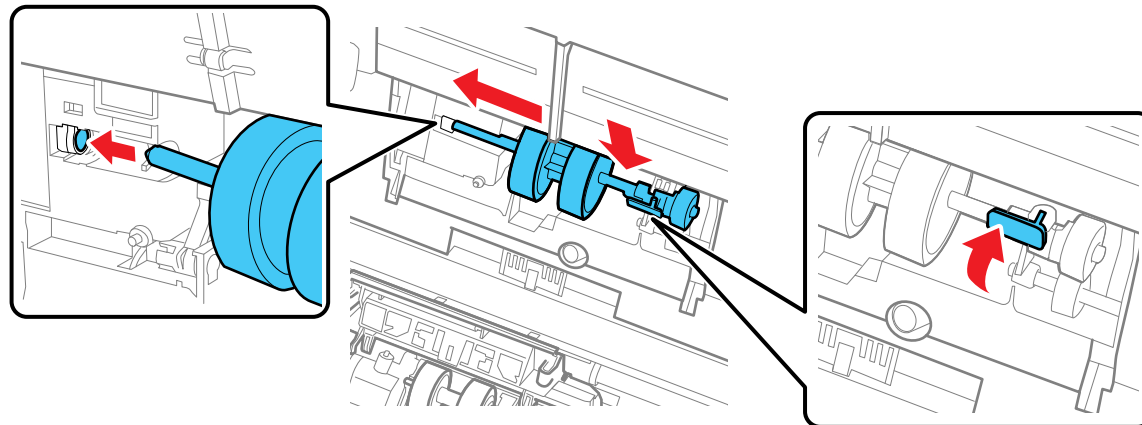

16. To replace the pickup roller, align the notches on the roller unit and slide it to the left. Press up on the tab to secure the roller.

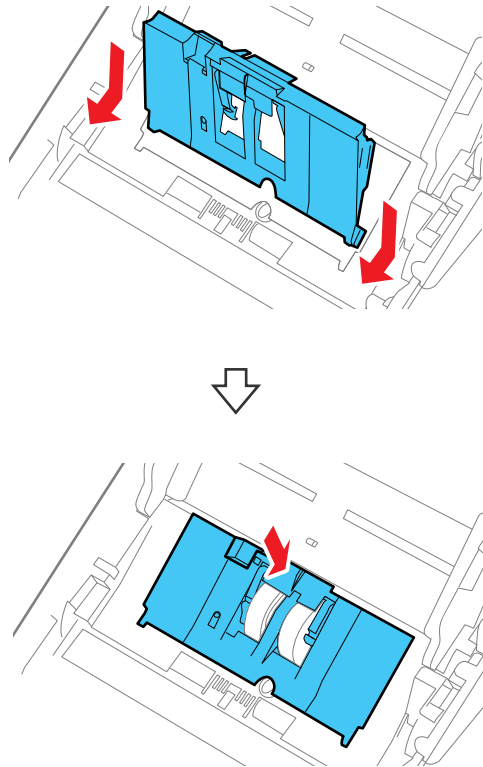

17. Align the bottom edge of the pickup roller cover into the notches as shown and press it down until it clicks into place.



Note: If you are not able to close the cover, the roller is not installed correctly. Remove the roller unit and reinstall it, then try to close the cover again.

18. Close the scanner cover.
19. Plug in the AC adapter and press the  power button to turn on the scanner.
20. Select  home, if necessary, and select **Scanner Maintenance**.
21. Select **Roller Cleaning**.

22. Pull down on the cover open lever and open the scanner cover.

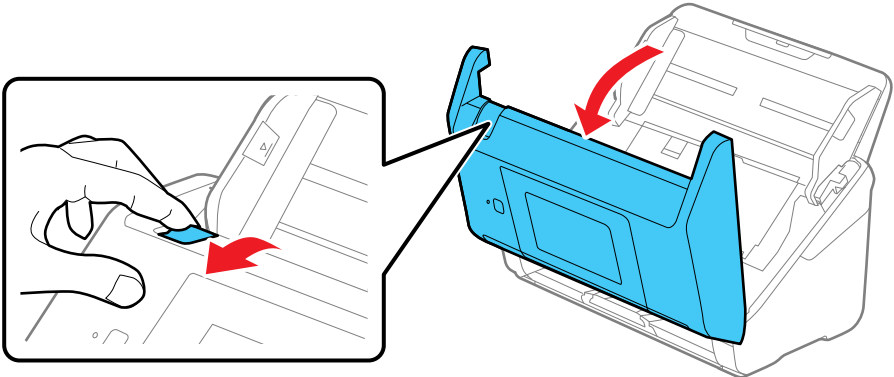

The scanner enters roller cleaning mode.

23. Slowly rotate the rollers shown here by tapping anywhere on the LCD screen. Use a genuine Epson cleaning kit or a soft, moist cloth to wipe off any dust or dirt on the rollers as they rotate. Repeat this step until the rollers are clean.

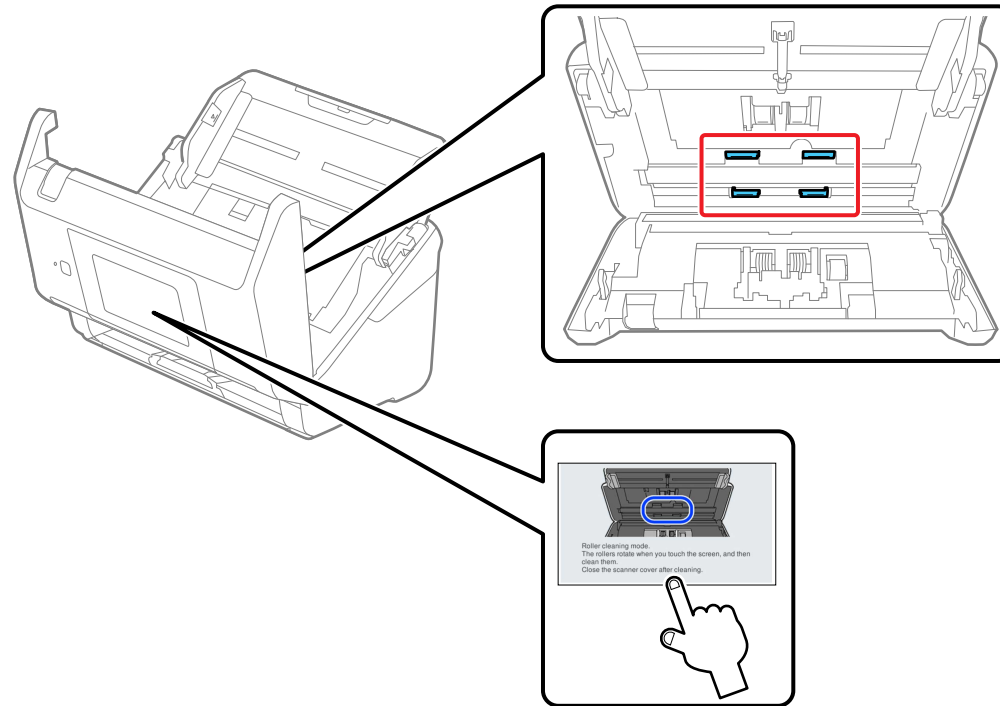

Caution: Be careful not to get your hands or hair caught in the rollers as they rotate.

24. Close the scanner cover.

Parent topic: [Cleaning and Transporting Your Scanner](#)



Related references

[User Replaceable Epson Scanner Parts](#)

Checking the Scanner Roller Counter

Check the scanner roller counter to determine when your rollers need to be replaced. When you replace the scanner rollers, reset the scanner roller counter so you know when you may need to replace the rollers again.

Note: To check the scanner roller counter from the scanner's control panel, select  home, if necessary, and select **Scanner Maintenance > Roller Replacement**.

1. Make sure the scanner is turned on and connected to your computer.
2. Do one of the following to open the Epson Scan 2 Utility:
 - **Windows 10:** Click  and select **EPSON > Epson Scan 2 Utility**.
 - **Windows 8.x:** Navigate to the **Apps** screen and select **Epson Scan 2 Utility**.
 - **Windows 7:** Click  > **All Programs > EPSON > Epson Scan 2 Utility**.
 - **Mac:** Open the **Applications** folder, click **Epson Software**, and click **Epson Scan 2 Utility**.
3. Click the **Counter** tab.

You see a screen like this:

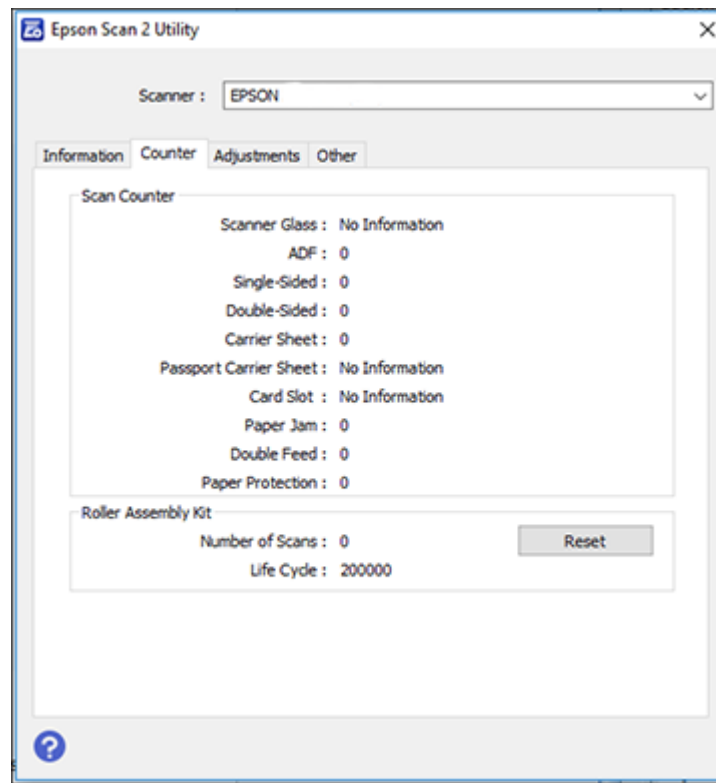

4. If the number in the **Number of Scans** field exceeds the number displayed as the **Life Cycle** of the rollers, it is time to replace the rollers.
5. Close the Epson Scan 2 Utility.

Parent topic: [Cleaning and Transporting Your Scanner](#)

Related tasks

[Changing Roller Replacement Alert Settings](#)

Replacing the Scanner Rollers

Replace the scanner rollers when the number of scans exceeds the life cycle of the rollers. Check the scanner roller counter to see when you need to replace the rollers.

Note: Frequent use of textured media may cause premature wear on the rollers. If frequent paper jams occur before the life cycle of the rollers is exceeded, try cleaning the rollers. In some cases, the rollers may need to be replaced before the number of scans exceeds the life cycle of the rollers.

1. Turn off the scanner.
2. Unplug the AC adapter.
3. Disconnect any connected cables.
4. Pull down on the cover open lever and open the scanner cover.

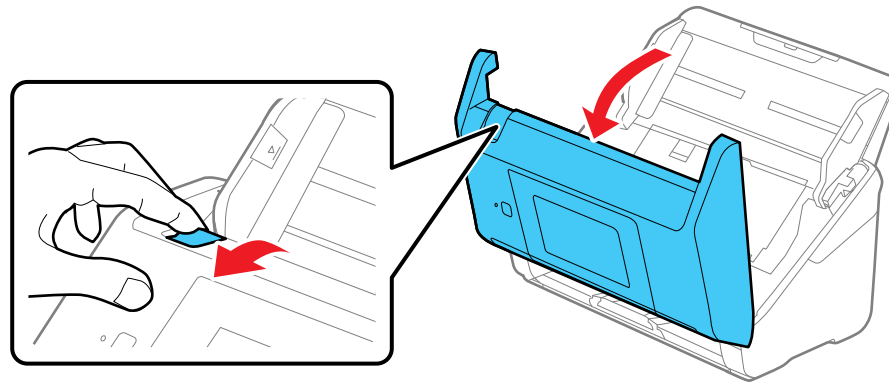

5. Press down on the pickup roller cover latch and pull up the cover to remove it.

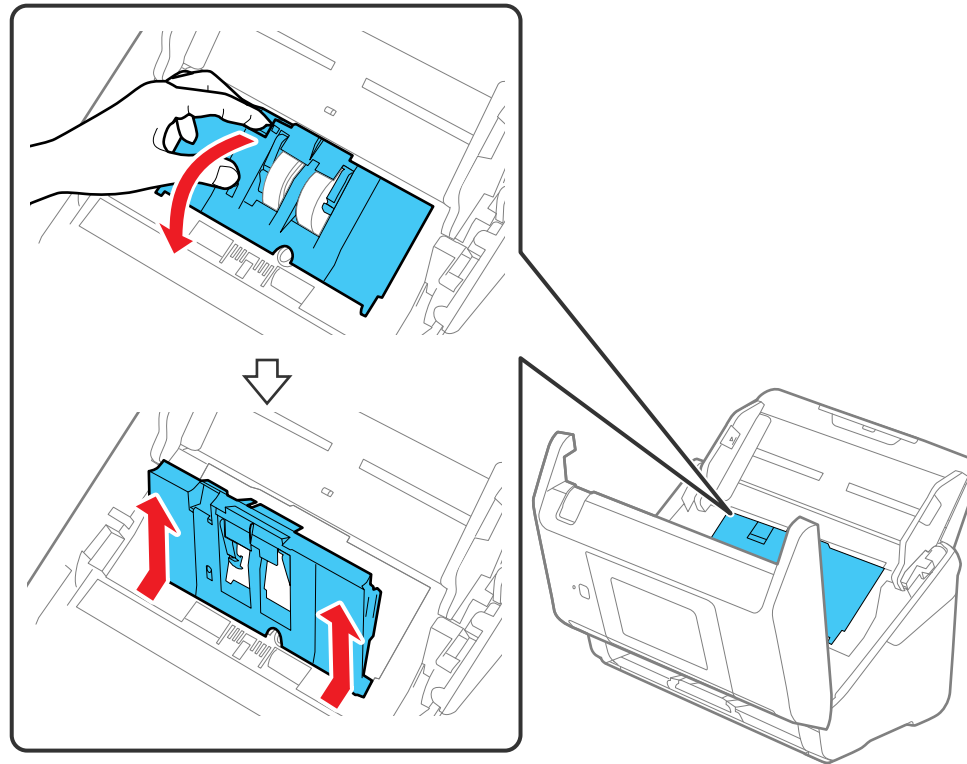

6. Pull down the tab on the pickup roller and slide the roller to the right to remove it.

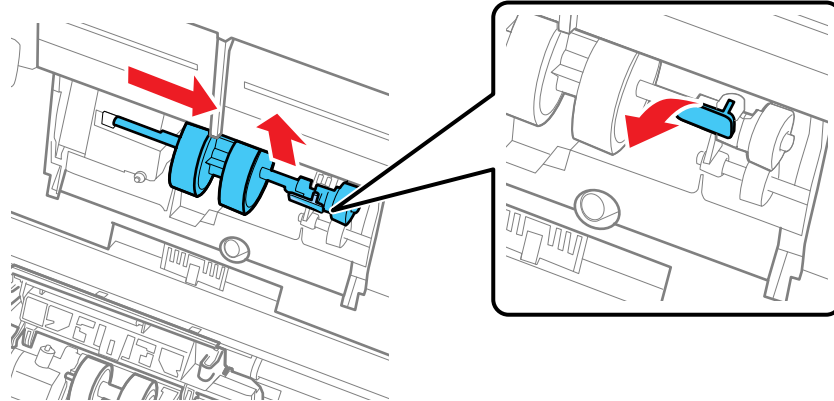

Note: Do not use force to pull out the pickup roller; doing so may damage the inside of the scanner.

7. To install the new pickup roller, align the notches on the roller unit and slide it to the left. Press up on the tab to secure the roller.

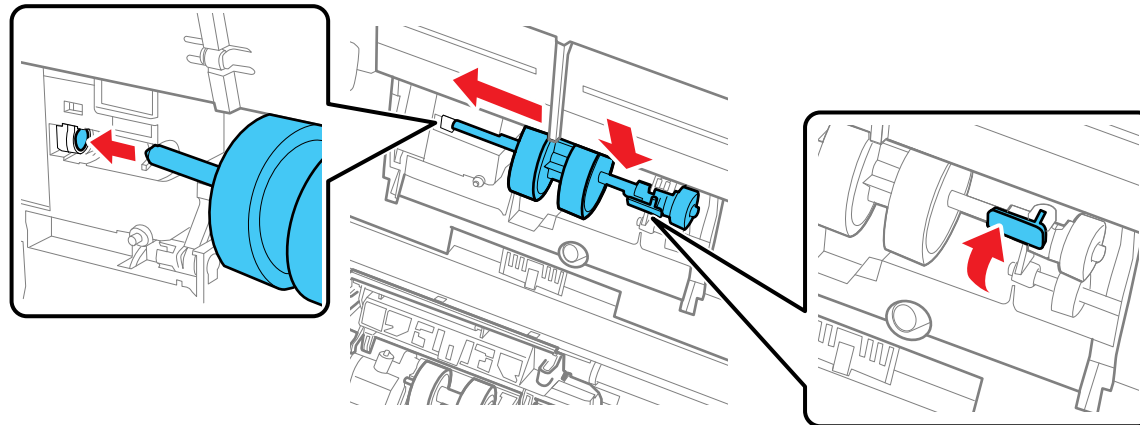

8. Align the bottom edge of the pickup roller cover into the notches as shown and press it down until it clicks into place.

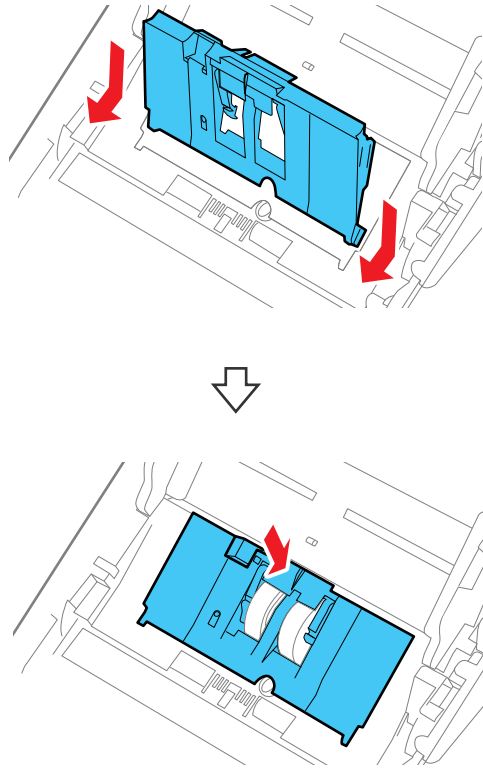

Note: If you are not able to close the cover, the pickup roller is not installed correctly. Remove the roller unit and reinstall it, then try to close the cover again.

9. Squeeze the tabs on the sides of the separation roller cover and open the cover.

Caution: Be careful not to apply too much force when opening the cover.

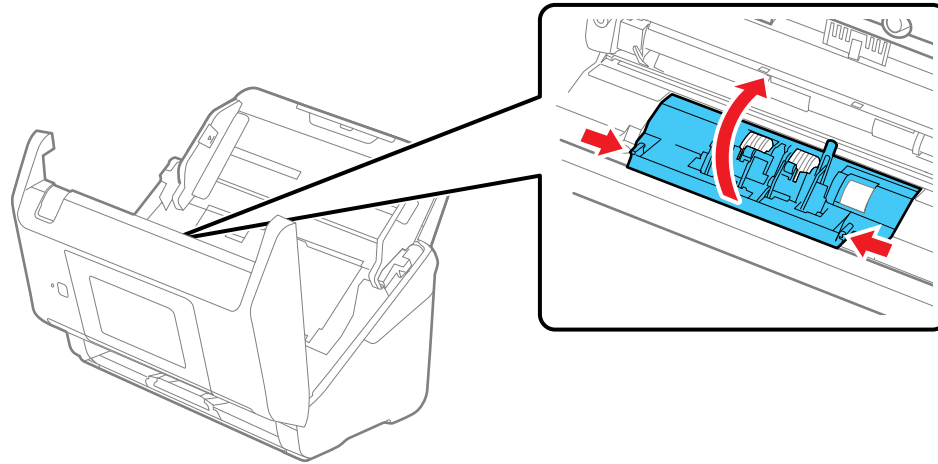

10. Slide the separation roller to the left and remove it.

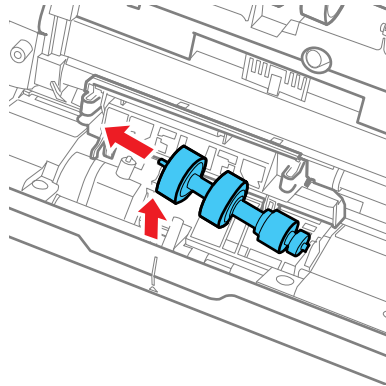

11. To install a new separation roller, insert the end of the roller into the hole on the right side and lower the other end of the roller into place.

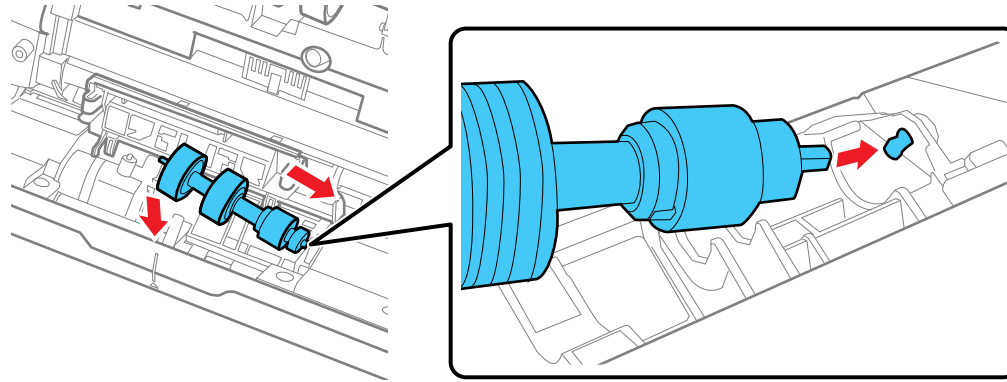

12. Close the separation roller cover until you hear it click into place.

Note: If you are not able to close the cover, the roller is not installed correctly. Remove the roller and reinstall it, then try to close the cover again.

13. Close the scanner cover.
14. Connect any disconnected cables.
15. Plug in the AC adapter and turn on the scanner.
16. Reset the roller counter.

Note: Make sure to dispose of the pickup roller and the separation roller following the rules and regulations of your local authority. Do not disassemble them.

[Resetting the Scanner Roller Counter](#)

Parent topic: [Cleaning and Transporting Your Scanner](#)

Related references

[User Replaceable Epson Scanner Parts](#)

Related tasks

[Checking the Scanner Roller Counter](#)

[Resetting the Scanner Roller Counter](#)

Resetting the Scanner Roller Counter

When you replace the scanner rollers, reset the scanner roller counter so you know when you may need to replace the rollers again.

1. Select  home, if necessary.
2. Do one of the following:
 - Select **Scanner Maintenance > Roller Replacement > Reset the Number of Scans > Number of Scans After Replacing Roller > Yes.**
 - Select **Settings > Device Settings > Reset the Number of Scans > Number of Scans After Replacing Roller > Yes.**

Note: You can also reset the roller counter from your computer using the Epson Scan 2 Utility. Select the **Counter** tab and click **Reset**.

Parent topic: [Replacing the Scanner Rollers](#)

Related tasks

[Checking the Scanner Roller Counter](#)

[Changing Roller Replacement Alert Settings](#)

Transporting Your Scanner

If you need to ship your product, transport it a long distance, or store it for an extended period, prepare it for transportation as described here.

1. Turn off the scanner and unplug the AC adapter.
2. Disconnect any connected cables.

3. Close the input tray extension and the output tray.

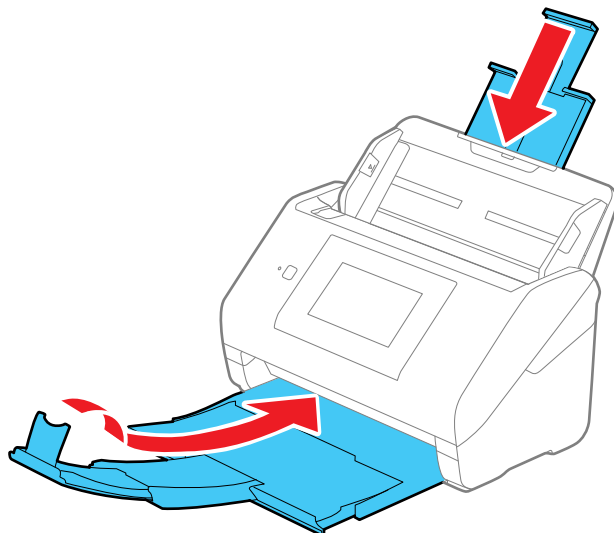

Note: Make sure the output tray is securely closed.

4. Push apart the latches on the back on the input tray and lift the input tray off of the scanner.

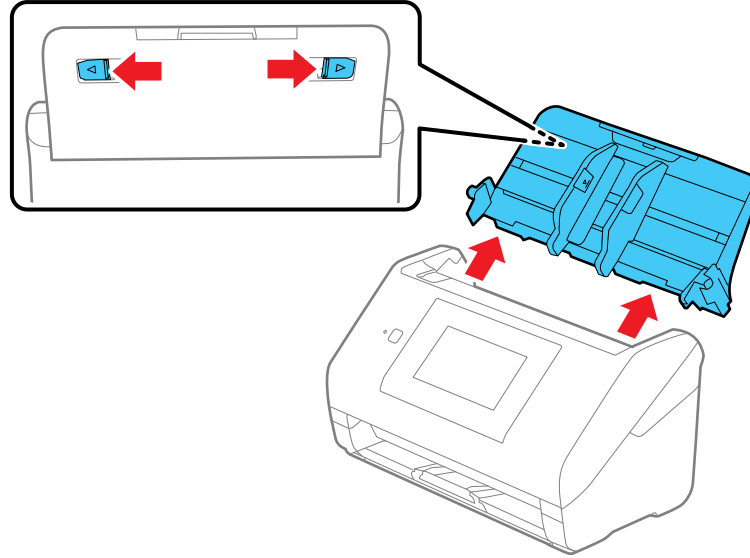

5. Place the scanner in its original packing materials, if possible, or use equivalent materials with cushioning around the product.

Parent topic: [Cleaning and Transporting Your Scanner](#)

Solving Problems

Check these sections for solutions to problems you may have using your product.

[Product Status Messages](#)

[Solving Scanning Problems](#)

[Solving Network Scanning Problems](#)

[Solving Scanned Image Quality Problems](#)

[Resetting the Epson Scan 2 Settings](#)

[Solving Invoice/Receipt Manager Problems](#)

[Uninstall Your Scanner Software](#)

[Where to Get Help \(U.S. and Canada\)](#)

[Where to Get Help \(Latin America\)](#)

Product Status Messages

You can often diagnose problems with your product by checking the messages on its LCD screen. You can also select the ⓘ help icon to see help information and how-to instructions on the screen.

LCD screen message	Condition/solution
Install the Epson ScanSmart software on the computer to use this feature. See your documentation for more details.	Epson ScanSmart did not launch. Make sure Epson ScanSmart is installed correctly and correct scanner is selected. If Epson ScanSmart is not installed, download the software from the Epson website and install it on your computer.

LCD screen message	Condition/solution
Check the following if a computer is not found. - Connection between the scanner and the computer (USB or network) - Installation of the necessary software - Power supply to the computer - Firewall and security software settings - Search again See your documentation for more details.	Make sure the scanner is connected correctly and the latest version of Epson ScanSmart is installed on your computer. Make sure the AC adapter is securely connected to the scanner and a working electrical outlet. Check the firewall settings for Epson software.
The combination of IP address and the subnet mask is invalid. See your documentation for more details.	There is a problem with the network connection to your product. Check the solutions in this guide.
Recovery Mode	A firmware update has failed. Connect your product using a USB cable and try updating the firmware again. If you still receive this error message, contact Epson for support.

Parent topic: [Solving Problems](#)

Related references

[Where to Get Help \(U.S. and Canada\)](#)

[Where to Get Help \(Latin America\)](#)

Related tasks

[Replacing the Scanner Rollers](#)

[Setting User Access Restrictions \(Access Control\)](#)

[Changing Regular Cleaning Alert Settings](#)

[Changing Roller Replacement Alert Settings](#)

[Cleaning Inside Your Scanner](#)

Related topics

[Loading Originals](#)

Solving Scanning Problems

Check these solutions if you have problems scanning with your product.

[Scanner Does Not Turn On or Turns Off Unexpectedly](#)

[Scanner Button Does Not Work as Expected](#)

[Scanning Software Does Not Operate Correctly](#)

[Original Feeds Incorrectly in Scanner](#)

[Original Jams in Scanner](#)

[Paper Protection Does Not Work Correctly](#)

[Scanning is Slow](#)

[Cannot Send Scans to a Cloud Service](#)

[Cannot Send Scans to an Email](#)

Parent topic: [Solving Problems](#)

Scanner Does Not Turn On or Turns Off Unexpectedly

If the scanner does not turn on or if it turns off unexpectedly, try these solutions:

- Make sure the AC adapter is securely connected to the scanner and to a working electrical outlet.
- If the scanner turns off unexpectedly, you may need to adjust the **Sleep Timer** and **Power Off Timer** settings on the control panel.

Parent topic: [Solving Scanning Problems](#)

Related tasks

[Changing the Sleep Timer Settings](#)

[Changing the Power Off Timer Settings](#)

Scanner Button Does Not Work as Expected

If the scanner button does not start the correct program or perform the correct action, try these solutions:

- If you installed the Epson ScanSmart software, pressing the  start button on your scanner starts Epson ScanSmart, over a USB or wireless connection. For instructions on scanning with Epson ScanSmart, see the help information in Epson ScanSmart.
- Make sure your scanner is turned on and any interface cables are securely connected at both ends.
- Check that the correct scanner is selected using the Epson Scan 2 Utility.
- In Windows, be sure that the scanner is listed under **Imaging Devices** in the Device Manager.

- Make sure you have assigned the correct job to the scanner button and change it, if necessary.
- Check the status of the lights and make sure the scanner is ready to scan.
- If you are connecting your scanner over a network, make sure the Wi-Fi connection is working correctly. Try turning the wireless router off and on again, and make sure the router cable is securely connected.
- If you are connecting your scanner via USB, use only the USB cable that came with the scanner. Make sure it is connected directly to your computer and not to a USB hub.
- For Wi-Fi scanning, confirm that your scanner is paired with your computer. Open Epson ScanSmart, click **Change** and select the scanner you want to use.
- Make sure your scanner is not connected to another computer via USB. A USB connection takes priority over a Wi-Fi connection.
- Make sure Epson ScanSmart and Epson Scan 2 are installed correctly. Reinstall the software, if necessary.

Parent topic: [Solving Scanning Problems](#)

Scanning Software Does Not Operate Correctly

If your scanning software does not operate correctly, try these solutions:

- Make sure your computer has adequate memory and meets the system requirements for your operating system.
- Make sure your computer is not running in a power-saving mode, such as sleep or standby. If so, wake your system and restart your scanning software.
- Make sure the scanner is turned on.
- Make sure the connection between the scanner and your computer is secure.
- If you upgraded your operating system but did not reinstall your scanning software, try reinstalling it.
- In Windows, be sure that the scanner is listed under **Imaging Devices** in the Device Manager.
- Make sure the scanning software is installed.
- Use the USB cable that came with the scanner.
- Connect the scanner directly to the computer. The scanner may not work properly when connected through a USB hub.
- If you are using a TWAIN-compliant program, make sure that the correct product is selected as the **Scanner** or **Source** setting.
- Make sure the **PC Connection via USB** setting is not disabled on the control panel.

- Check that the Wi-Fi connection is working correctly. Try turning the wireless router off and on.
- If your scanner is connected to one computer via USB and another computer via wireless connection, pressing the  start button on the scanner will save the scanned images to the computer connected via USB.
- Make sure another computer is not connected to the scanner using a USB cable. A USB connection takes priority over a Wi-Fi connection. If another computer is connected by USB, disconnect it.
- If you are using a Mac computer, make sure you select the network that has priority on it.

Parent topic: [Solving Scanning Problems](#)

Related concepts

[Uninstall Your Scanner Software](#)

Related references

[Windows System Requirements](#)

[Mac System Requirements](#)

Original Feeds Incorrectly in Scanner

If you have problems feeding originals in your scanner, try these solutions:

- If multiple pages feed at once, try the following:
 - Remove the originals, fan the edges to separate the sheets, if necessary, and reload them.
 - Load fewer originals at a time.
 - Load only originals that meet the specifications for your scanner.
 - Clean inside the scanner and replace the roller assembly kit, if necessary.
 - Check the pickup rollers and clean, if necessary.
 - Select  on the scanner control panel to slow down the scanning speed.
 - Use **Automatic Feeding Mode** in Epson Scan 2 and scan originals one at a time.
 - Use the optional carrier sheet for thin, folded, or irregularly shaped originals.

Parent topic: [Solving Scanning Problems](#)

Related references

[Original Document Specifications](#)

[Plastic and Laminated Card Specifications](#)

[Special Original Specifications](#)

[User Replaceable Epson Scanner Parts](#)

Related tasks

[Cleaning Inside Your Scanner](#)

Related topics

[Loading Originals](#)

Original Jams in Scanner

If an original has jammed inside the scanner, follow these steps:

Note: Epson Smart Panel does not support scanning originals more than 15.5 inches (398.3 mm) in length.

1. Turn off your scanner.
2. Remove all originals from the input tray.
3. Pull down the cover open lever and open the scanner cover.

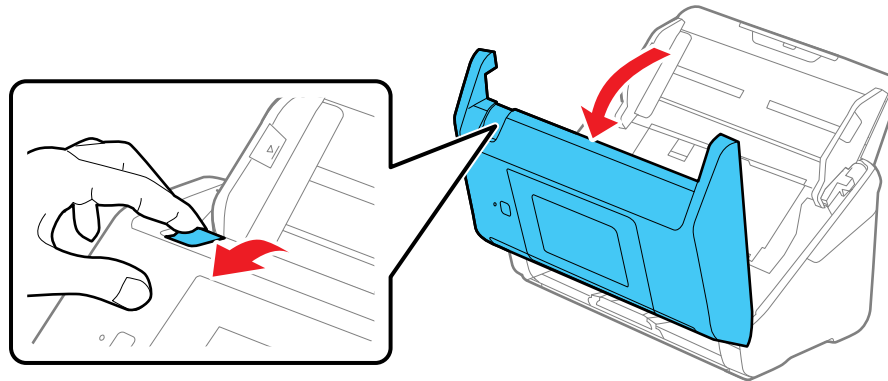

4. Gently pull out any jammed originals from inside the scanner.

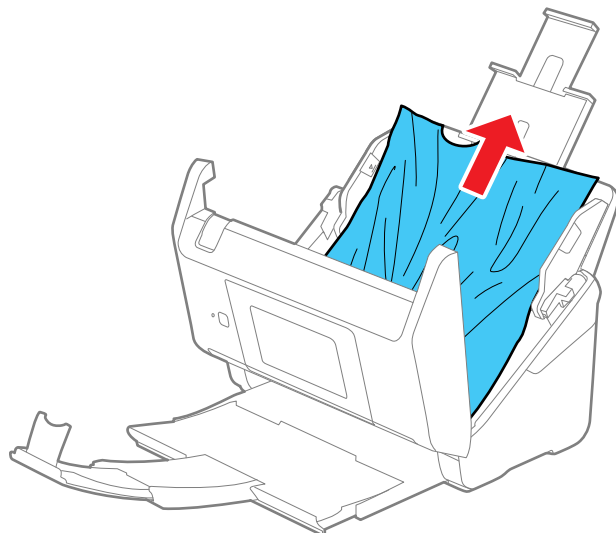

5. Gently pull out any jammed originals from the output tray.

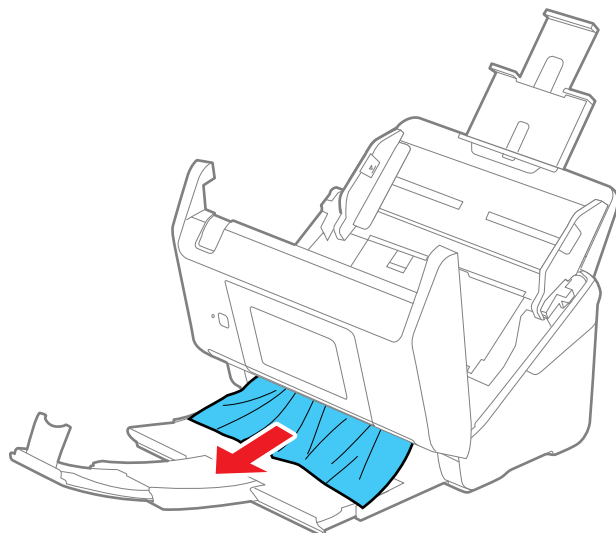

6. Close the scanner cover.
7. Carefully follow all loading instructions when you reload originals.

If originals jam in the scanner frequently, try the following:

- Select  on the scanner control panel to slow down the scanning speed.
- Turn off the **Detect Double Feed** setting.
- Clean inside the scanner and clean the rollers.
- Close the output tray and let the originals fall freely onto the surface below the scanner.
- If the roller counter is nearing end of life, replace the roller assembly kit.

Parent topic: [Solving Scanning Problems](#)

Related references

[Original Document Specifications](#)

[Plastic and Laminated Card Specifications](#)

[Special Original Specifications](#)

[Where to Get Help \(U.S. and Canada\)](#)

[Where to Get Help \(Latin America\)](#)

Related tasks

[Cleaning Inside Your Scanner](#)

Related topics

[Loading Originals](#)

Paper Protection Does Not Work Correctly

To reduce damage to the original, the Paper Protection feature immediately stops scanning if a paper feed error is detected. If the Paper Protection feature does not work correctly, try these solutions:

- If your scanned original is damaged, make sure that the Paper Protection feature is enabled. Increase the detection level, if necessary.
- If misdetection occurs frequently, lower the Paper Protection detection level .
- Set the Paper Protection feature to **Off** on the LCD screen (**Settings > Scanner Settings > Paper Protection > Off**) when scanning plastic cards and thick originals.
- When scanning multiple originals, make sure that the leading edges of the documents are aligned. If the leading edges of the documents are not aligned, they may be mistakenly detected as a paper feed error even if they are scanned correctly.

- Make sure you align the edge guides with the original to avoid scanning at an angle.

Parent topic: [Solving Scanning Problems](#)

Scanning is Slow

If scanning becomes slow, try these solutions:

- Scan your original at a lower resolution, if possible.
- Make sure your system meets the requirements for your operating system. If you are scanning a high-resolution image, you may need more than the minimum requirements. If necessary, increase your system's memory or reduce the resolution.
- The scanning speed may be reduced depending on the image adjustment features in Epson Scan 2.
- If scanning becomes slower after scanning continuously with the ADF for a long time, the scanner may have automatically slowed down to protect the scanner mechanism from overheating or becoming damaged. Let the scanner rest with the power on for 30 minutes, then try scanning again.
- Make sure the  slow mode setting is turned off on the scanner control panel.
- If you are running virus protection or other security software, exclude the TWAIN.log files from monitoring or set the TWAIN.log file as read only. See your virus protection or security software instructions for details. The TWAIN.log file is saved in C:\Users*(user name)*\AppData\Local\Temp.

Note: You may need to unhide system folders to view files in that location.

- If you are scanning over a network, factors such as interference, network traffic, or weak signal strength may affect your scanning speed.
- Computers with USB 3.0 (SuperSpeed) or USB 2.0 (Hi-Speed) ports can scan faster than those with USB 1.1 ports. If you are using a USB 3.0 or 2.0 port with the scanner, make sure it meets the system requirements.

Parent topic: [Solving Scanning Problems](#)

Related references

[Windows System Requirements](#)

[Mac System Requirements](#)

Cannot Send Scans to a Cloud Service

If you cannot send a scan to a cloud service, try these solutions:

- Make sure your computer is connected to the internet.

- Make sure the login information you entered for the cloud service is correct.
- Make sure the cloud service is not down for system maintenance. Check the cloud service website for more information.

Parent topic: [Solving Scanning Problems](#)

Cannot Send Scans to an Email

If you cannot send a scan to an email address, try these solutions:

- Make sure the destination email address is working.
- Make the email server settings are correct.
- Contact the email server administrator to make sure the server is running.

Parent topic: [Solving Scanning Problems](#)

Solving Network Scanning Problems

Check these solutions if you have problems scanning over a network.



[Cannot Scan Over a Network](#)

[Scanner Cannot Connect to a Wireless Router](#)

Parent topic: [Solving Problems](#)

Cannot Scan Over a Network

If you have problems scanning over a network, try these solutions:

- Check the scanner's control panel for error messages. If you have the notification email set when the events occur, you can promptly learn the status.
- Make sure the computer and scanner are connected to the same network (or network subnet/VLAN).
- Move the scanner and computer or smart device closer to the access point.
- If you cannot scan from the  start button on the scanner, make sure you restarted your computer after installing the scanning software. Also start Epson Scan 2 before scanning with the  start button.
- If you installed the Epson ScanSmart software, pressing the  start button on your scanner starts Epson ScanSmart instead, via a USB or wireless connection. For instructions on scanning with Epson ScanSmart, see the help information in Epson ScanSmart.
- If you are scanning a large original at a high resolution, a network communication error may occur. Try scanning again at a lower resolution.

- If network communication was interrupted while starting Epson Scan 2 or Epson ScanSmart, exit Epson Scan 2 or Epson ScanSmart, wait a few seconds, and restart the program. If Epson Scan 2 or Epson ScanSmart cannot restart, turn off your scanner, turn it back on, and try starting Epson Scan 2 or Epson ScanSmart again.
- Check the network connection setting in the Epson Scan 2 Utility.
- You may need to disable the firewall and any anti-virus software on your wireless router or access point.
- If you see the message "Network product is not available: currently being used by user", there may be a communication error between the scanner and computer. Restart the scanner.
- Epson Scan 2 does not support networks that use only IPv6. Use Epson Scan 2 on a network that supports IPv4.
- If the Firewall function is active, the scanner may not be discovered by the Epson Scan 2 Utility. Open the Epson Scan 2 Utility, enter the IP address for your scanner, and click **Add**.
- If the scanner and computer cannot communicate and are connected to the same network (subnet or VLAN), check if your router uses the privacy separator and disable it, if necessary. Follow the instructions in your router documentation to disable the privacy separator.

Parent topic: [Solving Network Scanning Problems](#)

Related topics

[Wi-Fi Networking](#)

Scanner Cannot Connect to a Wireless Router

If your scanner has trouble finding or connecting to a wireless router, try these solutions:

- If you are connecting the scanner via Wi-Fi Protected Setup (WPS), make sure you activate WPS on your scanner within 2 minutes of activating WPS discovery mode on the router by pressing the WPS button or enabling the WPS setting in your router firmware.
- Make sure to place your scanner within contact range of your router. Avoid placing your scanner near a microwave oven, 2.4 GHz cordless phone, or large metal object, such as a filing cabinet.
- Verify that your router is operating correctly by connecting to it from your computer or another device.
- You may need to temporarily disable your firewall and any anti-virus software on your wireless router. Then try scanning again. You can also unblock your scanner driver or network address in your firewall or anti-virus software.
- Check to see if access restrictions, such as MAC address filtering, are set on the router. If access restrictions are set, add your scanner's MAC address to your router's address list. To obtain your

scanner's MAC address, check the label on the back or bottom of your scanner. Then follow the instructions in your router documentation to add the address to the list.

- If your router does not broadcast its network name (SSID), follow the instructions that came with your scanner to enter your wireless network name manually.
- If your router has security enabled, determine the kind of security it is using and any required password or passphrase for connection. Then make sure to enter the exact WEP key or WPA passphrase correctly.
- Check if your computer is restricting the available wireless channels. If so, verify that your wireless access point is using one of the usable channels and change to a usable channel, if necessary.
- The scanner may not be able to communicate with a computer with both Ethernet and Wi-Fi adapters enabled. Disable all network interfaces except for the interface connected to the scanner.
- Enable the DHCP function on the access point or router.
- Check that the scanner's IP address is set correctly.
- Make sure Epson ScanSmart is installed.
- If you cannot start scanning from a smart device, make sure the scanner and smart device are connected correctly. Use the Epson Smart Panel to check the connection status for the smart device and the scanner.

Parent topic: [Solving Network Scanning Problems](#)

Related topics

[Wi-Fi Networking](#)

Solving Scanned Image Quality Problems

Check these sections if a scanned image on your computer screen has a quality problem.

Note: For solutions when using the Epson ScanSmart software, see the Epson ScanSmart help utility.

[Back of Original Image Appears in Scanned Image](#)

[Scanned Characters are Blurry](#)

[Characters are not Recognized During Conversion to Editable Text \(OCR\)](#)

[Ripple Patterns Appear in an Image](#)

[Spots or Lines Appear in All Scanned Images](#)

[Scanned Image is Cropped](#)

Parent topic: [Solving Problems](#)

Back of Original Image Appears in Scanned Image

If an image from the back of a thin original appears in your scanned image, make sure you selected the correct Image Type setting for your original and select the **Text Enhancement** setting in Epson Scan 2. You can also select the **Remove Background** setting in Epson Scan 2.

Note: If you select **Color** as the Image Type setting, you can change the level from Standard to High to remove more of the background.

If the image is still visible, you can also try setting a lower level for **Edge Enhancement** or a higher level for **Noise Reduction**.

Parent topic: [Solving Scanned Image Quality Problems](#)

Related tasks

[Scanning a Document in Epson ScanSmart](#)

[Changing the Scan Settings](#)

Scanned Characters are Blurry

If characters in your scanned images are blurry, try these solutions:

- Make sure you do not move the scanner or original while scanning.
- Operate the scanner on a flat, stable surface.
- Adjust these Epson Scan 2 settings (if available) and try scanning again:
 - Select the **Text Enhancement** setting.
 - If the **Image Type** setting is **Black & White**, adjust the **Threshold** setting or change the **Edge Enhancement** and **Noise Reduction Level** settings.
 - Increase the **Resolution** setting.
 - Set the **Image Type** to **Grayscale**.
 - If you are scanning in JPEG format, change the compression level. Click **Options** in the Image Format menu and change the **Image Quality** setting.

Parent topic: [Solving Scanned Image Quality Problems](#)

Related tasks

[Scanning a Document in Epson ScanSmart](#)

[Changing the Scan Settings](#)

Characters are not Recognized During Conversion to Editable Text (OCR)

If characters in your scanned images are not recognized during OCR conversion, try these solutions:

- Make sure your original is loaded straight on your product.
- Use an original with clear text.
- Adjust these Epson Scan 2 settings (if available) and try scanning again:
 - Select the correct **Image Type** setting.
 - Select or adjust the **Text Enhancement** setting.
 - If the **Image Type** is set to **Black & White**, adjust the **Threshold** setting.
 - Set the **Image Type** to **Grayscale**.
- Set the scanning resolution between 200 and 600 dpi.
- If the original document is in landscape mode, set the **Rotate** setting to **Auto** in Epson Scan 2.
- If you are using OCR software, check the manual for any additional adjustments.
- Scan thermal paper receipts as soon as possible. They may deteriorate due to age or friction.
- When saving to Microsoft Office or Searchable PDF files, check that the correct languages are selected. Check the language in each save setting window.

Parent topic: [Solving Scanned Image Quality Problems](#)

Related tasks

[Scanning a Document in Epson ScanSmart](#)

[Changing the Scan Settings](#)

Ripple Patterns Appear in an Image

You may see a ripple pattern (called a moiré) in scanned images of printed documents. This is caused by interference from differing pitches in the scanner's screen and your original's halftone screen. To reduce this effect, adjust these Epson Scan settings (if available) and try scanning again:

- Select the **Descreening** setting.
- Select a lower **Resolution** setting.

Parent topic: [Solving Scanned Image Quality Problems](#)

Related tasks

[Scanning a Document in Epson ScanSmart](#)

Spots or Lines Appear in All Scanned Images

If spots or lines appear in all your scanned images, try the following solutions:

- Clean the rollers and glass scanning surfaces inside your scanner using a genuine Epson cleaning kit or a soft, moist cloth.
- Remove any dirt from your original.
- Enable the **Detect Glass Dirt** setting in the Epson Scan 2 Utility.

Note: If glass dirt detection does not work correctly, adjust the setting. If the glass dirt alert screen appears after cleaning the inside of the scanner, check the glass surface again (scratches on the glass may be detected as a glass dirt).

Parent topic: [Solving Scanned Image Quality Problems](#)

Related tasks

[Cleaning Inside Your Scanner](#)

Scanned Image is Cropped

If the edges of a scanned image are cropped, try the following solutions:

- Select **Auto Detect** as the Document Size setting in Epson Scan 2.
- If the document size is not detected correctly using the **Auto Detect** setting, select the size of your original from the **Document Size** list.

Note: If the size you want to scan is not on the list, select **Customize** to create it manually (Windows only).

- In Epson Scan 2, select the **Main Settings** tab. Select **Document Size > Settings** and adjust the cropping area shown in the **Crop Margins for Size "Auto"** setting.
- In Epson Scan 2, select the **Advanced Settings** tab. Make sure the **Edge Fill** setting is set to **None**.



Parent topic: [Solving Scanned Image Quality Problems](#)

Related tasks

[Scanning a Document in Epson ScanSmart](#)

Resetting the Epson Scan 2 Settings

If you continue to experience image quality problems after trying all possible solutions, you may need to reset the Epson Scan 2 settings using the Epson Scan 2 Utility.

1. Do one of the following to start the Epson Scan 2 Utility:
 - **Windows 10:** Click  > **EPSON** > **Epson Scan 2 Utility**.
 - **Windows 8.x:** Navigate to the **Apps** screen and select **Epson Scan 2 Utility**.
 - **Windows 7:** Click , and select **All Programs**. Select **EPSON** > **Epson Scan 2** > **Epson Scan 2 Utility**.
 - **Mac:** Open the **Applications** folder, open the **Epson Software** folder, and select **Epson Scan 2 Utility**.
2. Click the **Other** tab.
3. Click **Reset** and confirm your choice.

Note: If resetting the Epson Scan 2 settings does not solve your problem, uninstall your scanner software and re-install it.

Parent topic: [Solving Problems](#)

Related concepts

[Uninstall Your Scanner Software](#)

Solving Invoice/Receipt Manager Problems

Check the solutions in these sections if you have problems scanning using Invoice/Receipt Manager.

[Cannot Access an Accounting Service](#)

[Cannot Import Invoice/Receipt Database](#)

[License Key is Disabled](#)

Parent topic: [Solving Problems](#)

Cannot Access an Accounting Service

If you cannot access an accounting service, try these solutions:

- Make sure the login information you entered for the accounting service is correct.

- Make sure the accounting service is not down for system maintenance. Check the accounting service website for more information.
- Make sure the desktop accounting service and its company file are opened on your computer.

Parent topic: [Solving Invoice/Receipt Manager Problems](#)

Cannot Import Invoice/Receipt Database

If you cannot import an invoice/receipt database, make sure the Epson ScanSmart software version installed on your computer is up to date. Run Epson Software Updater or visit the Epson support website for your product.

Parent topic: [Solving Invoice/Receipt Manager Problems](#)

License Key is Disabled

If you have problems entering a license key, try these solutions:

- Make sure the license key is valid and correctly entered.
- The license key is only available for one scanner. Make sure you selected the correct scanner.
- If you need to replace your scanner under warranty, Epson can issue you a new license key. Contact Epson Support if you have trouble with the new license key.

Parent topic: [Solving Invoice/Receipt Manager Problems](#)

Related tasks

[Changing the Epson Product](#)

Uninstall Your Scanner Software

If you have a problem that requires you to uninstall and re-install your software, follow the instructions for your operating system.

[Uninstalling Scanner Software - Windows](#)



[Uninstalling Scanner Software - Mac](#)

Parent topic: [Solving Problems](#)

Uninstalling Scanner Software - Windows

You can uninstall and then re-install your scanner software to solve certain problems.

1. Exit all applications currently running on your computer.
2. Turn off the scanner.

3. Disconnect any interface cables.
4. Do the following to uninstall each of your scanning software programs and follow any on-screen instructions:
 - **Windows 10:** Click  and select  (Settings) > **Apps** > **Apps & features**. Select the scanner software program and click **Uninstall**.
 - **Windows 8.x:** Navigate to the **Apps** screen and select **Control Panel** > **Programs** > **Programs and Features**. Select the scanner software program and click **Uninstall/Change**.
 - **Windows 7:** Open the Windows **Control Panel** utility. Select **Programs and Features**. (In Classic view, select **Programs** and click **Uninstall a program**.) Select the scanner software program and click **Uninstall/Change**.
5. Restart your computer, then see the *Start Here* sheet to re-install your software.

Note: If you find that re-installing your scanner software does not solve a problem, contact Epson.

Parent topic: [Uninstall Your Scanner Software](#)

Uninstalling Scanner Software - Mac

In most cases, you do not need to uninstall your scanner software before re-installing it. However, you can download the Uninstaller utility from the Epson support website to uninstall your scanner software as described here.

1. To download the Uninstaller utility, visit epson.com/support (U.S.), epson.ca/support (Canada), or latin.epson.com/support (Caribbean) and select your product.
2. Follow the instructions on the screen to install the Uninstaller utility.
3. Quit all applications currently running on your Mac.
4. Double-click the **Uninstaller** icon.
5. In the Epson Uninstaller screen, select the checkbox for each software program you want to uninstall.
6. Click **Uninstall**.
7. Follow the on-screen instructions to uninstall the software.
8. To reinstall your scanner software, see the *Start Here* sheet for instructions.

Note: If you find that re-installing your scanner software does not solve a problem, contact Epson.

Parent topic: [Uninstall Your Scanner Software](#)

Where to Get Help (U.S. and Canada)

If you need to contact Epson for technical support services, use the following support options.

Internet Support

Visit Epson's support website at epson.com/support (U.S.) or epson.ca/support (Canada) and select your product for solutions to common problems with your product. You can download utilities and documentation, get FAQs and troubleshooting advice, or e-mail Epson with your questions.

Speak to a Support Representative

Before you call Epson for support, please have the following information ready:

- Product name
- Product serial number (located on a label on the product)
- Proof of purchase (such as a store receipt) and date of purchase
- Computer configuration
- Description of the problem

Then call:

- U.S.: (562) 276-4382, 6 AM to 8 PM, Pacific Time, Monday through Friday, and 7 AM to 4 PM, Pacific Time, Saturday
- Canada: (905) 709-3839, 6 AM to 8 PM, Pacific Time, Monday through Friday, and 7 AM to 4 PM, Pacific Time, Saturday

Days and hours of support are subject to change without notice. Toll or long distance charges may apply.

Note: For help using any other software on your system, see the documentation for that software for technical support.

Purchase Supplies and Accessories

You can purchase genuine Epson accessories at epson.com (U.S. sales) or epson.ca (Canadian sales). You can also purchase accessories from an Epson authorized reseller. To find the nearest one, call 800-GO-EPSON (800-463-7766) in the U.S. or 800-807-7766 in Canada.

Parent topic: [Solving Problems](#)

Where to Get Help (Latin America)

If you need to contact Epson for technical support services, use the following support options.

Internet Support

Visit Epson's support website at latin.epson.com/support and select your product for solutions to common problems with your product. You can download utilities and documentation, get FAQs and troubleshooting advice, or e-mail Epson with your questions.

Speak to a Support Representative

Before you call Epson for support, please have the following information ready:

- Product name
- Product serial number (located on a label on the product)
- Proof of purchase (such as a store receipt) and date of purchase
- Computer configuration
- Description of the problem

Then call:

Country	Telephone
Argentina	(54 11) 5167-0300 0800-288-37766
Bolivia*	800-100-116
Brazil	State capitals and metropolitan areas: 3004-6627 Other areas: 0800-377-6627 / 0800-EPSONBR
Chile	(56 2) 2484-3400
Colombia	Bogota: (57 1) 592-2200 Other cities: 018000-915235
Costa Rica	800-377-6627
Ecuador*	1-800-000-044
El Salvador*	800-6570
Guatemala*	1-800-835-0358

Country	Telephone
Mexico	Mexico City: (52 55) 1323-2052 Other cities: 01-800-087-1080
Nicaragua*	00-1-800-226-0368
Panama*	00-800-052-1376
Paraguay	009-800-521-0019
Peru	Lima: (51 1) 418-0210 Other cities: 0800-10-126
Uruguay	00040-5210067
Venezuela	(58 212) 240-1111

* Contact your local phone company to call this toll-free number from a mobile phone.

If your country does not appear in the list, contact the sales office in the nearest country. Toll or long distance charges may apply.

Note: For help using any other software on your system, see the documentation for that software for technical support.

Purchase Supplies and Accessories

You can purchase genuine Epson accessories from an Epson authorized reseller. To find the nearest reseller, visit latin.epson.com or call your nearest Epson sales office.

Parent topic: [Solving Problems](#)

Technical Specifications

These sections list the technical specifications for your scanner.

Note: Epson offers a recycling program for end of life Epson products. Please go to [this site](#) (U.S) or [this site](#) (Canada) for information on how to return your Epson products for proper disposal.

[Windows System Requirements](#)

[Mac System Requirements](#)

[General Specifications](#)

[Dimension Specifications](#)

[Electrical Specifications](#)

[Environmental Specifications](#)

[Network Interface Specifications](#)

[Safety and Approvals Specifications](#)

Windows System Requirements

To use your product and its software, your computer should use one of these Microsoft operating systems:

- Windows 10
- Windows 8.x
- Windows 7

Note: For the latest product software available for your operating system, visit the Epson support site at [epson.com/support](#) (U.S.), [epson.ca/support](#) (Canada), or [latin.epson.com/support](#) (Caribbean), select your product, and select **Downloads**.

Parent topic: [Technical Specifications](#)

Mac System Requirements

To use your product and its software, your Mac should use one of these operating systems:

- macOS 11.x
- macOS 10.15.x

- macOS 10.14.x
- macOS 10.13.x
- macOS 10.12.x
- OS X 10.11.x

Note: The UNIX File System (UFS) for OS X and Fast User Switching on OS X is not supported.

For the latest product software available for your operating system, visit the Epson support site at epson.com/support (U.S.), epson.ca/support (Canada), or latin.epson.com/support (Caribbean), select your product, and select **Downloads**.

Parent topic: [Technical Specifications](#)

General Specifications

Scanner type	Sheet feed, one pass duplex, color
Photoelectric device	CIS
Effective pixels	5100 × 9300 pixels at 600 dpi 2550 × 64,500 pixels at 300 dpi
Document size	Maximum: 8.5 × 240 inches (215.9 × 6096 mm) Minimum: 2 × 2 inches (50.8 × 50.8 mm)
Paper input	Facedown loading
Paper output	Facedown ejection
Paper capacity	100 sheets of paper at 21 lb (80 g/m ²) weight
Scanning resolution	600 dpi (main scan) 600 dpi (sub scan)
Output resolution	50 to 1200 dpi in 1 dpi increments 53 inches (1346.0 mm) or less: up to 600 dpi 215 inches (5461.0 mm) or less: up to 300 dpi 240 inches (6096.0 mm) or less: up to 200 dpi

Color Depth	Color: 30 bits per pixel internal (10 bits per pixel per color) 24 bits per pixel external (8 bits per pixel per color) Grayscale: 10 bits per pixel internal 8 bits per pixel external Black-and-white: 10 bits per pixel internal 1 bit per pixel external
Interface	SuperSpeed USB 3.0 (backward-compatible with USB 1.1) IEEE802.11b/g/n
Light source	RGB LED

Parent topic: [Technical Specifications](#)

Dimension Specifications

Height	6.6 inches (167 mm)
Width	11.7 inches (296 mm)
Depth	6.7 inches (169 mm)
Weight	8.2 lb (3.7 kg)

Note: Dimensions do not include projecting parts.

Parent topic: [Technical Specifications](#)

Electrical Specifications

Scanner

Note: Check the label on the scanner and the AC adapter for voltage information. Power consumption varies depending on operating conditions or whether an option is installed.

Rated DC input power supply voltage	DC 24 V
Rated DC input current	1 A
Power consumption	Operating: 13 W (approximate) Ready mode: 6.7 W (approximate) Sleep mode: 1.0 W (approximate) Power off mode: 0.1 W (approximate) Wi-Fi Connection: Operating: 13 W (approximate) Ready mode: 6.9 W (approximate) Sleep mode: 1.4 W (approximate) Power off mode: 0.1 W (approximate)

AC Adapter

AC adapter model	100 to 240 V model: A461H
Rated input current	1 A
Rated frequency range	50 to 60 Hz
Rated output power supply voltage	DC 24 V
Rated output current	1 A

Parent topic: [Technical Specifications](#)

Environmental Specifications

Temperature	Operating: 41 to 95 °F (5 to 35 °C) Storage: –13 to 140 °F (–25 to 60 °C)
Humidity (non-condensing)	Operating: 15 to 80% RH Storage: 15 to 85% RH
Operating conditions	Ordinary office or home conditions

Note: Avoid operating the scanner in direct sunlight, near a strong light source, or in extremely dusty conditions.

Parent topic: [Technical Specifications](#)

Network Interface Specifications

Wi-Fi

Standards	IEEE802.11a/b/g/n/ac; IEEE802.11n available only on the 20 MHz channel
Frequency ranges	IEEE802.11b/g/n: 2.4 GHz IEEE802.11a/n/ac: 5 GHz
Wi-Fi channels	2.4 GHz: 1/2/3/4/5/6/7/8/9/10/11 5 GHz: W52 (36/40/44/48) W53 (52/56/60/64) W56 (100/104/108/112/116/132/136/140) W58 (149/153/157/161/165)
Connection modes	Infrastructure mode Wi-Fi Direct (Simple AP); not supported for IEEE802.11b Note: Infrastructure and Wi-Fi Direct modes can be used simultaneously.
Maximum radio frequency power transmitted	20 dBm (EIRP)

Wireless security protocols

WEP (64/128 bit)

WPA2-PSK (AES); complies with WPA2 standards with support for WPA/WPA2 Personal

WPA3-SAE (AES)

WPA2/WPA3-Enterprise; WPA2 compliant with support for WPA/WPA2 Enterprise

Note: Wi-Fi Direct supports only WPA2-PSK (AES).**Security Protocol**

SSL/TLS

HTTPS (Server/Client)

SMTPS (Client)

STARTTLS

SNMPv3

MIB accessing
Authentication/Encryption

SNMPv3

Parent topic: [Technical Specifications](#)**Safety and Approvals Specifications****Scanner****United States**

EMC: FCC part 15 Subpart B class B

Canada

EMC: CAN ICES-3 (B)/NMB-3 (B)

AC Adapter (A461H)**United States**

Safety: UL60950-1

EMC: FCC part 15 Subpart B class B

Canada

Safety: CAN/CSA C22.2 No. 60950-1

EMC: CAN ICES-3 (B)/NMB-3 (B)

This equipment contains the following wireless module:

- Manufacturer: Seiko Epson Corporation.
- Type: J26H005

This product conforms to Part 15 of the FCC Rules and RSS-210 of the IC Rules. Epson cannot accept responsibility for any failure to satisfy the protection requirements resulting from a non-recommended modification of the product. Operation is subject to the following two conditions: (1) this device may not cause harmful interference, and (2) this device must accept any interference received, including interference that may cause undesired operation of the device.

To prevent radio interference to the licensed service, this device is intended to be operated indoors and away from windows to provide maximum shielding. Equipment (or its transmit antenna) that is installed outdoors is subject to licensing.

This equipment complies with FCC/IC radiation exposure limits set forth for an uncontrolled environment and meets the FCC radio frequency (RF) Exposure Guidelines in Supplement C to OET65 and RSS-102 of the IC radio frequency (RF) Exposure rules. This equipment should be installed and operated so that the radiator is kept at least 7.9 inches (20 cm) or more away from a person's body (excluding extremities: hands, wrists, feet and ankles).

Notice for Mexico

Operation is subject to the following two conditions: (1) this device may not cause harmful interference, and (2) this device must accept any interference received, including interference that may cause undesired operation of the device.

Product model: J382C (ES-580W)

Brand: EPSON

IFT Certification Number: RCPEPJ219-2102

Notice for Paraguay

Imported by:

Fastrax, S.A.

Av. Perú esq. Río de Janeiro, Barrio Las Mercedes, Asunción, Paraguay

Imported by:

Sol Control S.R.L.

Av. Gral. Bernardino Caballero 810 esq. Celsa Speratti, Asunción, Paraguay

Notice for Peru

Product Model: J382C (ES-580W)

Brand: EPSON

This product uses the following WLAN module:

WLAN Module Model: J26H005

FCC ID: BKMFBJ26H005

Product Manufacturer: Seiko Epson Corporation

Address: 3-3-5 Owa Suwa-shi, Nagano-Ken 392-8502, Japan

Parent topic: [Technical Specifications](#)

Notices

Check these sections for important notices about your scanner.

Note: Epson offers a recycling program for end of life Epson products. Please go to [this site](#) (U.S) or [this site](#) (Canada) for information on how to return your Epson products for proper disposal.

[Important Safety Instructions](#)

[Restrictions on Copying](#)

[Default Delay Times for Power Management for Epson Products](#)

[Binding Arbitration and Class Waiver](#)

[Trademarks](#)

[Copyright Notice](#)

Important Safety Instructions

Follow these safety instructions when setting up and using the scanner:

- Read all these instructions, and follow all warnings and instructions marked on the scanner.
- Place the scanner close enough to the computer for the interface cable to reach it easily.
- Do not use with wet hands.
- When connecting this product to a computer or other device with a cable, ensure the correct orientation of the connectors. Each connector has only one correct orientation. Inserting a connector in the wrong orientation may damage both devices connected by the cable.
- Do not insert objects into any opening as they may touch dangerous voltage points or short out parts. Beware of electrical shock hazards.
- Place the product on a flat, stable surface that extends beyond the base of the product in all directions. If you place the product by the wall, leave at least 3.9 inches (10 cm) between the back of the product and the wall.
- After replacing consumable parts, dispose of them correctly following the rules of your local authority. Do not disassemble them.
- Do not place or store the scanner outdoors, in a car, near excessive dirt or dust, water, heat sources, or in locations subject to shocks, vibrations, condensation, high temperature or humidity, direct sunlight, strong light sources, or rapid changes in temperature or humidity.

- Never disassemble, modify, or attempt to repair the scanner or a scanner option by yourself except as specifically explained in this guide.

Caution: Radio waves from this product may adversely affect the operation of medical equipment, airplanes, or automatically controlled devices, such as pacemakers, automatic doors, or fire alarms. When using this product near such devices or inside a medical facility, follow the directions from authorized staff members at the facility, and follow all posted warnings and directions on the device to avoid causing an accident.

AC Adapter

- Do not place or store the AC adapter outdoors, in a car, near excessive dirt or dust, water, heat sources, or in locations subject to shocks, vibrations, condensation, high temperature or humidity, direct sunlight, strong light sources, or rapid changes in temperature or humidity.
- Place the scanner and the AC adapter near an electrical outlet where the adapter can be easily unplugged.
- The AC power cord should be placed to avoid abrasions, cuts, fraying, crimping, and kinking.
- Do not place objects on top of the AC power cord and do not allow the AC adapter or the power cord to be stepped on or run over. Be particularly careful to keep the AC power cord straight at the end and the point where it enters the AC adapter.
- Use only the AC adapter that comes with your scanner. Using any other adapter could cause fire, electrical shock, or injury.
- Use only the power cord that comes with your scanner. Use of another cord may cause fires or shock. Do not use the cord with any other equipment.
- The AC adapter is designed for use with the scanner with which it was included. Do not attempt to use it with other electronic devices unless specified.
- Use only the type of power source indicated on the AC adapter's label, and always supply power directly from a standard domestic electrical outlet with the AC adapter that meets the relevant local safety standards.
- Avoid using outlets on the same circuit as photocopiers or air control systems that regularly switch on and off.
- If you use an extension cord with the scanner, make sure the total ampere rating of the devices plugged into the extension cord does not exceed the cord's ampere rating. Also, make sure the total ampere rating of all devices plugged into the wall outlet does not exceed the wall outlet's ampere rating.

- Never disassemble, modify, or attempt to repair the AC adapter by yourself except as specifically explained in the scanner's guides.
- If damage occurs to the plug, replace the cord set or consult a qualified electrician. If there are fuses in the plug, make sure you replace them with fuses of the correct size and rating.
- Unplug the scanner and the AC adapter, and refer servicing to qualified service personnel under the following conditions: The AC adapter or plug is damaged; liquid has entered the scanner or the AC adapter; the scanner or the AC adapter has been dropped or the case has been damaged; the scanner or the AC adapter does not operate normally or exhibits a distinct change in performance. (Do not adjust controls that are not covered by the operating instructions.)
- Unplug the scanner and the AC adapter before cleaning. Clean with a damp cloth only. Do not use liquid or aerosol cleaners.
- If you are not going to use the scanner for a long period, be sure to unplug the AC adapter from the electrical outlet.

USB

- The USB cable is designed for use with the product with which it was included. Do not attempt to use it with other electrical devices unless specified.
- The USB cable should be placed to avoid abrasions, cuts, fraying, crimping, and kinking.
- Do not place objects on top of the USB cable and do not allow the cable to be stepped on or run over. Be particularly careful to keep the USB cable straight at the end.
- If you are not going to use the product for a long period, unplug the USB cable from the computer.
- Unplug the scanner and the USB cable, and refer servicing to qualified service personnel under the following conditions: Liquid has entered the scanner; the scanner has been dropped or the case has been damaged; the scanner does not operate normally or exhibits a distinct change in performance. (Do not adjust controls that are not covered by the operating instructions.)

LCD Screen

- The LCD screen may have uneven brightness or a few small bright or dark spots. This is normal and does not indicate damage.
- Use only a dry, soft cloth to clean the LCD screen. Do not use liquid or chemical cleansers.
- If the LCD screen is damaged, contact Epson. If the liquid crystal solution gets on your hands, wash them thoroughly with soap and water. If the liquid crystal solution gets into your eyes, flush them immediately with water. If discomfort or vision problems remain after a thorough flushing, see a doctor immediately.
- Do not press too hard on the LCD screen or subject it to heavy impacts.

- Do not use a pointy or sharp object, such as a pen or your fingernail, to operate the LCD screen.
- If the LCD screen chips or cracks, do not touch or attempt to remove the broken pieces; contact Epson for support.
- Do not subject your product to sudden changes in temperature or humidity; this may cause condensation to develop inside the LCD screen and degrade its performance.

Parent topic: [Notices](#)

Restrictions on Copying

Observe the following restrictions to ensure responsible and legal use of your scanner.

Copying of the following items is prohibited by law:

- Bank bills, coins, government-issued marketable securities, government bond securities, and municipal securities
- Unused postage stamps, pre-stamped postcards, and other official postal items bearing valid postage
- Government-issued revenue stamps, and securities issued according to legal procedure

Exercise caution when copying the following items:

- Private marketable securities (stock certificates, negotiable notes, checks, etc.), monthly passes, concession tickets, etc.
- Passports, driver's licenses, warrants of fitness, road passes, food stamps, tickets, etc.

Note: Copying these items may also be prohibited by law.

Restriction on disassembling and decompiling

You may not disassemble, decompile, or otherwise attempt to derive the source code of any software included with this product.

Parent topic: [Notices](#)

Default Delay Times for Power Management for Epson Products

This product will enter sleep mode after a period of nonuse. This is to ensure that the product meets Energy Star standards of energy efficiency. More energy savings can be achieved by setting the time to sleep to a shorter interval.

Parent topic: [Notices](#)

Binding Arbitration and Class Waiver

1. DISPUTES, BINDING INDIVIDUAL ARBITRATION, AND WAIVER OF CLASS ACTIONS AND CLASS ARBITRATIONS

1.1 Disputes. The terms of this Section 1 shall apply to all Disputes between you and Epson. The term "Dispute" is meant to have the broadest meaning permissible under law and includes any dispute, claim, controversy or action between you and Epson arising out of or relating to this Agreement, Epson branded products (hardware and including any related software), or other transaction involving you and Epson, whether in contract, warranty, misrepresentation, fraud, tort, intentional tort, statute, regulation, ordinance, or any other legal or equitable basis. "DISPUTE" DOES NOT INCLUDE IP CLAIMS, or more specifically, a claim or cause of action for (a) trademark infringement or dilution, (b) patent infringement, (c) copyright infringement or misuse, or (d) trade secret misappropriation (an "IP Claim"). You and Epson also agree, notwithstanding Section 1.6, that a court, not an arbitrator, may decide if a claim or cause of action is for an IP Claim.

1.2 Binding Arbitration. You and Epson agree that all Disputes shall be resolved by binding arbitration according to this Agreement. **ARBITRATION MEANS THAT YOU WAIVE YOUR RIGHT TO A JUDGE OR JURY IN A COURT PROCEEDING AND YOUR GROUNDS FOR APPEAL ARE LIMITED.**

Pursuant to this Agreement, binding arbitration shall be administered by JAMS, a nationally recognized arbitration authority, pursuant to its code of procedures then in effect for consumer related disputes, but excluding any rules that permit joinder or class actions in arbitration (for more detail on procedure, see Section 1.6 below). You and Epson understand and agree that (a) the Federal Arbitration Act (9 U.S.C. §1, et seq.) governs the interpretation and enforcement of this Section 1, (b) this Agreement memorializes a transaction in interstate commerce, and (c) this Section 1 shall survive termination of this Agreement.

1.3 Pre-Arbitration Steps and Notice. Before submitting a claim for arbitration, you and Epson agree to try, for sixty (60) days, to resolve any Dispute informally. If Epson and you do not reach an agreement to resolve the Dispute within the sixty (60) days, you or Epson may commence an arbitration. Notice to Epson must be addressed to: Epson America, Inc., ATTN: Legal Department, 3131 Katella Ave., Los Alamitos, CA 90720 (the "Epson Address"). The Dispute Notice to you will be sent to the most recent address Epson has in its records for you. For this reason, it is important to notify us if your address changes by emailing us at EAILEgal@ea.epson.com or writing us at the Epson Address above. Notice of the Dispute shall include the sender's name, address and contact information, the facts giving rise to the Dispute, and the relief requested (the "Dispute Notice"). Following receipt of the Dispute Notice, Epson and you agree to act in good faith to resolve the Dispute before commencing arbitration.

1.4 Small Claims Court. Notwithstanding the foregoing, you may bring an individual action in the small claims court of your state or municipality if the action is within that court's jurisdiction and is pending only in that court.

1.5 WAIVER OF CLASS ACTIONS AND CLASS ARBITRATIONS. YOU AND EPSON AGREE THAT EACH PARTY MAY BRING DISPUTES AGAINST THE OTHER PARTY ONLY IN AN INDIVIDUAL CAPACITY, AND NOT AS A PLAINTIFF OR CLASS MEMBER IN ANY CLASS OR REPRESENTATIVE PROCEEDING, INCLUDING WITHOUT LIMITATION FEDERAL OR STATE CLASS ACTIONS, OR CLASS ARBITRATIONS. CLASS ACTION LAWSUITS, CLASS-WIDE ARBITRATIONS, PRIVATE ATTORNEY-GENERAL ACTIONS, AND ANY OTHER PROCEEDING WHERE SOMEONE ACTS IN A REPRESENTATIVE CAPACITY ARE NOT ALLOWED. ACCORDINGLY, UNDER THE ARBITRATION PROCEDURES OUTLINED IN THIS SECTION, AN ARBITRATOR SHALL NOT COMBINE OR CONSOLIDATE MORE THAN ONE PARTY'S CLAIMS WITHOUT THE WRITTEN CONSENT OF ALL AFFECTED PARTIES TO AN ARBITRATION PROCEEDING.

1.6 Arbitration Procedure. If you or Epson commences arbitration, the arbitration shall be governed by the rules of JAMS that are in effect when the arbitration is filed, excluding any rules that permit arbitration on a class or representative basis (the "JAMS Rules"), available at <http://www.jamsadr.com> or by calling 1-800-352-5267, and under the rules set forth in this Agreement. All Disputes shall be resolved by a single neutral arbitrator, and both parties shall have a reasonable opportunity to participate in the selection of the arbitrator. The arbitrator is bound by the terms of this Agreement. The arbitrator, and not any federal, state or local court or agency, shall have exclusive authority to resolve all disputes arising out of or relating to the interpretation, applicability, enforceability or formation of this Agreement, including any claim that all or any part of this Agreement is void or voidable. Notwithstanding this broad delegation of authority to the arbitrator, a court may determine the limited question of whether a claim or cause of action is for an IP Claim, which is excluded from the definition of "Disputes" in Section 1.1 above. The arbitrator shall be empowered to grant whatever relief would be available in a court under law or in equity. The arbitrator may award you the same damages as a court could, and may award declaratory or injunctive relief only in favor of the individual party seeking relief and only to the extent necessary to provide relief warranted by that party's individual claim. In some instances, the costs of arbitration can exceed the costs of litigation and the right to discovery may be more limited in arbitration than in court. The arbitrator's award is binding and may be entered as a judgment in any court of competent jurisdiction.

You may choose to engage in arbitration hearings by telephone. Arbitration hearings not conducted by telephone shall take place in a location reasonably accessible from your primary residence, or in Orange County, California, at your option.

a) Initiation of Arbitration Proceeding. If either you or Epson decides to arbitrate a Dispute, both parties agree to the following procedure:

(i) Write a Demand for Arbitration. The demand must include a description of the Dispute and the amount of damages sought to be recovered. You can find a copy of a Demand for Arbitration at <http://www.jamsadr.com> ("Demand for Arbitration").

(ii) Send three copies of the Demand for Arbitration, plus the appropriate filing fee, to: JAMS, 500 North State College Blvd., Suite 600 Orange, CA 92868, U.S.A.

(iii) Send one copy of the Demand for Arbitration to the other party (same address as the Dispute Notice), or as otherwise agreed by the parties.

b) Hearing Format. During the arbitration, the amount of any settlement offer made shall not be disclosed to the arbitrator until after the arbitrator determines the amount, if any, to which you or Epson is entitled. The discovery or exchange of non-privileged information relevant to the Dispute may be allowed during the arbitration.

c) Arbitration Fees. Epson shall pay, or (if applicable) reimburse you for, all JAMS filings and arbitrator fees for any arbitration commenced (by you or Epson) pursuant to provisions of this Agreement.

d) Award in Your Favor. For Disputes in which you or Epson seeks \$75,000 or less in damages exclusive of attorney's fees and costs, if the arbitrator's decision results in an award to you in an amount greater than Epson's last written offer, if any, to settle the Dispute, Epson will: (i) pay you \$1,000 or the amount of the award, whichever is greater; (ii) pay you twice the amount of your reasonable attorney's fees, if any; and (iii) reimburse you for any expenses (including expert witness fees and costs) that your attorney reasonably accrues for investigating, preparing, and pursuing the Dispute in arbitration. Except as agreed upon by you and Epson in writing, the arbitrator shall determine the amount of fees, costs, and expenses to be paid by Epson pursuant to this Section 1.6d).

e) Attorney's Fees. Epson will not seek its attorney's fees and expenses for any arbitration commenced involving a Dispute under this Agreement. Your right to attorney's fees and expenses under Section 1.6d) above does not limit your rights to attorney's fees and expenses under applicable law; notwithstanding the foregoing, the arbitrator may not award duplicative awards of attorney's fees and expenses.

1.7 Opt-out. You may elect to opt-out (exclude yourself) from the final, binding, individual arbitration procedure and waiver of class and representative proceedings specified in this Agreement by sending a written letter to the Epson Address within thirty (30) days of your assent to this Agreement (including without limitation the purchase, download, installation of the Software or other applicable use of Epson Hardware, products and services) that specifies (i) your name, (ii) your mailing address, and (iii) your request to be excluded from the final, binding individual arbitration procedure and waiver of class and representative proceedings specified in this Section 1. In the event that you opt-out consistent with the procedure set forth above, all other terms shall continue to apply, including the requirement to provide notice prior to litigation.

1.8 Amendments to Section 1. Notwithstanding any provision in this Agreement to the contrary, you and Epson agree that if Epson makes any future amendments to the dispute resolution procedure and class action waiver provisions (other than a change to Epson's address) in this Agreement, Epson will obtain your affirmative assent to the applicable amendment. If you do not affirmatively assent to the applicable amendment, you are agreeing that you will arbitrate any Dispute between the parties in accordance with the language of this Section 1 (or resolve disputes as provided for in Section 1.7, if you timely elected to opt-out when you first assented to this Agreement).

1.9 Severability. If any provision in this Section 1 is found to be unenforceable, that provision shall be severed with the remainder of this Agreement remaining in full force and effect. **The foregoing shall not apply to the prohibition against class or representative actions as provided in Section 1.5. This means that if Section 1.5 is found to be unenforceable, the entire Section 1 (but only Section 1) shall be null and void.**

Parent topic: [Notices](#)

Trademarks

EPSON® and Epson Smart Panel® are registered trademarks and EPSON Exceed Your Vision is a registered logomark of Seiko Epson Corporation.

Windows is a registered trademark of Microsoft Corporation in the United States and/or other countries.

Apple, App Store, Mac, macOS, and OS X are trademarks of Apple Inc., registered in the U.S. and other countries.

Google® is a registered trademark and Android™ and Google Play™ are trademarks of Google LLC.

General Notice: Other product names used herein are for identification purposes only and may be trademarks of their respective owners. Epson disclaims any and all rights in those marks.



Parent topic: [Notices](#)

Copyright Notice

All rights reserved. No part of this publication may be reproduced, stored in a retrieval system, or transmitted in any form or by any means, electronic, mechanical, photocopying, recording, or otherwise, without the prior written permission of Seiko Epson Corporation. The information contained herein is designed only for use with this Epson product. Epson is not responsible for any use of this information as applied to other products.

Neither Seiko Epson Corporation nor its affiliates shall be liable to the purchaser of this product or third parties for damages, losses, costs, or expenses incurred by purchaser or third parties as a result of: accident, misuse, or abuse of this product or unauthorized modifications, repairs, or alterations to this product, or (excluding the U.S.) failure to strictly comply with Seiko Epson Corporation's operating and maintenance instructions.

Seiko Epson Corporation shall not be liable for any damages or problems arising from the use of any options or any consumable products other than those designated as Original Epson Products or Epson Approved Products by Seiko Epson Corporation.

Seiko Epson Corporation shall not be held liable for any damage resulting from electromagnetic interference that occurs from the use of any interface cables other than those designated as Epson approved Products by Seiko Epson Corporation.

This information is subject to change without notice.

[libTIFF Software Acknowledgment](#)

[A Note Concerning Responsible Use of Copyrighted Materials](#)

[Copyright Attribution](#)

Parent topic: [Notices](#)

libTIFF Software Acknowledgment

Copyright © 1988-1997 Sam Leffler

Copyright © 1991-1997 Silicon Graphics, Inc.

Permission to use, copy, modify, distribute, and sell this software and its documentation for any purpose is hereby granted without fee, provided that (i) the above copyright notices and this permission notice appear in all copies of the software and related documentation, and (ii) the names of Sam Leffler and Silicon Graphics may not be used in any advertising or publicity relating to the software without the specific, prior written permission of Sam Leffler and Silicon Graphics.

THE SOFTWARE IS PROVIDED "AS-IS" AND WITHOUT WARRANTY OF ANY KIND, EXPRESS, IMPLIED OR OTHERWISE, INCLUDING WITHOUT LIMITATION, ANY WARRANTY OF MERCHANTABILITY OR FITNESS FOR A PARTICULAR PURPOSE.

IN NO EVENT SHALL SAM LEFFLER OR SILICON GRAPHICS BE LIABLE FOR ANY SPECIAL, INCIDENTAL, INDIRECT OR CONSEQUENTIAL DAMAGES OF ANY KIND, OR ANY DAMAGES WHATSOEVER RESULTING FROM LOSS OF USE, DATA OR PROFITS, WHETHER OR NOT ADVISED OF THE POSSIBILITY OF DAMAGE, AND ON ANY THEORY OF LIABILITY, ARISING OUT OF OR IN CONNECTION WITH THE USE OR PERFORMANCE OF THIS SOFTWARE.

Parent topic: [Copyright Notice](#)

A Note Concerning Responsible Use of Copyrighted Materials

Epson encourages each user to be responsible and respectful of the copyright laws when using any Epson product. While some countries' laws permit limited copying or reuse of copyrighted material in certain circumstances, those circumstances may not be as broad as some people assume. Contact your legal advisor for any questions regarding copyright law.

Parent topic: [Copyright Notice](#)

Copyright Attribution

© 2020 Epson America, Inc.

12/20

CPD-59134

Parent topic: [Copyright Notice](#)

Free Manuals Download Website

<http://myh66.com>

<http://usermanuals.us>

<http://www.somanuals.com>

<http://www.4manuals.cc>

<http://www.manual-lib.com>

<http://www.404manual.com>

<http://www.luxmanual.com>

<http://aubethermostatmanual.com>

Golf course search by state

<http://golfingnear.com>

Email search by domain

<http://emailbydomain.com>

Auto manuals search

<http://auto.somanuals.com>

TV manuals search

<http://tv.somanuals.com>