

ET-2750 Start Here

Read these instructions before using your product.

Note for Spanish speakers/Nota para hispanohablantes: Para obtener instrucciones de configuración en español, consulte la *Guía de instalación* en www.epson.com/support/et2750sp (requiere una conexión a Internet).

1 Unpack

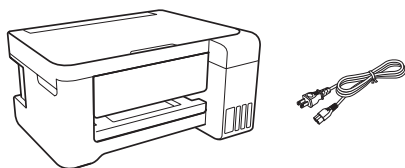

Note: Do not open the ink bottles until you are ready to fill the ink tanks. The ink bottles are vacuum packed to maintain reliability.

- 1 Remove all protective materials from the product.

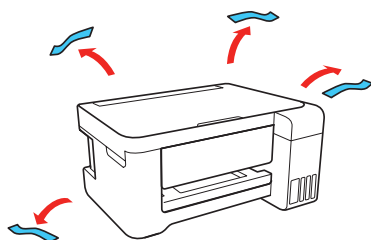

- 2 Lift up the scanner unit. Remove all protective materials from inside the product.

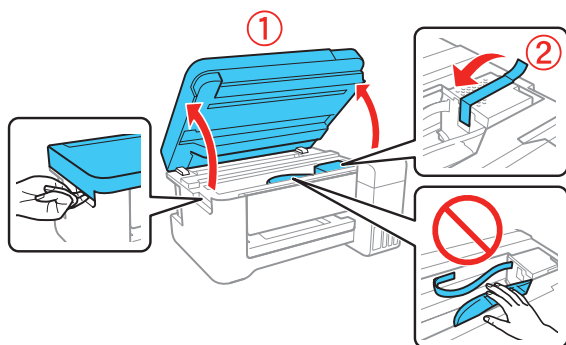

Caution: Do not touch the flat white cable or the ink tubes and their translucent cover.

2 Fill ink tanks

Note: This product requires careful handling of ink. If ink spills, wipe it off immediately with a damp towel to avoid permanent stains. If ink gets on your clothes or belongings, it may not come off.

Warning: Keep the ink bottles out of the reach of children and do not drink the ink.

- 1 Open the ink tank cover, then open the cap for the ink tank you are going to fill.

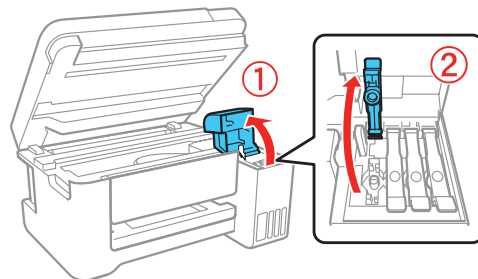

- 2 Unpack one of the ink bottles. Hold the ink bottle upright and slowly turn the bottle cap to remove it.

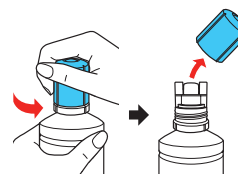

Caution: Do not shake or squeeze the ink bottles. Do not touch the top of the ink bottle after its cap is removed.

- 3 Position the top of the ink bottle along the slot in front of the filling port, then slowly stand the bottle up to insert it.

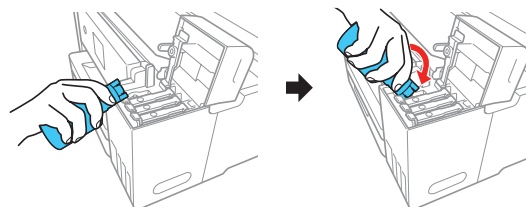

Note: Refer to the color-coded sticker on the ink tank unit to identify the color of each tank. Do not force the bottles into position; they are keyed for each color.

- 4 Wait for the ink to fill the tank. **Do not squeeze the bottle.** Ink flows into the tank and stops automatically when the ink is filled to the upper line.

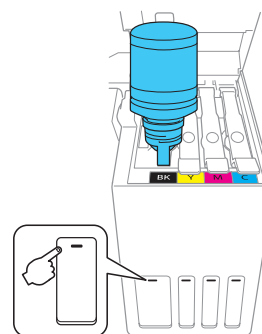

Note: If ink does not flow from the bottle, lift and reinsert the bottle.



413478800

EPSON
EXCEED YOUR VISION

- 5** When the ink tank is full, remove the ink bottle and securely close the ink tank cap. Place the remaining ink aside; you will need it later.

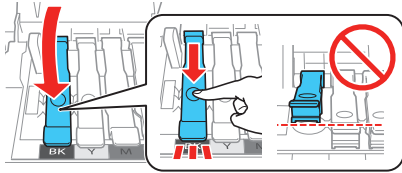

Note: Replace the bottle cap and tighten it.

- 6** Repeat the previous steps for the other colors.
7 Close the ink tank cover and then the scanner unit.

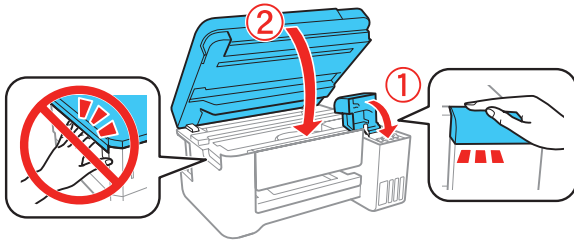

- 8** Connect the power cord to the back of the product and to an electrical outlet.

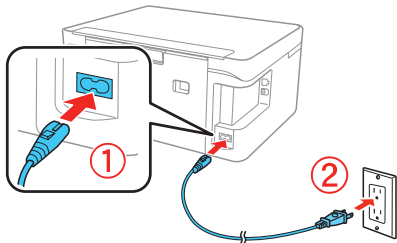

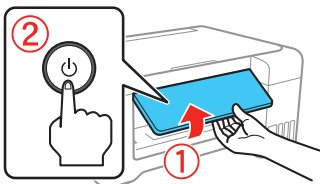

Caution: Do not connect to your computer yet.

- 9** Raise the control panel, then press the  power button to turn on the product.





Note: If an error message appears, turn off the product and check that no protective material has been left inside the product.

- 10** Press  or  to select your language on the LCD screen, then press the **OK** button. **Follow steps 11 and 12 to continue ink charging.**

Note: You can change this setting later using the product's control panel. For more information, see the online *User's Guide*.

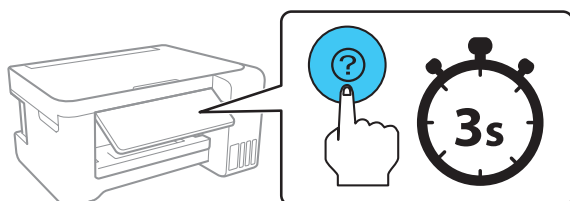
- 11** When the message to see the Start Here sheet appears on the LCD screen, press the **OK** button. On the next screen, press and hold the  help button for **3 seconds**.



- 12** When the message to start initialization appears on the LCD screen, press the  start button to start charging the ink. Ink charging takes approximately 10 minutes. A message appears when ink charging is complete. Press the **OK** button to continue.

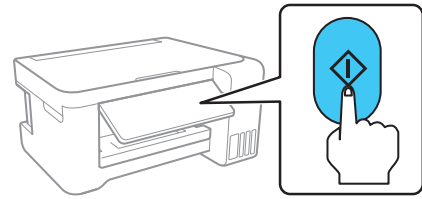

Note: After some ink is used for charging, the rest is available for printing.

Caution: Do not turn off the product, raise the scanner unit, or load paper while the product is charging or you'll waste ink.

- 13** To complete filling the ink tanks, repeat steps 1 through 6 using the remaining ink in the bottles.

Note: Replace the bottle cap before disposing of the bottles.

- 14** Close the ink tank cover and scanner unit.

- 15** Select **Maintenance > Reset Ink Levels**, then follow the on-screen instructions to reset the ink levels.

- 16** Follow the on-screen instructions to adjust the print quality. Press the **OK** button to continue.

Note: You can change these settings later using the product's control panel. For more information, see the online *User's Guide*.

3 Load paper

See the online *User's Guide* for information about loading capacity and available paper types and sizes.

- 1** Make sure the product is not charging. Then flip the feeder guard forward, raise the paper support, and tilt it backwards slightly.

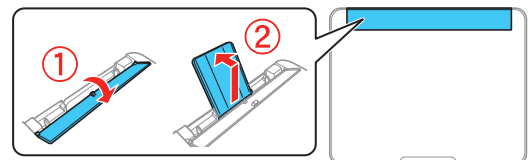

- 2** Slide the edge guides all the way out.

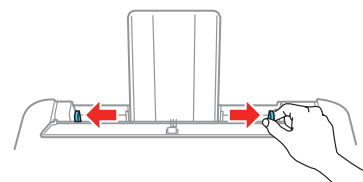

- 3** Load paper, glossy or printable side up and short edge first, in the middle of the rear paper feed slot.

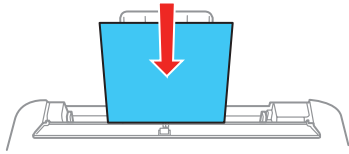

- 4** Slide the edge guide against the paper, but not too tightly.

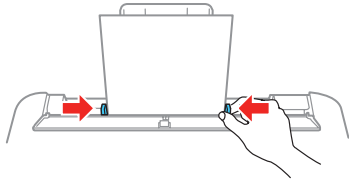

- 5** Pull out the output tray.

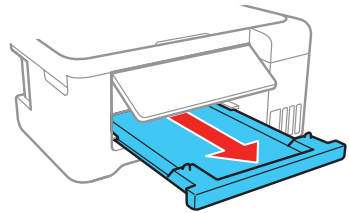

- 6** Select the paper settings on the product's control panel.

4 Install software

Note: If your computer does not have a CD/DVD drive or you are using a Mac, an Internet connection is required to obtain the product software.

To print from a Chromebook™, go to www.epson.com/support/gcp (U.S.) or www.epson.ca/support/gcp (Canada) for instructions.

- 1** Make sure the product is **NOT CONNECTED** to your computer.

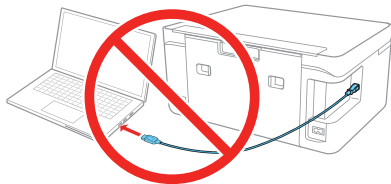

Windows®: If you see a Found New Hardware screen, click **Cancel** and disconnect the USB cable.

- 2** Insert the product CD or download and run your product's software package:

www.epson.com/support/et2750 (U.S.) or
www.epson.ca/support/et2750 (Canada)

- 3** Follow the instructions on the computer screen to run the setup program.

- 4** When you see the Select Your Connection screen, select one of the following:

- **Wireless connection**

In most cases, the software installer automatically attempts to set up your wireless connection. If setup is unsuccessful, you may need to enter your network name (SSID) and password.

- **Direct USB connection**

Make sure you have a USB cable (not included).

Mobile printing

Connect wirelessly from your smartphone, tablet, or computer. Print documents and photos from across the room or around the world:

- Print directly from a smartphone or tablet using iOS or Android with Epson iPrint™. Simply connect your printer and device to the same network and tap the action icon to select the print option.
- Use Epson Print Enabler (free from Google Play™) with Android™ devices (v4.4 or later). Then connect your printer and device to the same network and tap the menu icon to select the print option.
- Print remotely with Epson Connect™ and Google Cloud Print™. See your online *User's Guide* for instructions or learn more at www.epson.com/connect (U.S.) or www.epson.ca/connect (Canada).

Any problems?

Network setup was unsuccessful.

- Make sure you select the right network name (SSID).
- Restart your router (turn it off and then on), then try to connect to it again.
- The printer can only connect to a network that supports 2.4 GHz connections. If your router offers both 2.4 GHz and 5 GHz connections, make sure 2.4 GHz is enabled.
- If you see a firewall alert message, click **Unblock** or **Allow** to let setup continue.
- If your network has security enabled, make sure you enter your network password (WEP key or WPA passphrase) correctly. Be sure to enter your password in the correct case.

There are lines or incorrect colors in my printouts.

Run a nozzle check to see if there are any clogged nozzles. Then clean the print head, if necessary. See the online *User's Guide* for more information.

The product's screen is dark.

Make sure your product is turned on, and press any button to wake it from sleep mode.

Setup is unable to find my product after connecting it with a USB cable.

Make sure your product is on and securely connected as shown:

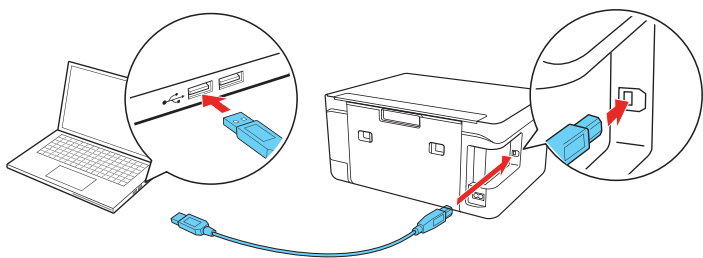

Need paper and ink?

Ensure peak performance and brilliant results with Genuine Epson® Ink and specialty papers, engineered specifically for Epson printers. Find Genuine Epson Ink and specialty papers at www.epson.com (U.S. sales) or www.epson.ca (Canadian sales) and at Epson authorized resellers. Call 800-GO-EPSON (800-463-7766).



DESIGNED *for* EXCELLENCE™

Epson printers, ink and specialty papers.

ET-2750 replacement inks

Color	Part number
● Black	502
● Cyan	502
● Magenta	502
● Yellow	502

Any questions?

Quick Guide

Basic information, troubleshooting, and limited warranty.

User's Guide

Windows: Click the icon on your desktop or Apps screen to access the online *User's Guide*.

Mac: Click the icon in **Applications/Epson Software/Guide** to access the online *User's Guide*.

If you don't have a User's Guide icon, go to the Epson website, as described below.

Technical support

Visit www.epson.com/support (U.S.) or www.epson.ca/support (Canada) and search for your product to download drivers, view manuals, get FAQs, or contact Epson.

Call (562) 276-4382 (U.S.) or (905) 709-3839 (Canada), 6 AM to 8 PM Pacific Time, Monday through Friday, and 7 AM to 4 PM, Pacific Time, Saturday. Days and hours of support are subject to change without notice. Toll or long distance charges may apply.

Recycling

Epson offers a recycling program for end of life hardware and ink bottles. Please go to www.epson.com/recycle (U.S.) or www.epson.ca/recycle (Canada) for information on how to return your products for proper disposal.



EPSON is a registered trademark, Epson Connect and Epson iPrint are trademarks, and EPSON Exceed Your Vision is a registered logomark of Seiko Epson Corporation.

Designed for Excellence is a trademark of Epson America, Inc.

Mac is a trademark of Apple Inc., registered in the U.S. and other countries.

Android, Google Cloud Print, Chromebook, and Google Play are trademarks of Google Inc.

General Notice: Other product names used herein are for identification purposes only and may be trademarks of their respective owners. Epson disclaims any and all rights in those marks.

This information is subject to change without notice.

© 2017 Epson America, Inc., 5/17

Printed in XXXXXX

CPD-53866

Free Manuals Download Website

<http://myh66.com>

<http://usermanuals.us>

<http://www.somanuals.com>

<http://www.4manuals.cc>

<http://www.manual-lib.com>

<http://www.404manual.com>

<http://www.luxmanual.com>

<http://aubethermostatmanual.com>

Golf course search by state

<http://golfingnear.com>

Email search by domain

<http://emailbydomain.com>

Auto manuals search

<http://auto.somanuals.com>

TV manuals search

<http://tv.somanuals.com>