

# ET-4700 Series / L5190 Series User's Guide

## Contents

### About This Manual

Introduction to the Manuals. . . . .	7
Using the Manual to Search for Information. . . . .	7
Marks and Symbols. . . . .	9
Descriptions Used in this Manual. . . . .	9
Operating System References. . . . .	9

### Important Instructions

Safety Instructions. . . . .	11
Safety Instructions for Ink. . . . .	11
Printer Advisories and Warnings. . . . .	12
Advisories and Warnings for Setting Up the Printer. . . . .	12
Advisories and Warnings for Using the Printer. . . . .	12
Advisories and Warnings for Transporting or Storing the Printer. . . . .	13
Advisories and Warnings for Using the Printer with a Wireless Connection. . . . .	13
Advisories and Warnings for Using the LCD Screen. . . . .	13
Protecting Your Personal Information. . . . .	13

### Printer Basics

Part Names and Functions. . . . .	14
Control Panel. . . . .	16
Guide to the LCD Screen. . . . .	17
Guide to the Home Screen. . . . .	17
Entering Characters. . . . .	18

### Network Settings

Network Connection Types. . . . .	20
Ethernet Connection. . . . .	20
Wi-Fi Connection. . . . .	20
Wi-Fi Direct (Simple AP) Connection. . . . .	21
Connecting to a Computer. . . . .	21
Connecting to a Smart Device. . . . .	22
Connecting to a smart device over a wireless router. . . . .	22
Connecting to an iPhone, iPad, or iPod touch using Wi-Fi Direct. . . . .	22
Connecting to Android Devices using Wi-Fi Direct. . . . .	26
Connecting to Devices other than iOS and Android using Wi-Fi Direct. . . . .	28

Making Wi-Fi Settings from the Printer. . . . .	31
Making Wi-Fi Settings by Entering the SSID and Password. . . . .	31
Making Wi-Fi Settings by Push Button Setup. . . . .	32
Making Wi-Fi Settings by PIN Code Setup (WPS). . . . .	33
Checking the Network Connection Status. . . . .	33
Network Icon. . . . .	34
Printing a Network Connection Report. . . . .	34
Printing a Network Status Sheet. . . . .	40
Replacing or Adding New Wireless Routers. . . . .	41
Changing the Connection Method to a Computer. . . . .	41
Changing the Network Connection to Ethernet from the Control Panel. . . . .	42
Enabling Energy Efficient Ethernet. . . . .	42
Changing the Wi-Fi Direct (Simple AP) Settings. . . . .	42
Disabling Wi-Fi from the Control Panel. . . . .	43
Disconnecting Wi-Fi Direct (Simple AP) Connection from the Control Panel. . . . .	44
Restoring the Network Settings from the Control Panel. . . . .	44

### Preparing the Printer

Loading Papers. . . . .	45
Available Paper and Capacities. . . . .	45
Loading Paper in the Rear Paper Feed. . . . .	48
Loading Envelopes and Precautions. . . . .	50
Loading Long Papers. . . . .	50
List of Paper Type. . . . .	51
Placing Originals. . . . .	51
Available Originals for the ADF. . . . .	51
Placing Originals on the ADF. . . . .	52
Placing Originals on the Scanner Glass. . . . .	53
Managing Contacts. . . . .	55
Registering or Editing Contacts. . . . .	55
Registering or Editing Grouped Contacts. . . . .	55
Register Contacts on a Computer. . . . .	56
Menu Options for Settings. . . . .	57
Menu Options for Maintenance. . . . .	57
Menu Options for Printer Setup. . . . .	58
Menu Options for Network Settings. . . . .	60
Menu Options for Epson Connect Services. . . . .	61
Menu Options for Google Cloud Print Services. . . . .	61
Menu Options for Contacts Manager. . . . .	62
Fax Settings. . . . .	62

## Contents

Menu Options for Print Status Sheet. . . . .	62	Printing to Emphasize Thin Lines. . . . .	93
Menu Options for Print Counter. . . . .	63	Printing Clear Bar Codes. . . . .	94
Menu Options for Restore Default Settings. . . . .	63	Canceling Printing. . . . .	94
Menu Options for Firmware Update. . . . .	63	Menu Options for the Printer Driver. . . . .	94
Saving Power. . . . .	63	Printing from the Printer Driver on Mac OS. . . . .	97
Saving Power - Control Panel. . . . .	64	Printing Basics. . . . .	97
		Printing Several Pages on One Sheet. . . . .	98
		Printing and Stacking in Page Order (Reverse Order Printing). . . . .	99
		Printing a Reduced or Enlarged Document. . . . .	99
		Adjusting the Print Color. . . . .	100
		Canceling Printing. . . . .	100
		Menu Options for the Printer Driver. . . . .	101
		Making Operation Settings for the Mac OS Printer Driver. . . . .	102
		Printing from Smart Devices. . . . .	103
		Using Epson iPrint. . . . .	103
		Using Epson Print Enabler. . . . .	104
		Using AirPrint. . . . .	105
		Canceling the Ongoing Job. . . . .	106
<b>Fax Settings</b>		<b>Copying</b>	
Before Using Fax Features. . . . .	65	Copying. . . . .	107
Connecting to a Phone Line. . . . .	65	Copying Multiple Originals onto One Sheet. . . . .	108
Compatible Telephone Lines. . . . .	65	Menu Options for Copying. . . . .	108
Connecting the Printer to a Phone Line. . . . .	66		
Connecting Your Phone Device to the Printer. . . . .	67	<b>Scanning</b>	
Making the Printer Ready to Send and Receive Faxes (Using Fax Setting Wizard). . . . .	68	Scanning Using the Control Panel. . . . .	110
Making Settings Individually for Printer's Fax Features. . . . .	70	Scanning to a Computer. . . . .	110
Setting Receive Mode. . . . .	70	Scanning to a Computer (WSD). . . . .	114
Making Settings When You Connect an External Phone Device. . . . .	72	Scanning from a Computer. . . . .	116
Making Settings for Blocking Junk Faxes. . . . .	73	Scanning Using Epson Scan 2. . . . .	116
Making Settings to Send and Receive Faxes on a Computer. . . . .	73	Scanning from Smart Devices. . . . .	119
Menu Options for Fax Settings. . . . .	74	Installing Epson iPrint. . . . .	119
Check Fax Connection. . . . .	74	Scanning Using Epson iPrint. . . . .	119
Fax Setting Wizard. . . . .	75		
Basic Settings Menu. . . . .	75	<b>Faxing</b>	
Receive Settings Menu. . . . .	76	Before Using Fax Features. . . . .	121
Report Settings Menu. . . . .	77	Sending Faxes Using the Printer. . . . .	121
Security Settings Menu. . . . .	77	Sending Faxes Using the Control Panel. . . . .	121
Menu Options for User Default Settings. . . . .	78	Various Ways of Sending Faxes. . . . .	123
		Receiving Faxes on the Printer. . . . .	126
		Receiving Incoming Faxes. . . . .	126
		Receiving Faxes by Making a Phone Call. . . . .	127
		Menu Options for Faxing. . . . .	128
		Fax. . . . .	128
		Scan Settings. . . . .	129
<b>Printing</b>			
Printing from the Printer Driver on Windows. . . . .	79		
Accessing the Printer Driver. . . . .	79		
Printing Basics. . . . .	79		
Printing on 2-Sides. . . . .	81		
Printing Several Pages on One Sheet. . . . .	82		
Printing and Stacking in Page Order (Reverse Order Printing). . . . .	82		
Printing a Reduced or Enlarged Document. . . . .	83		
Printing One Image on Multiple Sheets for Enlargement (Creating a Poster). . . . .	84		
Printing with a Header and Footer. . . . .	90		
Printing a Watermark. . . . .	91		
Printing Multiple Files Together. . . . .	91		
Printing Using the Color Universal Print Feature. . . . .	92		
Adjusting the Print Color. . . . .	93		

## Contents

Fax Send Settings. . . . .	129
More. . . . .	130
Contacts Manager. . . . .	131
Sending a Fax from a Computer. . . . .	131
Sending Documents Created Using an Application (Windows). . . . .	131
Sending Documents Created Using an Application (Mac OS). . . . .	134
Receiving Faxes on a Computer. . . . .	135
Saving Incoming Faxes on a Computer. . . . .	135
Canceling the Feature that Saves Incoming Faxes to the Computer. . . . .	136
Checking for New Faxes (Windows). . . . .	136
Checking for New Faxes (Mac OS). . . . .	137
Using Other Faxing Features. . . . .	138
Printing Fax Report Manually. . . . .	138

### Refilling Ink

Checking the Ink Levels. . . . .	139
Checking the Ink Levels - Windows. . . . .	139
Checking the Ink Levels - Mac OS. . . . .	139
Ink Bottle Codes. . . . .	139
Ink Bottle Handling Precautions. . . . .	140
Refilling the Ink Tanks. . . . .	141

### Maintaining the Printer

<b>Preventing the Print Head from Drying.</b> . . . .	146
Checking and Cleaning the Print Head. . . . .	146
Checking and Cleaning the Print Head - Control Panel. . . . .	146
Checking and Cleaning the Print Head - Windows. . . . .	147
Checking and Cleaning the Print Head - Mac OS. . . . .	147
Running Power Cleaning. . . . .	148
Running Power Cleaning - Control Panel. . . . .	148
Running Power Cleaning - Windows. . . . .	149
Running Power Cleaning - Mac OS. . . . .	149
Aligning the Print Head. . . . .	149
Aligning the Print Head - Control Panel. . . . .	150
Cleaning the Paper Path for Ink Smears. . . . .	150
Cleaning the ADF. . . . .	150
Cleaning the Scanner Glass. . . . .	152
Checking the Total Number of Pages Fed Through the Printer. . . . .	153
Checking the Total Number of Pages Fed Through the Printer - Control Panel. . . . .	153

Checking the Total Number of Pages Fed Through the Printer - Windows. . . . .	154
Checking the Total Number of Pages Fed Through the Printer - Mac OS. . . . .	154

### Network Service and Software Information

Application for Configuring Printer Operations (Web Config). . . . .	155
Running Web Config on a Web Browser. . . . .	155
Running Web Config on Windows. . . . .	156
Running Web Config on Mac OS. . . . .	156
Application for Scanning Documents and Images (Epson Scan 2). . . . .	156
Adding the Network Scanner. . . . .	157
Application for Configuring Scanning Operations from the Control Panel (Epson Event Manager). . . . .	157
Application for Configuring Fax Operations and Sending Faxes (FAX Utility). . . . .	158
Application for Sending Faxes (PC-FAX Driver). . . . .	159
Application for Printing Images (Epson Photo+). . . . .	159
Application for Printing Web Pages (E-Web Print)	160
Application for Scanning and Transferring Images (Easy Photo Scan). . . . .	160
Software Update Tools (EPSON Software Updater). . . . .	161
Application for Configuring Multiple Devices (EpsonNet Config). . . . .	161
Installing the Latest Applications. . . . .	162
Updating the Printer's Firmware using the Control Panel. . . . .	163
Uninstalling Applications. . . . .	163
Uninstalling Applications - Windows. . . . .	164
Uninstalling Applications - Mac OS. . . . .	164
Printing Using a Network Service. . . . .	165

### Solving Problems

Checking the Printer Status. . . . .	166
Checking Error Codes on the LCD Screen. . . . .	166
Checking the Printer Status - Windows. . . . .	167
Checking the Printer Status - Mac OS. . . . .	167
Checking the Software Status. . . . .	168
Removing Jammed Paper. . . . .	168
Removing Jammed Paper from the Rear Paper Feed. . . . .	168
Removing Jammed Paper from Inside the Printer. . . . .	169

## Contents

Removing Jammed Paper from the ADF. . . . .	171	An Image of the Reverse Side of the Original Appears in the Copied Image. . . . .	189
Paper Does Not Feed Correctly. . . . .	172	Banding Appears when Copying from the ADF	189
Paper Jams. . . . .	172	The Printout Problem Could Not be Cleared. . .	189
Paper Feeds at a Slant. . . . .	173	Other Printing Problems. . . . .	189
Several Sheets of Paper are Fed at a Time. . . . .	173	Printing Is Too Slow. . . . .	189
Paper Out Error Occurs. . . . .	173	Printing or Copying Slows Down Dramatically During Continuous Operation. . .	190
Original Does Not Feed in the ADF. . . . .	173	Cannot Start Scanning. . . . .	190
Power and Control Panel Problems. . . . .	174	Cannot Start Scanning when Using the Control Panel. . . . .	191
Power Does Not Turn On. . . . .	174	Scanned Image Problems. . . . .	191
Power Does Not Turn Off. . . . .	174	Uneven Colors, Dirt, Spots, and so on Appear when Scanning from the Scanner Glass. . . . .	191
Power Turns Off Automatically. . . . .	174	Straight Lines Appear when Scanning from ADF. . . . .	192
LCD Screen Gets Dark. . . . .	174	The Image Quality Is Rough. . . . .	192
Cannot Print from a Computer. . . . .	174	Offset Appears in the Background of Images. . .	192
Checking the Connection (USB). . . . .	174	Text is Blurred. . . . .	192
Checking the Connection (Network). . . . .	175	Moiré Patterns (Web-Like Shadows) Appear. . .	192
Checking the Software and Data. . . . .	176	Cannot Scan the Correct Area on the Scanner Glass. . . . .	193
Checking the Printer Status from the Computer (Windows). . . . .	178	Text is Not Recognized Correctly when Saving as a Searchable PDF. . . . .	193
Checking the Printer Status from the Computer (Mac OS). . . . .	178	Cannot Solve Problems in the Scanned Image. .	194
When You Cannot Make Network Settings. . . . .	179	Other Scanning Problems. . . . .	194
Cannot Connect from Devices Even Though Network Settings are No Problems. . . . .	179	Scanning Is Too Slow. . . . .	194
Checking the SSID Connected to the Printer. . .	181	Scanning Slows Down Dramatically During Continuous Scanning. . . . .	194
Checking the SSID for the Computer. . . . .	181	Scanning Stops when Scanning to PDF/ Multi-TIFF. . . . .	195
Ethernet Connection Becomes Unstable. . . . .	182	Problems when Sending and Receiving Faxes. . . .	195
Cannot Print from an iPhone or iPad. . . . .	183	Cannot Send or Receive Faxes. . . . .	195
Printout Problems. . . . .	183	Cannot Send Faxes. . . . .	196
Printout is Scuffed or Color is Missing. . . . .	183	Cannot Send Faxes to a Specific Recipient. . . . .	197
Banding or Unexpected Colors Appear. . . . .	184	Cannot Send Faxes at a Specified Time. . . . .	197
Colored Banding Appears at Intervals of Approximately 2.5 cm. . . . .	184	Cannot Receive Faxes. . . . .	197
Blurry Prints, Vertical Banding, or Misalignment. . . . .	184	Sent Fax Quality Is Poor. . . . .	198
Print Quality is Poor. . . . .	185	Faxes Are Sent at the Wrong Size. . . . .	198
Paper Is Smeared or Scuffed. . . . .	186	Received Fax Quality Is Poor. . . . .	198
Printed Photos are Sticky. . . . .	186	Received Faxes Are Not Printed. . . . .	198
Images or Photos are Printed in Unexpected Colors. . . . .	187	Pages are Blank or only a Small Amount of Text is Printed on the Second Page in Received Faxes. . . . .	199
Cannot Print Without Margins. . . . .	187	Other Faxing Problems. . . . .	199
Edges of the Image are Cropped During Borderless Printing. . . . .	187	Cannot Make Calls on the Connected Telephone. . . . .	199
The Position, Size, or Margins of the Printout Are Incorrect. . . . .	187	Answering Machine Cannot Answer Voice Calls. . . . .	199
Printed Characters Are Incorrect or Garbled. . .	188	Sender's Fax Number Not Displayed on Received Faxes or the Number Is Wrong. . . . .	199
The Printed Image Is Inverted. . . . .	188		
Mosaic-Like Patterns in the Prints. . . . .	188		
Uneven Colors, Smears, Dots, or Straight Lines Appear in the Copied Image. . . . .	188		
Moiré (Cross-Hatch) Patterns Appear in the Copied Image. . . . .	189		

## Contents

Other Problems. . . . .	199
Slight Electric Shock when Touching the Printer. . . . .	199
Operation Sounds Are Loud. . . . .	200
The Date and Time Are Incorrect. . . . .	200
Application Is Blocked by a Firewall (for Windows Only). . . . .	200
A Message Prompting You to Reset the Ink Levels is Displayed. . . . .	200
Ink Spilled. . . . .	200

## **Appendix**

Technical Specifications. . . . .	201
Printer Specifications. . . . .	201
Scanner Specifications. . . . .	202
Interface Specifications. . . . .	202
Fax Specifications. . . . .	202
Network Function List. . . . .	203
Wi-Fi Specifications. . . . .	204
Ethernet Specifications. . . . .	204
Security Protocol. . . . .	205
Supported Third Party Services. . . . .	205
Dimensions. . . . .	205
Electrical Specifications. . . . .	205
Environmental Specifications. . . . .	206
System Requirements. . . . .	206
Regulatory Information. . . . .	207
Standards and Approvals. . . . .	207
Restrictions on Copying. . . . .	208
Transporting and Storing the Printer. . . . .	209
Copyright. . . . .	212
Trademarks. . . . .	212
Where to Get Help. . . . .	213
Technical Support Web Site. . . . .	213
Contacting Epson Support. . . . .	214

# About This Manual

---

## Introduction to the Manuals

The following manuals are supplied with your Epson printer. As well as the manuals, check the various types of help information available from the printer itself or from the Epson software applications.

- Important Safety Instructions (paper manual)  
Provides you with instructions to ensure the safe use of this printer.
- Start Here (paper manual)  
Provides you with information on setting up the printer, installing the software, using the printer, and so on.
- User's Guide (digital manual)  
This manual. Provides overall information and instructions on using the printer, on network settings when using the printer on a network, and on solving problems.

You can obtain the latest versions of the above manuals with the following methods.

- Paper manual  
Visit the Epson Europe support website at <http://www.epson.eu/Support>, or the Epson worldwide support website at <http://support.epson.net/>.
- Digital manual  
Start EPSON Software Updater on your computer. EPSON Software Updater checks for available updates of Epson software applications and the digital manuals, and allows you to download the latest ones.

### Related Information

- ➔ [“Software Update Tools \(EPSON Software Updater\)” on page 161](#)

---

## Using the Manual to Search for Information

The PDF manual allows you to search for information you are looking for by keyword, or jump directly to specific sections using the bookmarks. You can also print only the pages you need. This section explains how to use a PDF manual that has been opened in Adobe Reader X on your computer.

## About This Manual

### Searching by keyword

Click **Edit > Advanced Search**. Enter the keyword (text) for information you want to find in the search window, and then click **Search**. Hits are displayed as a list. Click one of the displayed hits to jump to that page.

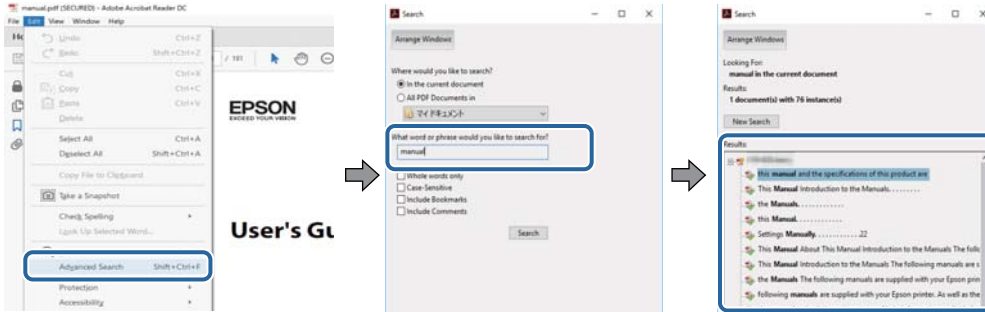

### Jumping directly from bookmarks

Click a title to jump to that page. Click + or > to view the lower level titles in that section. To return to the previous page, perform the following operation on your keyboard.

- ❑ Windows: Hold down **Alt**, and then press ←.
- ❑ Mac OS: Hold down the command key, and then press ←.

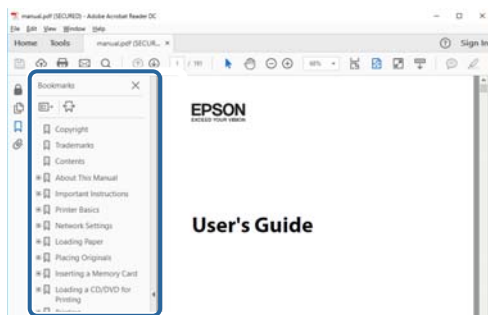

### Printing only the pages you need

You can extract and print only the pages you need. Click **Print** in the **File** menu, and then specify the pages you want to print in **Pages in Pages to Print**.

- ❑ To specify a series of pages, enter a hyphen between the start page and the end page.  
Example: 20-25
- ❑ To specify pages that are not in series, divide the pages with commas.  
Example: 5, 10, 15

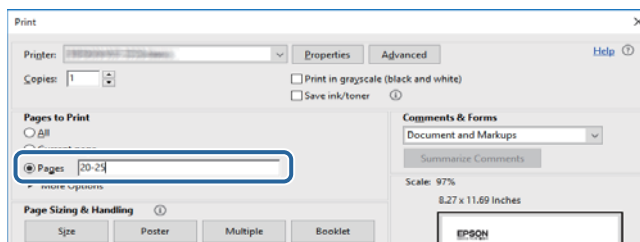



---

## Marks and Symbols

**Caution:**

*Instructions that must be followed carefully to avoid bodily injury.*

**Important:**

*Instructions that must be observed to avoid damage to your equipment.*

**Note:**

*Provides complementary and reference information.*

**Related Information**

➔ Links to related sections.

---

## Descriptions Used in this Manual

- Screenshots of the printer driver and the Epson Scan 2 (scanner driver) screens are from Windows 10 or macOS High Sierra. The content displayed on the screens varies depending on the model and situation.
- Illustrations used in this manual are examples only. Although there may be slight differences depending on the model, the method of operation is the same.
- Some of the menu items on the LCD screen vary depending on the model and settings.
- You can read the QR code using dedicated app.

---

## Operating System References

**Windows**

In this manual, terms such as "Windows 10", "Windows 8.1", "Windows 8", "Windows 7", "Windows Vista", "Windows XP", "Windows Server 2016", "Windows Server 2012 R2", "Windows Server 2012", "Windows Server 2008 R2", "Windows Server 2008", "Windows Server 2003 R2", and "Windows Server 2003" refer to the following operating systems. Additionally, "Windows" is used to refer to all versions.

- Microsoft® Windows® 10 operating system
- Microsoft® Windows® 8.1 operating system
- Microsoft® Windows® 8 operating system
- Microsoft® Windows® 7 operating system
- Microsoft® Windows Vista® operating system
- Microsoft® Windows® XP operating system
- Microsoft® Windows® XP Professional x64 Edition operating system
- Microsoft® Windows Server® 2016 operating system
- Microsoft® Windows Server® 2012 R2 operating system

## About This Manual

- Microsoft® Windows Server® 2012 operating system
- Microsoft® Windows Server® 2008 R2 operating system
- Microsoft® Windows Server® 2008 operating system
- Microsoft® Windows Server® 2003 R2 operating system
- Microsoft® Windows Server® 2003 operating system

### Mac OS

In this manual, "Mac OS" is used to refer to macOS High Sierra, macOS Sierra, OS X El Capitan, OS X Yosemite, OS X Mavericks, OS X Mountain Lion, Mac OS X v10.7.x, and Mac OS X v10.6.8.

# Important Instructions

---

## Safety Instructions

Read and follow these instructions to ensure safe use of this printer. Make sure you keep this manual for future reference. Also, be sure to follow all warnings and instructions marked on the printer.

- Some of the symbols used on your printer are to ensure safety and proper use of the printer. Visit the following Web site to learn the meaning of the symbols.  
<http://support.epson.net/symbols>
- Use only the power cord supplied with the printer and do not use the cord with any other equipment. Use of other cords with this printer or the use of the supplied power cord with other equipment may result in fire or electric shock.
- Be sure your AC power cord meets the relevant local safety standard.
- Never disassemble, modify, or attempt to repair the power cord, plug, printer unit, or options by yourself, except as specifically explained in the printer's manuals.
- Unplug the printer and refer servicing to qualified service personnel under the following conditions:  
The power cord or plug is damaged; liquid has entered the printer; the printer has been dropped or the casing damaged; the printer does not operate normally or exhibits a distinct change in performance. Do not adjust controls that are not covered by the operating instructions.
- Place the printer near a wall outlet where the plug can be easily unplugged.
- Do not place or store the printer outdoors, near excessive dirt or dust, water, heat sources, or in locations subject to shocks, vibrations, high temperature or humidity.
- Take care not to spill liquid on the printer and not to handle the printer with wet hands.
- Keep the printer at least 22 cm away from cardiac pacemakers. Radio waves from this printer may adversely affect the operation of cardiac pacemakers.
- If the LCD screen is damaged, contact your dealer. If the liquid crystal solution gets on your hands, wash them thoroughly with soap and water. If the liquid crystal solution gets into your eyes, flush them immediately with water. If discomfort or vision problems remain after a thorough flushing, see a doctor immediately.
- Avoid using a telephone during an electrical storm. There may be a remote risk of electric shock from lightning.
- Do not use a telephone to report a gas leak in the vicinity of the leak.

## Safety Instructions for Ink

- Be careful not to touch any ink when you handle the ink tanks, ink tank caps, and opened ink bottles or ink bottle caps.
  - If ink gets on your skin, wash the area thoroughly with soap and water.
  - If ink gets into your eyes, flush them immediately with water. If discomfort or vision problems continue after a thorough flushing, see a doctor immediately.
  - If ink gets into your mouth, see a doctor right away.
- Do not shake an ink bottle too vigorously or subject it to strong impacts as this can cause ink to leak.

## Important Instructions

- ❑ Keep ink bottles and the ink tank unit out of the reach of children. Do not allow children to drink from or handle the ink bottles and ink bottle cap.

---

## Printer Advisories and Warnings

Read and follow these instructions to avoid damaging the printer or your property. Make sure you keep this manual for future reference.



### Advisories and Warnings for Setting Up the Printer

- ❑ Do not block or cover the vents and openings in the printer.
- ❑ Use only the type of power source indicated on the printer's label.
- ❑ Avoid using outlets on the same circuit as photocopiers or air control systems that regularly switch on and off.
- ❑ Avoid electrical outlets controlled by wall switches or automatic timers.
- ❑ Keep the entire computer system away from potential sources of electromagnetic interference, such as loudspeakers or the base units of cordless telephones.
- ❑ The power-supply cords should be placed to avoid abrasions, cuts, fraying, crimping, and kinking. Do not place objects on top of the power-supply cords and do not allow the power-supply cords to be stepped on or run over. Be particularly careful to keep all the power-supply cords straight at the ends and the points where they enter and leave the transformer.
- ❑ If you use an extension cord with the printer, make sure that the total ampere rating of the devices plugged into the extension cord does not exceed the cord's ampere rating. Also, make sure that the total ampere rating of all devices plugged into the wall outlet does not exceed the wall outlet's ampere rating.
- ❑ If you plan to use the printer in Germany, the building installation must be protected by a 10 or 16 amp circuit breaker to provide adequate short-circuit protection and over-current protection for the printer.
- ❑ When connecting the printer to a computer or other device with a cable, ensure the correct orientation of the connectors. Each connector has only one correct orientation. Inserting a connector in the wrong orientation may damage both devices connected by the cable.
- ❑ Place the printer on a flat, stable surface that extends beyond the base of the printer in all directions. The printer will not operate properly if it is tilted at an angle.
- ❑ Allow space above the printer so that you can fully raise the document cover.
- ❑ Leave enough space in front of the printer for the paper to be fully ejected.
- ❑ Avoid places subject to rapid changes in temperature and humidity. Also, keep the printer away from direct sunlight, strong light, or heat sources.

### Advisories and Warnings for Using the Printer

- ❑ Do not insert objects through the slots in the printer.
- ❑ Do not put your hand inside the printer during printing.
- ❑ Do not touch the white flat cable and ink tubes inside the printer.
- ❑ Do not use aerosol products that contain flammable gases inside or around the printer. Doing so may cause fire.
- ❑ Do not move the print head by hand; otherwise, you may damage the printer.

## Important Instructions

- ❑ Be careful not to trap your fingers when closing the document cover.
- ❑ Do not press too hard on the scanner glass when placing the originals.
- ❑ If any of the ink tanks are not filled up to the lower line, refill the ink soon. Prolonged use of the printer when the ink level is below the lower line could damage the printer.
- ❑ Always turn the printer off using the  button. Do not unplug the printer or turn off the power at the outlet until the  light stops flashing.
- ❑ If you are not going to use the printer for a long period, be sure to unplug the power cord from the electrical outlet.

## Advisories and Warnings for Transporting or Storing the Printer

- ❑ When storing or transporting the printer, avoid tilting it, placing it vertically, or turning it upside down; otherwise ink may leak.
- ❑ Before transporting the printer, make sure that the print head is in the home (far right) position.

## Advisories and Warnings for Using the Printer with a Wireless Connection

- ❑ Radio waves from this printer may negatively affect the operation of medical electronic equipment, causing them to malfunction. When using this printer inside medical facilities or near medical equipment, follow directions from the authorized personnel representing the medical facilities, and follow all posted warnings and directions on the medical equipment.
- ❑ Radio waves from this printer may negatively affect the operation of automatically controlled devices such as automatic doors or fire alarms, and could lead to accidents due to malfunction. When using this printer near automatically controlled devices, follow all posted warnings and directions on these devices.

## Advisories and Warnings for Using the LCD Screen

- ❑ The LCD screen may contain a few small bright or dark spots, and because of its features it may have an uneven brightness. These are normal and do not indicate that it is damaged in any way.
- ❑ Only use a dry, soft cloth for cleaning. Do not use liquid or chemical cleaners.
- ❑ The exterior cover of the LCD screen could break if it receives a heavy impact. Contact your dealer if the screen's surface chips or cracks, and do not touch or attempt to remove the broken pieces.

---

## Protecting Your Personal Information

When you give the printer to someone else or dispose of it, erase all the personal information stored in the printer's memory by selecting **Settings > Restore Default Settings > Clear All Data and Settings** on the control panel.

# Printer Basics

## Part Names and Functions

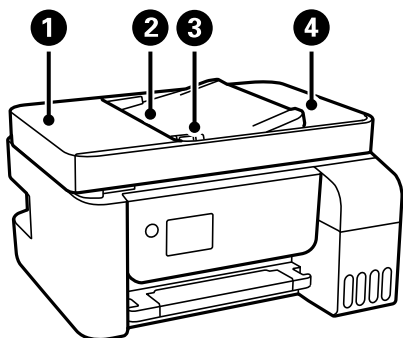

1	ADF (Automatic Document Feeder) cover	Open when removing jammed originals in the ADF.
2	ADF input tray	Feeds originals automatically.
3	ADF edge guide	Feeds originals straight into the printer. Slide to the edge of the originals.
4	ADF output tray	Holds originals ejected from the ADF.

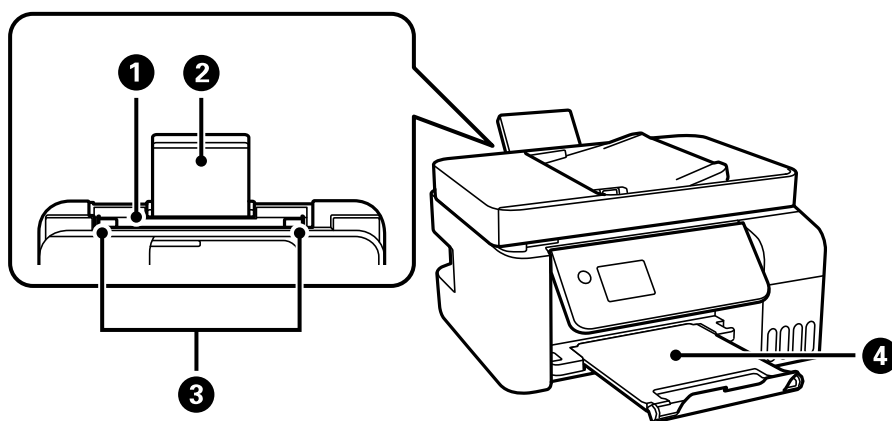

1	Rear paper feed	Loads paper.
2	Paper support	Supports loaded paper.
3	Edge guides	Feeds the paper straight into the printer. Slide to the edges of the paper.
4	Output tray	Holds the ejected paper.

**Printer Basics**

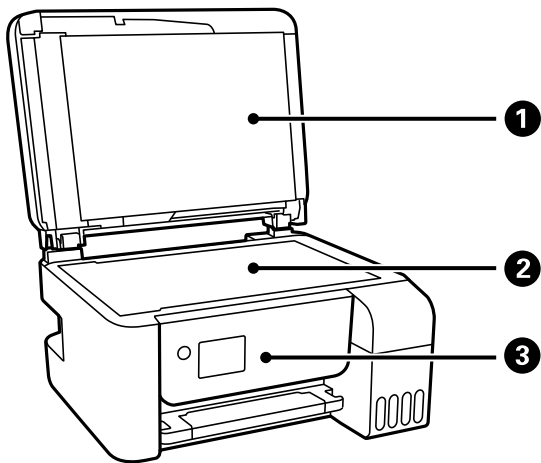

1	Document cover	Blocks external light while scanning.
2	Scanner glass	Place the originals.
3	Control panel	Indicates the printer's status and allows you to make print settings.

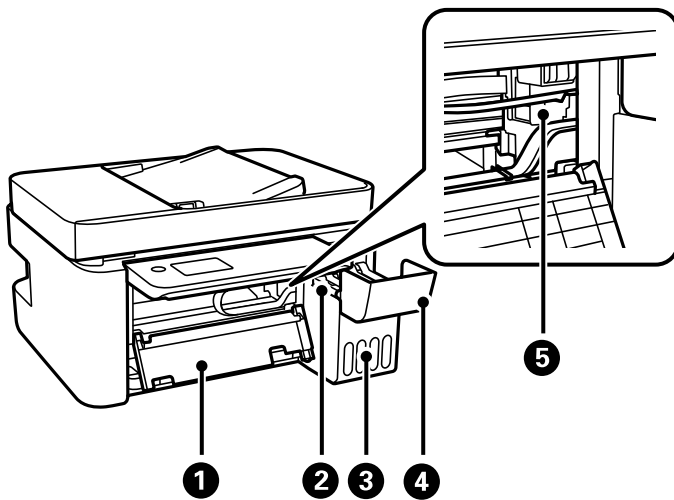

1	Inner cover	Open when removing jammed paper inside the printer.
2	Ink tank unit	Contains the ink tanks.
3	Ink reservoir tank (Ink tank)	Supplies ink to the print head.
4	Ink tank cover	Open to refill the ink tank.
5	Print head	Ink is ejected from the print head nozzles underneath.

### Printer Basics

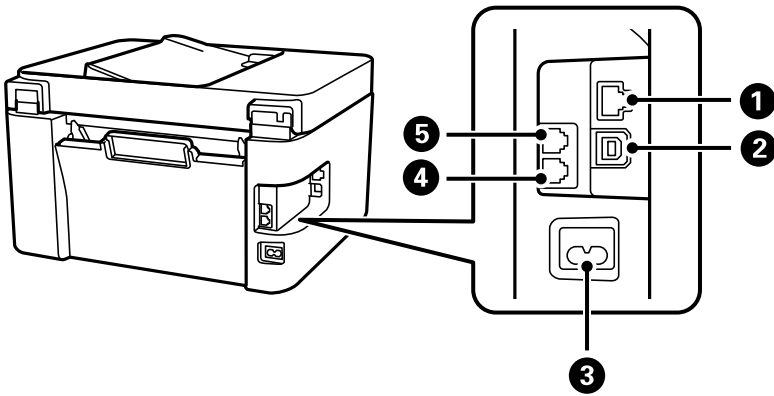

①	LAN port	Connects a LAN cable.
②	USB port	Connects a USB cable to connect with a computer.
③	AC inlet	Connects the power cord.
④	EXT. port	Connects external phone devices.
⑤	LINE port	Connects a phone line.

#### Related Information

➔ [“Control Panel” on page 16](#)

## Control Panel

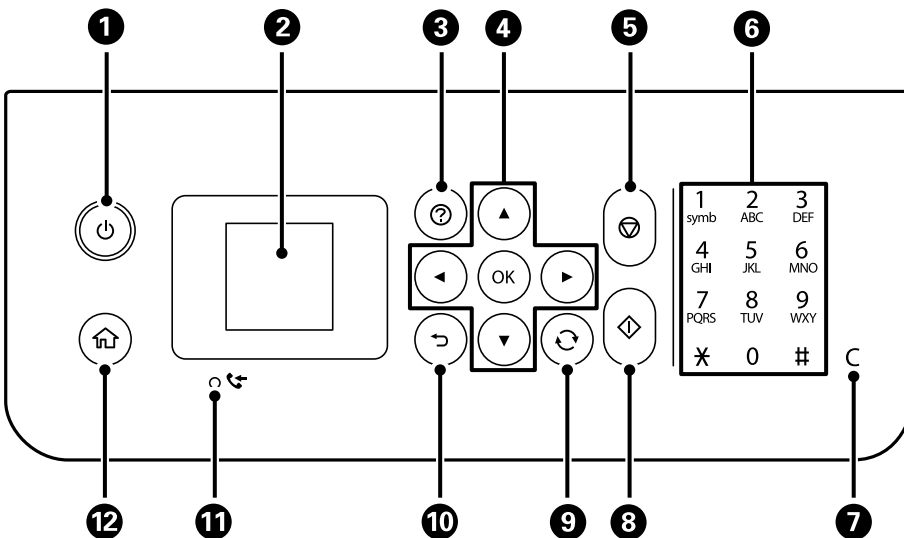

①	Turns the printer on or off. Unplug the power cord after checking that the power light is off.
②	Displays menus and messages. Use buttons on the control panel to select a menu or to make settings.



## Printer Basics

③	Displays the solutions when you are in trouble.
④	Use the ▲▼◀▶ buttons to select a menu, and then ppress the OK button to enter the selected menu.
⑤	Stops the current operation.
⑥	Enters numbers, characters, and symbols.
⑦	Clears number settings such as the number of copies.
⑧	Starts an operation such as printing or copying.
⑨	Applies to a variety of functions depending on the situation.
⑩	Returns to the previous screen.
⑪	Turns on when received documents that have not yet been printed or saved are stored in the printer's memory.
⑫	Displays the home screen.

## Guide to the LCD Screen





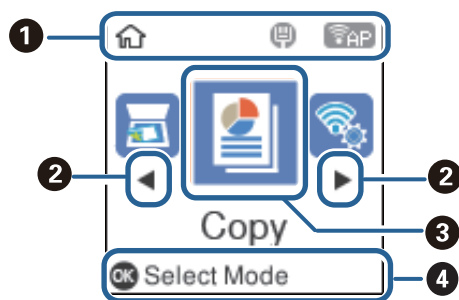

Menus and messages are displayed on the LCD screen. Select a menu or setting by pressing the ▲▼◀▶ buttons.

## Guide to the Home Screen

The following icons and menus are displayed on the home screen.



## Printer Basics

①	Icons that show the network status are displayed.	
		The printer is not connected to a wired (Ethernet) network or unset it.
		The printer is connected to a wired (Ethernet) network.
		Indicates that a wireless (Wi-Fi) network is disabled, or that the printer is processing a wireless network connection.
		Indicates a problem with the printer's wireless (Wi-Fi) network connection, or that the printer is searching for a wireless (Wi-Fi) network connection.
		Indicates that the printer is connected to a wireless (Wi-Fi) network. The number of bars indicates the signal strength of the connection. The more bars there are, the stronger the connection.
		Indicates that Wi-Fi Direct (Simple AP) is enabled.
		Indicates that Wi-Fi Direct (Simple AP) is disabled.
②	When ◀ and ▶ are displayed, you can scroll right or left by pressing the ◀ or ▶ button.	
③	Function icons and names are displayed as menu icons.	
	Copy	Enters <b>Copy</b> menu that allows you to copy a document.
	Scan	Enters <b>Scan</b> menu that allows you to scan a document or a photo.
	Fax	Enters <b>Fax</b> menu that allows you to send faxes.
	Quiet Mode	Displays <b>Quiet Mode</b> setting that allows you to reduce the noise the printer makes. However, enabling this may reduce print speed. Depending on the paper type and print quality settings you selected, there may be no difference in the printer's noise level.  This is a shortcut to the following menu. <b>Settings &gt; Printer Setup &gt; Quiet Mode</b>
	Settings	Displays <b>Settings</b> menu that allows you to make settings related to maintenance, printer setup, and network settings.
	Maintenance	Displays the menus recommended to improve the quality of your printouts such as unclogging nozzles by printing a nozzle check pattern and performing head cleaning, and improving blurring or banding in your printouts by aligning the print head. This is a shortcut to the following menu. <b>Settings &gt; Maintenance</b>
	Wi-Fi Setup	Displays menus that allow you to set up the printer for use on a wireless network. This is a shortcut to the following menu. <b>Settings &gt; Network Settings &gt; Wi-Fi Setup</b>
④	Available buttons are displayed. In this example, you can proceed to the selected menu by pressing the OK button.	



## Entering Characters

To enter characters and symbols for network settings and register contacts from the control panel, use the 12-key numeric keypad. To clear all characters, press the **C** button.

## Printer Basics

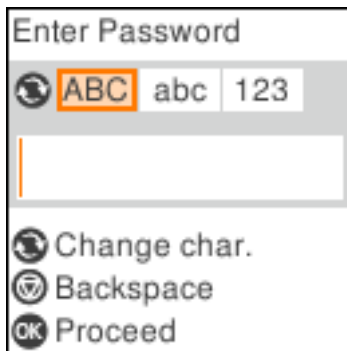
The following is the screen for entering the password for your Wi-Fi network. The displayed screen varies depending on the setting items.



Buttons	Descriptions
	Switches the character type. ABC: Uppercase characters abc: Lowercase characters 123: Numbers and symbols
	Deletes a character to the left (backspace).
OK	Enters the selected characters.

**Note:**

- Pressing the ◀▶ buttons moves the cursor to the left or right.
- Pressing the ↶ button returns to the previous screen.

# Network Settings

---

## Network Connection Types

You can use the following connection methods.

### Ethernet Connection

Connect the printer to a hub with an Ethernet cable.

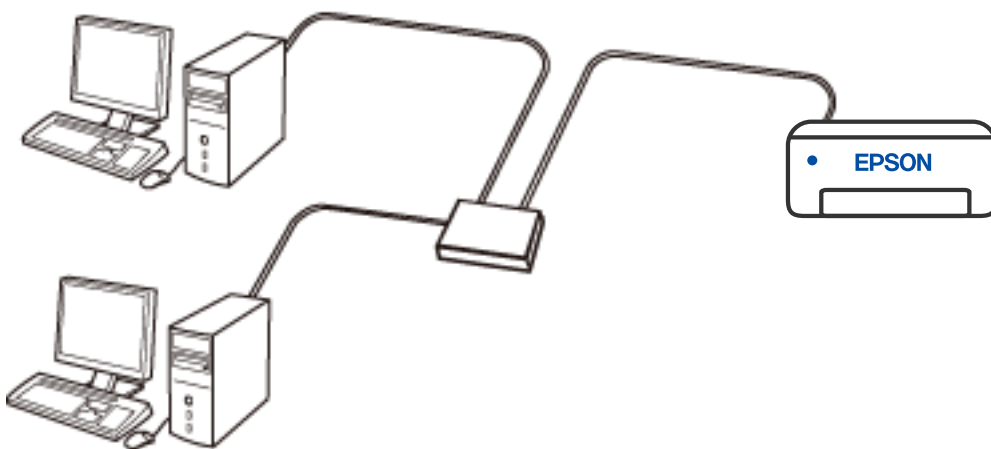

### Wi-Fi Connection

Connect the printer and the computer or smart device to the wireless router. This is the typical connection method for home or office networks where computers are connected by Wi-Fi through the wireless router.

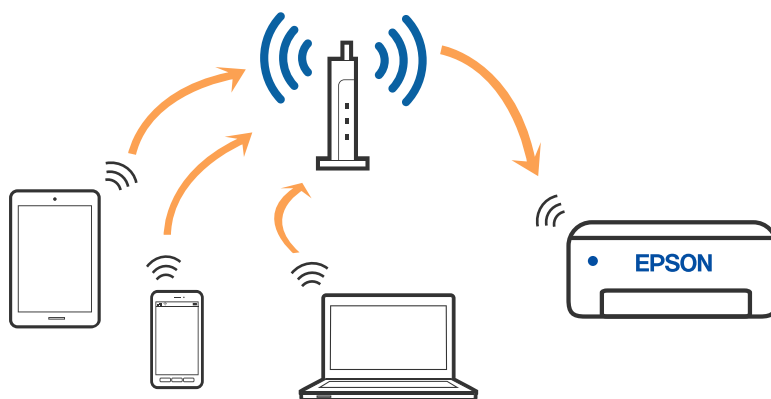

### Related Information

➔ [“Connecting to a Computer” on page 21](#)

- ➔ “Connecting to a smart device over a wireless router” on page 22
- ➔ “Making Wi-Fi Settings from the Printer” on page 31

## Wi-Fi Direct (Simple AP) Connection

Use this connection method when you are not using Wi-Fi at home or at the office, or when you want to connect the printer and the computer or smart device directly. In this mode, the printer acts as an wireless router and you can connect the devices to the printer without having to use a standard wireless router. However, devices directly connected to the printer cannot communicate with each other through the printer.

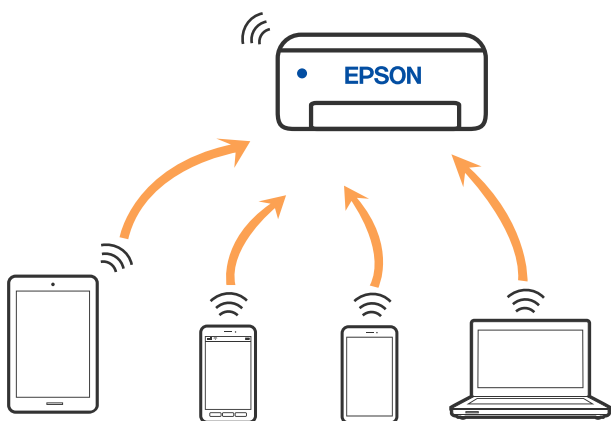

The printer can be connected by Wi-Fi or Ethernet, and Wi-Fi Direct (Simple AP) connection simultaneously. However, if you start a network connection in Wi-Fi Direct (Simple AP) connection when the printer is connected by Wi-Fi, the Wi-Fi is temporarily disconnected.

### Related Information

- ➔ “Connecting to an iPhone, iPad, or iPod touch using Wi-Fi Direct” on page 22
- ➔ “Connecting to Android Devices using Wi-Fi Direct” on page 26
- ➔ “Connecting to Devices other than iOS and Android using Wi-Fi Direct” on page 28

---

## Connecting to a Computer

We recommend using the installer to connect the printer to a computer. You can run the installer using one of the following methods.

- Setting up from the website

Access the following website, and then enter the product name. Go to **Setup**, and then start setting up.

<http://epson.sn>

- Setting up using the software disc (only for the models that come with a software disc and users with Windows computers with disc drives.)

Insert the software disc into the computer, and then follow the on-screen instructions.

### Selecting the Connection Methods

Follow the on-screen instructions until the following screen is displayed, and then select the connection method of the printer to the computer.

## Network Settings

Select the connection type and then click **Next**.

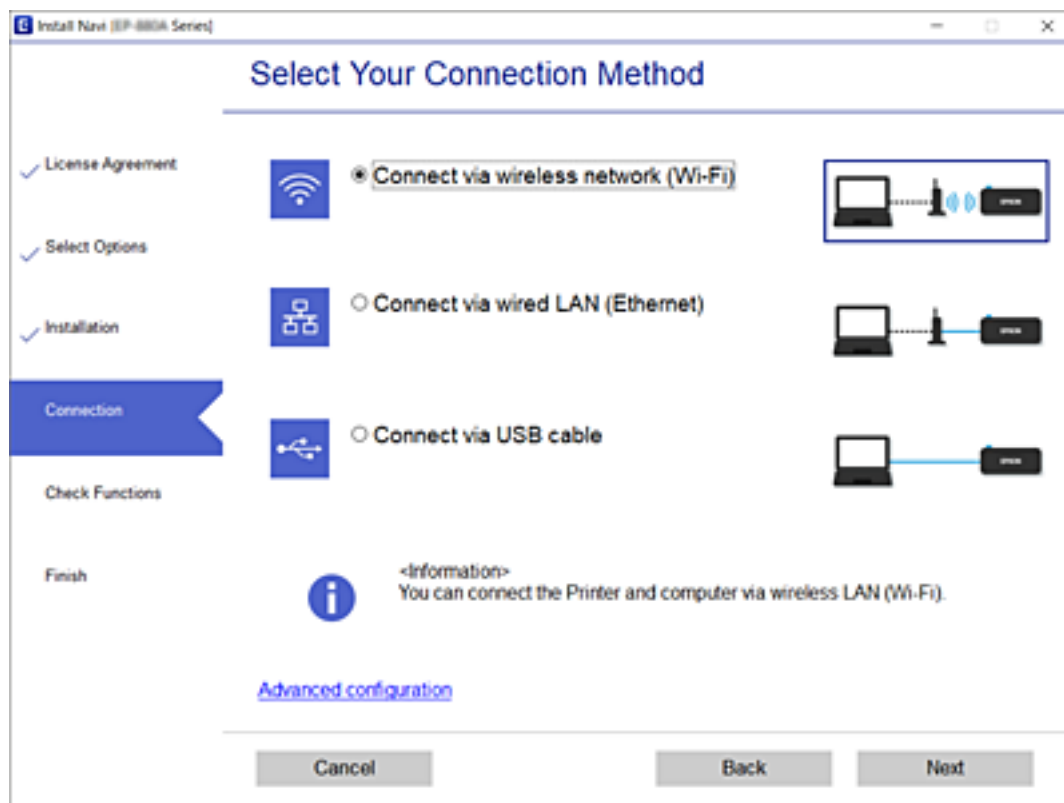

Follow the on-screen instructions.

## Connecting to a Smart Device

### Connecting to a smart device over a wireless router

You can use the printer from a smart device when you connect the printer to the same Wi-Fi network (SSID) as the smart device. To use the printer from a smart device, set up from the following website. Access to the website from the smart device that you want to connect to the printer.

<http://epson.sn> > Setup

**Note:**

*If you want to connect a computer and a smart device to the printer at the same time, we recommend setting up from the computer first by using the installer.*

**Related Information**

➔ [“Printing from Smart Devices” on page 103](#)

### Connecting to an iPhone, iPad, or iPod touch using Wi-Fi Direct

This method allows you to connect the printer directly to an iPhone, iPad, or iPod touch without a wireless router. The following conditions are required to connect using this method. If your environment does not match these

## Network Settings

conditions, you can connect by selecting **Other OS Devices**. See "Related Information" below for details on connecting.

- ❑ iOS 11 or later
- ❑ Using the standard camera application to scan the QR code
- ❑ Epson iPrint version 7.0 or later

Epson iPrint is used to print from a smart device. Install Epson iPrint on the smart device in advance.

**Note:**

*You only need to make these settings for the printer and the smart device that you want to connect to once. Unless you disable Wi-Fi Direct or restore the network settings to their defaults, you do not need to make these settings again.*

1. Select **Wi-Fi Setup** on the home screen.

To select an item, use the ▲ ▼ ◀ ▶ buttons, and then press the OK button.

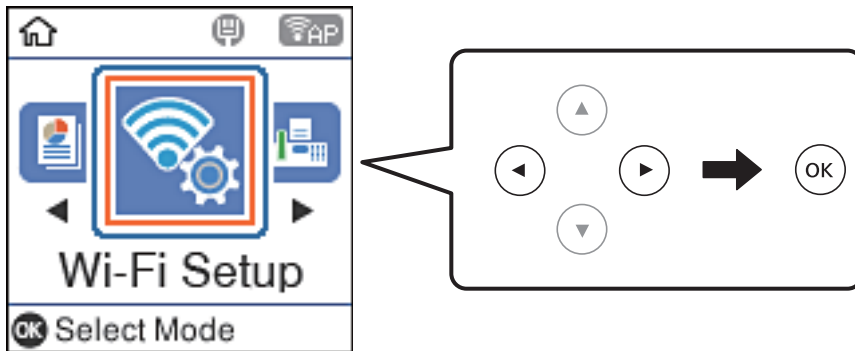

2. Select **Wi-Fi Direct**.
3. Check the message, and then press the OK button to proceed.
4. Check the message, and then press the OK button to proceed.
5. Select **iOS**.

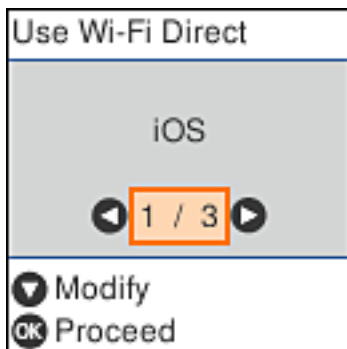

### Network Settings

6. Check the message, and then press the OK button to proceed.

The QR code is displayed on the printer's control panel.

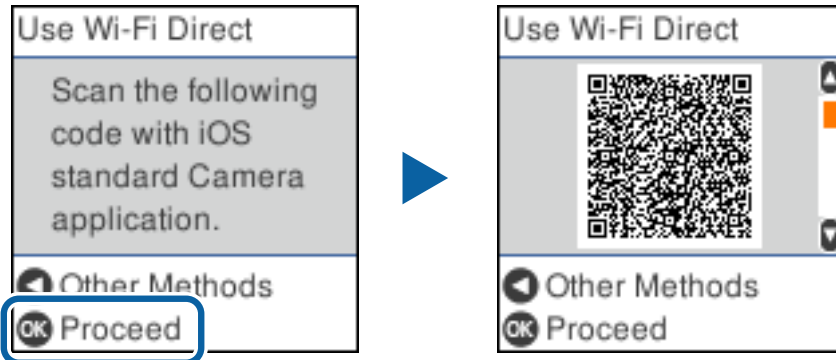

7. On your iPhone, iPad, or iPod touch, start the standard Camera app, and then scan the QR code displayed on the printer's control panel in PHOTO mode.

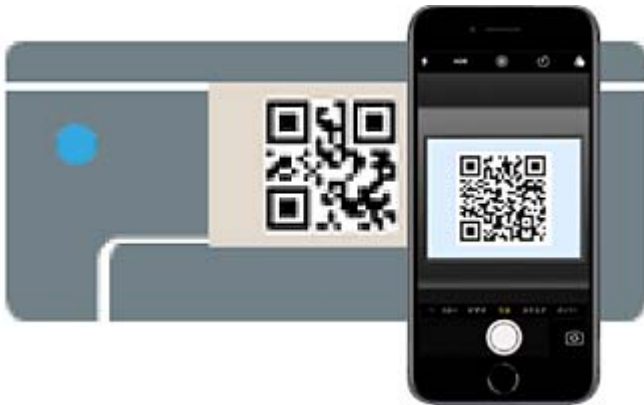

Use the Camera app for iOS 11 or later. You cannot connect to the printer using the Camera app for iOS 10 or earlier. Also, you cannot connect using an app for scanning QR codes. If you cannot connect, press the ◀ button. See "Related Information" below for details on connecting.

8. Tap the notification displayed on the screen of the iPhone, iPad, or iPod touch.

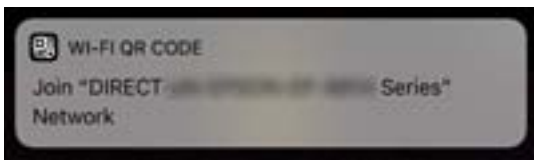

9. Tap **Join**.

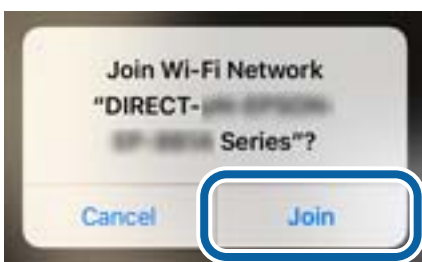



## Network Settings

10. On the printer's control panel, press the OK button.
11. On the iPhone, iPad, or iPod touch, start Epson printing app.

Examples of Epson printing apps



Epson iPrint



Epson Creative Print

12. On the Epson iPrint screen, tap **Printer is not selected.**
13. Select the printer that you want to connect to.



See the information displayed on the printer's control panel to select the printer.

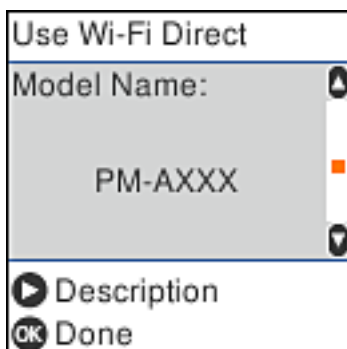

14. On the printer's control panel, press the OK button.

For smart devices that have been connected to the printer before, select the network name (SSID) on the smart device's Wi-Fi screen to connect them again.

## Network Settings

### Related Information

- ➔ “Connecting to Devices other than iOS and Android using Wi-Fi Direct” on page 28
- ➔ “Printing from Smart Devices” on page 103

## Connecting to Android Devices using Wi-Fi Direct

This method allows you to connect the printer directly to your Android device without a wireless router. The following conditions are required to use this function.

- Android 4.4 or later
- Epson iPrint version 7.0 or later

Epson iPrint is used to print from a smart device. Install Epson iPrint on the smart device in advance.

**Note:**

*You only need to make these settings for the printer and the smart device that you want to connect to once. Unless you disable Wi-Fi Direct or restore the network settings to their defaults, you do not need to make these settings again.*

1. Select **Wi-Fi Setup** on the home screen.

To select an item, use the ▲ ▼ ◀ ▶ buttons, and then press the OK button.

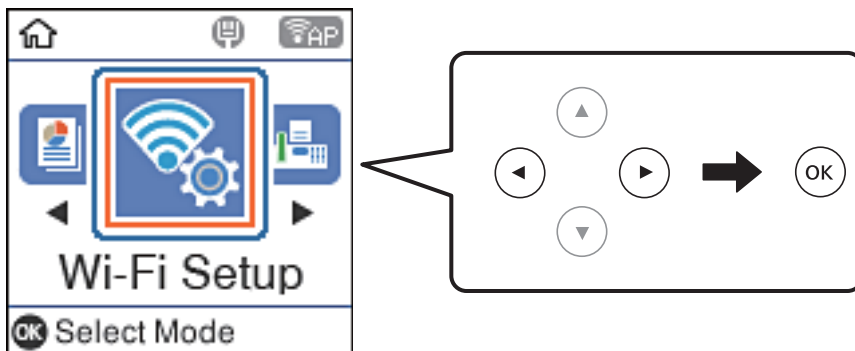

2. Select **Wi-Fi Direct**.
3. Check the message, and then press the OK button to proceed.
4. Check the message, and then press the OK button to proceed.
5. Select **Android**.



## Network Settings

- On the smart device, start Epson iPrint.



- On the Epson iPrint screen, tap **Printer is not selected..**
- Select the printer that you want to connect to.

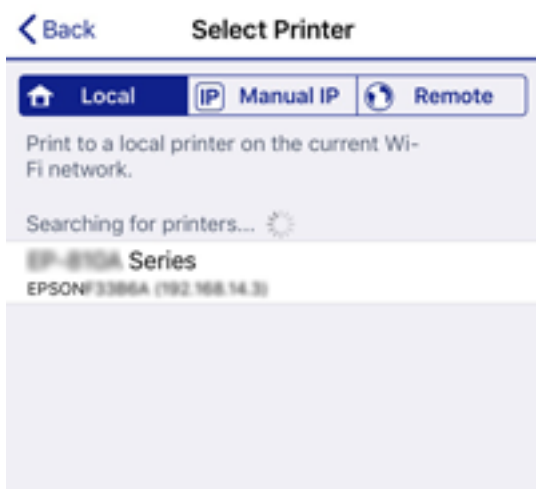

See the information displayed on the printer's control panel to select the printer.

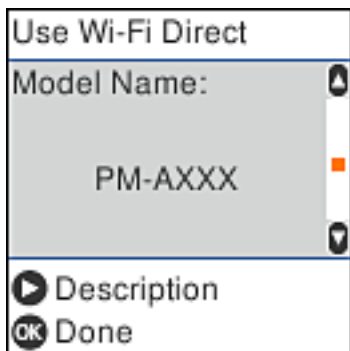

**Note:**

Printers may not be displayed depending on the Android device. If printers are not displayed, connect by selecting **Other OS Devices**. See "Related Information" below for connecting.

- When the device connection approval screen is displayed, select **Approve**.
- On the printer's control panel, press the OK button.

For smart devices that have been connected to the printer before, select the network name (SSID) on the smart device's Wi-Fi screen to connect them again.

### Related Information

➔ ["Connecting to Devices other than iOS and Android using Wi-Fi Direct" on page 28](#)

➔ “Printing from Smart Devices” on page 103

## Connecting to Devices other than iOS and Android using Wi-Fi Direct

This method allows you to connect the printer directly to smart devices without a wireless router.

**Note:**

*You only need to make these settings for the printer and the smart device that you want to connect to once. Unless you disable Wi-Fi Direct or restore the network settings to their defaults, you do not need to make these settings again.*

1. Select **Wi-Fi Setup** on the home screen.

To select an item, use the ▲ ▼ ◀ ▶ buttons, and then press the OK button.

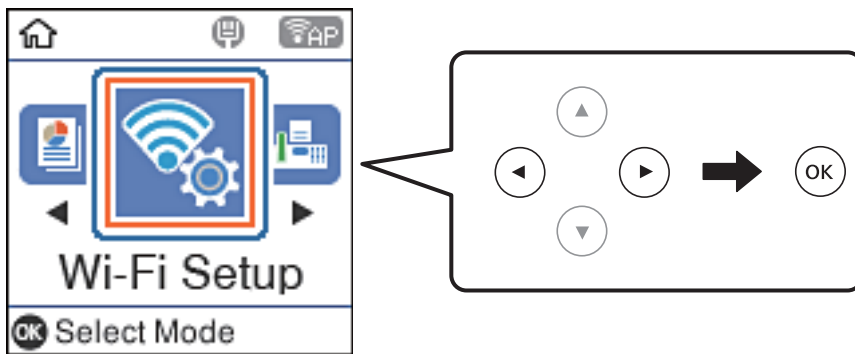

2. Select **Wi-Fi Direct**.
3. Check the message, and then press the OK button to proceed.
4. Check the message, and then press the OK button to proceed.
5. Select **Other OS Devices**.



The Network Name and Password for Wi-Fi Direct for the printer are displayed.

### Network Settings

- On the smart device's Wi-Fi screen, select the SSID shown on the printer's control panel, and then enter the password.

The screenshot is an example on iPhone.



- On the printer's control panel, press the OK button.

## Network Settings

- On the smart device, start Epson printing app.

Examples of Epson printing apps



Epson iPrint



Epson Creative Print

- On the Epson printing app screen, tap **Printer is not selected..**
- Select the printer that you want to connect to.

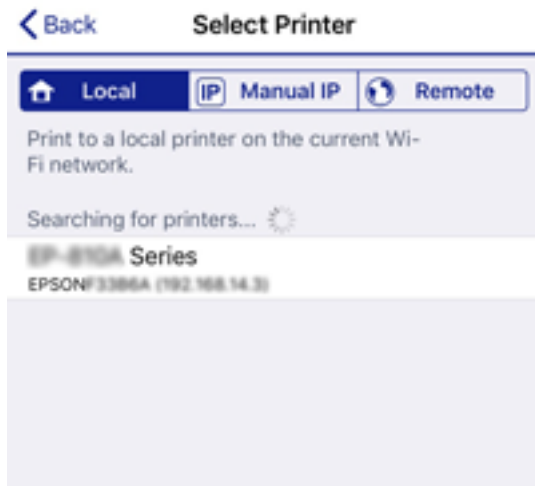

See the information displayed on the printer's control panel to select the printer.

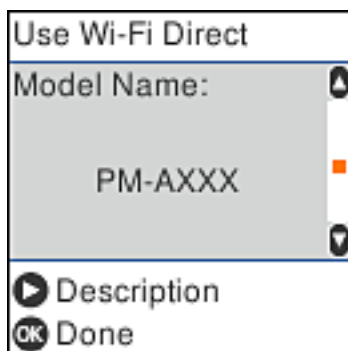

- On the printer's control panel, press the OK button.

For smart devices that have been connected to the printer before, select the network name (SSID) on the smart device's Wi-Fi screen to connect them again.

### Related Information

➔ [“Printing from Smart Devices” on page 103](#)

## Making Wi-Fi Settings from the Printer

You can make network settings from the printer's control panel in several ways. Choose the connection method that matches the environment and conditions that you are using.

If you know the information for the access point such as SSID and password, you can make settings manually.

If the access point supports WPS, you can make settings by using push button setup.

After connecting the printer to the network, connect to the printer from the device that you want to use (computer, smart device, tablet, and so on.)

### Related Information

- ➔ “Making Wi-Fi Settings by Entering the SSID and Password” on page 31
- ➔ “Making Wi-Fi Settings by Push Button Setup” on page 32
- ➔ “Making Wi-Fi Settings by PIN Code Setup (WPS)” on page 33

## Making Wi-Fi Settings by Entering the SSID and Password

You can set up a Wi-Fi network by entering the information necessary to connect to a wireless router from the printer's control panel. To set up using this method, you need the SSID and password for a wireless router.

### Note:

If you are using an wireless router with its default settings, the SSID and password are on the label. If you do not know the SSID and password, contact the person who set up the wireless router, or see the documentation provided with the wireless router.

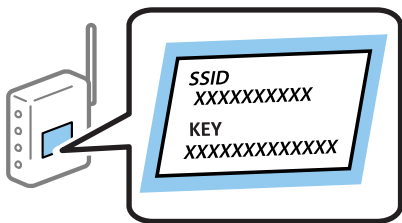

1. Select **Wi-Fi Setup** on the home screen.  
To select an item, use the ▲ ▼ ◀ ▶ buttons, and then press the OK button.
2. Select **Wi-Fi (Recommended)**.
3. Press the OK button to proceed.
4. Select **Wi-Fi Setup Wizard**.
5. Select the SSID for the wireless router from printer's control panel, and then press the OK button.

### Note:

- If the SSID you want to connect to is not displayed on the printer's control panel, press the  button to update the list. If it is still not displayed, select **Other SSIDs**, and then enter the SSID directly.
- If you do not know the SSID, check if it is written on the label of the wireless router. If you are using the wireless router with its default settings, use the SSID written on the label.

## Network Settings

6. Enter the password.

Select whether or not you print a network connection report after finishing the settings.

**Note:**

- ❑ The password is case-sensitive.
- ❑ If you do not know the network name (SSID) check if the information is written on the label of the wireless router. If you are using the wireless router with its default settings, use the SSID on the label. If you cannot find any information, see the documentation provided with the wireless router.

7. When you have setup finished, and then press the  button.

**Note:**

If you fail to connect, load paper, and then press the  button to print a network connection report.

### Related Information





- ➔ [“Entering Characters” on page 18](#)
- ➔ [“Checking the Network Connection Status” on page 33](#)
- ➔ [“When You Cannot Make Network Settings” on page 179](#)

## Making Wi-Fi Settings by Push Button Setup

You can automatically set up a Wi-Fi network by pressing a button on the wireless router. If the following conditions are met, you can set up by using this method.

- ❑ The wireless router is compatible with WPS (Wi-Fi Protected Setup).
- ❑ The current Wi-Fi connection was established by pressing a button on the wireless router.

1. Select **Wi-Fi Setup** on the home screen.

To select an item, use the     buttons, and then press the OK button.

2. Select **Wi-Fi (Recommended)**.
3. Press the OK button to proceed.
4. Select **Push Button Setup (WPS)**.
5. Hold down the [WPS] button on the wireless router until the security light flashes.

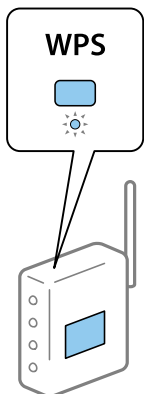



## Network Settings

If you do not know where the [WPS] button is, or there are no buttons on the wireless router, see the documentation provided with your wireless router for details.

6. Press the OK button on the printer's control panel. Follow the on-screen instruction hereafter.

**Note:**

*If connection fails, restart the wireless router, move it closer to the printer, and try again. If it still does not work, print a network connection report and check the solution.*

### Related Information

- ➔ [“Checking the Network Connection Status” on page 33](#)
- ➔ [“When You Cannot Make Network Settings” on page 179](#)

## Making Wi-Fi Settings by PIN Code Setup (WPS)

You can automatically connect to an wireless router by using a PIN code. You can use this method to set up if an wireless router is capable of WPS (Wi-Fi Protected Setup). Use a computer to enter a PIN code into the wireless router.

1. Select **Wi-Fi Setup** on the home screen.

To select an item, use the ▲ ▼ ◀▶ buttons, and then press the OK button.

2. Select **Wi-Fi (Recommended)**.
3. Press the OK button to proceed.
4. Select **Others**.
5. Select **PIN Code (WPS)**.
6. Use your computer to enter the PIN code (an eight digit number) displayed on the printer's control panel into the wireless router within two minutes.

**Note:**

*See the documentation provided with your wireless router for details on entering a PIN code.*

7. Press the OK button on the printer.

Setup is complete when the setup completion message is displayed.

**Note:**

*If connection fails, restart the wireless router, move it closer to the printer, and try again. If it still does not work, print a connection report and check the solution.*

### Related Information

- ➔ [“Checking the Network Connection Status” on page 33](#)
- ➔ [“When You Cannot Make Network Settings” on page 179](#)

---

## Checking the Network Connection Status

You can check the network connection status in the following way.

## Network Icon

You can check the network connection status and strength of the radio wave using the network icon on the printer's home screen.



### Related Information

➔ [“Guide to the LCD Screen” on page 17](#)

## Printing a Network Connection Report

You can print a network connection report to check the status between the printer and the wireless router.

1. Load papers.
2. Select **Settings** on the home screen, and then press the OK button.  
To select an item, use the ▲ ▼ ◀ ▶ buttons, and then press the OK button.
3. Select **Network Settings > Connection Check**.  
The connection check starts.
4. Press the ◊ button to print the network connection report.  
If an error has occurred, check the network connection report, and then follow the printed solutions.

### Related Information

➔ [“Messages and Solutions on the Network Connection Report” on page 35](#)

## Network Settings

### Messages and Solutions on the Network Connection Report

Check the messages and error codes on the network connection report, and then follow the solutions.

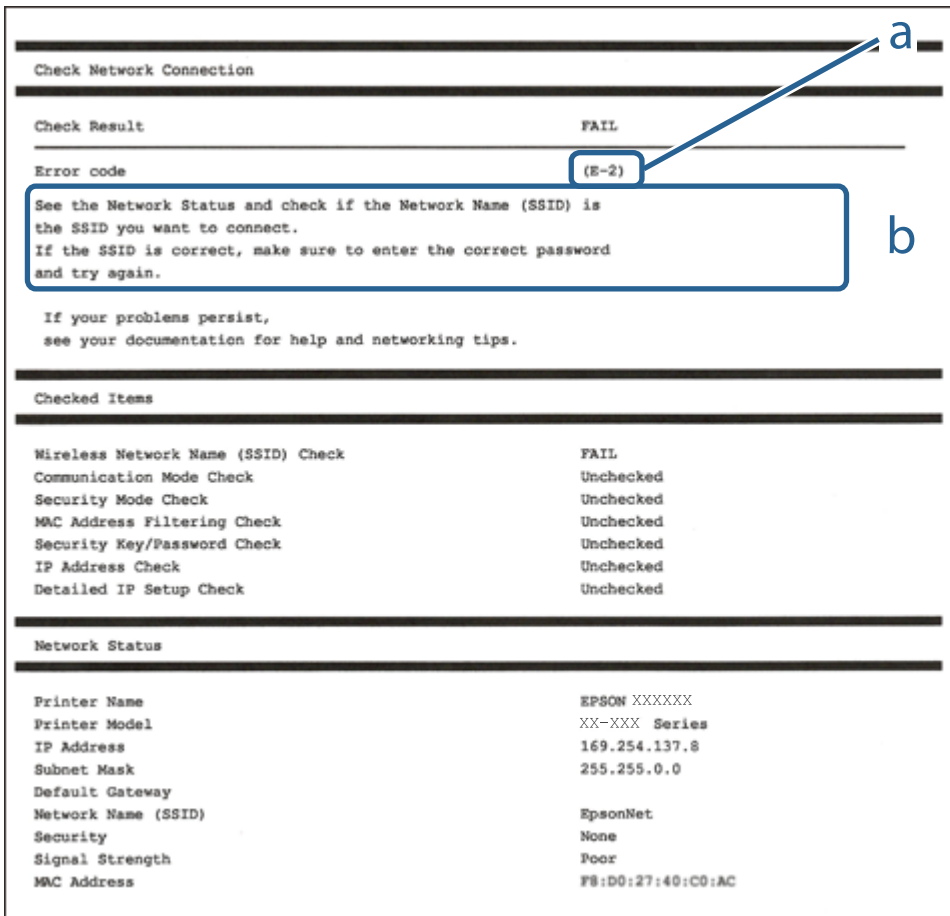

- a. Error code
- b. Messages on the Network Environment

#### Related Information

- ➔ “E-1” on page 36
- ➔ “E-2, E-3, E-7” on page 36
- ➔ “E-5” on page 37
- ➔ “E-6” on page 37
- ➔ “E-8” on page 37
- ➔ “E-9” on page 38
- ➔ “E-10” on page 38
- ➔ “E-11” on page 38
- ➔ “E-12” on page 39
- ➔ “E-13” on page 39
- ➔ “Message on the Network Environment” on page 40

## Network Settings

### E-1

#### Solutions:

- Make sure the Ethernet cable is securely connected to your printer and to your hub or other network device.
- Make sure your hub or other network device is turned on.
- If you want to connect the printer by Wi-Fi, make Wi-Fi settings for the printer again because it is disabled.

### E-2, E-3, E-7

#### Solutions:

- Make sure your wireless router is turned on.
- Confirm that your computer or device is connected correctly to the wireless router.
- Turn off the wireless router. Wait for about 10 seconds, and then turn it on.
- Place the printer closer to your wireless router and remove any obstacles between them.
- If you have entered the SSID manually, check if it is correct. Check the SSID from the **Network Status** part on the network connection report.
- If an wireless router has multiple SSIDs, select the SSID that is displayed. When the SSID is using a non-compliant frequency, the printer does not display them.
- If you are using push button setup to establish a network connection, make sure your wireless router supports WPS. You cannot use push button setup if your wireless router does not support WPS.
- Make sure your SSID uses only ASCII characters (alphanumeric characters and symbols). The printer cannot display an SSID that contains non-ASCII characters.
- Make sure you know your SSID and password before connecting to the wireless router. If you are using a wireless router with its default settings, the SSID and password are located on a label on the wireless router. If you do not know your SSID and password, contact the person who set up the wireless router, or see the documentation provided with the wireless router.
- If you are connecting to an SSID generated from a tethering smart device, check for the SSID and password in the documentation provided with the smart device.
- If your Wi-Fi connection suddenly disconnects, check for the conditions below. If any of these conditions are applicable, reset your network settings by downloading and running the software from the following website.  
<http://epson.sn> > **Setup**
  - Another smart device was added to the network using push button setup.
  - The Wi-Fi network was set up using any method other than push button setup.

#### Related Information

- ➔ [“Connecting to a Computer” on page 21](#)
- ➔ [“Making Wi-Fi Settings from the Printer” on page 31](#)

## Network Settings

### E-5

#### Solutions:

Make sure the wireless router's security type is set to one of the following. If it is not, change the security type on the wireless router, and then reset the printer's network settings.

- WEP-64 bit (40 bit)
- WEP-128 bit (104 bit)
- WPA PSK (TKIP/AES)\*
- WPA2 PSK (TKIP/AES)\*
- WPA (TKIP/AES)
- WPA2 (TKIP/AES)

\* WPA PSK is also known as WPA Personal. WPA2 PSK is also known as WPA2 Personal.

### E-6

#### Solutions:

- Check if MAC address filtering is disabled. If it is enabled, register the printer's MAC address so that it is not filtered. See the documentation provided with the wireless router for details. You can check the printer's MAC address from the **Network Status** part on the network connection report.
- If your wireless router is using shared authentication with WEP security, make sure the authentication key and index are correct.
- If the number of connectable devices on the wireless router is less than the number of network devices that you want to connect, make settings on the wireless router to increase the number of connectable devices. See the documentation provided with the wireless router to make settings.

#### Related Information

➔ [“Connecting to a Computer” on page 21](#)

### E-8

#### Solutions:

- Enable DHCP on the wireless router if the printer's Obtain IP Address setting is set to **Auto**.
- If the printer's Obtain IP Address setting is set to Manual, the IP address you manually set is invalid due to out of range (for example: 0.0.0.0). Set a valid IP address from the printer's control panel or by using Web Config.

#### Related Information

➔ [“Printing a Network Status Sheet” on page 40](#)

## Network Settings

### E-9

#### Solutions:

Check the following.

- Devices are turned on.
- You can access the Internet and other computers or network devices on the same network from the devices you want to connect to the printer.

If still does not connect your printer and network devices after confirming the above, turn off the wireless router. Wait for about 10 seconds, and then turn it on. Then reset your network settings by downloading and running the installer from the following website.

<http://epson.sn> > Setup

#### Related Information

➔ [“Connecting to a Computer” on page 21](#)

### E-10

#### Solutions:

Check the following.

- Other devices on the network are turned on.
- Network addresses (IP address, subnet mask, and default gateway) are correct if you have set the printer's Obtain IP Address to Manual.

Reset the network address if they are incorrect. You can check the IP address, subnet mask, and default gateway from the **Network Status** part on the network connection report.

If DHCP is enabled, change the printer's Obtain IP Address setting to **Auto**. If you want to set the IP address manually, check the printer's IP address from the **Network Status** part on the network connection report, and then select Manual on the network settings screen. Set the subnet mask to [255.255.255.0].

If still does not connect your printer and network devices, turn off the wireless router. Wait for about 10 seconds, and then turn it on.

#### Related Information

➔ [“Printing a Network Status Sheet” on page 40](#)

### E-11

#### Solutions:

Check the following.

- The default gateway address is correct if you set the printer's TCP/IP Setup setting to Manual.
- The device that is set as the default gateway is turned on.

Set the correct default gateway address. You can check the default gateway address from the **Network Status** part on the network connection report.

## Network Settings

### Related Information

- ➔ [“Printing a Network Status Sheet” on page 40](#)

## E-12

### Solutions:

Check the following.

- Other devices on the network are turned on.
- The network addresses (IP address, subnet mask, and default gateway) are correct if you are entering them manually.
- The network addresses for other devices (subnet mask and default gateway) are the same.
- The IP address does not conflict with other devices.

If still does not connect your printer and network devices after confirming the above, try the following.

- Turn off the wireless router. Wait for about 10 seconds, and then turn it on.
- Make network settings again using the installer. You can run it from the following website.  
<http://epson.sn> > **Setup**
- You can register several passwords on a wireless router that uses WEP security type. If several passwords are registered, check if the first registered password is set on the printer.

### Related Information

- ➔ [“Printing a Network Status Sheet” on page 40](#)
- ➔ [“Connecting to a Computer” on page 21](#)

## E-13

### Solutions:

Check the following.

- Network devices such as a wireless router, hub, and router are turned on.
- The TCP/IP Setup for network devices has not been set up manually. (If the printer's TCP/IP Setup is set automatically while the TCP/IP Setup for other network devices is performed manually, the printer's network may differ from the network for other devices.)

If it still does not work after checking the above, try the following.

- Turn off the wireless router. Wait for about 10 seconds, and then turn it on.
- Make network settings on the computer that is on the same network as the printer using the installer. You can run it from the following website.  
<http://epson.sn> > **Setup**
- You can register several passwords on a wireless router that uses the WEP security type. If several passwords are registered, check if the first registered password is set on the printer.

## Network Settings

### Related Information

- ➔ [“Printing a Network Status Sheet” on page 40](#)
- ➔ [“Connecting to a Computer” on page 21](#)

### Message on the Network Environment

Message	Solution
*Multiple network names (SSID) that match your entered network name (SSID) have been detected. Confirm network name (SSID).	The same SSID may be set on several wireless router. Check the settings on the wireless router, and change the SSID.
The Wi-Fi environment needs to be improved. Turn the wireless router off and then turn it on. If the connection does not improve, see the documentation for the wireless router.	After moving the printer closer to the wireless router and removing any obstacles between them, turn off the wireless router. Wait for about 10 seconds, and then turn it on. If it still does not connect, see the documentation supplied with the wireless router.
*No more devices can be connected. Disconnect one of the connected devices if you want to add another one.	Computer and smart devices that can be connected simultaneously are connected in full in the Wi-Fi Direct (Simple AP) connection. To add another computer or smart device, disconnect one of the connected devices or connect it to the other network first.  You can confirm the number of wireless devices which can be connected simultaneously and the number of connected devices by checking the network status sheet or the printer's control panel.
The same SSID as Wi-Fi Direct exists in the environment. Change the Wi-Fi Direct SSID if you cannot connect a smart device to the printer.	On the printer's control panel, go to Wi-Fi Direct Setup screen and select the menu to change the setting. You can change the network name following after DIRECT-XX-. Enter within 32 characters.

## Printing a Network Status Sheet

You can check the detailed network information by printing it.

1. Load papers.
2. Select **Settings** on the home screen.  
To select an item, use the ▲ ▼ ◀ ▶ buttons, and then press the OK button.
3. Select **Network Settings > Print Status Sheet**.
4. Press the ◊ button.  
The network status sheet is printed.



---

## Replacing or Adding New Wireless Routers

If the SSID changes due to the replacement of a wireless router, or a wireless router is added and a new network environment is established, re-set the Wi-Fi settings.

### Related Information

➔ “Changing the Connection Method to a Computer” on page 41

---

## Changing the Connection Method to a Computer

Using the installer and re-set up in a different connection method.

- Setting up from the website

Access the following website, and then enter the product name. Go to **Setup**, and then start setting up.

<http://epson.sn>

- Setting up using the software disc (only for the models that come with a software disc and users with Windows computers with disc drives.)

Insert the software disc into the computer, and then follow the on-screen instructions.

### Selecting Change the Connection Methods

Follow the on-screen instructions until the following screen is displayed.

Select **Set up Printer connection again (for new network router or changing USB to network, etc.)** on the Install Software screen, and then click **Next**.

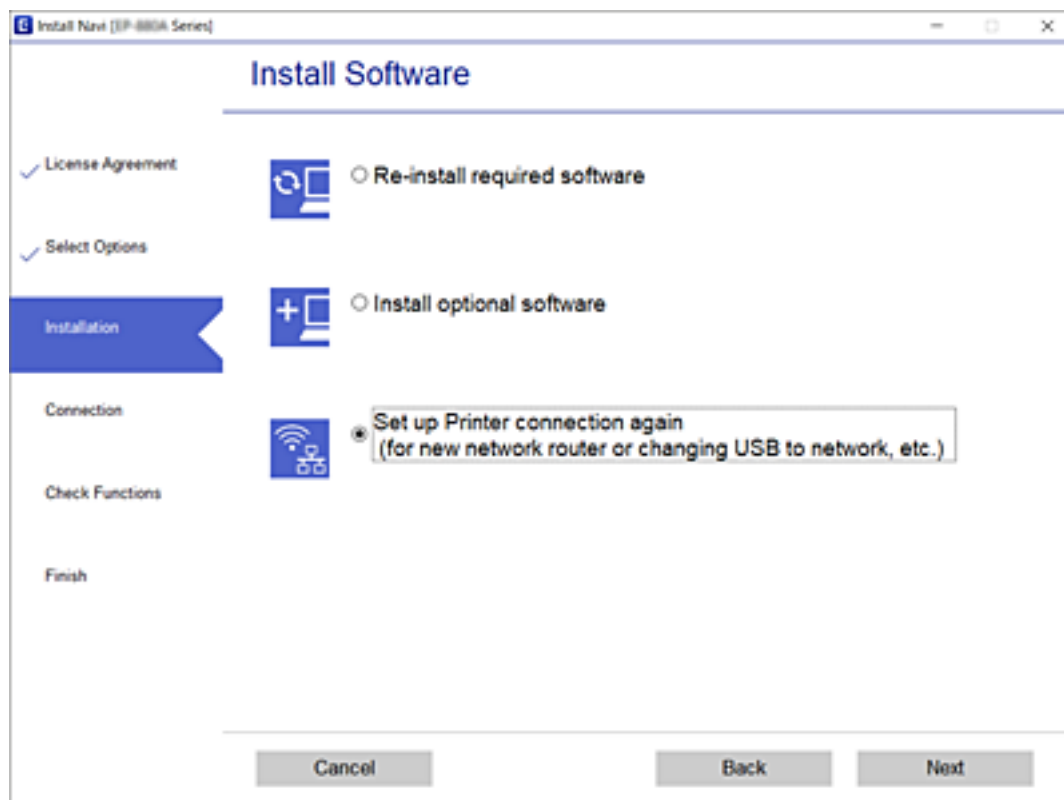

---

## Changing the Network Connection to Ethernet from the Control Panel

Follow the steps below to change the network connection to Ethernet from Wi-Fi using the control panel.

1. Connect the printer to a router using an Ethernet cable.
2. Disable the Wi-Fi from the printer's control panel.

### Related Information

➔ [“Disabling Wi-Fi from the Control Panel” on page 43](#)

---

## Enabling Energy Efficient Ethernet

The Energy Efficient Ethernet for the printer is compliant with IEEE802.3az.

When using this function, enable IEEE802.3az for the printer. All devices connected to the network should support this function.

1. Access Web Config.
2. Select **Advanced Settings** from the list at the top right of the window.
3. Select **Network Settings > Wired LAN**.
4. Select **ON** for **IEEE 802.3az**.
5. Click **Next**.
6. Click **OK**.

### Related Information

➔ [“Running Web Config on a Web Browser” on page 155](#)

---

## Changing the Wi-Fi Direct (Simple AP) Settings

When a Wi-Fi Direct (Simple AP) connection is enabled, you can change the Wi-Fi Direct settings such as the network name and the password.

1. Select **Wi-Fi Setup** on the home screen.  
To select an item, use the ▲ ▼ ◀▶ buttons, and then press the OK button.
2. Select **Wi-Fi Direct**.
3. Press the OK button to proceed.
4. Press the OK button to proceed.

## Network Settings

5. Press the ▼ button to display the setting screen.

6. Select the menu item that you want to change.

You can select the following menu items.

❑ **Change Network Name**

Change the Wi-Fi Direct (simple AP) network name (SSID) used for connecting to the printer to your arbitrary name. You can set the network name (SSID) in ASCII characters that is displayed on the software keyboard on the control panel.

When changing the network name (SSID), all connected devices are disconnected. Use the new network name (SSID) if you want to re-connect the device.

❑ **Change Password**

Change the Wi-Fi Direct (simple AP) password for connecting to the printer to your arbitrary value. You can set the password in ASCII characters that is displayed on the software keyboard on the control panel.

When changing the password, all connected devices are disconnected. Use the new password if you want to re-connect the device.

❑ **Disable Wi-Fi Direct**

Disable Wi-Fi Direct (simple AP) settings of the printer. When disabling it, all devices connected to the printer in Wi-Fi Direct (Simple AP) connection are disconnected.

❑ **Restore Default Settings**

Restore all Wi-Fi Direct (simple AP) settings to their defaults.

The Wi-Fi Direct (simple AP) connection information of the smart device saved to the printer is deleted.

7. Follow the on-screen instruction.

---

## Disabling Wi-Fi from the Control Panel

When Wi-Fi is disabled, the Wi-Fi connection is disconnected.

1. Select **Wi-Fi Setup** on the home screen.

To select an item, use the ▲ ▼ ◀ ▶ buttons, and then press the OK button.

2. Select **Wi-Fi (Recommended)**.

3. Press the OK button to proceed.

4. Select **Others**.

5. Select **Disable Wi-Fi**.

6. Check the message, and then press the OK button.

---

## Disconnecting Wi-Fi Direct (Simple AP) Connection from the Control Panel

There are two methods available to disable a Wi-Fi Direct (Simple AP) connection; you can disable all connections by using the printer's control panel, or disable each connection from the computer or the smart device. This section explains how to disable all connections.

**Important:**

*When Wi-Fi Direct (Simple AP) connection disabled, all computers and smart devices connected to the printer in Wi-Fi Direct (Simple AP) connection are disconnected.*

**Note:**

*If you want to disconnect a specific device, disconnect from the device instead of the printer. Use one of the following methods to disconnect the Wi-Fi Direct (Simple AP) connection from the device.*

- Disconnect the Wi-Fi connection to the printer's network name (SSID).*
- Connect to another network name (SSID).*

1. Select **Wi-Fi Setup** on the home screen.

To select an item, use the ▲ ▼ ◀▶ buttons, and then press the OK button.

2. Select **Wi-Fi Direct**.
3. Press the OK button to proceed.
4. Press the OK button to proceed.
5. Press the ▼ button to display the setting screen.
6. Select **Disable Wi-Fi Direct**.
7. Check the message, and then press the OK button.

---

## Restoring the Network Settings from the Control Panel

You can restore all network settings to their defaults.

1. Select **Settings** on the home screen.

To select an item, use the ▲ ▼ ◀▶ buttons, and then press the OK button.

2. Select **Restore Default Settings > Network Settings**.
3. Check the message, and then press the OK button.

# Preparing the Printer

## Loading Papers

### Available Paper and Capacities

**Note:**

The paper size displayed differs depending on the driver.

### Genuine Epson Paper

Epson recommends using genuine Epson paper to ensure high-quality printouts.

**Note:**

The availability of paper varies by location. For the latest information on paper available in your area, contact Epson support.

#### Paper suitable for printing documents

Media Name	Size	Loading Capacity (Sheets)	Manual 2-Sided Printing	Border less Printing
Epson Bright White Ink Jet Paper	A4	Up to the line indicated by the triangle symbol on the edge guide. *1	✓	-

\*1 For manual 2-sided printing, you can load up to 30 sheets for paper with one side already printed.

#### Paper suitable for printing documents and photos

Media Name	Size	Loading Capacity (Sheets)	Manual 2-Sided Printing	Border less Printing
Epson Matte Paper-Heavyweight	A4	20	-	-
Epson Photo Quality Ink Jet Paper	A4	80	-	-
Epson Double-Sided Matte Paper	A4	1	✓	-

## Preparing the Printer

### Paper suitable for printing photos

Media Name	Size	Loading Capacity (Sheets)	Manual 2-Sided Printing	Borderless Printing
Epson Ultra Glossy Photo Paper	A4, 13×18 cm (5×7 in.)	20 <sup>*1</sup>	-	-
	10×15 cm (4×6 in.)			✓
Epson Premium Glossy Photo Paper	A4, 13×18 cm (5×7 in.)	20 <sup>*1</sup>	-	-
	16:9 wide size (102×181 mm), 10×15 cm (4×6 in.)			✓
Epson Premium Semigloss Photo Paper	A4	20 <sup>*1</sup>	-	-
	10×15 cm (4×6 in.)			✓
Epson Photo Paper Glossy	A4, 13×18 cm (5×7 in.)	20 <sup>*1</sup>	-	-
	10×15 cm (4×6 in.)			✓

\*1 Load one sheet of paper at a time if the paper does not feed correctly or if the printout has uneven colors or smears.

## Commercially Available Paper

### Plain papers

Media Name	Size	Loading Capacity (Sheets)	Manual 2-Sided Printing	Borderless Printing
Plain paper Copy paper	Letter, A4, B5, 16K (195×270 mm), A5, A6, B6	Up to the line indicated by the triangle symbol on the edge guide. <sup>*1*2</sup>	✓	-
	Legal, 8.5×13 in., Indian-Legal	1	✓	-
	User Defined (mm) <sup>*3</sup> 54×86 to 215.9×1200	1	✓	-

\*1 Load one sheet of paper at a time if the paper does not feed correctly or if the printout has uneven colors or smears.

\*2 For manual 2-sided printing, you can load up to 30 sheets for paper with one side already printed.

\*3 Only printing from computer is available.

## Preparing the Printer

### Envelopes

Media Name	Size	Loading Capacity (Envelopes)	Manual 2-Sided Printing	Borderless Printing
Envelope	Envelope #10, Envelope DL, Envelope C6	10	-	-

### Paper Handling Precautions

- Read the instruction sheets supplied with the paper.
- To achieve high-quality printouts with genuine Epson paper, use the paper in the environment stated on the sheets supplied with the paper.
- Fan and align the edges of the paper before loading. Do not fan or curl photo paper. Doing so may damage the printable side.

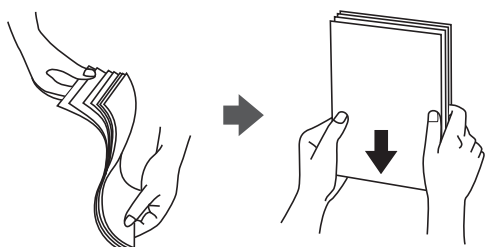

- If the paper is curled, flatten it or curl it slightly in the opposite direction before loading. Printing on curled paper may cause paper jams and smears on the printout.

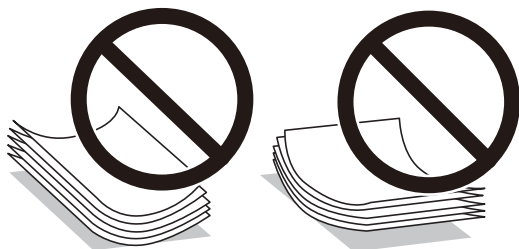

- Do not use paper that is wavy, torn, cut, folded, damp, too thick, too thin, or paper that has stickers stuck to it. Using these types of paper causes paper jams and smears on the printout.
- Make sure you are using long-grain paper. If you are not sure what type of paper you are using, check the paper packaging or contact the manufacturer to confirm the paper specifications.

### Related Information

- ➔ [“Printer Specifications” on page 201](#)

## Preparing the Printer

## Loading Paper in the Rear Paper Feed

1. Pull out the paper support.

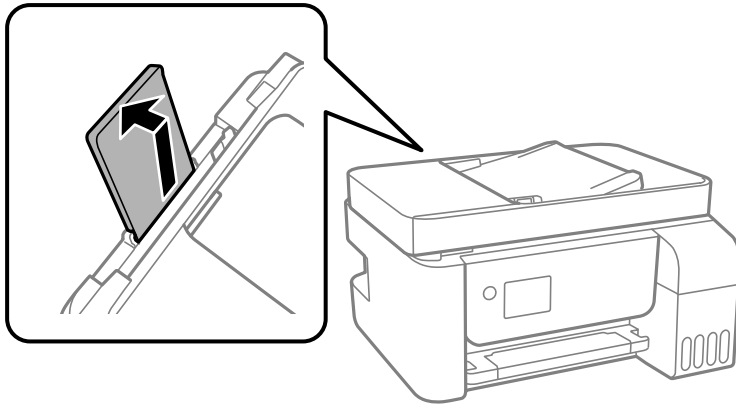

2. Slide the edge guides.

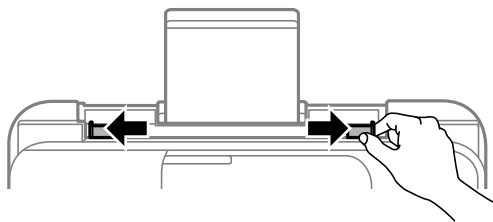

3. Load paper at the center of the paper support with the printable side facing up.

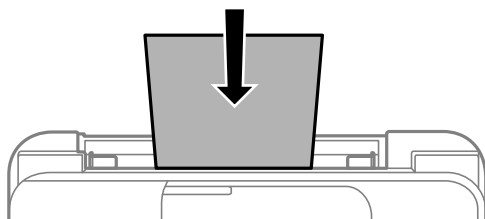
**! Important:**

- Do not load more than the maximum number of sheets specified for the paper. For plain paper, do not load above the line just under the ▼ symbol inside the edge guide.
- Load paper short edge first. However, when you have set the long edge as the width of the user defined size, load paper long edge first.



## Preparing the Printer

- ❑ Pre-punched paper

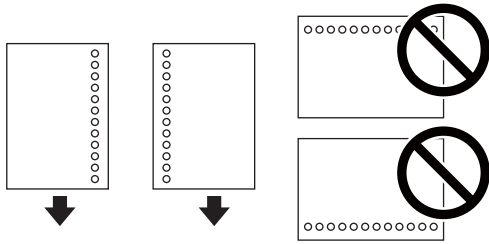

**Note:**

- ❑ Load a single sheet of defined size plain paper with binding holes at the left or right.
- ❑ Adjust the print position of your file to avoid printing over the holes.

4. Slide the edge guides to the edges of the paper.

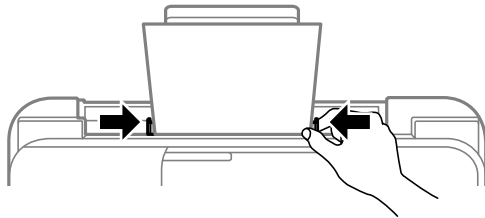

5. On the control panel, set the size and type of the paper you loaded in the rear paper feed.

To select an item, use the ▲ ▼ ◀ ▶ buttons, and then press the OK button.

**Note:**

You can also display the paper size and paper type settings screen by selecting **Settings > Printer Setup > Paper Source Settings > Paper Setting**.

6. Slide out the output tray.

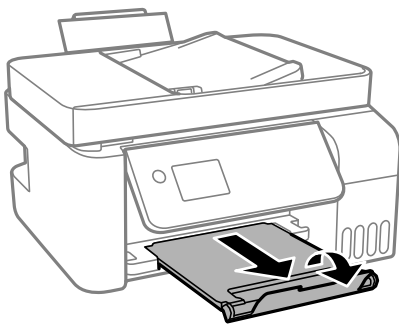

**Note:**

Return the remaining paper to its package. If you leave it in the printer, the paper may curl or the print quality may decline.

### Related Information

- ➔ [“Paper Handling Precautions” on page 47](#)
- ➔ [“Available Paper and Capacities” on page 45](#)
- ➔ [“Loading Envelopes and Precautions” on page 50](#)

## Preparing the Printer

➔ [“Loading Long Papers” on page 50](#)

### Loading Envelopes and Precautions

Loading envelopes short edge first at the center with the flap facing down, and slide the edge guides to the edges of the envelopes.

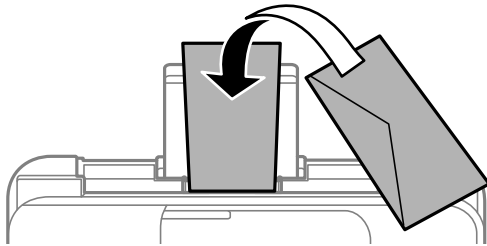

- ❑ Fan and align the edges of the envelopes before loading. When the stacked envelopes are puffed up with air, press them down to flatten them before loading.

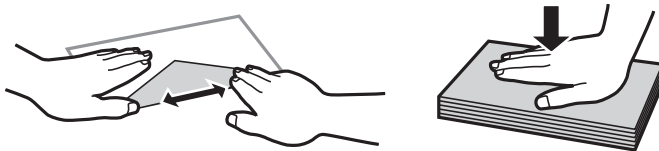

- ❑ Do not use envelopes that are curled or folded. Using these envelopes causes paper jams and smears on the printout.
- ❑ Do not use envelopes with adhesive surfaces on the flaps or window envelopes.
- ❑ Avoid using envelopes that are too thin, as they may curl during printing.

#### Related Information

- ➔ [“Available Paper and Capacities” on page 45](#)
- ➔ [“Loading Paper in the Rear Paper Feed” on page 48](#)

### Loading Long Papers

When loading paper longer than legal size, store the paper support, and then flatten the leading edge of the paper.

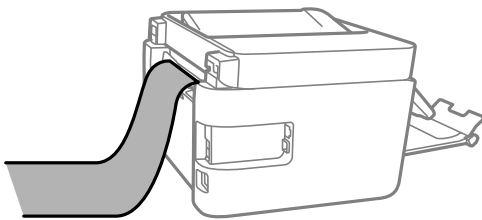

#### Related Information

- ➔ [“Available Paper and Capacities” on page 45](#)
- ➔ [“Loading Paper in the Rear Paper Feed” on page 48](#)

## Preparing the Printer

### List of Paper Type

To obtain optimum printing results, select the paper type that suits the paper.

Media Name	Media Type	
	Control Panel	Printer Driver
Epson Bright White Ink Jet Paper	Plain paper	Plain paper
Epson Ultra Glossy Photo Paper	Ultra Glossy	Epson Ultra Glossy
Epson Premium Glossy Photo Paper	Prem. Glossy	Epson Premium Glossy
Epson Premium Semigloss Photo Paper	Prem. Semigloss	Epson Premium Semigloss
Epson Photo Paper Glossy	Glossy	Photo Paper Glossy
Epson Matte Paper-Heavyweight Epson Double-Sided Matte Paper	Matte	Epson Matte
Epson Photo Quality Ink Jet Paper	Photo Quality IJ	Epson Photo Quality Ink Jet

## Placing Originals

Place originals on the scanner glass or the ADF.

You can scan multiple originals at the same time with the ADF.

### Available Originals for the ADF

Available Paper Sizes	A4, Letter, 8.5x13 in., Legal
Paper Type	Plain paper
Paper Thickness (Weight of Paper)	64 to 95 g/m <sup>2</sup>
Loading Capacity	A4, Letter: 30 sheets or 3.3 mm 8.5x13 in., Legal: 10 sheets

Even when the original meets the specifications for media that can be placed in the ADF, it may not feed from the ADF or the scan quality may decline depending on the paper properties or quality.



**Important:**

*Do not feed photographs or valuable original artwork into the ADF. Misfeeding may wrinkle or damage the original. Scan these documents on the scanner glass instead.*

To prevent paper jams, avoid placing the following originals in the ADF. For these types, use the scanner glass.

- Originals that are torn, folded, wrinkled, deteriorated, or curled
- Originals with binder holes
- Originals held together with tape, staples, paper clips etc.

## Preparing the Printer

- ❑ Originals that have stickers or labels stuck to them
- ❑ Originals that are cut irregularly or not right angled
- ❑ Originals that are bound
- ❑ OHPs, thermal transfer paper, or carbon backs

## Placing Originals on the ADF

1. Align the edges of the originals.
2. Slide out the ADF edge guide.

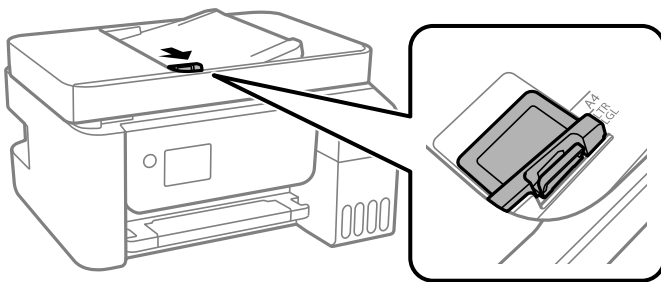

3. Place the originals face-up and short edge first in the ADF, and then slide the ADF edge guide to the edge of the originals.

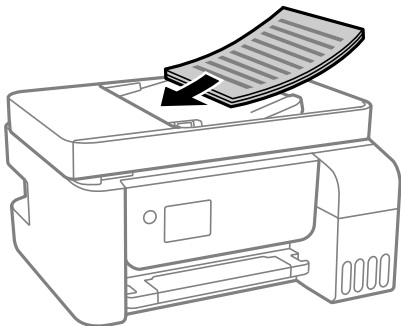

**!** **Important:**

- ❑ Do not load originals above the line indicated by the triangle symbol on the ADF.

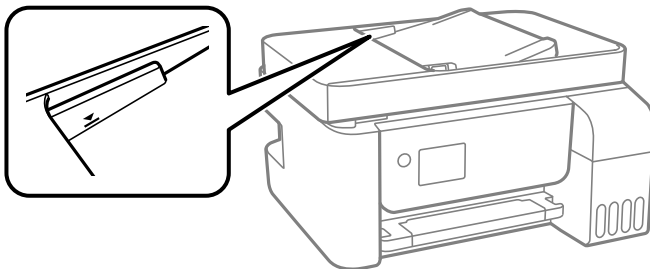

- ❑ Do not add originals while scanning.

## Preparing the Printer

### Placing Originals on the ADF for 2-up Copying

Place the originals in the direction shown in the illustration, and then select the orientation setting.

- Portrait originals: Select **Portrait** on the control panel as described below.

**Multi-Page > 2-up > Original Orientation > Portrait**

Place the originals on the ADF in the direction of the arrow.



- Landscape originals: Select **Landscape** on the control panel as described below.

**Multi-Page > 2-up > Original Orientation > Landscape**

Place the originals on the ADF in the direction of the arrow.



### Placing Originals on the Scanner Glass

 **Caution:**

*Be careful not to trap your hand or fingers when opening or closing the document cover. Otherwise you may be injured.*

 **Important:**

*When placing bulky originals such as books, prevent exterior light from shining directly onto the scanner glass.*

1. Open the document cover.

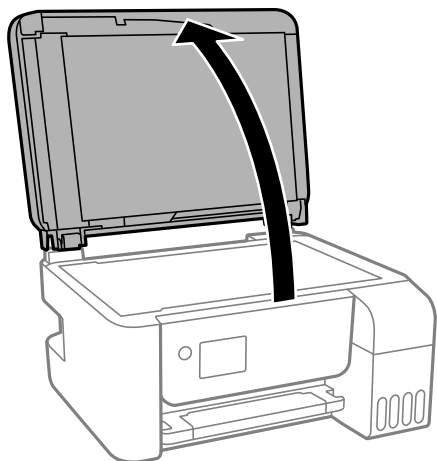

## Preparing the Printer

2. Remove any dust or stains on the surface of the scanner glass using a soft, dry, clean cloth.

**Note:**

*If there is any trash or dirt on the scanner glass, the scanning range may expand to include it, so the image of the original may be displaced or reduced.*

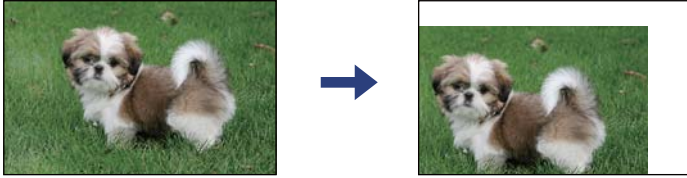

3. Place the original face-down and slide it to the corner mark.

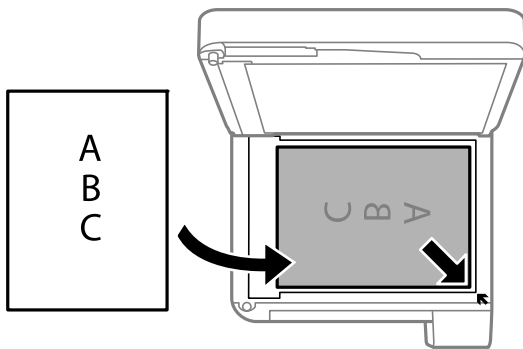

**Note:**

- A range of 1.5 mm from the corner of the scanner glass is not scanned.
- When originals are placed in the ADF and on the scanner glass, priority is given to the originals in the ADF.

4. Close the cover gently.



**Important:**

*Do not apply too much force to the scanner glass or the document cover. Otherwise, they may be damaged.*

5. Remove the originals after scanning.

**Note:**

*If you leave the originals on the scanner glass for a long time, they may stick to the surface of the glass.*

## Preparing the Printer

### Placing an ID Card for Copying

Place an ID card 5 mm away from the corner mark of the scanner glass.

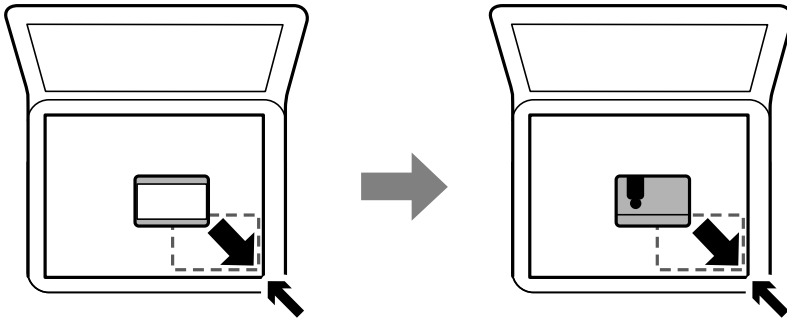

---

## Managing Contacts

Registering a contacts list allows you to easily enter destinations. You can register up to 100 entries, and you can use the contacts list when you enter a fax number.

### Registering or Editing Contacts

1. Select **Settings** on the home screen.

To select an item, use the ▲ ▼ ◀ ▶ buttons, and then press the OK button.

2. Select **Contacts Manager**.

3. Do one of the following.

- To register a new contact, select **Add Entry**, and then select the registry number.
- To edit a contact, select **Edit**, and then select the target contact .
- To delete a contact, select **Delete**, select the target contact, and then select **Yes**. No further steps are necessary.

4. Make the necessary settings.

**Note:**

When entering a fax number, enter an external access code at the beginning of the fax number if your phone system is PBX and you need the access code to get an outside line. If the access code has been set in the **Line Type** setting, enter a hash (#) instead of the actual access code. To add a pause (pause for three seconds) during dialing, enter a hyphen (-).

5. Press the OK button to proceed, and then select **Add Entry** to complete registering or editing.

### Registering or Editing Grouped Contacts

Adding contacts to a group allows you to send a fax to multiple destinations at the same time.

## Preparing the Printer

1. Select **Settings** on the home screen.

To select an item, use the ▲ ▼ ◀▶ buttons, and then press the OK button.

2. Select **Contacts Manager**.

3. Do one of the following.

- To register a new group of contacts, select **Add Group**, and then select the registry number.
- To edit a group of contacts, select **Edit**, and then select the target group.
- To delete a group of contacts, select **Delete**, select the target group, and then select **Yes**. No further steps are necessary.

4. Enter or edit the **Group Name**, and then press the OK.

5. Enter or edit the **Index Word**, and then press the OK.

6. Select the contacts that you want to register in the group.

Each time you press the ► button, the contact is selected and deselected alternatively.

**Note:**

*You can register up to 99 contacts.*

7. Press the OK button to proceed, and then select **Add Entry** to complete registering or editing.

## Register Contacts on a Computer

Using Web Config, you can create a contact list on your computer and import it to the printer.

1. Access Web Config.
2. Select **Advanced Settings** from the list at the top right of the window.
3. Select **Contacts**.
4. Select the number that you want to register, and then click **Edit**.
5. Enter **Name**, **Index Word**, **Fax Number**, and **Fax Speed**.
6. Click **Apply**.

## Destination Setting Items

Items	Settings and Explanation
Name	Enter a name displayed in the contacts in 30 characters or less in Unicode (UTF-8). If you do not specify this, leave it blank.
Index Word	Enter words to search in 30 characters or less in Unicode (UTF-8). If you do not specify this, leave it blank.
Type	This item is fixed as <b>Fax</b> . You cannot change this setting.



## Preparing the Printer

Items	Settings and Explanation
Fax Number	Enter between 1 and 64 characters using 0-9 - * # and space.
Fax Speed	Select a communication speed for a destination.

### Registering Destinations as a Group

1. Access Web Config.
2. Select **Advanced Settings** from the list at the top right of the window.
3. Select **Contacts**.
4. Select the number that you want to register, and then click **Edit**.
5. Enter a **Name** and **Index Word**.
6. Select a group from **Type**.
7. Click **Select for Contact(s) for Group**.  
The available destinations are displayed.
8. Select the destination that you want to register to the group, and then click **Select**.  
*Note:*  
*Destinations can be registered to multiple groups.*
9. Click **Apply**.

---

## Menu Options for Settings

Select **Settings** on the home screen of the printer to make various settings.

### Menu Options for Maintenance

Select the menus on the control panel as described below.

#### Settings > Maintenance

##### Nozzle Check:

Select this feature to check if the print head nozzles are clogged. The printer prints a nozzle check pattern.

##### Head Cleaning:

Select this feature to clean clogged nozzles in the print head.

## Preparing the Printer

### Power Cleaning:

Select this feature to replace all of the ink inside the ink tubes. More ink is consumed than in usual cleaning. See the "Related Information" below for details on using this feature.

### Print Head Alignment:

Select this feature to adjust the print head to improve print quality.

Vertical Alignment

Select this feature if your printouts look blurry or text and lines are misaligned.

Horizontal Alignment

Select this feature if horizontal banding appears at regular intervals in your printouts.

### Reset Ink Level:

Select this feature to reset the ink levels to 100% when refilling the ink tank.

### Paper Guide Cleaning:

Select this feature if there are ink stains on the internal rollers. The printer feeds paper to clean the internal rollers.

### Related Information

- ➔ ["Checking and Cleaning the Print Head" on page 146](#)
- ➔ ["Running Power Cleaning" on page 148](#)
- ➔ ["Aligning the Print Head" on page 149](#)
- ➔ ["Refilling the Ink Tanks" on page 141](#)
- ➔ ["Cleaning the Paper Path for Ink Smears" on page 150](#)

## Menu Options for Printer Setup

Select the menus on the control panel as described below.

### Settings > Printer Setup

#### Paper Source Settings:

##### Paper Setting:

Select the paper size and paper type you loaded in the paper source.

##### A4/Letter Auto Switching:

Select **On** to feed paper from the paper source set as A4 size when there is no paper source set as Letter, or feed from the paper source set as Letter size when there is no paper source set as A4.

##### Error Notice:

Select **On** to display an error message when the selected paper size or type does not match the loaded paper.

## Preparing the Printer

### Paper Setup Auto Display:

Select **On** to display the **Paper Setting** screen when loading paper in the paper source. If you disable this feature, you cannot print from an iPhone or iPad using AirPrint.

### Sound:

Adjust the volume.

Mute

Select **On** to mute all sound.

Normal Mode

Select the volume such as **Button Press**.

Quiet Mode

Select the volume such as **Button Press** in **Quiet Mode**.

### Quiet Mode:

Your product may not have this feature depending on the location of purchase.

Select **On** to reduce noise during printing, however, this may lower the print speed. Depending on the paper type and print quality settings you selected, there may be no difference in the printer's noise level.

### Power Off Timer:

Your product may have this feature or the **Power Off Settings** feature depending on the location of purchase.

Select this setting to turn the printer off automatically when it is not used for a specified period of time. You can adjust the time before power management is applied. Any increase will affect the product's energy efficiency. Please consider the environment before making any change.

### Power Off Settings:

Your product may have this feature or the **Power Off Timer** feature depending on the location of purchase.

Power Off If Inactive

Select this setting to turn the printer off automatically if it is not used for a specified period of time. Any increase will affect the product's energy efficiency. Please consider the environment before making any change.

Power Off If Disconnected

Select this setting to turn the printer off after 30 minutes when all ports including the LINE port are disconnected. This feature may not be available depending on your region.

### Date/Time Settings:

Date/Time

Enter the current date and time.

Daylight Saving Time

Select the summer time setting that applies to your area.

Time Difference

Enter the time difference between your local time and UTC (Coordinated Universal Time).

## Preparing the Printer

### Country/Region:

Select the country or region in which you are using your printer. If you change the country or region, your fax settings return to their defaults and you must select them again.

### Language:

Select the language used on the LCD screen.

### Sleep Timer:

Adjust the time period to enter a sleep mode (energy saving mode) when the printer has not performed any operations. The LCD screen turns black when the setting time passes.

### PC Connection via USB:

Select **Enable** to allow a computer to access the printer when connected by USB. When **Disable** is selected, printing and scanning that is not sent over a network connection is restricted.

### Related Information

➔ [“Saving Power - Control Panel” on page 64](#)

## Menu Options for Network Settings

Select the menus on the control panel as described below.

### Settings > Network Settings

#### Print Status Sheet

Prints a network status sheet.

#### Wi-Fi Setup:

Set up or change wireless network settings. Choose the connection method from following and then follow the instructions on the control panel.

Wi-Fi (Recommended):

Wi-Fi Direct

#### Connection Check

Checks the status of the network connection and prints the network connection report. If there are any problems with the connection, see the check report to solve the problem.

### Related Information

➔ [“Making Wi-Fi Settings by Entering the SSID and Password” on page 31](#)

➔ [“Making Wi-Fi Settings by Push Button Setup” on page 32](#)

➔ [“Making Wi-Fi Settings by PIN Code Setup \(WPS\)” on page 33](#)

➔ [“Wi-Fi Direct \(Simple AP\) Connection” on page 21](#)

➔ [“Printing a Network Status Sheet” on page 40](#)

➔ [“Checking the Network Connection Status” on page 33](#)

## Preparing the Printer

### Menu Options for Epson Connect Services

Select the menus on the control panel as described below.

#### Settings > Epson Connect Services

##### Register/Delete:

Register or delete the printer to or from the Epson Connect services.

For usage guides, see the following portal website.

<https://www.epsonconnect.com/>

<http://www.epsonconnect.eu> (Europe only)

##### Suspend/Resume:

Select whether to suspend or resume Epson Connect services.

##### Email Address:

Check the printer's email address that is registered to the Epson Connect services.

##### Status:

Check whether or not the printer is registered and connected to the Epson Connect services.

#### Related Information

➔ [“Printing Using a Network Service” on page 165](#)

### Menu Options for Google Cloud Print Services

Select the menus on the control panel as described below.

#### Settings > Google Cloud Print Services

##### Suspend/Resume:

Select whether to suspend or resume the Google Cloud Print services.

##### Unregister:

Unregister the Google Cloud Print services.

##### Status:

Check whether or not the printer is registered and connected to the Google Cloud Print services.

For registration and usage guides, see the following portal website.

<https://www.epsonconnect.com/>

<http://www.epsonconnect.eu> (Europe only)

## Menu Options for Contacts Manager

Select the menus on the control panel as described below.

### Settings > Contacts Manager

**Add Entry:**

Register the entry to be used for faxes in contacts.

**Add Group:**

Register the entry for group faxes in contacts.

**Edit:**

Edit the entries and groups registered in contacts.

**Delete:**

Delete the entry or group registered in contacts.

**Print Contacts:**

Print the entry information and group information for the contacts in the list.

## Fax Settings

Select the menu on the control panel as described below.

### Settings > Fax Settings

See Related Information below.

#### Related Information

➔ [“Menu Options for Fax Settings” on page 74](#)

## Menu Options for Print Status Sheet

Select the menus on the control panel as described below.

### Settings > Print Status Sheet

**Configuration Status Sheet:**

Print information sheets showing the current printer status and settings.

**Supply Status Sheet:**

Print information sheets showing the status of consumables.

**Usage History Sheet:**

Print information sheets showing the usage history of the printer.

## Preparing the Printer

### Menu Options for Print Counter

Select the menus on the control panel as described below.

#### Settings > Print Counter

Displays the total number of prints, B&W prints, and color prints including items such as the status sheet from the time you purchased the printer.

### Menu Options for Restore Default Settings

Select the menus on the control panel as described below.

#### Settings > Restore Default Settings

Resets the following menus to their defaults.

- Network Settings
- Copy Settings
- Scan Settings
- Fax Settings
- Clear All Data and Settings

### Menu Options for Firmware Update

Select the menus on the control panel as described below.

#### Settings > Firmware Update

##### Update:

Checks if the latest version of the firmware has been uploaded to the network server. If an update is available, you can select whether or not to start updating.

##### Current Version:

Displays the current firmware version of your printer.

##### Notification:

Checks for firmware updates periodically and notifies you if an update is available.

---

## Saving Power

The printer enters sleep mode or turns off automatically if no operations are performed for a set period. You can adjust the time before power management is applied. Any increase will affect the product's energy efficiency. Please consider the environment before making any change.

Depending on the location of purchase, the printer may have a feature that turns it off automatically if it is not connected to the network for 30 minutes.

## Preparing the Printer

### Saving Power - Control Panel

1. Select **Settings** on the home screen.

To select an item, use the ▲ ▼ ◀ ▶ buttons, and then press the OK button.

2. Select **Printer Setup**.

3. Do one of the following.

**Note:**

*Your product may have the **Power Off Settings** or **Power Off Timer** feature depending on the location of purchase.*

- Select **Sleep Timer** or **Power Off Settings** > **Power Off If Inactive** or **Power Off If Disconnected**, and then make settings.
- Select **Sleep Timer** or **Power Off Timer**, and then make settings.



# Fax Settings

---

## Before Using Fax Features

Set up the following to use the fax features.

- Connect the printer correctly with the phone line and, if necessary, with a phone
- Complete the **Fax Setting Wizard**, which is required to make basic settings.

Set the following as necessary.

- Contacts** registration
- User Default Settings** that define default values for **Fax** menu items
- Report Settings** to print reports when faxes are sent or received

### Related Information

- ➔ [“Connecting to a Phone Line” on page 65](#)
- ➔ [“Making the Printer Ready to Send and Receive Faxes \(Using Fax Setting Wizard\)” on page 68](#)
- ➔ [“Making Settings Individually for Printer's Fax Features” on page 70](#)
- ➔ [“Menu Options for Fax Settings” on page 74](#)
- ➔ [“Network Settings” on page 20](#)
- ➔ [“Managing Contacts” on page 55](#)
- ➔ [“Menu Options for User Default Settings” on page 78](#)
- ➔ [“Report Settings Menu” on page 77](#)

---

## Connecting to a Phone Line

### Compatible Telephone Lines

You can use the printer over standard analogue telephone lines (PSTN = Public Switched Telephone Network) and PBX (Private Branch Exchange) telephone systems.

You may not be able to use the printer with the following phone lines or systems.

- VoIP phone line such as DSL or fiber-optic digital service
- Digital phone line (ISDN)
- Some PBX telephone systems
- When adapters such as terminal adapters, VoIP adapters, splitters, or DSL router are connected between the telephone wall jack and the printer

## Connecting the Printer to a Phone Line

Connect the printer to a telephone wall jack using an RJ-11 (6P2C) phone cable. When connecting a telephone to the printer, use a second RJ-11 (6P2C) phone cable.

Depending on the area, a phone cable may be included with the printer. If it is included, use that cable.

You may need to connect the phone cable to an adapter provided for your country or region.

**Note:**

*Remove the cap from the EXT. port of the printer only when connecting your telephone to the printer. Do not remove the cap if you are not connecting your telephone.*

In areas where lightning strikes occur frequently, we recommend that you use a surge protector.

## Connecting to a Standard Phone Line (PSTN) or PBX

Connect a phone cable from the telephone wall jack or PBX port to the LINE port on the back of the printer.

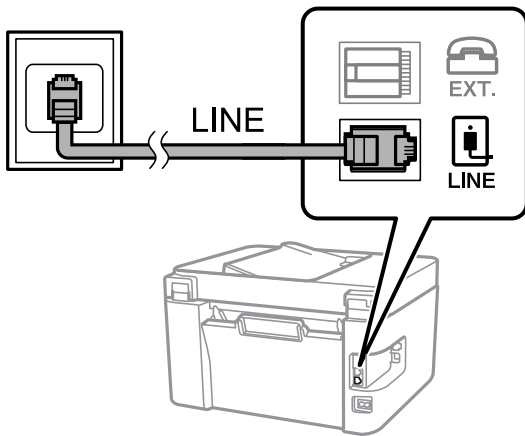

## Connecting to DSL or ISDN

Connect a phone cable from the DSL modem or the ISDN terminal adapter to the LINE port on the back of the printer. See the documentation provided with the modem or the adapter for more details.

**Note:**

*If your DSL modem is not equipped with a built-in DSL filter, connect a separate DSL filter.*

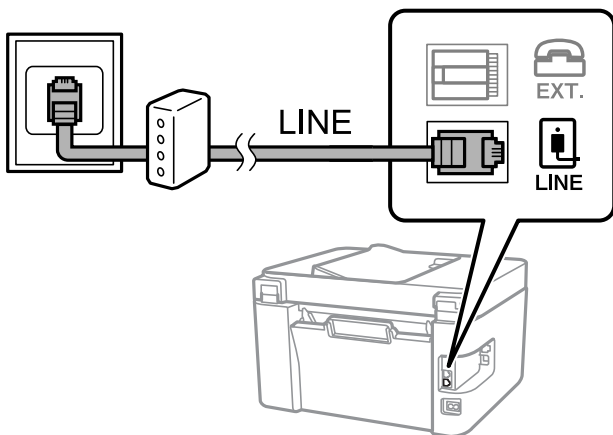

## Connecting Your Phone Device to the Printer

When using the printer and your telephone on a single phone line, connect the telephone to the printer.

**Note:**

- ❑ If your phone device has a fax function, disable the fax function before connecting. See the manuals that came with the phone device for details.
- ❑ If you connect an answering machine, make sure the printer's **Rings to Answer** setting is set higher than the number of rings your answering machine is set to answer a call.

1. Remove the cap from the EXT. port on the back of the printer.

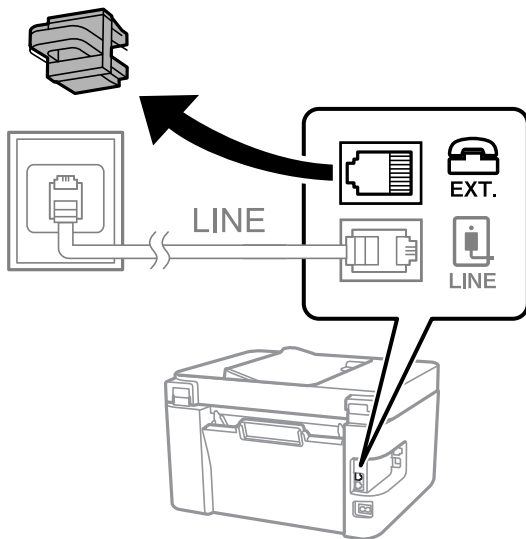

2. Connect the phone device and the EXT. port with a phone cable.

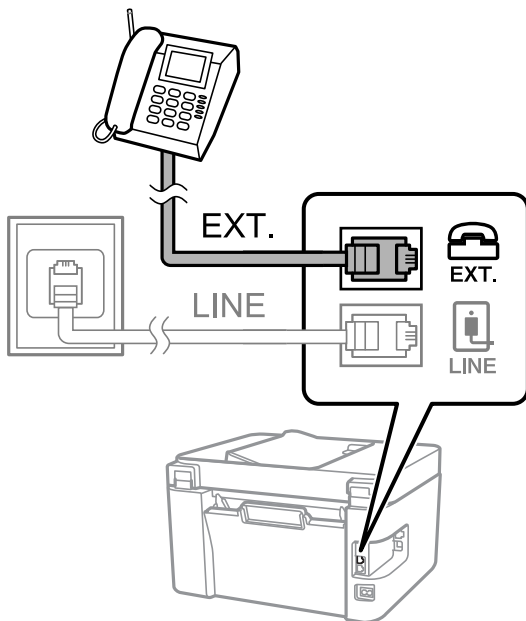

**Note:**

When sharing a single phone line, make sure you connect the phone device to the EXT. port of the printer. If you split the line to connect the phone device and the printer separately, the phone and the printer do not work correctly.

## Fax Settings

3. Select **Fax** on the home screen.

To select an item, use the ▲ ▼ ◀ ▶ buttons, and then press the OK button.

4. Pick up the handset.

A connection has been established when the message to press ◊ to start sending or receiving a fax is displayed on the screen.



### Related Information

- ➔ [“Making the Printer Ready to Send and Receive Faxes \(Using Fax Setting Wizard\)” on page 68](#)
- ➔ [“Making Settings to Use an Answering Machine” on page 72](#)
- ➔ [“Making Settings to Receive Faxes Operating Only a Connected Phone \(Remote Receive\)” on page 72](#)
- ➔ [“Setting Receive Mode” on page 70](#)

---

## Making the Printer Ready to Send and Receive Faxes (Using Fax Setting Wizard)

**Fax Setting Wizard** configures the basic fax features to make the printer ready to send and receive faxes.

The Wizard is displayed automatically when the printer is turned on for the first time. You can also display the wizard manually from the printer's control panel. You need to run the wizard again in case the wizard is skipped when the printer is first turned on or when the connection environment has changed.

- The items below are what you can set through the wizard.
  - Header (Your Phone Number and Fax Header)**
  - Receive Mode (Auto or Manual)**
- The items below are set automatically according to the connection environment.
  - Dial Mode (such as Tone or Pulse)**
  - Line Type (PSTN or PBX)**
  - Dial Tone Detection**
  - DRD Setting**
- Other items in **Basic Settings** remain as they are.

Start **Fax Setting Wizard** to make **Basic Settings**, following the on-screen instructions.

## Fax Settings

1. Make sure the printer is connected to the phone line.

**Note:**

*Because an automatic fax connection check runs at the end of the wizard, the printer must be connected to the phone line before starting the wizard.*

2. Select **Settings** on the home screen on the printer's control panel.

To select an item, use the ▲ ▼ ◀▶ buttons, and then press the OK button.

3. Select **Fax Settings > Fax Setting Wizard**.

4. Check the message on the screen displayed, and then select **Proceed**.

The wizard begins.

5. On the fax header entry screen, enter the sender name such as your company name, and then select **Proceed**.

**Note:**

*Your sender name and your fax number appear as the header for outgoing faxes.*

6. On the phone number entry screen, enter your fax number, and then select **Proceed**.

7. On the **DRD Setting** screen, make the following settings.

- If you have subscribed to a distinctive ring service from your telephone company: Select **Settings**, and then select the ring pattern to be used for incoming faxes.

- If you select **All**, go to step 8.

- If you select any other setting, **Receive Mode** is automatically set to **Auto**. Go to step 10.

- If you do not need to set this option: Select **Skip**, and then go to step 10.

**Note:**

- Distinctive ring services, offered by many telephone companies (the service name differs by company), allows you to have several phone numbers on one phone line. Each number is assigned a different ring pattern. You can use one number for voice calls and another for fax calls. Select the ring pattern assigned to fax calls in **DRD**.*

- Depending on the region, **On** and **Off** are displayed as the **DRD** options. Select **On** to use the distinctive ring feature.*

8. On the **Receive Mode Setting** screen, select whether you are using your phone device connected to the printer.

- When connected: Select **Yes**, and then go to the next step.

- When not connected: Select **No**, and then go to step 10. **Receive Mode** is set to **Auto**.

9. On the **Receive Mode Setting** screen, select whether you want to receive faxes automatically.

- To receive automatically: Select **Yes**. **Receive Mode** is set to **Auto**.

- To receive manually: Select **No**. **Receive Mode** is set to **Manual**.

10. Check the settings you made on the confirmation screen displayed, and then select **Proceed**.

To correct or change settings, select ↶.

11. On the **Check Fax Connections** screen, select **Start Checking** to run the fax connection check, and when the screen prompts you to print the check result, select **Print**.

A report of the check result that shows the connection status is printed.

## Fax Settings

### Note:

- ❑ If there are any errors reported, follow the instructions on the report to solve them.
- ❑ If the **Select Line Type** screen is displayed, select the line type.
  - When you are connecting the printer to a PBX phone system or terminal adapter, select **PBX**.
  - When you are connecting the printer to a standard phone line, select **PSTN**. When the message to disable dial tone detection is shown on the screen, press the OK button. However, disabling dial tone detection may cause the printer to skip the first digit of a fax number when dialing and send the fax to the wrong number.

### Related Information

- ➔ [“Connecting the Printer to a Phone Line” on page 66](#)
- ➔ [“Setting Receive Mode” on page 70](#)
- ➔ [“Making Settings to Use an Answering Machine” on page 72](#)
- ➔ [“Making Settings to Receive Faxes Operating Only a Connected Phone \(Remote Receive\)” on page 72](#)
- ➔ [“Basic Settings Menu” on page 75](#)

---

## Making Settings Individually for Printer's Fax Features

You can configure the printer's fax features individually using the printer's control panel. The settings made using **Fax Setting Wizard** can also be changed. For more details, see the descriptions of the **Fax Settings** Menu.

### Related Information

- ➔ [“Menu Options for Fax Settings” on page 74](#)

## Setting Receive Mode

There are two options in **Receive Mode** for receiving incoming faxes. You can make settings in the menu below.

**Settings > Fax Settings > Basic Settings > Receive Mode**

Receive Mode	Use of Phone Line
Manual	Mainly for phoning, but also for faxing
Auto	Only for faxing (external phone device is not required)
	Mainly for faxing, and sometimes phoning

### Related Information

- ➔ [“Usage of Auto Mode” on page 71](#)
- ➔ [“Usage of Manual Mode” on page 71](#)
- ➔ [“Basic Settings Menu” on page 75](#)

## Fax Settings

### Usage of Manual Mode

#### Receiving Faxes

When the telephone rings, you can answer the ringing manually by picking up the handset.

- When you hear a fax signal (baud):

Select **Fax** on the printer's home screen, press the # button to select receiving a fax, and then select . Next, hang up the handset.

- If the ringing is for a voice call:

You can answer the phone as normal.

#### Receiving Faxes Using only a Connected Telephone

When **Remote Receive** is set, you can receive faxes by simply entering the start code.

When the telephone rings, pick up the handset. When you hear a fax tone (baud), dial the two digit start code, and then hang up the handset.

#### Related Information

- ➔ [“Making Settings to Receive Faxes Operating Only a Connected Phone \(Remote Receive\)” on page 72](#)

### Usage of Auto Mode

#### Receiving Faxes Without an External Phone Device

The printer automatically switches to receive faxes when the number of rings you set in **Rings to Answer** is complete.

**Note:**

*We recommend setting **Rings to Answer** to as low a number as possible.*

#### Receiving Faxes With an External Phone Device

A printer with an external phone device works as follows.

- If your phone device is the answering machine and when it answers within the number of rings set in **Rings to Answer**:
  - If the ringing is for a fax: The printer automatically switches to receive faxes.
  - If the ringing is for a voice call: The answering machine can receive voice calls and record voice messages.
- When you pick up the handset within the number of rings set in **Rings to Answer**:
  - If the ringing is for a fax: You can receive the fax using the same steps as **Manual**.
  - If the ringing is for a voice call: You can answer the phone as normal.
- When the printer automatically switches to receive faxes:
  - If the ringing is for a fax: The printer starts receiving faxes.
  - If the ringing is for a voice call: You cannot answer the phone. Ask the person to call you back.

**Note:**

*Set the **Rings to Answer** settings of the printer to a higher number than the number of rings for the answering machine. Otherwise, the answering machine cannot receive voice calls to record voice messages. For details on setting up the answering machine, see the manual supplied with the answering machine.*

**Related Information**

- ➔ [“Making Settings to Use an Answering Machine” on page 72](#)
- ➔ [“Usage of Manual Mode” on page 71](#)

## Making Settings When You Connect an External Phone Device

### Making Settings to Use an Answering Machine

You need settings to use an answering machine.

1. Select **Settings** on the home screen on the printer's control panel.  
To select an item, use the ▲ ▼ ◀▶ buttons, and then press the OK button.
2. Select **Fax Settings > Basic Settings**.
3. Set **Receive Mode** to **Auto**.
4. Set the **Rings to Answer** setting of the printer to a higher number than the number of rings for the answering machine.

If **Rings to Answer** is set lower than the number of rings for the answering machine, the answering machine cannot receive voice calls to record voice messages. See the manuals that came with the answering machine for its settings.

The printer's **Rings to Answer** setting may not be displayed, depending on the region.

**Related Information**

- ➔ [“Usage of Auto Mode” on page 71](#)
- ➔ [“Basic Settings Menu” on page 75](#)

### Making Settings to Receive Faxes Operating Only a Connected Phone (Remote Receive)

You can start receiving incoming faxes by only picking up the handset and operating the phone, without operating the printer at all.

The **Remote Receive** feature is available for telephones that support tone dialing.

1. Select **Settings** on the home screen on the printer's control panel.  
To select an item, use the ▲ ▼ ◀▶ buttons, and then press the OK button.
2. Select **Fax Settings > Basic Settings > Remote Receive**.
3. Select **On**.
4. Enter a two digit code (you can enter 0 to 9, \*, and #) as the start code, and then press the OK button to apply the settings.



## Fax Settings

### Related Information

- ➔ [“Usage of Manual Mode” on page 71](#)
- ➔ [“Basic Settings Menu” on page 75](#)

## Making Settings for Blocking Junk Faxes

You can block junk faxes.

1. Select **Settings** on the home screen on the printer's control panel.  
To select an item, use the ▲ ▼ ◀ ▶ buttons, and then press the OK button.
2. Select **Fax Settings** > **Basic Settings** > **Rejection Fax**.
3. Set the condition to block junk faxes.  
Select **Rejection Fax**, and then enable the following options.
  - Rejection Number List: Rejects faxes that are in the Rejection Number List.
  - Fax Header Blank: Rejects faxes that have blank header information.
  - Caller not in Contacts: Rejects faxes that have not been added to the contact list.
4. Press ↶ to return to the **Rejection Fax** screen.
5. If you are using the **Rejection Number List**, select **Edit Blocked Number list**, and then edit the list.

### Related Information

- ➔ [“Basic Settings Menu” on page 75](#)

## Making Settings to Send and Receive Faxes on a Computer

To send and receive faxes on a client computer, FAX Utility must be installed on the computer connected by network or USB cable .

## Making Save to Computer Setting to Receive Faxes

You can receive faxes on a computer by using the FAX Utility. Install FAX Utility on the client computer and make the setting. For details, see Basic Operations in the FAX Utility help (displayed on the main window).

The setting item below on the printer's control panel is set to **Yes**, and the faxes received can be saved on the computer.

**Settings** > **Fax Settings** > **Receive Settings** > **Save to Computer**

### Related Information

- ➔ [“Receive Settings Menu” on page 76](#)

## Fax Settings

### Making Save to Computer Setting to Also Print on the Printer to Receive Faxes

You can make the setting to print received faxes on the printer as well as save them on a computer.

1. Select **Settings** on the home screen on the printer's control panel.  
To select an item, use the ▲ ▼ ◀▶ buttons, and then press the OK button.
2. Select **Fax Settings > Receive Settings**.
3. Select **Save to Computer > Yes and Print**.

#### Related Information

➔ [“Receive Settings Menu” on page 76](#)

### Making Save to Computer Setting not to Receive Faxes

To set the printer not to save received faxes on the computer, change the settings on the printer.

#### Note:

*You can also change the settings using the FAX Utility. However, if there are any faxes that have been unsaved to the computer, the feature does not work.*

1. Select **Settings** on the home screen on the printer's control panel.  
To select an item, use the ▲ ▼ ◀▶ buttons, and then press the OK button.
2. Select **Fax Settings > Receive Settings**.
3. Select **Save to Computer > No**.

#### Related Information

➔ [“Receive Settings Menu” on page 76](#)

---

## Menu Options for Fax Settings

Selecting **Settings > Fax Settings** from the printer's control panel displays this menu.

### Check Fax Connection

You can find the menu on the printer's control panel below:

**Settings > Fax Settings > Check Fax Connection**

Selecting **Check Fax Connection** checks that the printer is connected to the phone line and ready for fax transmission. You can print the check result on A4 size plain paper.

## Fax Settings

### Fax Setting Wizard

You can find the menu on the printer's control panel below:

**Settings > Fax Settings > Fax Setting Wizard**

Selecting **Fax Setting Wizard** makes basic fax settings. Follow the on-screen instructions.

#### Related Information

➔ [“Making the Printer Ready to Send and Receive Faxes \(Using Fax Setting Wizard\)” on page 68](#)

### Basic Settings Menu

You can find the menu on the printer's control panel below:

**Settings > Fax Settings > Basic Settings**

Item	Description
Fax Speed	Select the fax transmission speed. We recommend selecting <b>Slow(9,600bps)</b> when a communication error occurs frequently, when sending/receiving a fax to/from abroad, or when you are using an IP (VoIP) phone service.
ECM	Automatically corrects errors in the fax transmission (Error Correction Mode), mostly caused by telephone line noise. If this is disabled, you cannot send or receive documents in color.
Dial Tone Detection	Detects a dial tone before starting to dial. If the printer is connected to a PBX (Private Branch Exchange) or digital phone line, the printer may fail to start dialing. In this situation, change the <b>Line Type</b> setting to <b>PBX</b> . If this does not work, disable this feature. However, disabling this feature may drop the first digit of a fax number and send the fax to the wrong number.
Dial Mode	Select the type of phone system to which you have connected the printer. When set to <b>Pulse</b> , you can temporarily switch the dialing mode from pulse to tone by pressing * ("T" is entered) while entering numbers on the fax top screen. This setting may not be displayed depending on your region or country.
Line Type	Select the line type to which you have connected the printer.  When using the printer in an environment that uses extensions and requires an external access code, such as 0 and 9, to get an outside line, select <b>PBX</b> and register the access code. Once you have registered the access code, enter # (hash) instead of the access code when sending a fax to an outside fax number. For an environment that uses a DSL modem or terminal adapter, setting to <b>PBX</b> is also recommended.  You cannot send faxes to recipients in <b>Contacts</b> in which an external access code such as 0 or 9 is set. If you have added recipients in <b>Contacts</b> using an external access code such as 0 or 9, set the access code to <b>Do Not Use</b> . Otherwise, you must change the code to # in <b>Contacts</b> .
Header	Enter your sender name and fax number. These appear as a header on outgoing faxes.  <input type="checkbox"/> Your Phone Number: You can enter up to 20 characters using 0-9 + or space.  <input type="checkbox"/> Fax Header: You can register up to 21 sender names as necessary. You can enter up to 40 characters for each sender name.
Receive Mode	Select the receive mode. For details, see the related Information below.

## Fax Settings

Item	Description
DRD	If you have subscribed to a distinctive ring service from your telephone company, select the ring pattern to be used for incoming faxes. The distinctive ring service, offered by many telephone companies (the service name differs by company), allows you to have several phone numbers on one phone line. Each number is assigned different ring pattern. You can use one number for voice calls and another for fax calls. Depending on the region, this option may be <b>On</b> or <b>Off</b> .
Rings to Answer	Select the number of rings that must occur before the printer automatically receives a fax.
Remote Receive	When you answer an incoming fax call on a phone connected to the printer, you can start receiving the fax by entering the code using the phone.  To set or change the start code, set <b>Remote Receive</b> to <b>On</b> and enter two characters using 0-9, *, #.
Rejection Fax	<input type="checkbox"/> Rejection Fax: Select options to reject receiving junk faxes. <ul style="list-style-type: none"> <li><input type="checkbox"/> Rejection Number List: If the other party's phone number is in the rejection number list, set whether to reject the incoming faxes.</li> <li><input type="checkbox"/> Fax Header Blank: If the other party's phone number is blocked, set whether to reject receiving the faxes.</li> <li><input type="checkbox"/> Caller not in Contacts: If the other party's phone number is not in the contacts, set whether to reject receiving the faxes.</li> </ul> <input type="checkbox"/> Edit Blocked Number list: You can register up to 30 fax numbers to reject the faxes and calls. Enter up to 20 characters using 0-9, *, #, or space.

### Related Information

- ➔ [“Making the Printer Ready to Send and Receive Faxes \(Using Fax Setting Wizard\)” on page 68](#)
- ➔ [“Setting Receive Mode” on page 70](#)
- ➔ [“Making Settings to Receive Faxes Operating Only a Connected Phone \(Remote Receive\)” on page 72](#)
- ➔ [“Making Settings for Blocking Junk Faxes” on page 73](#)

## Receive Settings Menu

You can find the menu on the printer's control panel below:

**Settings > Fax Settings > Receive Settings**

Item	Description
Save to Computer	Saves received faxes as PDF files on a computer connected to the printer. You can set this to <b>Yes</b> by using only the FAX Utility. Install FAX Utility on the computer in advance. After setting this to <b>Yes</b> , you can change this to <b>Yes and Print</b> .
Auto Reduction	Prints received faxes with large-size documents reduced to fit on the paper in the paper source. Reducing may not always be possible depending on the received data. If this is turned off, large documents are printed at their original size on multiple sheets, or a blank second page may be ejected.
Split Page Settings	Prints received faxes with the page split when the size of the received documents is larger than the size of the paper loaded in the printer.

## Fax Settings

Item	Description
Auto Rotation	Rotates faxes received as landscape-orientated, A5 size documents so that they are printed on A5 size paper. This setting is applied when A5 size is set in <b>Settings &gt; Printer Setup &gt; Paper Source Settings &gt; Printer Setup &gt; Paper Size</b> .  Selecting <b>Off</b> , faxes received as landscape-orientated A5 size, the same width as A4 portrait documents, are assumed and printed as A4 size faxes.
Add Reception Information	Prints reception information in the received fax, even if the sender does not set the header information. The reception information includes the received date and time, sender's ID, and page number (such as "P1"). When <b>Split Page Settings</b> is enabled, the split page number is also included.
Print Start Timing	Select options to start printing the faxes to receive.  <input type="checkbox"/> All Pages Received: Printing starts after receiving all of the pages. To start printing from the first page or last page depends on the setting of <b>Collation Stack</b> feature. See the explanation for <b>Collation Stack</b> .  <input type="checkbox"/> First Page Received: Starts printing when the first page is received, and then prints in order as the pages are received. If the printer cannot start printing, such as when it is printing other jobs, the printer starts printing received pages as a batch when it is available.
Collation Stack	Since the first page is printed last (output to the top), the printed documents are stacked in the correct page order. When the printer is running low on memory, this feature may not be available.
Print Suspend Time	During the time period you specified from <b>Stop</b> through <b>Restart</b> you specified, the printer saves documents received in the printer's memory without printing them. This feature can be used for noise prevention at night or to prevent confidential documents from being disclosed while you are away. Before using this feature, make sure there is enough free memory. When you set this to <b>Off</b> , you can print the received documents even before the restart time.
Quiet Mode	Reduces the noise the printer makes when printing faxes, however, print speed may be reduced.

## Report Settings Menu

You can find the menu on the printer's control panel below:

**Settings > Fax Settings > Report Settings**

Item	Description
Fax Log Auto Print	Prints the fax log automatically. Select <b>On(Every 30)</b> to print a log every time 30 fax jobs are completed. Select <b>On(Time)</b> to print the log at a specified time. However, if the number of fax jobs exceeds 30, the log is printed before the specified time.
Attach Fax image to report	Prints a <b>Transmission Report</b> with an image of the first page of the sent document. Select <b>On(Large Image)</b> to print the upper part of the page without reducing. Select <b>On(Small Image)</b> to print the entire page reducing it to fit onto the report.
Report Format	Selects a format for fax reports in <b>Fax &gt; Menu &gt; More &gt; Fax Report</b> other than <b>Protocol Trace</b> . Select <b>Detail</b> to print with error codes.

## Security Settings Menu

You can find the menu on the printer's control panel below:

## Fax Settings

### Settings > Fax Settings > Security Settings

Item	Description
Direct Dialing Restrictions	<p>Selecting <b>On</b> disables manual entry of the recipient's fax numbers allowing the operator to select recipients only from the contacts list or sent history.</p> <p>Selecting <b>Enter Twice</b> requires the operator to enter the fax number again when the number was manually entered.</p> <p>Selecting <b>Off</b> enables manual entry of the recipient's fax numbers.</p>
Confirm Address List	Selecting <b>On</b> displays a recipient confirmation screen before starting the transmission.
Backup Data Auto Clear	<p>Selecting <b>On</b> automatically erases the backups when sending or receiving a document completes successfully and the backups become unnecessary.</p> <p>Selecting <b>Off</b>, to prepare for an unexpected power off due to an electricity failure or an incorrect operation, temporarily stores backup copies of sent and received documents in its memory.</p>
Clear Backup Data	<p>Erases all backup copies temporarily stored in the printer's memory. Run this before you give the printer to someone else or dispose of it.</p> <p>This menu is not displayed on the Web Config screen.</p>

## Menu Options for User Default Settings

You can find the menu on the printer's control panel below:

### Settings > Fax Settings > User Default Settings

The settings made in this menu become your default settings for in the **Fax > Menu**. For details, see the related information below.

#### Related Information

- ➔ [“Scan Settings” on page 129](#)
- ➔ [“Fax Send Settings” on page 129](#)

# Printing

---

## Printing from the Printer Driver on Windows

### Accessing the Printer Driver

When accessing the printer driver from the computer's control panel, the settings are applied to all of the applications.

#### Accessing the printer driver from the control panel

Windows 10/Windows Server 2016

Click on the start button, and then select **Windows System > Control Panel > View devices and printers in Hardware and Sound**. Right-click on your printer, or press and hold it and then select **Printing preferences**.

Windows 8.1/Windows 8/Windows Server 2012 R2/Windows Server 2012

Select **Desktop > Settings > Control Panel > View devices and printers in Hardware and Sound**. Right-click on your printer, or press and hold it and then select **Printing preferences**.

Windows 7/Windows Server 2008 R2

Click the start button, and select **Control Panel > View devices and printers in Hardware and Sound**. Right-click on your printer and select **Printing preferences**.

Windows Vista/Windows Server 2008

Click the start button, and select **Control Panel > Printers in Hardware and Sound**. Right-click on your printer and select **Printing preferences**.

Windows XP/Windows Server 2003 R2/Windows Server 2003

Click the start button, and select **Control Panel > Printers and Other Hardware > Printers and Faxes**. Right-click on your printer and select **Printing preferences**.

#### Accessing the printer driver from the printer icon on the task bar

The printer icon on the desktop task bar is a shortcut icon allowing you to quickly access the printer driver.

If you click the printer icon and select **Printer Settings**, you can access the same printer settings window as the one displayed from the control panel. If you double-click this icon, you can check the status of the printer.

**Note:**

*If the printer icon is not displayed on the task bar, access the printer driver window, click **Monitoring Preferences** on the **Maintenance** tab, and then select **Register the shortcut icon to the taskbar**.*

### Printing Basics

**Note:**

*Operations may differ depending on the application. See the application's help for details.*

1. Open the file you want to print.  
Load paper in the printer if it has not already been loaded.

## Printing

2. Select **Print** or **Page Setup** from the **File** menu.
3. Select your printer.
4. Select **Preferences** or **Properties** to access the printer driver window.

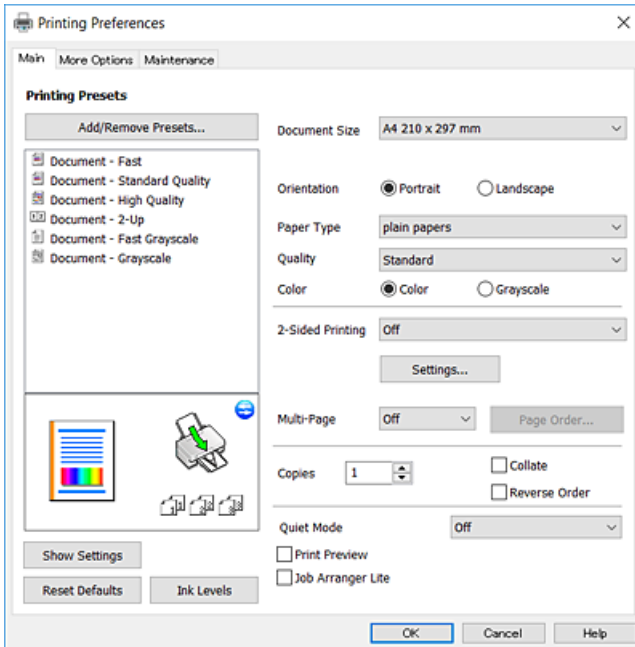

5. Change the settings as necessary.  
See the menu options for the printer driver for details.

**Note:**

- You can also see the online help for explanations of the setting items. Right-clicking an item displays **Help**.
- When you select **Print Preview**, you can see a preview of your document before printing.

6. Click **OK** to close the printer driver window.
7. Click **Print**.

**Note:**

When you select **Print Preview**, a preview window is displayed. To change the settings, click **Cancel**, and then repeat the procedure from step 2.

### Related Information

- ➔ [“Available Paper and Capacities” on page 45](#)
- ➔ [“Loading Paper in the Rear Paper Feed” on page 48](#)
- ➔ [“Main Tab” on page 95](#)



## Printing

### Printing on 2-Sides

You can print on both sides of the paper. Flip the paper over to print on the other side when the printer has finished printing the first side. You can also print a booklet that can be created by re-ordering the pages and folding the printout.

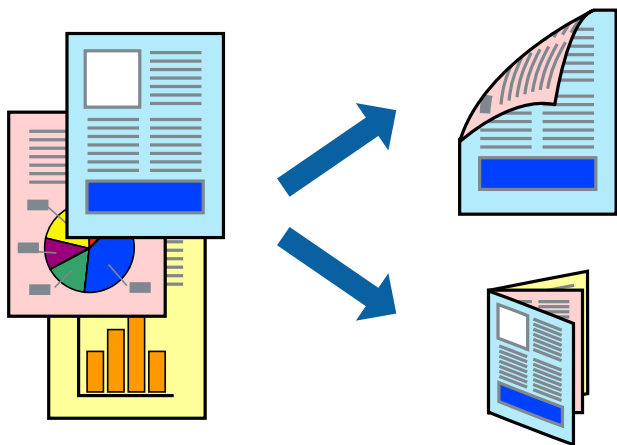

**Note:**

- This feature is not available for borderless printing.
- If you do not use paper that is suitable for 2-sided printing, the print quality may decline and paper jams may occur.
- Depending on the paper and the data, ink may bleed through to the other side of the paper.

**Related Information**

➔ [“Available Paper and Capacities” on page 45](#)

### Print Settings

2-sided printing is available when EPSON Status Monitor 3 is enabled. However, it may not be available when the printer is accessed over a network or is used as a shared printer.

**Note:**

To enable EPSON Status Monitor 3, click **Extended Settings** on the **Maintenance** tab, and then select **Enable EPSON Status Monitor 3**.

1. On the printer driver's **Main** tab, select an option from **2-Sided Printing**.
2. Click **Settings**, make the appropriate settings, and then click **OK**.

**Note:**

To print a folded booklet, select **Booklet**.

3. Click **Print**.

When the first side has finished printing, a pop-up window is displayed on the computer. Follow the on-screen instructions.

**Related Information**

➔ [“Printing Basics” on page 79](#)

## Printing

➔ [“Main Tab” on page 95](#)

### Printing Several Pages on One Sheet

You can print two or four pages of data on a single sheet of paper.

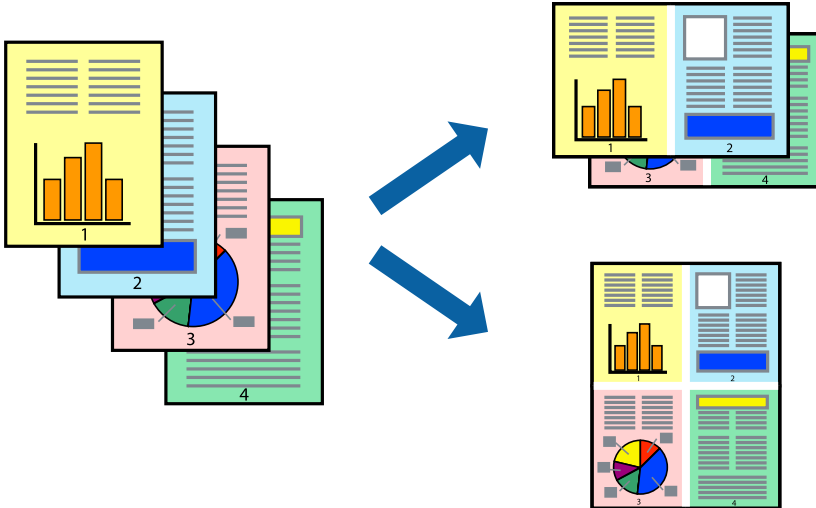

### Print Settings

On the printer driver's **Main** tab, select **2-Up** or **4-Up** as the **Multi-Page** setting.

**Note:**

*This feature is not available for borderless printing.*

### Related Information

- ➔ [“Printing Basics” on page 79](#)
- ➔ [“Main Tab” on page 95](#)

### Printing and Stacking in Page Order (Reverse Order Printing)

You can print from the last page so that the documents are stacked in page order.

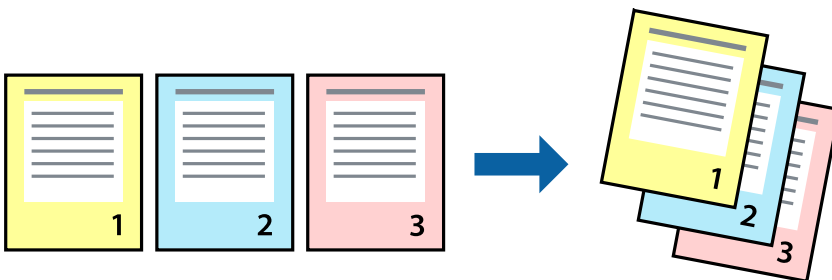

## Printing

### Print Settings

On the printer driver's **Main** tab, select **Reverse Order**.

#### Related Information

- ➔ [“Printing Basics” on page 79](#)
- ➔ [“Main Tab” on page 95](#)

### Printing a Reduced or Enlarged Document

You can reduce or enlarge the size of a document by a specific percentage or to fit the paper size you loaded in the printer.



### Print Settings

On the printer driver's **More Options** tab, select the document size from the **Document Size** setting. Select the paper size you want to print on from the **Output Paper** setting. Select **Reduce/Enlarge Document**, and then select **Fit to Page** or **Zoom to**. When you select **Zoom to**, enter a percentage.

Select **Center** to print the images in the center of the page.

#### **Note:**

*This feature is not available for borderless printing.*

#### Related Information

- ➔ [“Printing Basics” on page 79](#)
- ➔ [“More Options Tab” on page 95](#)

## Printing One Image on Multiple Sheets for Enlargement (Creating a Poster)

This feature allows you to print one image on multiple sheets of paper. You can create a larger poster by taping them together.

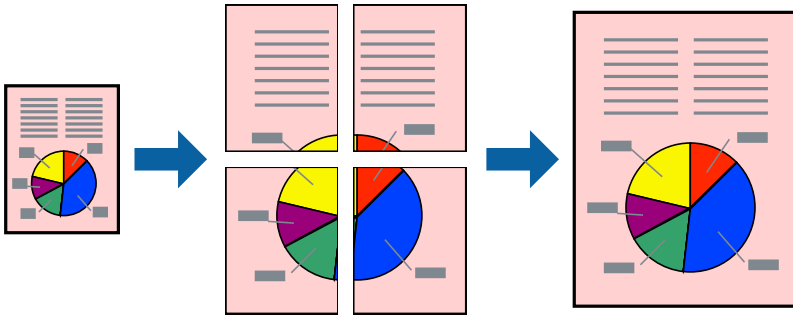

**Note:**

*This feature is not available for borderless printing.*

### Print Settings

On the printer driver's **Main** tab, select **2x1 Poster**, **2x2 Poster**, **3x3 Poster**, or **4x4 Poster** as the **Multi-Page** setting. If you click **Settings**, you can select the panels that you do not want to print. You can also select the cutting guide options.

#### Related Information

- ➔ [“Printing Basics” on page 79](#)
- ➔ [“Main Tab” on page 95](#)

### Making Posters Using Overlapping Alignment Marks

Here is an example of how to make a poster when **2x2 Poster** is selected, and **Overlapping Alignment Marks** is selected in **Print Cutting Guides**.

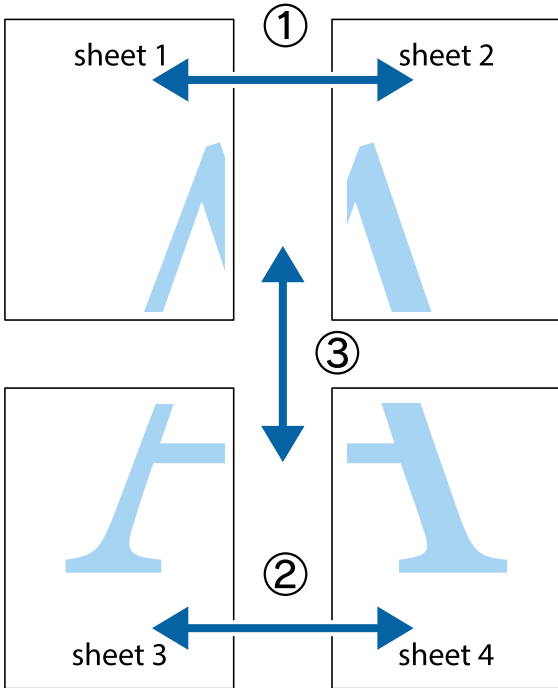

1. Prepare Sheet 1 and Sheet 2. Cut off the margins of Sheet 1 along the vertical blue line through the center of the top and bottom cross marks.

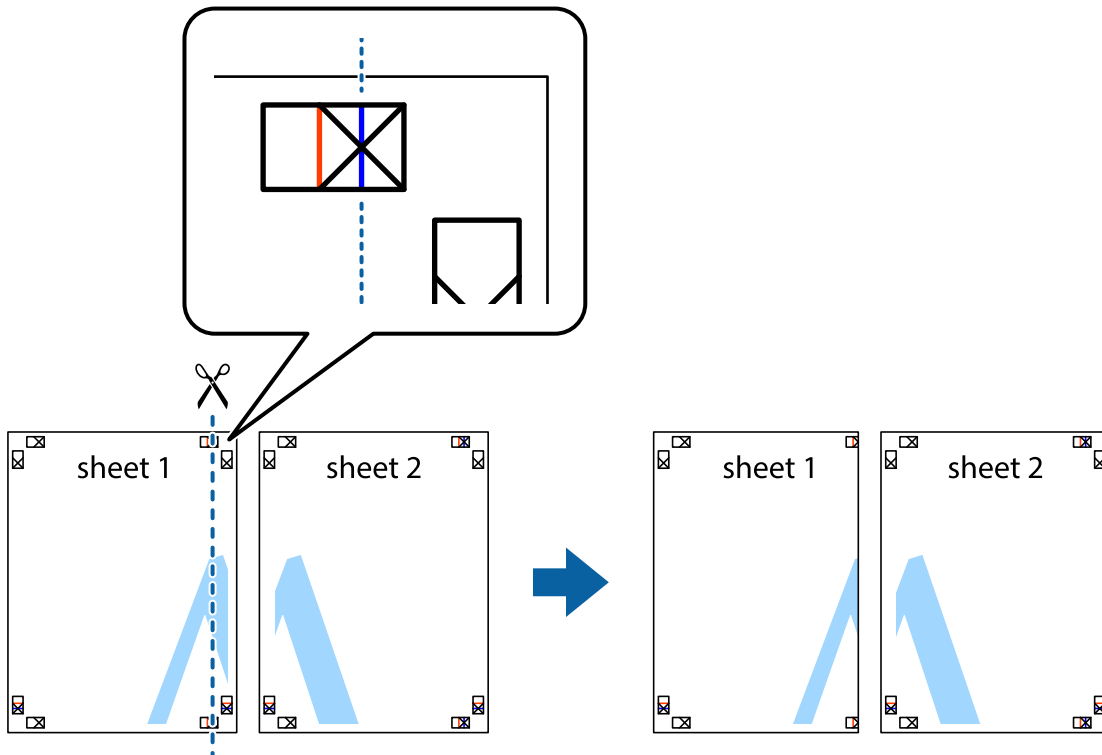

### Printing

2. Place the edge of Sheet 1 on top of Sheet 2 and align the cross marks, then temporarily tape the two sheets together from the back.

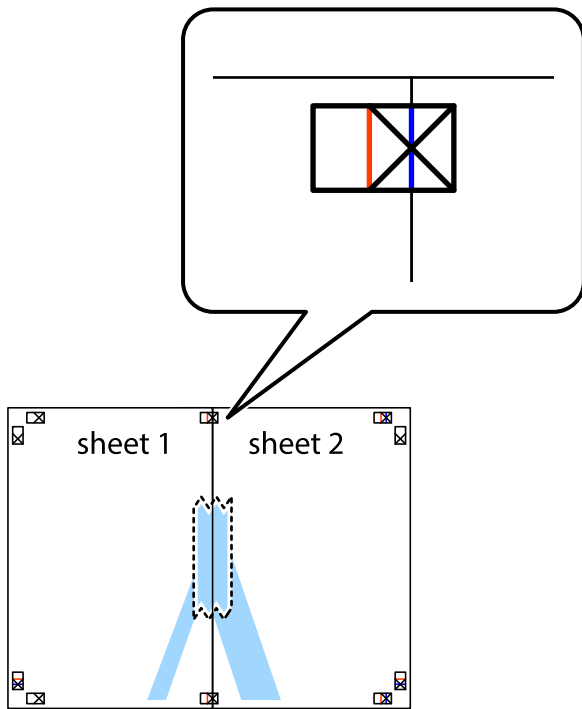

3. Cut the taped sheets in two along the vertical red line through the alignment markers (this time, the line to the left of the cross marks).



## Printing

4. Tape the sheets together from the back.



5. Repeat steps 1 to 4 to tape Sheet 3 and Sheet 4 together.
6. Cut off the margins of Sheet 1 and Sheet 2 along the horizontal blue line through the center of the left and right side cross marks.

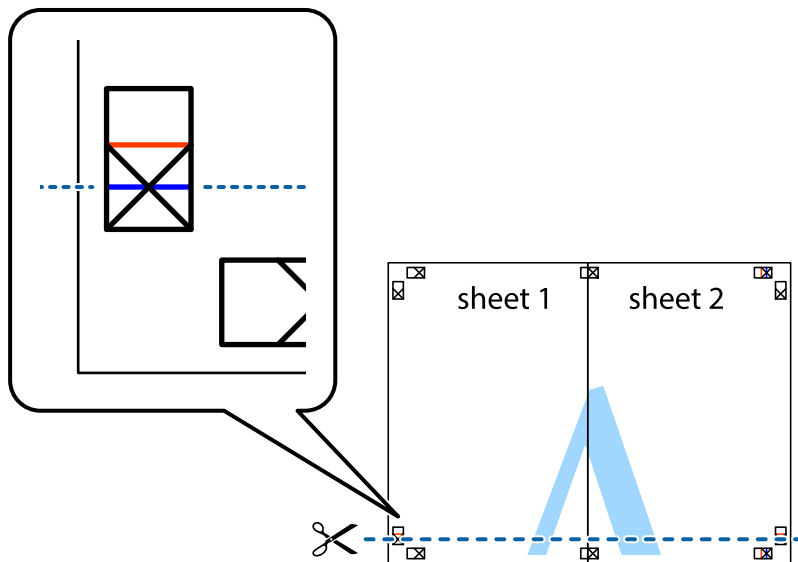

### Printing

7. Place the edge of Sheet 1 and Sheet 2 on top of Sheet 3 and Sheet 4 and align the cross marks, and then temporarily tape them together from the back.





### Printing

- Cut the taped sheets in two along the horizontal red line through the alignment markers (this time, the line above the cross marks).



- Tape the sheets together from the back.



## Printing

10. Cut off the remaining margins along the outer guide.

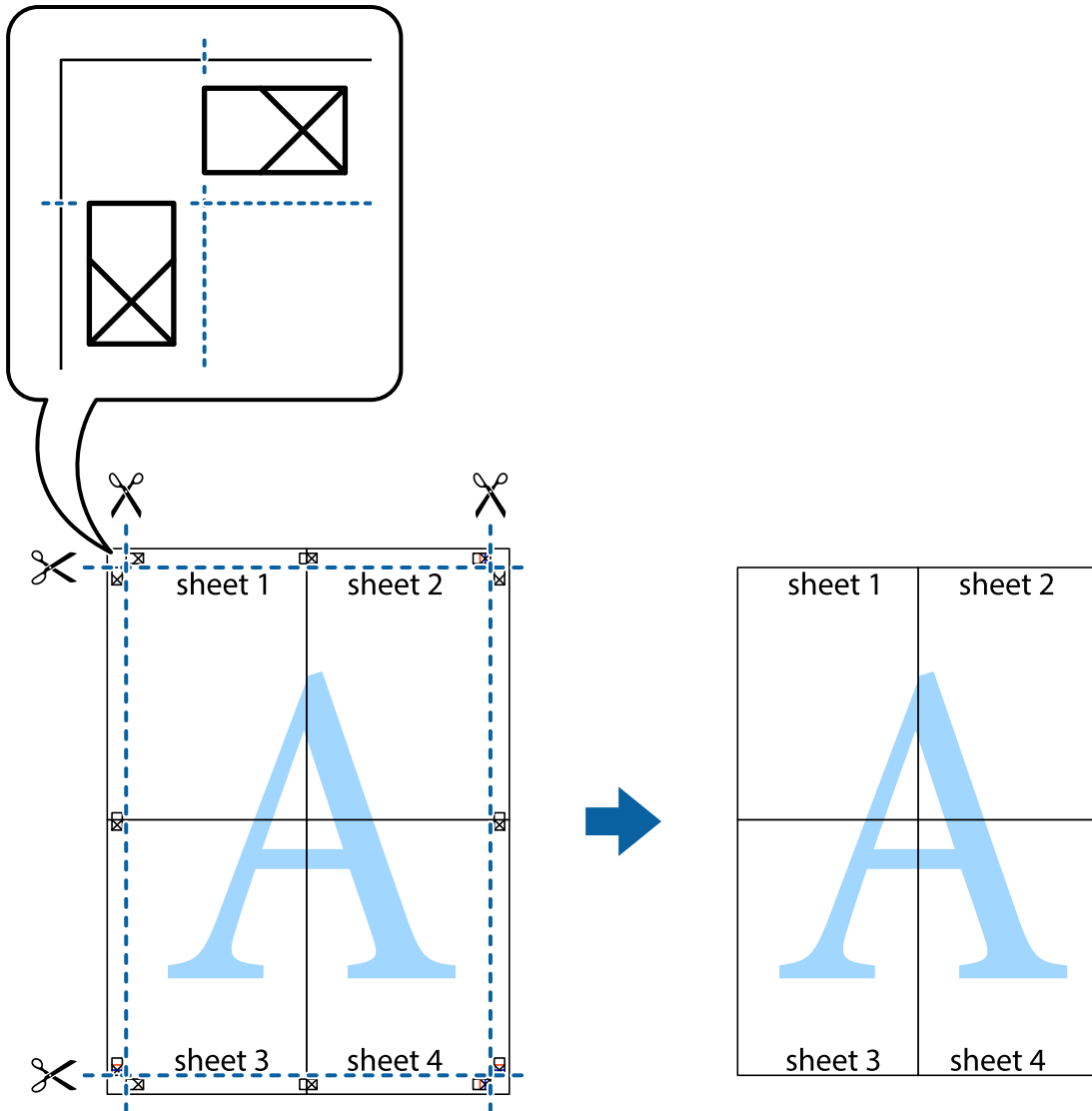

## Printing with a Header and Footer

You can print information such as a user name and printing date in headers or footers.

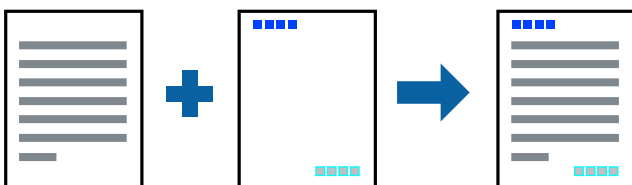

## Print Settings

On the printer driver's **More Options** tab, click **Watermark Features**, and then select **Header/Footer**. Click **Settings**, and then select the items you want to print.

## Printing

### Related Information

- ➔ “Printing Basics” on page 79
- ➔ “More Options Tab” on page 95

## Printing a Watermark

You can print a watermark such as "Confidential" on your printouts. You can also add your own watermark.

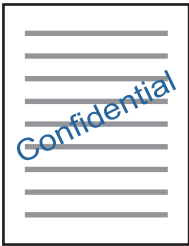

**Note:**

*This feature is not available with borderless printing.*

### Print Settings

On the printer driver's **More Options** tab, click **Watermark Features**, and then select Watermark. Click **Settings** to change details such as the size, density, or position of the watermark.

### Related Information

- ➔ “Printing Basics” on page 79
- ➔ “More Options Tab” on page 95

## Printing Multiple Files Together

Job Arranger Lite allows you to combine several files created by different applications and print them as a single print job. You can specify the print settings for combined files, such as multi-page layout, and 2-sided printing.

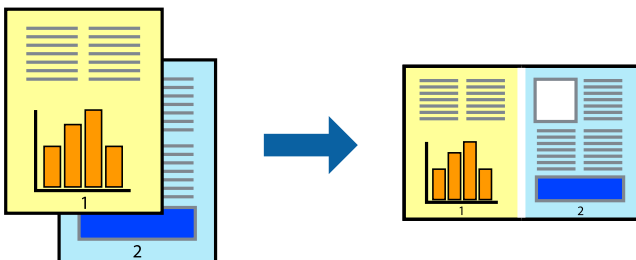

### Print Settings

On the printer driver's **Main** tab, select **Job Arranger Lite**. When you start printing, the Job Arranger Lite window is displayed. With the Job Arranger Lite window opened, open the file that you want to combine with the current file, and then repeat the above steps.

## Printing

When you select a print job added to Print Project in the Job Arranger Lite window, you can edit the page layout.

Click **Print** from the **File** menu to start printing.

**Note:**

If you close the Job Arranger Lite window before adding all the print data to the Print Project, the print job you are currently working on is canceled. Click **Save** from the **File** menu to save the current job. The extension of the saved files is ".ecl".

To open a Print Project, click **Job Arranger Lite** on the printer driver's **Maintenance** tab to open the Job Arranger Lite window. Next, select **Open** from the **File** menu to select the file.

### Related Information

➔ ["Printing Basics" on page 79](#)

➔ ["Main Tab" on page 95](#)

## Printing Using the Color Universal Print Feature

You can enhance the visibility of texts and images in printouts.

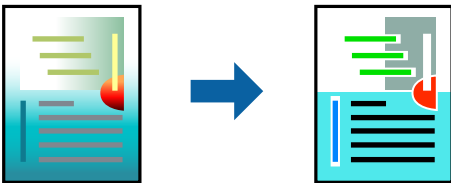

Color Universal Print is only available when the following settings are selected.

- Paper Type: Plain paper
- Quality: **Standard** or a higher quality
- Print Color: **Color**
- Applications: Microsoft® Office 2007 or later
- Text Size: 96 pts or smaller

### Print Settings

On the printer driver's **More Options** tab, click **Image Options** in the **Color Correction** setting. Select an option from the **Color Universal Print** setting. Click **Enhancement Options** to make further settings.

**Note:**

- Certain characters may be altered by patterns, such as "+" appearing as "±".
- Application-specific patterns and underlines may alter content printed using these settings.
- Print quality may decrease in photos and other images when using Color Universal Print settings.
- Printing is slower when using Color Universal Print settings.

### Related Information

➔ ["Printing Basics" on page 79](#)

➔ ["More Options Tab" on page 95](#)

## Printing

### Adjusting the Print Color

You can adjust the colors used in the print job. These adjustments are not applied to the original data.

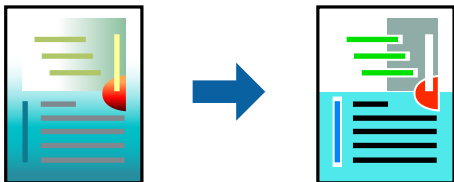

### Print Settings

On the printer driver's **More Options** tab, select **Custom** as the **Color Correction** setting. Click **Advanced** to open the **Color Correction** window, and then select the method of color correction.

**Note:**

- Automatic** is selected as default on the **More Options** tab. With this setting, the colors are automatically adjusted to match the paper type and print quality settings.
- PhotoEnhance** on the **Color Correction** window adjusts the color by analyzing the location of the subject. Therefore, if you have changed the location of the subject by reducing, enlarging, cropping, or rotating the image, the color may change unexpectedly. Selecting the borderless setting also changes the location of the subject resulting in changes in color. If the image is out of focus, the tone may be unnatural. If the color is changed or becomes unnatural, print in a mode other than **PhotoEnhance**.

#### Related Information

- ➔ [“Printing Basics” on page 79](#)
- ➔ [“More Options Tab” on page 95](#)

### Printing to Emphasize Thin Lines

You can thicken thin lines that are too thin to print.

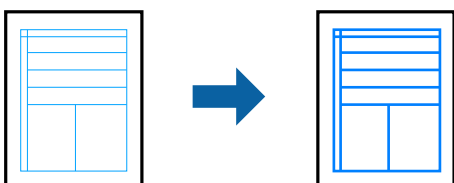

### Print Settings

On the printer driver's **More Options** tab, click **Image Options** in the **Color Correction** setting. Select **Emphasize Thin Lines**.

#### Related Information

- ➔ [“Printing Basics” on page 79](#)
- ➔ [“More Options Tab” on page 95](#)

## Printing Clear Bar Codes

You can print a bar code clearly and make it easy to scan. Only enable this feature if the bar code you printed cannot be scanned.

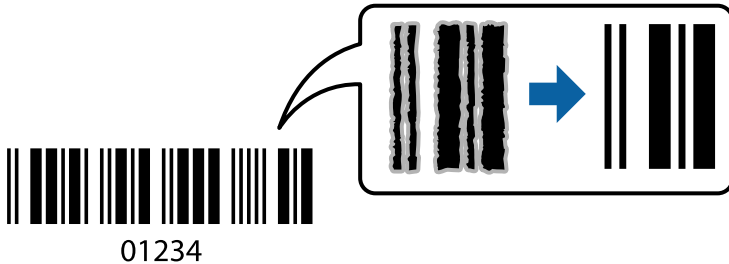

You can use this feature under the following conditions.

- Paper: Plain paper, Copy paper, or Envelope
- Quality: **Standard**

The print quality may be changed when printing. The print speed may become slower and print density may become higher.

**Note:**

*Deblurring may not always be possible depending on the circumstances.*

## Print Settings

On the printer driver's **Maintenance** tab, click **Extended Settings**, and then select **Barcode mode**.

### Related Information

- ➔ [“Printing Basics” on page 79](#)
- ➔ [“Maintenance Tab” on page 96](#)

## Canceling Printing

You can cancel a print job from the computer. However, you cannot cancel a print job from the computer once it has been completely sent to the printer. In this case, cancel the print job by using the printer's control panel.

## Canceling

On your computer, right-click on your printer in **Devices and Printers**, **Printer**, or in **Printers and Faxes**. Click **See what's printing**, right-click on the job you want to cancel, and then select **Cancel**.

## Menu Options for the Printer Driver

Open the print window in an application, select the printer, and then access the printer driver window.

**Note:**

*Menus vary depending on the option you selected.*

## Printing

### Main Tab

Printing Presets	Add/Remove Presets	You can add or remove your own presets for frequently used print settings. Select the preset you want to use from the list.
Show Settings	Displays a list of items currently set on the <b>Main</b> and <b>More Options</b> tabs.	
Reset Defaults	Return all settings to their factory default values. The settings on the <b>More Options</b> tab are also reset to their defaults.	
Ink Levels	Displays the approximate ink levels.	
Paper Source	Select the paper source from which the paper is fed. Select <b>Auto Select</b> to automatically select the paper source selected in the print settings on the printer's control panel. If the printer has only one paper source, this item is not displayed.	
Document Size	Select the paper size on which you want to print. If you select <b>User-Defined</b> , enter the paper width and height.	
Borderless	Enlarges the print data slightly more than the paper size so that no margins are printed around the edges of the paper. Click <b>Settings</b> to select the amount of enlargement.	
Orientation	Select the orientation you want to use to print.	
Paper Type	Select the type of paper on which you print.	
Quality	Select the print quality you want to use for printing. Available settings depend on the paper type you select. Click <b>More Settings</b> to make further settings.	
Color	Select the color for your print job.	
2-Sided Printing	Allows you to perform 2-sided printing.	
	Settings	You can specify the binding edge and the binding margins.
Multi-Page	Allows you to print several pages on one sheet or perform poster printing. Click <b>Page Order</b> to specify the order in which pages are printed.	
Copies	Set the number of copies you want to print.	
	Collate	Prints multi-page documents collated in order and sorted into sets.
	Reverse Order	Allows you to print from the last page so that the pages are stacked in the correct order after printing.
Quiet Mode	Reduces the noise the printer makes. However, enabling this may reduce print speed.	
Print Preview	Displays a preview of your document before printing.	
Job Arranger Lite	Select to print using the Job Arranger Lite feature.	

### More Options Tab

Printing Presets	Add/Remove Presets	You can add or remove your own presets for frequently used print settings. Select the preset you want to use from the list.
Show Settings	Displays a list of items currently set on the <b>Main</b> and <b>More Options</b> tabs.	
Reset Defaults	Return all settings to their factory default values. The settings on the <b>Main</b> tab are also reset to their defaults.	

## Printing

Document Size	Select the size of your document.	
Output Paper	Select the paper size on which you want to print. If the <b>Output Paper</b> differs from the <b>Document Size</b> , <b>Reduce/Enlarge Document</b> is selected automatically. You do not have to select it when printing without reducing or enlarging the size of a document.	
Reduce/Enlarge Document	Allows you to reduce or enlarge the size of a document.	
	Fit to Page	Automatically reduce or enlarge the document to fit to the paper size selected in <b>Output Paper</b> .
	Zoom to	Prints with a specific percentage.
	Center	Prints images in the center of the paper.
Color Correction	Automatic	Adjusts the colors of images automatically.
	Custom	Allows you to perform manual color correction. Click <b>Advanced</b> for further settings.
	Image Options	Enables print quality options such as Color Universal Print or Fix Red-Eye. You can also thicken thin lines to make them visible on the printouts.
Watermark Features	Allows you to make settings for anti-copy pattern or watermarks.	
Additional Settings	Rotate 180°	Rotates pages 180 degrees before printing. This feature is helpful when printing on paper such as envelopes that are loaded in fixed direction in the printer.
	High Speed	Prints when the print head moves in both directions. The print speed is faster, but the quality may decline.
	Mirror Image	Inverts an image to print as it would appear in a mirror.

## Maintenance Tab

Nozzle Check	Prints a nozzle check pattern to check if the print head nozzles are clogged.
Head Cleaning	Cleans the clogged nozzles in the print head. Because this feature uses some ink, clean the print head only if the nozzles are clogged.
Power Cleaning	Replaces all of the ink inside the ink tubes to improve the print quality.
Job Arranger Lite	Opens the Job Arranger Lite window. Here you can open and edit previously saved data.
EPSON Status Monitor 3	Opens the EPSON Status Monitor 3 window. Here you can confirm the status of the printer and the consumables.
Monitoring Preferences	Allows you to make settings for items on the EPSON Status Monitor 3 window.
Extended Settings	Allows you to make a variety of settings. Right-click each item to view the Help for more details.
Print Queue	Displays the jobs waiting to be printed. You can check, pause, or resume print jobs.
Printer and Option Information	Displays the number of sheets of paper fed into the printer or the ADF.
Language	Changes the language used on the printer driver window. To apply the settings, close the printer driver, and then open it again.



## Printing

Software Update	Starts EPSON Software Updater to check for the latest version of applications on the Internet.
Technical Support	Allows you to access the Epson technical support website.

# Printing from the Printer Driver on Mac OS

## Printing Basics

**Note:**

Operations differ depending on the application. See the application's help for details.

1. Open the file you want to print.  
Load paper in the printer if it has not already been loaded.
2. Select **Print** from the **File** menu or another command to access the print dialog.  
If necessary, click **Show Details** or ▼ to expand the print window.
3. Select your printer.
4. Select **Print Settings** from the pop-up menu.

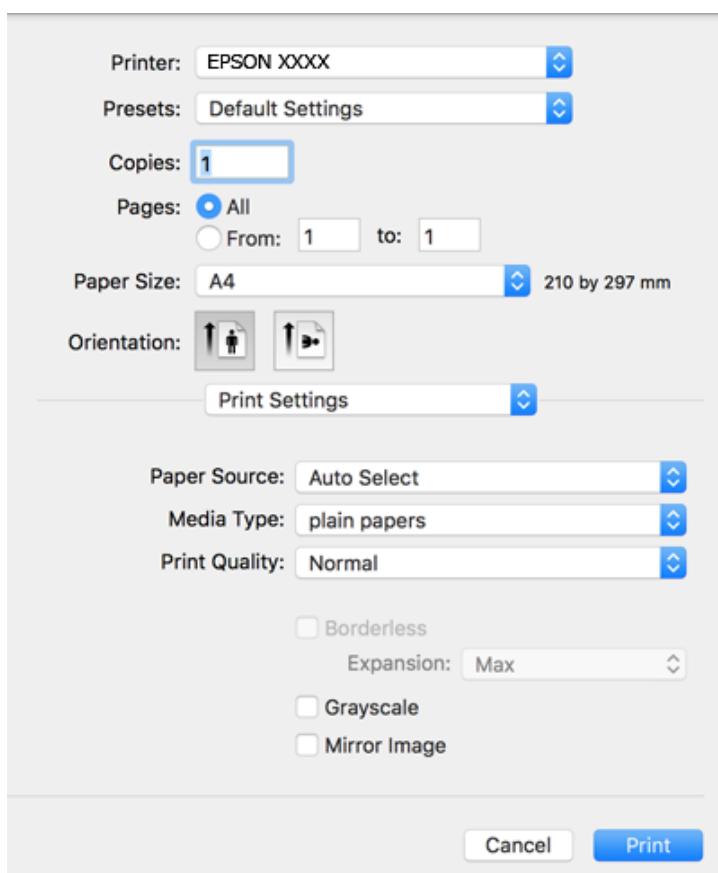

## Printing

### Note:

On OS X Mountain Lion or later, if the **Print Settings** menu is not displayed, the Epson printer driver has not been installed correctly.

Select **System Preferences** from the  menu > **Printers & Scanners** (or **Print & Scan**, **Print & Fax**), remove the printer, and then add the printer again. See the following to add a printer.

<http://epson.sn>

5. Change the settings as necessary.  
See the menu options for the printer driver for details.
6. Click **Print**.

### Related Information

- ➔ “Available Paper and Capacities” on page 45
- ➔ “Loading Paper in the Rear Paper Feed” on page 48
- ➔ “Menu Options for Print Settings” on page 102

## Printing Several Pages on One Sheet

You can print two or four pages of data on a single sheet of paper.

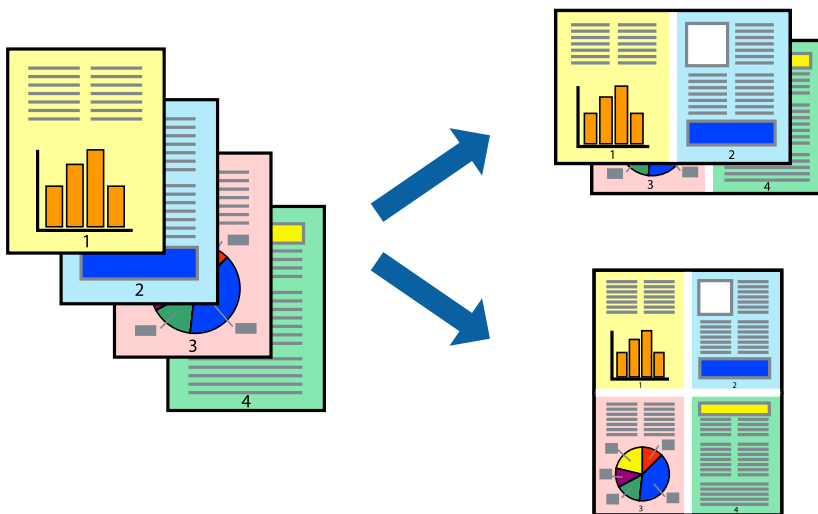

## Print Settings

Select **Layout** from the pop-up menu. Set the number of pages in **Pages per Sheet**, the **Layout Direction** (page order), and **Border**.

### Related Information

- ➔ “Printing Basics” on page 97
- ➔ “Menu Options for Layout” on page 101

## Printing

### Printing and Stacking in Page Order (Reverse Order Printing)

You can print from the last page so that the documents are stacked in page order.

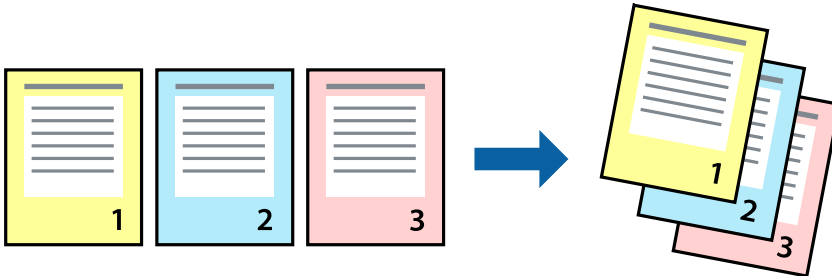

### Print Settings

Select **Paper Handling** from the pop-up menu. Select **Reverse** as the **Page Order** setting.

#### Related Information

- ➔ [“Printing Basics” on page 97](#)
- ➔ [“Menu Options for Paper Handling” on page 101](#)

### Printing a Reduced or Enlarged Document

You can reduce or enlarge the size of a document by a specific percentage or to fit the paper size you loaded in the printer.



### Print Settings

When printing to fit to the paper size, select **Paper Handling** from the pop-up menu, and then select **Scale to fit paper size**. Select the paper size you loaded in the printer in **Destination Paper Size**. When reducing the size of the document, select **Scale down only**.

When printing at a specific percentage, do one of the following.

## Printing

- ❑ Select **Print** from the **File** menu of the application. Select **Printer**, enter a percentage in **Scale**, and then click **Print**.
- ❑ Select **Page Setup** from the **File** menu of the application. Select your printer in **Format For**, enter a percentage in **Scale**, and then click **OK**.

### Note:

Select the paper size you set in the application as the **Paper Size** setting.

### Related Information

- ➔ [“Printing Basics” on page 97](#)
- ➔ [“Menu Options for Paper Handling” on page 101](#)

## Adjusting the Print Color

You can adjust the colors used in the print job. These adjustments are not applied to the original data.

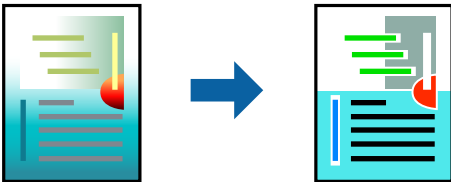

## Print Settings

Select **Color Matching** from the pop-up menu, and then select **EPSON Color Controls**. Select **Color Options** from the pop-up menu, and then select one of the available options. Click the arrow next to **Advanced Settings**, and then make more detailed settings.

### Related Information

- ➔ [“Printing Basics” on page 97](#)
- ➔ [“Menu Options for Color Matching” on page 101](#)
- ➔ [“Menu Options for Color Options” on page 102](#)

## Canceling Printing

You can cancel a print job from the computer. However, you cannot cancel a print job from the computer once it has been completely sent to the printer. In this case, cancel the print job by using the printer's control panel.

### Canceling

Click the printer icon in the **Dock**. Select the job you want to cancel, and then do one of the following.

- ❑ OS X Mountain Lion or later
  - Click  next to the progress meter.

## Printing

- Mac OS X v10.6.8 to v10.7.x

Click **Delete**.

### Menu Options for the Printer Driver

Open the print window in an application, select the printer, and then access the printer driver window.

**Note:**

*Menus vary depending on the option you selected.*

### Menu Options for Layout

Pages per Sheet	Select the number of pages to be printed on one sheet.
Layout Direction	Specify the order in which the pages will be printed.
Border	Prints a border around the pages.
Reverse page orientation	Rotates pages 180 degrees before printing. Select this item when printing on paper such as envelopes that are loaded in fixed direction in the printer.
Flip horizontally	Inverts an image to print as it would appear in a mirror.

### Menu Options for Color Matching

ColorSync	Select the method for color adjustment. These options adjust colors between the printer and the computer display to minimize the difference in color.
EPSON Color Controls	

### Menu Options for Paper Handling

Collate pages	Prints multi-page documents collated in order and sorted into sets.	
Pages to Print	Select to print only odd pages or even pages.	
Page Order	Select to print from the top or the last page.	
Scale to fit paper size	Prints to fit to the paper size you loaded.	
	Destination Paper Size	Select the paper size to print on.
	Scale down only	Select when reducing the size of the document.

### Menu Options for Cover Page

Print Cover Page	Select whether or not to print a cover page. When you want to add a back cover, select <b>After document</b> .
Cover Page Type	Select the contents of the cover page.

## Printing

### Menu Options for Print Settings

Paper Source	Select the paper source from which the paper is fed. If the printer has only one paper source, this item is not displayed. Selecting <b>Auto Select</b> selects the paper source that matches the paper setting on the printer automatically.	
Media Type	Select the type of paper on which you print.	
Print Quality	Select the print quality you want to use for printing. The options vary depending on the paper type.	
Borderless	This checkbox is selected when you select a borderless paper size.	
	Expansion	In borderless printing, the print data is enlarged slightly more than the paper size so that no margins are printed around the edges of the paper. Select the amount of enlargement.
Grayscale	Select when you want to print in black or shades of gray.	
Mirror Image	Inverts an image to print as it would appear in a mirror.	

### Menu Options for Color Options

Manual Settings	Adjusts the color manually. In <b>Advanced Settings</b> , you can select detailed settings.
PhotoEnhance	Produces sharper images and more vivid colors by automatically adjusting the contrast, saturation, and brightness of the original image data.
Off (No Color Adjustment)	Print without enhancing or adjusting the color in any way.

## Making Operation Settings for the Mac OS Printer Driver

### Accessing the Operation Settings Window of the Mac OS Printer Driver

Select **System Preferences** from the  menu > **Printers & Scanners** (or **Print & Scan**, **Print & Fax**), and then select the printer. Click **Options & Supplies** > **Options** (or **Driver**).

### Operation Settings of the Mac OS Printer Driver

- Skip Blank Page: Avoids printing blank pages.
- Quiet Mode: Prints quietly. However, the print speed may be slower.
- High Speed Printing: Prints when the print head moves in both directions. The print speed is faster, but the quality may decline.
- Remove white borders: Removes unnecessary margins during borderless printing.
- Warning Notifications: Allows the printer driver to display warning notifications.
- Establish bidirectional communication: Usually, this should be set to **On**. Select **Off** when acquiring the printer information is impossible because the printer is shared with Windows computers on a network or for any other reason.

---

## Printing from Smart Devices

### Using Epson iPrint

Epson iPrint is an application that allows you to print photos, documents, and web pages from a smart device such as a smartphone or tablet. You can use local print, printing from a smart device that is connected to the same wireless network as your printer, or remote print, printing from a remote location over the Internet. To use remote print, register your printer in the Epson Connect service.

If you start Epson iPrint when the printer is not connected to the network, a message is displayed instructing you to connect to the printer. Follow the instructions to complete the connection. See the URL below for the operating conditions.

<http://epson.sn>



#### Related Information

➔ [“Printing Using a Network Service” on page 165](#)

### Installing Epson iPrint

You can install Epson iPrint on your smart device from the following URL or QR code.

<http://ipr.to/c>



### Printing Using Epson iPrint

Start Epson iPrint from your smart device and select the item you want to use from the home screen.

## Printing

The following screens are subject to change without notice. The contents may vary depending on the product.

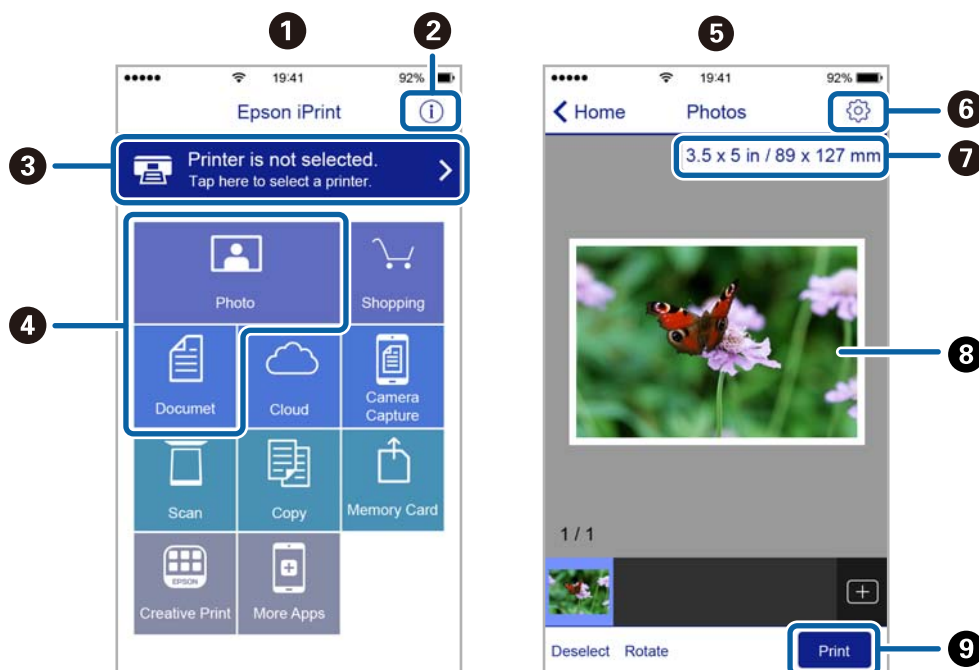

1	Home screen displayed when the application is started.
2	Displays information on how to setup the printer and a FAQ.
3	Displays the screen where you can select the printer and make printer settings. Once you have selected the printer, you do not need to select it again from the next time.
4	Select what you want to print such as photos and documents.
5	The print photos screen displayed when the photo menu is selected.
6	Displays the screen to make print settings such as paper size and paper type.
7	Displays the paper size. When this is displayed as a button, tap it to display the paper settings currently set on the printer.
8	Displays photos and documents you selected.
9	Starts printing.

**Note:**

To print from the document menu using iPhone, iPad, and iPod touch running iOS, start Epson iPrint after transferring the document you want to print using the file sharing function in iTunes.

## Using Epson Print Enabler

You can wirelessly print your documents, emails, photos, and web pages right from your Android phone or tablet (Android v4.4 or later). With a few taps, your Android device will discover an Epson printer that is connected to the same wireless network.

**Note:**

Operations may differ depending on the device.



## Printing

1. Load paper in the printer.
2. Set up your printer for wireless printing.
3. On your Android device, install the Epson Print Enabler plug-in from Google Play.
4. Connect your Android device to the same wireless network as your printer.
5. Go to **Settings** on your Android device, select **Connected devices** > **Printing**, and then enable Epson Print Enabler.
6. From an Android application such as Chrome, tap the menu icon and print whatever is on the screen.

**Note:**

*If you do not see your printer, tap **All Printers** and select your printer.*

### Related Information

- ➔ [“Loading Paper in the Rear Paper Feed” on page 48](#)
- ➔ [“Connecting to a Smart Device” on page 22](#)

## Using AirPrint

AirPrint enables instant wireless printing from iPhone, iPad, and iPod touch with the latest version of iOS, and Mac with the latest version of OS X or macOS.



**Note:**

*If you disabled paper configuration messages on your product control panel, you cannot use AirPrint. See the link below to enable the messages, if necessary.*

1. Load paper in your product.
2. Set up your product for wireless printing. See the link below.  
<http://epson.sn>
3. Connect your Apple device to the same wireless network that your product is using.
4. Print from your device to your product.

**Note:**

*For details, see the AirPrint page on the Apple website.*

---

## Canceling the Ongoing Job

Press the  button on the printer's control panel to cancel the print job in progress.

# Copying

## Copying

1. Load paper in the printer.
2. Place the originals.

**Note:**

When originals are placed in the ADF, ADF is displayed on the control panel. When you start copying, originals are copied from the ADF even if there is an original on the scanner glass.

3. Select **Copy** on the home screen.

To select an item, use the ▲ ▼ ◀ ▶ buttons, and then press the OK button.

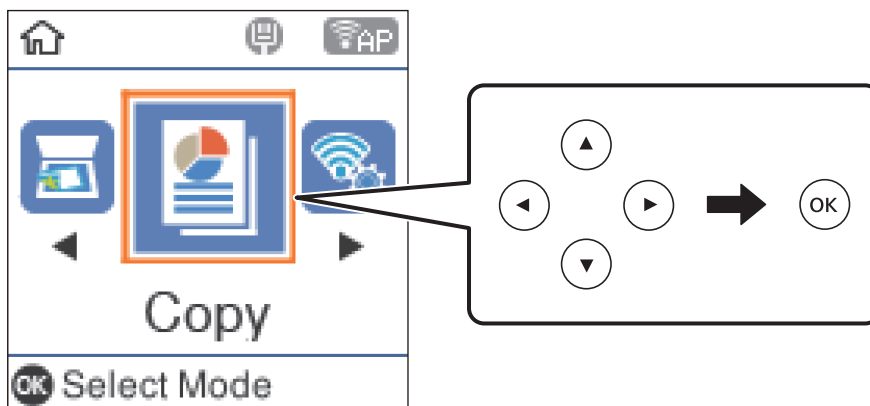

4. Set the number of copies.
5. Select color copy or monochrome copy.
6. Press the OK button to display and check the print settings. To change the settings, press the ▼ button, select the setting items and change settings. When you have finished, press the OK button.

**Note:**

If you want to copy by reducing or enlarging the size of a document by a specific percentage, select any item other than **Auto Fit** as the **Reduce/Enlarge** setting. Specify a percentage in **Custom Size**.

7. Press the ◊ button.

### Related Information

- ➔ [“Placing Originals” on page 51](#)
- ➔ [“Menu Options for Copying” on page 108](#)

---

## Copying Multiple Originals onto One Sheet

1. Select **Copy** on the home screen.  
To select an item, use the ▲ ▼ ◀ ▶ buttons, and then press the OK button.
2. Press the OK button to display the print settings, and then press the ▼ button.
3. Select **2-up** as the **Multi-Page** setting, and then press the OK button.
4. Select the order of the layout for the **Layout Order** setting, and then press the OK button.
5. Select the orientation of the original for the **Original Orientation** setting, and then press the OK button.
6. Check other print setting items, change them if necessary, and then press the OK button.
7. Press the ◊ button.

---

## Menu Options for Copying

**Note:**

*Available menus vary depending on the layout you selected.*

**The number of copies:**

Enter the number of copies.

**B&W:**

Copies the original in black and white (monochrome).

**Color:**

Copies the original in color.

**Density:**

Increase the level of density when the copying results are faint. Decrease the level of density when ink smears.

**Paper Size:**

Select the paper size you loaded.

**Paper Type:**

Select the paper type you loaded.

**Reduce/Enlarge:**

Enlarges or reduces the originals.

Actual Size

Copies at 100 % magnification.

## Copying

### Auto Fit

Detects the scan area and automatically enlarges or reduces the original to fit to the paper size you selected. When there are white margins around the original, the white margins from the corner mark of the scanner glass are detected as the scan area, but the margins at the opposite side may be cropped.

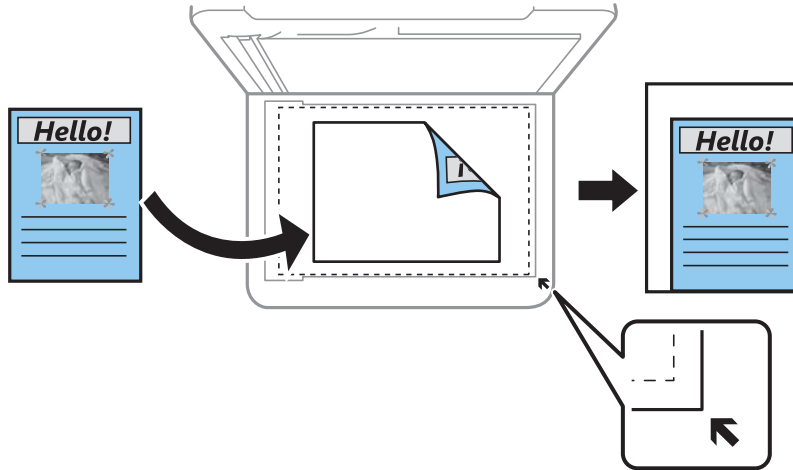

### Custom

Select to specify the magnification to enlarge or reduce the original.

#### Custom Size:

Specifies the magnification used to enlarge or reduce the original within a range of 25 to 400%.

#### Original Size:

Select the size of your original. When copying non-standard size originals, select the size closest to your original.

#### Multi-Page:

##### Single Page

Copies a single-sided original onto a single sheet.

##### 2-up

Copies two single-sided originals onto a single sheet in 2-up layout. Select the layout order and the orientation of your original.

#### Quality:

Select the print quality. **Draft** provides faster printing, but the printouts may be faint. **Best** provides higher quality printing, but the printing speed may be slower.

#### ID Card Copy:

Scans both sides of an ID card and copies onto one side of A4 size paper.

#### Borderless Copy:

Copies without margins around the edges. The image is enlarged a little to remove margins from the edges of the paper. Select how much to enlarge in the **Expansion** setting.

# Scanning

## Scanning Using the Control Panel

You can send scanned images from the printer's control panel to the following destinations.

To Computer (JPEG)/To Computer (PDF)/To Computer (Email)/To Computer (Custom)

You can save the scanned image to a computer connected to the printer. Before scanning, install Epson Scan 2 and Epson Event Manager on your computer.

To Computer (WSD)

You can save the scanned image to a computer connected to the printer, using WSD feature. If you are using the Windows 7/Windows Vista, you need to make WSD settings on your computer before scanning.

### Related Information

- ➔ [“Scanning to a Computer” on page 110](#)
- ➔ [“Scanning to a Computer \(WSD\)” on page 114](#)

## Scanning to a Computer

### Note:

Before scanning, install Epson Scan 2 and Epson Event Manager on your computer.

1. Place the originals.
2. Select **Scan** on the home screen.

To select an item, use the ▲ ▼ ◀ ▶ buttons, and then press the OK button.

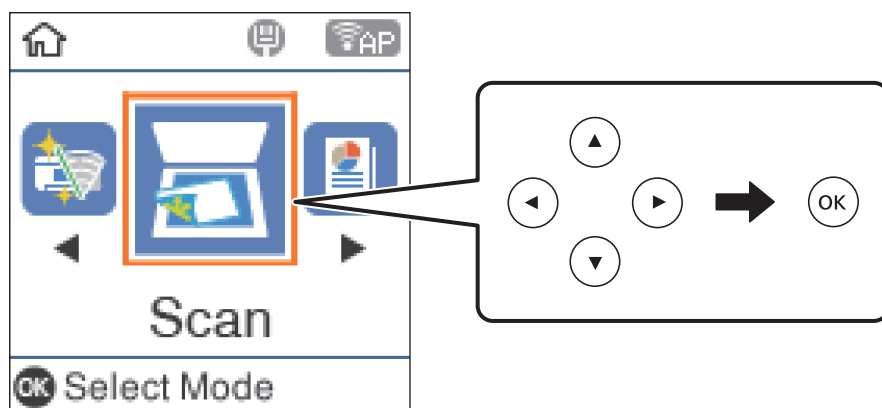

3. Select how to save the scanned image to a computer from the following menus, and then press the OK button.
  - To Computer (JPEG):** Saves the scanned image in JPEG format.
  - To Computer (PDF):** Saves the scanned image in PDF format.

## Scanning

- ❑ **To Computer (Email):** Starts the email client on your computer, and then automatically attaches it to an email.
- ❑ **To Computer (Custom):** Saves the scanned image using the settings on the Epson Event Manager. You can change the scan settings such as the scanning size, folder to save to, or save format.

4. Select the computer to which you want to save the scanned images.

**Note:**

- ❑ *You can change the scan settings such as the scanning size, folder to save, or save format, by using Epson Event Manager.*
- ❑ *When the printer is connected to a network, you can select the computer to which you want to save the scanned image. You can display up to 20 computers on the printer's control panel. If you set **Network Scan Name (Alphanumeric)** on Epson Event Manager, it is displayed on the control panel.*

5. Press the  button.

### Related Information

➔ [“Placing Originals” on page 51](#)

## Making Custom Settings in Epson Event Manager

You can set the scan settings for **To Computer (Custom)** in Epson Event Manager.

See the Epson Event Manager help for details.

1. Start Epson Event Manager.
2. Make sure that your scanner is selected as the **Scanner** on the **Button Settings** tab on the main screen.

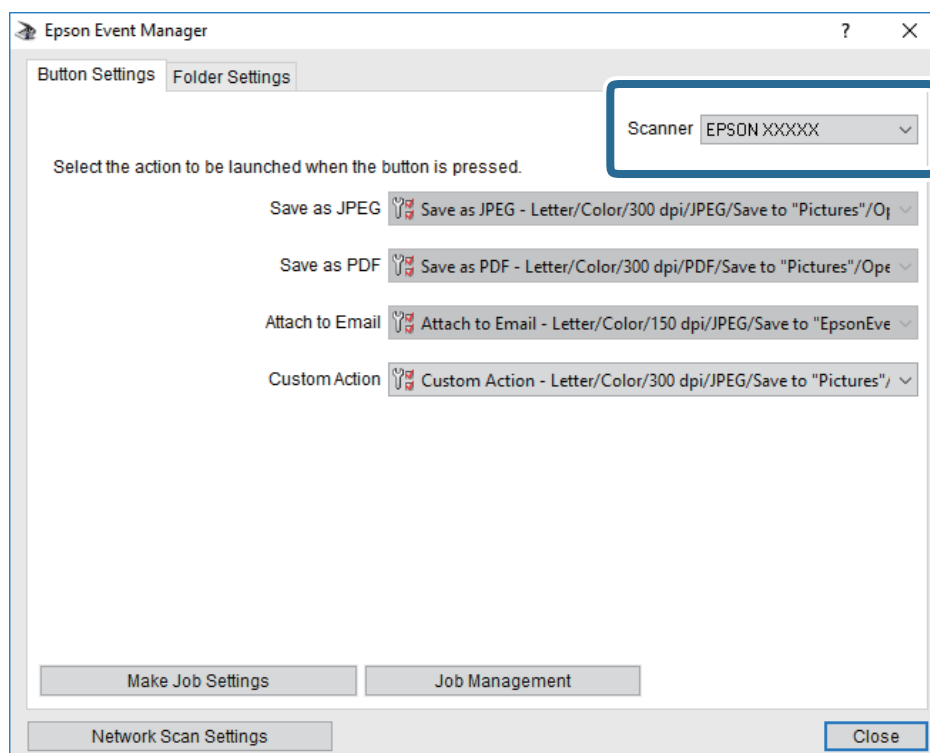

## Scanning

3. Click **Make Job Settings**.

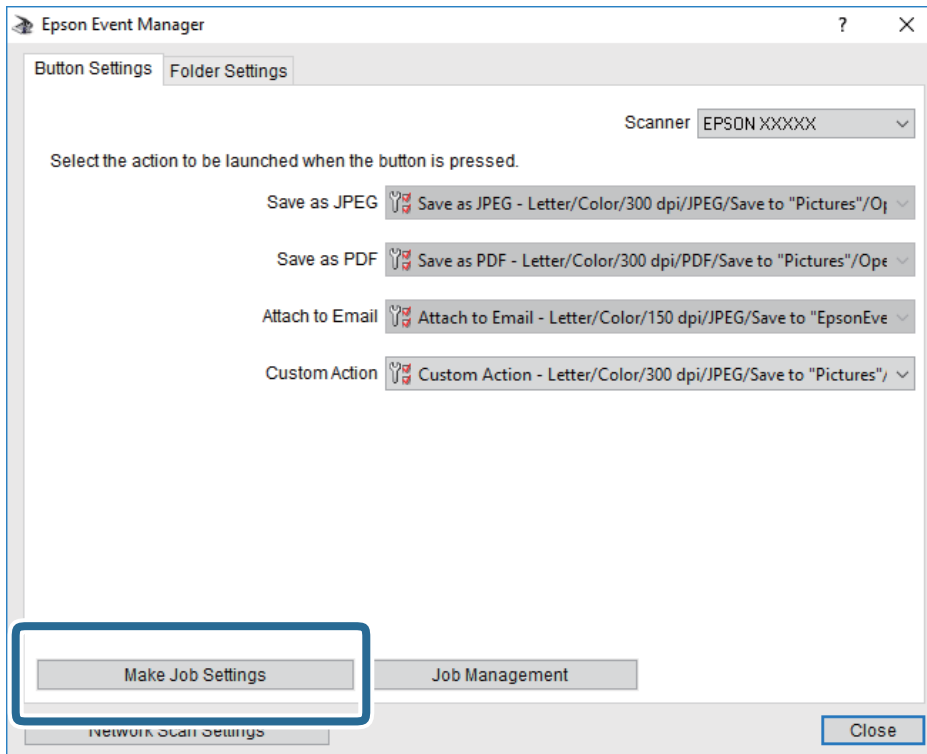



## Scanning

4. Make scan settings on the **Job Settings** screen.

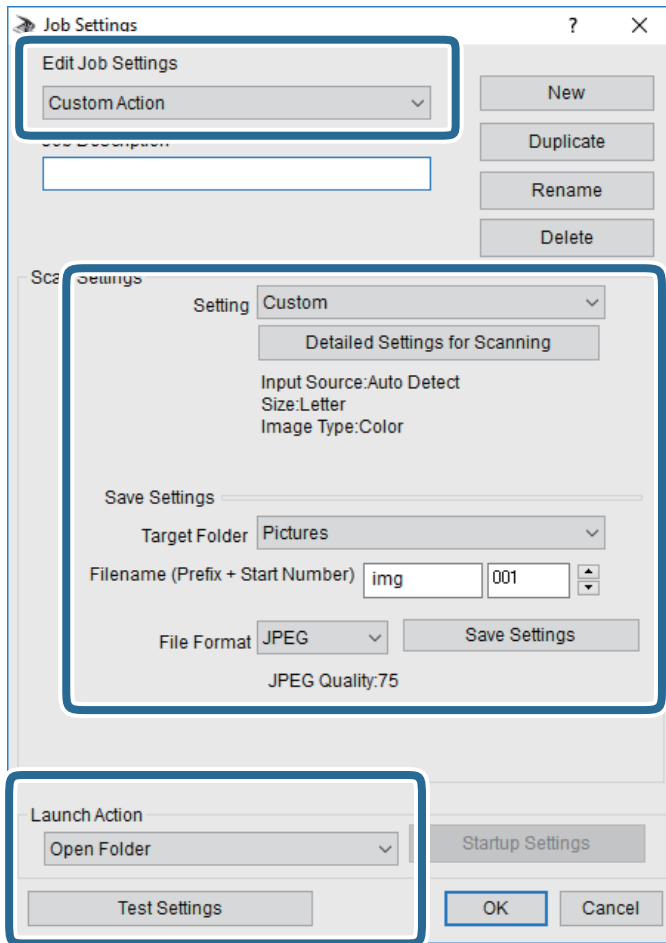

- Edit Job Settings: Select **Custom Action**.
- Setting: Scan using the best settings for the selected type of original. Click **Detailed Settings for Scanning** to set the items such as the resolution or the color for saving the scanned image.
- Target Folder: Select the save folder for the scanned image.
- Filename (Prefix + Start Number): Change the settings for the file name you want to save.
- File Format: Select the save format.
- Launch Action: Select the action when scanning.
- Test Settings: Starts test scanning using current settings.

5. Click **OK** to return to the main screen.

## Scanning

6. Make sure that the **Custom Action** is selected on the **Custom Action** list.

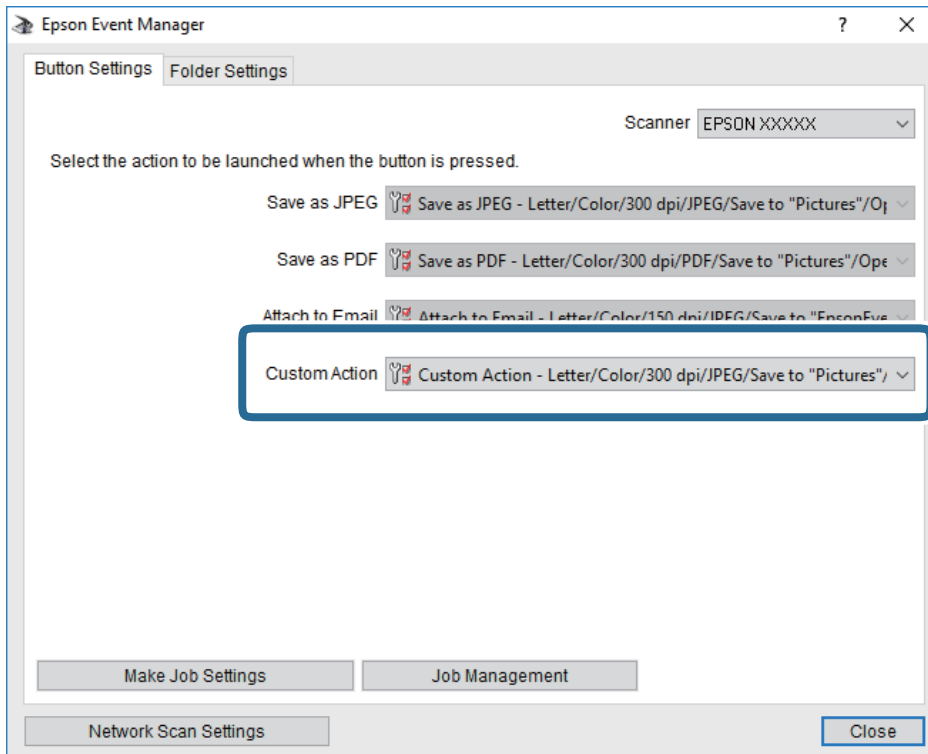

7. Click **Close** to close Epson Event Manager.

## Scanning to a Computer (WSD)

**Note:**

- ❑ This feature is only available for computers running Windows 10/Windows 8.1/Windows 8/Windows 7/Windows Vista.
- ❑ If you are using Windows 7/Windows Vista, you need to setup your computer in advance using this feature.

1. Place the originals.
2. Select **Scan** on the home screen.

To select an item, use the ▲ ▼ ◀ ▶ buttons, and then press the OK button.

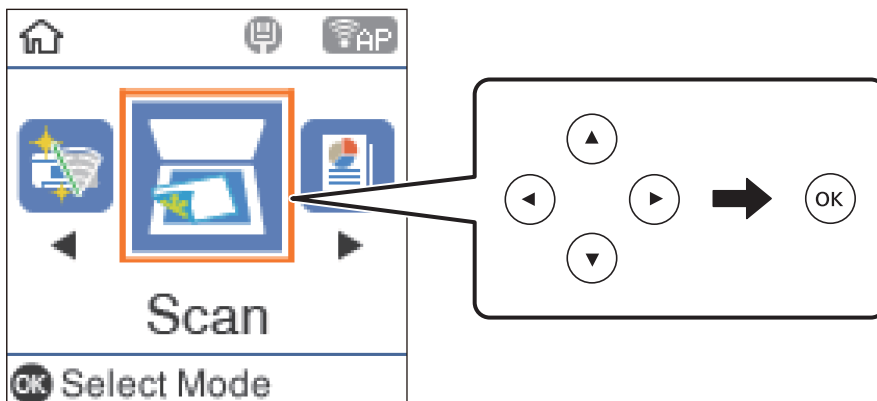

## Scanning

3. Select **To Computer (WSD)**.
4. Select a computer.
5. Press the  button.

## Setting Up a WSD Port

This section explains how to set up a WSD port for Windows 7/Windows Vista.

**Note:**

For Windows 10/Windows 8.1/Windows 8, the WSD port is set up automatically.

The following is necessary to set up a WSD port.

- The printer and the computer are connected to the network.
- The printer driver is installed on the computer.

1. Turn the printer on.
2. Click start, and then click **Network** on the computer.
3. Right-click the printer, and then click **Install**.  
Click **Continue** when the **User Account Control** screen is displayed.  
Click **Uninstall** and start again if the **Uninstall** screen is displayed.

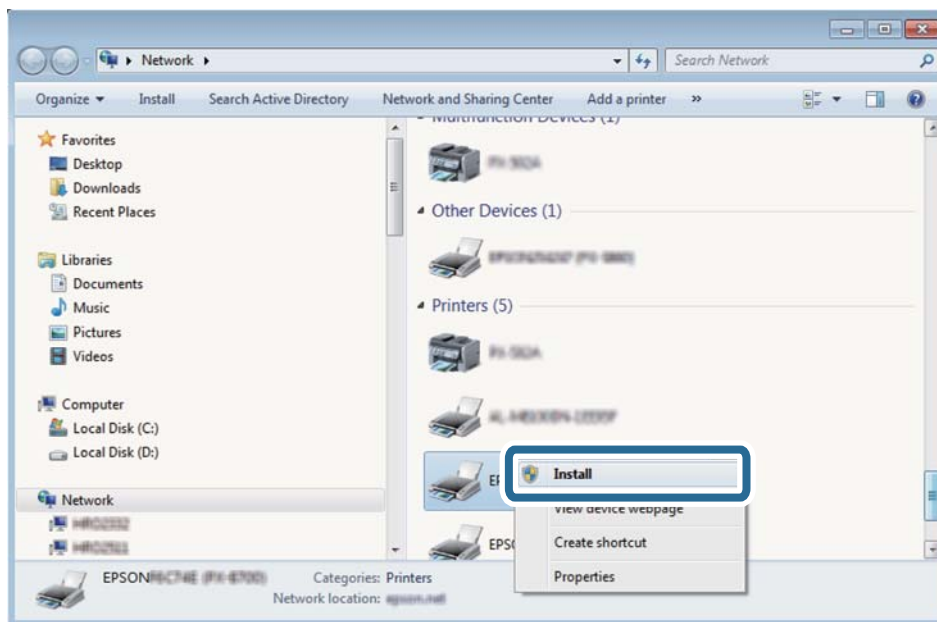

**Note:**

The printer name you set on the network and model name (EPSON XXXXXX (XX-XXXX)) are displayed on the network screen. You can check the printer's name set on the network from the printer's control panel or by printing a network status sheet.

## Scanning

4. Click **Your device is ready to use**.

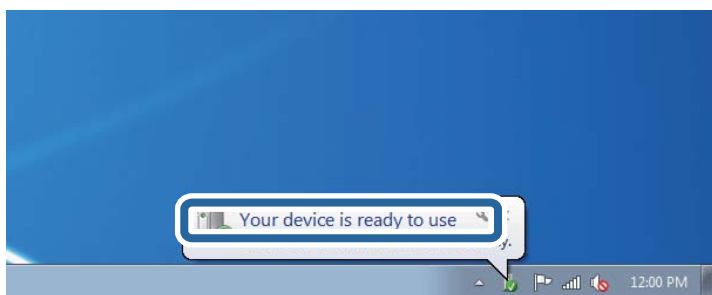

5. Check the message, and then click **Close**.

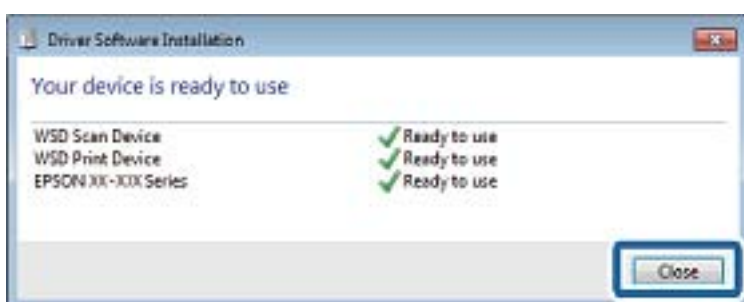

6. Open the **Devices and Printers** screen.

- Windows 7

Click start > **Control Panel** > **Hardware and Sound** (or **Hardware**) > **Devices and Printers**.

- Windows Vista

Click start > **Control Panel** > **Hardware and Sound** > **Printers**.

7. Check that an icon with the printer's name on the network is displayed.

Select the printer name when using with WSD.

---

## Scanning from a Computer

### Scanning Using Epson Scan 2

You can scan using the scanner driver "Epson Scan 2". You can scan originals using detailed settings that are suitable for text documents.

See the Epson Scan 2 help for an explanation of each setting item.

1. Place the original.

**Note:**

*If you want to scan multiple originals, place them in the ADF.*

2. Start Epson Scan 2.

## Scanning

3. Make the following settings on the **Main Settings** tab.

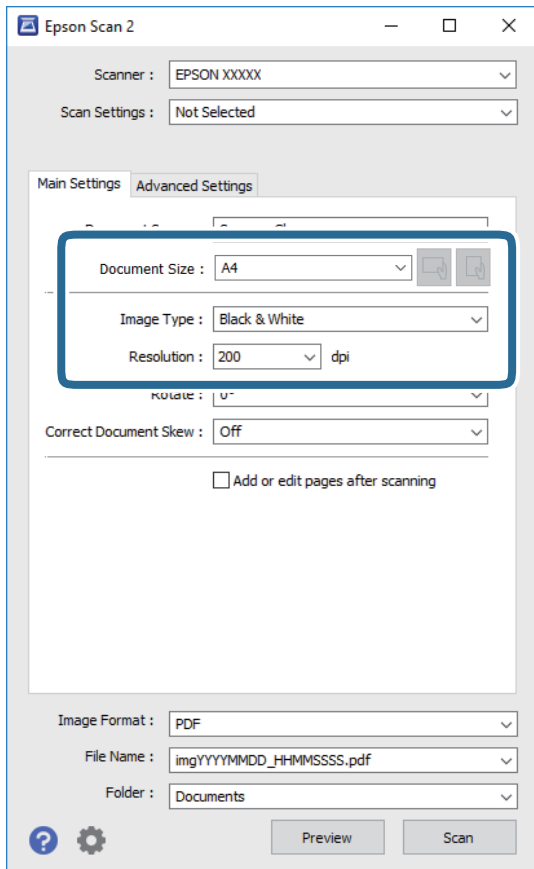

- Document Source: Select the source where the original is placed.
- Document Size: Select the size of the original you placed.
-  (Original orientation) buttons: Select the set orientation of the original you placed. Depending on the size of the original, this item may be set automatically and cannot be changed.
- Image Type: Select the color for saving the scanned image.
- Resolution: Select the resolution.

4. Make other scan settings if necessary.

- You can preview the scanned image by clicking the **Preview** button. The preview window opens, and the previewed image is displayed.  
When you preview using the ADF, the original is ejected from the ADF. Place the ejected original again.

## Scanning

- ❑ On the **Advanced Settings** tab, you can make detailed image adjustment settings that are suitable for text documents, such as the following.
  - ❑ Remove Background: Remove the background of the originals.
  - ❑ Text Enhancement: You can make blurred letters in the original clear and sharp.
  - ❑ Auto Area Segmentation: You can make letters clear and images smooth when performing black and white scanning for a document that contains images.
  - ❑ Color Enhance: You can enhance the color specified for the scanned image, and then save it in grayscale or black and white.
  - ❑ Threshold: You can adjust the border for monochrome binary (black and white).
  - ❑ Unsharp Mask: You can enhance and sharpen the outlines of the image.
  - ❑ Descreening: You can remove moiré patterns (web-like shadows) that appear when scanning printed papers such as a magazine.
  - ❑ Edge Fill: You can remove the shadow created around the scanned image.
  - ❑ Dual Image Output (Windows Only): You can scan once and save two images with different output settings at the same time.

**Note:**

*The items may not be available depending on other settings you made.*

5. Set the file saving settings.

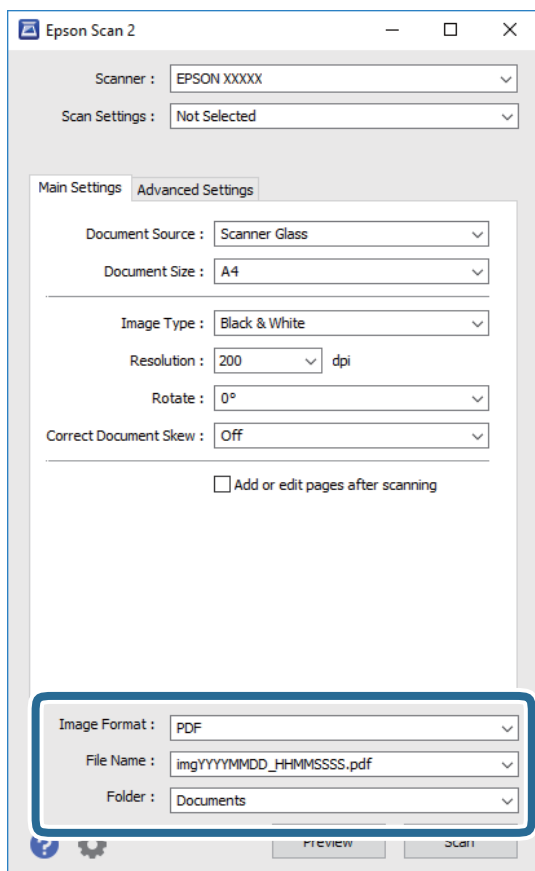

## Scanning

- Image Format:** Select the save format from the list.

You can make detailed settings for each save format except BITMAP and PNG. Select **Options** from the list after selecting the save format.

- File Name:** Confirm the save file name displayed.

You can change settings for the file name by selecting **Settings** from the list.

- Folder:** Select the save folder for the scanned image from the list.

You can select another folder or create a new folder by selecting **Select** from the list.

- Click **Scan**.

### Related Information

➔ [“Placing Originals” on page 51](#)

---

## Scanning from Smart Devices

Epson iPrint is an application that allows you to scan photos and documents from a smart device, such as a smartphone or tablet, that is connected to the same wireless network as your printer. You can save the scanned data on a smart device or to Cloud services, send it by email, or print it.

If you start Epson iPrint when the printer is not connected to the network, a message is displayed instructing you to connect to the printer. Follow the instructions to complete the connection. See the URL below for the operating conditions.

<http://epson.sn>



## Installing Epson iPrint

You can install Epson iPrint on your smart device from the following URL or QR code.

<http://ipr.to/c>



## Scanning Using Epson iPrint

Start Epson iPrint from your smart device and select the item you want to use from the home screen.

## Scanning

The following screens are subject to change without notice.

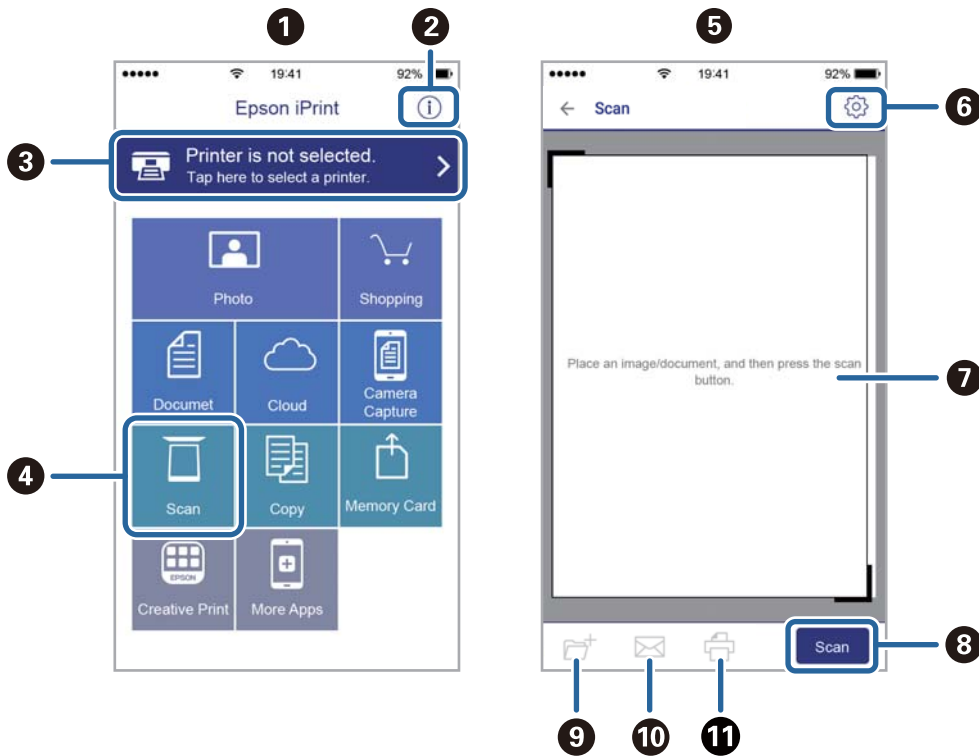

1	Home screen displayed when the application is started.
2	Displays information on how to setup the printer and a FAQ.
3	Displays the screen where you can select the printer and make printer settings. Once you have selected the printer, you do not need to select it again from the next time.
4	Displays the scanning screen.
5	The scanning screen displayed when the scan menu is selected.
6	Displays the screen where you can make scan settings such as resolution.
7	Displays scanned images.
8	Starts scanning.
9	Displays the screen where you can save scanned data to a smart device or Cloud services.
10	Displays the screen where you can send scanned data by email.
11	Displays the screen where you can print scanned data.



# Faxing

---

## Before Using Fax Features

Check the following before you start using the fax features.

- The printer and the phone line, and (if necessary) the phone machine are connected correctly
- Fax basic settings (Fax Setting Wizard) is complete
- Other necessary Fax Settings are complete

See "Related Information" below to make settings.

### Related Information

- ➔ ["Fax Settings" on page 65](#)

---

## Sending Faxes Using the Printer

### Sending Faxes Using the Control Panel

#### Related Information

- ➔ ["Sending Faxes Automatically Using the Control Panel" on page 121](#)

### Sending Faxes Automatically Using the Control Panel

You can send faxes by entering fax numbers for recipients on the control panel.

1. Place the originals.

You can send up to 100 pages in one transmission; however depending on the remaining amount of memory, you may not be able to send faxes even with less than 100 pages.

## Faxing

2. Select **Fax** on the home screen.

To select an item, use the ▲ ▼ ◀ ▶ buttons, and then press the OK button.

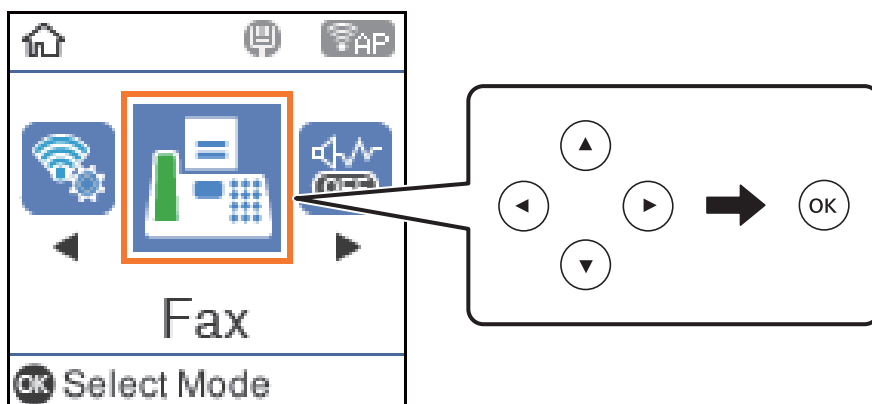

3. Specify the recipient.

You can send the same monochrome fax to up to 100 recipients. However, a color fax can only be sent to one recipient at a time.

- ❑ To enter manually: Press the fax number with the number buttons, and then press the OK button.

- To add a pause (pause for three seconds during dialing), press the ▼ button.

- If you have set an external access code in **Line Type**, enter "#" (hash) instead of the actual external access code at the beginning of the fax number.

Note:

If you cannot manually enter a fax number, **Direct Dialing Restrictions** in **Security Settings** is set to **On**. Select fax recipients from the contacts list or the sent fax history.

- ❑ To select from the contacts list: Press the ▲ button and select the recipients you want to send to. If the recipient you want to send to has not been registered in **Contacts**, register it from **Contacts Manager**.

**Fax > Menu > Contacts Manager**

- ❑ To select from sent fax history: Press the ▼ button, and then select a recipient.

**Note:**

To delete recipients you have entered, press the ▶ button on the **Fax** screen, select the recipient, and then press the OK button. Press the ↶ button to finish and return to the **Fax** screen.

4. Press the OK button, and then select **Scan Settings** or **Fax Send Settings** to make settings such as the resolution and the sending method if necessary.

5. Press the ↶ button until return to **Fax** screen, and then press the ⬠ button.

6. When sending is complete, remove the originals.

**Note:**

- ❑ If the fax number is busy or there is some problem, the printer automatically redials after one minute.

- ❑ To cancel sending, press the ⓧ button.

- ❑ It takes longer to send a fax in color because the printer performs scanning and sending simultaneously. While the printer is sending a fax in color, you cannot use the other features.

## Faxing

### Related Information

- ➔ [“Managing Contacts” on page 55](#)
- ➔ [“Placing Originals” on page 51](#)
- ➔ [“Menu Options for Faxing” on page 128](#)

## Sending Faxes Dialing from the External Phone Device

You can send a fax by dialing using the connected telephone when you want to talk over the phone before sending a fax, or when the recipient's fax machine does not switch to the fax automatically.

1. Place the originals.  
You can send up to 100 pages in one transmission.
2. Pick up the handset of the connected telephone, and then dial the recipient's fax number using the phone.

**Note:**

*When the recipient answers the phone, you can talk with the recipient.*

3. Select **Fax** on the home screen.  
To select an item, use the ▲ ▼ ◀ ▶ buttons, and then press the OK button.
4. Press the OK button, and then select **Scan Settings** or **Fax Send Settings** to make settings such as the resolution and the sending method if necessary.
5. When you hear a fax tone, press the ◊ button, and then hang up the handset.

**Note:**

*When a number is dialed using the connected telephone, it takes longer to send a fax because the printer performs scanning and sending simultaneously. While sending the fax, you cannot use the other features.*

6. When sending is complete, remove the originals.

### Related Information

- ➔ [“Placing Originals” on page 51](#)
- ➔ [“Fax Send Settings” on page 129](#)

## Various Ways of Sending Faxes

### Related Information

- ➔ [“Sending Many Pages of a Monochrome Document \(Direct Send\)” on page 124](#)
- ➔ [“Sending Faxes in Monochrome at a Specified Time \(Send Fax Later\)” on page 124](#)
- ➔ [“Sending Different Size Documents Using ADF \(ADF Continuous Scan\)” on page 125](#)

## Faxing

### Sending Many Pages of a Monochrome Document (Direct Send)

When sending a fax in monochrome, the scanned document is temporarily stored in the printer's memory. Therefore, sending a lot of pages may cause the printer to run out of memory and stop sending the fax. You can avoid this by enabling the **Direct Send** feature, however, it takes longer to send the fax because the printer performs scanning and sending simultaneously. You can use this feature when there is only one recipient.

1. Place the originals.

2. Select **Fax** on the home screen.

To select an item, use the ▲ ▼ ◀ ▶ buttons, and then press the OK button.

3. Specify the recipient.

4. Press the OK button, and then select **Fax Send Settings**.

5. Select **Direct Send**, and then select **On**.

You can also make settings such as the resolution and the sending method in **Scan Settings** or **Fax Send Settings** if necessary.

6. Press the ↶ button until return to **Fax** screen, and then press the ⬠ button.

7. When sending is complete, remove the originals.

#### Related Information

➔ [“Placing Originals” on page 51](#)

➔ [“Sending Faxes Automatically Using the Control Panel” on page 121](#)

➔ [“Fax Send Settings” on page 129](#)

### Sending Faxes in Monochrome at a Specified Time (Send Fax Later)

You can set to send a fax at a specified time. Only monochrome faxes can be sent when the time to send is specified.

1. Place the originals.

2. Select **Fax** on the home screen.

To select an item, use the ▲ ▼ ◀ ▶ buttons, and then press the OK button.

3. Specify the recipient.

4. Make settings to send faxes at a specified time.



❶ Press the OK button, and then select **Fax Send Settings**.

❷ Select **Send Fax Later**, and then select **On**.

❸ Enter the time you want to send the fax, and then press the OK button.

You can also make settings such as the resolution and the sending method in **Scan Settings** or **Fax Send Settings** if necessary.

## Faxing

5. Press the  button until return to **Fax** screen, and then press the  button.
6. When sending is complete, remove the originals.

**Note:**

You can cancel faxing from the **Fax** screen.

### Related Information





- ➔ [“Placing Originals” on page 51](#)
- ➔ [“Sending Faxes Automatically Using the Control Panel” on page 121](#)
- ➔ [“Fax Send Settings” on page 129](#)

## Sending Different Size Documents Using ADF (ADF Continuous Scan)

Sending faxes by placing originals one by one, or by placing originals by size, you can send them as one document at their original sizes.





If you place different sized originals in the ADF, all of the originals are sent at the largest size among them. To send originals at their original sizes, do not place originals with mixed sizes.

1. Place the first batch of originals at the same size.
2. Select **Fax** on the home screen.

To select an item, use the     buttons, and then press the OK button.

3. Specify the recipient.
4. Press the OK button, and then select **Scan Settings**.
5. Select **ADF Continuous Scan**, and then select **On**.

You can also make settings such as the resolution and the sending method in **Scan Settings** or **Fax Send Settings** if necessary.

6. Press the  button until return to **Fax** screen, and then press the  button.
7. When scanning the first originals is complete and the message **Send another page?** is displayed on the control panel, select **Yes**, load the next originals, and then press the  button. If you want to change the document size, press the  button and select the document size you want to send.

**Note:**

If you leave the printer untouched for 20 seconds after prompted to set the next originals, the printer stops storing and starts sending the document.

8. When sending is complete, remove the originals.

### Related Information

- ➔ [“Placing Originals” on page 51](#)
- ➔ [“Sending Faxes Automatically Using the Control Panel” on page 121](#)
- ➔ [“Fax Send Settings” on page 129](#)

---

## Receiving Faxes on the Printer

If the printer is connected to the phone line and basic settings have been completed using the Fax Setting Wizard, you can receive faxes.

There are two ways of receiving faxes.

- Receiving an incoming fax
- Receiving a fax by making a call (Polling Receive)

Received faxes are printed in the printer's initial settings.

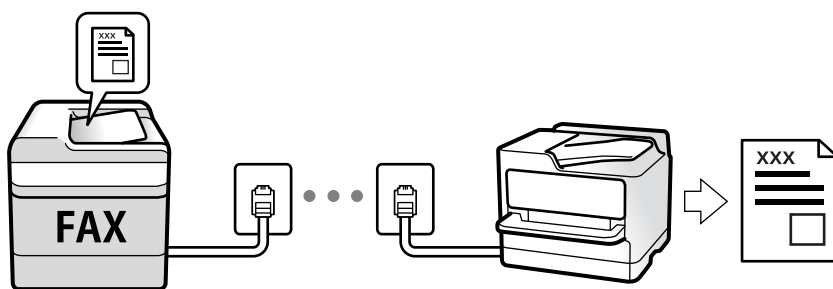

To check the status of the fax settings, you can print a **Fax Settings List** by selecting **Fax > Menu > More > Fax Report > Fax Settings List**.

See "Related Information" below to make settings.

### Related Information

➔ [“Making Settings Individually for Printer's Fax Features” on page 70](#)

## Receiving Incoming Faxes

There are two options in **Receive Mode**.

### Related Information

➔ [“Usage of Auto Mode” on page 126](#)

➔ [“Usage of Manual Mode” on page 127](#)

## Usage of Auto Mode

This mode allows you to use the line for the following uses.

- Using the line for faxing only (external telephone is not necessary)
- Using the line for faxing mainly, and sometimes phoning

### Receiving Faxes Without an External Phone Device

The printer automatically switches to receive faxes when the number of rings you set in **Rings to Answer** is complete.

## Faxing

### Receiving Faxes With an External Phone Device

A printer with an external phone device works as follows.

- ❑ When the answering machine answers within the number of rings set in **Rings to Answer**:
  - If the ringing is for a fax: The printer automatically switches to receive faxes.
  - If the ringing is for a voice call; The answering machine can receive voice calls and record voice messages.
- ❑ When you pick up the handset within the number of rings set in **Rings to Answer**:
  - If the ringing is for a fax: You can receive the fax using the same steps as for **Manual**. Select **Fax** on the printer's home screen, press the # button to select receiving a fax, and then press the . Next hang up the handset.
  - If the ringing is for a voice call: You can answer the phone as normal.
- ❑ When the ringing stops and the printer automatically switches to receive faxes:
  - If the ringing is for a fax: The printer starts receiving faxes.
  - If the ringing is for a voice call: You cannot answer the phone. Ask the person to call you back.

**Note:**

Set the number of rings to answer for the answering machine to a lower number than the number set in **Rings to Answer**. Otherwise, the answering machine cannot receive voice calls to record voice messages. For details on setting up the answering machine, see the manual supplied with the answering machine.

### Related Information

➔ [“Usage of Manual Mode” on page 127](#)

## Usage of Manual Mode

This mode is mainly for making phone calls, but is also for faxing.

### Receiving Faxes

When the telephone rings, you can answer the ringing manually by picking up the handset.

- ❑ When you hear a fax signal (baud):
  - Select **Fax** on the printer's home screen, press the # button to select receiving a fax, and then press the . Next, hang up the handset.
- ❑ If the ringing is for a voice call:
  - You can answer the phone as normal.

### Receiving Faxes Using only the Connected Telephone

When **Remote Receive** is set, you can receive faxes by simply entering the start code.

When the telephone rings, pick up the handset. When you hear a fax tone (baud), dial the two digit start code, and then hang up the handset.

## Receiving Faxes by Making a Phone Call

You can receive a fax stored on another fax machine by dialing the fax number.

**Related Information**

➔ [“Receiving Faxes by Polling \(Polling Receive\)” on page 128](#)

**Receiving Faxes by Polling (Polling Receive)**

You can receive a fax stored on another fax machine by dialing the fax number. Use this feature to receive a document from a fax information service.

**Note:**

- ❑ *If the fax information service has an audio guidance feature that you need to follow to receive a document, you cannot use this feature.*
- ❑ *To receive a document from a fax information service that uses audio guidance, just dial the fax number using the connected telephone, and operate the phone and the printer following the audio guidance.*

1. Select **Fax** on the home screen.

To select an item, use the ▲ ▼ ◀ ▶ buttons, and then press the OK button.

2. Press the OK button, and then select **More**.

3. Select **Polling Receive**, and then select **On**.

4. Specify the recipient.

**Note:**

*If you cannot manually enter a fax number, **Direct Dialing Restrictions** in **Security Settings** is set to **On**. Select fax recipients from the contacts list or the sent fax history.*

5. Press the ◊ button to start **Polling Receive**.

**Related Information**

➔ [“Sending Faxes Dialing from the External Phone Device” on page 123](#)

➔ [“More” on page 130](#)

---

**Menu Options for Faxing****Fax**

Select the menus in **Fax** from home screen on the control panel.

Contacts	Select a recipient from the contacts list.
Recent	Select a recipient from the sent fax history.



## Faxing

Menu	<p>You can select the following menus.</p> <ul style="list-style-type: none"> <li><input type="checkbox"/> Scan Settings</li> <li><input type="checkbox"/> Fax Send Settings</li> <li><input type="checkbox"/> More</li> <li><input type="checkbox"/> Contacts Manager</li> </ul> <p>See "Related Information" below for more details.</p>
Send Fax	Press the  button to send the fax.



### Related Information

- ➔ ["Scan Settings" on page 129](#)
- ➔ ["Fax Send Settings" on page 129](#)
- ➔ ["More" on page 130](#)
- ➔ ["Contacts Manager" on page 131](#)

## Scan Settings

Select the menus on the control panel as described below:

### Fax > Menu > Scan Settings

Resolution	Select the resolution of the outgoing fax. If you select <b>Fine</b> or <b>Photo</b> , the data size becomes larger and it takes time to send the fax.
Density	Sets the density of the outgoing fax. Press  to make the density darker, and press  to make it lighter.
ADF Continuous Scan	Sending faxes by placing originals one by one, or by placing originals by size, you can send them as one document at their original sizes. See "Related Information" below on this topic.
Original Size (Glass)	Select the size and orientation of the original you placed on the scanner glass.
Color Mode	Select whether to scan in color or in monochrome.

### Related Information

- ➔ ["Sending Different Size Documents Using ADF \(ADF Continuous Scan\)" on page 125](#)

## Fax Send Settings

Select the menus on the control panel as described below:

### Fax > Menu > Fax Send Settings

## Faxing

Direct Send	<p>Sends a monochrome fax while scanning the originals. Since scanned originals are not stored temporarily in the printer's memory even when sending a large volume of pages, you can avoid printer errors due to a lack of memory. Note that sending using this feature takes longer than not using this feature. See "Related Information" below on this topic.</p> <p>You cannot use this feature when you send a fax to multiple recipients.</p>
Send Fax Later	<p>Sends a fax at a time you specified. Only a monochrome fax is available when using this option. See "Related Information" below on this topic.</p>
Add Sender Info	<p>Select the position where you want to include the header information (sender name and fax number) in the outgoing fax, or not to include the information.</p> <p><input type="checkbox"/> <b>Off:</b> Sends a fax with no header information.</p> <p><input type="checkbox"/> <b>Outside of Image:</b> Sends a fax with header information in the top white margin of the fax. This keeps the header from overlapping with the scanned image, however, the fax received by the recipient may be printed across two sheets depending on the size of the originals.</p> <p><input type="checkbox"/> <b>Inside of Image:</b> Sends a fax with header information approximately 7 mm lower than the top of the scanned image. The header may overlap with the image, however, the fax received by the recipient will not be split into two documents.</p>
Fax Header	<p>Select the header for the recipient. To use this feature, you should register multiple headers in advance.</p>
Additional Header Info	<p>Select the information you want to add. You can select one from <b>Your Phone Number</b> and <b>Destination List</b>.</p>
Transmission Report	<p>Prints a transmission report after you send the fax.</p> <p><b>Print on Error</b> prints a report only when an error occurs.</p>

### Related Information

- ➔ ["Sending Many Pages of a Monochrome Document \(Direct Send\)" on page 124](#)
- ➔ ["Sending Faxes in Monochrome at a Specified Time \(Send Fax Later\)" on page 124](#)

## More

Select the menus on the control panel as described below:

### Fax > Menu > More

Transmission Log	<p>You can check the history of sent or received fax jobs.</p>
Fax Report	<p><input type="checkbox"/> Last Transmission Prints a report for the previous fax that was sent or received through polling.</p> <p><input type="checkbox"/> Fax Log Prints a transmission report. You can set to print this report automatically using the following menu. <b>Settings &gt; Fax Settings &gt; Report Settings &gt; Fax Log Auto Print</b></p> <p><input type="checkbox"/> Fax Settings List Prints the current fax settings.</p> <p><input type="checkbox"/> Protocol Trace Prints a detailed report for the previous fax that was sent or received.</p>

## Faxing

Reprint Faxes	You can reprint the received fax.
Polling Receive	When this is set to <b>On</b> and you call the sender's fax number, you can receive documents from the sender's fax machine. See "Related information" below on this topic for details on how to receive faxes using <b>Polling Receive</b> .  When you leave the Fax menu, the setting returns to <b>Off</b> (default).
Fax Settings	Accesses <b>Settings &gt; Fax Settings</b> .

### Related Information

➔ [“Receiving Faxes by Polling \(Polling Receive\)” on page 128](#)

## Contacts Manager

Select the menus on the control panel as described below:

**Fax > Menu > Contacts Manager**

Accesses **Settings > Contacts Manager**.

You can add or edit your contacts.

### Related Information

➔ [“Menu Options for Contacts Manager” on page 62](#)

➔ [“Managing Contacts” on page 55](#)

---

## Sending a Fax from a Computer

You can send faxes from the computer by using the FAX Utility and PC-FAX driver.

### Note:

To install the FAX Utility, use the EPSON Software Updater. See Related Information below for details. For Windows users, you can install using the software disc supplied with the printer.

### Related Information

➔ [“Software Update Tools \(EPSON Software Updater\)” on page 161](#)

➔ [“Installing the Latest Applications” on page 162](#)

## Sending Documents Created Using an Application (Windows)

By selecting a printer fax from the **Print** menu of an application like Microsoft Word or Excel, you can directly transmit data such as documents, drawings, and tables you have created, with a cover sheet.

### Note:

The following explanation uses Microsoft Word as an example. The actual operation may differ depending on the application you use. For details, see the application's help.

1. Using an application, create a document to transmit by fax.

## Faxing

2. Click **Print** from the **File** menu.

The application's **Print** window appears.

3. Select **XXXXXX (FAX)** (where XXXXXX is your printer name) in **Printer**, and then check the settings for fax sending.

- Specify **1** in **Number of copies**. Fax may not be transmitted correctly if you specify **2** or more.
- You cannot use functions such as **Print to File** that change the output port.
- You may transmit up to 100 pages including cover sheet in one fax transmission.

4. Click **Printer Properties** or **Properties** if you want to specify **Paper Size, Orientation, Color, Image Quality, or Character Density**.

For details, see the PC-FAX driver help.

5. Click **Print**.

**Note:**

*When Using FAX Utility for the first time, a window for registering your information is displayed. Enter the necessary information, and then click **OK**. FAX Utility uses **Nickname** to manage fax jobs internally. Other information is automatically added to the cover sheet.*

**Recipient Settings** screen of FAX Utility is displayed.

6. Specify a recipient and click **Next**.

- Selecting a recipient (name, fax number and so on) from **PC-FAX Phone Book**:

If the recipient is saved in the phone book, do the steps below.

- ① Click the **PC-FAX Phone Book** tab.
- ② Select the recipient from the list and click **Add**.

- Selecting a recipient (name, fax number and so on) from the contacts on the printer:

If the recipient is saved in the contacts on the printer, do the steps below.

- ① Click the **Contacts on Printer** tab.
- ② Select contacts from the list and click **Add** to proceed to **Add to Recipient** window.
- ③ Select the contacts from the list displayed, and then click **Edit**.
- ④ Add the personal data such as **Company/Corp.** and **Title** as necessary, and then click **OK** to return to the **Add to Recipient** window.
- ⑤ As necessary, select the checkbox of **Register in the PC-FAX Phone Book** to save the contacts to **PC-FAX Phone Book**.
- ⑥ Click **OK**.

## Faxing

- Specifying a recipient (name, fax number and so on) directly:

Do the steps below.

- ① Click the **Manual Dial** tab.
- ② Enter the necessary information.
- ③ Click **Add**.

Furthermore, by clicking **Save to Phone Book**, you can save the recipient in the list under the **PC-FAX Phone Book** tab.

**Note:**

- If your printer's *Line Type* is set to **PBX** and the access code has been set to use # (hash) instead of entering the exact prefix code, enter # (hash). For details, see *Line Type in Basic Settings* from related information link below.
- If you have selected **Enter fax number twice** in the **Option settings** on the FAX Utility main screen, you need to enter the same number again when you click **Add** or **Next**.

The recipient is added to the **Recipient List** displayed in the upper part of the window.

7. Specify the content of the cover sheet.

① To attach a cover sheet, select one of the samples from **Cover Sheet**. Enter the **Subject** and **Message**. Note that there is no function to create an original cover sheet or to add an original cover sheet to the list.

If you do not want to attach a cover sheet, select **No cover sheet** from **Cover Sheet**.

② Click **Cover Sheet Formatting** if you want to change the order of the items on the cover sheet. You can select the cover sheet size in **Paper Size**. You can also select a cover sheet at a different size to the document being transmitted.

③ Click **Font** if you want to change the font or font size used for the text on the cover sheet.

④ Click **Sender Settings** if you want to change the sender information.

⑤ Click **Detailed Preview** if you want to check the cover sheet with the subject and the message you entered.

⑥ Click **Next**.

8. Check the transmission content and click **Send**.

Make sure the name and fax number of the recipient are correct before transmitting. Click **Preview** to preview the cover sheet and document to transmit.

Once transmission starts, a window displaying the transmission status appears.

**Note:**

- To stop transmitting, select the data, and click **Cancel** . You can also cancel using the printer's control panel.
- If an error occurs during transmission, the **Communication error** window appears. Check the error information and retransmit.
- The Fax Status Monitor screen (the screen mentioned above where you can check the transmission status) is not displayed if **Display Fax Status Monitor During Transmission** is not selected in the **Optional Settings** screen of the FAX Utility main screen.

### Related Information

- ➔ [“Basic Settings Menu” on page 75](#)

## Faxing

## Sending Documents Created Using an Application (Mac OS)

By selecting a fax-capable printer from the **Print** menu of a commercially available application, you can send data such as documents, drawings, and tables, you have created.

**Note:**

*The following explanation uses Text Edit, a standard Mac OS application as an example.*

1. Create the document you want to send by fax in an application.
2. Click **Print** from the **File** menu.  
The application's **Print** window is displayed.
3. Select your printer (fax name) in **Name**, click ▼ to display the detailed settings, check the print settings, and then click **OK**.

4. Make settings for each item.

- Specify **1** in **Number of copies**. Even if you specify **2** or more, only 1 copy is sent.
- You can send up to 100 pages in one fax transmission.

**Note:**

*The page size of documents you can send is the same as the paper size you can fax from the printer.*

5. Select Fax Settings from the popup menu, and then make settings for each item.

See the PC-FAX driver's help for explanations on each setting item.

Click  at the bottom left of the window to open the PC-FAX driver's help.

6. Select the Recipient Settings menu, and then specify the recipient.

- Specifying a recipient (name, fax number, and so on) directly:

Click the **Add** item, enter the necessary information, and then click . The recipient is added to the Recipient List displayed in the upper part of the window.

If you have selected "Enter fax number twice" in the PC-FAX driver settings, you need to enter the same number again when you click .

If your fax connection line requires a prefix code, enter External Access Prefix.

**Note:**

*If your printer's Line Type is set to **PBX** and the access code has been set to use # (hash) instead of entering the exact prefix code, enter # (hash). For details, see Line Type in Basic Settings from Related Information link below.*

- Selecting a recipient (name, fax number, and so on) from the phone book:

If the recipient is saved in the phone book, click . Select the recipient from the list, and then click **Add** > **OK**.

If your fax connection line requires a prefix code, enter External Access Prefix.

**Note:**

*If your printer's Line Type is set to **PBX** and the access code has been set to use # (hash) instead of entering the exact prefix code, enter # (hash). For details, see Line Type in Basic Settings from Related Information link below.*

## Faxing

7. Check the recipient settings, and then click **Fax**.

Sending starts.

Make sure the name and fax number of the recipient are correct before transmitting.

**Note:**

- If you click the printer icon in Dock, the transmission status check screen is displayed. To stop sending, click the data, and then click **Delete**.
- If an error occurs during transmission, the **Sending failed** message is displayed. Check the transmission records on the **Fax Transmission Record** screen.
- Mixed paper size documents may not be sent correctly.

### Related Information

- ➔ [“Basic Settings Menu” on page 75](#)

---

## Receiving Faxes on a Computer

You can receive faxes and save them as PDF files to the computer connected to the printer. The FAX Utility comes with features including how to specify a folder to save the faxes. Install the FAX Utility before using this feature.

**Note:**

You can use one of the following methods to install the FAX Utility.

- Using the EPSON Software Updater (application for updating software)
- Using the disc supplied with your printer. (Windows users Only )

 **Important:**

- To receive faxes on a computer, the **Receive Mode** on the printer's control panel must be set to **Auto**.
- The computer set to receive faxes should always be on. Received documents are saved in the printer's memory temporarily before the documents are saved on the computer. If you turn off the computer, the printer's memory might become full as it cannot send the documents to the computer.
- When received faxes have been temporarily saved to the printer's memory, the  light turns on.
- To read the received faxes, you need to install a PDF viewer such as Adobe Reader in the computer.

### Related Information

- ➔ [“Setting Receive Mode” on page 70](#)
- ➔ [“Software Update Tools \(EPSON Software Updater\)” on page 161](#)
- ➔ [“Installing the Latest Applications” on page 162](#)

## Saving Incoming Faxes on a Computer

You can make settings to save incoming faxes on a computer by using the FAX Utility. Install the FAX Utility on the computer in advance.

For details, see Basic Operations in the FAX Utility help (displayed on the main window). If the password entry screen is displayed on the computer screen while you are making settings, enter the password.

## Faxing

**Note:**

You can receive faxes on a computer and print from the printer at the same time. See "Related Information" below to make settings.

**Related Information**

- ➔ ["Making Save to Computer Setting to Also Print on the Printer to Receive Faxes"](#) on page 74
- ➔ ["Application for Configuring Fax Operations and Sending Faxes \(FAX Utility\)"](#) on page 158

## Canceling the Feature that Saves Incoming Faxes to the Computer

You can cancel saving faxes to the computer by using the FAX Utility.

For details, see Basic Operations in the FAX Utility help (displayed on the main window).

**Note:**

- If there are any faxes that have not been saved to the computer, you cannot cancel the feature that saves faxes on the computer.*
- You can also change the settings on the printer. If your organization has a printer administrator, contact your administrator for information on canceling settings for saving received faxes on the computer. See "Related Information" below to change settings.*

**Related Information**

- ➔ ["Making Save to Computer Setting not to Receive Faxes"](#) on page 74
- ➔ ["Application for Configuring Fax Operations and Sending Faxes \(FAX Utility\)"](#) on page 158

## Checking for New Faxes (Windows)

By setting up a computer to save faxes received by the printer, you can check the processing status of received faxes, and whether or not there are any new faxes using the fax icon on the Windows task bar. By setting up the computer to display a notification when new faxes are received, a notification screen pops up near the Windows system tray, and you can check the new faxes.



**Note:**

- Received fax data saved to the computer is removed from the printer's memory.*
- You need Adobe Reader to view the received faxes because they are saved as PDF files.*

## Using the Fax Icon on the Task Bar (Windows)

You can check for new faxes and the operation status by using the fax icon displayed on the Windows taskbar.

1. Check the icon.

-  : Standing by.
-  : Checking for new faxes.
-  : Importing new faxes is complete.



## Faxing

2. Right-click the icon, and then click **Open the received fax folder**.

The received fax folder is displayed. Check the date and the sender in the file name, and then open the PDF file.

While the fax icon indicates that it is standing by, you can check for new faxes instantly by selecting **Check new faxes now**.

**Note:**

*Received faxes are automatically renamed using the following naming format.*

YYYYMMDDHHMMSS\_XXXXXXXXXX\_nnnnn (Year/Month/Day/Hour/Minute/Second\_sender's number)

## Using the Notification Window (Windows)

When you set to notify you the new faxes exist, a notification window is displayed near the task bar for each the fax.

1. Check the notification screen displayed on your computer screen.

**Note:**

*The notification screen disappears if no operation is performed for a given length of time. You can change the notification settings such as the display time.*

2. Click anywhere in the notification screen, except for the  button.

The folder you specified to save new faxes opens. Check the date and the sender in the file name, and then open the PDF file.

**Note:**

*Received faxes are automatically renamed using the following naming format.*

YYYYMMDDHHMMSS\_XXXXXXXXXX\_nnnnn (Year/Month/Day/Hour/Minute/Second\_sender's number)

## Checking for New Faxes (Mac OS)

You can check for new faxes using one of the following methods. This is available only on computers set to "Save" (save faxes on this computer).

- Open the received fax folder (specified in **Received Fax Output Settings**.)
- Open the Fax Receive Monitor and click **Check new faxes now**.
- Notification that new faxes have been received

Select the **Notify me of new faxes via a dock icon** in the **Fax Receive Monitor > Preferences** in the FAX Utility, the fax receive monitor icon on the Dock jumps to notify you that new faxes have arrived.

## Open the Received Fax Folder from Received Fax Monitor (Mac OS)

You can open the save folder from the computer specified to receive faxes when selecting "Save" (save faxes on this computer).

1. Click the received fax monitor icon on the Dock to open **Fax Receive Monitor**.
2. Select the printer and click **Open folder**, or double click the printer name.

## Faxing

3. Check the date and the sender in the file name, and then open the PDF file.

**Note:**

*Received faxes are automatically renamed using the following naming format.*

*YYYYMMDDHHMMSS\_XXXXXXXXXX\_nnnnn (Year/Month/Day/Hour/Minute/Second\_sender's number)*

*Information sent from the sender is displayed as the sender's number. This number may not be displayed depending on the sender.*

---

## Using Other Faxing Features

### Printing Fax Report Manually

1. Select **Fax** on the home screen.  
To select an item, use the ▲ ▼ ◀ ▶ buttons, and then press the OK button.
2. Press OK button and select **More**.
3. Select **Fax Report**.
4. Select the report you want to print, and then follow the on-screen instructions.

**Note:**

*You can change the report format. From the home screen, select **Settings** > **Fax Settings** > **Report Settings**, and then change the **Attach Fax image to report** or **Report Format** settings.*

#### Related Information

- ➔ [“More” on page 130](#)
- ➔ [“Report Settings Menu” on page 77](#)

# Refilling Ink

---

## Checking the Ink Levels

To confirm the actual ink remaining, visually check the ink levels in all of the printer's tanks.

You can check the approximate ink levels from the computer.

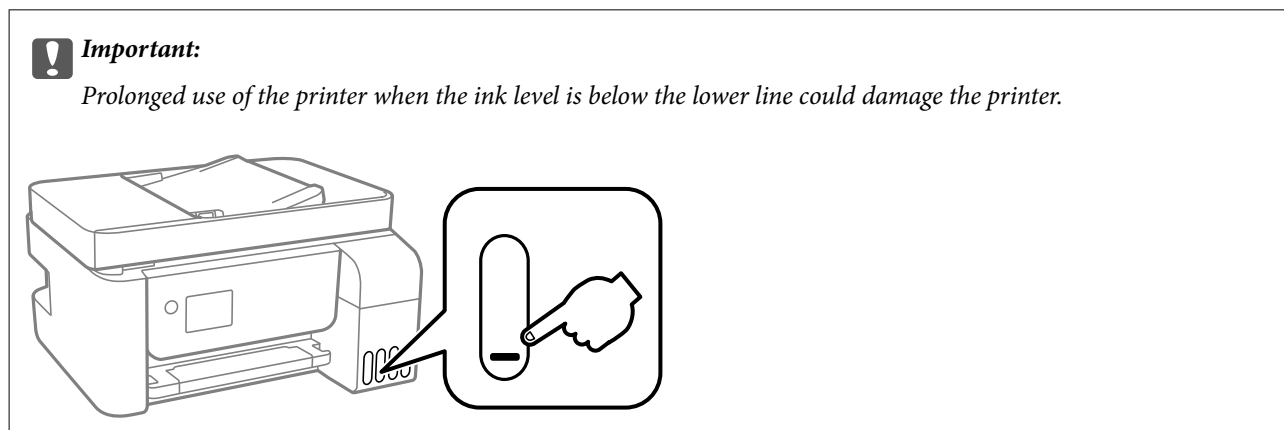

## Checking the Ink Levels - Windows

1. Access the printer driver window.
2. Click **EPSON Status Monitor 3** on the **Maintenance** tab.

**Note:**

*If EPSON Status Monitor 3 is disabled, click **Extended Settings** on the **Maintenance** tab, and then select **Enable EPSON Status Monitor 3**.*

## Checking the Ink Levels - Mac OS

1. Select **System Preferences** from the  menu > **Printers & Scanners** (or **Print & Scan**, **Print & Fax**), and then select the printer.
2. Click **Options & Supplies** > **Utility** > **Open Printer Utility**.
3. Click **EPSON Status Monitor**.

---

## Ink Bottle Codes

Epson recommends the use of genuine Epson ink bottles.

The following are the codes for genuine Epson ink bottles.

## Refilling Ink

### **Important:**

- Epson warranty does not cover damage caused by inks other than those specified, including any genuine Epson ink not designed for this printer or any third party ink.
- Other products not manufactured by Epson may cause damage that is not covered by Epson's warranties, and under certain circumstances, may cause erratic printer behavior.

### **Note:**

- Ink bottle codes may vary by location. For the correct codes in your area, contact Epson support.
- Although the ink bottles may contain recycled materials, this does not affect printer function or performance.
- Specifications and appearance of the ink bottle are subject to change without prior notice for improvement.

### For Europe

Product	BK: Black	C: Cyan	M: Magenta	Y: Yellow
ET-4700	104	104	104	104
L5190	103	103	103	103

### **Note:**

Visit the following website for information on Epson's ink bottle yields.

<http://www.epson.eu/pageyield>

### For Australia and New Zealand

BK: Black	C: Cyan	M: Magenta	Y: Yellow
522	522	522	522

### For China

BK: Black	C: Cyan	M: Magenta	Y: Yellow
004	004	004	004

### For Asian countries except for China

BK: Black	C: Cyan	M: Magenta	Y: Yellow
003	003	003	003

### Related Information

➔ [“Technical Support Web Site” on page 213](#)

## Ink Bottle Handling Precautions

Read the following instructions before refilling ink.

## Refilling Ink

### Storing precautions for ink

- Keep the ink bottles out of direct sunlight.
- Do not store the ink bottles in high or freezing temperatures.
- After bringing an ink bottle inside from a cold storage site, allow it to warm up at room temperature for at least three hours before using it.
- Epson recommends using the ink bottle before the date printed on the package.
- Do not open the ink bottle package until you are ready to fill the ink tank. The ink bottle is vacuum packed to maintain its reliability. If you leave an ink bottle unpacked for a long time before using it, normal printing may not be possible.
- Once you open an ink bottle, we recommend using it as soon as possible.
- When storing or transporting an ink bottle, do not tilt the bottle and do not subject it to impacts or temperature changes. Otherwise, ink may leak even if the cap on the ink bottle is tightened securely. Be sure to keep the ink bottle upright when tightening the cap, and take precautions to prevent ink from leaking when transporting the bottle, for example, putting the bottle in a bag.

### Handling precautions for refilling ink

- To ensure you receive premium print quality and to help protect your print head, a variable ink safety reserve remains in the ink tank when your printer indicates to refill ink. The yields quoted for you do not include this reserve.
- Use ink bottles with the correct part code for this printer.
- The ink for this printer must be handled carefully. Ink may splatter when the ink tanks are filled or refilled with ink. If ink gets on your clothes or belongings, it may not come off.
- Do not shake too vigorously or squeeze the ink bottles.
- For optimum print results do not maintain low ink levels for extended periods of time.
- To obtain optimum printing results, refill the ink tanks to the upper line at least once every year.
- Prolonged use of the printer when the ink level is below the lower line could damage the printer. Epson recommends filling the ink tank to the upper line when the printer is not operating to reset the ink level.

### Ink consumption

- To maintain optimum print head performance, some ink is consumed from all ink tanks during maintenance operations such as print head cleaning. Ink may also be consumed when you turn the printer on.
- When printing in monochrome or grayscale, color inks instead of black ink may be used depending on the paper type or print quality settings. This is because a mixture of color inks is used to create black.
- The ink in the ink bottles supplied with your printer is partly used during initial setup. In order to produce high quality printouts, the print head in your printer will be fully charged with ink. This one-off process consumes a quantity of ink and therefore these bottles may print fewer pages compared to subsequent ink bottles.
- Quoted yields may vary depending on the images that you are printing, the paper type that you are using, the frequency of your prints and environmental conditions such as temperature.

---

## Refilling the Ink Tanks

Ink can be refilled at any time.

## Refilling Ink

**!** *Important:*

*Epson recommends the use of genuine Epson ink bottles.*

1. Select **Maintenance** on the home screen.  
To select an item, use the ▲ ▼ ◀ ▶ buttons, and then press the OK button.
2. Select **Reset Ink Level**.
3. Press the ◊ button.
4. Confirm the message, and then press the ◊ button.
5. Open the ink tank cover.

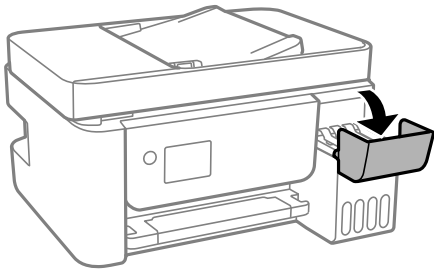

6. Open the ink tank cap.

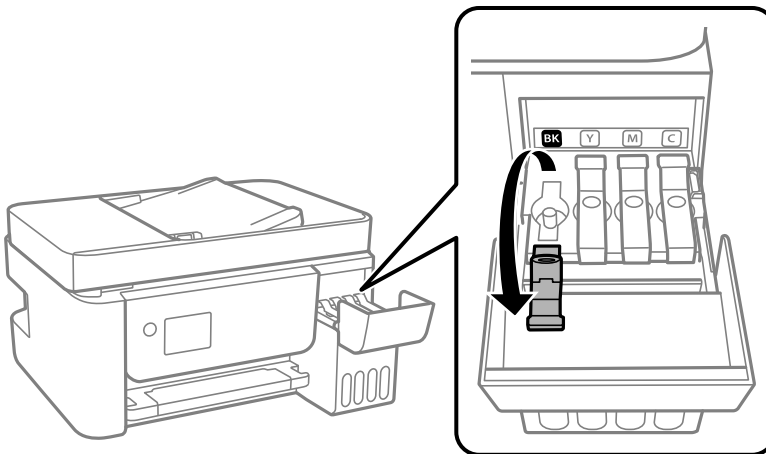

**!** *Important:*

*Make sure that the color of the ink tank matches the ink color that you want to refill.*

## Refilling Ink

7. While holding the ink bottle upright, turn the cap slowly to remove it.

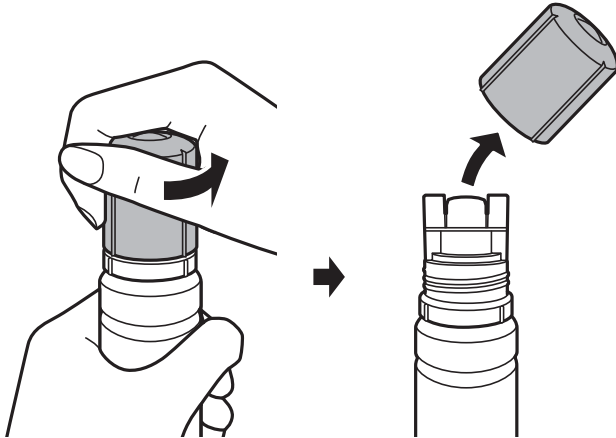

**!** *Important:*

- Be careful not to spill any ink.
- Do not touch the top of the ink bottle after removing the cap; otherwise you may be smeared with ink.

8. Align the tip of the bottle with the filling port, and then stand the bottle slowly to insert it into the filling port.

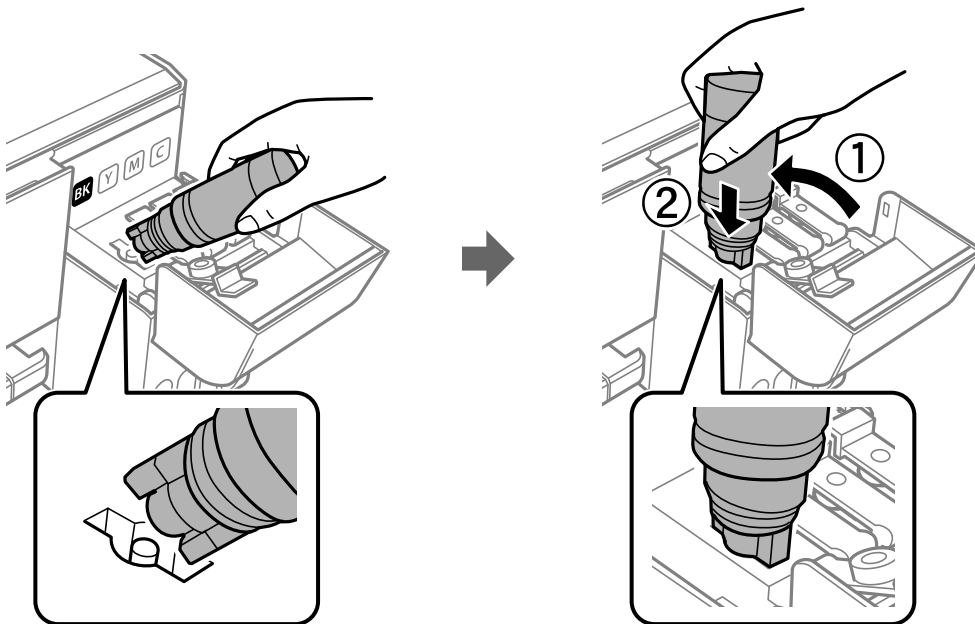

**!** *Important:*

Do not allow the top of the ink bottle to hit against any objects after removing its cap; otherwise ink may spill.

## Refilling Ink

9. Insert the top of the ink bottle securely into the filling port of the tank to refill the tank with ink. Ink pours into the tank just by holding the bottle normally without squeezing. The ink flow stops automatically when the ink is filled to the upper line.

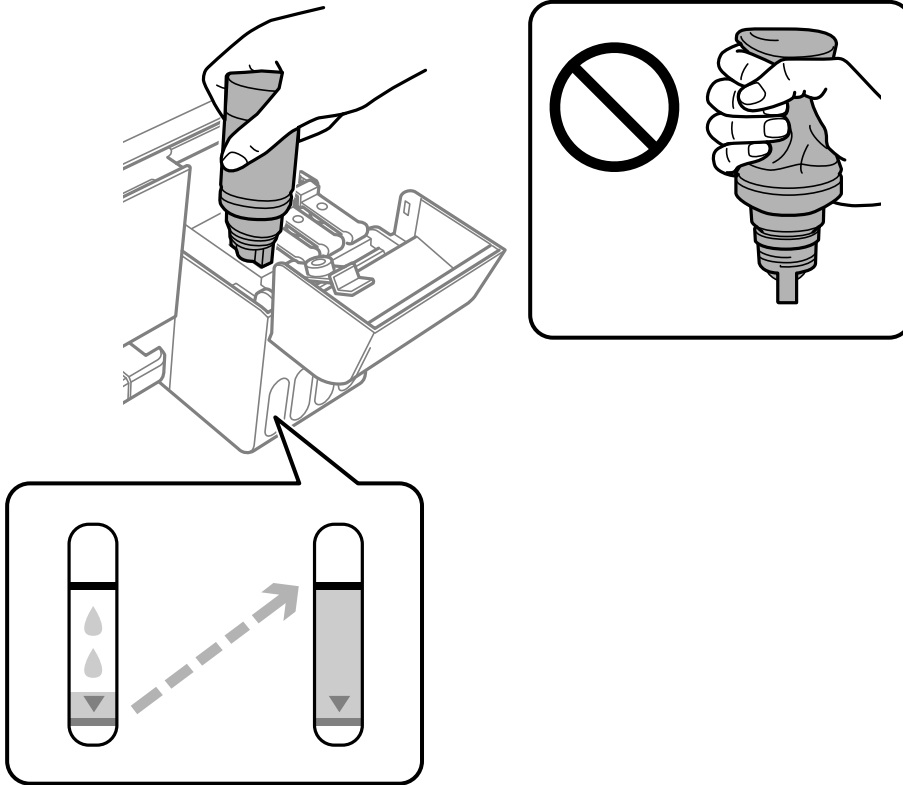

**Note:**

- If the ink does not start flowing into the tank, remove the ink bottle and try reinserting it.
- You can reset the ink levels even if you did not fill the ink to the upper line. However, this printer cannot generate notifications and stop operations before ink levels drop below the lower line.

10. When you have finished refilling the ink, remove the ink bottle, and then close the ink tank cap securely.

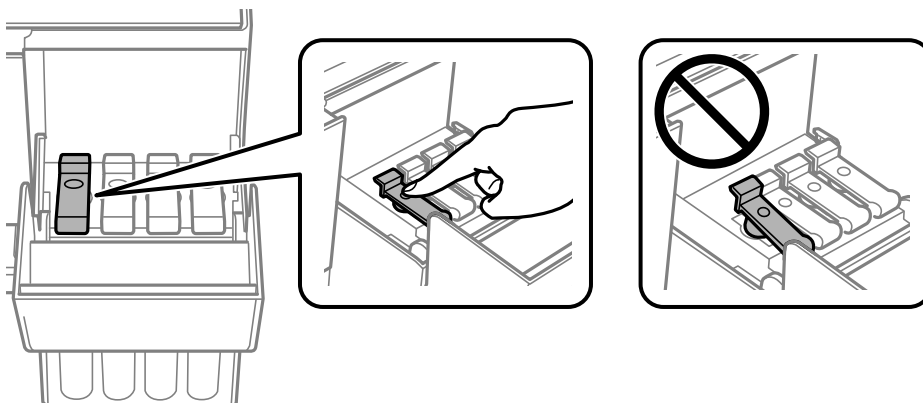

**! Important:**

Do not leave the ink bottle inserted; otherwise the bottle may be damaged or ink may leak.



## Refilling Ink

**Note:**

If any ink remains in the ink bottle, tighten the cap and store the bottle upright for later use.

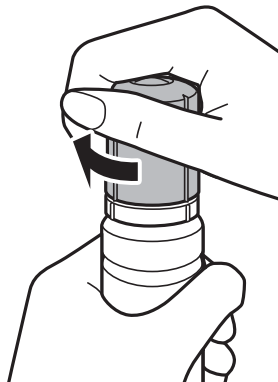

11. Close the ink tank cover firmly and then press the  button.

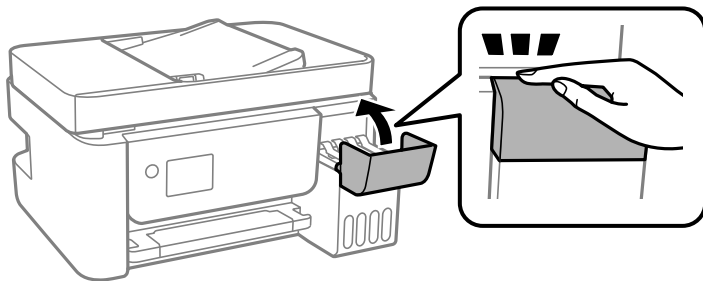

12. Select the color of the ink you refilled up to the upper line.
13. Press the  button to reset the ink level.
14. Confirm the message, and then press the OK button.

**! Important:**

If you continue to use the printer after resetting the ink level without refilling the ink tank to the upper line, printing may be performed without ink and this may damage the printer. Before you start printing, make sure you visually check the ink levels in all of the ink tanks.

**Related Information**

- ➔ [“Ink Bottle Codes” on page 139](#)
- ➔ [“Ink Bottle Handling Precautions” on page 140](#)
- ➔ [“Ink Spilled” on page 200](#)

# Maintaining the Printer

---

## Preventing the Print Head from Drying

Always use the power button when turning the printer on and off.

Check that the power light is off before you disconnect the power cord.

The ink itself can dry out if it is not covered. Just like placing a cap on a fountain pen or an oil pen to prevent it from drying, make sure the print head is capped properly to prevent the ink from drying.

When the power cord is unplugged or a power outage occurs while the printer is in operation, the print head may not be capped properly. If the print head is left as it is, it will dry out causing nozzles (ink outlets) to clog.

In these cases, turn the printer on and off again as soon as possible to cap the print head.

---

## Checking and Cleaning the Print Head

If the nozzles are clogged, the printouts become faint, there is visible banding, or unexpected colors appear. When print quality has declined, use the nozzle check feature and check if the nozzles are clogged. If the nozzles are clogged, clean the print head.

 **Important:**

- Do not open the inner cover or turn off the printer during head cleaning. If the head cleaning is incomplete, you may not be able to print.
- Because print head cleaning uses some ink, clean the print head only if quality declines.
- When ink is low, you may not be able to clean the print head.
- If print quality has not improved after repeating nozzle check and head cleaning three times, wait for at least 12 hours without printing, and then run the nozzle check again and repeat the head cleaning if necessary. We recommend to turn off the printer. If print quality has still not improved, run Power Cleaning. If it has still not improved, contact Epson support.
- To prevent the print head from drying out, do not unplug the printer while the power is on.

## Checking and Cleaning the Print Head - Control Panel

1. Load A4-size plain paper in the printer.
2. Select **Maintenance** on the home screen.  
To select an item, use the ▲ ▼ ◀▶ buttons, and then press the OK button.
3. Select **Nozzle Check**.
4. Follow the on-screen instructions to print the nozzle check pattern.

## Maintaining the Printer

5. Examine the printed pattern.
  - If you cannot see any broken lines or missing segments as in the following "OK" pattern, the nozzles are not clogged. Select **No** to close the nozzle check feature. No further steps are necessary.
  - If there are broken lines or missing segments as shown in the "NG" pattern, the print head nozzles may be clogged. Go to the next step.

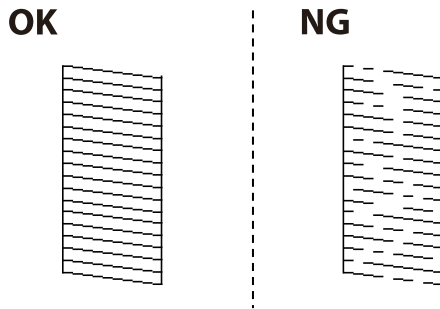

6. Select **Yes**, and then follow the on-screen instructions to clean the print head.
7. When cleaning is finished, print the nozzle check pattern again. Repeat cleaning and printing the pattern until all lines are printed completely.

### Related Information

➔ [“Loading Paper in the Rear Paper Feed” on page 48](#)

## Checking and Cleaning the Print Head - Windows

1. Load A4-size plain paper in the printer.
2. Access the printer driver window.
3. Click **Nozzle Check** on the **Maintenance** tab.
4. Follow the on-screen instructions.

### Related Information

➔ [“Loading Paper in the Rear Paper Feed” on page 48](#)

➔ [“Accessing the Printer Driver” on page 79](#)

## Checking and Cleaning the Print Head - Mac OS

1. Load A4-size plain paper in the printer.
2. Select **System Preferences** from the  menu > **Printers & Scanners** (or **Print & Scan**, **Print & Fax**), and then select the printer.
3. Click **Options & Supplies** > **Utility** > **Open Printer Utility**.
4. Click **Nozzle Check**.

## Maintaining the Printer

5. Follow the on-screen instructions.

### Related Information

- ➔ [“Loading Paper in the Rear Paper Feed” on page 48](#)

---

## Running Power Cleaning

The **Power Cleaning** utility allows you to replace all of the ink inside the ink tubes. In the following situations, you may need to use this feature to improve the print quality.

- You printed or performed head cleaning when the ink levels were too low to be seen in the ink tank windows.
- You performed the nozzle check and head cleaning several times and then waited for at least 12 hours without printing, but print quality still did not improve.

Before running this feature, read the following instructions.

**Important:**

*Make sure that there is enough ink in the ink tanks.*

*Visually check all ink tanks are at least a third full. Low ink levels during Power Cleaning could damage the product.*

**Important:**

*An interval of 12 hours is required between each Power Cleaning.*

*Normally, a single Power Cleaning should resolve the print quality issue within 12 hours. Therefore, to avoid unnecessary ink usage, you must wait 12 hours before you try it again.*

**Important:**



*This feature effects the service life of the ink pads. The ink pads reach their capacity earlier by running this feature. If the ink pads have reached the end of their service life, contact Epson Support to request replacement.*

**Note:**

*When the ink levels are insufficient for Power Cleaning, you cannot run this feature. Even in this case, the levels for printing may remain.*

## Running Power Cleaning - Control Panel

Read the instructions for Power Cleaning before running this feature.

1. Turn off the printer.
2. While holding down the  button, press the  button to display the confirmation screen until the power light flashes.

## Maintaining the Printer

3. Follow the on-screen instructions to run the Power Cleaning feature.

**Note:**

If you cannot run this feature, solve the problems that are displayed on the screen. Next, follow this procedure from step 1 to run this feature again.

4. After running this feature, run the nozzle check to make sure the nozzles are not clogged.

For details on how to run the nozzle check, see the related information below.

### Related Information

- ➔ [“Checking and Cleaning the Print Head” on page 146](#)

## Running Power Cleaning - Windows

1. Access the printer driver window.
2. Click **Power Cleaning** on the **Maintenance** tab.
3. Follow the on-screen instructions.

**Note:**

If you cannot run this feature, solve the problems that are displayed on the printer's control panel. Next, follow this procedure from step 1 to run this feature again.

### Related Information

- ➔ [“Accessing the Printer Driver” on page 79](#)

## Running Power Cleaning - Mac OS

1. Select **System Preferences** from the  menu > **Printers & Scanners** (or **Print & Scan**, **Print & Fax**), and then select the printer.
2. Click **Options & Supplies** > **Utility** > **Open Printer Utility**.
3. Click **Power Cleaning**.
4. Follow the on-screen instructions.

**Note:**

If you cannot run this feature, solve the problems that are displayed on the printer's control panel. Next, follow this procedure from step 1 to run this feature again.

---

## Aligning the Print Head

If print results contain the following problems, align the print head to improve the printouts.

- Vertical lines look misaligned or the printouts look blurry
- Horizontal banding occurs at regular intervals

## Maintaining the Printer

### Aligning the Print Head - Control Panel

1. Select **Maintenance** on the home screen.  
To select an item, use the ▲ ▼ ◀▶ buttons, and then press the OK button.
2. Select **Print Head Alignment**.
3. Select the adjustment menu you want to adjust to improve the printouts according to the status of the print results.
  - Vertical lines look misaligned or the printouts look blurry : Select **Vertical Alignment**.
  - Horizontal banding occurs at regular intervals: Select **Horizontal Alignment**.
4. Follow the on-screen instructions.

#### Related Information

➔ [“Loading Paper in the Rear Paper Feed” on page 48](#)

---

## Cleaning the Paper Path for Ink Smears

When the printouts are smeared or scuffed, clean the roller inside.

**Important:**

*Do not use tissue paper to clean the inside of the printer. The print head nozzles may be clogged with lint.*

1. Load A4-size plain paper in the rear paper feed slot.
2. Select **Maintenance** on the home screen.  
To select an item, use the ▲ ▼ ◀▶ buttons, and then press the OK button.
3. Select **Paper Guide Cleaning**.
4. Follow the on-screen instructions to clean the paper path.  
Repeat this procedure until the paper is not smeared with ink.

#### Related Information

➔ [“Loading Paper in the Rear Paper Feed” on page 48](#)

---

## Cleaning the ADF

When the copied or scanned images from the ADF are smeared or the originals do not feed in the ADF correctly, clean the ADF.

## Maintaining the Printer

**!** *Important:*

*Never use alcohol or thinner to clean the printer. These chemicals can damage the printer.*

1. Open the ADF cover.

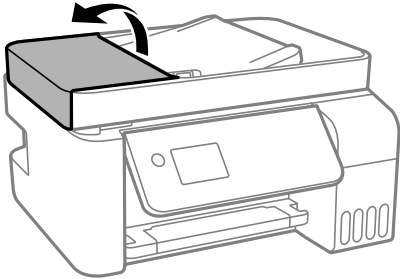

2. Use a soft, moist cloth to clean the roller and the interior of the ADF.

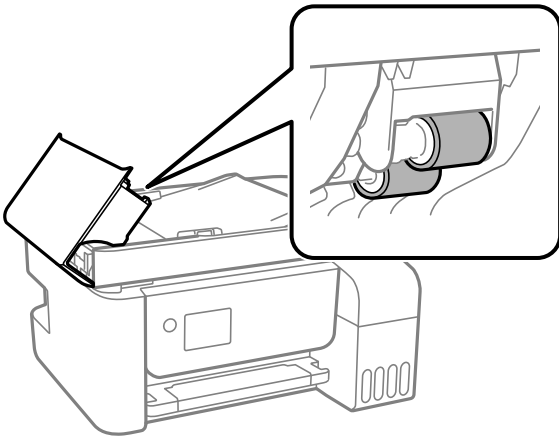

**!** *Important:*

- Using a dry cloth may damage the surface of the roller.*
- Use the ADF after the roller has dried.*

3. Open the document cover.

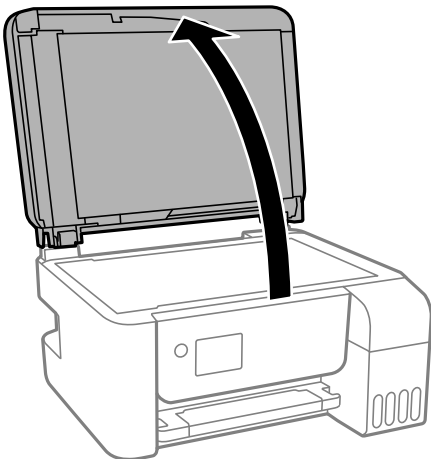

## Maintaining the Printer

- Clean the part that is shown in the illustration.

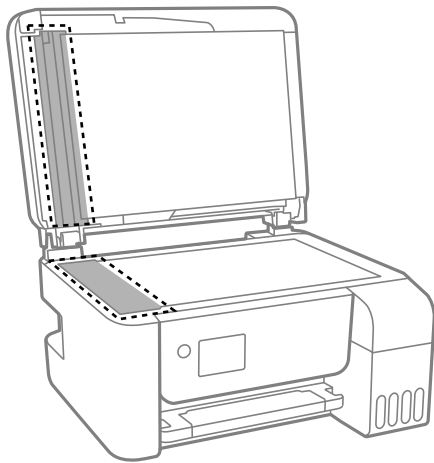

**!** **Important:**

- If the glass surface is stained with grease or some other hard-to-remove material, use a small amount of glass cleaner and a soft cloth to remove it. Wipe off all remaining liquid.
- Do not press the glass surface too hard.
- Be careful not to scratch or damage the surface of the glass. A damaged glass surface can decrease the scan quality.

---

## Cleaning the Scanner Glass

When the copies or scanned images are smeared, clean the scanner glass.

**!** **Caution:**

Be careful not to trap your hand or fingers when opening or closing the document cover. Otherwise you may be injured.

**!** **Important:**

Never use alcohol or thinner to clean the printer. These chemicals can damage the printer.



## Maintaining the Printer

1. Open the document cover.

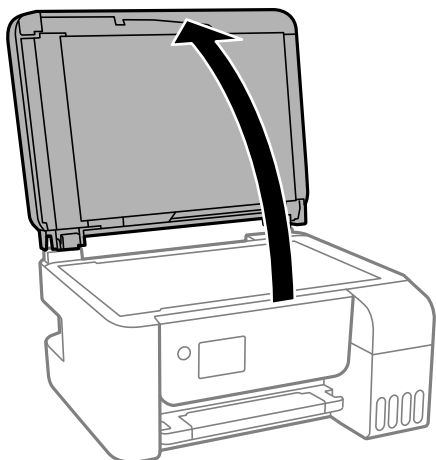

2. Use a soft, dry, clean cloth to clean the surface of the scanner glass.

**!** *Important:*

- If the glass surface is stained with grease or some other hard-to-remove material, use a small amount of glass cleaner and a soft cloth to remove it. Wipe off all remaining liquid.*
- Do not press the glass surface too hard.*
- Be careful not to scratch or damage the surface of the glass. A damaged glass surface can decrease the scan quality.*

---

## Checking the Total Number of Pages Fed Through the Printer

You can check the total number of pages fed through the printer.

### Checking the Total Number of Pages Fed Through the Printer - Control Panel

The information is printed together with the nozzle check pattern.

1. Load A4-size plain paper in the printer.
2. Select **Maintenance** on the home screen.

To select an item, use the ▲ ▼ ◀ ▶ buttons, and then press the OK button.

3. Select **Nozzle Check**.
4. Follow the on-screen instructions to print the nozzle check pattern.

## Maintaining the Printer

### Related Information

➔ [“Loading Paper in the Rear Paper Feed” on page 48](#)

## Checking the Total Number of Pages Fed Through the Printer - Windows

1. Access the printer driver window.
2. Click **Printer and Option Information** on the **Maintenance** tab.

### Related Information

➔ [“Accessing the Printer Driver” on page 79](#)

## Checking the Total Number of Pages Fed Through the Printer - Mac OS

1. Select **System Preferences** from the  menu > **Printers & Scanners** (or **Print & Scan**, **Print & Fax**), and then select the printer.
2. Click **Options & Supplies** > **Utility** > **Open Printer Utility**.
3. Click **Printer and Option Information**.

# Network Service and Software Information

This section introduces the network services and software products available for your printer from the Epson website or the supplied software disc.

## Application for Configuring Printer Operations (Web Config)

Web Config is an application that runs in a web browser, such as Internet Explorer and Safari, on a computer or smart device. You can confirm the printer status or change the network service and printer settings. To use the Web Config, connect the printer and the computer or device to the same network.

The following browsers are supported.

OS	Browser
Windows XP SP3 or later	Microsoft Edge, Internet Explorer 8 or later, Firefox*, Chrome*
Mac OS X v10.6.8 or later	Safari*, Firefox*, Chrome*
iOS*	Safari*
Android 2.3 or later	Default browser
Chrome OS*	Default browser

\* Use the latest version.

## Running Web Config on a Web Browser

1. Check the printer's IP address.

Select **Settings** > **Network Settings** > **Connection Check** from the control panel to start the connection check.

Press the  button or the OK button to print the network connection report. Check the printer's IP address on the printed network connection report.

2. Launch a Web browser from a computer or smart device, and then enter the printer's IP address.

Format:

IPv4: http://the printer's IP address/

IPv6: http://[the printer's IP address]/

Examples:

IPv4: http://192.168.100.201/

IPv6: http://[2001:db8::1000:1]/

## Network Service and Software Information

**Note:**

Using the smart device, you can also run Web Config from the maintenance screen of Epson iPrint.

**Related Information**

➔ [“Using Epson iPrint” on page 103](#)

## Running Web Config on Windows

When connecting a computer to the printer using WSD, follow the steps below to run Web Config.

1. Open the printer list on the computer.
  - Windows 10/Windows Server 2016  
Click on the start button, and then select **Windows System > Control Panel > View devices and printers in Hardware and Sound**.
  - Windows 8.1/Windows 8/Windows Server 2012 R2/Windows Server 2012  
Select **Desktop > Settings > Control Panel > View devices and printers in Hardware and Sound (or Hardware)**.
  - Windows 7/Windows Server 2008 R2  
Click the start button, and select **Control Panel > View devices and printers in Hardware and Sound**.
  - Windows Vista/Windows Server 2008  
Click the start button, and select **Control Panel > Printers in Hardware and Sound**.
2. Right-click on your printer and select **Properties**.
3. Select the **Web Service** tab and click the URL.

## Running Web Config on Mac OS

1. Select **System Preferences** from the  menu > **Printers & Scanners** (or **Print & Scan, Print & Fax**), and then select the printer.
2. Click **Options & Supplies > Show Printer Webpage**.

---

## Application for Scanning Documents and Images (Epson Scan 2)

Epson Scan 2 is an application for controlling scanning. You can adjust the size, resolution, brightness, contrast, and quality of the scanned image. You can also start Epson Scan 2 from a TWAIN-compliant scanning application. See the application's help for details.

**Starting on Windows****Note:**

For Windows Server operating systems, make sure the **Desktop Experience** feature is installed.

## Network Service and Software Information

- ❑ Windows 10/Windows Server 2016

Click the start button, and then select **EPSON > Epson Scan 2**.

- ❑ Windows 8.1/Windows 8/Windows Server 2012 R2/Windows Server 2012

Enter the application name in the search charm, and then select the displayed icon.

- ❑ Windows 7/Windows Vista/Windows XP/Windows Server 2008 R2/Windows Server 2008/Windows Server 2003 R2/Windows Server 2003

Click the start button, and then select **All Programs** or **Programs > EPSON > Epson Scan 2 > Epson Scan 2**.

### Starting on Mac OS

**Note:**

*Epson Scan 2 does not support the Mac OS fast user switching feature. Turn off fast user switching.*

Select **Go > Applications > Epson Software > Epson Scan 2**.

### Related Information

➔ [“Scanning Using Epson Scan 2” on page 116](#)

➔ [“Installing the Latest Applications” on page 162](#)

## Adding the Network Scanner

Before using Epson Scan 2, you need to add the network scanner.

1. Start the software, and then click **Add** on the **Scanner Settings** screen.

**Note:**

- ❑ If **Add** is grayed out, click **Enable Editing**.

- ❑ If the main screen of Epson Scan 2 is displayed, it has already been connected to the scanner. If you want to connect to another network, select **Scanner > Settings** to open the **Scanner Settings** screen.

2. Add the network scanner. Enter the following items, and then click **Add**.

- ❑ **Model:** Select the scanner you want to connect to.

- ❑ **Name:** Enter the scanner name within 32 characters.

- ❑ **Search for Network:** When the computer and the scanner are on the same network, the IP address is displayed. If it is not displayed, click the  button. If the IP address is still not displayed, click **Enter address**, and then enter the IP address directly.

3. Select the scanner on the **Scanner Settings** screen, and then click **OK**.

---

## Application for Configuring Scanning Operations from the Control Panel (Epson Event Manager)

Epson Event Manager is an application that allows you to manage scanning from the control panel and save images to a computer. You can add your own settings as presets, such as the document type, the save folder location, and the image format. See the application's help for details.

## Network Service and Software Information

**Note:**

Windows Server operating systems are not supported.

**Starting on Windows** Windows 10

Click the start button, and then select **Epson Software > Event Manager**.

 Windows 8.1/Windows 8

Enter the application name in the search charm, and then select the displayed icon.

 Windows 7/Windows Vista/Windows XP

Click the start button, and then select **All Programs** or **Programs > Epson Software > Event Manager**.

**Starting on Mac OS**

Go > Applications > Epson Software > Event Manager.

**Related Information**

➔ [“Installing the Latest Applications” on page 162](#)

---

# Application for Configuring Fax Operations and Sending Faxes (FAX Utility)

FAX Utility is an application that allows you to configure various settings for sending faxes from a computer. You can create or edit the contacts list to be used when sending a fax, configure to save received faxes in PDF format on the computer, and so on. See the application's help for details.

**Note:**

Windows Server operating systems are not supported.

Make sure you have installed the printer driver before installing FAX Utility.

**Starting on Windows** Windows 10

Click the start button, and select **Epson Software > FAX Utility**.

 Windows 8.1/Windows 8

Enter the application name in the search charm, and then select the displayed icon.

 Windows 7/Windows Vista/Windows XP

Click the start button, and select **All Programs** (or **Programs**) > **Epson Software > FAX Utility**.

**Starting on Mac OS**

Select **System Preferences** from the  menu > **Printers & Scanners** (or **Print & Scan, Print & Fax**), and then select the printer (FAX). Click **Options & Supplies > Utility > Open Printer Utility**.

**Related Information**

➔ [“Receiving Faxes on a Computer” on page 135](#)

➔ [“Installing the Latest Applications” on page 162](#)

---

## Application for Sending Faxes (PC-FAX Driver)

PC-FAX driver is an application that allows you to send a document created on a separate application as a fax directly from the computer. PC-FAX driver is installed when you install FAX Utility. See the application's help for details.

**Note:**

- Windows Server operating systems are not supported.*
- The operation differs depending on the application you used to create the document. See the application's help for details.*

### Accessing from Windows

In the application, select **Print** or **Print Setup** from the **File** menu. Select your printer (FAX), and then click **Preferences** or **Properties**.

### Accessing from Mac OS

In the application, select **Print** from the **File** menu. Select your printer (FAX) as the **Printer** setting, and then select **Fax Settings** or **Recipient Settings** from the pop-up menu.

### Related Information

- ➔ [“Sending a Fax from a Computer” on page 131](#)
- ➔ [“Application for Configuring Fax Operations and Sending Faxes \(FAX Utility\)” on page 158](#)

---

## Application for Printing Images (Epson Photo+)

Epson Photo+ is an application that allows you to easily print images with a variety of layouts. You can also perform image correction and adjust the position while viewing a preview of your document. You can also brighten up your images by adding text and stamps wherever you like. When printing on genuine Epson photo paper, the ink performance is maximized creating a beautiful finish with excellent coloring.

See the application's help for details.

**Note:**

- Windows Server operating systems are not supported.*
- To use this application the printer driver for this printer must be installed.*
- You can also print images by using Epson Easy Photo Print. See the application's help for details.*

### Starting

- Windows 10/Windows Server 2016  
Click the start button, and then select **Epson Software > Epson Photo+**.
- Windows 8.1/Windows 8/Windows Server 2012 R2/Windows Server 2012  
Enter the application name in the search charm, and then select the displayed icon.
- Windows 7/Windows Vista/Windows XP/Windows Server 2008 R2/Windows Server 2008/Windows Server 2003 R2/Windows Server 2003  
Click the start button, and select **All Programs** or **Programs > Epson Software > Epson Photo+**.

### Starting on Mac OS

Select **Go** > **Applications** > **Epson Software** > **Epson Photo+**.

### Related Information

➔ [“Installing the Latest Applications” on page 162](#)

---

## Application for Printing Web Pages (E-Web Print)

E-Web Print is an application that allows you to easily print web pages with various layouts. See the application's help for details. You can access the help from the **E-Web Print** menu on the **E-Web Print** tool bar.

### Note:

- Windows Server operating systems are not supported.
- Mac OS is not supported.
- Check for supported browsers and the latest version from the download site.

### Starting

When you install E-Web Print, it is displayed in your browser. Click **Print** or **Clip**.

### Related Information

➔ [“Installing the Latest Applications” on page 162](#)

---

## Application for Scanning and Transferring Images (Easy Photo Scan)

Easy Photo Scan is an application that allows you to scan photos and easily send the scanned image to a computer or cloud service. You can also easily adjust the scanned image. See the application's help for details.

### Note:

- Windows Server operating systems are not supported.
- To use this application, the scanner driver Epson Scan 2 needs to be installed.

### Starting on Windows

- Windows 10

Click the start button, and then select **Epson Software** > **Easy Photo Scan**.

- Windows 8.1/Windows 8

Enter the application name in the search charm, and then select the displayed icon.

- Windows 7/Windows Vista/Windows XP

Click the start button, and then select **All Programs** or **Programs** > **Epson Software** > **Easy Photo Scan**.

### Starting on Mac OS

Select **Go** > **Applications** > **Epson Software** > **Easy Photo Scan**.



---

## Software Update Tools (EPSON Software Updater)

EPSON Software Updater is an application that checks for new or updated software on the internet and installs it. You can also update the printer's firmware and manual.

**Note:**

*Windows Server operating systems are not supported.*

### Installing Method

Download EPSON Software Updater from the Epson website.

If you are using a Windows computer and cannot to download it from the website, you can install it from the supplied software disc.

<http://www.epson.com>

### Starting on Windows

 Windows 10

Click the start button, and then select **Epson Software > EPSON Software Updater**.

 Windows 8.1/Windows 8

Enter the application name in the search charm, and then select the displayed icon.

 Windows 7/Windows Vista/Windows XP

Click the start button, and then select **All Programs** or **Programs > Epson Software > EPSON Software Updater**.

**Note:**

*You can also start EPSON Software Updater by clicking the printer icon on the task bar on the desktop, and then selecting **Software Update**.*

### Starting on Mac OS

Select **Go > Applications > Epson Software > EPSON Software Updater**.

---

## Application for Configuring Multiple Devices (EpsonNet Config)

EpsonNet Config is an application that allows you to set the network interface addresses and protocols. See the operations guide for EpsonNet Config or the application's help for more details.

### Starting on Windows

 Windows 10/Windows Server 2016

Click the start button, and then select **EpsonNet > EpsonNet Config**.

 Windows 8.1/Windows 8/Windows Server 2012 R2/Windows Server 2012

Enter the application name in the search charm, and then select the displayed icon.

## Network Service and Software Information

- ❑ Windows 7/Windows Vista/Windows XP/Windows Server 2008 R2/Windows Server 2008/Windows Server 2003 R2/Windows Server 2003

Click the start button, and select **All Programs** or **Programs > EpsonNet > EpsonNet Config SE > EpsonNet Config**.

### Starting on Mac OS

Go > **Applications > Epson Software > EpsonNet > EpsonNet Config SE > EpsonNet Config**.

---

## Installing the Latest Applications

### Note:

When reinstalling an application, you need to uninstall it first.

1. Make sure the printer and the computer are available for communication, and the printer is connected to the Internet.
2. Start EPSON Software Updater.

The screenshot is an example on Windows.

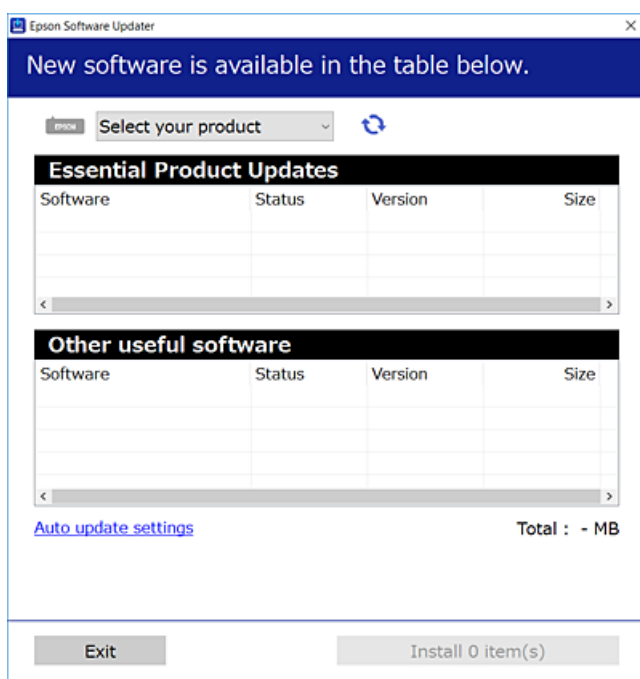

3. For Windows, select your printer, and then click  to check for the latest available applications.
4. Select the items you want to install or update, and then click the install button.



### Important:

Do not turn off or unplug the printer until the update is complete; otherwise, the printer may malfunction.

## Network Service and Software Information

**Note:**

- You can download the latest applications from the Epson website.

<http://www.epson.com>

- If you use Windows Server operating systems, you cannot use EPSON Software Updater. Download the latest applications from the Epson website.

**Related Information**

- ➔ “Software Update Tools (EPSON Software Updater)” on page 161
- ➔ “Uninstalling Applications” on page 163

---

# Updating the Printer's Firmware using the Control Panel

If the printer is connected to the Internet, you can update the printer's firmware using the control panel. You can also set the printer to regularly check for firmware updates and notify you if any are available.

1. Select **Settings** on the home screen.

To select an item, use the ▲ ▼ ◀ ▶ buttons, and then press the OK button.

2. Select **Firmware Update > Update**.

**Note:**

Enable **Notification** to set the printer to regularly check for available firmware updates.

3. Check the message displayed on the screen and press the OK button to start searching for available updates.
4. If a message is displayed on the LCD screen informing you that a firmware update is available, follow the on-screen instructions to start the update.

**Important:**

- Do not turn off or unplug the printer until the update is complete; otherwise, the printer may malfunction.
- If the firmware update is not completed or is unsuccessful, the printer does not start up normally and "Recovery Mode" is displayed on the LCD screen the next time the printer is turned on. In this situation, you need to update the firmware again using a computer. Connect the printer to the computer with a USB cable. While "Recovery Mode" is displayed on the printer, you cannot update the firmware over a network connection. On the computer, access your local Epson website, and then download the latest printer firmware. See the instructions on the website for the next steps.

---

# Uninstalling Applications

Log in to your computer as an administrator. Enter the administrator password if the computer prompts you.

## Uninstalling Applications - Windows

1. Press the  button to turn off the printer.
2. Quit all running applications.
3. Open **Control Panel**:
  - Windows 10/Windows Server 2016  
Click on the start button, and then select **Windows System > Control Panel**.
  - Windows 8.1/Windows 8/Windows Server 2012 R2/Windows Server 2012  
Select **Desktop > Settings > Control Panel**.
  - Windows 7/Windows Vista/Windows XP/Windows Server 2008 R2/Windows Server 2008/Windows Server 2003 R2/Windows Server 2003  
Click the start button and select **Control Panel**.
4. Open **Uninstall a program** (or **Add or Remove Programs**):
  - Windows 10/Windows 8.1/Windows 8/Windows 7/Windows Vista/Windows Server 2016/Windows Server 2012 R2/Windows Server 2012/Windows Server 2008 R2/Windows Server 2008  
Select **Uninstall a program** in **Programs**.
  - Windows XP/Windows Server 2003 R2/Windows Server 2003  
Click **Add or Remove Programs**.
5. Select the application you want to uninstall.  
You cannot uninstall the printer driver if there is any print jobs. Delete or wait to be printed the jobs before uninstalling.
6. Uninstall the applications:
  - Windows 10/Windows 8.1/Windows 8/Windows 7/Windows Vista/Windows Server 2016/Windows Server 2012 R2/Windows Server 2012/Windows Server 2008 R2/Windows Server 2008  
Click **Uninstall/Change** or **Uninstall**.
  - Windows XP/Windows Server 2003 R2/Windows Server 2003  
Click **Change/Remove** or **Remove**.

**Note:**  
*If the **User Account Control** window is displayed, click **Continue**.*
7. Follow the on-screen instructions.

## Uninstalling Applications - Mac OS

1. Download the Uninstaller using EPSON Software Updater.  
Once you have downloaded the Uninstaller, you do not need to download it again each time you uninstall the application.
2. Press the  button to turn off the printer.

## Network Service and Software Information

3. To uninstall the printer driver or PC-FAX driver, select **System Preferences** from the  menu > **Printers & Scanners** (or **Print & Scan, Print & Fax**), and then remove the printer from the enabled printers list.
4. Quit all running applications.
5. Select **Go > Applications > Epson Software > Uninstaller**.
6. Select the application you want to uninstall, and then click **Uninstall**.

**Important:**

*The Uninstaller removes all drivers for Epson inkjet printers on the computer. If you use multiple Epson inkjet printers and you only want to delete some drivers, delete all of them first, and then install the necessary printer driver again.*

**Note:**

*If you cannot find the application you want to uninstall in the application list, you cannot uninstall using the Uninstaller. In this situation, select **Go > Applications > Epson Software**, select the application you want to uninstall, and then drag it to the trash icon.*

**Related Information**

➔ [“Software Update Tools \(EPSON Software Updater\)” on page 161](#)

---

## Printing Using a Network Service

By using Epson Connect service available on the Internet, you can print from your smartphone, tablet PC, or laptop, anytime and practically anywhere. To use this service, you need to register the user and the printer in Epson Connect.

The features available on the Internet are as follows.

 Email Print

When you send an email with attachments such as documents or images to an email address assigned to the printer, you can print that email and the attachments from remote locations such as your home or office printer.

 Epson iPrint

This Application is for iOS and Android, and allows you to print from a smart phone or tablet. You can print documents, images, and websites by sending them directly to a printer on the same wireless LAN.

 Remote Print Driver

This is a shared driver supported by Remote Print Driver. When printing using a printer in a remote location, you can print by changing the printer on the usual applications window.

See the Epson Connect portal website for details.

<https://www.epsonconnect.com/>



<http://www.epsonconnect.eu> (Europe only)

# Solving Problems

## Checking the Printer Status

### Checking Error Codes on the LCD Screen

A code is displayed on the LCD screen if there is an error or information that requires your attention. If a code is displayed, follow the solutions below to solve the problem.

Code	Situation	Solutions
E-01	A printer error has occurred.	Open the inner cover and remove any paper or protective material inside the printer. Turn the power off and on again.
E-02	A scanner error has occurred.	Turn the power off and on again.
E-11	An ink pad needs to be replaced.	Contact Epson or an authorised Epson service provider to replace the ink pad*. It is not a user-serviceable part. However, non-printing features such as scanning are available.
E-12	A borderless printing ink pad needs to be replaced.	Contact Epson or an authorised Epson service provider to replace the borderless printing ink pad*. It is not a user-serviceable part. Borderless printing is not available, but printing with a border is available.
W-01	A paper jam has occurred.	Remove the paper from the printer and press the button displayed on the bottom of the LCD screen to clear the error. In some cases, you need to turn the power off and on again.
W-11	An ink pad is nearing the end of its service life.	Contact Epson or an authorised Epson service provider to replace the ink pad*. It is not a user-serviceable part. The message will be displayed until the ink pad is replaced. Press the  button to resume printing.
W-14	A borderless printing ink pad is nearing the end of its service life.	Contact Epson or an authorised Epson service provider to replace the borderless printing ink pad*. It is not a user-serviceable part. The message will be displayed until the ink pad is replaced. Press the  button to resume printing.
I-22	Set Wi-Fi from the <b>Push Button (WPS)</b> .	Push the access point button. If there is no button on the access point, open the access point setting window, and then click the button displayed in the software.
I-23	Set Wi-Fi from the <b>PIN Code (WPS)</b> .	Enter the PIN code displayed on the LCD screen into the access point or computer within two minutes.
I-31	Set Wi-Fi from the <b>Wi-Fi Auto Connect</b> .	Install the software on your computer, and then press the OK button when Wi-Fi setup starts.
I-41	<b>Paper Setup Auto Display</b> is disabled. Some functions cannot be used.	If <b>Paper Setup Auto Display</b> is disabled, you cannot use AirPrint. To use AirPrint, enable <b>Paper Setup Auto Display</b> .

## Solving Problems

Code	Situation	Solutions
I-60	Your computer may not support WSD (Web Services for Devices).	The scan to computer (WSD) feature is only available for computers running English versions of Windows 10, Windows 8.1, Windows 8, Windows 7 or Windows Vista. Make sure that the printer is correctly connected to the computer.
Recovery Mode	The printer has started in recovery mode because the firmware update failed.	Follow the steps below to try to update the firmware again. 1. Connect the computer and the printer with a USB cable. (During recovery mode, you cannot update the firmware over a network connection.) 2. Visit your local Epson website for further instructions.

\* In some print cycles a very small amount of surplus ink may be collected in the ink pad. To prevent ink leakage from the pad, the printer is designed to stop printing when the pad has reached its limit. Whether and how often this is required will vary according to the number of pages you print, the type of material that you print and the number of cleaning cycles that the printer performs. The need for replacement of the pad does not mean that your printer has ceased to operate in accordance with its specifications. The printer will advise you when the pad requires replacing and this can only be performed by an authorised Epson Service provider. The Epson warranty does not cover the cost of this replacement.

### Related Information

- ➔ [“Removing Jammed Paper” on page 168](#)
- ➔ [“Contacting Epson Support” on page 214](#)
- ➔ [“Installing the Latest Applications” on page 162](#)

## Checking the Printer Status - Windows

1. Access the printer driver window.
2. Click **EPSON Status Monitor 3** on the **Maintenance** tab.

### Note:

- You can also check the printer status by double-clicking the printer icon on the taskbar. If the printer icon is not added to the taskbar, click **Monitoring Preferences** on the **Maintenance** tab, and then select **Register the shortcut icon to the taskbar**.
- If **EPSON Status Monitor 3** is disabled, click **Extended Settings** on the **Maintenance** tab, and then select **Enable EPSON Status Monitor 3**.

### Related Information

- ➔ [“Accessing the Printer Driver” on page 79](#)

## Checking the Printer Status - Mac OS

1. Select **System Preferences** from the  menu > **Printers & Scanners** (or **Print & Scan, Print & Fax**), and then select the printer.
2. Click **Options & Supplies** > **Utility** > **Open Printer Utility**.

## Solving Problems

### 3. Click EPSON Status Monitor.

You can check the printer status, ink levels, and error status.

---

## Checking the Software Status

You may be able to clear the problem by updating the software to the latest version. To check the software status, use the software update tool.

### Related Information

- ➔ [“Software Update Tools \(EPSON Software Updater\)” on page 161](#)
- ➔ [“Installing the Latest Applications” on page 162](#)

---

## Removing Jammed Paper

Check the error displayed on the control panel and follow the instructions to remove the jammed paper including any torn pieces. Next, clear the error.



### **Important:**

- Remove the jammed paper carefully. Removing the paper vigorously may cause damage to the printer.
- When removing jammed paper, avoid tilting the printer, placing it vertically, or turning it upside down; otherwise ink may leak.

## Removing Jammed Paper from the Rear Paper Feed

Remove the jammed paper.

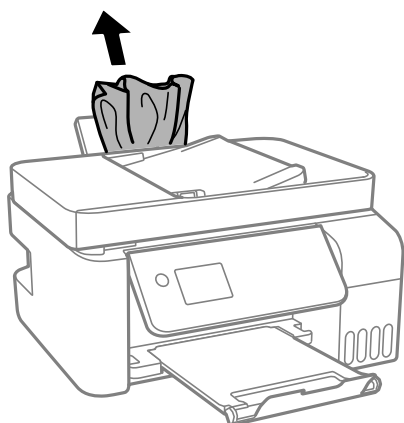



## Removing Jammed Paper from Inside the Printer

 **Caution:**

Never touch the buttons on the control panel while your hand is inside the printer. If the printer starts operating, it could cause an injury. Be careful not to touch the protruding parts to avoid injury.

1. Raise the control panel.

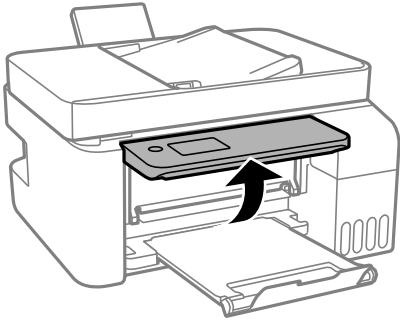

2. Open the inner cover.

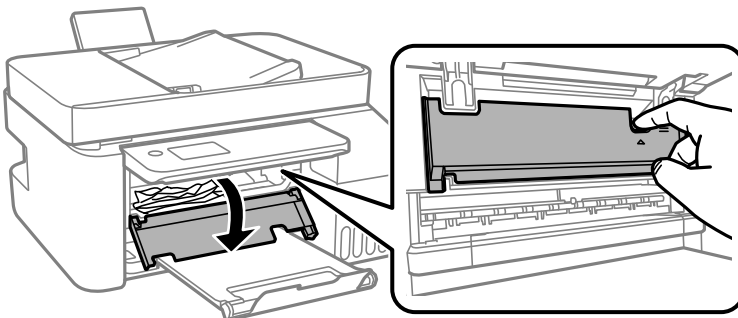

3. Remove the jammed paper.

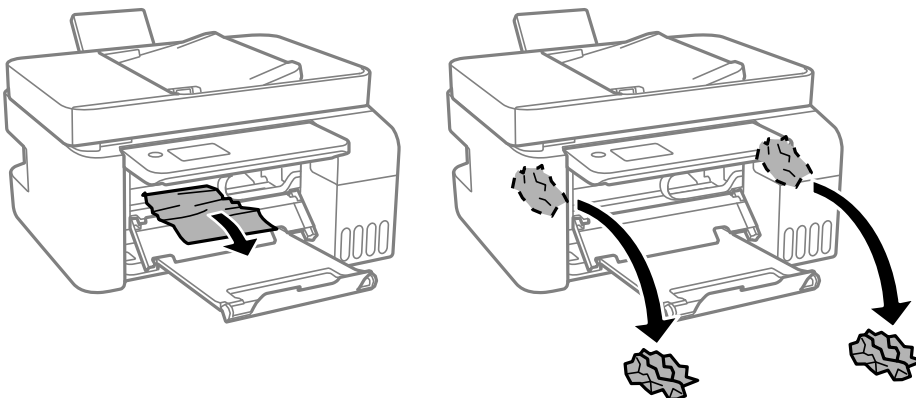

## Solving Problems

**!** *Important:*

*Do not touch the parts shown in the illustration inside the printer. Doing so may cause a malfunction.*

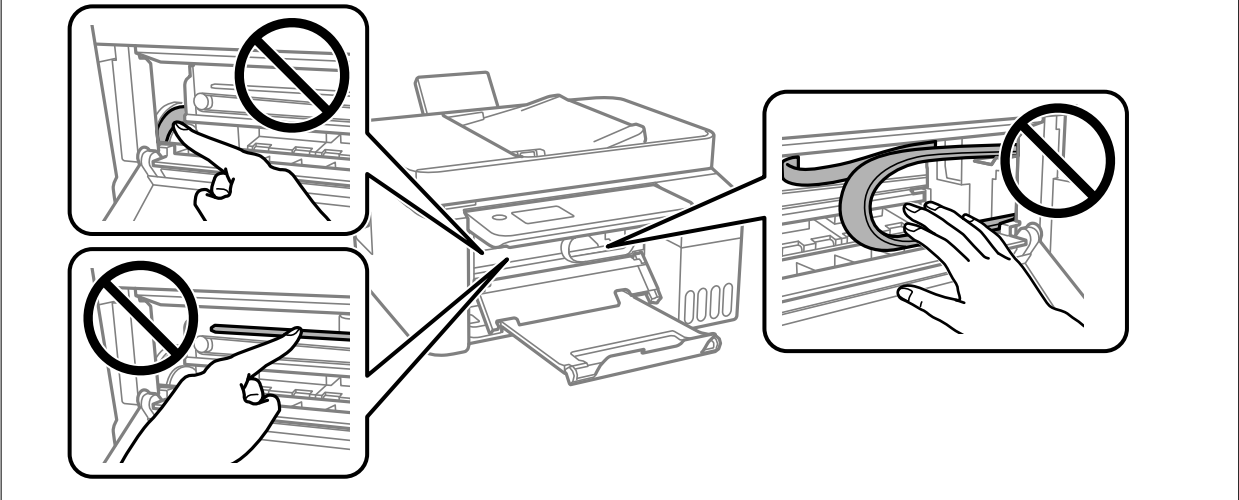

4. Close the inner cover.

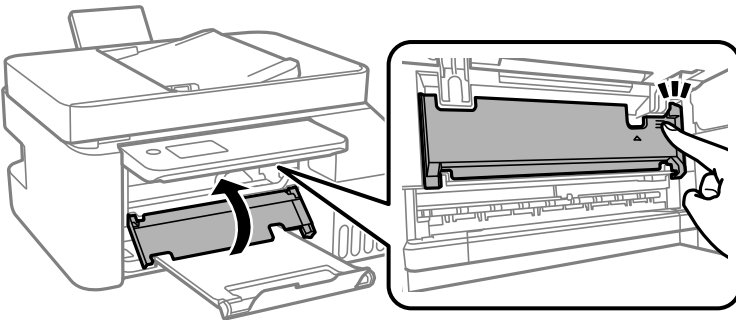

5. Close the control panel.

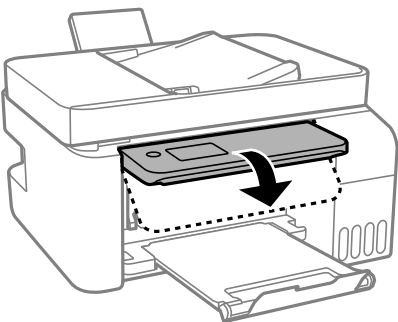

## Removing Jammed Paper from the ADF

1. Open the ADF cover.

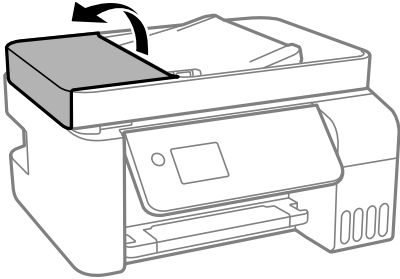

2. Remove the jammed paper.

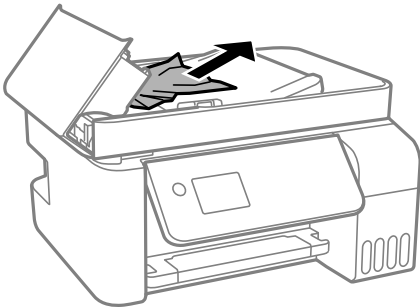

3. Raise the ADF input tray.



**Important:**

*Make sure that you open the ADF cover before raising the ADF input tray. Otherwise, the ADF may be damaged.*

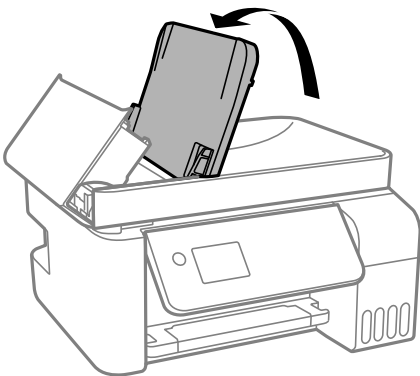

## Solving Problems

4. Remove the jammed paper.

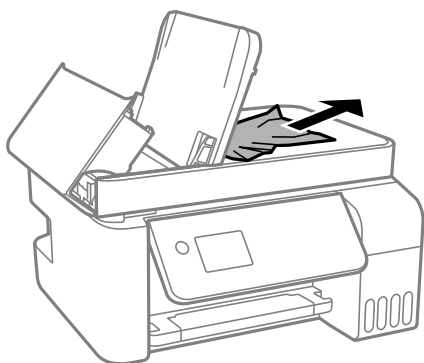

5. Close the ADF cover until it clicks.

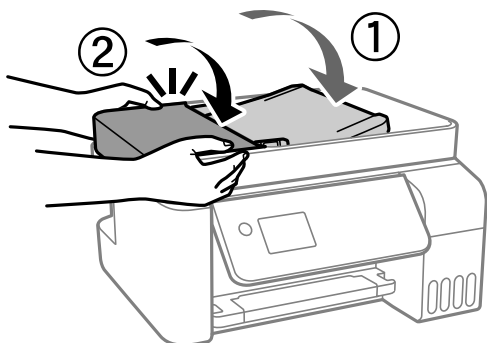

---

## Paper Does Not Feed Correctly

Check the following points, and then take the appropriate actions to solve the problem.

- Place the printer on a flat surface and operate in the recommended environmental conditions.
- Use paper supported by this printer.
- Follow the paper handling precautions.
- Do not load more than the maximum number of sheets specified for the paper. For plain paper, do not load above the line indicated by the triangle symbol on the edge guide.
- Make sure the paper size and paper type settings match the actual paper size and paper type loaded in the printer.

### Related Information

- ➔ [“Environmental Specifications” on page 206](#)
- ➔ [“Paper Handling Precautions” on page 47](#)
- ➔ [“Available Paper and Capacities” on page 45](#)
- ➔ [“List of Paper Type” on page 51](#)

## Paper Jams

- Load paper in the correct direction, and slide the edge guides against the edges of the paper.

## Solving Problems

- Load one sheet of paper at a time if you have loaded several sheets of paper.

### Related Information

- ➔ [“Removing Jammed Paper” on page 168](#)
- ➔ [“Loading Paper in the Rear Paper Feed” on page 48](#)

## Paper Feeds at a Slant

Load paper in the correct direction, and slide the edge guides against the edges of the paper.

### Related Information

- ➔ [“Loading Paper in the Rear Paper Feed” on page 48](#)

## Several Sheets of Paper are Fed at a Time

- Load one sheet of paper at a time.
- When several sheets of paper are fed at a time during manual 2-sided printing, remove any paper which is loaded in the printer before you reload the paper.

## Paper Out Error Occurs

When a paper out error occurs although paper is loaded in the rear paper feed, reload paper in the center of the rear paper feed.

## Original Does Not Feed in the ADF

- Use originals supported by the ADF.
- Load originals in the correct direction, and slide the ADF edge guides against the edges of the originals.
- Clean the inside of the ADF.
- Do not load originals above the line indicated by the triangle symbol on the ADF.

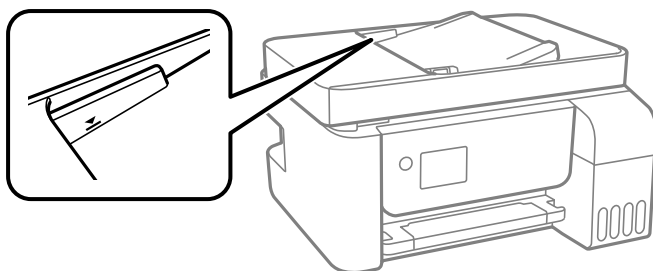

- On the screen for copy, scan, or fax, check that the ADF icon is on. If it is off, place the originals again.



---

## Power and Control Panel Problems

### Power Does Not Turn On

- Make sure the power cord is securely plugged in.
- Hold down the  button for a little longer.

### Power Does Not Turn Off

Hold down the  button for a little longer. If you still cannot turn off the printer, unplug the power cord. To prevent the print head from drying out, turn the printer back on and turn it off by pressing the  button.

### Power Turns Off Automatically

- Select **Power Off Settings** in **Settings**, and then disable the **Power Off If Inactive** and **Power Off If Disconnected** settings.
- Disable the **Power Off Timer** setting in **Settings**.

**Note:**

*Your product may have the **Power Off Settings** or **Power Off Timer** feature depending on the location of purchase.*

### LCD Screen Gets Dark

The printer is in sleep mode. Press any button on the control panel to return the LCD screen to its former state.

---

## Cannot Print from a Computer

### Checking the Connection (USB)

- Connect the USB cable securely to the printer and the computer.
- If you are using a USB hub, try to connect the printer directly to the computer.
- If the USB cable cannot be recognized, change the port, or change the USB cable.

## Solving Problems

- ❑ If the printer cannot print using a USB connection, try the following.

Disconnect the USB cable from the computer. Right-click on the printer icon displayed on the computer, and then select **Remove Device**. Next, connect the USB cable to the computer and try a test print.

Re-set the USB connection by following the steps in this manual for changing the connection method to a computer. See the related information link below for details.

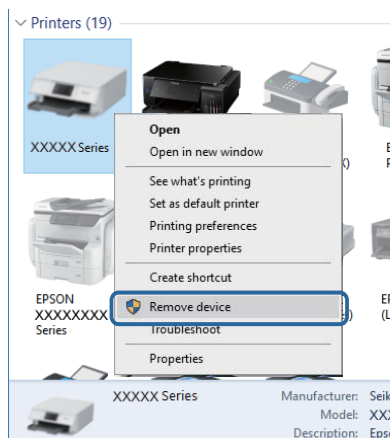

### Related Information

- ➔ [“Changing the Connection Method to a Computer” on page 41](#)

## Checking the Connection (Network)

- ❑ When you have changed your wireless router or provider, try making network settings for the printer again. Connect the computer or smart device to the same SSID as the printer.
- ❑ Turn off the devices you want to connect to the network. Wait for about 10 seconds, and then turn on the devices in the following order; wireless router, computer or smart device, and then printer. Move the printer and computer or smart device closer to the wireless router to help with radio wave communication, and then try to make network settings again.
- ❑ Print the network connection report. See the related information link below for details. If the report shows that the network connection failed, check the network connection report and then follow the printed solutions.
- ❑ If the IP address assigned to the printer is 169.254.XXX.XXX, and the subnet mask is 255.255.0.0, the IP address may not be assigned correctly. Restart the wireless router or reset the network settings for the printer. If this does not solve the problem, see the documentation for the wireless router.
- ❑ Try accessing any website from your computer to make sure that your computer's network settings are correct. If you cannot access any website, there is a problem on the computer. Check the network connection of the computer.

### Related Information

- ➔ [“Connecting to a Computer” on page 21](#)
- ➔ [“Printing a Network Connection Report” on page 34](#)

## Solving Problems

### Checking the Software and Data

- ❑ Make sure that a genuine Epson printer driver is installed. If a genuine Epson printer driver is not installed, the available functions are limited. We recommend using a genuine Epson printer driver. See the related information link below for details.
- ❑ If you are printing a large data size image, the computer may run out of memory. Print the image at a lower resolution or a smaller size.

#### Related Information

- ➔ [“Checking for Genuine Epson Printer Drivers” on page 176](#)
- ➔ [“Installing the Latest Applications” on page 162](#)

### Checking for Genuine Epson Printer Drivers

You can check if a genuine Epson printer driver is installed on your computer by using one of the following methods.

#### Windows

Select **Control Panel > View devices and printers (Printers, Printers and Faxes)**, and then do the following to open the print server properties window.

- ❑ Windows 10/Windows 8.1/Windows 8/Windows 7/Windows Server 2016/Windows Server 2012 R2/Windows Server 2012/Windows Server 2008 R2  
Click the printer icon, and then click **Print server properties** at the top of the window.
- ❑ Windows Vista/Windows Server 2008  
Right-click on the **Printers** folder, and then click **Run as administrator > Server Properties**.
- ❑ Windows XP/Windows Server 2003 R2/Windows Server 2003  
From the **File** menu, select **Server Properties**.



## Solving Problems

Click the **Driver** tab. If your printer name is displayed in the list, a genuine Epson printer driver is installed on your computer.

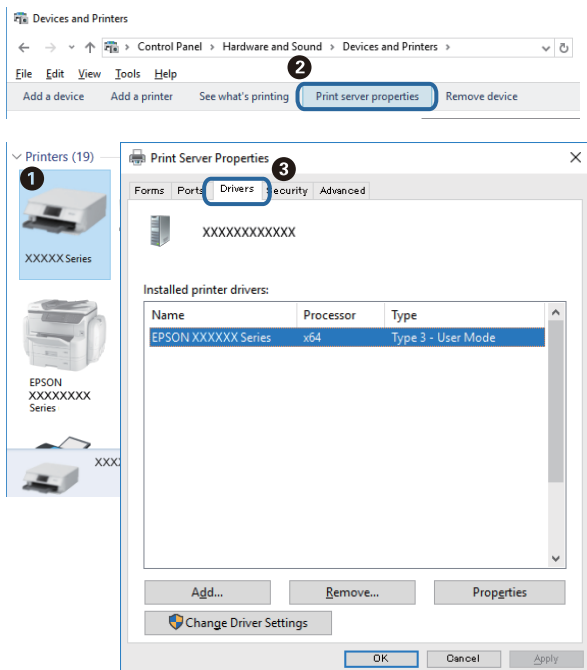

## Mac OS

Select **System Preferences** from the  menu > **Printers & Scanners** (or **Print & Scan**, **Print & Fax**), and then select the printer. Click **Options & Supplies**, and if the **Options** tab and **Utility** tab are displayed on the window, a genuine Epson printer driver is installed on your computer.



## Related Information

➔ [“Installing the Latest Applications” on page 162](#)

## Solving Problems

## Checking the Printer Status from the Computer (Windows)

Click **Print Queue** on the printer driver's **Maintenance** tab, and then check the following.

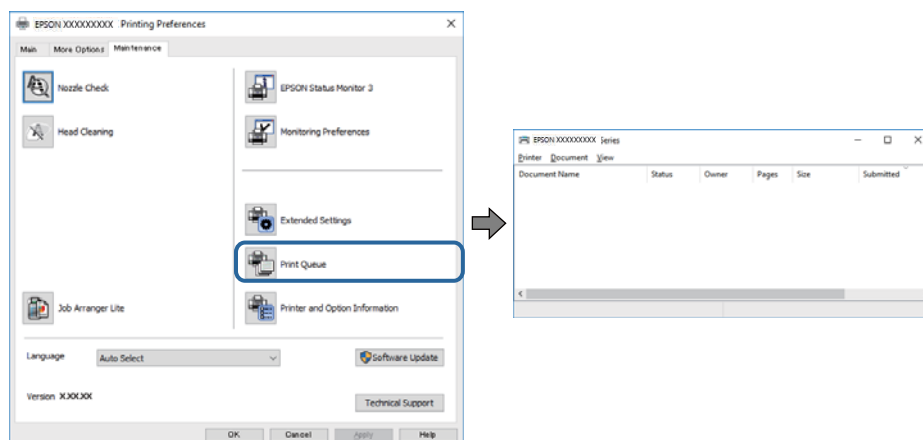

- ❑ Check if there are any paused print jobs.

If unnecessary data remains, select **Cancel all documents** from the **Printer** menu.

- ❑ Make sure the printer is not offline or pending.

If the printer is offline or pending, clear the offline or pending setting from the **Printer** menu.

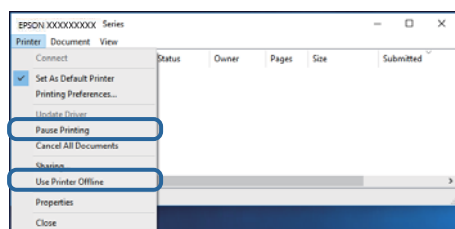

- ❑ Make sure the printer is selected as the default printer from the **Printer** menu (there should be a check mark on the menu item).

If the printer is not selected as the default printer, set it as the default printer. If there are multiple icons in **Control Panel > View devices and printers (Printers, Printers and Faxes)**, see the following to select the icon. Example)

USB connection: EPSON XXXX Series

Network connection: EPSON XXXX Series (network)

If you install the printer driver multiple times, copies of printer driver may be created. If copies such as "EPSON XXXX Series (copy 1)" are created, right-click the copied driver icon, and then click **Remove Device**.

- ❑ Make sure the printer port is selected correctly in **Property > Port** from the **Printer** menu as follows. Select "USBXXX" for a USB connection, or "EpsonNet Print Port" for a network connection.

## Checking the Printer Status from the Computer (Mac OS)

Make sure the printer status is not **Pause**.

Select **System Preferences** from the  menu > **Printers & Scanners** (or **Print & Scan, Print & Fax**), and then double-click the printer. If the printer is paused, click **Resume** (or **Resume Printer**).

## When You Cannot Make Network Settings

- ❑ Turn off the devices you want to connect to the network. Wait for about 10 seconds, and then turn on the devices in the following order; wireless router, computer or smart device, and then printer. Move the printer and computer or smart device closer to the wireless router to help with radio wave communication, and then try to make network settings again.
- ❑ Select **Settings > Network Settings > Connection Check**, and then print the network connection report. If an error has occurred, check the network connection report and then follow the printed solutions.

### Related Information

- ➔ [“Printing a Network Connection Report” on page 34](#)
- ➔ [“Messages and Solutions on the Network Connection Report” on page 35](#)

## Cannot Connect from Devices Even Though Network Settings are No Problems

If you cannot connect from the computer or smart device to the printer even though the network connection report does not show any problems, see the following.

- ❑ When you are using multiple wireless routers at the same time, you may not be able to use the printer from the computer or smart device depending on the settings of the wireless routers. Connect the computer or smart device to the same wireless router as the printer.

Disable the tethering function on the smart device if it is enabled.

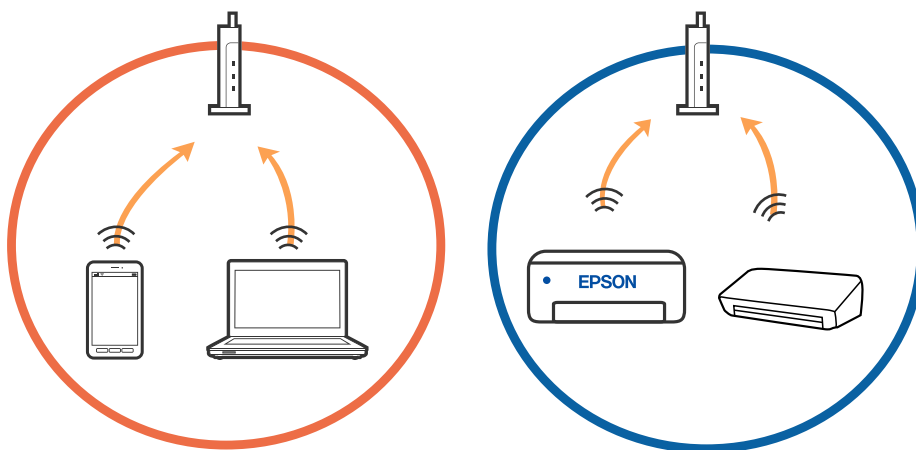

### Solving Problems

- ❑ You may not be able to connect to the wireless router when the wireless router has multiple SSIDs and devices are connected to different SSIDs on the same wireless router. Connect the computer or smart device to the same SSID as the printer.

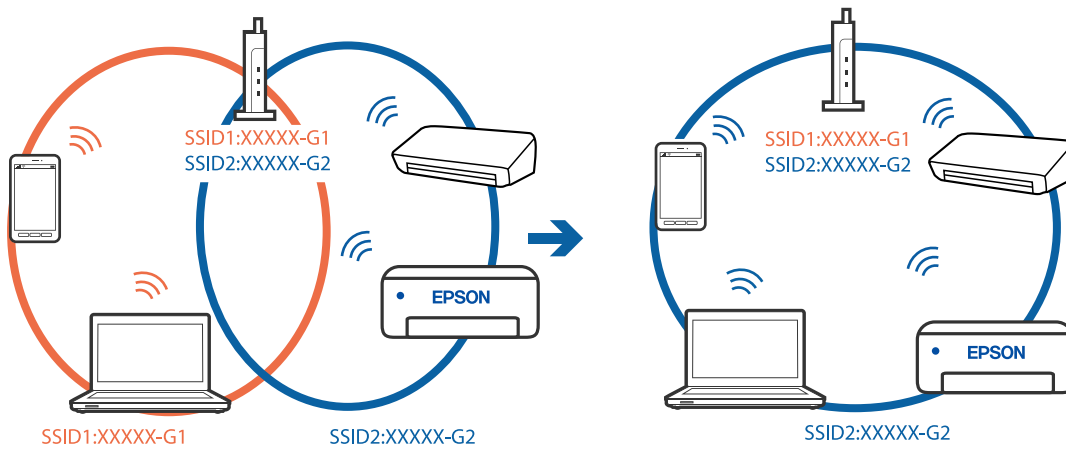

- ❑ A wireless router that is compliant with both IEEE802.11a and IEEE802.11g has SSIDs of 2.4 GHz and 5 GHz. If you connect the computer or smart device to a 5 GHz SSID, you cannot connect to the printer because the printer only supports communication over 2.4 GHz. Connect the computer or smart device to the same SSID as the printer.

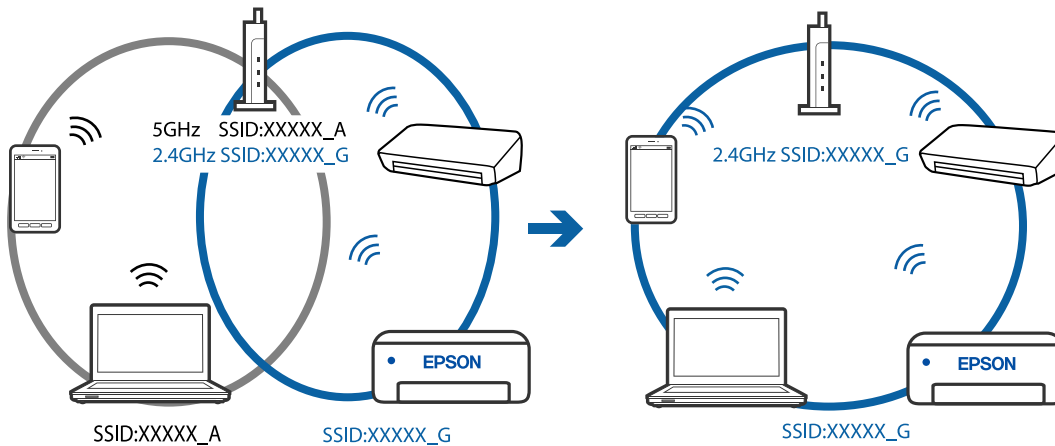

- ❑ Most wireless routers have a privacy separator feature that blocks communication between connected devices. If you cannot communicate between the printer and the computer or smart device even if they are connected to the same network, disable the privacy separator on the wireless router. See the manual provided with the wireless router for details.

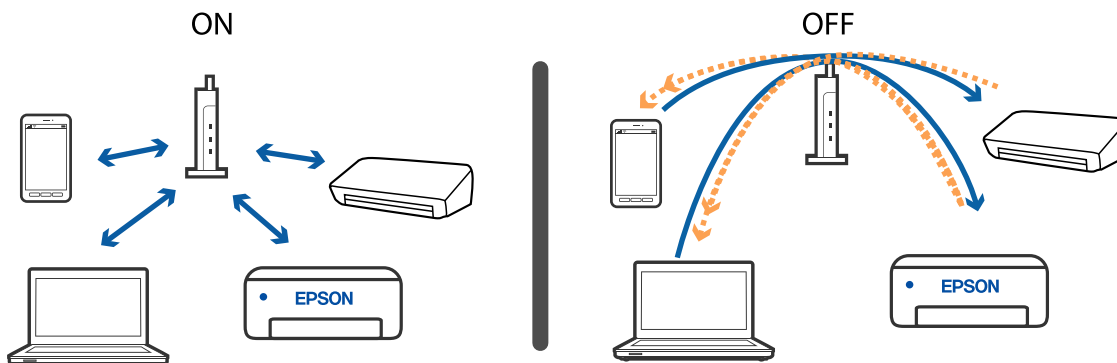

## Solving Problems

### Related Information

- ➔ [“Checking the SSID Connected to the Printer” on page 181](#)
- ➔ [“Checking the SSID for the Computer” on page 181](#)

## Checking the SSID Connected to the Printer

You can check the SSID by printing a network connection report, network status sheet, or on Web Config.

### Related Information

- ➔ [“Printing a Network Connection Report” on page 34](#)
- ➔ [“Printing a Network Status Sheet” on page 40](#)

## Checking the SSID for the Computer

### Windows

Click  in the task tray on the desktop. Check the name of the connected SSID from the list displayed.



## Solving Problems

### Mac OS

Click the Wi-Fi icon at the top of the computer screen. A list of SSIDs is displayed and the connected SSID is indicated with a check mark.



### Ethernet Connection Becomes Unstable

When you connect the printer by Ethernet using devices that support IEEE802.3az (Energy Efficient Ethernet), the following problems may occur depending on the hub or router that you are using.

- Connection becomes unstable, the printer is connected and disconnected again and again.
- Cannot connect to the printer.
- The communication speed becomes slow.

Follow the steps below to disable IEEE802.3az for the printer and then connect.

1. Remove the Ethernet cable connected to the computer and the printer.
2. When IEEE802.3az for the computer is enabled, disable it.  
See the documentation provided with the computer for details.
3. Connect the computer and the printer with an Ethernet cable directly.
4. On the printer, print a network connection report.
5. Check the printer's IP address on the network connection report.
6. On the computer, access Web Config.  
Launch a Web browser, and then enter the printer's IP address.
7. Select **Advanced Settings** from the list at the top right of the window.
8. Select **Network Settings > Wired LAN**.
9. Select **OFF** for **IEEE 802.3az**.
10. Click **Next**.

## Solving Problems

11. Click **OK**.
12. Remove the Ethernet cable connected to the computer and the printer.
13. If you disabled IEEE802.3az for the computer in step 2, enable it.
14. Connect the Ethernet cables that you removed in step 1 to the computer and the printer.

If the problem still occurs, devices other than the printer may be causing the problem.

### Related Information

- ➔ [“Printing a Network Connection Report” on page 34](#)
- ➔ [“Running Web Config on a Web Browser” on page 155](#)

---

## Cannot Print from an iPhone or iPad

- Connect the iPhone or iPad to the same network (SSID) as the printer.
- Enable **Paper Setup Auto Display** in the following menus.  
**Settings > Printer Setup > Paper Source Settings > Paper Setup Auto Display**
- Enable the AirPrint setting on Web Config.

### Related Information

- ➔ [“Connecting to a Smart Device” on page 22](#)
- ➔ [“Application for Configuring Printer Operations \(Web Config\)” on page 155](#)

---

## Printout Problems

### Printout is Scuffed or Color is Missing

- If you have not used the printer for a long time, the print head nozzles may be clogged and ink drops may not be discharged. Perform a nozzle check, and then clean the print head if any of the print head nozzles are clogged.
- If you printed when the ink levels were too low to be seen in the ink tank windows, refill the ink tanks to the upper lines and then use the **Power Cleaning** utility to replace the ink inside the ink tubes. After you use the utility, perform a nozzle check to see if print quality has improved.

### Related Information

- ➔ [“Checking and Cleaning the Print Head” on page 146](#)
- ➔ [“Refilling the Ink Tanks” on page 141](#)
- ➔ [“Running Power Cleaning” on page 148](#)

## Banding or Unexpected Colors Appear

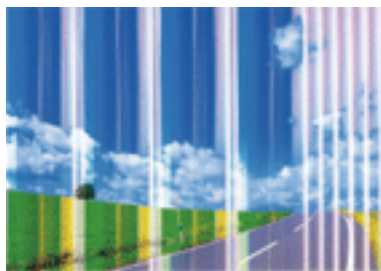

The print head nozzles may be clogged. Perform a nozzle check to check if the print head nozzles are clogged. Clean the print head if any of the print head nozzles are clogged.

### Related Information

➔ [“Checking and Cleaning the Print Head” on page 146](#)

## Colored Banding Appears at Intervals of Approximately 2.5 cm

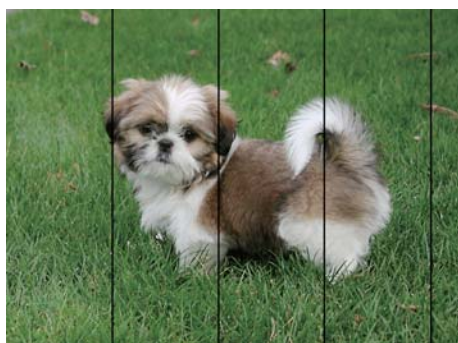

- Select the appropriate paper type setting for the type of paper loaded in the printer.
- Align the print head.
- When printing on plain paper, print using a higher quality setting.

### Related Information

➔ [“Aligning the Print Head” on page 149](#)

## Blurry Prints, Vertical Banding, or Misalignment



enthalten alle  
 1. Ausdruck. W  
 ↓ 5008 "Regel



## Solving Problems

Align the print head using the **Vertical Alignment** feature.

### Related Information

➔ [“Aligning the Print Head” on page 149](#)

## Print Quality Does Not Improve Even After Aligning the Print Head

During bidirectional (or high speed) printing, the print head prints while moving in both directions, and vertical lines may be misaligned. If print quality does not improve, disable the bidirectional (or high speed) setting. Disabling this setting may slow down printing speed.

### Windows

Clear **High Speed** on the printer driver's **More Options** tab.

### Mac OS

Select **System Preferences** from the  menu > **Printers & Scanners** (or **Print & Scan**, **Print & Fax**), and then select the printer. Click **Options & Supplies** > **Options** (or **Driver**). Select **Off** as the **High Speed Printing** setting.

## Print Quality is Poor

Check the following if the print quality is poor due to blurry prints, banding, missing colors, faded colors, and misalignment in the prints.

### Checking the printer

- Make sure the initial ink charging is complete.
- Refill the ink tank if the ink level is below the lower line.
- Perform a nozzle check, and then clean the print head if any of the print head nozzles are clogged.
- Align the print head.

### Checking the paper

- Use paper supported by this printer.
- Do not print on paper that is damp, damaged, or too old.
- If the paper is curled or the envelope is puffed up, flatten it.
- Do not stack the paper immediately after printing.
- Dry the printouts completely before filing or displaying them. When drying the printouts, avoid direct sun light, do not use a dryer, and do not touch the printed side of paper.
- When printing images or photos, Epson recommends using genuine Epson paper rather than plain paper. Print on the printable side of the genuine Epson paper.

### Checking the print settings

- Select the appropriate paper type setting for the type of paper loaded in the printer.
- Print using a higher quality setting.

## Solving Problems

### Checking the ink bottle

- Use ink bottles with the correct part code for this printer.
- Epson recommends using the ink bottle before the date printed on the package.
- Try to use genuine Epson ink bottles. This product is designed to adjust colors based on the use of genuine Epson ink bottles. The use of non-genuine ink bottles may cause print quality to decline.

### Related Information

- ➔ [“Checking and Cleaning the Print Head” on page 146](#)
- ➔ [“Aligning the Print Head” on page 149](#)
- ➔ [“Available Paper and Capacities” on page 45](#)
- ➔ [“List of Paper Type” on page 51](#)
- ➔ [“Paper Handling Precautions” on page 47](#)

## Paper Is Smearred or Scuffed

- When horizontal banding appears or the top or bottom of the paper is smearred, load paper in the correct direction and slide the edge guides to the edges of the paper.

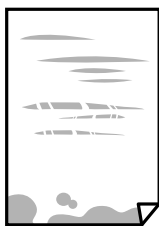

- When vertical banding appears or the paper is smearred, clean the paper path.



- Place the paper on a flat surface to check if it is curled. If it is, flatten it.
- When performing manual 2-sided printing, make sure that the ink is completely dry before reloading the paper.

### Related Information

- ➔ [“Loading Paper in the Rear Paper Feed” on page 48](#)
- ➔ [“Cleaning the Paper Path for Ink Smears” on page 150](#)

## Printed Photos are Sticky

You may be printing on the wrong side of the photo paper. Make sure you are printing on the printable side.

## Solving Problems

When printing on the wrong side of the photo paper, you need to clean the paper path.

### Related Information

➔ [“Cleaning the Paper Path for Ink Smears” on page 150](#)

## Images or Photos are Printed in Unexpected Colors

When printing from the Windows printer driver, the Epson auto photo adjustment setting is applied by default depending on the paper type. Try change the setting.

On the **More Options** tab, select **Custom** in **Color Correction**, and then click **Advanced**. Change the **Scene Correction** setting from **Auto Correct** to any other option. If changing the setting does not work, use any color correction method other than **PhotoEnhance** in **Color Management**.

### Related Information

➔ [“Adjusting the Print Color” on page 93](#)

## Cannot Print Without Margins

Make borderless setting in the print settings. If you select a paper type that does not support borderless printing, you cannot select **Borderless**. Select a paper type that supports borderless printing.

## Edges of the Image are Cropped During Borderless Printing

During borderless printing, the image is slightly enlarged and the protruding area is cropped. Select a smaller enlargement setting.

Control panel

Change the **Expansion** setting.

Windows

Click **Settings** next to the **Borderless** checkbox on the printer driver's **Main** tab, and then change the settings.

Mac OS

Change the **Expansion** setting from the print dialog's **Print Settings** menu.

## The Position, Size, or Margins of the Printout Are Incorrect

Load paper in the correct direction, and slide the edge guides against the edges of the paper.

When placing the originals on the scanner glass, align the corner of the original with the corner indicated by a symbol on the frame of the scanner glass. If the edges of the copy are cropped off, move the original slightly away from the corner.

When placing the originals on the scanner glass, clean the scanner glass and the document cover. If there is dust or stains on the glass, the copy area may extend to include the dust or stains, resulting in the wrong copying position or small images.

Select the appropriate **Original Size** in the copy settings.

Select the appropriate paper size setting.

## Solving Problems

- Adjust the margin setting in the application so that it falls within the printable area.

### Related Information

- ➔ [“Loading Paper in the Rear Paper Feed” on page 48](#)
- ➔ [“Placing Originals on the Scanner Glass” on page 53](#)
- ➔ [“Cleaning the Scanner Glass” on page 152](#)
- ➔ [“Printable Area” on page 201](#)

## Printed Characters Are Incorrect or Garbled

- Connect the USB cable securely to the printer and the computer.
- Cancel any paused print jobs.
- Do not put the computer manually into the **Hibernate** mode or the **Sleep** mode while printing. Pages of garbled text may be printed next time you start the computer.
- If you use the printer driver you had previously used, printed characters may be garbled. Make sure that the printer driver you are using is for this printer. Check the printer name on the top of the printer driver window.

## The Printed Image Is Inverted

Clear any mirror image settings in the printer driver or the application.

- Windows  
Clear **Mirror Image** on the printer driver's **More Options** tab.
- Mac OS  
Clear **Mirror Image** from the print dialog's **Print Settings** menu.

## Mosaic-Like Patterns in the Prints

When printing images or photos, print using high-resolution data. Images on websites are often low resolution although they look good enough on the display, and so print quality may decline.

## Uneven Colors, Smears, Dots, or Straight Lines Appear in the Copied Image

- Clean the paper path.
- Clean the scanner glass.
- Clean the ADF.
- Do not press too hard on the original or the document cover when you are placing the originals on the scanner glass.
- When the paper is smeared, lower the copy density setting.

**Related Information**

- ➔ [“Cleaning the Paper Path for Ink Smears” on page 150](#)
- ➔ [“Cleaning the Scanner Glass” on page 152](#)

**Moiré (Cross-Hatch) Patterns Appear in the Copied Image**

Change the reduce and enlarge setting or place the original at a slightly different angle.

**An Image of the Reverse Side of the Original Appears in the Copied Image**

- For a thin original, place the original on the scanner glass and then place a piece of black paper over it.
- Lower the copy density setting on the control panel.

**Banding Appears when Copying from the ADF**

Depending on the original, banding may appear when copying from the ADF.

- Copy from the scanner glass.
- Copy using a higher quality setting.

**The Printout Problem Could Not be Cleared**

If you have tried all of the solutions and have not solved the problem, try uninstalling and then reinstalling the printer driver.

**Related Information**

- ➔ [“Uninstalling Applications” on page 163](#)
- ➔ [“Installing the Latest Applications” on page 162](#)

---

**Other Printing Problems****Printing Is Too Slow**

- Close any unnecessary applications.
- Lower the quality setting. High quality printing slows down the printing speed.

## Solving Problems

- Enable the bidirectional (or high speed) setting. When this setting is enabled, the print head prints while moving in both directions, and the printing speed increases.
  - Windows
 

Select **High Speed** on the printer driver's **More Options** tab.
  - Mac OS
 

Select **System Preferences** from the  menu > **Printers & Scanners** (or **Print & Scan, Print & Fax**), and then select the printer. Click **Options & Supplies > Options** (or **Driver**). Select **On** as the **High Speed Printing** setting.
- Disable quiet mode. This feature slows down the printing speed.
  - Control Panel
 

Select  on the home screen, and then disable **Quiet Mode**.
  - Windows
 

Select **Off** as the **Quiet Mode** setting on the printer driver's **Main** tab.
  - Mac OS
 

Select **System Preferences** from the  menu > **Printers & Scanners** (or **Print & Scan, Print & Fax**), and then select the printer. Click **Options & Supplies > Options** (or **Driver**). Select **Off** as the **Quiet Mode** setting.

## Printing or Copying Slows Down Dramatically During Continuous Operation

Printing or Copying slows down to prevent the printer mechanism from overheating and being damaged. However, you can continue operation. To return to normal speed, leave the printer idle for at least 30 minutes. The speed does not return to normal if the power is off.

---

## Cannot Start Scanning

- If you are scanning with the ADF, check that the document cover and ADF cover are closed.
- Connect the USB cable securely to the printer and the computer. If you are using a USB hub, try to connect the printer directly to the computer.
- If you scan at a high resolution over a network, a communication error may occur. Lower the resolution.
- Make sure that the correct printer (scanner) is selected on Epson Scan 2.

### Check whether or not the printer is recognized when using Windows

In Windows, make sure the printer (scanner) is displayed in **Scanner and Camera**. The printer (scanner) should be displayed as "EPSON XXXXX (printer name)". If the printer (scanner) is not displayed, uninstall and then re-install Epson Scan 2. See the following to access **Scanner and Camera**.

- Windows 10
 

Click on the start button, and then select **Windows System > Control Panel**, enter "Scanner and Camera" in the search charm, click **View scanners and cameras**, and then check if the printer is displayed.

## Solving Problems

- ❑ Windows 8.1/Windows 8/Windows Server 2012 R2/Windows Server 2012  
Select **Desktop > Settings > Control Panel**, enter "Scanner and Camera" in the search charm, click **Show Scanner and Camera**, and then check if the printer is displayed.
- ❑ Windows 7/Windows Server 2008 R2  
Click the start button and select **Control Panel**, enter "Scanner and Camera" in the search charm, click **View scanners and cameras**, and then check if the printer is displayed.
- ❑ Windows Vista/Windows Server 2008  
Click the start button, select **Control Panel > Hardware and Sound > Scanners and Cameras**, and then check if the printer is displayed.
- ❑ Windows XP/Windows Server 2003 R2/Windows Server 2003  
Click the start button, select **Control Panel > Printers and Other Hardware > Scanner and Cameras**, and then check if the printer is displayed.

### Related Information

- ➔ ["Uninstalling Applications" on page 163](#)
- ➔ ["Installing the Latest Applications" on page 162](#)

## Cannot Start Scanning when Using the Control Panel

- ❑ Make sure Epson Scan 2 and Epson Event Manager are installed correctly.
- ❑ Check the scanning setting assigned in Epson Event Manager.

### Related Information

- ➔ ["Application for Scanning Documents and Images \(Epson Scan 2\)" on page 156](#)
- ➔ ["Application for Configuring Scanning Operations from the Control Panel \(Epson Event Manager\)" on page 157](#)

---

## Scanned Image Problems

### Uneven Colors, Dirt, Spots, and so on Appear when Scanning from the Scanner Glass

- ❑ Clean the scanner glass.
- ❑ Remove any trash or dirt that adheres to the original.
- ❑ Do not press with too much force on the original or the document cover. If you press with too much force, blurring, smudges, and spots may occur.

### Related Information

- ➔ ["Cleaning the Scanner Glass" on page 152](#)

## Solving Problems

### Straight Lines Appear when Scanning from ADF

- Clean the ADF.

Straight lines may appear in the image when trash or dirt gets into the ADF.

- Remove any trash or dirt that adheres to the original.

### The Image Quality Is Rough

- In Epson Scan 2, adjust the image using items on the **Advanced Settings** tab, and then scan.
- If the resolution is low, try increasing the resolution and then scanning.

#### Related Information

- ➔ [“Scanning Using Epson Scan 2” on page 116](#)

### Offset Appears in the Background of Images

Images on the back of the original may appear in the scanned image.

- In Epson Scan 2, select the **Advanced Settings** tab, and then adjust the **Brightness**.

This feature may not be available depending on the settings on the **Main Settings** tab > **Image Type** or other settings on the **Advanced Settings** tab.

- In Epson Scan 2, select the **Advanced Settings** tab, and then **Image Option** > **Text Enhancement**.
- When scanning from the scanner glass, place black paper or a desk pad over the original.

#### Related Information

- ➔ [“Placing Originals on the Scanner Glass” on page 53](#)
- ➔ [“Scanning Using Epson Scan 2” on page 116](#)

### Text is Blurred

- In Epson Scan 2, select the **Advanced Settings** tab, and then **Image Option** > **Text Enhancement**.
- In Epson Scan 2, when **Image Type** on the **Main Settings** tab is set to **Black & White**, adjust the **Threshold** on the **Advanced Settings** tab. When you increase the **Threshold**, black becomes stronger.
- If the resolution is low, try increasing the resolution and then scanning.

#### Related Information

- ➔ [“Scanning Using Epson Scan 2” on page 116](#)

### Moiré Patterns (Web-Like Shadows) Appear

If the original is a printed document, moiré patterns (web-like shadows) may appear in the scanned image.



## Solving Problems

- ❑ On the **Advanced Settings** tab in Epson Scan 2, set **Descreening**.



- ❑ Change the resolution, and then scan again.

### Related Information

- ➔ [“Scanning Using Epson Scan 2” on page 116](#)

## Cannot Scan the Correct Area on the Scanner Glass

- ❑ Make sure the original is placed correctly against the alignment marks.
- ❑ If the edge of the scanned image is missing, move the original slightly away from the edge of the scanner glass.
- ❑ When scanning from the control panel and selecting the auto scan area cropping function, remove any trash or dirt from the scanner glass and document cover. If there is any trash or dirt around the original, the scanning range expands to include it.

### Related Information

- ➔ [“Placing Originals on the Scanner Glass” on page 53](#)

## Text is Not Recognized Correctly when Saving as a Searchable PDF

- ❑ On the **Image Format Options** window in Epson Scan 2, check that **Text Language** is set correctly on the **Text** tab.
- ❑ Check that the original is placed straight.
- ❑ Use an original with clear text. Text recognition may decline for the following types of originals.
  - ❑ Originals that have been copied a number of times
  - ❑ Originals received by fax (at low resolutions)
  - ❑ Originals on which the letter spacing or line spacing is too small
  - ❑ Originals with ruled lines or underlining over the text
  - ❑ Originals with hand-written text
  - ❑ Originals with creases or wrinkles
- ❑ In Epson Scan 2, when **Image Type** on the **Main Settings** tab is set to **Black & White**, adjust the **Threshold** on the **Advanced Settings** tab. When you increase the **Threshold**, the black color area becomes larger.
- ❑ In Epson Scan 2, select the **Advanced Settings** tab, and then **Image Option > Text Enhancement**.

### Related Information

- ➔ [“Scanning Using Epson Scan 2” on page 116](#)

## Cannot Solve Problems in the Scanned Image

If you have tried all of the solutions and have not solved the problem, initialize the Epson Scan 2 settings using Epson Scan 2 Utility.

**Note:**

*Epson Scan 2 Utility is an application that comes with Epson Scan 2.*

1. Start Epson Scan 2 Utility.
  - Windows 10/Windows Server 2016  
Click the start button, and then select **EPSON > Epson Scan 2 Utility**.
  - Windows 8.1/Windows 8/Windows Server 2012 R2/Windows Server 2012  
Enter the application name in the search charm, and then select the displayed icon.
  - Windows 7/Windows Vista/Windows XP/Windows Server 2008 R2/Windows Server 2008/Windows Server 2003 R2/Windows Server 2003  
Click the start button, and then select **All Programs** or **Programs > EPSON > Epson Scan 2 > Epson Scan 2 Utility**.
  - Mac OS  
Select **Go > Applications > Epson Software > Epson Scan 2 Utility**.
2. Select the **Other** tab.
3. Click **Reset**.

**Note:**

*If initialization does not solve the problem, uninstall and re-install Epson Scan 2.*

### Related Information

- ➔ [“Uninstalling Applications” on page 163](#)
- ➔ [“Installing the Latest Applications” on page 162](#)

---

## Other Scanning Problems

### Scanning Is Too Slow

Lower the resolution.

### Related Information

- ➔ [“Scanning Using Epson Scan 2” on page 116](#)

### Scanning Slows Down Dramatically During Continuous Scanning

Scanning slows down to prevent the printer mechanism from overheating and being damaged. However, you can continue scanning. To return to normal scanning speed, leave the printer idle for at least 30 minutes. Scanning speed does not return to normal if the power is off.

## Scanning Stops when Scanning to PDF/Multi-TIFF

- ❑ When scanning using Epson Scan 2, you can continuously scan up to 999 pages in PDF format and up to 200 pages in Multi-TIFF format.
- ❑ When scanning large volumes, we recommend scanning in grayscale.
- ❑ Increase the free space on the computer's hard disk. Scanning may stop if there is not enough free space.
- ❑ Try scanning at a lower resolution. Scanning stops if the total data size reaches the limit.

### Related Information

- ➔ [“Scanning Using Epson Scan 2” on page 116](#)

---

## Problems when Sending and Receiving Faxes



### Related Information

- ➔ [“Cannot Send or Receive Faxes” on page 195](#)
- ➔ [“Cannot Send Faxes” on page 196](#)
- ➔ [“Cannot Send Faxes to a Specific Recipient” on page 197](#)
- ➔ [“Cannot Send Faxes at a Specified Time” on page 197](#)
- ➔ [“Cannot Receive Faxes” on page 197](#)
- ➔ [“Sent Fax Quality Is Poor” on page 198](#)
- ➔ [“Faxes Are Sent at the Wrong Size” on page 198](#)
- ➔ [“Received Fax Quality Is Poor” on page 198](#)
- ➔ [“Received Faxes Are Not Printed” on page 198](#)

## Cannot Send or Receive Faxes

- ❑ Use **Check Fax Connection** on the control panel to run the automatic fax connection check. Try the solutions printed on the report.
- ❑ Check the **Line Type** setting. Setting to **PBX** may solve the problem. If your phone system requires an external access code to get an outside line, register the access code to the printer, and enter # (hash) at the beginning of a fax number when sending.
- ❑ If a communication error occurs, change the **Fax Speed** setting to **Slow(9,600bps)** on the control panel.
- ❑ Check that the telephone wall jack works by connecting a phone to it and testing it. If you cannot make or receive calls, contact your telecommunication company.
- ❑ To connect to a DSL phone line, you need to use a DSL modem equipped with a built-in DSL filter, or install a separate DSL filter to the line. Contact your DSL provider.
- ❑ If you are connecting to a DSL phone line, connect the printer directly to a telephone wall jack to see if the printer can send a fax. If it works, the problem may be caused by the DSL filter. Contact your DSL provider.
- ❑ Enable the **ECM** setting on the control panel. Color faxes cannot be sent or received when **ECM** is off.
- ❑ To send or receive faxes using the computer, make sure that the printer is connected using a USB cable or a network, and that the PC-FAX Driver have been installed on the computer. The PC-FAX Driver is installed together with FAX Utility.

## Solving Problems

- ❑ In Windows, make sure the printer (fax) is displayed in **Devices and Printers**, **Printer**, or **Printers and Other Hardware**. The printer (fax) is displayed as "EPSON XXXXX (FAX)". If the printer (fax) is not displayed, uninstall and then re-install the FAX Utility. See the following to access **Devices and Printers**, **Printer**, or **Printers and Other Hardware**.
  - ❑ Windows 10/Windows Server 2016
    - Click on the start button, and then select **Windows System > Control Panel > View devices and printers in Hardware and Sound**.
  - ❑ Windows 8.1/Windows 8
    - Select **Desktop > Settings > Control Panel > View devices and printers in Hardware and Sound or Hardware**.
  - ❑ Windows 7
    - Click the start button, and select **Control Panel > View devices and printers in Hardware and Sound or Hardware**.
  - ❑ Windows Vista
    - Click the start button, and select **Control Panel > Printers in Hardware and Sound**.
  - ❑ Windows XP
    - Click the start button, and select **Settings > Control Panel > Printers and Other Hardware > Printers and Faxes**.
- ❑ In Mac OS, check the following.
  - ❑ Select **System Preferences** from the  menu > **Printers & Scanners** (or **Print & Scan**, **Print & Fax**), and then make sure the printer (fax) is displayed. The printer (fax) is displayed as "FAX XXXX (USB)" or "FAX XXXX (IP)". If the printer (fax) is not displayed, click [+] and then register the printer (fax).
  - ❑ Select **System Preferences** from the  menu > **Printers & Scanners** (or **Print & Scan**, **Print & Fax**), and then double-click the printer (fax). If the printer is paused, click **Resume** (or **Resume Printer**).

### Related Information

- ➔ [“Connecting to a Phone Line” on page 65](#)
- ➔ [“Basic Settings Menu” on page 75](#)
- ➔ [“Uninstalling Applications” on page 163](#)
- ➔ [“Installing the Latest Applications” on page 162](#)

## Cannot Send Faxes

- ❑ Set up the header information for outgoing faxes on the control panel. Some fax machines automatically reject incoming faxes that do not include header information.
- ❑ If you have blocked your caller ID, unblock it. Some phones or fax machines automatically reject anonymous calls.
- ❑ Ask the recipient if the fax number is correct and the recipient's fax machine is ready to receive a fax.

### Related Information

- ➔ [“Cannot Send or Receive Faxes” on page 195](#)

## Solving Problems

### Cannot Send Faxes to a Specific Recipient

Check the following if you cannot send faxes to a specific recipient due to an error.

- If the recipient machine does not pick up your call within 50 seconds after the printer has finished dialing, the call ends with an error. Dial using a connected telephone to check how long it takes before you hear a fax tone. If it takes more than 50 seconds, add pauses after the fax number to send the fax. A hyphen is entered as the pause mark. One pause is about three seconds. Add multiple pauses as needed.
- If you have selected the recipient from the contacts list, verify that the registered information is correct. If the information is correct, select the recipient in **Contacts Manager > Edit**, and then change **Communication Mode** to **Slow(9,600bps)**.

#### Related Information

- ➔ [“Sending Faxes Dialing from the External Phone Device” on page 123](#)
- ➔ [“Managing Contacts” on page 55](#)
- ➔ [“Cannot Send or Receive Faxes” on page 195](#)

### Cannot Send Faxes at a Specified Time

Set the date and the time correctly on the control panel.

#### Related Information

- ➔ [“Sending Faxes in Monochrome at a Specified Time \(Send Fax Later\)” on page 124](#)
- ➔ [“Basic Settings Menu” on page 75](#)

### Cannot Receive Faxes

- If you have subscribed to a call forwarding service, the printer may not be able to receive faxes. Contact the service provider.
- If you have not connected a telephone to the printer, set the **Receive Mode** setting to **Auto** on the control panel.
- Under the following conditions, the printer runs out of memory and cannot receive faxes. See the troubleshooting for information on handling a memory full error.
  - The number of received documents has reached the maximum of 100 documents.
  - The printer's memory is full (100%).
- Check if the sender's fax number has been registered to the **Rejection Number List**. Faxes sent from numbers that have been added to this list are blocked when **Rejection Number List** in **Rejection Fax** is enabled.
- Ask the sender if header information is set up on their fax machine. Faxes that do not include header information are blocked when **Fax Header Blank** in **Rejection Fax** is enabled.
- Check if the sender's fax number is registered in the contacts list. Faxes sent from numbers that have not been registered to this list are blocked when **Caller not in Contacts** in **Rejection Fax** is enabled.

#### Related Information

- ➔ [“Cannot Send or Receive Faxes” on page 195](#)

## Solving Problems

### Sent Fax Quality Is Poor

- Clean the scanner glass.
- Clean the ADF.
- Change the **Density** setting on the control panel.
- If you are not sure about the capabilities of the recipient fax machine, enable the **Direct Send** feature or select **Fine** as the **Resolution** setting.
- Enable the **ECM** setting on the control panel.

#### Related Information

- ➔ [“Fax Send Settings” on page 129](#)
- ➔ [“Cleaning the Scanner Glass” on page 152](#)
- ➔ [“Cleaning the ADF” on page 150](#)

### Faxes Are Sent at the Wrong Size

- When sending a fax using the scanner glass, place the original correctly aligning its corner with the origin mark. Select your original size on the control panel.
- Clean the scanner glass and the document cover. If there is dust or stains on the glass, the scanning area may extend to include the dust or stains, resulting in the wrong scanning position or small images.

#### Related Information

- ➔ [“Fax Send Settings” on page 129](#)
- ➔ [“Placing Originals” on page 51](#)
- ➔ [“Cleaning the Scanner Glass” on page 152](#)

### Received Fax Quality Is Poor

- Enable the **ECM** setting on the control panel.
- Contact the sender and ask them to send using a higher quality mode.
- Reprint the received fax. Select **Fax > Menu > More > Reprint Faxes** to reprint the fax.

#### Related Information

- ➔ [“More” on page 130](#)
- ➔ [“Basic Settings Menu” on page 75](#)

### Received Faxes Are Not Printed

If an error has occurred on the printer, such as a paper jam, the printer cannot print received faxes. Check the printer.

**Related Information**

- ➔ [“Checking the Printer Status” on page 166](#)
- ➔ [“Removing Jammed Paper” on page 168](#)

## Pages are Blank or only a Small Amount of Text is Printed on the Second Page in Received Faxes

You can print on one page by using the **Delete Print Data After Split** feature in **Split Page Settings**.

Select **Delete Top** or **Delete Bottom** in **Delete Print Data After Split**, and then adjust **Threshold**. Increasing the threshold increases the amount deleted; a higher threshold gives you a higher possibility of printing on one page.

**Related Information**

- ➔ [“Receive Settings Menu” on page 76](#)

---

## Other Faxing Problems

### Cannot Make Calls on the Connected Telephone

Connect the telephone to the EXT. port on the printer, and pick up the receiver. If you cannot hear a dial tone through the receiver, connect the phone cable correctly.

### Answering Machine Cannot Answer Voice Calls

On the control panel, set the printer's **Rings to Answer** setting to a number higher than the number of rings for your answering machine.

### Sender's Fax Number Not Displayed on Received Faxes or the Number Is Wrong

The sender may not have set the fax header information or may have set it incorrectly. Contact the sender.

---

## Other Problems

### Slight Electric Shock when Touching the Printer

If many peripherals are connected to the computer, you may feel a slight electric shock when touching the printer. Install a ground wire to the computer that is connected to the printer.

## Operation Sounds Are Loud

If operations sounds are too loud, enable **Quiet Mode**. Enabling this feature may reduce printing speed.

### Control panel

Select  on the home screen, and then enable **Quiet Mode**.

### Windows printer driver

Enable **Quiet Mode** on the **Main** tab.

### Mac OS printer driver

Select **System Preferences** from the  menu > **Printers & Scanners** (or **Print & Scan, Print & Fax**), and then select the printer. Click **Options & Supplies > Options** (or **Driver**). Select **On** as the **Quiet Mode** setting.

### Epson Scan 2

Click the  button to open the **Configuration** window. Next, set the **Quiet Mode** on the **Scan** tab.

## The Date and Time Are Incorrect

Set the date and the time correctly on the control panel. After a power failure caused by a lightning strike or if the power is left off for a long time, the clock may show the wrong time.

### Related Information

➔ [“Menu Options for Printer Setup” on page 58](#)

## Application Is Blocked by a Firewall (for Windows Only)

Add the application to the Windows Firewall allowed program in security settings on the **Control Panel**.

## A Message Prompting You to Reset the Ink Levels is Displayed

Refill all or the specified ink tanks, select the color that you refilled on the LCD screen, and then reset the ink levels.

Depending on the usage conditions, the message may be displayed when there is still ink in the tank.

### Related Information

➔ [“Refilling the Ink Tanks” on page 141](#)

## Ink Spilled

- If ink adheres to the area around the tank, wipe it off using a napless, clean cloth or cotton swab.
- If ink spills on the desk or floor, wipe it off immediately. When ink is dried, it will be difficult to remove the smear. To prevent the smear from spreading, blot the ink with a dry cloth, and then wipe it with a moist cloth.
- If ink gets on your hands, wash them with water and soap.



# Appendix

## Technical Specifications

### Printer Specifications

Print Head Nozzle Placement		Black ink nozzles: 180 Color ink nozzles: 59 for each color
Weight of Paper*	Plain Paper	64 to 90 g/m <sup>2</sup> (17 to 24lb)
	Envelopes	Envelope #10, DL, C6: 75 to 90 g/m <sup>2</sup> (20 to 24 lb)

\* Even when the paper thickness is within this range, the paper may not feed in the printer or the print quality may decline depending on the paper properties or quality.

### Printable Area

#### Printable Area for Single Sheets

Print quality may decline in the shaded areas due to the printer's mechanism.

#### Printing with borders

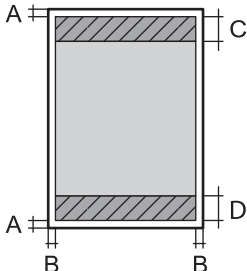
	A	3.0 mm (0.12 in.)
	B	3.0 mm (0.12 in.)
	C	41.0 mm (1.61 in.)
	D	37.0 mm (1.46 in.)

#### Borderless printing

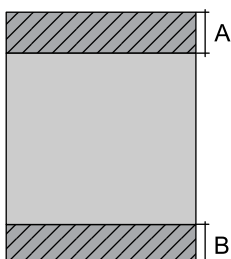
	A	44.0 mm (1.73 in.)
	B	40.0 mm (1.57 in.)

**Appendix**

**Printable Area for Envelopes**

Print quality may decline in the shaded areas due to the printer's mechanism.

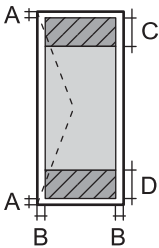
	A	3.0 mm (0.12 in.)
	B	5.0 mm (0.20 in.)
	C	18.0 mm (0.71 in.)
	D	41.0 mm (1.61 in.)

**Scanner Specifications**

Scanner Type	Flatbed
Photoelectric Device	CIS
Effective Pixels	10200×14040 pixels (1200 dpi)
Maximum Document Size	216×297 mm (8.5×11.7 in.) A4, Letter
Scanning Resolution	1200 dpi (main scan) 2400 dpi (sub scan)
Output Resolution	50 to 9600 dpi in 1 dpi increments
Color Depth	Color <input type="checkbox"/> 48 bits per pixel internal (16 bits per pixel per color internal) <input type="checkbox"/> 24 bits per pixel external (8 bits per pixel per color external)  Grayscale <input type="checkbox"/> 16 bits per pixel internal <input type="checkbox"/> 8 bits per pixel external  Black and white <input type="checkbox"/> 16 bits per pixel internal <input type="checkbox"/> 1 bits per pixel external
Light Source	LED

**Interface Specifications**

For Computer	Hi-Speed USB
--------------	--------------

**Fax Specifications**

Fax Type	Walk-up black and white and color fax capability (ITU-T Super Group 3)
----------	--

## Appendix

Supported Lines	Standard analogue telephone lines, PBX (Private Branch Exchange) telephone systems
Speed	Up to 33.6 kbps
Resolution	Monochrome <input type="checkbox"/> Standard: 8 pel/mm×3.85 line/mm (203 pel/in.×98 line/in.) <input type="checkbox"/> Fine: 8 pel/mm×7.7 line/mm (203 pel/in.×196 line/in.) <input type="checkbox"/> Photo: 8 pel/mm×7.7 line/mm (203 pel/in.×196 line/in.)  Color 200×200 dpi
Page Memory	Up to 100 pages (when received ITU-T No.1 chart in monochrome draft mode)
Redial*	2 times (with 1 minute intervals)
Interface	RJ-11 Phone Line, RJ-11 Telephone set connection

\* The specifications may differ by country or region.

## Network Function List

### Network Functions and IPv4/IPv6

Functions			Supported	Remarks
Network Printing	EpsonNet Print (Windows)	IPv4	✓	-
	Standard TCP/IP (Windows)	IPv4, IPv6	✓	-
	WSD Printing (Windows)	IPv4, IPv6	✓	Windows Vista or later
	Bonjour Printing (Mac OS)	IPv4, IPv6	✓	-
	IPP Printing (Windows, Mac OS)	IPv4, IPv6	✓	-
	UPnP Printing	IPv4	-	Information appliance
	PictBridge Printing (Wi-Fi)	IPv4	-	Digital camera
	Epson Connect (Email Print, Remote Print)	IPv4	✓	-
	AirPrint (iOS, Mac OS)	IPv4, IPv6	✓	iOS 5 or later, Mac OS X v10.7 or later
	Google Cloud Print	IPv4, IPv6	✓	-

## Appendix

Functions			Supported	Remarks
Network Scanning	Epson Scan 2	IPv4, IPv6	✓	-
	Event Manager	IPv4	✓	-
	Epson Connect (Scan to Cloud)	IPv4	-	-
	AirPrint (Scan)	IPv4, IPv6	✓	OS X Mavericks or later
	ADF (2-sided scanning)		-	-
Fax	Send a fax	IPv4	✓	-
	Receive a fax	IPv4	✓	-
	AirPrint (Faxout)	IPv4, IPv6	✓	OS X Mountain Lion or later

## Wi-Fi Specifications

Standards	IEEE802.11b/g/n <sup>*1</sup>
Frequency Range	2.4 GHz
Maximum Radio-Frequency Power Transmitted	20 dBm (EIRP)
Coordination Modes	Infrastructure, Wi-Fi Direct (Simple AP) <sup>*2*3</sup>
Wireless Securities <sup>*4</sup>	WEP (64/128bit), WPA2-PSK (AES) <sup>*5</sup>

\*1 IEEE802.11n is only available for the HT20.

\*2 Not supported for IEEE 802.11b.

\*3 Simple AP mode is compatible with a Wi-Fi connection (infrastructure) or an Ethernet connection.

\*4 Wi-Fi Direct supports WPA2-PSK (AES) only.

\*5 Complies with WPA2 standards with support for WPA/WPA2 Personal.

## Ethernet Specifications

Standards	IEEE802.3i (10BASE-T) <sup>*1</sup> IEEE802.3u (100BASE-TX) IEEE802.3az (Energy Efficient Ethernet) <sup>*2*3</sup>
Communication Mode	Auto, 10Mbps Full duplex, 10Mbps Half duplex, 100Mbps Full duplex, 100Mbps Half duplex
Connector	RJ-45

\*1 Use a category 5e or higher STP (Shielded twisted pair) cable to prevent risk of radio interference.

## Appendix

\*2 The connected device should comply with IEEE802.3az standards.

\*3 IEEE802.3az is disabled by default. See "Related Information" to enable this setting.

### Related Information

➔ [“Enabling Energy Efficient Ethernet” on page 42](#)

## Security Protocol

SSL/TLS	HTTPS Server/Client, IPPS
---------	---------------------------

## Supported Third Party Services

AirPrint	Print	iOS 5 or later/Mac OS X v10.7.x or later
	Scan	Mac OS X v10.9.x or later
	Fax	Mac OS X v10.8.x or later
Google Cloud Print		

## Dimensions

Dimensions	<p>Storage</p> <ul style="list-style-type: none"> <li><input type="checkbox"/> Width: 375 mm (14.8 in.)</li> <li><input type="checkbox"/> Depth: 347 mm (13.7 in.)</li> <li><input type="checkbox"/> Height: 237 mm (9.3 in.)</li> </ul> <p>Printing</p> <ul style="list-style-type: none"> <li><input type="checkbox"/> Width: 375 mm (14.8 in.)</li> <li><input type="checkbox"/> Depth: 578 mm (22.8 in.)</li> <li><input type="checkbox"/> Height: 253 mm (10.0 in.)</li> </ul>
Weight*	Approx. 5.0 kg (11.0 lb)

\* Without the ink and the power cord.

## Electrical Specifications

Model	100 to 240 V Model	220 to 240 V Model
Rated Frequency Range	50 to 60 Hz	50 to 60 Hz
Rated Current	0.4 to 0.2 A	0.2 A

## Appendix

Power Consumption (with USB Connection)	Standalone copying: Approx. 12.0 W (ISO/IEC24712) Ready mode: Approx. 4.3 W Sleep mode: Approx. 0.7 W Power off: Approx. 0.2 W	Standalone copying: Approx. 12.0 W (ISO/IEC24712) Ready mode: Approx. 4.3 W Sleep mode: Approx. 0.7 W Power off: Approx. 0.3 W
---	---	---

**Note:**

- Check the label on the printer for its voltage.
- For European users, see the following Website for details on power consumption.  
<http://www.epson.eu/energy-consumption>

## Environmental Specifications

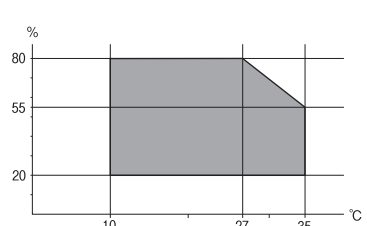
Operation	Use the printer within the range shown in the following graph.  Temperature: 10 to 35°C (50 to 95°F) Humidity: 20 to 80% RH (without condensation)
Storage	Temperature: -20 to 40°C (-4 to 104°F)* Humidity: 5 to 85% RH (without condensation)

\* You can store for one month at 40°C (104°F).

## Environmental Specifications for Ink Bottles

Storage Temperature	-20 to 40 °C (-4 to 104 °F)*
Freezing Temperature	-15 °C (5 °F) Ink thaws and is usable after approximately 2 hours at 25 °C (77 °F).

\* You can store for one month at 40 °C (104 °F).

## System Requirements

- Windows 10 (32-bit, 64-bit)/Windows 8.1 (32-bit, 64-bit)/Windows 8 (32-bit, 64-bit)/Windows 7 (32-bit, 64-bit)/Windows Vista (32-bit, 64-bit)/Windows XP SP3 or later (32-bit)/Windows XP Professional x64 Edition SP2 or later/Windows Server 2016/Windows Server 2012 R2/Windows Server 2012/Windows Server 2008 R2/Windows Server 2008/Windows Server 2003 R2/Windows Server 2003 SP2 or later

## Appendix

- ❑ macOS High Sierra/macOS Sierra/OS X El Capitan/OS X Yosemite/OS X Mavericks/OS X Mountain Lion/Mac OS X v10.7.x/Mac OS X v10.6.8

**Note:**

- ❑ *Mac OS may not support some applications and features.*
- ❑ *The UNIX File System (UFS) for Mac OS is not supported.*

---

## Regulatory Information

### Standards and Approvals

#### Standards and Approvals for U.S. Model

Safety	UL60950-1 CAN/CSA-C22.2 No.60950-1
EMC	FCC Part 15 Subpart B Class B CAN/CSA-CEI/IEC CISPR 22 Class B

This equipment contains the following wireless module.

Manufacturer: Seiko Epson Corporation

Type: J26H006

This product conforms to Part 15 of the FCC Rules and RSS-210 of the IC Rules. Epson cannot accept responsibility for any failure to satisfy the protection requirements resulting from a non-recommended modification of the product. Operation is subject to the following two conditions: (1) this device may not cause harmful interference, and (2) this device must accept any interference received, including interference that may cause undesired operation of the device.

To prevent radio interference to the licensed service, this device is intended to be operated indoors and away from windows to provide maximum shielding. Equipment (or its transmit antenna) that is installed outdoors is subject to licensing.

This equipment complies with FCC/IC radiation exposure limits set forth for an uncontrolled environment and meets the FCC radio frequency (RF) Exposure Guidelines in Supplement C to OET65 and RSS-102 of the IC radio frequency (RF) Exposure rules. This equipment should be installed and operated so that the radiator is kept at least 7.9 inches (20 cm) or more away from a person's body (excluding extremities: hands, wrists, feet and ankles).

#### Standards and Approvals for European Model

For European users

Hereby, Seiko Epson Corporation declares that the following radio equipment model is in compliance with Directive 2014/53/EU. The full text of the EU declaration of conformity is available at the following website.

<http://www.epson.eu/conformity>

C622A

## Appendix

For use only in Ireland, UK, Austria, Germany, Liechtenstein, Switzerland, France, Belgium, Luxemburg, Netherlands, Italy, Portugal, Spain, Denmark, Finland, Norway, Sweden, Iceland, Croatia, Cyprus, Greece, Slovenia, Malta, Bulgaria, Czech, Estonia, Hungary, Latvia, Lithuania, Poland, Romania, and Slovakia.

Epson cannot accept responsibility for any failure to satisfy the protection requirements resulting from a non-recommended modification of the products.



### Standards and Approvals for Australian Model

EMC	AS/NZS CISPR32 Class B
-----	------------------------

Epson hereby declares that the following equipment Models are in compliance with the essential requirements and other relevant provisions of AS/NZS4268:

C622A

Epson cannot accept responsibility for any failure to satisfy the protection requirements resulting from a non-recommended modification of the products.

### Standards and Approvals for New Zealand Model

#### General Warning

The grant of a Telepermit for any item of terminal equipment indicates only that Telecom has accepted that the item complies with the minimum conditions for connection to its network. It indicates no endorsement of the product by Telecom, nor does it provide any sort of warranty. Above all, it provides no assurance that any item will work correctly in all respects with another item of Telepermitted equipment of a different make or model, nor does it imply that any product is compatible with all of Telecom's network services.

Telepermitted equipment only may be connected to the EXT telephone port. This port is not specifically designed for 3-wire-connected equipment. 3-wire-connected equipment might not respond to incoming ringing when attached to this port.

#### Important Notice

Under power failure conditions, this telephone may not operate. Please ensure that a separate telephone, not dependent on local power, is available for emergency use.

This equipment is not capable, under all operating conditions, of correct operation at the higher speeds for which it is designed. Telecom will accept no responsibility should difficulties arise in such circumstances.

This equipment shall not be set up to make automatic calls to the Telecom '111' Emergency Service.

### Restrictions on Copying

Observe the following restrictions to ensure the responsible and legal use of the printer.

Copying of the following items is prohibited by law:

- Bank bills, coins, government-issued marketable securities, government bond securities, and municipal securities
- Unused postage stamps, pre-stamped postcards, and other official postal items bearing valid postage



## Appendix

- Government-issued revenue stamps, and securities issued according to legal procedure

Exercise caution when copying the following items:

- Private marketable securities (stock certificates, negotiable notes, checks, etc.), monthly passes, concession tickets, etc.
- Passports, driver's licenses, warrants of fitness, road passes, food stamps, tickets, etc.

**Note:**

*Copying these items may also be prohibited by law.*

Responsible use of copyrighted materials:

Printers can be misused by improperly copying copyrighted materials. Unless acting on the advice of a knowledgeable attorney, be responsible and respectful by obtaining the permission of the copyright holder before copying published material.

---

## Transporting and Storing the Printer

When you need to store the printer or transport it when moving or for repairs, follow the steps below to pack the printer.



**Caution:**

*Be careful not to trap your hand or fingers when opening or closing the document cover. Otherwise you may be injured.*

## Appendix

**!** *Important:*

- ❑ When storing or transporting the printer, place the printer in the plastic bag and fold it closed. Avoid tilting the printer, placing it vertically, or turning it upside down; otherwise ink may leak.

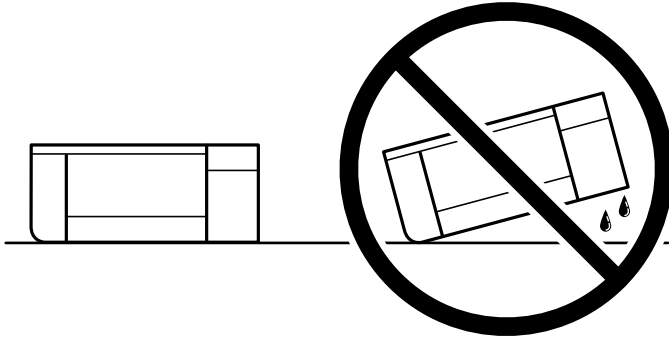

- ❑ When storing or transporting an ink bottle, do not tilt the bottle and do not subject it to impacts or temperature changes. Otherwise, ink may leak even if the cap on the ink bottle is tightened securely. Be sure to keep the ink bottle upright when tightening the cap, and take precautions to prevent ink from leaking when transporting the bottle, for example, putting the bottle in a bag.
- ❑ Do not put opened ink bottles in the box with printer.



1. Turn off the printer by pressing the  button.
2. Make sure the power light turns off, and then unplug the power cord.

**!** *Important:*

*Unplug the power cord when the power light is off. Otherwise, the print head does not return to the home position causing the ink to dry, and printing may become impossible.*

3. Disconnect all cables such as the power cord and USB cable.
4. Remove all of the paper from the printer.
5. Make sure there are no originals on the printer.

## Appendix

6. Make sure to install the cap onto the ink tank securely.

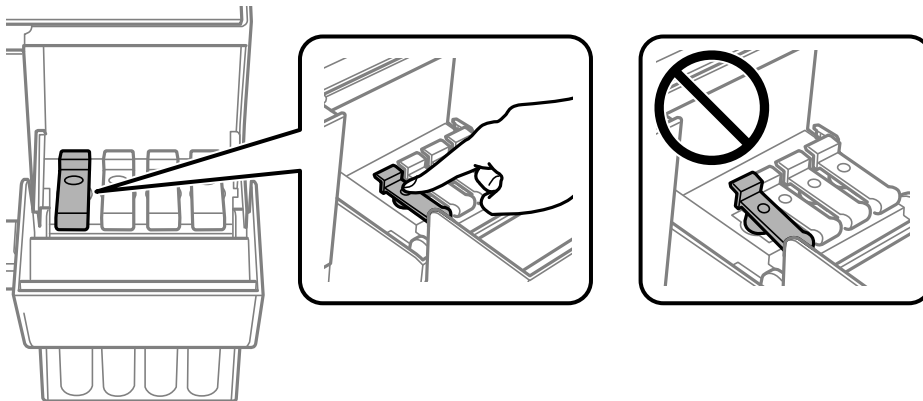

7. Close the Ink Tank Cover securely.

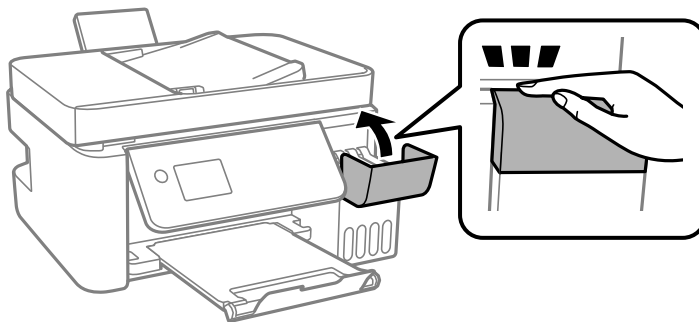

8. Prepare to pack the printer as shown below.

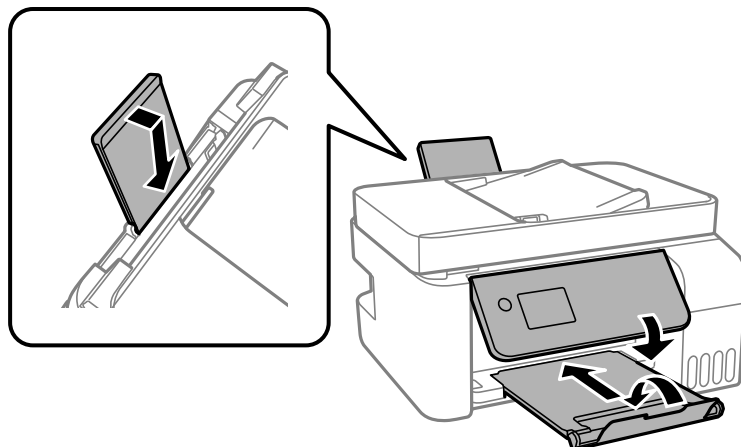

9. Place the printer in the plastic bag and fold it closed.
10. Pack the printer in its box using the protective materials.



**Important:**

*Make sure you keep the printer horizontal when transporting or storing the printer by packing it in its box; otherwise ink may leak.*

If print quality has declined the next time you print, clean and align the print head.

**Related Information**

- ➔ [“Part Names and Functions” on page 14](#)
- ➔ [“Checking and Cleaning the Print Head” on page 146](#)
- ➔ [“Aligning the Print Head” on page 149](#)

---

## Copyright

No part of this publication may be reproduced, stored in a retrieval system, or transmitted in any form or by any means, electronic, mechanical, photocopying, recording, or otherwise, without the prior written permission of Seiko Epson Corporation. No patent liability is assumed with respect to the use of the information contained herein. Neither is any liability assumed for damages resulting from the use of the information herein. The information contained herein is designed only for use with this Epson product. Epson is not responsible for any use of this information as applied to other products.

Neither Seiko Epson Corporation nor its affiliates shall be liable to the purchaser of this product or third parties for damages, losses, costs, or expenses incurred by the purchaser or third parties as a result of accident, misuse, or abuse of this product or unauthorized modifications, repairs, or alterations to this product, or (excluding the U.S.) failure to strictly comply with Seiko Epson Corporation's operating and maintenance instructions.

Seiko Epson Corporation and its affiliates shall not be liable for any damages or problems arising from the use of any options or any consumable products other than those designated as Original Epson Products or Epson Approved Products by Seiko Epson Corporation.

Seiko Epson Corporation shall not be held liable for any damage resulting from electromagnetic interference that occurs from the use of any interface cables other than those designated as Epson Approved Products by Seiko Epson Corporation.

© 2018 Seiko Epson Corporation

The contents of this manual and the specifications of this product are subject to change without notice.

---

## Trademarks

- EPSON® is a registered trademark, and EPSON EXCEED YOUR VISION or EXCEED YOUR VISION is a trademark of Seiko Epson Corporation.
- Epson Scan 2 software is based in part on the work of the Independent JPEG Group.

## Appendix

### ❑ libtiff

Copyright © 1988-1997 Sam Leffler

Copyright © 1991-1997 Silicon Graphics, Inc.

Permission to use, copy, modify, distribute, and sell this software and its documentation for any purpose is hereby granted without fee, provided that (i) the above copyright notices and this permission notice appear in all copies of the software and related documentation, and (ii) the names of Sam Leffler and Silicon Graphics may not be used in any advertising or publicity relating to the software without the specific, prior written permission of Sam Leffler and Silicon Graphics.

THE SOFTWARE IS PROVIDED "AS-IS" AND WITHOUT WARRANTY OF ANY KIND, EXPRESS, IMPLIED OR OTHERWISE, INCLUDING WITHOUT LIMITATION, ANY WARRANTY OF MERCHANTABILITY OR FITNESS FOR A PARTICULAR PURPOSE.

IN NO EVENT SHALL SAM LEFFLER OR SILICON GRAPHICS BE LIABLE FOR ANY SPECIAL, INCIDENTAL, INDIRECT OR CONSEQUENTIAL DAMAGES OF ANY KIND, OR ANY DAMAGES WHATSOEVER RESULTING FROM LOSS OF USE, DATA OR PROFITS, WHETHER OR NOT ADVISED OF THE POSSIBILITY OF DAMAGE, AND ON ANY THEORY OF LIABILITY, ARISING OUT OF OR IN CONNECTION WITH THE USE OR PERFORMANCE OF THIS SOFTWARE.

- ❑ QR Code is a registered trademark of DENSO WAVE INCORPORATED in Japan and other countries.
- ❑ Intel® is a registered trademark of Intel Corporation.
- ❑ Microsoft®, Windows®, Windows Server®, and Windows Vista® are registered trademarks of Microsoft Corporation.
- ❑ Apple, Macintosh, macOS, OS X, Bonjour, ColorSync, Safari, AirPrint, the AirPrint Logo, iPad, iPhone, iPod touch, and iTunes are trademarks of Apple Inc., registered in the U.S. and other countries.
- ❑ Google Cloud Print, Chrome, Chrome OS, Google Play and Android are trademarks of Google Inc.
- ❑ Adobe and Adobe Reader are either registered trademarks or trademarks of Adobe Systems Incorporated in the United States and/or other countries.
- ❑ General Notice: Other product names used herein are for identification purposes only and may be trademarks of their respective owners. Epson disclaims any and all rights in those marks.

---

## Where to Get Help

### Technical Support Web Site

If you need further help, visit the Epson support website shown below. Select your country or region and go to the support section of your local Epson website. The latest drivers, FAQs, manuals, or other downloadables are also available from the site.

<http://support.epson.net/>

<http://www.epson.eu/Support> (Europe)

If your Epson product is not operating properly and you cannot solve the problem, contact Epson support services for assistance.

## Contacting Epson Support

### Before Contacting Epson

If your Epson product is not operating properly and you cannot solve the problem using the troubleshooting information in your product manuals, contact Epson support services for assistance. If Epson support for your area is not listed below, contact the dealer where you purchased your product.

Epson support will be able to help you much more quickly if you give them the following information:

- Product serial number  
(The serial number label is usually on the back of the product.)
- Product model
- Product software version  
(Click **About**, **Version Info**, or a similar button in the product software.)
- Brand and model of your computer
- Your computer operating system name and version
- Names and versions of the software applications you normally use with your product

**Note:**

*Depending on the product, the dial list data for fax and/or network settings may be stored in the product's memory. Due to breakdown or repair of a product, data and/or settings may be lost. Epson shall not be responsible for the loss of any data, for backing up or recovering data and/or settings even during a warranty period. We recommend that you make your own backup data or take notes.*

### Help for Users in Europe

Check your Pan-European Warranty Document for information on how to contact Epson support.

### Help for Users in Taiwan

Contacts for information, support, and services are:

#### World Wide Web

<http://www.epson.com.tw>

Information on product specifications, drivers for download, and products enquiry are available.

#### Epson HelpDesk

Phone: +886-2-80242008

Our HelpDesk team can help you with the following over the phone:

- Sales enquiries and product information
- Product usage questions or problems
- Enquiries on repair service and warranty

## Appendix

### Repair service center:

<http://www.tekcare.com.tw/branchMap.page>

TekCare corporation is an authorized service center for Epson Taiwan Technology & Trading Ltd.

## Help for Users in Australia

Epson Australia wishes to provide you with a high level of customer service. In addition to your product manuals, we provide the following sources for obtaining information:

### Internet URL

<http://www.epson.com.au>

Access the Epson Australia World Wide Web pages. Worth taking your modem here for the occasional surf! The site provides a download area for drivers, Epson contact points, new product information and technical support (e-mail).

### Epson Helpdesk

Phone: 1300-361-054

Epson Helpdesk is provided as a final backup to make sure our clients have access to advice. Operators on the Helpdesk can aid you in installing, configuring and operating your Epson product. Our Pre-sales Helpdesk staff can provide literature on new Epson products and advise where the nearest dealer or service agent is located. Many types of queries are answered here.

We encourage you to have all the relevant information on hand when you ring. The more information you prepare, the faster we can help solve the problem. This information includes your Epson product manuals, type of computer, operating system, application programs, and any information you feel is required.

### Transportation of Product

Epson recommends retaining product packaging for future transportation. Securing the ink tank with tape and keeping the product upright is also recommended.

## Help for Users in New Zealand

Epson New Zealand wishes to provide you with a high level of customer service. In addition to your product documentation, we provide the following sources for obtaining information:

### Internet URL

<http://www.epson.co.nz>

Access the Epson New Zealand World Wide Web pages. Worth taking your modem here for the occasional surf! The site provides a download area for drivers, Epson contact points, new product information and technical support (e-mail).

### Epson Helpdesk

Phone: 0800 237 766

Epson Helpdesk is provided as a final backup to make sure our clients have access to advice. Operators on the Helpdesk can aid you in installing, configuring and operating your Epson product. Our Pre-sales Helpdesk staff

## Appendix

can provide literature on new Epson products and advise where the nearest dealer or service agent is located. Many types of queries are answered here.

We encourage you to have all the relevant information on hand when you ring. The more information you prepare, the faster we can help solve the problem. This information includes your Epson product documentation, type of computer, operating system, application programs, and any information you feel is required.

### Transportation of Product

Epson recommends retaining product packaging for future transportation. Securing the ink tank with tape and keeping the product upright is also recommended.

## Help for Users in Singapore

Sources of information, support, and services available from Epson Singapore are:

### World Wide Web

<http://www.epson.com.sg>

Information on product specifications, drivers for download, Frequently Asked Questions (FAQ), Sales Enquiries, and Technical Support via e-mail are available.

### Epson HelpDesk

Toll Free: 800-120-5564

Our HelpDesk team can help you with the following over the phone:

- Sales enquiries and product information
- Product usage questions or problem troubleshooting
- Enquiries on repair service and warranty

## Help for Users in Thailand

Contacts for information, support, and services are:

### World Wide Web

<http://www.epson.co.th>

Information on product specifications, drivers for download, Frequently Asked Questions (FAQ), and e-mail are available.

### Epson Call Centre

Phone: 66-2685-9899

Email: [support@eth.epson.co.th](mailto:support@eth.epson.co.th)

Our Call Centre team can help you with the following over the phone:

- Sales enquiries and product information
- Product usage questions or problems
- Enquiries on repair service and warranty



## Appendix

### Help for Users in Vietnam

Contacts for information, support, and services are:

#### Epson Service Center

65 Truong Dinh Street, District 1, Hochiminh City, Vietnam.

Phone(Ho Chi Minh City): 84-8-3823-9239, 84-8-3825-6234

29 Tue Tinh, Quan Hai Ba Trung, Hanoi City, Vietnam

Phone(Hanoi City): 84-4-3978-4785, 84-4-3978-4775

### Help for Users in Indonesia

Contacts for information, support, and services are:

#### World Wide Web

<http://www.epson.co.id>

- Information on product specifications, drivers for download
- Frequently Asked Questions (FAQ), Sales Enquiries, questions through e-mail

#### Epson Hotline

Phone: +62-1500-766

Fax: +62-21-808-66-799

Our Hotline team can help you with the following over the phone or fax:

- Sales enquiries and product information
- Technical support

#### Epson Service Center

Province	Company Name	Address	Phone E-mail
DKI JAKARTA	ESS JAKARTA MANGGADUA	Ruko Mall Mangga Dua No. 48 Jl. Arteri Mangga Dua, Jakarta Utara - DKI JAKARTA	(+6221) 62301104 jkt-admin@epson-indonesia.co.id
NORTH SUMATERA	ESC MEDAN	Jl. Bambu 2 Komplek Graha Niaga Nomor A-4, Medan - North Sumatera	(+6261) 42066090 / 42066091 mdn-adm@epson-indonesia.co.id
WEST JAWA	ESC BANDUNG	Jl. Cihampelas No. 48 A Bandung Jawa Barat 40116	(+6222) 4207033 bdg-admin@epson- indonesia.co.id
DI YOGYAKARTA	ESC YOGYAKARTA	YAP Square, Block A No. 6 Jl. C Simanjutak Yogyakarta - DIY	(+62274) 581065 ygy-admin@epson-indonesia.co.id
EAST JAWA	ESC SURABAYA	Hitech Mall Lt. 2 Block A No. 24 Jl. Kusuma Bangsa No. 116 - 118 Surabaya - JATIM	(+6231) 5355035 sby-admin@epson-indonesia.co.id

## Appendix

Province	Company Name	Address	Phone E-mail
SOUTH SULAWESI	ESC MAKASSAR	Jl. Cendrawasih NO. 3A, kunjung mae, mariso, MAKASSAR - SULSEL 90125	(+62411) 8911071 mksr-admin@epson-indonesia.co.id
WEST KALIMANTAN	ESC PONTIANAK	Komp. A yani Sentra Bisnis G33, Jl. Ahmad Yani - Pontianak Kalimantan Barat	(+62561) 735507 / 767049 pontianak-admin@epson-indonesia.co.id
RIAU	ESC PEKANBARU	Jl. Tuanku Tambusai No.459A Pekanbaru Riau	(+62761) 8524695 pkb-admin@epson-indonesia.co.id
DKI JAKARTA	ESS JAKARTA SUDIRMAN	Wisma Keiai Lt. 1 Jl. Jenderal Sudirman Kav. 3 Jakarta Pusat - DKI JAKARTA 10220	(+6221) 5724335 ess@epson-indonesia.co.id
EAST JAWA	ESS SURABAYA	Ruko Surya Inti Jl. Jawa No 2-4 Kav. 29 Surabaya - Jawa Timur	(+6231) 5014949 esssby@epson-indonesia.co.id
BANTEN	ESS SERPONG	Ruko Mall WTC Matahari No. 953, Serpong-Banten	(+6221) 53167051 / 53167052 esstag@epson-indonesia.co.id
CENTRAL JAWA	ESS SEMARANG	Komplek Ruko Metro Plaza Block C20 Jl. MT Haryono No 970 Semarang - JAWA TENGAH	(+6224) 8313807 / 8417935 esssmg@epson-indonesia.co.id
EAST KALIMANTAN	ESC SAMARINDA	Jl. KH. Wahid Hasyim (M. Yamin) Kelurahan Sempaja Selatan Kecamatan Samarinda UTARA - SAMARINDA - KALTIM	(+62541) 7272904 escsmd@epson-indonesia.co.id
SOUTH SUMATERA	ESC PALEMBANG	Jl. H.M Rasyid Nawawi No. 249 Kelurahan 9 Ilir Palembang Sumatera Selatan	(+62711) 311330 escplg@epson-indonesia.co.id
EAST JAVA	ESC JEMBER	JL. Panglima Besar Sudirman Ruko no.1D Jember-Jawa Timur (Depan Balai Penelitian & Pengolahan Kakao)	(+62331) 488373 / 486468 jmr-admin@epson-indonesia.co.id
NORTH SULAWESI	ESC MANADO	Tekno Megamall Lt LG 11 TK 21, Kawasan Megamas Boulevard, Jl Piere Tendean, Manado - SULUT 95111	(+62431) 8890996 MND-ADMIN@EPSON-INDONESIA.CO.ID

For other cities not listed here, call the Hot Line: 08071137766.

## Help for Users in Hong Kong

To obtain technical support as well as other after-sales services, users are welcome to contact Epson Hong Kong Limited.

### Internet Home Page

<http://www.epson.com.hk>

Epson Hong Kong has established a local home page in both Chinese and English on the Internet to provide users with the following information:

## Appendix

- Product information
- Answers to Frequently Asked Questions (FAQs)
- Latest versions of Epson product drivers

### Technical Support Hotline

You can also contact our technical staff at the following telephone and fax numbers:

Phone: 852-2827-8911

Fax: 852-2827-4383

## Help for Users in Malaysia

Contacts for information, support, and services are:

### World Wide Web

<http://www.epson.com.my>

- Information on product specifications, drivers for download
- Frequently Asked Questions (FAQ), Sales Enquiries, questions through e-mail

### Epson Call Centre

Phone: +60 1800-8-17349

- Sales enquiries and product information
- Product usage questions or problems
- Enquiries on repair services and warranty

### Head Office

Phone: 603-56288288

Fax: 603-5628 8388/603-5621 2088

## Help for Users in India

Contacts for information, support, and services are:

### World Wide Web

<http://www.epson.co.in>

Information on product specifications, drivers for download, and products enquiry are available.

### Helpline

- Service, product information, and ordering consumables (BSNL Lines)

Toll-free number: 18004250011

Accessible 9am to 6pm, Monday through Saturday (Except public holidays)

## Appendix

### Service (CDMA & Mobile Users)

Toll-free number: 186030001600

Accessible 9am to 6pm, Monday through Saturday (Except public holidays)

## Help for Users in the Philippines

To obtain technical support as well as other after sales services, users are welcome to contact the Epson Philippines Corporation at the telephone, fax numbers and e-mail address below:

### World Wide Web

<http://www.epson.com.ph>

Information on product specifications, drivers for download, Frequently Asked Questions (FAQ), and E-mail Enquiries are available.

### Epson Philippines Customer Care

Toll Free: (PLDT) 1-800-1069-37766

Toll Free: (Digital) 1-800-3-0037766

Metro Manila: (+632)441-9030

Web Site: <https://www.epson.com.ph/contact>

E-mail: [customercare@epc.epson.com.ph](mailto:customercare@epc.epson.com.ph)

Accessible 9am to 6pm, Monday through Saturday (Except public holidays)

Our Customer Care team can help you with the following over the phone:

- Sales enquiries and product information
- Product usage questions or problems
- Enquiries on repair service and warranty

### Epson Philippines Corporation

Trunk Line: +632-706-2609

Fax: +632-706-2663

## Free Manuals Download Website

<http://myh66.com>

<http://usermanuals.us>

<http://www.somanuals.com>

<http://www.4manuals.cc>

<http://www.manual-lib.com>

<http://www.404manual.com>

<http://www.luxmanual.com>

<http://aubethermostatmanual.com>

Golf course search by state

<http://golfingnear.com>

Email search by domain

<http://emailbydomain.com>

Auto manuals search

<http://auto.somanuals.com>

TV manuals search

<http://tv.somanuals.com>