

DirectView Display Reference Guide

Models: INF4201, INF5501 and INF6501



Regulatory models ST-HB42A, ST-HB55A, ST-HB65A
11850138-0G

InFocus
Bright Ideas Made Brilliant

Contents

Important Information	3
<i>FCC Compliance Statement</i>	3
<i>Safety Information</i>	4
Shipping Contents	5
Moving the Monitor Safely	6
Installation Guidelines	7
<i>Wall Installation</i>	7
INF6501	7
INF5501	7
INF4201	7
<i>Stand installation</i>	8
INF6501	8
INF5501	9
INF4201	9
Connecting Power	10
Using the Remote Control	11
<i>Cautions regarding use of remote control</i>	11
<i>Remote Control Overview</i>	12
<i>Replacing remote batteries</i>	13
Identification of Controls	14
<i>Front panel</i>	14
<i>Rear panel</i>	15
Connection	17
<i>Connecting a VCR or DVD player</i>	17
<i>Connecting a Camcorder</i>	18
<i>Connecting an HDMI device</i>	19
<i>Connecting Component Video</i>	20
<i>Connecting Optical Digital Audio</i>	21

Connecting a Computer	22
Connecting PC Audio In	22
Basic Operation	23
Turning the monitor on	23
Turning the monitor off	23
Adjusting the Volume	23
Selecting the input source	23
PIP/SplitScreen mode	24
Using the Menus	26
Menu Overview	26
Navigating through the Menu System	27
Image Settings Menu	27
Display Settings Menu	29
Audio Settings Menu	30
Basic Settings Menu	31
Advanced Settings Menu	32
System Status Menu	33
Specifications	34
INF6501	34
INF5501	35
INF4201	36
Maintenance	37
Troubleshooting.....	38

※ Please read this user's manual cautiously and completely before operating this monitor.

Important Information

FCC Compliance Statement

This equipment has been tested and found to comply with the limits for a Class A digital device, pursuant to part 15 of the FCC Rules. These limits are designed to provide reasonable protection against harmful interference when the equipment is operated in a commercial environment. This equipment generates, uses, and can radiate radio frequency energy and, if not installed and used in accordance with the instruction manual, may cause harmful interference to radio communications.

Operation of this equipment in a residential area is likely to cause harmful interference in which case the user will be required to correct the interference at his all expense.

WARNING

This is a Class A monitor. In a domestic environment, this monitor may cause radio interference in which case the user may be required to take adequate measures.

This device complies with Part 15 of the FCC Rules. Operation is subject to the following two conditions: (1) this device may not cause harmful interference, and (2) this device must accept any interference received, including interference that may cause undesired operation.

CE

EN 55022, EN 61000-3-2, EN-61000-3-3

EN 55024, IEC61000-4

EN 60950 [Low-Voltage Directive (2006/95/EC)]

Important Information (Continued)

Safety Information

- ◆ To prevent fire or shock hazard, do not expose the monitor to rain or moisture.
- ◆ The high voltage in the monitor can be extremely dangerous. Do not open the monitor enclosure. Refer all servicing to qualified servicing personnel.
- ◆ Do not expose the monitor to rain or moisture.
- ◆ Do not remove the rear cover.
- ◆ Operate the monitor only with the type of power source indicated on the serial number/model plate.
- ◆ Do not cover the gaps or openings with cloth or any other object.
- ◆ Do not block the ventilation openings.
- ◆ The monitor should not be used with the power cord near water, for instance, near a bathtub, washbowl, kitchen sink, or swimming pool, etc.
- ◆ Do not install the monitor in hot, humid, or excessively dusty places.
- ◆ Do not place any object on or twist the power cord or put the monitor in places where the power cord is likely to be worn or misused.
- ◆ Do not install the monitor in places subject to mechanical vibration.
- ◆ Do not place the monitor on an unstable surface, which could result in serious personal injuries and monitor damage. When mounting the monitor to a stand, be sure to follow the manufacturer's instructions. Use only the mounting hardware recommended by the manufacturer.
- ◆ When mounting the monitor on a wall or hanging from the ceiling, be sure to follow the manufacturer's instructions. Use only the mounting hardware recommended by the manufacturer.
- ◆ Protect the power cord from being walked on or pinched particularly at plugs, convenience receptacles, and the point where they exit from the monitor.
- ◆ This monitor is to be used with 110/220V power. If you are unsure of the type of power, which is supplied to your building/home, consult your local dealer or the local power company. For added protection, unplug the monitor from the power outlet and disconnect all cables during lightning storms or when the monitor is left unattended and unused for long periods of time. This will prevent damage to the monitor due to lightning and power line surges. The power outlet should be located near the monitor and be easily accessible. Only use the included power cord.
- ◆ This monitor provides finely detailed pictures, however some pixels may appear on the screen as fixed points of blue, green or red. This will not affect the performance of your monitor.

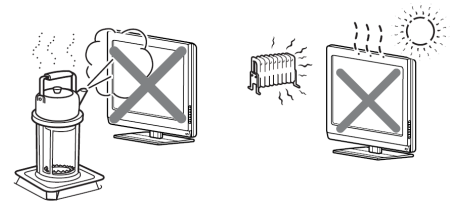

Warning:

For safety purposes, it is recommended that this Class A monitor be grounded.

Shipping Contents



Monitor



**Remote Control
(Does not include batteries)**



Reference Guide on CD

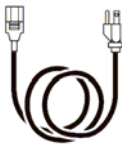

Power Cord

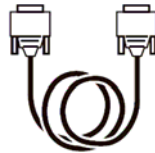

VGA Cable



Cleaning Cloth

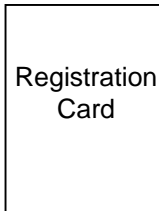

Registration Card

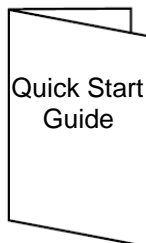

**Quick Start Guide
(Included Safety
Instructions)**

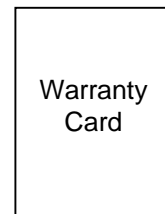

Warranty Card

Moving the Monitor Safely

In order to prevent monitor damage and/or personal injuries, you should always follow these procedures when moving the monitor:

- ◆ Do not attempt to move the monitor yourself. At least two people are required to move the monitor.
- ◆ Do not hold onto the speaker grid when moving the monitor.
- ◆ Hold the monitor firmly when moving the monitor.
- ◆ Disconnect all accessories and cables before moving the monitor.

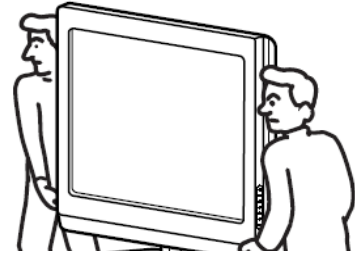

Caution:

- ◆ **Keep children away from the monitor during installation. Climbing or pushing the monitor may cause the monitor to fall and cause injuries and monitor damage.**
- ◆ **If the monitor is installed against the wall, maintain a distance of at least 10cm (4") between the monitor and the wall to provide adequate ventilation.**

Installation Guidelines

Wall Installation

Always follow the mounting instructions provided by the wall bracket manufacturer.

Step1. Remove screws (Table 1) from the back of the monitor.

Step2. Align the wall brackets with the mounting holes and attach the brackets to the monitor using the screws removed in Step 1. **Caution:** Longer screws will damage the monitor.

INF6501

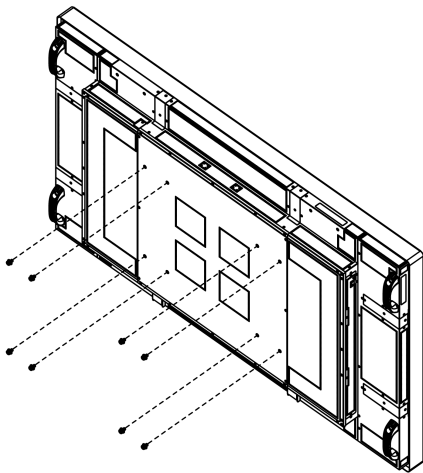
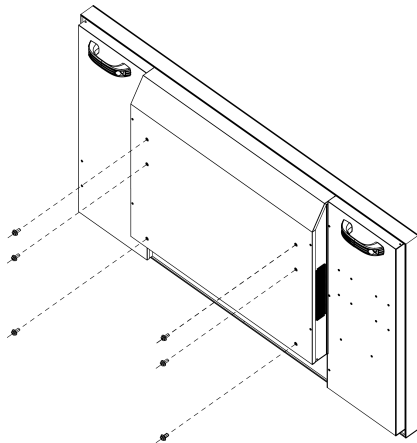

Table 1

Model	Screw size	Q'TY
INF6501	M8 X 18 mm	8
INF5501	M8 X 15 mm	6
INF4201	M8 X 15 mm	4

INF5501



INF4201

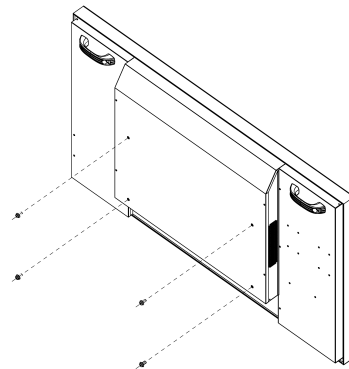

Caution:

- ◆ When using wall mount kit, it has to be able to hold at least 3 times the weight of the monitor.
- ◆ When using wall mount kit, it is required to use screw sizes stated in table 1 in page 7 for each model.

Installation Guidelines (Continued)

Stand installation

The following examples may not be representative of the optional stand, which you purchased. Use them as guidelines only. Always follow the mounting instructions provided by the stand manufacturer.

INF6501

1. Place the monitor (LCD screen face down) on a flat, stable surface, which has been covered with a soft cloth. This will help prevent the monitor from being scratched.
2. Remove the screws (2 total) from the back of the monitor.
3. Align the stand brackets with the mounting holes and attach the brackets to the monitor using the screws removed in Step 2. **Caution:** Longer screws will damage the monitor.

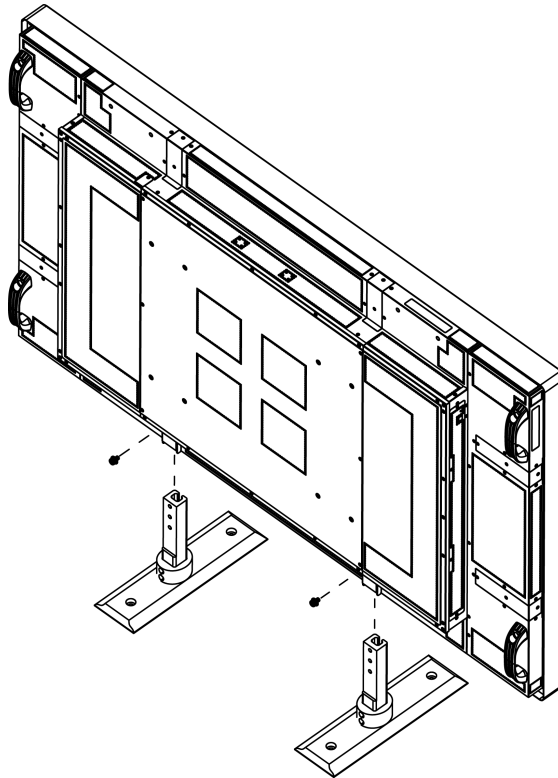

Installation Guidelines (Continued)

INF5501

1. Place the monitor (LCD screen face down) on a flat, stable surface which has been covered with a soft cloth. This will help prevent the monitor from being scratched.
2. Remove the screws (6 total) from the back of the monitor.
3. Align the stand brackets with the mounting holes and attach the brackets to the monitor using the screws removed in Step 2. **Caution:** Longer screws will damage the monitor.

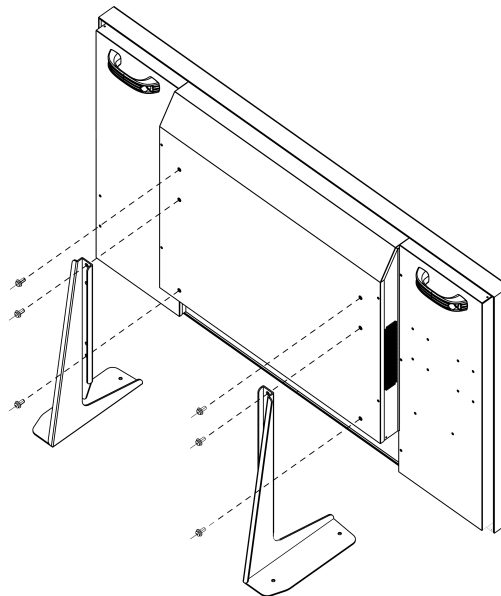

INF4201

1. Place the monitor (LCD screen face down) on a flat, stable surface, which has been covered with a soft cloth. This will help prevent the monitor from being scratched.
2. Remove the screws (4 total) from the back of the monitor.
3. Align the stand brackets with the mounting holes and attach the brackets to the monitor using the screws removed in Step 2. **Caution:** Longer screws will damage the monitor.

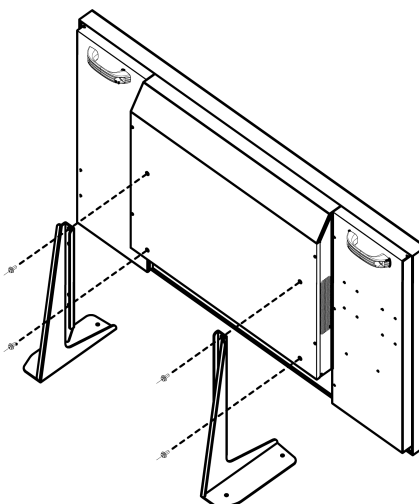

Connecting Power

Environmental Specifications:

Operating Temperature: 5°C to +35°C (Fahrenheit: 41°F to 95°F)

Humidity: max.90%

1. Connect the power cord to the monitor before connecting to the AC power outlet.
2. Turn on the power switch (INF6501 and INF5501 only).
3. Press  on the remote or monitor keypad to turn on or off.

INF6501 Input: 100-240V ~ 6-4A 50-60 Hz

INF5501 Input: 100-240V ~ 5A 50-60 Hz

INF4201 Input: 100-240V ~5A 50-60 Hz

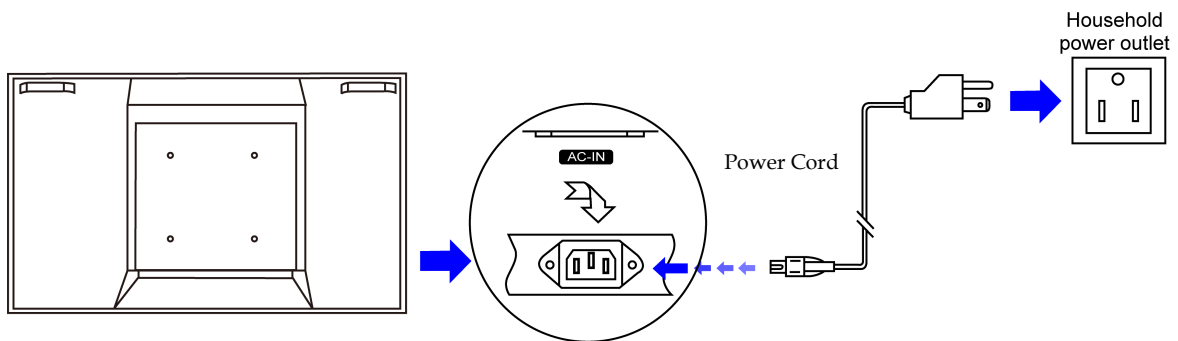

Note:

Unplug the monitor from the power outlet when not in use for extended periods of time.

Using the Remote Control

Use the remote control by pointing it towards the remote sensor of the set. Objects between the remote control and remote sensor may prevent proper operation.

Cautions regarding use of remote control

- ◆ Do not expose the remote control to shock. In addition, do not expose the remote control to liquids, and do not place in an area with high humidity.
- ◆ Do not install or place the remote control under direct sunlight. The heat may cause remote damage.
- ◆ The remote control may not work properly if the remote sensor is located under strong lighting or in direct sunlight. In such a case, change the angle of the lighting or the monitor itself, or operate the remote control closer to the remote sensor.

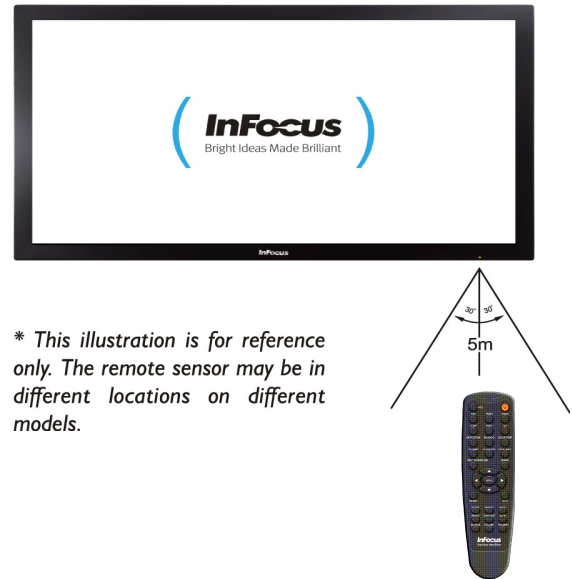

Using the Remote Control (Continued)

Remote Control Overview



No.	Function	Description
1		Turns the monitor on and off.
2	INFO	Provides source and resolution information.
3	VGA	Selects the PC RGB source.
	HDMI 1	Selects the HDMI source 1.
	HDMI 2	Selects the HDMI source 2.
4	COMP	Selects the Component source.
	VIDEO	Selects the Composite Video source.
	S-V	Selects the S-Video source.
5	SS-POSITION	Changes the size and position of the SplitScreen windows (Large PIP, Medium PIP, Small PIP, Side-by-Side).
	SS-AUDIO	Toggles between the SplitScreen audio sources.
	COLOR TEMP	Toggles between the various color temperature options.
6	SS-SWAP	Swaps the position of the main SplitScreen source and the secondary source.
	SS-SOURCE	Selects the secondary SplitScreen source.
	BACK LIGHT	Controls the brightness of the monitor backlighting.
7	SPLIT SCREEN (SS)	Turns the SplitScreen feature on and off.
8	BLANK	Turns the blank screen feature on and off.
9	MENU	Opens the monitor's on-screen menu system. When the menu system is already open, pressing this button will select the previous submenu.
		Navigates through submenus and settings.
10	EXIT	Closes the menu system.
11	ENTER	Selects highlighted menu choices.
12	RESIZE	Toggles between different aspect ratios (Auto, Native, 4x3, 16x9, 16x10 and Letterbox).
	FREEZE	Freezes the current source image.
	MUTE	Turns off the sound.
	BRIGHT	Adjusts the brightness.
	CONTRAST	Adjusts the contrast ratio.
	AUTO	Resynchronizes the monitor to the source.
	SOURCE	Allows selection of the different sources.
	VOLUME-	Decreases the sound volume.
	VOLUME+	Increases the sound volume.

Using the Remote Control (Continued)

Replacing remote batteries

Remove the battery cover

1. Slide back and remove the battery cover in the direction of the arrow.

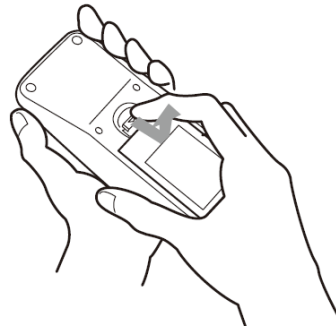

Insert the batteries

2. Align and insert two AAA batteries according to their plus and minus ports (as indicated in the remote control).

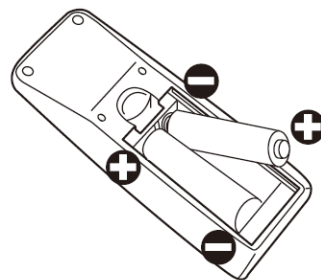

Close the battery cover

3. Replace the battery cover in the direction of the arrow and snap it back into place.

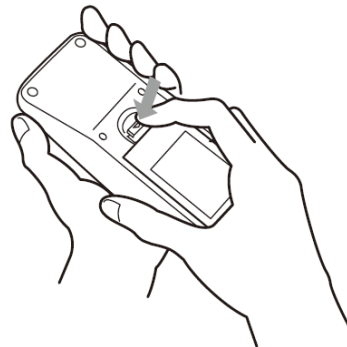

Caution:

- ◆ When replacing the batteries, be aware that using batteries other than the type described above may risk severe damage to the remote. When disposing of the batteries, be sure to do so in an environmentally proper manner.
- ◆ If the remote control gets wet, wipe it dry immediately.
- ◆ Avoid excessive heat and humidity.
- ◆ Ensure the batteries' polarity (+/-) is aligned correctly.
- ◆ Do not mix new and old batteries together, or different types of batteries together.
- ◆ Replace the batteries as soon as they run out.
- ◆ Remove batteries from the remote control when storing or not in use for a prolonged period.

Identification of Controls

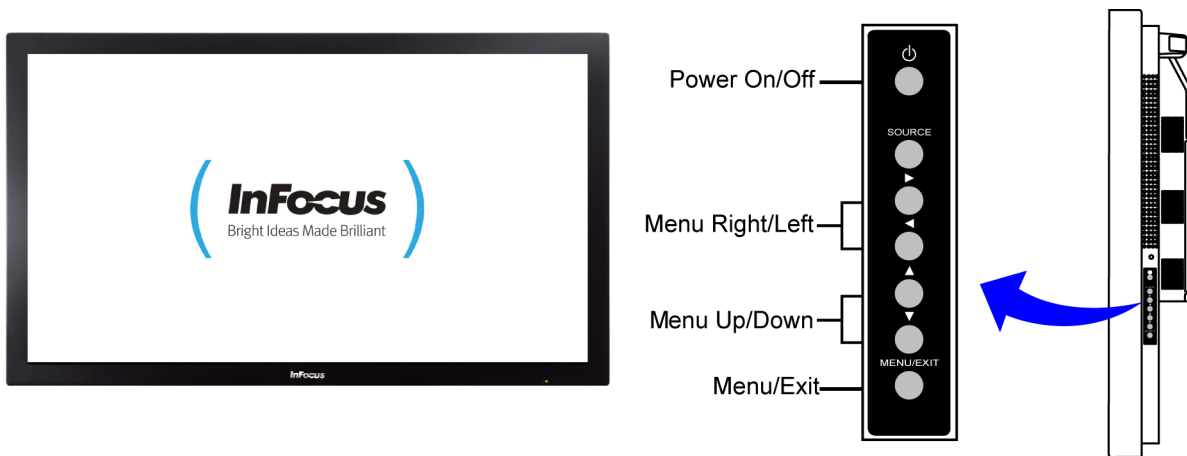

Front panel







Power

Press this button to turn the monitor ON or OFF.

Source (ENTER)

Press this button and use the arrow buttons ( ) to navigate to the desired input source. Press **SOURCE** again to select the highlighted source.

Menu/Exit

Press **MENU/EXIT** to access the on-screen menu system and use the arrow buttons (   ) to navigate through the menu system. Press **MENU/EXIT** again to go back to the previous menu or exit from the menu system entirely.

Note:

The remote control can also be used to control the monitor.

Identification of Controls (continued)

Rear panel INF6501

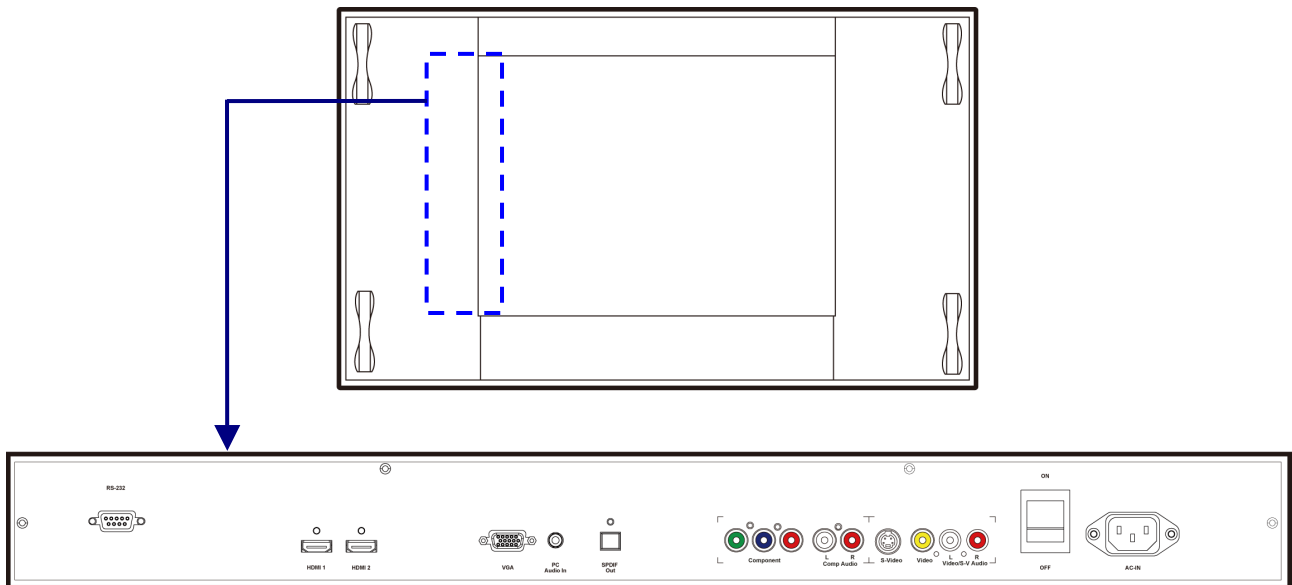

INF5501

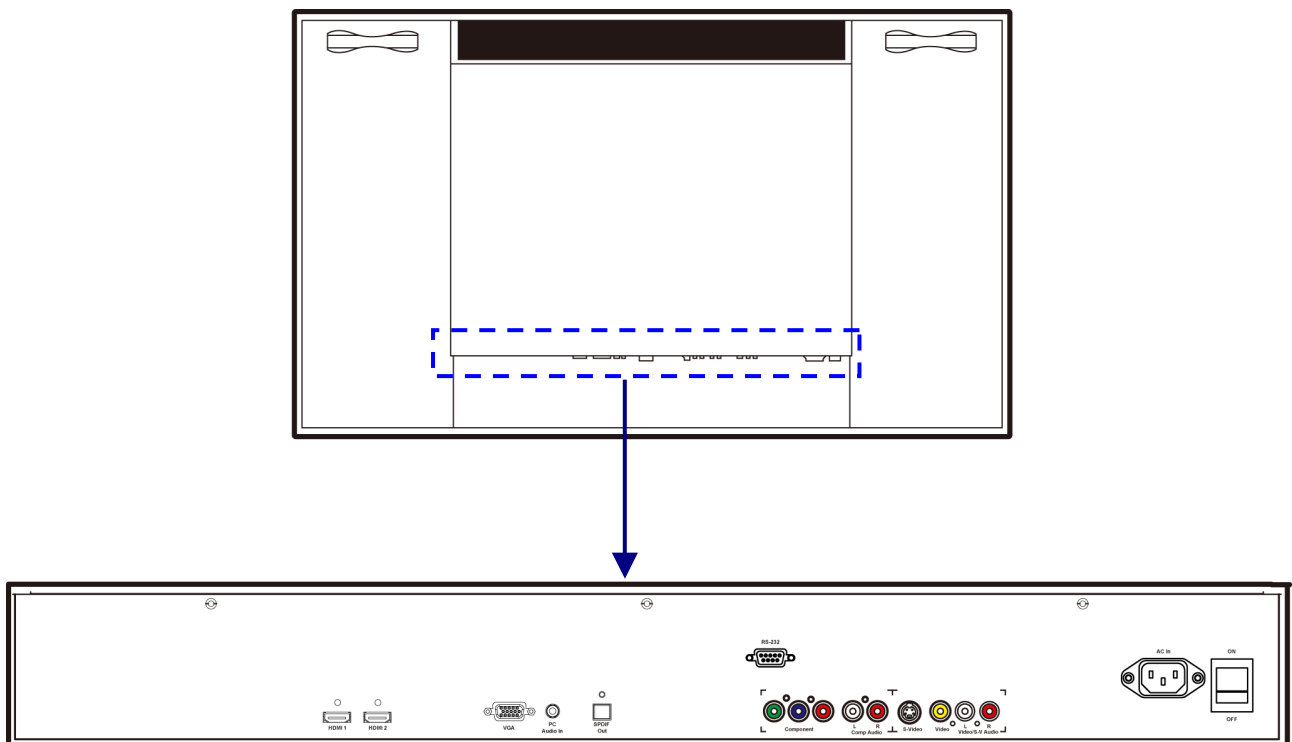

Identification of Controls (continued)

INF4201

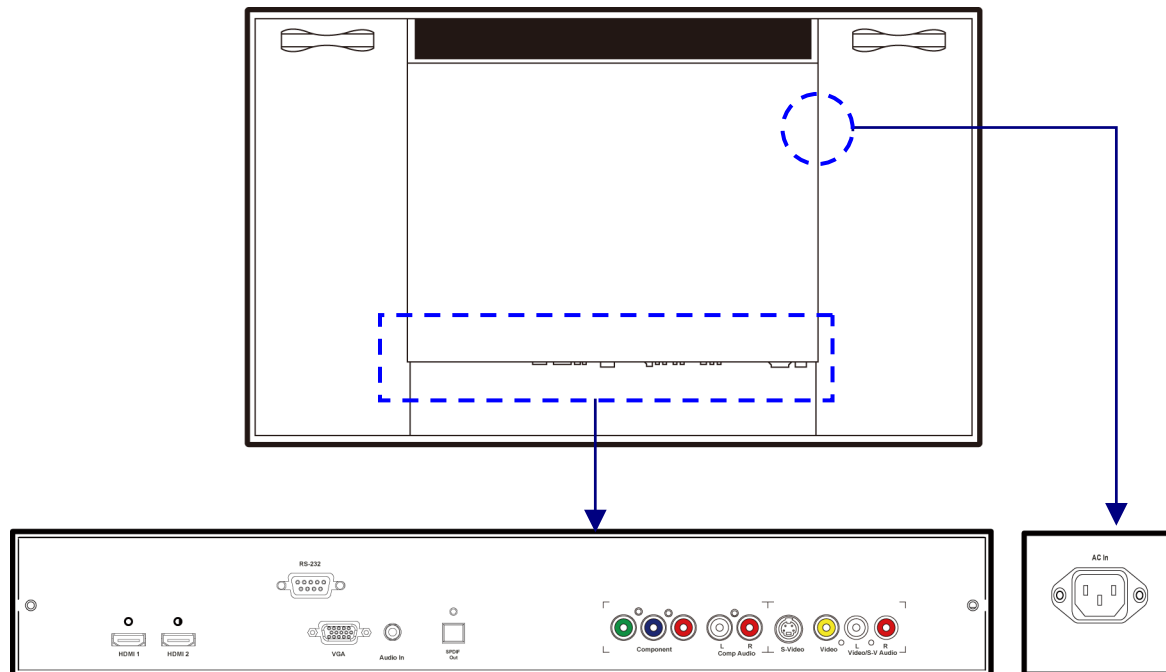

1. **HDMI 1/2:** provides an uncompressed, all-digital audio/video interface between the monitor and any HDMI-equipped audio/video component, such as a set-top box or DVD player.
2. **VGA:** Connect to a PC or other analog RGB output device such as a video conferencing device.
3. **PC Audio input:** Connect to a PC audio output device.
4. **SPDIF:** Connect to a digital audio output device, such as a speaker system (used in conjunction with an HDMI input source on the monitor).
5. **RS-232:** Used with external command systems and RS232 command protocol, and firmware upgrades.
6. **Component:** Connect to the component video output ports on a DVD player or a high-definition cable/satellite receiver. Component video provides better picture quality than S-Video or composite video.
7. **Component Audio:** Connect to the component audio output ports on a VCR, DVD player or other video device.
8. **S-Video:** Connect to the S-Video output port of a VCR, DVD player or other video device. S-Video provides better picture quality than composite video.
9. **Video:** Connect to the composite output port of a VCR, DVD player or other video device, using a yellow RCA video cable.
10. **Video/S-V Audio:** Connect an RCA audio cable to the Audio Out ports of the video source.
11. **AC In:** Connect the power cord to this port.
12. **Power Switch (INF6501 and INF5501 only):** Hard-power the monitor on or off with this switch.

Connection

Connecting a VCR or DVD player

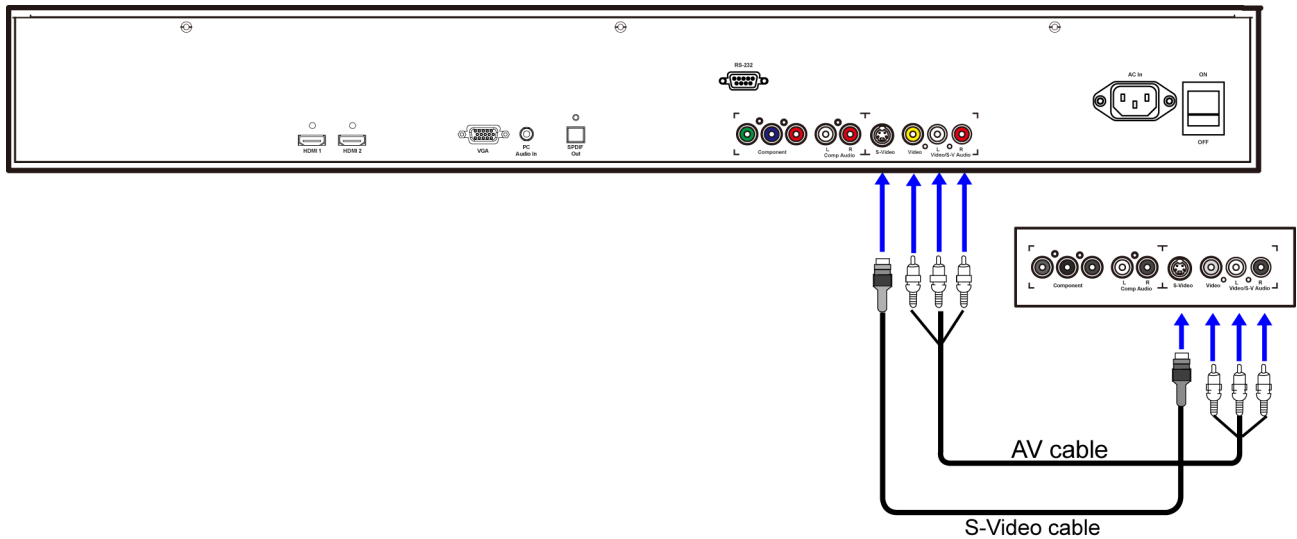

How to connect:

Connect the Audio/Video cable between the Audio (L/R)/Video ports on the monitor and VCR.

To play a VHS tape or CD/DVD:

1. Turn on the monitor. The monitor will automatically search for the source signal. If multiple sources are active, press **VIDEO** (composite video) or **S-V** (S-video) on the remote.
2. Turn on the VCR (or DVD player) and set the tape/CD/DVD to play. See the device's user manual for more information.

Note:

- ◆ For better video, you can use the S-Video port if your source supports it.
- ◆ Please check the ports for position and type before making any connections.
- ◆ The illustration of the external equipment may be different depending on your model.
- ◆ Loose connectors can result in image or color problems. Verify that all connectors are securely inserted into their ports.
- ◆ Refer to the operating manual of the external device as well.
- ◆ When connecting an external device, turn the power off to avoid any issues.

Connection (Continued)

Connecting a Camcorder

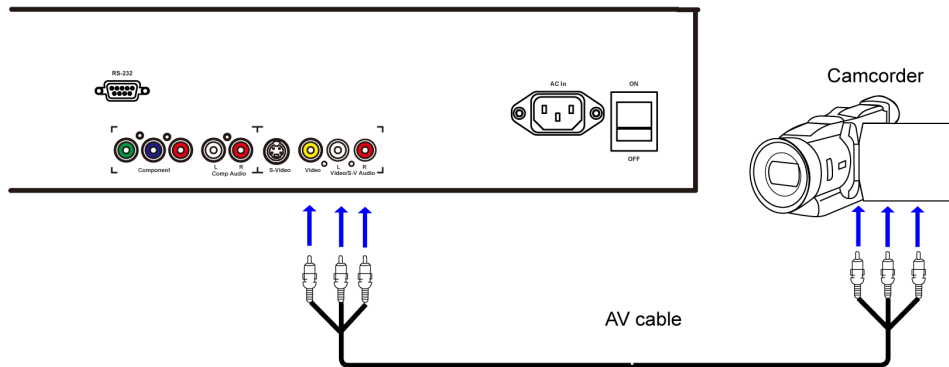

How to connect:

Connect the Video/S-V Audio cables between the Audio (L/R)/Video ports on the monitor and camcorder.

To Playback Camcorder:

1. Turn on the monitor. The monitor will automatically search for the source signal. If multiple sources are active, press **VIDEO** (composite video) on the remote.
2. Turn on the camcorder and set it to output the source. For details, refer to the camcorder user manual.

Connection (Continued)

Connecting an HDMI device

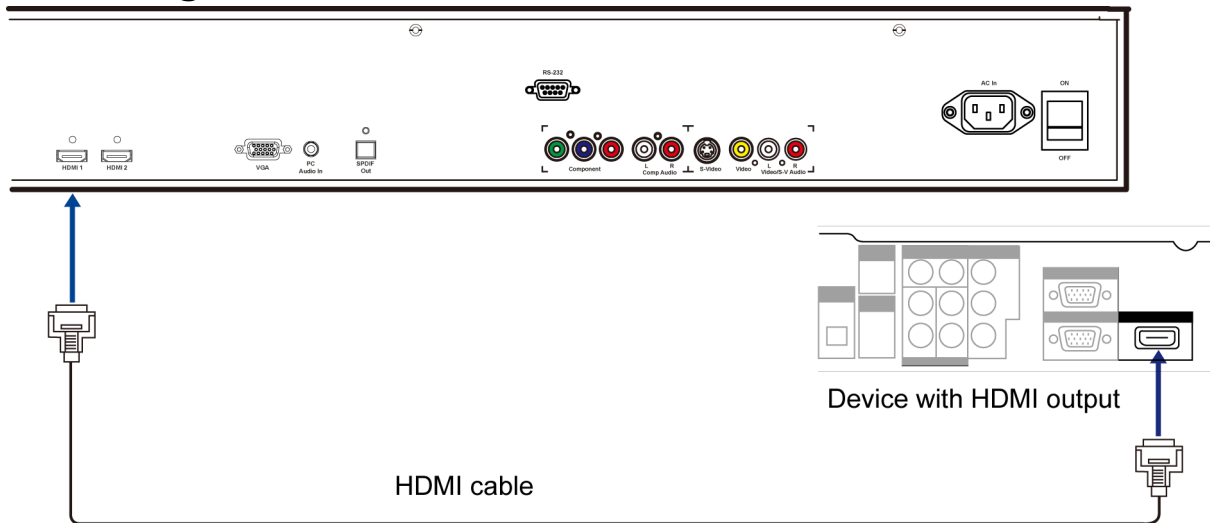

How to connect a device using HDMI Connection:

Connect the HDMI cable between the HDMI interface on the monitor and HDMI on the device.

To play from the device using HDMI:

1. Turn on the monitor. The monitor will automatically search for the source signal. If multiple sources are active, press **HDMI1** or **HDMI2** on the remote.
2. Turn on the HDMI device and set it to output the source. For details, refer to the device's user manual.

Note:

If the external device has DVI output only, use a DVI to HDMI adapter cable to connect to the HDMI port. Connect the audio cable to the VGA AUDIO port on the monitor rear.

Connection (Continued)

Connecting Component Video

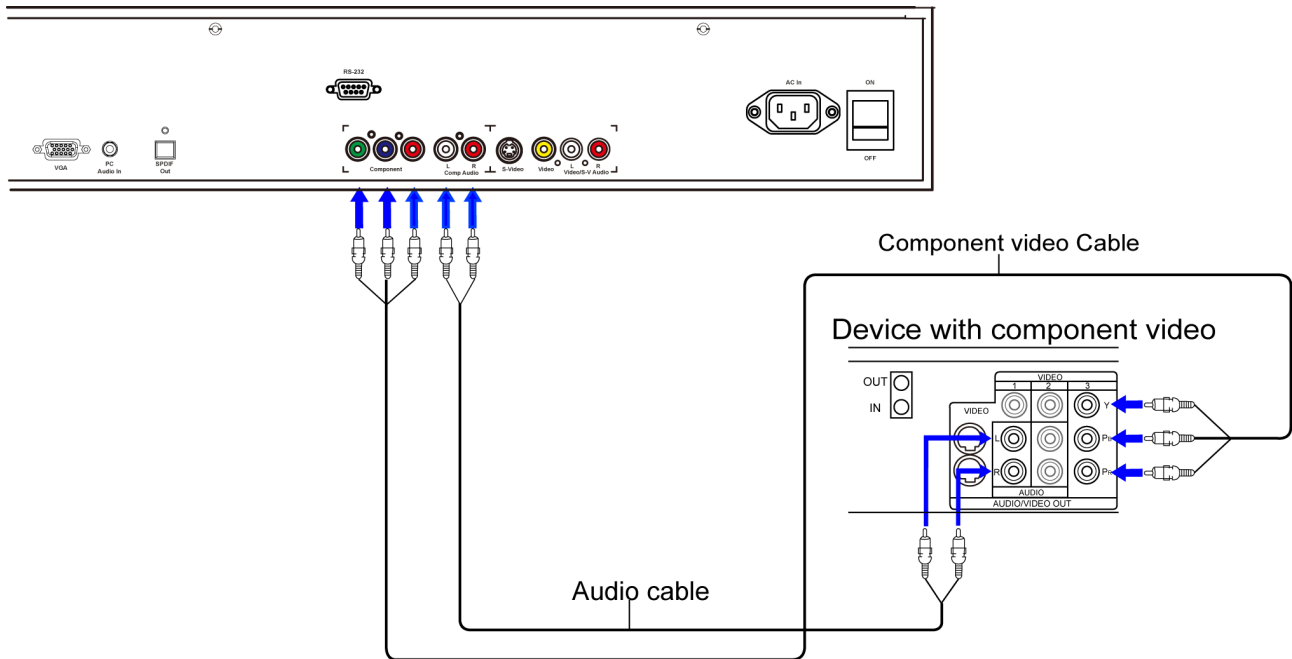

To connect a device using component video:

Connect the Component Video cable between the Y, Cb/Pb, Cr/Pr input ports on the monitor and Y, Cb/Pb, Cr/Pr output port on the device.

Connect the Audio cable between the AUDIO input ports on the monitor and AUDIO output ports on the device.

To play component video from an external device:

1. Turn on the monitor. The monitor will automatically search for the source signal. If multiple sources are active, press **COMP** (component video) on the remote.
2. Turn on the device and set it to output the source. For details, see the device's user guide for more information.

Note:

- ◆ The illustration of the external equipment may be different depending on your model.
- ◆ Loose connectors can result in image or color problems. Verify that all connectors are securely inserted into their ports.

Connection (Continued)

Connecting Optical Digital Audio

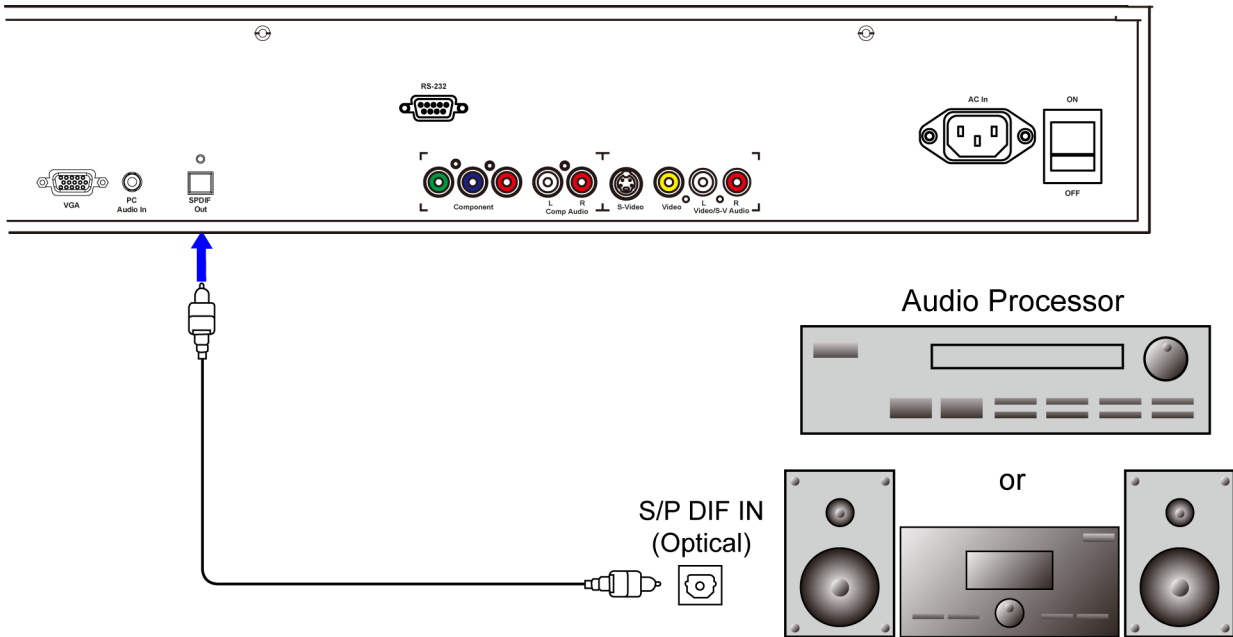

How to connect:

Connect an optical digital audio cable between the SPDIF Out port on the monitor and the optical digital audio input port on the amplified speaker system or other optical digital audio output device (for use with HDMI sources).

Connection (Continued)

Connecting a Computer

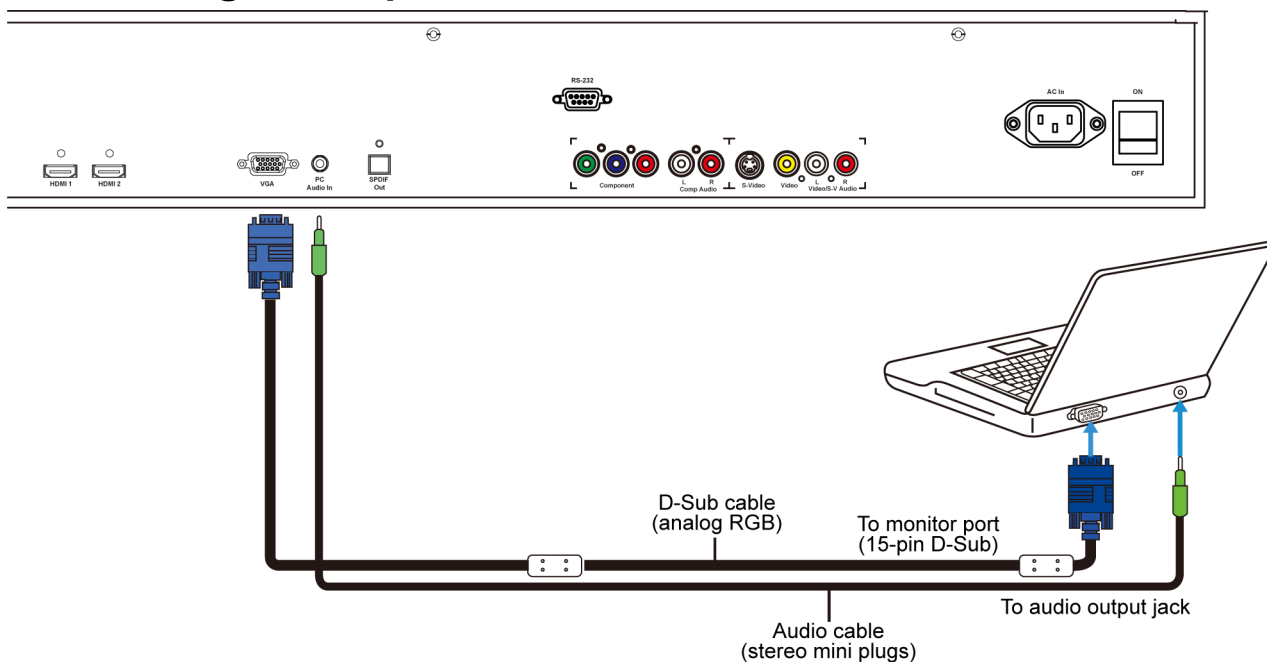

How to connect:

1. Connect a VGA cable between the VGA port on the computer and the VGA port on the monitor.
2. Connect an Audio cable between the Audio output on the computer and audio port on the monitor.

To play video from a computer:

1. Turn on the monitor. The monitor will automatically search for the source signal. If multiple sources are active, press **VGA** on the remote.
2. Turn on the computer. If the computer image does not automatically display, you may need to activate the laptop's external port (FN+F5, FN+F7 or other keypad combination – See laptop user manual for additional information.). Note: The monitor is compatible with resolutions up to a maximum of 1920 x 1200 at a 60Hz refresh rate.

Connecting PC Audio In

Insert the cable from the computer's audio output port into the monitor's PC Audio In port. (See above illustration.)

Basic Operation

Turning the monitor on

1. Insert the power cord into monitor and into the power outlet.
2. Press the power button on the monitor (or using the remote control) to power-on the monitor.

Turning the monitor off

With the power on, press the power button on the monitor (or the remote control) to put the monitor in a standby mode. To turn off power completely, disconnect the AC power cord from the power outlet.

Note:

If there is no signal input for a certain time, the monitor will automatically go to standby mode.

Adjusting the Volume

1. Using the remote, press the **VOLUME-** or **VOLUME+** to increase or decrease the volume.
2. Press the **MUTE** button to temporarily turn off all sound. To restore the sound, press the **MUTE** button again.

Selecting the input source

1. Using the remote, press the desired source button (VGA, HDMI1, HDMI2, COMP, VIDEO or S-V)
2. Or press **SOURCE** on the monitor keypad, use the arrow buttons (**▲ ▼**) to navigate to the desired input source, and press **ENTER**:

- ◆ **HDMI 1**
- ◆ **HDMI 2**
- ◆ **VGA**
- ◆ **Component**
- ◆ **S-Video**
- ◆ **Composite Video**

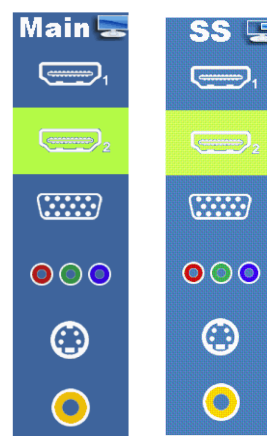

2. When the monitor cannot find a source, the following “No signal” message will appear (Not shown when InFocus Logo is set to No Signal Screen under Basic Settings).



Basic Operation (Continued)

PIP/SplitScreen mode

1. **Select the main source** - Using the remote, press the desired source button (VGA, HDMI1, HDMI2, COMP, VIDEO or S-V).
2. **Turn on PIP/SplitScreen mode:** Using the remote, press **SPLITSCREEN (SS)**.

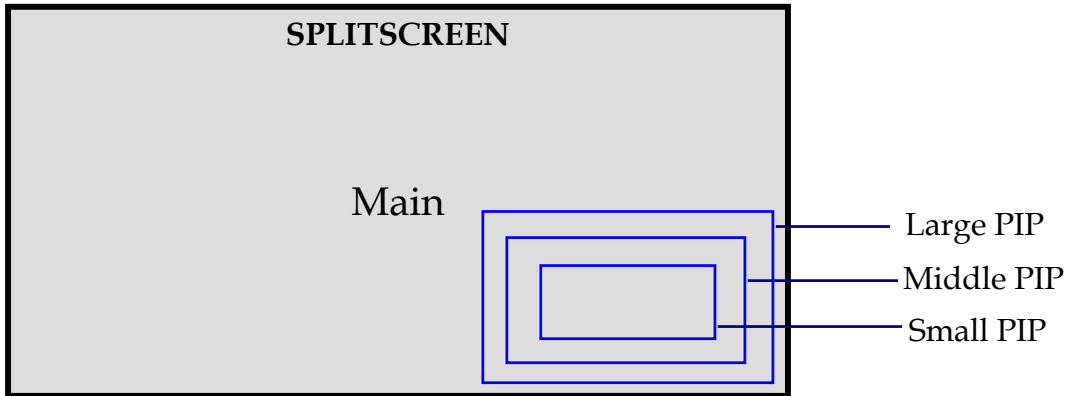

3. **To select the PIP/SplitScreen subsource:** Using the remote, press **SS-SOURCE** and use the arrow buttons (▲ ▼) to navigate to the desired subsource. Press **ENTER**.
4. **To change the size and position of the subsource:** Using the remote, press **SS-POSITION** to toggle through the options.

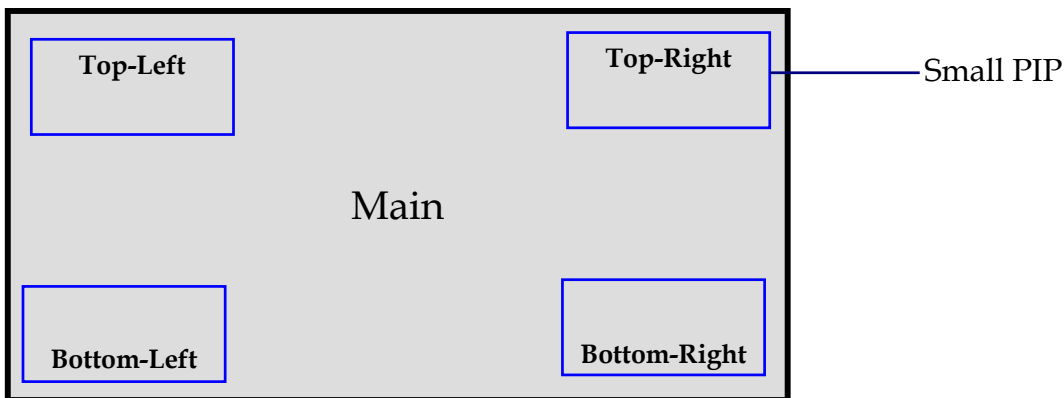

5. **To switch the main source and the subsource:** Using the remote, press **SS-SWAP**.

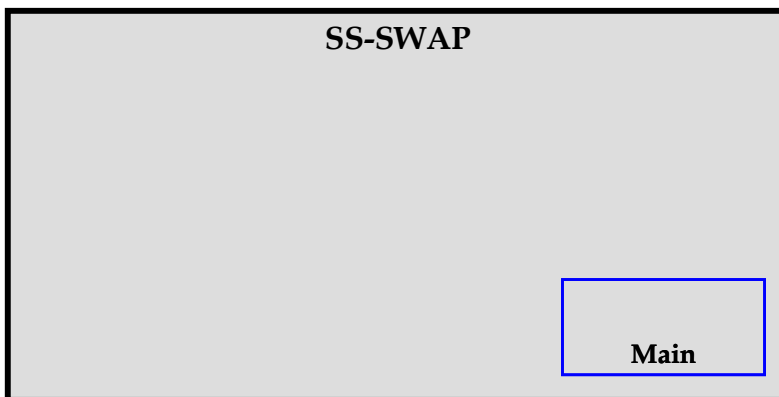

Basic Operation (Continued)

6. To switch audio between the main source and the subsource: Using the remote, press **SS-AUDIO**.
7. **Note:** For additional PIP/SplitScreen functionality, press **MENU** and navigate to the **Display Settings** menu. Use the arrow buttons (**▲ ▼**) to navigate to the desired **SplitScreen** feature and press **ENTER**. Press **▶** to toggle through the associated options and press **ENTER** to select the highlighted option.

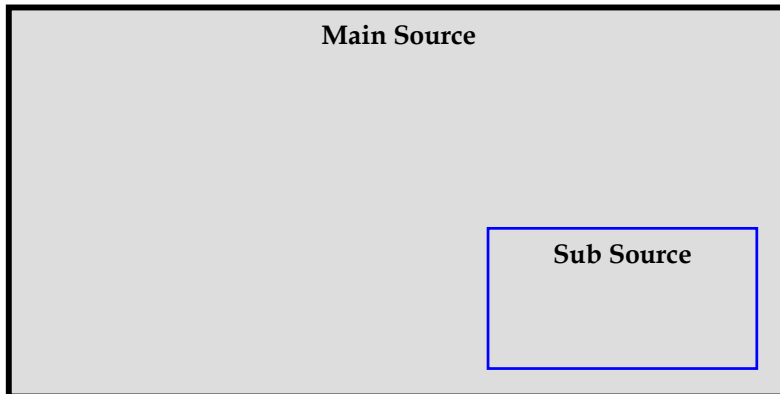

8. **Side by Side Model:** Press **SS-POSITION** button choose “Side by side” mode, then the main source and the subsource will be on the screen display.

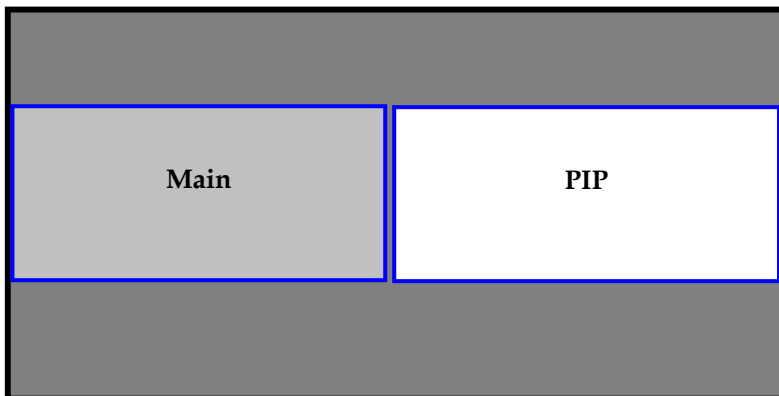

Split Screen Table

	HDMI 1	HDMI 2	VGA	Component	S-Video	Video
HDMI 1	–	–	Yes	Yes	Yes	Yes
HDMI 2	–	–	Yes	Yes	Yes	Yes
VGA	Yes	Yes	–	Yes	Yes	Yes
Component	Yes	Yes	Yes	–	Yes	Yes
S-Video	Yes	Yes	Yes	Yes	–	Yes
Video	Yes	Yes	Yes	Yes	Yes	–

Using the Menus

Menu Overview

Image Settings (1/2)

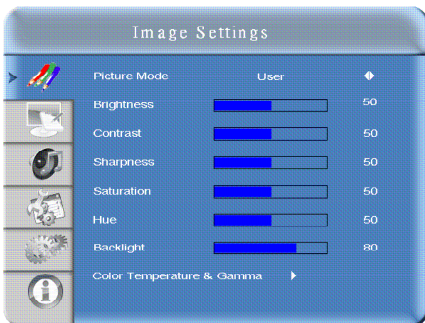

Audio Settings



Image Settings (2/2)

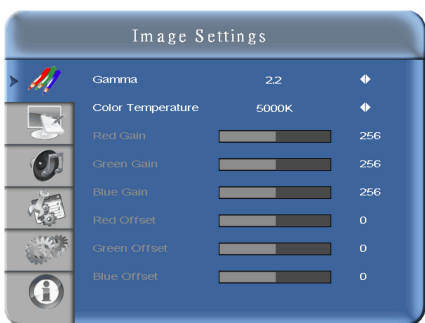

Basic Settings

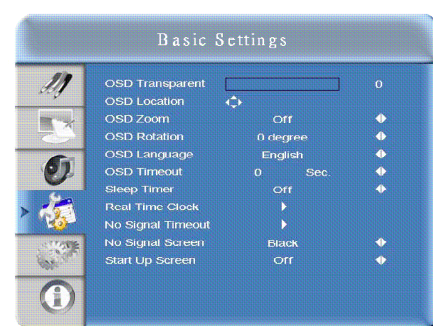

Display Settings

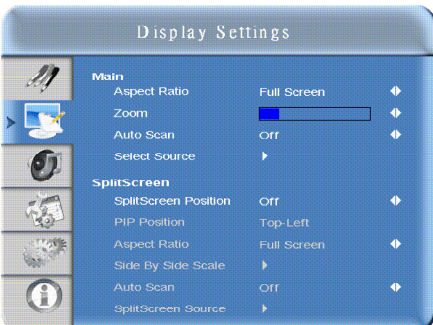

Advanced Setting



System Status

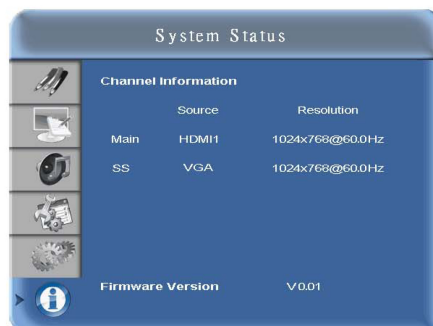

Using the Menus (Continued)

Navigating through the Menu System

1. With the power on, press **MENU**. The **Image Settings** menu will display.
2. Within the menu, use **▲, ▼, ◀, ▶**, and **ENTER** to navigate through the menus and adjust options.
3. Press **MENU** to return to the previous menu. To exit the menu system, press **EXIT**.

Image Settings Menu

This menu is used for making common image adjustments.

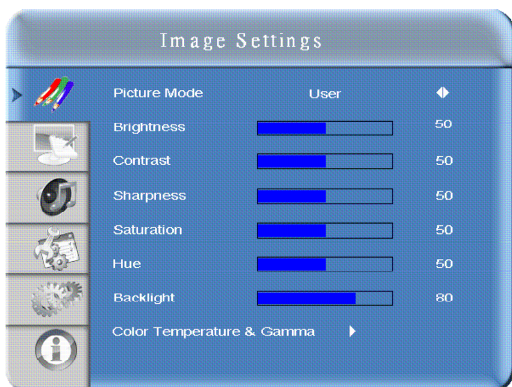

Picture Mode

Press **◀** or **▶** to select one of the following:

Options: User, Presentation, Video and Bright

Default: Presentation

Brightness

Increases or decreases the brightness of picture. Press **◀** or **▶**, select the desired level, and then press **ENTER**.

Range: 0~100; **Default:** 50

Contrast

Increases the contrast of picture (color becomes dark), or decreases the contrast of picture (color becomes pastel). Press **◀** or **▶**, select the desired level, and then press **ENTER**. **Range:** 0~100; **Default:** 50

Sharpness

Adjusts the definition of picture. Press **◀** or **▶**, select the desired level, and then press **ENTER**. **Range:** 0~24; **Default:** 10

Saturation

Adjusts the brilliance and brightness (only Video Mode). Press **◀** or **▶**, select the desired level, and then press **ENTER**. **Range:** 0~100; **Default:** 50

Hue

Increases or decreases the green hue (Only Video Mode). Press **◀** or **▶**, select the desired level, and then press **ENTER**. **Range:** 0~100; **Default:** 50

Back Light

Range: 0~100; **Default:** 80

Color Temp and Gamma

Adjusts red, green, blue gain and red, green blue offset.

Using the Menus (Continued)

Image Settings Menu (continued)

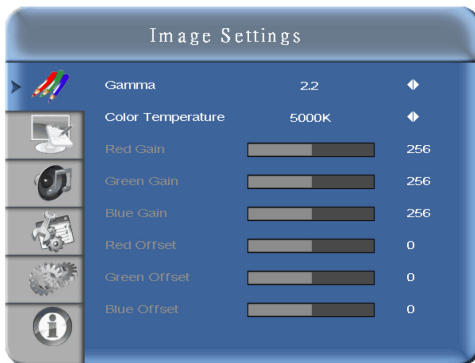

Gamma

Options: Off, 2.2
Default: 2.2

Color Temp

Options: User, 5000K, 6500K, 7500K and 9300K.
Default: Dependent on Picture mode

Red Gain

Set Color Temperature to "User Mode" in order to adjust this setting.
Range: 128~384
Default: 256

Green Gain

Set Color Temperature to "User Mode" in order to adjust this setting.
Range: 128~384
Default: 256

Blue Gain

Set Color Temperature to "User Mode" in order to adjust this setting.
Range: 128~384
Default: 256

Red Offset

Set Color Temperature to "User Mode" in order to adjust this setting.
Range: -50~50
Default: 0

Green Offset

Set Color Temperature to "User Mode" in order to adjust this setting.
Range: -50~50
Default: 0

Blue Offset

Set Color Temperature to "User Mode" in order to adjust this setting.
Range: -50~50
Default: 0

Using the Menus (Continued)

Display Settings Menu

This menu is used for common source adjustments.

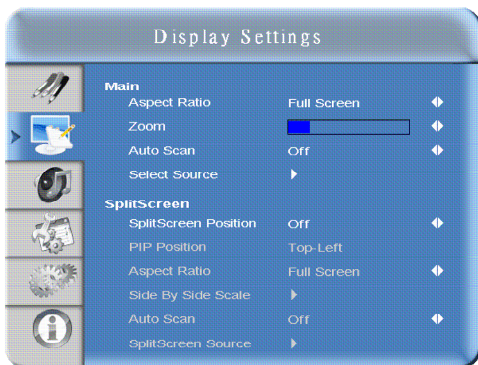

Main

The Display Setting Mode.

Aspect Ratio

Changes the picture aspect ratio
Press ◀, ▶ to select the following options:
Options: Auto, Native, 4x3, 16x9, 16x10 and Letter Box.
Default: Auto

Zoom

Range: 0~10
Default: 0

Auto Scan

Range: On, Off
Default: On

Select Source

Options: HDMI1, HDMI2, VGA, Component, S-Video and Video
Default: HDMI1

Split Screen

Split Screen Position

Options: Off, Large PIP, Middle PIP, Small PIP and Side-by-Side
Default: Off

PIP Position

Options: Bottom-Right, Top-Left, Top-Right and Bottom-Left
Default: Bottom-Right

Aspect Ratio

Options: Auto, 4x3, 16x9, 16x10 and Letter Box
Default: Auto

Side by Side Scale

Submenu Options: Zoom In, Zoom Out, Main, PIP, Default and Return

Auto Scan

Options: On, Off
Default: On

Split Screen Source

Options: HDMI1, HDMI2, VGA, Component, S-Video and Video
Default: VGA

Using the Menus (Continued)

Audio Settings Menu

This menu is used for adjusting volume settings.

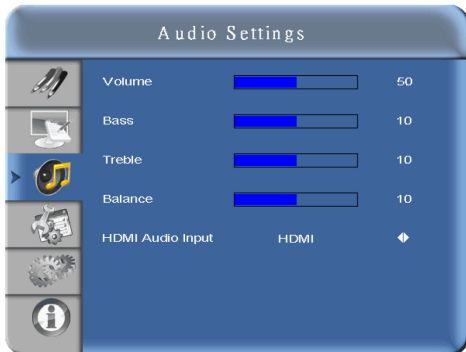

Volume

Adjust the sound. Press ◀ or ▶, select the desired level, and then press ENTER.
Range: 0~100
Default: 50

Bass

Adjust the sound in low tones (bass). Press ◀ or ▶, select the desired level, and then press ENTER.
Range: 0~20
Default: 10

Treble

Adjust the sound in high tones (Treble). Press ◀ or ▶, select the desired level, and then press ENTER.
Range: 0~20
Default: 10

Balance

Adjust the balance of the left and right speakers. Press ◀ or ▶, select the desired level, and then press ENTER.
Range: 0~20
Default: 10

HDMI Audio Input

Select HDMI and PC audio input mode.
Default: HDMI

Using the Menus (Continued)

Basic Settings Menu

This menu is used to make initial set-up adjustments to the OSD (On-Screen Display) menu and other on-screen messages. These adjustments are not normally changed often.

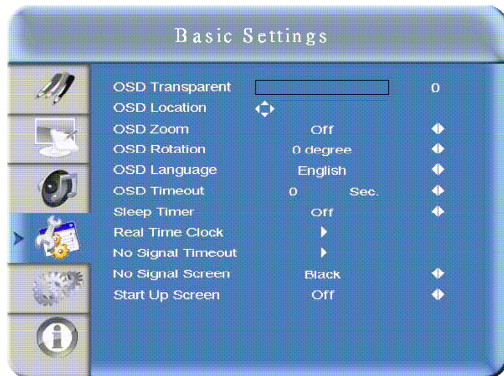

OSD Transparent

Set the menu transparency. Press ◀ or ▶ to select the desired level, and then press ENTER.

Range: 0~100

Default: 0

OSD Location

Adjust the menu location on the monitor (Up, Down, Left, Right).

OSD Zoom

Options: On, Off

Default: Off

OSD Rotation

Select the OSD Rotation. Press ◀ ▶ select the rotation.

Options: 0, 90, 180 and 270 degree

Default: 0 degree

OSD Language

Default: English

OSD Timeout

Options: 5~120

Default: 30

Sleep Timer

Set up a period of time after which the monitor set will switch to standby mode automatically. Press ◀ ▶ to select the desired time limit.

Options: Off, 15, 30, 45, 60, 90, 120 Min

Default: Off

Real Time Clock

Set date, and switch alarm on and off. Use ▲, ▼, ◀, ▶ to adjust these options.

No Signal Timeout

Options: Off ~ 1200 Sec.

Default: 300 Sec.

No Signal Screen

Options: Black, Blue and InFocus Logo

Default: InFocus Logo

Start Up Screen

Options: Off, 3 Sec., 5 Sec. and 10 Sec.

Default: 3 seconds

Using the Menus (Continued)

Advanced Settings Menu

This menu provides more complex adjustments for the user to modify, if desired.



Auto Adjustment

Forces the monitor to reacquire and lock to the input signal. This is useful when the signal quality is marginal. Note: This feature does not continually reacquire the signal.

Options: No, Yes

Default: No

Image Position

Image location can be adjusted (Only VGA Mode).

Options: Up, Down, Left, Right

Phase

Range: 0~63 (Only VGA Mode)

Clocks

Range: 0~100 (Only VGA Mode)

Flesh Tone

Options: Off, Low, Medium and High (Only Video Mode)

Default: Off

Front LED

Options: On and Off

Default: On

Anti-Burn-In

Creates slight frame motion to help avoid image retention when the image is static for a specified amount of time.

Options: Off, 1 Hour, 2 Hours and 4 Hours

Default: 1 Hour (On)

Baud Rate

Options: 115200, 38400, 19200, 9600

Default: 115200

Factory Reset

Restores all settings to their default.

Options: No, Yes

Default: No

Using the Menu (Continued)

System Status Menu

This read-only menu provides information on the active sources and the latest firmware version.

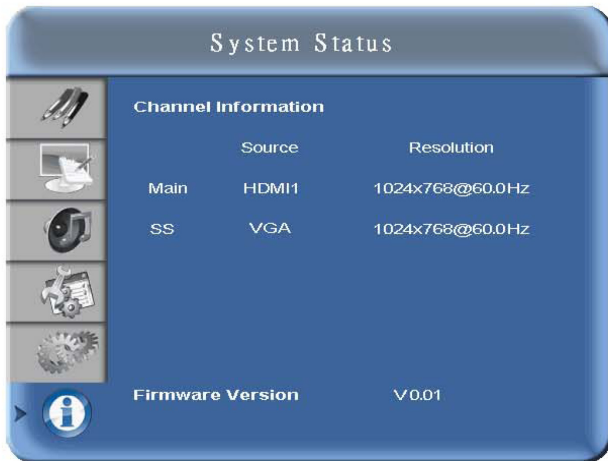

Specifications

INF6501

	Item	Specification
LCD panel	Resolution	1920 x 1080 (HD monitor format)
	Brightness	450 cd/m ²
	Contrast Ratio	5000
	Response time (GTG)	5.5 ms
	Aspect Ratio	16:9
	Backlight Life Time	50000 hrs
	Horizontal Sync.	Positive / Negative
	Vertical Sync.	Positive / Negative
	Connectors	HDMI1, HDMI2, Component (with Audio L/R), S-Video (with Audio L/R – shared with Video), Video (with Audio L/R – shared with S-Video), PC (with PC Audio In), SPDIF, RS232
Scan Rate	Horizontal	31~91 KHz
	Vertical	56~85 Hz
Performance	Auto Adjust	Clock, Phase, H-Position and V-Position
	Screen Scaling	VGA/SVGA/XGA/WXGA/HD monitor Full Screen Display, WUXGA
	Power Management	VESA DPMS
	OSD Language	English
Power Source	Power Input	AC 100V~240V
Power Consumption	Operation Mode (Typ.)	578W
	Power Saving Mode (Typ.)	1W
	Input Frequency Range	50 Hz ~ 60 Hz
	Rated Input Volt	AC 100V~240V
Physical	Dimension (W×H×D)	1567.6mm x 942.6mm x 155.7mm (61.7" x 37.1" x 6.1")
	Net Weight	67.0 KG (147.7 lbs)
	Gross Weight w/ packing	89.0 KG (196.2 lbs)
Environment	Storage Temperature	Min -5°C ~ Max 50°C
	Operating Temperature	Min 5°C ~ Max 35°C
	Humidity	90% RH @40°C
DDC	Plug and Play	DDC 2B Compliance
Audio	Speaker	Input 1Vp-p, Output: 10W/4Ω x2
Function	RS232	D-Sub 9-pin
	OSD key	7 keys (⏏, SOURCE, ▶, ◀, ▲, ▼, MENU/EXIT)
	Wall mount	VESA standard
IR Arrive Distance	Angle (horizontal)	Distance at noted angle (Typ.)
	± 0°	7 meters (23'0")
	±30°	3 meters (9'10")
	±45°	2.5 meters (8'2")

Specifications (Continued)

INF5501

	Item	Specification
LCD panel	Resolution	1920 x 1080 (HD monitor format)
	Brightness	450 cd/m ²
	Contrast Ratio	5000
	Response time (GTG)	4.5 ms
	Aspect Ratio	16:9
	Backlight Life Time	50000 hrs
	Horizontal Sync.	Positive / Negative
	Vertical Sync.	Positive / Negative
	Connectors	HDMI1, HDMI2, Component (with Audio L/R), S-Video (with Audio L/R - shared with Video), Video (with Audio L/R - shared with S-Video), PC (with PC Audio In), SPDIF, RS232
Scan Rate	Horizontal	31~91 KHz
	Vertical	56~85 Hz
Performance	Auto Adjust	Clock, Phase, H-Position and V-Position
	Screen Scaling	VGA/SVGA/XGA/WXGA/HD monitor Full Screen Display, WUXGA
	Power Management	VESA DPMS
	OSD Language	English
Power Source	Power Input	AC 100V~240V
Power Consumption	Operation Mode (Typ.)	273W
	Power Saving Mode (Typ.)	1W
	Input Frequency Range	50 Hz ~ 60 Hz
	Rated Input Volt	AC 100V~240V
Physical	Dimension (W×H×D)	1307.0mm x 777.8mm x 134.1mm (51.5" x 30.6" x 5.3")
	Net Weight	43.8 KG (96.5 lbs)
	Gross Weight w/ packing	54.0 KG (119.0 lbs)
Environment	Storage Temperature	Min -5°C ~ Max 50°C
	Operating Temperature	Min 5°C ~ Max 35°C
	Humidity	90% RH @40°C
DDC	Plug and Play	DDC 2B Compliance
Audio	Speaker	Input 1Vp-p, Output: 10W/4Ω x2
Function	RS232	D-Sub 9-pin
	OSD key	7 keys (⏏, SOURCE, ▶, ◀, ▲, ▼, MENU/EXIT)
	Wall mount	VESA standard
IR Arrive Distance	Angle (horizontal)	Distance at noted angle (Typ.)
	± 0°	7 meters (23'0")
	±30°	3 meters (9'10")
	±45°	2.5 meters (8'2")

Specifications (Continued)

INF4201

	Item	Specification
LCD panel	Resolution	1920 x 1080 (HD monitor format)
	Brightness	400 cd/m ²
	Contrast Ratio	5000
	Response time (GTG)	6.5 ms
	Aspect Ratio	16:9
	Backlight Life Time	50000 hrs
	Horizontal Sync.	Positive / Negative
	Vertical Sync.	Positive / Negative
	Connectors	HDMI1, HDMI2, Component (with Audio L/R), S-Video (with Audio L/R - shared with Video), Video (with Audio L/R - shared with S-Video), PC (with PC Audio In), SPDIF, RS232
Scan Rate	Horizontal	31~91 KHz
	Vertical	56~85 Hz
Performance	Auto Adjust	Clock, Phase, H-Position and V-Position
	Screen Scaling	VGA/SVGA/XGA/WXGA/HD monitor Full Screen Display, WUXGA
	Power Management	VESA DPMS
	OSD Language	English
Power Source	Power Input	AC 100V~240V
Power Consumption	Operation Mode (Typ.)	201W
	Power Saving Mode (Typ.)	1W
	Input Frequency Range	50 Hz ~ 60 Hz
	Rated Input Volt	AC 100V~240V
Physical	Dimension (W×H×D)	1021mm x 614mm x 124mm (40.2" x 24.2" x 4.9")
	Net Weight	22.0 KG (48.5 lbs)
	Gross Weight w/ packing	28.0 KG (61.7 lbs)
Environment	Storage Temperature	Min -5°C ~ Max 50°C
	Operating Temperature	Min 5°C ~ Max 35°C
	Humidity	90% RH @40°C
DDC	Plug and Play	DDC 2B Compliance
Audio	Speaker	Input 1Vp-p, Output: 10W/4Ω x2
Function	RS232	D-Sub 9-pin
	OSD key	7 keys (⏏, SOURCE, ▶, ◀, ▲, ▼, MENU/EXIT)
	Wall mount	VESA standard
IR Arrive Distance	Angle (horizontal)	Distance at noted angle (Typ.)
	± 0°	7 meters (23'0")
	±30°	3 meters (9'10")
	±45°	2.5 meters (8'2")

Maintenance

Regular maintenance of the monitor is recommended.

Dust the rear cover of the monitor regularly using a soft, dry cloth. Dust on the rear cover may cause the cooling system of the monitor to fail. To remove stubborn dust, only use a moistened (not dripping) cloth which has been dipped in a mild detergent solution. See important notes below.

To clean the LCD surface, apply a non-abrasive camera lens cleaner to a soft, dry cloth. Lightly wipe the cleaning cloth over the LCD surface in a circular motion. Avoid using an excessive amount of cleaner, and do not apply the cleaner directly on the LCD surface. Abrasive cleaners, solvent or other harsh chemicals might scratch the LCD surface.

Image brightness may decrease after long-term use. In this case, the interior of the monitor may need to be cleaned. Do not attempt to clean the monitor yourself. Contact InFocus Corporation (www.infocus.com/service) for service assistance.

 **Note:**

1. Unplug the AC power cord before cleaning the monitor to avoid a shocking hazard.
2. When cleaning the monitor, avoid pressing too hard on the monitor surface. Excessive force can cause damage to the monitor.
3. Do not use paper products or similar items to wipe the LCD screen. These materials can easily scratch the LCD surface. Only use a soft dry cloth.
4. Keep sharp objects, such as writing utensils and screwdrivers, away from the LCD surface to avoid screen damage.
5. Avoid cleaning monitors with solutions which contain ammonia, ethyl alcohol, acetone, toluene, ethyl acid, or methyl chloride. These chemicals will damage your monitor.

Troubleshooting

<i>Problem</i>	<i>Possible Solution</i>
No power	<ul style="list-style-type: none"> • Verify the power cord is properly connected to the power outlet and to the monitor. • Verify the monitor power switch is ON (INF5501 and INF6501 only) and that the power button (all models) is ON. • Plug another electrical device (like a radio) to the power outlet to verify that the outlet is supplying the proper voltage.
No picture	<ul style="list-style-type: none"> • Verify that connections between the source and the monitor have been made correctly. • Verify that the cables are in good condition. • Verify the correct input source is selected and that the input signal is compatible with the monitor.
No sound	<ul style="list-style-type: none"> • Verify that audio connections between the source and the monitor have been made correctly. • MUTE may have been pressed, try pressing this button again. • Press the VOLUME + on the remote control.
Remote control does not function properly	<ul style="list-style-type: none"> • Verify the batteries in the remote are properly aligned. • The batteries may be weak or dead. Replace batteries. • There may be infrared interference from fluorescent lights or infrared equipment nearby. Move closer to the remote sensor on the monitor, or turn off items which may be interfering with the remote's infrared signal. • The path of the remote control beam may be blocked. Verify the path is clear and that the remote control is aimed at the remote control sensor on the monitor. • Press POWER on the remote control to see if you can turn on the monitor. • Press MENU on the remote control to see if a menu will display on the screen.
Monitor shuts-down suddenly	<ul style="list-style-type: none"> • The Sleep Timer may be activated. Turn on the monitor and check the Sleep Timer setting. • Verify that a source is active. • The monitor may have overheated. Remove any objects blocking the vent and clean as necessary.
Strange or faded colors, or color misalignment	<ul style="list-style-type: none"> • Ensure that the video cable is connected securely. • The picture may appear dim in a brightly lit room. • Adjust brightness, contrast, saturation (color), and tint. • Check the input signal setting.
Monitor will not power on	<ul style="list-style-type: none"> • Lightning, static electricity and other external events may cause the monitor to act abnormally. In this case, unplug the power cord and wait for 1 to 2 minutes, then plug back in and attempt to power up the monitor again.
No color/dark picture/color is not correct	<ul style="list-style-type: none"> • Adjust the color saturation in the menu system.
Audio noise	<ul style="list-style-type: none"> • Noise can occur when infrared communication equipment (e.g., infrared cordless headphones) is used near the monitor. Move the infrared communication equipment away from the monitor to eliminate the noise.

Caution:

DO NOT attempt to repair a defective monitor yourself. If the above tips do not solve the problem, contact InFocus Corporation (www.infocus.com/service) for support/repair assistance.

Free Manuals Download Website

<http://myh66.com>

<http://usermanuals.us>

<http://www.somanuals.com>

<http://www.4manuals.cc>

<http://www.manual-lib.com>

<http://www.404manual.com>

<http://www.luxmanual.com>

<http://aubethermostatmanual.com>

Golf course search by state

<http://golfingnear.com>

Email search by domain

<http://emailbydomain.com>

Auto manuals search

<http://auto.somanuals.com>

TV manuals search

<http://tv.somanuals.com>