



AIR CONDITIONER

(Portable Type)

KKP009H0R51B

OWNER'S MANUAL

Thank you very much for choosing our air conditioner.
Please read this owner's manual carefully before using your air conditioner.



CONTENTS

1.SAFETY RULES.....	1
2.NAMES OF PARTS.....	2
3.ACCESSORIES.....	3
4.OPERATION PANEL OF THE AIR CONDITIONER.....	4
5.OPERATING INSTRUCTION FOR THE AIR CONDITIONER	5
6.THE REMOTE CONTROL UNIT(RCU).....	7
7.OPERATION BUTTONS ON THE RCU.....	9
8.NAMES AND FUNCTIONS FOR THE OPERATION PANEL WINDOW OF THE RCU.....	11
9.OPERATING INSTRUCTIONS FOR THE RCU.....	12
10.INSTALLATION.....	15
11.MAINTENANCE.....	16
12.TROUBLE SHOOTING.....	17

SAFETY RULES

1. DO NOT CONNECT UNIT TO ANY AC SOCKET IN DISREPAIR OR WITH CONNECTIONS.
2. DO NOT USE IN THE FOLLOWING LOCATIONS:
 - NEXT TO SOURCE OF FIRE.
 - AN AREA WHERE OIL IS LIKELY TO SPLASH.
 - AN AREA EXPOSED TO DIRECT SUNLIGHT.
 - AN AREA WHERE WATER IS LIKELY TO SPLASH.
 - NEAR A BATH, A SHOWER OR A SWIMMING POOL
 - IN THE GREEN HOUSE
3. NEVER INSERT YOUR FINGERS OR ANY FOREIGN OBJECTS INTO THE AIR OUTLET. TAKE SPECIAL CARE TO WARN CHILDREN OF THESE DANGERS.
4. ALWAYS STORE THE UNIT UPRIGHT IN ORDER TO MAINTAIN THE COMPRESSOR IN A PROPER CONDITION.
5. BE SURE TO UNPLUG THE UNIT BEFORE CLEANING.
6. THE HEATER MUST NOT BE LOCATED IMMEDIATELY BELOW A SOCKET OUTLET.
7. IF THE APPLIANCE IS COVERED, THERE IS A RISK OF OVERHEAT.
8. IF THE SUPPLY COOL OF THIS APPLIANCE IS DAMAGED, IT MUST BE REPLACED BY A REPAIR SHOP APPOINTED BY THE MANUFACTURER, BECAUSE SPECIAL PURPOSE TOOLS ARE REQUIRED.





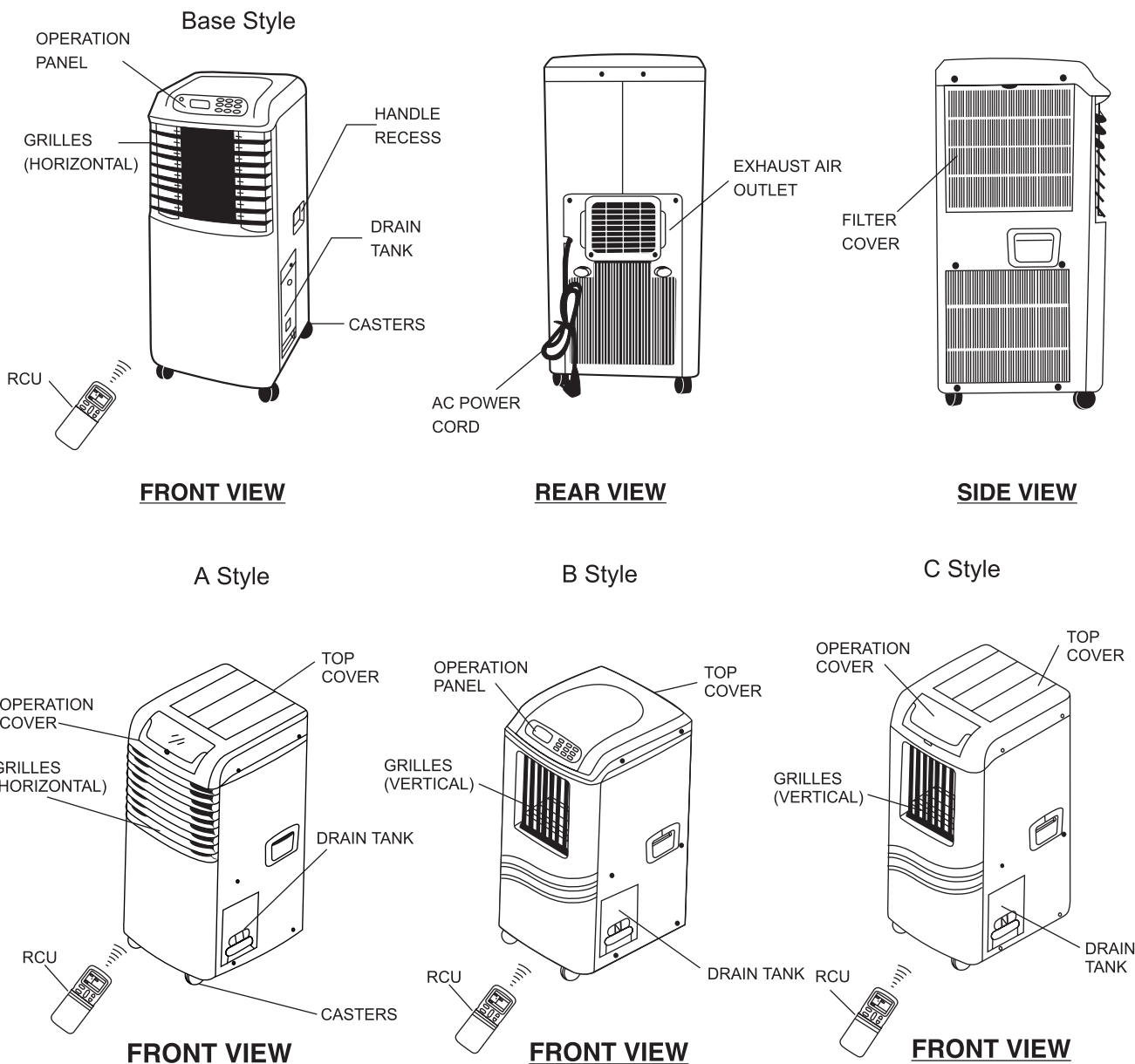

NOTE: The air-conditioner can be connected only to a supply with system impedance no more than 0.4582 ohm. In case necessary, please consult your supply authority for system impedance information.

NAMES OF PARTS

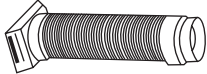

Note: The Rear View and Side View as well as the performance of above styles are same as that of base style.

ACCESSORIES

PARTS :	PARTS NAME :	QUANTITY :
	DUCT	1
	ADAPTOR A (FOR PERMANENT DUCT MOUNTING)	1
	ADAPTOR B (FOR TEMPORARY DUCT MOUNTING)	1
	WALL PLUG	4
	SCREWS	4
	ALKALINE BATTERIES	2
	REMOTE CONTROL UNIT	

- Check all the accessories are included in the package and please refer to the installation instructions for their usage.

OPERATION PANEL OF THE AIR CONDITIONER

WATER FULL INDICATOR :
Red lamp will blink when the drain tank is full or misplaced.

POWER BUTTON :
Turn on/off the unit.

SELECTION BUTTON :
Select the operation mode from COOL DEHUMIDIFY, *(HEAT) AND FAN.

TEMP./CLOCK SETTING BUTTON:
Preset your desired room temperature/ clock setting by pressing the button "▲" (up) or button "▼" (down)

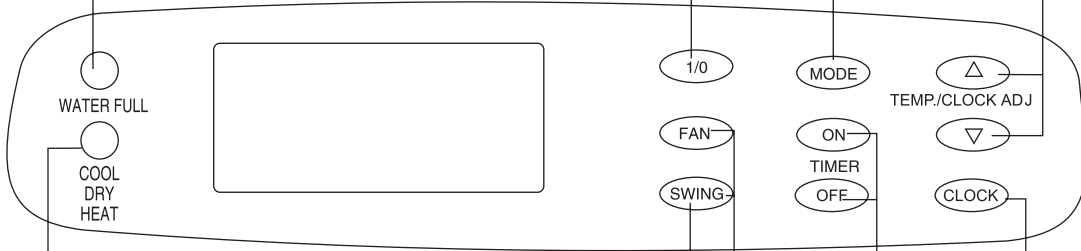

OPERATING PANEL

COOL/DRY/HEAT INDICATOR :
Green lamp will light when the compressor operates. Red lamp will light when HEATING mode is selected.

LOUVER BUTTON :
The louver automatically varies the horizontal direction of air flow from left to right.

FAN SPEED BUTTON :
Switch the fan speed to HIGH, MED or LOW when at COOL & FAN mode; HIGH or LOW when at * HEAT mode.

ON/OFF TIMER BUTTON:
Program the ON/OFF timer function.

CLOCK SETTING BUTTON:
Setting the clock by pressing the "CLOCK" - button for 3 seconds and then pressing the "▲" and the "▼" - TEMP./COLCK ADJ. buttons to adjust to correct time. Press "CLOCK" - button when complete.

* HEAT FEATURE IS ONLY AVAILABLE IN HEATING/COOLING MODELS

TIMER ON/OFF DISPLAY.

CLOCK/ TIMER DISPLAY

OPERATING MODE DISPLAY.

FAN SPEED DISPLAY.

LOUVER ON/OFF DISPLAY.

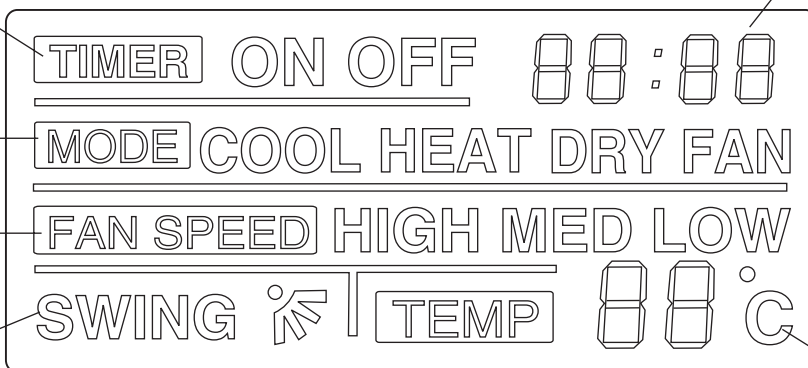

PRESET TEMPERATURE DISPLAY.

OPERATING PANEL WINDOW

OPERATING INSTRUCTIONS FOR THE AIR CONDITIONER

Before Starting This Unit

- 1) Select a suitable location, making sure you have easy access to an electrical outlet.
- 2) Install the **Flexible Exhaust Hose** and the **Adjustable Window Slider Kit** as depicted in *Fig. 3* & *Fig.3a*.

NOTE: Step 2 is required only while using the **COOLING MODE**.

- 3) Plug the unit into a 220-240V~ 50Hz or 220V~ 60Hz grounded electrical outlet.
- 4) Make sure the Water Tank is correctly positioned inside the cabinet otherwise the unit will not operate (*Fig 4*).
- 5) To turn the unit on, press the 1/0 key (On / Off Switch) .

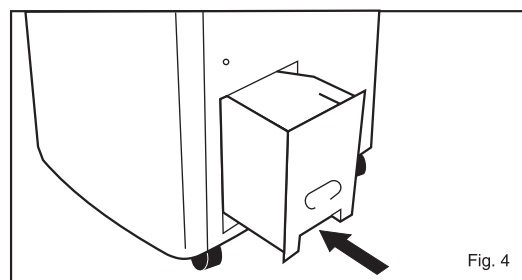
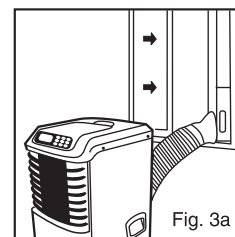
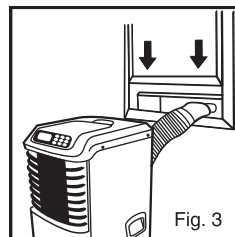

1 BEFORE USE

Dehumidifying and Cooling Operations:

- The operating range for dehumidifying is 10°C-30°C, and the operating range for cooling operating is 17°C-30°C.
- If the cooling or dehumidifying operations have been switched off and need switching on again in a short time, allow approximately three minutes for the cooling or dehumidifying operations to resume.
- Ensure that the drain tank is properly placed in the unit.

Power supply:

- The operation condition is 18°C-35°C
- Insert the AC Power Plug to a AC socket.
- Do not connect the air conditioner to a multiple socket outlet which is also being used for other electrical appliance.
- Be sure the power supply is AC 220-240V~ 50Hz or 220V~ 60Hz

2 COOLING OPERATION

- Press the "MODE" button several times until the Operating Panel Window display " COOL".
- Press the "TEMP/CLOCK ADJ" buttons" ▲ or ▼" to select your desired room temperature.(17°C - 30°C)
- Press the "FAN" button to choose the fan speed.

3 DEHUMIDIFYING OPERATION

- Press the "MODE" button several times until the Operating Panel Window display "DRY".
- Press the "TEMP/CLOCK ADJ" buttons "▲" or "▼" to select your desired room temp. (10°C - 30°C)
- The fan will run at a fixed speed at this setting.
- Keep windows and doors closed for the best dehumidifying effect.
- Do not put the duct to window.

4 HEATING OPERATION

- Press the "MODE" button several times until the Operating Panel Window display "HEAT".
- Press the "TEMP/CLOCK ADJ" buttons "▲" or "▼" to select your desired room temperature. (17°C - 30°C)
- Press the "FAN" button to choose the fan speed.
- Do not put the duct to window.

5 FAN OPERATION

- Press the "MODE" button several times until the Operating Panel Window display "FAN".
- Press the "FAN" button to choose the fan speed.
- Do not put the duct to window.

6 TIMER OPERATION

Setting the on timer:

- Press the "TIMER ON" or "TIMER OFF" button when the air conditioner is off. Select the time you need the unit start to operate. Press "CLOCK" - button when complete. The Operation Panel Window will display "TIMER ON".
- The starting time is adjustable from 00:00 to 23:50.

Setting the off timer:

- Press the "TIMER ON" or "TIMER OFF" button when the air conditioner is on. Select the time you need the unit turn off. Press "CLOCK" - button when complete. The Operation Panel Window will display "TIMER OFF".
- The turning off time is adjustable from 00:00 to 23:50.

7 AUTOMATIC LOUVER

- Press the "SWING" button and the louver (horizontal or vertical grilles) will automatically move to control direction of air flow. The Operation Panel Window will display "SWING".

• For Base Style and A Style:

The inside vertical grilles move automatically to change the air flow direction from left to right. At the same time, you can adjust manually the outside horizontal grilles to change air flow from upside to downside.

Note:

- 1) Always keep horizontality the piece of grille on the top place when turn up the horizontal grilles.
- 2) Always keep horizontality the piece of grille on the bottom place horizontal when turn down the horizontal grilles.

• For B Style and C Style:

The outside vertical grilles move automatically to change the air flow direction from left to right. At the same time, you can adjust manually the inside horizontal grilles to change air flow from upside to downside.

- To stop the movement of louver, press the "SWING" button again.

8 DRAIN TANK INDICATOR

- The unit will signal 8 beeps and the water full indicator light will flash red continuously when the water tank is full. The unit stops working.
- Please dump the water and put back the water tank correctly into the cabinet. The unit will work again.

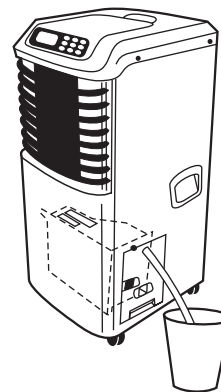

ATTENTION

In case the water tank is not emptied within 3 minutes and the unit will shut off automatically. Please press 1/0 button to restart the unit after the emptied water tank is correctly positioned inside the cabinet.

9 CONTINUOUS DRAINAGE

- Drain water can be collected externally by directing the plastic tube inside the Drain Tank Cabin through the Water Tank to any vessel such as bucket. Remove the plastic tube cap before operate.
- Do not take out the water tank during drainage.

The Remote Control Unit (RCU)

How to Use the Remote Control Unit

Effective Operation Range

The RCU should be used within the effective range of 7m from the air conditioner.

Holder for the RCU

This holder is included together with the RCU.

Installation of the Holder

Before installation, ensure that the Holder is at a location from where the RCU's signal can reach the air conditioner and operate effectively.

Holder/RCU Operation

When not in use, the RCU can rest in the Holder. The Holder will help prevent your RCU from being misplaced.

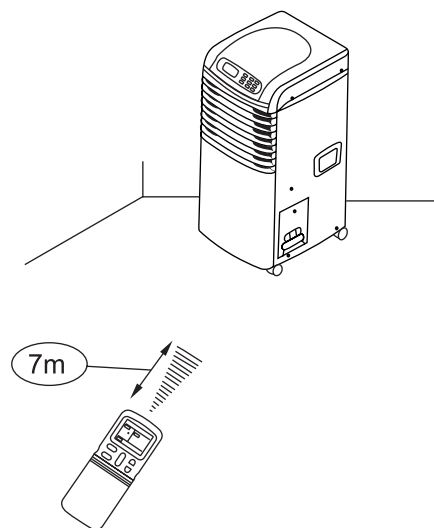

Precautions for Using the RCU

- Do not operate the RCU near contains, door or obstacles which may block the RCU's transmission of signals, otherwise the air conditioner will not work as controlled.
- Keep the RCU away from water or other fluid, direct sunlight or heat.
- Avoid direct sunlight to the infra-red receiver in the air conditioner, sunlight will affect the effectiveness off the air conditioner.
- Other electrical appliances may affect the signals from the RCU. Consult your nearest distributor should you encounter any problem.

Battery Installation

Type AM4 alkaline batteries should be used for the RCU.

1. Slide out the RCU lower cover, take out old batteries and replace by new ones.
2. Press the "reset" button.
3. Before closing the battery cover, please note that the time displayed on the unit's screen is "0:00" and the colon ":" blinks.
4. When installing new batteries, you have to reset the time on the RCU.

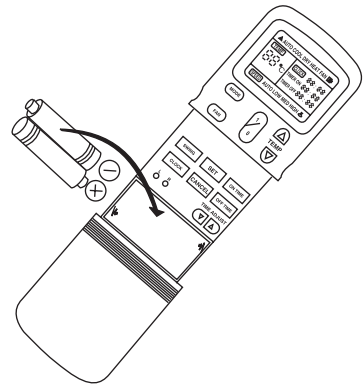

Caution

- Do not mix old batteries with new ones or use different brands or type of batteries otherwise the RCU will not work.
- When the RCU is not in use for periods of several weeks, take out of the batteries, otherwise any leakage from the batteries will ruin the RCU.
- Life of the batteries is about six months under normal use.
- Replace the batteries when you do not hear the sound of the receiver when operating or there is no display on the LCD screen.

OPERATION BUTTONS ON THE RCU

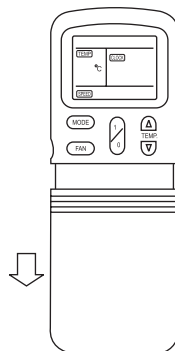
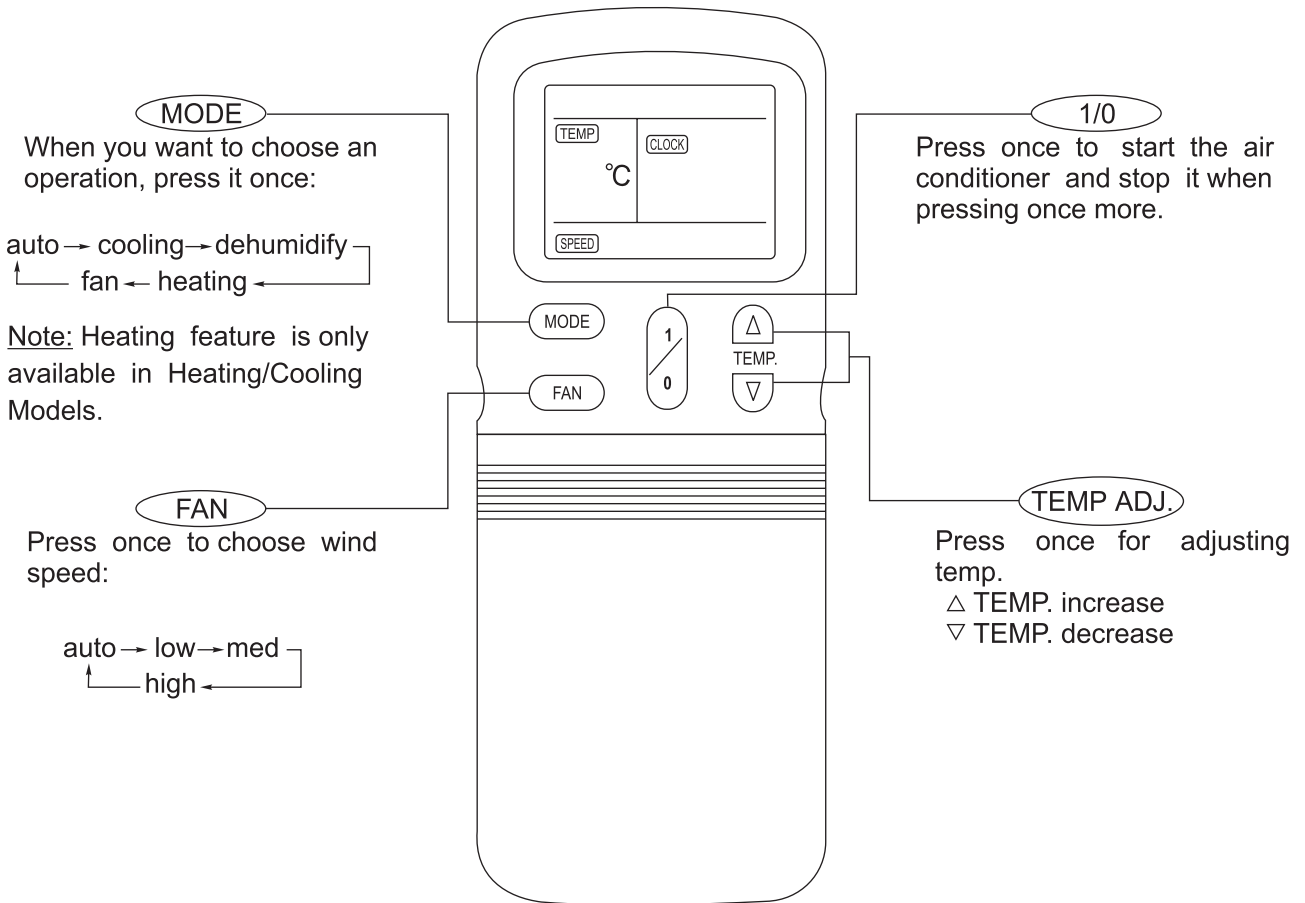

Slide out this lower

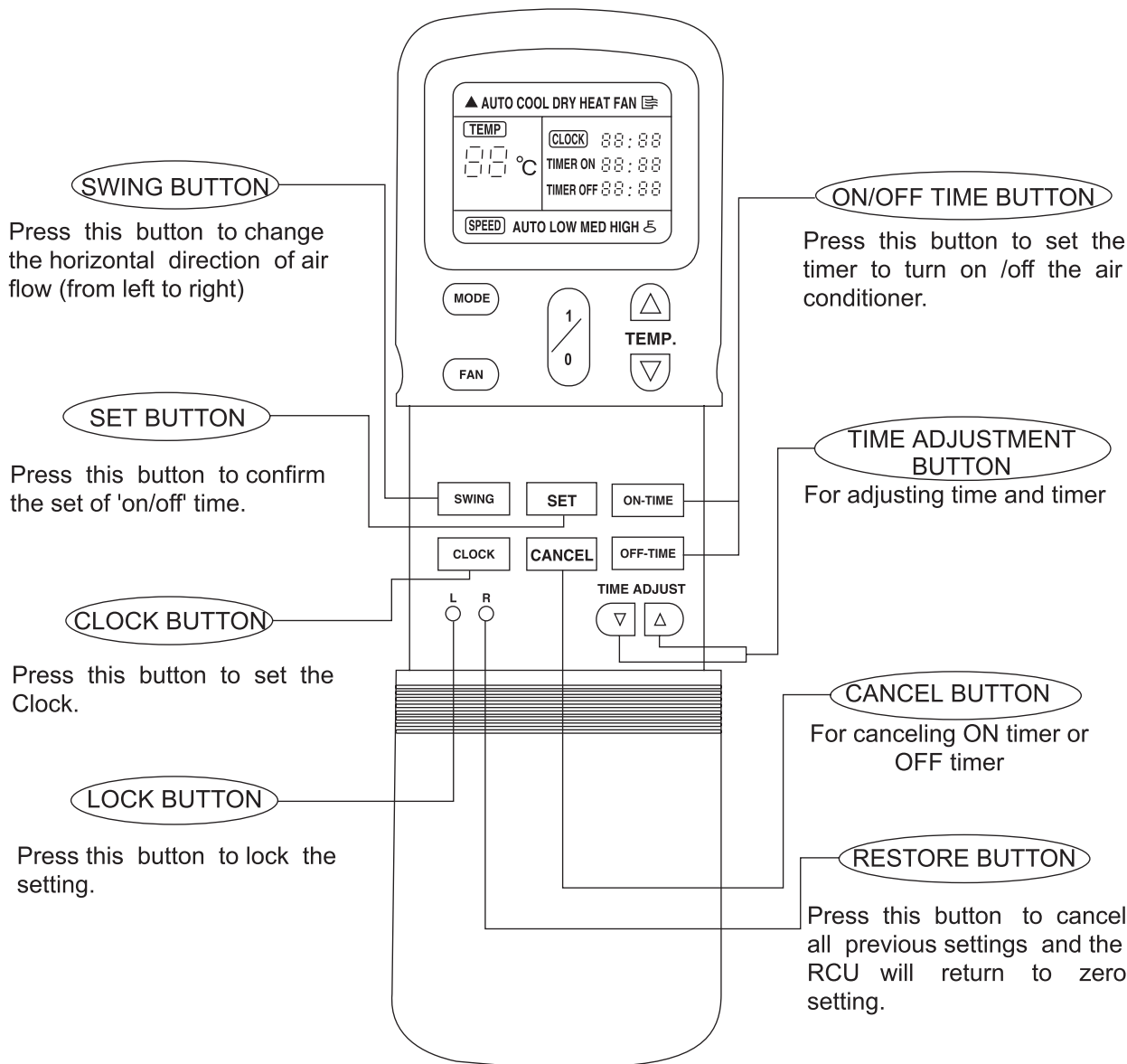

NTOE:

The two buttons: "AIR DIRECTION", "ECONOMIC RUNNING" on the remote controller do not effect on your air conditioner

NAMES AND FUNCTIONS FOR THE OPERATING PANEL WINDOW OF THE RCU.

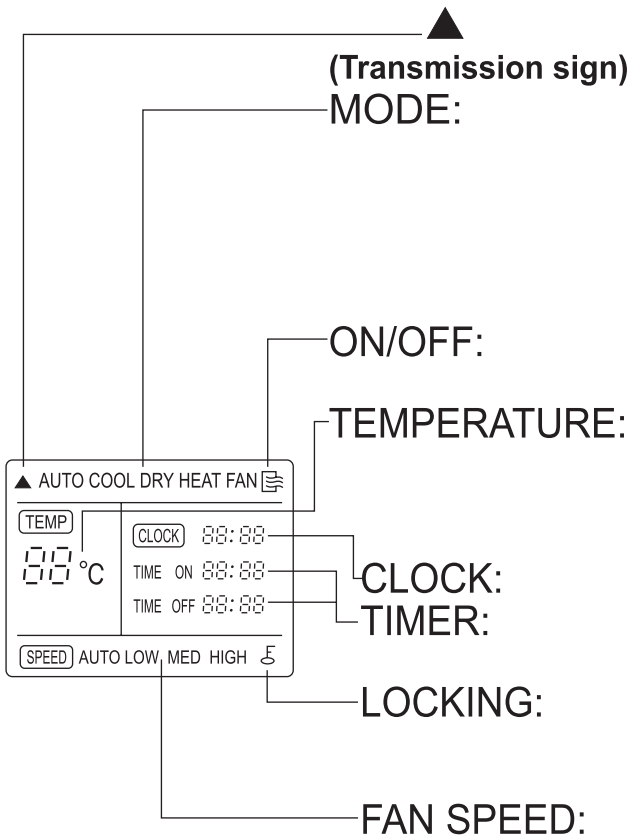

This sign flashes once when the signal from the RCU is transmitted to the air conditioner.

Press the "MODE" button to display the different operational mode. You can select different operations including "AUTO", "COOL", "DRY", "HEAT", "FAN".

Press once to switch ON or OFF. Press again to cancel display.

Press this button to display the selected temperature (the operating range is 17°C-30°C). The selected temperature will not display if operation mode is set to "FAN".

Displays (0-24 hours) of the day.

Press "ON-TIME" or "OFF-TIME" button to display the time selected. (0-24 hours). Press once the "LOCK" button to display the locking sign. The sign disappears when press it once more.

Press the "FAN" button to display the different fan speeds. You can select different fan speeds such as "AUTO", "LOW", "MEDIUM", "HIGH". When the operational mode is in "AUTO" or "DRY", the fan speed is set to "AUTO".

NOTE: All the signs appear in the operating panel window of the above figure are only for reference. During operation, only the signs for the corresponding operational mode will appear.

OPERATING INSTRUCTION FOR THE RCU

CLOCK SETTING

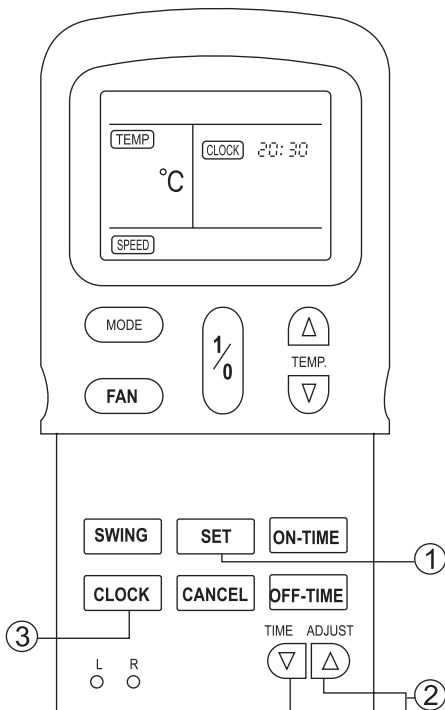

Before operation, please refer to the following step to set the time. The time should be set same as that of the main unit.

When new batteries are installed, the time displayed on the screen appears "0:00" and the colon blinks continuously.

Timer Preset

1. Press or to adjust the time.
2. Press **SET** button to start the time and the colon stops blinking.

Timer Reset

3. Keep pressing the **CLOCK** button for at least three seconds, the colon sign in the time displayed begins to blink.

Repeat step 1 and 2.

NOTE: Accuracy of time is less than 10 seconds per day.

AUTOMATIC OPERATION

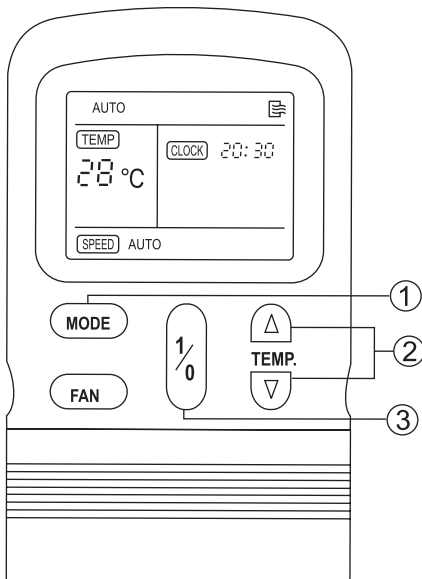



1. After installation of the air conditioner, check and make sure power is on and the Drain Tank is correctly positioned.
2. Press **MODE** button, then select "AUTO"
3. Press the **TEMP** button or to select your desired room temperature. Usually it should be set to 21°C ~ 28°C .
4. Press **1/0** button. The air conditioner start to operate automatically and the fan speed controls appears in "AUTO" mode.

Stop: Press the **1/0** button once again to cancel the operations.

NOTE: In "AUTO" mode, the air conditioner can select automatically the operation mode including "cooling", "ventilating" or "heating (for heating/cooling models only)".

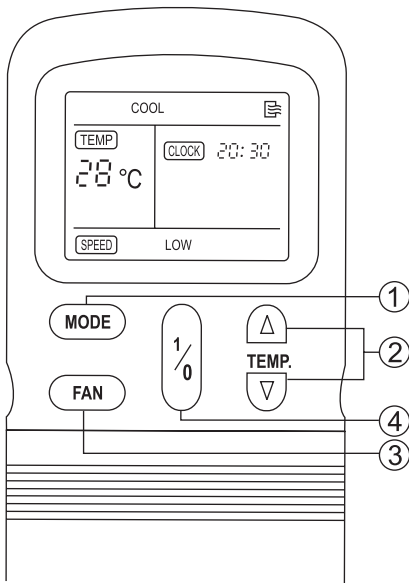
COOLING/HEATING/FAN OPERATION





1. Check and make sure power is on and the Drain Tank is correctly positioned.
2. Press **MODE** button to select "COOLING", "HEATING", "FAN" operation mode.
3. Press the **TEMP** button  or  to select your desired room temperature. Usually it should be set to 21°C or 28°C.
4. Press the **FAN** button to select your desired wind speed, including "AUTO", "LOW", "MED", "HIGH".
5. Press the **1/0** button and the air conditioner operates as you select.

Stop: Press **1/0** button once again to cancel the operations.

NOTE: In "FAN" operation mode, the temperature can not be controlled, and you need not to set the room temperature.

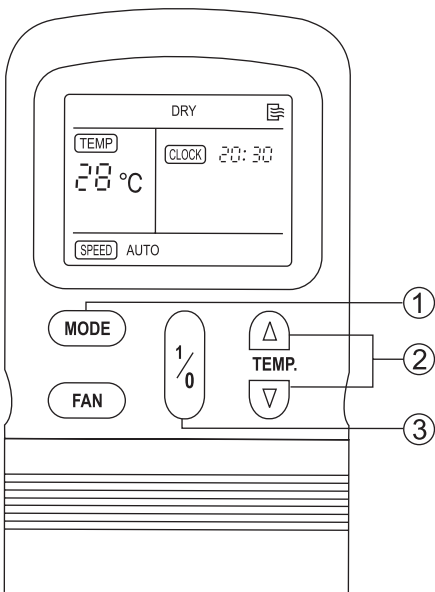
DEHUMIDIFYING OPERATION



1. After installation of the air conditioner, check and make sure power is on and the Drain Tank is correctly positioned.
2. Press **MODE** button, then select "DRY" as your operation mode.
3. Press the **TEMP** button  or  to select your desired room temperature. Usually it should be set to 21°C ~ 28°C.

4. Press **1/0** button. The air conditioner start to dehumidifying. The screen on the RCU indicates the fan speed as "AUTO".

Stop: Press the **1/0** button once again to cancel the operations.

NOTE: The dehumidifying mode operates and stops automatically when the preset temperature and the room temperature are different or same. This makes humidity of the room lower.

TIMER SETTING

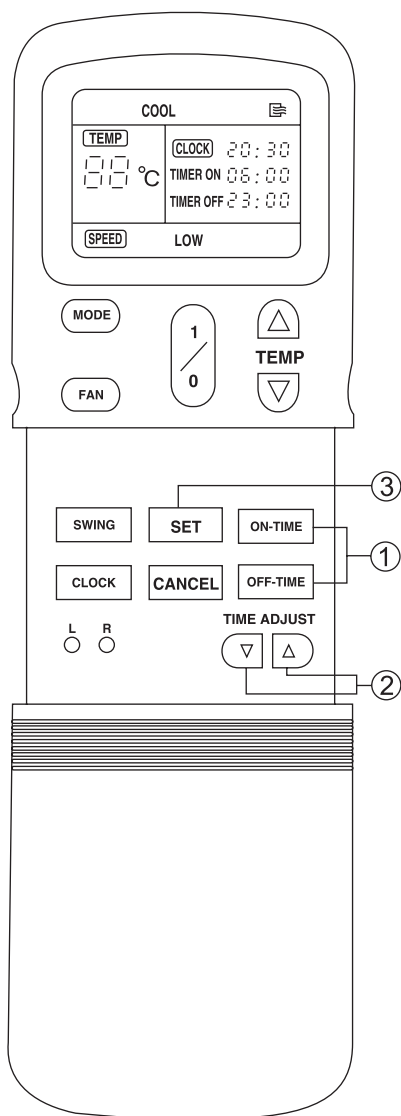

1. Before setting the timer, it is advisable to complete clock setting.

2. Press **ON-TIME** or **OFF-TIME** button, the time displayed in either these two modes will have the colon blinking.

3. Press the **TIME ADJUST** button  or  to adjust the correct time.

4. Press the **SET** button the screen of main unit display the time you have set, and the air conditioner switch on/off automatically according to your time setting.

CANCEL: Press the **CANCEL** button to cancel the timer reservation.

RESET: Press **CANCEL** and then follow instruction 2 and 3.

CAUTION:

1. Setting for "TIMER ON" and "TIMER OFF" can be achieved independently or simultaneously.
2. When "TIMER ON" and "TIMER OFF" are set to be achieved simultaneously, the air conditioner operates to the nearest time for either "TIMER ON" or "TIMER OFF".
3. If both "TIMER ON" and "TIMER OFF" are set in the same reserved time, the controller stop functioning.
4. When time you set reached, the air conditioner switch on/off automatically, and the "TIMER ON" or "TIMER OFF" displayed on RCU screen disappears accordingly.

INSTALLATION

1. **IMPORTANT :** Install the mobile air conditioner in a flat and spacious location where the air outlets will not be covered up. A minimum clearance of 30cm from a wall or other obstacles should be kept.

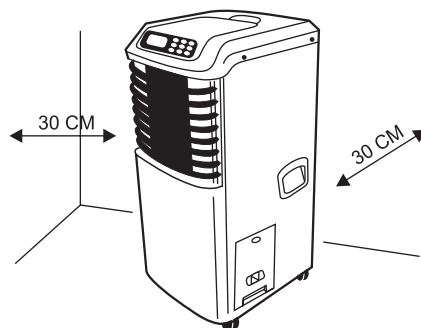

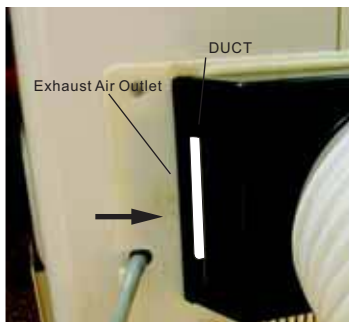
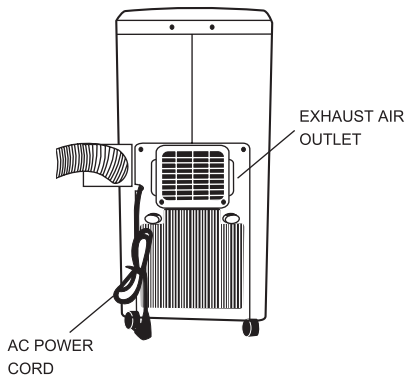

2. DUCT MOUNT INSTRUCTIONS:

A) TEMPORARY-

1. Attach one end of the duct to the exhaust air outlet of the mobile air conditioner. According to the arrow direction, first fit the left side of the duct on the exhaust air panel, then the right side duct. Push it downwards, be sure to fix thoroughly. (See the figures)
2. Attach the other end of the duct to adaptor B.
3. Put the end of duct to a nearby window.

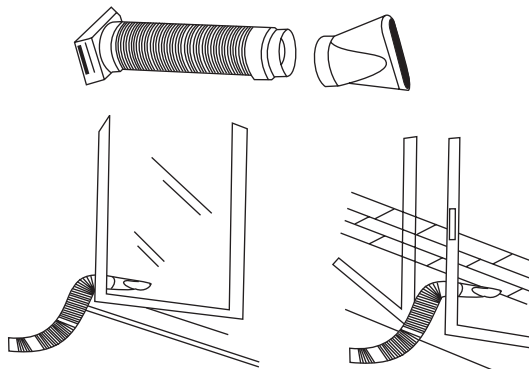

B) PERMANENT-

1. Attach one end of the duct to the exhaust air outlet of the mobile air conditioner. According to the arrow direction, first fit the left side of the duct on the exhaust air panel, then the right side duct. Push it downwards, be sure to fix thoroughly. (See the figures)
2. Install the adaptor A onto the wall by using 4 wall plug and screws.
3. Attach the other end of the duct to adaptor A.
4. Cover the hole using the adaptor cap when not in use.

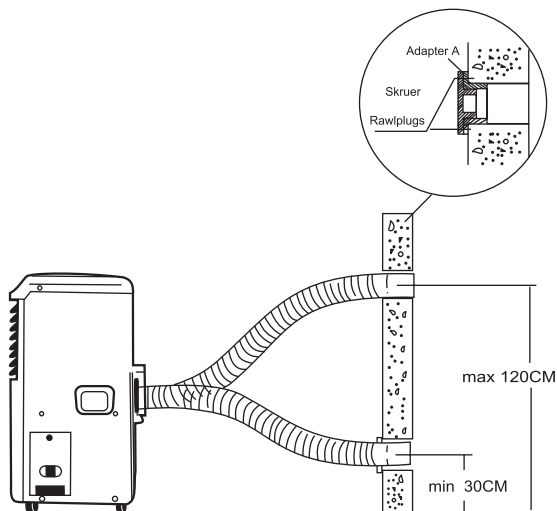

- The duct can be compressed or extended between 500 mm and 2000 mm, but it is desirable to keep the duct length to a minimum.

IMPORTANT: DO NOT OVER STRETCH THE DUCT (SEE FIGURE)

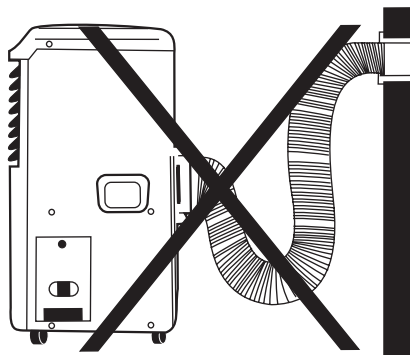

Window Kit Installation

Your window kit has been designed to fit most standard "Vertical" and "horizontal" window applications. However, it may be necessary for you to improvise/modify some aspects of the installation procedures for certain types of window. Please refer to *Fig. 2* & *Fig. 2a* for minimum and maximum window openings.

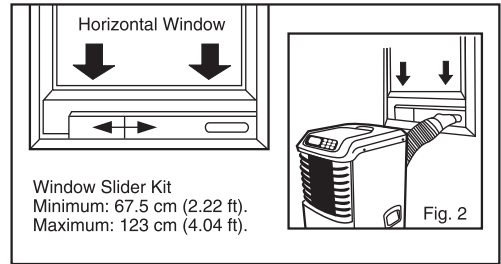

Drain Tank Safety Feature

This unit is equipped with a full-safe switch mechanism which prevents the unit from condensing water in the event the water tank is accidentally displaced, and/or **FULL** with water. If this situation occurs, the unit will signal **8 BEEPS** and the **WATER FULL** indicator light will flash red continuously until the Drain Tank is correctly positioned and/or emptied.

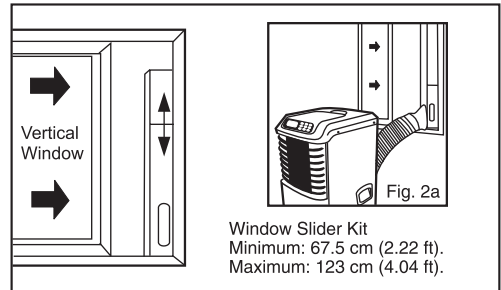

MAINTENANCE

- IMPORTANT:**
- 1) BE SURE TO UNPLUG THE UNIT BEFORE CLEANING.
 - 2) DO NOT USE GASOLINE, THINNER OR OTHER CHEMICALS TO CLEAN THE UNIT.
 - 3) DO NOT WASH THE UNIT DIRECTLY UNDER A TAP OR USING A HOSE. THE ELECTRICAL COMPONENTS INSIDE MAY BE DAMAGED AND CAUSE DANGER.
 - 4) IF THE POWER CORD IS DAMAGED, IT SHOULD BE REPAIRED BY MANUFACTURE OR ITS AGENCY.

1 AIR FILTER

- Clean the air filter at least once every two weeks to prevent inferior fan operation because of dust.
- **Removal**
Pull out the filter cover and remove the air filter from the filter cover.
- **Cleaning**
Wash the air filter by immersing it gently in warm water (about 40°C) with a neutral detergent. Rinse the filter and dry it in a shady place.
- **Mounting**
Attach the air filter to the filter cover using the attachment hooks on the inner surface of the cover. Put the filter cover back to the unit.

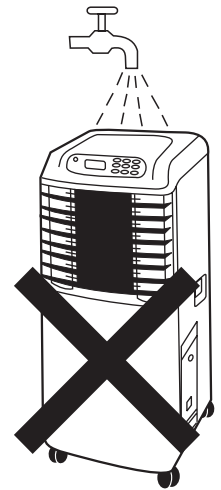
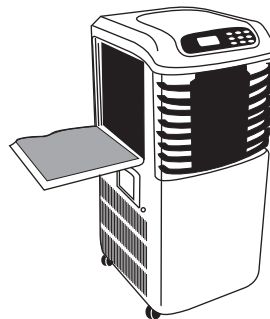

2 UNIT ENCLOSURE

Use a lint-free cloth soaked with neutral detergent to clean the unit enclosure. Finished by a dry clean cloth.

3 DRAIN TANK

Wash the tank using warm water (about 40°C) with neutral detergent. Rinse and then dry in a cool place. Put the tank back to place after it is dried completely.

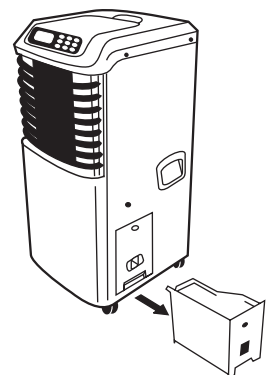

TROUBLE SHOOTING

TROUBLES	POSSIBLE CAUSES	SUGGEST REMEDIES
1. UNIT DOES NOT START WHEN PRESSING 1/0 BUTTON	- Water full indicator blinks, drain tank is full.	Dump the water in the drain tank.
	- Green lamp does not light. It is not yet three minutes after switching off.	Wait until three minutes have passed.
	- Room temperature is higher than the set temperature.(Heating mode)	Reset the temperature.
	- Room temperature is lower than the set temperature.(Cooling mode)	Reset the temperature.
2. NOT COOL ENOUGH	- The windows or doors in the room are not closed.	Make sure all the windows and doors are closed.
	- There are heat sources inside the room.	Remove the heat sources if possible.
	- Exhaust air duct is not connected or blocked.	Connect the duct and make sure it can function properly.
	- Temperature setting is too high.	Decrease the set temperature.
	- Air filter is blocked by dust.	Clean the air filter.
3. POWER SHUT OFF AT HEATING MODE	- The automatic over heat protection function. When the temperature at the air outlet exceed 70°C, the device will stop.	Switch on again after the unit has cool down.
4. NOISY OR VIBRATION	- The ground is not level or not flat enough.	Place the unit on a flat, level ground if possible.
5. GURGLING SOUND	- The sound comes from the flowing of the refrigerant inside the air-conditioner.	It is normal.

Indesit Company
Viale A. Merloni, 47 - 60044 Fabriano - ITALY
Tel. ++39 0732 6611 - Fax ++39 0732 662501
www.indesitcompany.com

Free Manuals Download Website

<http://myh66.com>

<http://usermanuals.us>

<http://www.somanuals.com>

<http://www.4manuals.cc>

<http://www.manual-lib.com>

<http://www.404manual.com>

<http://www.luxmanual.com>

<http://aubethermostatmanual.com>

Golf course search by state

<http://golfingnear.com>

Email search by domain

<http://emailbydomain.com>

Auto manuals search

<http://auto.somanuals.com>

TV manuals search

<http://tv.somanuals.com>