

EN

English, 1

IDE 750

Contents

Installation, 2-3-4

Positioning and levelling
Connecting the water and electricity supplies
Technical data
Electrical Connection

Description of the appliance, 5

Overall view
Control panel
Display

Loading the racks, 6

Lower rack
Cutlery basket
Upper rack

Start-up and use, 7

Starting the dishwasher
Loading the detergent
Washing options

Wash cycles, 8

Wash cycle table

Rinse aid and refined salt, 9

Loading the rinse aid
Loading the refined salt

Care and maintenance, 10

Shutting off the water and electricity supplies
Cleaning the dishwasher
Preventing unpleasant odours
Cleaning the sprayer arms
Cleaning the filters
Leaving the machine unused for extended periods

Precautions and advice, 11

General safety
Disposal
Saving energy and respecting the environment

Troubleshooting, 12

Installation

EN

⚠ Keep this instruction manual in a safe place for future reference. If the appliance is sold, given away or moved, please ensure the manual is kept with the machine, so that the new owner may benefit from the advice contained within it.

⚠ Please read this instruction manual carefully: it contains important information regarding the safe installation, use and maintenance of the appliance.

⚠ If the appliance must be moved at any time, keep it in an upright position; if absolutely necessary, it may be tilted onto its back.

Positioning and levelling

1. Remove the appliance from all packaging and check that it has not been damaged during transportation.

If it has been damaged, contact the retailer and do not proceed any further with the installation process.

2. Check the dishwasher by placing it so that its sides or back panel are in contact with the adjacent cabinets or even with the wall. This appliance can also be recessed under a single worktop* (see the *Assembly instruction sheet*).

3. Position the dishwasher on a level and sturdy floor. If the floor is uneven, the front feet of the appliance may be adjusted until it reaches a horizontal position (the angle of inclination must not exceed 2 degrees). If the appliance is levelled correctly, it will be more stable and much less likely to move or cause vibrations and noise while it is operating.

Connecting the water and electricity supplies

⚠ Connection to the water and electricity supplies should only be performed by a qualified technician.

⚠ The dishwasher should not stand on top of the water hoses or the electricity supply cable.

⚠ The appliance must be connected to the water supply network using new piping. Do not use old piping.

The water inlet (A) and outlet (B) hoses and the electricity supply cable may be positioned towards the right or the left in order to achieve the best possible installation (see *figure*).

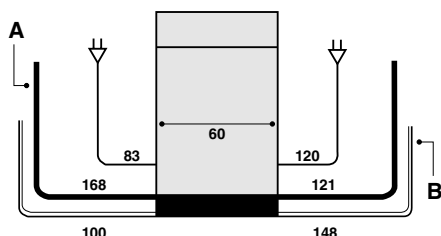

Connecting the water inlet hose

- To a suitable cold water connection point: before attaching the hose, run the water until it is perfectly clear so that any impurities that may be present in the water do not clog the appliance; after performing this operation, screw the inlet hose tightly onto a tap with a $\frac{3}{4}$ gas threaded connection.
- To a suitable hot water connection point: your dishwasher may be provided with hot water from the mains supply (if you have a central heating system with radiators) provided that it does not exceed a temperature of 60°C. Screw the hose to the tap as described for connection to a cold water supply.

⚠ If the inlet hose is not long enough, contact a specialist store or an authorised technician (see *Assistance*).

⚠ The water pressure must be within the values indicated in the Technical data table (see *below*).

⚠ The hose should not be bent or compressed.

Anti-flooding protection

To ensure floods do not occur, the dishwasher:

- is provided with a special system which blocks the water supply in the event of anomalies or leaks from inside the appliance.
- is provided with a *Water Stop** safety device, in other words it has a water inlet hose that consists of a transparent hose on the outside and a red hose on the inside: both the hoses can withstand extremely high pressure. If the internal hose breaks, the external hose becomes a bright red colour and carries the water instead, thus avoiding any leakage.

⚠ It is very important to check the external hose regularly: if it is a bright red colour, it must be replaced by an authorised technician as soon as possible (see *Assistance*).

* Only available in selected models.

Connecting the water outlet hose

Connect the outlet hose (without bending it) to a drain duct with a minimum diameter of 4 cm. Alternatively, rest it over a sink or tub; the free end of the hose should not remain immersed in water.

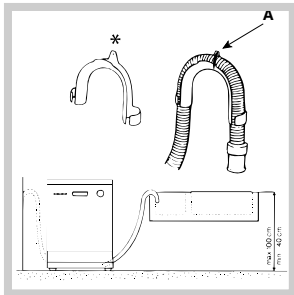

The special plastic elbow* makes it easier to find the best layout: fix the elbow to the wall securely in order to prevent the outlet hose from moving and spilling the dirty water.

The part of the hose marked with the letter A

should be between 40 and 100 cm above the ground (see figure).

 We advise against the use of hose extensions.

Electrical connection

Before inserting the plug into the electrical socket, make sure that:

- the socket is earthed and complies with current regulations;
- the socket can withstand the maximum load of the appliance, which is indicated on the data plate located on the inside of the door (see *Description of the appliance*);
- the power supply voltage falls within the values indicated on the data plate on the inside of the door;
- the socket is compatible with the plug of the appliance. If this is not the case, ask an authorised technician to replace the plug (see *Assistance*); do not use extension cables or multiple sockets.

 Once the appliance has been installed, the power supply cable and the electrical socket should be easily accessible.

 The cable should not be bent or compressed.



 If the power supply cable is damaged, it must be replaced by the manufacturer or its Technical Assistance Service in order to prevent all potential hazards. (See Assistance)

 The Company shall not be held responsible for any incidents that occur if these regulations are not observed.

Advice regarding the first wash cycle

After the appliance has been installed, immediately before running the first wash cycle, completely fill the salt dispenser with water and add approximately 2 kg of salt (see *Rinse aid and refined salt*). The water may overflow: this is normal and is not a cause for concern. It is also normal that the LOW SALT* indicator light continues to flash for a few cycles after the salt has been loaded.

Technical data

Dimensions	width 60 cm height 85 cm depth 60 cm
Capacity	12 standard place-settings
Water supply pressure	0,03 ÷ 1MPa (0.3 ÷ 10 bar) 4.3 psi – 145 psi
Power supply voltage	See appliance data plate
Total absorbed power	See appliance data plate
Fuse	See appliance data plate
 	This dishwasher conforms to the following European Community Directives: -73/23/EEC dated 19/02/73 (Low Voltage) and subsequent modifications -89/336/EEC dated 03/05/89 (Electromagnetic Compatibility) and subsequent modifications -97/17/EC (Labelling) -2002/96/ CE Waste Electrical and Electronic Equipment (WEEE)

* Only available in selected models.

Electrical Connection

EN

Electrical Connection

If your appliance is supplied with a 13 amp. fused plug it can be plugged into a 13 amp socket for immediate use. Before using the appliance please read the instruction below.

**⚠ WARNING: THIS APPLIANCE MUST BE EARTHED.
THE FOLLOWING OPERATIONS SHOULD BE CARRIED OUT BY A QUALIFIED ELECTRICIAN.**

Replacing the fuse:

When replacing a faulty fuse, a 13 amp ASTA approved fuse to BS 1362 should always be used, and the fuse cover re-fitted. If the fuse cover is lost, the plug must not be used until a replacement is obtained.

Replacement fuse covers:

If a replacement fuse cover is fitted, it must be of the correct colours as indicated by the coloured marking or the colour that is embossed in words on the base of the plug. Replacements can be obtained directly from your nearest Service Depot.

Removing the plug:

If your appliance has a non-rewireable moulded plug and you should wish to remove it to re-route the mains cable through partitions, units etc., please ensure that either:

- the plug is replaced by a fused 13 amp re-wireable plug bearing the BSI mark of approval
- or:
- the mains cable is wired directly into a 13 amp cable outlet, controlled by a switch, (in compliance with BS 5733) which is accessible without moving the appliance.

Disposing of the plug:

Ensure that before disposing of the plug itself, you make the pins unusable so that it cannot be accidentally inserted into a socket.

Instruction for connecting cable to an alternative plug:

Important: the wires in the mains lead are coloured in accordance with the following code:

- Green & Yellow - **Earth**
- Blue - **Neutral**
- Brown - **Live**

⚠ CAUTION:

- Once the appliance has been installed, the electrical plug and socket should remain accessible.

- The Company shall not be held responsible for any incidents that occur if these regulations are not observed.

As the colours of the wires in the mains lead may not correspond with the coloured markings identifying the terminal in your plug, proceed as follows:
connect Green & Yellow wire to terminal marked "E" or coloured Green or Green & Yellow.
Connect Brown wire to terminal marked "L" or coloured Red.
Connect Blue wire to terminal marked "N" or coloured Black.

If a 13 amp plug (BS 1363) is used it must be fitted with a 13 amp fuse. A 15 amp plug must be protected by a 15 amp fuse, either in the plug or adaptor or at the distribution board.

If you are in any doubt about the electrical supply to your machine, consult a qualified electrician before use.

How to connect an alternative plug:

The wires in this mains lead are coloured in accordance with the following code:

- BLUE "NEUTRAL" ("N")
- BROWN "LIVE" ("L")
- GREEN AND YELLOW "EARTH" ("E")

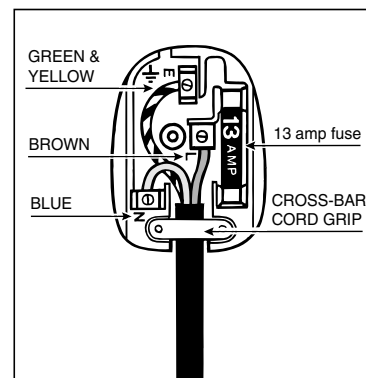

Disposing of the appliance:

When disposing of the appliance please remove the plug by cutting the mains cable as close as possible to the plug body and dispose of it as described above

Description of the appliance

Overall view

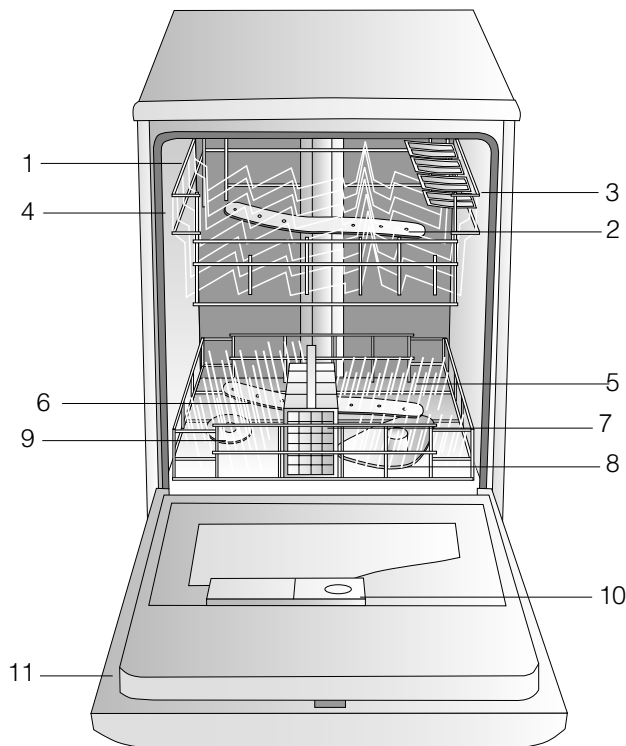

1. Upper rack
2. Upper sprayer arm
3. Tip-up compartments
4. Rack height adjuster
5. Lower rack
6. Lower sprayer arm
7. Cutlery basket
8. Washing filter
9. Salt dispenser
10. Detergent and rinse aid dispensers
11. Data plate

Control panel

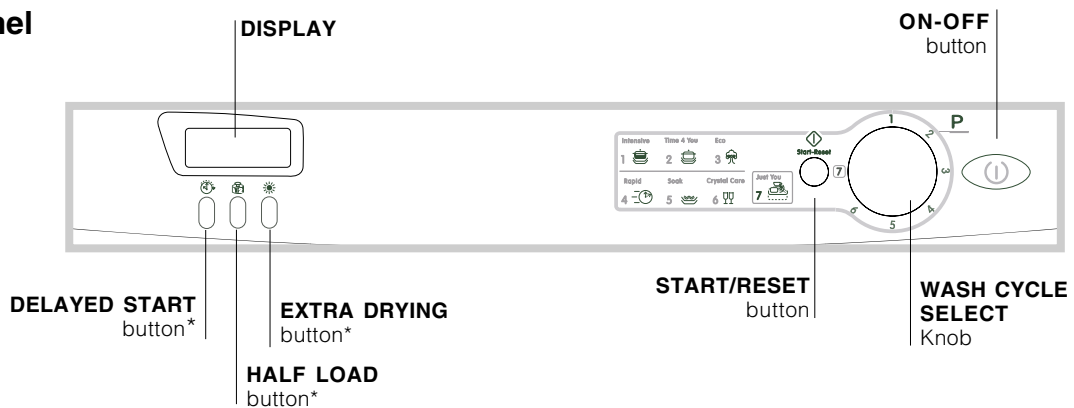

Display

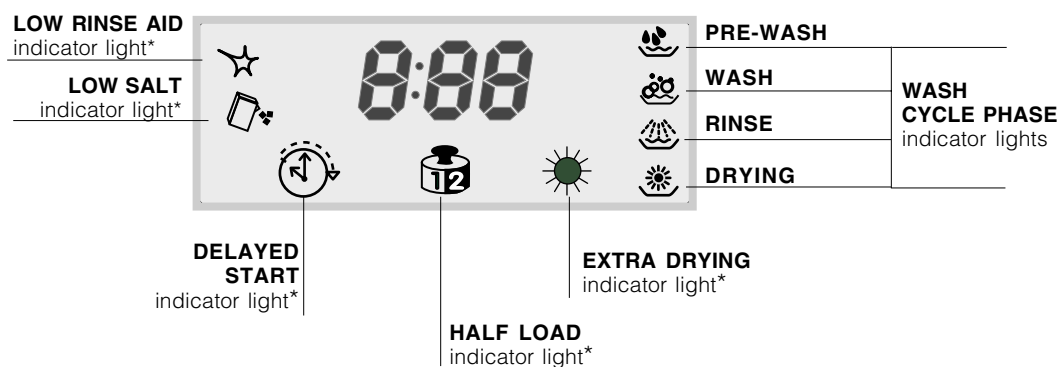

* Only available in selected models.

Loading the racks

EN

 Before loading the rack, remove all food residue from the crockery, leave saucepans and frying pans with burnt-on residue to soak in water only and empty all remaining liquid from cups and glasses. After loading the appliance, check that the sprayer arms can rotate freely.

Lower rack

Arrange the more difficult items to wash using the *Loading examples* as a guide and use the collapsible supports* where needed.

- Serving dishes and lids: place these at the sides of the rack.
- Saucepans and salad bowls: always turn these upside down.
- Very deep dishes: position these at an angle.

In order to guarantee the best washing and drying performance, the surface of the lower rack is more uneven than that of the upper rack.

Cutlery basket

The type of cutlery basket may vary according to the dishwasher model.

 Knives and other utensils with sharp edges must be placed in the cutlery basket with the points facing downwards, or they must be positioned horizontally in the tip-up compartments on the upper rack.

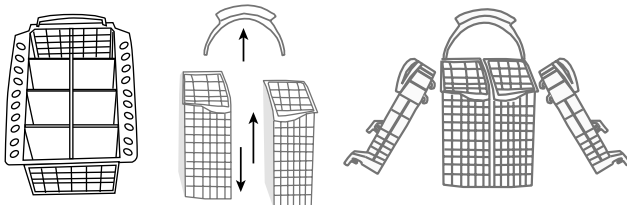

To divide the central basket* into two separate pieces: pull out the handle. The two detachable side compartments* may be hooked onto the upper or lower rack.

The two grids* may be positioned in the basket to separate the cutlery: place the pieces of cutlery into the appropriate compartments with the handles at the bottom.

Upper rack

Load this rack with delicate and lightweight crockery: glasses, tea and coffee cups, saucers, small salad bowls, saucepans and small saucepans that are not too soiled, using the *Loading examples* as a guide.

- Lightweight crockery: position these dishes so that they will not be moved by the jets of water.
- Mugs and cups: place these on the tip-up compartments**.
- Long sharp knives and serving utensils: place these on the tip-up compartments**.

Adjusting the height of the upper rack

In order to make it easier to arrange the crockery, the upper rack may be moved to a higher or lower level.

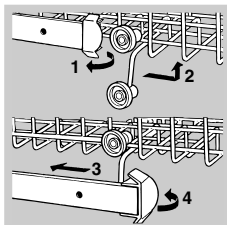

Open the left and right guide rail stops and pull out the rack; position it higher or lower as required, slide it along the guide rails until the front wheels are in place and close the stops (see figure).

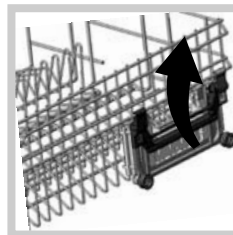

If the rack is equipped with the click clack handles* (see figure), pull them upwards or downwards to adjust the height.

Loading examples for the upper rack

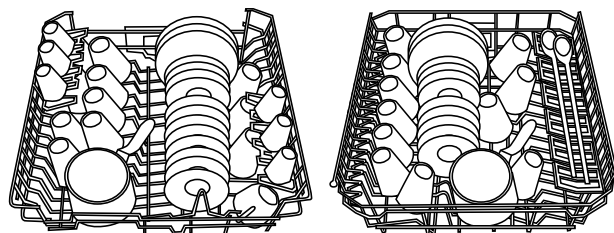

Loading examples for the lower rack

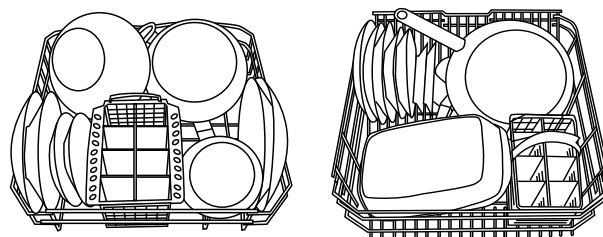

Just you Tip-up compartments**

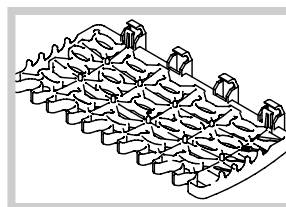

These special tip-up compartments can be used to arrange mugs and cups. Spoons, forks and knives should be placed in the slots provided. Stemmed glasses can be hooked on by threading the stems into the slits.

Items that should not be washed in the dishwasher

- Wooden items, objects with wooden or horn handles or glued-on parts.
- Items made from aluminium, copper, brass, pewter or tin.
- Items made from plastic that is not heat-resistant.
- Antique or hand-painted porcelain.
- Antique silver. Silver that is not antique may, however, be washed in the dishwasher using a delicate wash cycle, provided that it does not come into contact with other metals.

 When buying crockery and cutlery we recommend that you check whether it can be washed using the dishwasher.

Washing the handles*

To wash the upper and lower rack handles: remove the two fastening plugs, lift out the handles and rinse them under running water, then fasten them to the rack using the same plugs.

* Only available in selected models.

** The number and position may vary.

Starting the dishwasher

1. Turn the water tap on.
2. Press the ON/OFF button: the display will light up.
3. Measure out the detergent (*see below*).
4. Load the racks (see Loading the racks) and shut the door.
5. Select the programme by turning the WASH CYCLE SELECT knob in a clockwise direction: align the notch on the knob with the number or symbol representing the desired wash cycle.
6. Select the wash options (*see below*).
7. Start the cycle by pressing the START/RESET button: the machine will emit a confirmation beep. The WASH CYCLE PHASE indicator lights display the status of the cycle: Pre-wash, Wash, Rinse, or Drying.
8. At the end of the cycle three short beeps will sound and END will appear on the display. Switch off the appliance by pressing the ON/OFF button, shut off the water tap and unplug the appliance from the electricity socket.
9. Open the door and wait for a few minutes before removing the crockery, in order to avoid burns. Unload the racks, beginning with the lower level.

Demo*

If dON appears on the display, this means that the appliance is in demonstration mode. To deactivate it, press the START/RESET and ON/OFF buttons simultaneously: dOF should appear on the display.

Modifying a wash cycle in progress

If a mistake was made during the wash cycle selection process it is possible to change the cycle, provided that it has only just begun: press and hold the START/RESET button for 4 seconds. After one long beep and three short beeps, the WASH CYCLE PHASE indicator light will switch off. Select the new cycle and switch the machine back on by pressing the START/RESET button.

Adding extra crockery

Press the ON/OFF button and open the door, taking care to avoid the escaping steam, and place the crockery inside the dishwasher. Press the ON/OFF button again: the cycle starts from the point at which it was interrupted.

Accidental interruptions

If the door is opened during the wash cycle, or if there is a power cut, the cycle stops. It starts again from the point at which it was interrupted once the door has been shut or the electricity supply is restored.

Loading the detergent

A successful wash also depends on the correct amount of detergent being used, as recommended by the manufacturer. Exceeding the recommended amount does not result in a more effective wash and pollutes the environment.

 To obtain the best results from each washing and drying cycle, powder detergent, rinse aid liquid and salt should be used.

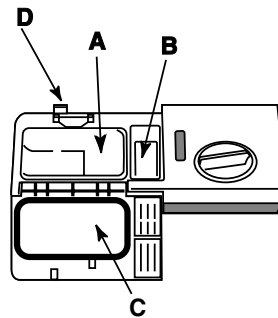

compartment A: Washing detergent

compartment B: Pre-wash detergent

1. Open cover C by pressing button D.
2. Pour in the detergent after consulting the *Wash cycle table*:
 - for powder detergent use compartments A and B
 - for tablets, use compartment A and the bottom of the appliance,

i.e. when the cycle requires 1 tablet, place it in compartment A and close the cover; when it requires 2, place the second tablet at the bottom of the appliance.

3. Remove detergent residues from the edges of the compartment and close the cover until it clicks.

Washing options

Delayed start

It is possible to delay the start time of the cycle for a period of time between 1 and 24 hours.

1. Press the DELAYED START button: every time the button is pressed, the time selected appears on the display and the delayed start indicator light illuminates.
2. Select the wash cycle and press the START/RESET button: after the beep sounds, the timer begins counting down.
3. Once this time is up, the indicator light switches off and the wash cycle begins.

To adjust the delay time and select a lower period of time, press the DELAYED START button. To cancel it, press the button repeatedly until the wash cycle begins and the WASH CYCLE PHASE indicator light corresponding to the start of the cycle in progress illuminates.

Half load using the upper rack*

If there are not many dishes to be washed, a half load cycle may be used in order to save water, electricity and detergent. Before selecting the wash cycle press the HALF LOAD button repeatedly: the indicator light will illuminate and the wash cycle will take place only in the upper rack.

Remember to load the upper rack only, and to reduce the amount of detergent accordingly.

 It is better to use powder detergent in this case.

Extra drying*

To make sure that the crockery is completely dry at the end of the cycle, press the EXTRA DRYING button before selecting the wash cycle. A prolonged beep will sound to indicate that this option has been selected and a short beep will sound to indicate when it has been deselected.

 If the Extra drying option is selected, the wash cycles will last longer.

Wash cycles

EN

Wash cycle table

 INDESIT dishwashers are equipped with an automatic filter cleaning system so that they do not become clogged with food residues. This function may extend the duration of the wash cycles. If there is a high level of dirt contained in the filters, the dishwasher will stop operating (see *Troubleshooting - Blocked filter alarm*).

 If the crockery is only lightly soiled or if it has been rinsed with water before being placed in the dishwasher, reduce the amount of detergent used accordingly.

 The number and type of wash cycles varies according to the model of dishwasher.

Wash cycle selection instructions	Wash cycle	Detergent (A) = compartment A (B) = compartment B			Pre-wash	Drying	Wash cycle duration (tolerance ±10%) Hrs. Min.
		Powder	Liquid	Tablets			
Extremely soiled dishes and pans (not to be used for delicate items).	1) Intensive	30 g (A) 5 g (B)	30 ml (A) 5 ml (B)	1 (A) 1 (bottom of the appliance)	•	•	2:00'
Normally soiled pans and dishes. Standard daily wash cycle.	2) Normal	30 g (A)	30 ml (A)	1 (A)		•	1:28'
Environmentally-friendly wash cycle with low energy consumption levels, suitable for pans and dishes.	3) Eco	25 g (A) 5 g (B)	25 ml (A) 5 ml (B)	1 (A)	•	•	2:25'
Economic and fast wash cycle to be used for lightly soiled dishes. (Run cycle immediately after use.)	4) Rapid	25 g (A)	25 ml (A)				0:24'
Preliminary wash cycle for dishes while the load is awaiting completion with the dishes from the next meal.	5) Soak						0:12'
Special cycle to be used for more delicate items which are sensitive to high temperatures. Run cycle immediately after use.	6) Crystal	25 g (A)	25 g (A)	1 (A)		•	1:38'
Economic and fast cycle for a fairly small daily load of dishes. This may only be done on the upper rack.	7) Just you	25 g (A)	25 ml (A)				0:48'

Note

To make it easier to measure out the detergent, it is worth remembering that:

1 tablespoon = 15 grams of powder = approximately 15 ml of liquid

1 teaspoon = 5 grams of powder = approximately 5 ml of liquid

Rinse aid and refined salt

⚠ Only use products that have been specifically designed for dishwashers.
Do not use table salt or industrial salt.

⚠ If using a multi-functional product, it is not necessary to add rinse aid; however, we recommend that you add salt, especially if you live in an area where the water is hard or very hard. If you do not add salt or rinse aid, the LOW SALT* and LOW RINSE AID* indicator lights will flash continuously.

Loading the rinse aid

Rinse aid makes it easier for the crockery to dry, as water runs off surfaces more readily and therefore does not leave streaks or marks.

The rinse aid dispenser should be filled:

- whenever the indicator light (H) signals that it is empty. Illuminated light: add rinse aid; unlit light: there is no shortage of rinse aid in the dispenser.
- when the LOW RINSE AID* indicator light on the panel flashes;

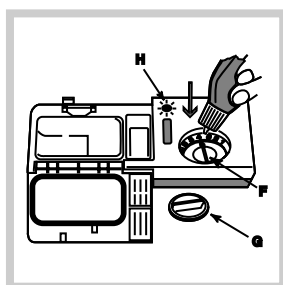

1. Open the dispenser by turning the lid (G) in an anticlockwise direction.
2. Pour in the rinse aid, making sure it does not overflow from the dispenser. If this happens, clean the spill immediately with a sponge.
3. Screw the lid back on. NEVER pour the rinse aid

directly into the appliance tub.

Adjusting the amount of rinse aid

If you are not completely satisfied with the drying results, you may adjust the quantity of rinse aid used. Use a screwdriver to turn the dosage adjuster to one of the 6 pre-set positions (the default position is set to 4):

- if there are streaks on the crockery, set the adjuster to a lower number (1-3).
- if drops of water remain on the crockery or there are limescale marks present after the cycle has finished, set the adjuster to a higher number (4-6).

⚠ If you are using multi-functional tablets and you wish to further improve the drying performance of the appliance, fill the dispenser and set the dosage adjuster to 2.

Loading the refined salt

In order to obtain the best possible results from a wash cycle, make sure that the dispenser is never empty. Refined salt removes limescale from the water, thus avoiding the formation of deposits on crockery. The salt dispenser is located in the lower part of the dishwasher (see *Description*) and should be filled:

- when the green float* cannot be seen by simply looking at the cap of the salt dispenser;
- when the LOW SALT* indicator light on the panel flashes;
- if your machine is not equipped with an indicator light or a green float: approximately every 30 wash cycles;

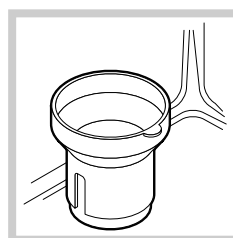

1. Remove the lower rack and unscrew the cap of the dispenser (in an anti-clockwise direction).
2. For the first wash cycle only: fill the dispenser up to the edges with water.
3. Position the funnel provided correctly (see figure) and fill the salt dispenser up to the edges (approximately 2 kg); it is normal for

a little water to leak out.

4. Remove the funnel, wipe away any salt residue from the thread and screw the cap on tightly, so that detergent does not leak into the dispenser during the wash cycle (this could damage the water softening system beyond repair).

⚠ When salt has been added, run a wash cycle immediately, without crockery, in order to remove any salt solution that has leaked out and to avoid corrosion.

Adjusting the amount of salt*

It is possible to adjust the amount of salt used according to the hardness of the water in your area (this information is available from your local water board).

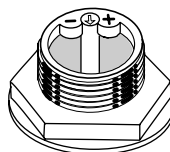

1. Unscrew the dispenser cap.
2. Turn the arrow on the neck of the dispenser (see figure) towards the + or - symbols, using the table below as a guide.

Hardness of the water			Selector knob position	Salt consumption (grams/cycle)	Autonomy (cycle/2 kg)
°dH	°fH	°mmol/l			
0-10	0-17	0-1,7	/	0	/
10-25	18-44	1,8-4,4	—	20	60
25-50	45-89	4,5-8,9	MED	40	40
> 50	> 89	> 8,9	+	60	25

The default setting of the water softening system is +.

- If using multi-functional tablets, fill the salt dispenser and set the adjuster to -; if the hardness of the water is greater than 60°fH, set it to +.

* Only available in selected models.

Care and maintenance

EN

Shutting off the water and electricity supplies

- Turn off the water tap after every wash cycle to avoid leaks.
- Remove the plug from the socket when cleaning the machine and when carrying out maintenance work.

Cleaning the dishwasher

- The external surfaces of the machine and the control panel may be cleaned using a non-abrasive cloth which has been dampened with water. Do not use solvents or abrasive products.
- Any marks on the appliance interior may be removed using a cloth dampened with water and a little vinegar.

Preventing unpleasant odours

- Always keep the door of the appliance ajar in order to avoid moisture from forming and being trapped inside the machine.
- Clean the seals around the door and detergent dispensers regularly using a damp sponge. This will avoid food becoming trapped in the seals, which is the main cause of the formation of unpleasant odours.

Cleaning the sprayer arms

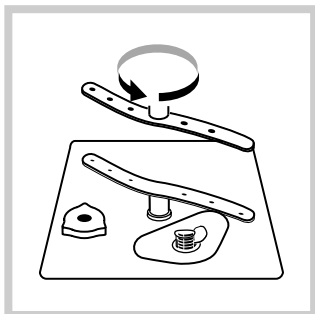

Food residue may become encrusted onto the sprayer arms and block the holes used to spray the water. It is therefore recommended that the arms are checked from time to time and cleaned with a small non-metallic brush.

Cleaning the filters

The filters remove food residue from the water used in the wash cycle: to obtain the best results from each wash, they should be cleaned.

- ⚠ Clean the filters regularly.
- ⚠ After cleaning check that the filter assembly has been replaced correctly.
- ⚠ The dishwasher should not be used without filters or when the filter is loose.

1. Remove the filters by pulling the handle upwards.
2. Clean the filters:

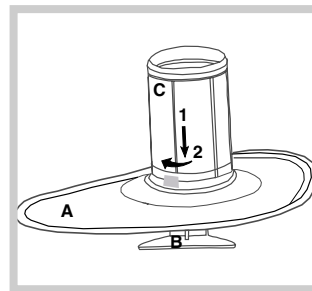

- after every wash cycle, remove the largest pieces of residue from semicircular plate A and glass B (these may be removed by pulling the handle) by rinsing them under running water.

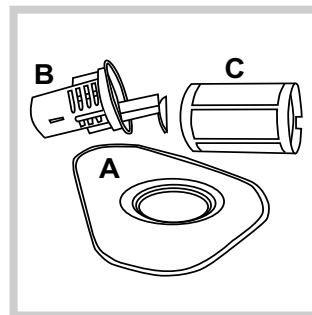

- The entire filter assembly should be cleaned thoroughly once a month: this includes the semicircular plate A, the glass B and the cylinder C (this may be removed by turning it in an anti-clockwise direction). Use a small

non-metallic brush to clean these parts.

3. Reconstruct the filter assembly and replace it in the correct position, following movements 1 and 2 as shown in the figure, until it clicks into place.

Leaving the machine unused for extended periods

- Run a wash cycle when the dishwasher is empty.
- Unplug the appliance and disconnect the water supply.
- Leave the door of the appliance ajar.

 The appliance was designed and manufactured in compliance with current international safety standards. The following information has been provided for safety reasons and should therefore be read carefully.

General safety

- The appliance was designed for domestic use inside the home and is not intended for commercial or industrial use.
- The appliance must be used by adults only, to wash domestic crockery according to the instructions in this manual.
- The appliance must not be installed outdoors, even in covered areas. It is extremely dangerous to leave the machine exposed to rain and storms.
- Do not touch the appliance when barefoot.
- When unplugging the appliance always pull the plug from the mains socket, do not pull on the cable.
- The water supply tap must be shut off and the plug should be removed from the electrical socket before cleaning the appliance or carrying out any maintenance work.
- If the appliance breaks down, do not under any circumstances touch the internal parts in an attempt to carry out the repair work yourself.
- Never touch the heating element.
- Do not lean or sit on the open door of the appliance: this may cause the appliance to overturn.
- The door should not be left open as it may create a dangerous obstacle.
- Keep detergent and rinse aid out of reach of children.
- The packaging material should not be used as a toy: it can become a choking or suffocation hazard.

Disposal of old electrical appliances

The European Directive 2002/96/EC on Waste Electrical and Electronic Equipment (WEEE), requires that old household electrical appliances must not be disposed of in the normal unsorted municipal waste stream. Old appliances must be collected separately in order to optimise the recovery and recycling of the materials they contain and reduce the impact on human health and the environment. The crossed out "wheeled bin" symbol on the product reminds you of your obligation, that when you dispose of the appliance it must be separately collected.

Consumers should contact their local authority or retailer for information concerning the correct disposal of their old appliance.

Saving energy and respecting the environment

Saving water and energy

- Only start a wash cycle when the dishwasher is full. While waiting for the dishwasher to be filled, prevent unpleasant odours with the Soak cycle (see *Wash Cycles*).
- Select a wash cycle that is suited to the type of crockery and to the soil level of the crockery using the *Wash cycle table*:
 - for dishes with a normal soil level, use the Eco wash cycle, which guarantees low energy and water consumption levels.
 - if the load is smaller than usual activate the Half load option (see *Start-up and use*).
- If your electricity supply contract gives details of electricity saving time bands, run wash cycles during the periods when a lower tariff is applied. The Delayed start* button (see *Start-up and use*) helps you organise the wash cycles accordingly.

Phosphate-free and chlorine-free detergents containing enzymes

- We strongly recommend that you use detergents that do not contain phosphates or chlorine, as these products are harmful to the environment.
- Enzymes provide a particularly effective action at temperatures around 50°C, and as a result detergents containing enzymes can be used in conjunction with low-temperature wash cycles in order to achieve the same results as a normal 65°C wash cycle.
- To avoid wasting detergent, use the product in appropriate quantities based on the manufacturer's recommendations, the hardness of the water and the soil level and quantity of the crockery. Even if they are biodegradable, detergents contain substances that may alter the balance of nature.

* Only available in selected models.

Whenever the appliance fails to work, check for a solution from the following list before calling for Technical Assistance Centre.

Some problems are indicated by specific codes that flash on the display: make a note of any codes displayed before calling Assistance.

Malfunction:	Possible causes / Solutions:
The dishwasher does not start.	<ul style="list-style-type: none"> The plug has not been inserted into the electrical socket properly, or there is no power in the house. The dishwasher door has not been shut properly. A delayed start has been programmed (<i>see Start-up and use</i>).
No water enters the dishwasher.	<ul style="list-style-type: none"> There is no water in the mains supply. The water inlet hose is bent (<i>see Installation</i>).
No water drains out from the dishwasher.	<ul style="list-style-type: none"> The dishwasher cycle has not yet finished. The water outlet hose is bent (<i>see Installation</i>). The drain duct is blocked. The filter is clogged up with food residues.
The dishwasher makes excessive noise.	<ul style="list-style-type: none"> The dishes are rattling against each other or against the sprayer arms.
The dishes and glasses are covered in a white film or limescale deposits.	<ul style="list-style-type: none"> The level of the refined salt is low or the dosage setting is not suited to the hardness of the water (<i>see Rinse aid and salt</i>). The lid on the salt dispenser is not closed properly. The rinse aid has been used up or the dosage is too low. The crockery is made from non-stick material.
The dishes and glasses are streaked or have a bluish tinge.	<ul style="list-style-type: none"> The rinse aid dosage is too high.
The crockery has not been dried properly.	<ul style="list-style-type: none"> The rinse aid has been used up or the dosage is too low (<i>see Rinse aid and salt</i>). The rinse aid dispenser setting is not high enough. A wash cycle without a drying programme has been selected.
The dishes are not clean.	<ul style="list-style-type: none"> The racks are overloaded (<i>see Loading the racks</i>). The crockery has not been arranged well. The sprayer arms cannot move freely. The wash cycle is too gentle (<i>see Wash cycles</i>). The detergent has not been measured out correctly or it is not suited to the type of wash cycle (<i>see Start-up and use</i>). The filter is dirty or blocked (<i>see Care and maintenance</i>). The refined salt level is low (<i>see Rinse aid and salt</i>).
Shut off tap alarm. (you will hear several short beeps) (the code AO6 flashes on the display).	<ul style="list-style-type: none"> Turn on the tap and the appliance will start after a few minutes. The appliance lock has been activated because nothing was done when the beeps sounded. Switch off the machine using the ON/OFF button, turn on the tap and switch the machine back on after 20 seconds by pressing the same button. Re-programme the machine and restart the wash cycle.
Blocked filter alarm (the code AO5 flashes on the display).	<ul style="list-style-type: none"> Switch off the machine by pressing the ON/OFF button and clean the filters (<i>see Maintenance</i>), then switch the dishwasher back on by pressing the same button. Re-programme the machine and restart the wash cycle.
Water loading solenoid valve malfunction alarm (the code AO2 flashes on the display).	<ul style="list-style-type: none"> Switch off the appliance by pressing the ON/OFF button and switch it back on after a minute. If the alarm continues, turn off the water tap to reduce the risk of flooding, remove the plug from the electrical socket and call Assistance.

Free Manuals Download Website

<http://myh66.com>

<http://usermanuals.us>

<http://www.somanuals.com>

<http://www.4manuals.cc>

<http://www.manual-lib.com>

<http://www.404manual.com>

<http://www.luxmanual.com>

<http://aubethermostatmanual.com>

Golf course search by state

<http://golfingnear.com>

Email search by domain

<http://emailbydomain.com>

Auto manuals search

<http://auto.somanuals.com>

TV manuals search

<http://tv.somanuals.com>