

**User
Instruction
Book**

for

INDESIT

Dishwasher

Models:

**IDE 1000UK
IDE 1005SUK**

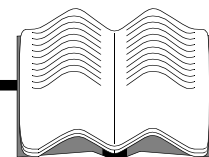

Safety Is a Good Habit to Get Into

NOTICE

Carefully read the instructions contained in this manual, as they provide important information which is essential to safe and proper installation, use and maintenance of the appliance.



This appliance complies with the following EEC directives:
- 73/23/EEC of 19/02/73 (Low Voltage) and subsequent modifications;

- 89/336/EEC of 03/05/89 (Electromagnetic Compatibility) and subsequent modifications.

- 97/17/EEC Labelling

1. Carefully dispose of the packing material.

2. After removing the packing, check to make sure that the appliance is not damaged. If in doubt, contact a qualified professional.

3. The dishwasher must only be used by adults for the washing of household dishes and cooking utensils.

4. Fundamental rules to follow when using the appliance:

- Never touch the dishwasher when barefoot or with wet hands or feet;

- We discourage the use of extension cords and multiple sockets;

- During installation, the power supply cord must not be excessively or dangerously bent or flattened;

- If the appliance is not operating properly or maintenance must be performed, disconnect the appliance from the power supply.

5. Keep detergents out of the reach of children, who must also be kept away from the dishwasher when it is open.

6. This appliance cannot be installed outdoors, not even if the area in which it is installed is covered by a roof; it is also very dangerous to leave it exposed to the rain and elements.

7. Do not touch the heating element during or after a wash cycle.

8. Do not lean or sit on the door when it is open, as this could overturn the dishwasher.

9. If the appliance malfunctions, turn off water supply to the appliance and disconnect the plug from the wall socket. Then, consult the section entitled, "Troubleshooting." If you cannot resolve the problem, contact a service centre.

10. Appliances which are no longer being used must be made inoperable by cutting the power supply cord and removing the door lock.

To maintain the **EFFICIENCY** and **SAFETY** of this appliance, we recommend:

- call only the Service Centers authorized by the manufacturer
- always use original Spare Parts

Close-up View (control panel)

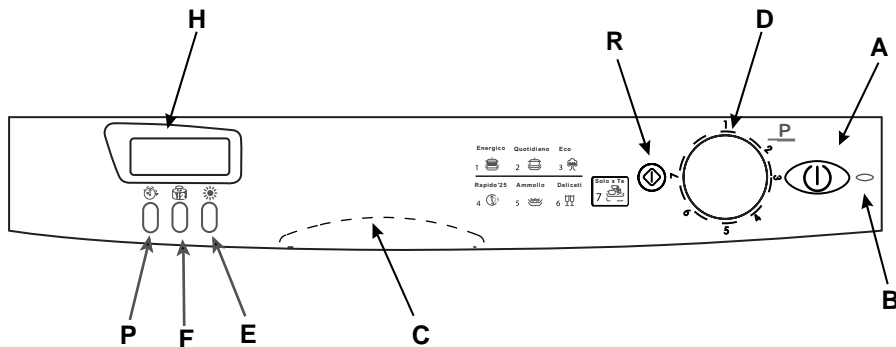

A: ON-OFF button

B: ON-OFF Indicator light

C: Door handle

R: Start/Reset Button

H: Display

E: "Extra drying" button

F: "Half load" button

P: Delayed start select button

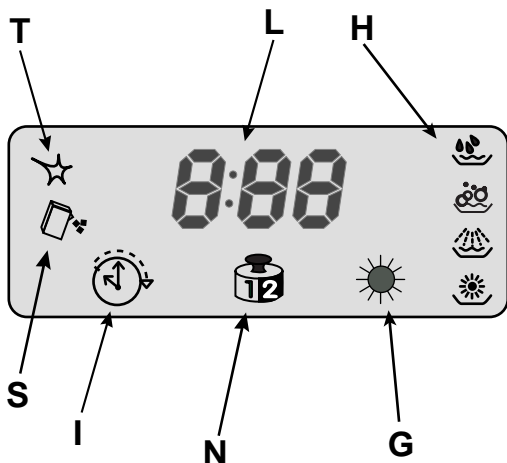

G: "Extra drying" indicator light

H: Cycle phase indicator lights

L: Alphanumeric indicator

N: Half load indicator light

S: Low salt indicator light

T: Low rinse aid indicator light

I: Delayed start indicator light

Close-up View (Interior)

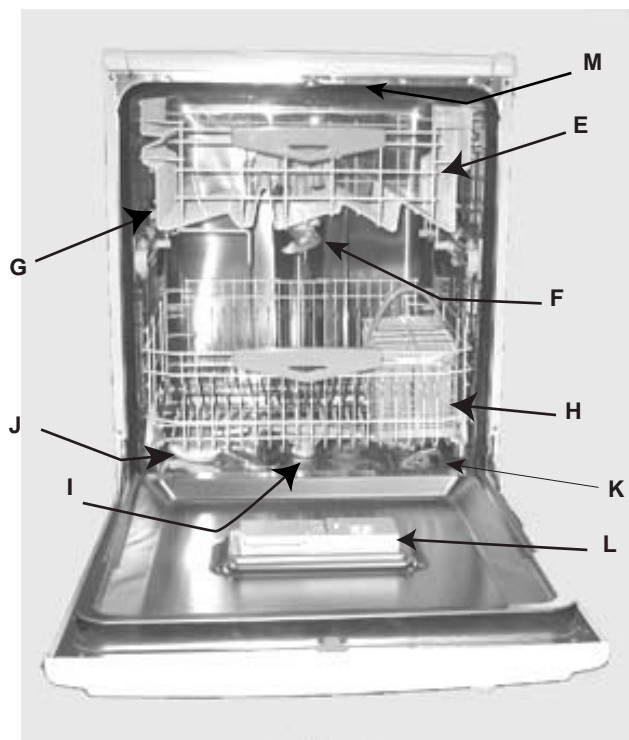

- | | |
|-------------------------------|--|
| E Upper Rack | I Bottom Sprayer Arm |
| F Top Sprayer Arm | J Salt Container Cap |
| G Rack Height Adjustor | K Washing Filter |
| H Lower Rack | L Detergent and Rinse Aid Dispenser |
| | M Turbo dry Fan |

Technical characteristics

Width	cm. 60
Depth	cm. 60
Height	cm. 85
Capacity	12 standard place settings
Mains water pressure	30 KPa÷ 1MPa (0,3 ÷10 bar)
Power voltage	See data plate
Total absorber power	See data plate
Fuse	See data plate

Salt

Salt

The hardness of the water varies from place to place. If hard water is used in the dishwasher, deposits will form on the dishes and utensils.

The appliance is equipped with a special softener that uses a salt specifically designed to eliminate lime and minerals from the water.

Loading the Salt into the Softener

Always use salt intended for use with dishwashers. The salt container is located beneath the lower rack and should be filled as follows:



1. Remove the lower rack and then unscrew and remove the cap from the salt container;
2. If you are filling the container for the first time, fill it with water;
3. Place the end of the funnel (supplied) into the hole and introduce about 2 kg of salt. It is normal for a small amount of water to come out of the salt container.
4. Carefully screw the cap back on.

The salt container should be filled up when the low salt indicator light "S" flashes.

Once you have loaded the salt for the first time, it is normal that the low salt indicator light stays on or flashes for about 5 consecutive cycles.

Warning: To prevent rust from forming, we advise you to load the salt **before** starting a wash cycle.

Adjusting Salt Consumption

The dishwasher is designed to allow for adjusting the amount of salt consumed based on the hardness of the water used. This is intended to optimize and customize the level of salt consumption so that it remains at a minimum.

Your Local Water Board can supply the degree of hardness of the water in your area.

To adjust salt consumption, proceed as follows:

- 1) Unscrew the cap from the salt container.
- 2) There is a ring on the container with an arrow on it (see figure to the side), if necessary, rotate the ring in the anti-clockwise direction from the "-" setting towards the "+" sign, based on the hardness of the water being used.

It is recommended that adjustments be made in accordance with the following schema:

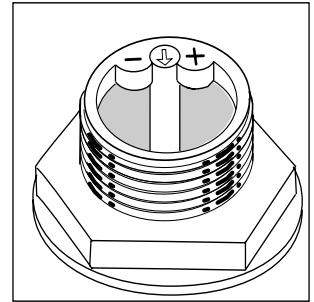

Water Hardness					
Clarke degrees	°fH	mmol/l	Selector position	Salt consumption (grams/cycle)	Autonomy (cycles/2-kg)
0 - 14	0 - 17	0 - 1,7	/	0	/
14 - 36	18 - 44	1,8 - 4,4	"-"	20	60
36 - 71	45 - 89	4,5 - 8,9	MED	40	40
>71	>89	> 8,9	"+"	60	25

Detergent and Rinse Aid

Detergent

Detergent specifically intended for use with dishwashers must be used. The dispenser must be refilled before the start of each wash cycle following the instructions provided in the "Wash Cycle Table." The detergent dispenser is located on the inside panel of the door.

Loading the detergent

To open lid "A", press button "B". The cleaning detergent should be introduced into the two containers "C" and "D" up to the rim.

After pouring in the detergent, replace the lid, pressing down until it clicks.

Dishwasher detergent in tablets is now available on the market, in which case you should place one tablet into container "D" and replace the lid.

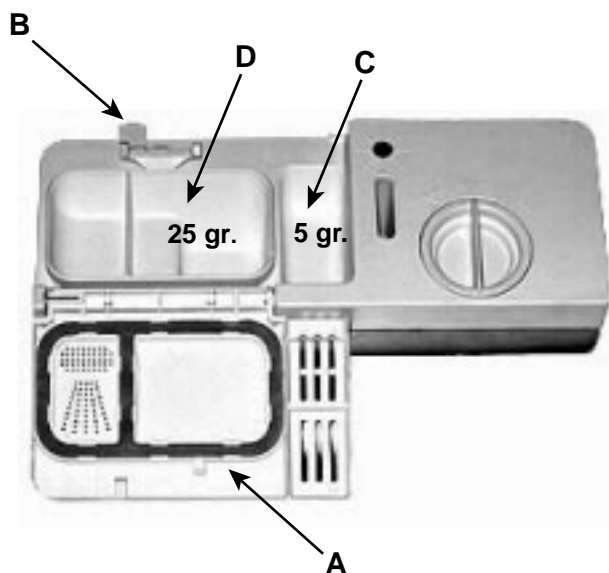

Notice: To facilitate closing the cover, remove any excess detergent on the edges of the dispenser.

Warning

Three-in-one dishwasher tablets are now available on the market, and combine the detergent, salt and rinse aid all in one. If the water in your area is hard or very hard, we still recommend you pour extra salt into the relevant dispenser to prevent the formation of white streaks on your dishes or on the appliance interior.

Add rinse aid to the corresponding container only if you are dissatisfied with the results on your dishes.

In any case, please read the manufacturer's instructions provided on the packet.

If you use only these products, it is normal for the salt and rinse aid indicator lights to flash permanently after a certain number of cycles.

Rinse Aid

This product makes dishes sparkle more as it improves their drying. The rinse aid container is situated on the inside of the appliance door; you should refill it when the low rinse aid indicator light "T" flashes.

Loading the Rinse Aid

To open the dispenser, turn the "C" cap in the anti-clockwise direction and then pour in the rinse aid, making sure not to overfill. The amount of rinse aid used for each cycle can be regulated by turning the "F" dose adjuster, located beneath the "C" cap, with a screwdriver. There are 6 different settings; the normal dosage setting is 4.

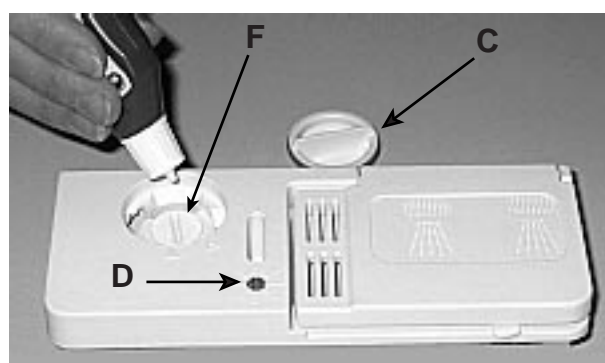

Important:

Proper dosage of the rinse aid improves drying. If drops of water remain on the dishes or spotting occurs, the dosage adjuster should be turned to a higher setting. If the dishes have white streaks, turn the dosage adjuster to a lower setting.

Loading the Dishwasher

Before placing the dishes in the racks, remove the largest scraps of food left over on your plates, you will thus avoid blocking the filter, which would reduce the efficacy of the wash.

If the saucepans and frying pans are very dirty, allow them to soak before being washed.

You will thus avoid having to wash them again.

To make it easier to load your dishes, pull the racks out fully.

How to use the lower rack

We recommend you place the most difficult dishes to wash into the lower rack: saucepans, lids, soup dishes and plates (load examples are shown in the photo).

- **Serving dishes and large lids:** place them on the sides of the rack.
- **Saucepans, salad bowls:** must always be placed upside down.
- **Very deep dishes:** place them obliquely, thus allowing water to run down them and cleaning them better.

The cutlery basket (Figures A,B)

The cutlery basket can be split up by pulling out the handle and removing the clip that keeps the two parts joined together (see figures A and B). When you only have little cutlery to wash, you can use just half the basket.

This basket is equipped with two removable grids: insert the cutlery one by one into the slots, with the handles at the bottom. Position them so that they don't touch.

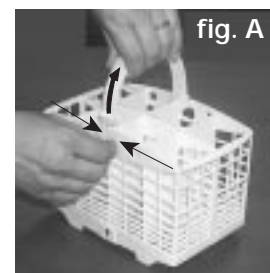
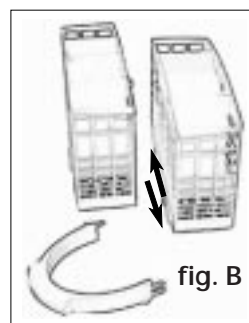
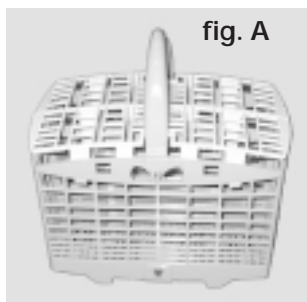

How to use the upper rack

Place delicate and lightweight dishes in the upper rack: glasses, tea cups and coffee cups, saucers - but plates too - shallow salad bowls, slightly dirty frying pans and shallow pans (the photo illustrates a few examples).

Position lightweight dishes in such a way as to avoid their being moved by the spray of water.

The upper rack can be equipped with one or two special tip-up compartments for mugs and cups, as well as spoons, knives and forks, which should be fitted in the slots provided. Stemmed glasses can be hooked onto these compartments by threading the stems into the slots provided (see fig. D).

After loading the dishes, remember to check that the blades on the sprayer arms can turn freely without knocking against any dishes.

How to adjust the upper rack

The upper rack can be set in a high or low position. There are two handles on the sides of the upper rack: use these to adjust its height (see figure C).

Load examples

upper rack



lower rack

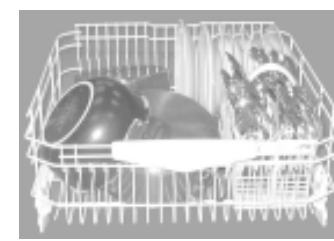

fig. D

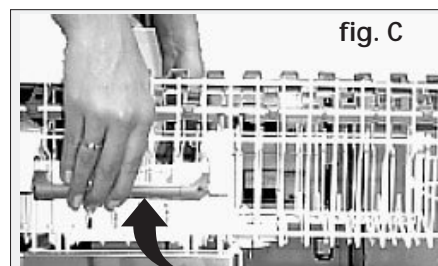

fig. C

Turning on the Appliance

First of all

Insert the plug into the electricity socket to power the dishwasher. Turn on the water tap completely and press ON-OFF button "A"; the display lights up and the wash cycle time selected on the knob will flash.

Selecting and starting a wash cycle.

- Select the desired wash cycle by turning knob "D" clockwise from wash cycle 1 to 7 and anticlockwise from 7 to 1; the display indicates the average duration of the wash cycle and the cycle phases it consists of (consult the wash cycle table contained on page 7, especially when first using the appliance).

- Press the Start button "R" and the wash cycle starts up, emitting a double beep; the approximate amount of time left until the end of the wash cycle is displayed.

- If the time indicated at the start of the wash cycle does not correspond to the actual duration of the cycle itself, this could be for a number of reasons: the temperature of the inlet water, the degree of soil, prolonged attempts by the appliance to clean the wash filter from food residue clogging it, etc.

Cycle phase under way indicator

While the wash cycle is under way, the symbols corresponding to the cycle phases light up in sequence.

Here are the symbols corresponding to each cycle phase:



Pre-wash



Wash



Rinses



Drying

Cancelling and modifying a wash cycle in progress

Premise: a wash cycle in progress can only be modified if it hasn't been running for long.

Keep the Reset button "R" pressed for about 3 seconds: a prolonged beep will sound, followed by three short beeps. The cancelled cycle time will flash on the display. Turn the knob to select a new wash cycle.

You've left out a dish?

You can interrupt a wash cycle by pressing the "ON-OFF" button, then place the forgotten dishes into the appliance, which will start up, after approximately 10 seconds, from where it was interrupted when you turn it back on.

There's been a power failure? Has the dishwasher door been opened?

The wash cycle stops and 3 dashes appear on the display; the cycle restarts as soon as the electricity comes back on or when the door is shut.

At the end of the wash cycle

The end of the wash cycle is indicated by two short beeps and the word "END" flashes on the display.

- Turn the appliance off at the ON-OFF button
- Turn off the water tap.
- Empty the lower rack first.

Make sure the wash cycle has ended before removing the dishes!

Warning: when you open the dishwasher door after the wash cycle has just ended or is under way, take care not to scald yourself with the hot steam.

How to set the extra drying



Press button "E". After a prolonged beep, indicator light "G" lights up and the time corresponding to the wash cycle selected on the knob will flash on the display.

Note: The time indicated on the display is extended due to the extra drying time.

To disable the extra drying option, press the same button and indicator light "G" will be turned off after a beep is sounded.

This option is incompatible with the soak cycle.

Setting a half load and a delayed start

How to set a delayed start



When you have loaded the dishes, you can choose when to start your dishwasher before setting the wash cycle desired.

- Press button "P" repeatedly to postpone the start of the wash cycle from 1 hour to 24h.
- If you press the button again, the word "OFF" is displayed (no selection made).

Once you have made your selection, make sure the appliance door is shut and start the wash cycle by pressing the **START** button.

Symbol "I" lights up on the display and the countdown begins.

- Once the countdown is up, the wash cycle begins and the approximate amount of time left until the end of the wash cycle is displayed.

Have you changed your mind?

- If you change your mind, you can set a shorter time delay: press button "D" to select it. You need not reset the wash cycle.

- If you have changed your mind and wish to start the wash cycle immediately, press button "P" until the countdown is fully reset. Indicator light "I" will turn off and the cycle will start at the sound of a beep.

The indicator light corresponding to the cycle phase under way will come up on the display and the countdown to the estimated cycle end begins.

You want to wash on one rack only?



Remember to use half the amount of detergent.

When you only have little cutlery to wash, you can run just half a load on the upper rack, saving on both water and electricity.

- Press button "F"; you will hear a beep and the symbol corresponding to the half load will light up.

Once you have made your setting, start the wash cycle by pressing the **START** button.

- *This option is available with all wash cycles.*







- *The Just You wash cycle is programmed to wash on the upper rack only.*

Warning: if the display indicates the word "dON" when you turn your dishwasher on, this means the demo mode is in operation. This mode is useful for exhibitors in that it simulates the wash cycles without actually carrying them out.

To quit this mode, keep the **START/RESET** button "R" pressed for approximately 4 seconds. The word "dOF" will be displayed once you have quit the demo mode successfully.

Wash Cycle Table

Dishwasher washing guarantees your dishes will be cleaned in a hygienic setting for safer, cleaner results.

Cycle	Cycle selection instructions	Cycle description	Detergent for pre-wash + wash	Rinse Aid	Wash cycle duration (±10% margin without extra drying)
 Intensive	Very dirty dishes and pans (not to be used for delicate items)	Pre-wash with hot water at 40°C Extended wash at 65°C 2 cold rinses Hot rinse at 65°C Drying.	5+25 g	*	120'
 Time 4 You	Normally dirty pans and dishes. Standard daily cycle.	Pre-wash with cold water. Wash at 50°C. Cold rinse Hot rinse at 70°C Drying.	5+25 g	*	72'
 Eco	Environmentally-friendly cycle, with low energy consumption levels, suitable for normally dirty pans and dishes.	2 pre-washes with cold water Extended wash at 50°C Hot rinse at 65°C Drying	5+25 g	*	120'
 Rapid 25'	Economic and fast cycle to be used for slightly dirty dishes. Run cycle immediately after use. Without drying except when the extra drying option has been selected.	Short wash at 50°C Rinse at 50°C Drying only if selected	25 g	* (with extra drying)	24'
 Soak	Preliminary wash cycle for dishes and pans awaiting completion of the load with the dishes from the next meal.	Short cold wash to prevent food from drying onto the dishes.			12'
 Crystal Care	Special cycle to be used for delicate items, which are more sensitive to high temperatures.	Wash at 50°C Rinse at 45°C Hot rinse at 65°C Drying	25 g	*	96'
 Just You	Quick and economic wash for a daily load of dishes. This may only be done on the upper rack.	Wash at 50°C Hot rinse at 70°C	25 g		48'

Energy Saving Tips

- It is important to try and run the dishwasher when it is fully loaded in order to save on energy. In order to prevent odors from forming and food from caking onto the dishes, you can run the hold cycle.

- Choose the right wash cycle: the choice of cycle depends on the type of dishware, cookware and utensils being washed and how dirty they are.

- Use the right amount of detergent: if you use too much detergent, the result will not be cleaner dishes, but, rather, a greater negative impact on the environment.

- There is no utility in rinsing dishes, cookware and utensils before placing them in the dishwasher.

How to Keep Your Dishwasher in Shape

After Every Wash

After every wash, turn off the water supply to the appliance and leave the door slightly ajar so that moisture and odors are not trapped inside.

Remove the Plug

Before cleaning or performing maintenance, always remove the plug from the socket. Do not run risks.

No Solvents or Abrasive Cleaning Products

To clean the exterior and rubber parts of the dishwasher, do not use solvents or abrasive cleaning products. Rather, use only a cloth and warm soapy water.

To remove spots or stains from the surface of the interior, use a cloth dampened with water and a little white vinegar, or a cleaning product made specifically for dishwashers.

When You Go on Holiday

When you go on holiday, it is recommended that you run a wash cycle with the dishwasher empty and then remove the plug from the socket, turn off the water supply and leave the door of the appliance slightly ajar. This will help the seals last longer and prevent odors from forming within the appliance.

Moving the Appliance

If the appliance must be moved, try to keep it in the vertical position. If absolutely necessary, it can be positioned on its back.

Seals

One of the factors that cause odors to form in the dishwasher is food that remains trapped in the seals. Periodic cleaning with a damp sponge will prevent this from occurring.

Cleaning and Special Maintenance

The filter assembly

If you want consistent good results from your dishwasher, you need to clean the filter assembly.

The food particles are removed from the wash water, allowing it to be recirculated during the cycle, filtered perfectly. For this reason, it is a good idea to remove the larger food particles trapped inside the semi-circular filter **A** and cup "C" after each wash; to remove the filter assembly, pull the cup handle upwards. All you need to do is rinse them under running water.

The entire filter assembly should be cleaned thoroughly once a month: semi-circular filter A + cup C + cylindrical filter B + microfilter D.

To remove filter "B", turn it anti-clockwise. Use a small non-metallic brush for cleaning.

Reassemble the filter parts (as shown in the figure) and reinsert the whole assembly into the dishwasher. Position it into its housing and press downwards.

The dishwasher is not to be used without filters. Improper replacement of the filters may reduce the efficiency of the wash and even damage your dishwasher.

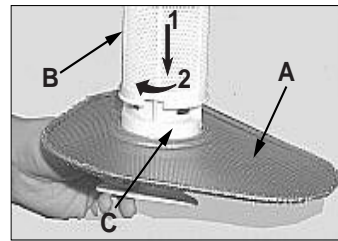
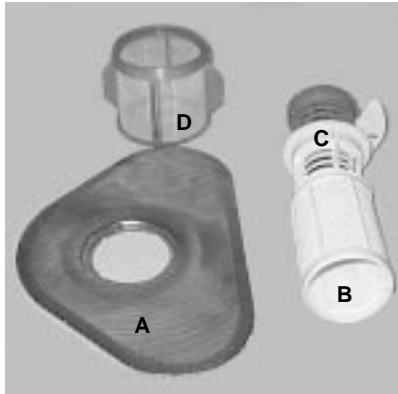

Cleaning the Sprayer Arms

It may happen that food particles become encrusted on the sprayer arms and block the holes (see "Close up view (interior)", letters F-I). Check the sprayer arms periodically and clean them when needed.

Cleaning the Water Inlet Filter

Periodically clean the water inlet filter (see figure 2 under "Installation") located on the outlet of the water supply tap. After turning off the water tap, unscrew the end of the water supply hose, remove the filter and clean it carefully under running water. Then, return the filter to its place and tighten the water supply hose back into position.

Troubleshooting

It may occur that the dishwasher does not function or does not function properly. Before calling for assistance, let us see what can be done first: have you forgot to press one of the buttons or to perform an essential operation?

The Dishwasher Does Not Start

Have you checked whether:

- the plug is pushed into the socket correctly;
- the power is on in the house;
- the door is closed properly;
- the ON-OFF switch is on "ON";
- the water supply is turned on.

The Dishwasher Does Not Load Water

Have you checked whether:

- the water is turned on and the hose is connected properly;
- the water supply to the house is on and has sufficient pressure;
- the water supply hose is crimped or bent;
- the filter for the water supply hose is clogged.

The Dishes Are Not Clean

Have you put the right amount of detergent into the dispenser?

Is the wash cycle suitable for the dishes you have placed inside the appliance?

Are the filter and microfilter clean?

Can the sprayer arms turn freely?

The Dishwasher Does Not Drain

Have you checked whether:

- the drain hose is crimped or bent.

Lime Deposits or a White Film Form on the Dishes

Have you checked whether:

- the lid to the salt container is closed properly;
- the rinse aid dosage is correct.

If the display indicates the word "dON" when you turn your dishwasher on, this means the demo mode is in operation.

Read the instructions on pages 7.

Error messages.

Your dishwasher is equipped with a safety system which is able to detect any operating anomalies.

These anomalies or faults are signalled by several codes consisting of letters and numbers that flash up on the display. Make a note of the error code that appears, turn the appliance off, turn off the water tap and call for technical assistance.

Tap off alarm

If you have forgotten to turn on the water tap, the appliance will remind you with a series of prolonged beeps and the wording **H2O** will flash up on the display. Turn the tap on and the wash cycle will start up after a few minutes.

If you are not there when the **H2O** signal appears, the appliance will switch to alarm mode and the code "**A06**" will flash on the display. Turn the appliance off at button "A", turn on the water tap and wait approximately 20 seconds before turning the appliance back on, the wash cycle will start up again.

Clogged filter alarm

If the appliance is blocked and the code "**A05**" is flashing, this means the filter is clogged by large particles of food residue. Turn the appliance off at the ON-OFF button, clean the filter thoroughly and reposition it in its seat, then turn the appliance back on. The wash cycle will start up as normal after a few seconds.

Water load solenoid valve malfunction alarm

If the code "**A02**" flashes, first of all turn off the water tap to avoid any flooding and then cut off the electricity supply and call for assistance.

If, despite all these checks, the dishwasher still does not function and/or the problem persists, contact the nearest authorised service centre and provide them with the following information:

- the nature of the problem;
- the model type number (Mod. ...) and the serial number (S/N ...), which are indicated on the plate located on the side of the inner part of the door.

Never call on unauthorised technicians and refuse to allow parts to be installed that are not original spare parts.

Installation

Positioning the Appliance

Position the appliance in the desired location. The back should rest against the wall behind it, and the sides, along the adjacent cabinets or wall. The dishwasher is equipped with water supply and drain hoses that can be positioned to the right or the left to facilitate proper installation.

Levelling the Appliance

Once the appliance is positioned, adjust the feet (screwing them in or out) to adjust the height of the dishwasher, making it level. In any case, the appliance should not be inclined more than 2°.

If the appliance is level, it will help ensure proper performance.

This dishwasher model can be built under a single worktop (please read the relevant instruction sheet).

Cold Water Connection

This electric household appliance should be connected to the water mains using the cold water supply hose provided with the appliance only. Do not use a different hose. In the event of replacements, use original spare parts only.

Connect the cold water supply hose to a threaded 3/4 (gas) connector, inserting the small filter supplied with the dishwasher and making sure that it is fastened tightly in place (see figure 2).

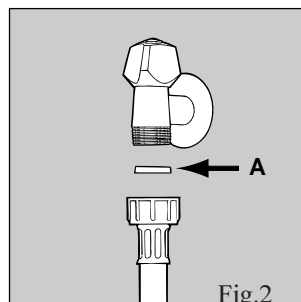

If the water pipes are new or have not been used for an extended period of time, let the water run to make sure that the water is clear and free of impurities. If this precaution is not taken, there is a risk that the water inlet can get blocked and damage the appliance.

Hot Water Connection

The water supply to the appliance can also be connected to the house's hot water line (centralised system, heating system), as long as it does not exceed a temperature of 60° C.

In this case, the wash cycle time will be shortened by about 15 minutes and the wash efficiency slightly reduced.

The connection must be made to the hot water line following the same procedures as those for the connection to the cold water line.

Drain Hose Connection

Fit the drain pipe into a drain line with a minimum diameter of 4 cm or place it over the sink. Avoid restricting or bending it. Use the special plastic elbow provided (see figure) to position it in the best possible way. The part of the pipe marked with the letter A should be between 40 and 100 cm above the ground.

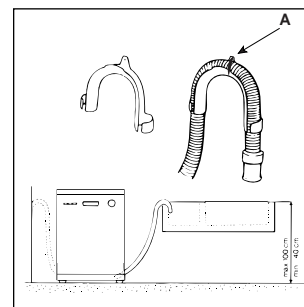

The pipe should not be immersed in water.

Attention: *The special plastic hose support must be solidly fastened to the wall to prevent the drain hose from moving and allowing water to spill outside the drain.*

Electrical Connection

After making sure that the voltage and frequency values for the current in the home correspond to those on the rating plate (located on the stainless steel inner door of the appliance) and that the electrical system is sized for the maximum voltage on the rating plate, insert the plug into an electrical socket which is earthed properly (the earthing of the appliance is a safety requirement mandated by law). If the electrical socket to which the appliance must be connected is not appropriate for the plug, replace the plug, rather than using adaptors or the like as they could cause overheating and burns.

Should the electricity supply cable be damaged, we recommend that you only contact authorised Technical Service Centres for the replacement.

The plug

The dishwasher plug must be accessible even when the appliance is installed as a built-in unit so that maintenance can be done safely.

Electrical Connection

Electrical Connection

If your appliance is supplied with a 13 amp. fused plug it can be plugged into a 13 amp socket for immediate use. Before using the appliance please read the instruction below.

WARNING: THIS APPLIANCE MUST BE EARTHED. THE FOLLOWING OPERATIONS SHOULD BE CARRIED OUT BY A QUALIFIED ELECTRICIAN.

Replacing the fuse:

When replacing a faulty fuse, a 13 amp ASTA approved fuse to BS 1362 should always be used, and the fuse cover re-fitted. If the fuse cover is lost, the plug must not be used until a replacement is obtained.

Replacement fuse covers:

If a replacement fuse cover is fitted, it must be of the correct colours as indicated by the coloured marking or the colour that is embossed in words on the base of the plug. Replacements can be obtained directly from your nearest Service Depot.

Removing the plug:

If your appliance has a non-rewireable moulded plug and you should wish to remove it to re-route the mains cable through partitions, units etc., please ensure that either:

- the plug is replaced by a fused 13 amp re-wireable plug bearing the BSI mark of approval
- or:
- the mains cable is wired directly into a 13 amp cable outlet, controlled by a switch, (in compliance with BS 5733) which is accessible without moving the appliance.

Disposing of the plug:

Ensure that before disposing of the plug itself, you make the pins unusable so that it cannot be accidentally inserted into a socket.

Instruction for connecting cable to an alternative plug:

Important: the wires in the mains lead are coloured in accordance with the following code:

Green & Yellow - **Earth**
Blue - **Neutral**
Brown - **Live**

CAUTION:

The dishwasher plug must be accessible even when the appliance is installed as a built-in unit so that maintenance can be done safely.

As the colours of the wires in the mains lead may not correspond with the coloured markings identifying the terminal in your plug, proceed as follows: connect Green & Yellow wire to terminal marked "E" or \perp coloured Green or Green & Yellow.

Connect Brown wire to terminal marked "L" or coloured Red.

Connect Blue wire to terminal marked "N" or coloured Black.

If a 13 amp plug (BS 1363) is used it must be fitted with a 13 amp fuse. A 15 amp plug must be protected by a 15 amp fuse, either in the plug or adaptor or at the distribution board.

If you are in any doubt about the electrical supply to your machine, consult a qualified electrician before use.

How to connect an alternative plug:

The wires in this mains lead are coloured in accordance with the following code:

BLUE "NEUTRAL" ("N")
BROWN "LIVE" ("L")
GREEN AND YELLOW "EARTH" ("E")

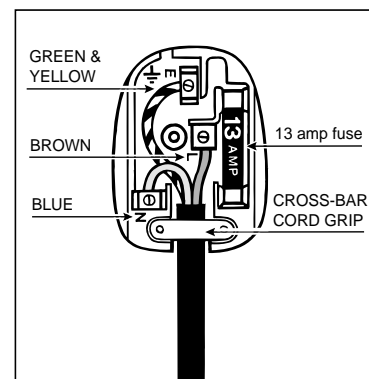

Disposing of the appliance:

When disposing of the appliance please remove the plug by cutting the mains cable as close as possible to the plug body and dispose of it as described above.

Free Manuals Download Website

<http://myh66.com>

<http://usermanuals.us>

<http://www.somanuals.com>

<http://www.4manuals.cc>

<http://www.manual-lib.com>

<http://www.404manual.com>

<http://www.luxmanual.com>

<http://aubethermostatmanual.com>

Golf course search by state

<http://golfingnear.com>

Email search by domain

<http://emailbydomain.com>

Auto manuals search

<http://auto.somanuals.com>

TV manuals search

<http://tv.somanuals.com>