

# Operating Instructions

OVEN

GB

English, 1

FIE 56 K.B GB/1

FIE 56 K.B IX GB/1

## Contents

### Installation, 2-3

Positioning  
Electrical connections  
Data plate

### Description of the appliance, 4

Overall view  
Control panel

### Start-up and use, 5

Starting the oven

### Cooking modes, 6-7

Cooking modes  
Practical cooking advice  
Cooking advice table

### The electronic cooking programmer, 8

### Precautions and tips, 9

General safety  
Disposal  
Respecting and conserving the environment

### Maintenance and care, 10

Switching the appliance off  
Cleaning the appliance  
Cleaning the oven door  
Replacing the light bulb  
Assistance

GB

 **INDESIT**

# Installation

GB

! Before placing your new appliance into operation please read these operating instructions carefully. They contain important information for safe use, for installation and for care of the appliance.

! Please keep these operating instructions for future reference. Pass them on to possible new owners of the appliance.

## Positioning

! Keep packaging material out of the reach of children. It can become a choking or suffocation hazard. (see *Precautions and tips*).

! The appliance must be installed by a qualified person in compliance with the instructions provided. Incorrect installation may cause harm to persons, animals or may damage property.

## Fitting the appliance

Use the appropriate cabinet to ensure that the appliance functions properly.

- The panels adjacent to the oven must be made of heat-resistant material.
- Cabinets with a veneer exterior must be assembled with glues which can withstand temperatures of up to 100°C.
- to install the oven under the counter (see *diagram*) and in a kitchen unit, the cabinet must have the following dimensions:

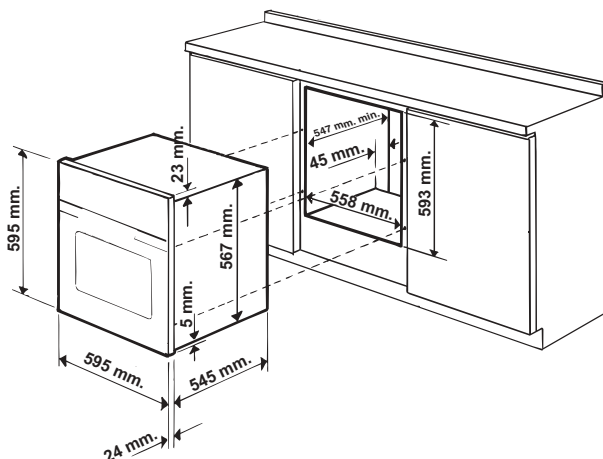

! The appliance must not come into contact with electrical parts once it has been installed. The consumption indications on the data plate have been calculated for this type of installation.

## Ventilation

To ensure good ventilation, the back panel of the cabinet must be removed. It is advisable to install the oven so that it rests on two strips of wood, or on a completely flat surface with an opening of at least 45 x 560 mm (see *diagrams*).

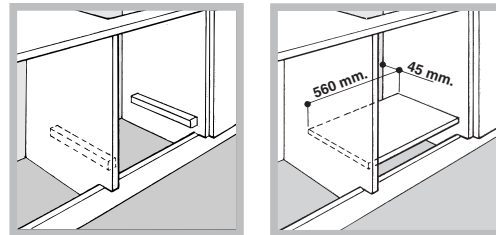

## Centring and fastening

Secure the appliance to the cabinet by opening the oven door and putting 4 screws into the 4 holes of the outer frame.

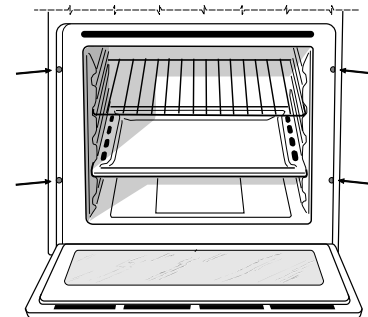

! All parts which ensure the safe operation of the appliance must not be removable without the aid of a tool.

## Electrical connection

! Ovens with a three-pole power supply cable are designed to operate with alternated current at the supply frequency and voltage indicated on the data plate (at the bottom of the oven dashboard). The earthing conductor of the cable is the yellow-green conductor.

### Two types of connection are provided:

#### Connection n° 1

#### Connecting the power supply cable to the mains.

Fit a normalized plug to the cable, which corresponds to the load indicated on the data plate; if the cooker is connected directly to the mains, an omnipolar circuit-breaker with a minimum opening of 3 mm between the contacts, suitable for the load indicated and complying with current directives, must be installed between the appliance and the mains (the earthing wire must not be interrupted by the circuit-breaker). The power supply cable must be positioned so that it does not exceed room temperature by 50°C at any point of its length. Before making the connection check that:

- the circuit breakers or fuses of the home system can support appliance load (see data plate);
- the power supply system has an efficient earthing connection which complies with the provisions of current regulations and the law;
- there is easy access to the socket or the omnipolar circuit-breaker once the cooker has been installed.

! do not use reducers, adapters or shunts as these could cause heating or burning.

#### Connection n° 2

#### Disposing of the plug.

#### ! THIS APPLIANCE MUST BE EARTHED.

Ensure that before disposing of the plug itself, you make the pins unusable so that it cannot be accidentally inserted into a socket. Instructions for connecting cable to an alternative plug:

! the wires in the mains lead are coloured in accordance with the following code:

Green & Yellow -Earth  
 Blue -Neutral  
 Brown -Live

If the colours of the wires in the mains lead do not correspond with the coloured markings identifying the terminals in your plug, proceed as follows.

Connect Green & Yellow wire to terminal marked "E" or 6 or coloured Green or Green & Yellow.

Connect Brown wire to terminal marked "L" or

coloured Red. Connect Blue wire to terminal marked "N" or coloured Black. If a 13 amp plug (BS 1363) is used it must be fitted with a 13 amp fuse.

A 15 amp plug must be protected by a 15 amp fuse, either in the plug or adaptor or at the distribution board. If you are in any doubt about the electrical supply to your machine, consult a qualified electrician before use.

#### How to connect an alternative plug

The wires in this mains lead are coloured in accordance with the following code:

BLUE "NEUTRAL" (N)  
 BROWN "LIVE" (L)  
 GREEN AND YELLOW "EARTH" (E)

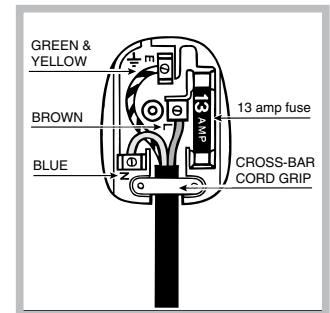

#### Disposing of the appliance

When disposing of the appliance please remove the plug by cutting the mains cable as close as possible to the plug body and dispose of it as described above.

#### ! The plug and socket must be easily accessible.

DATA PLATE	
<b>Dimensions</b>	width cm 43.5 height cm 32 depth cm 40
<b>Volume</b>	lt. 56
<b>Electrical connections</b>	voltage: 230-240V ~ 50Hz maximum power absorbed 2250W -2400W
<b>ENERGY LABEL</b>	Directive 2002/40/EC on the label of electric ovens. Standard EN 50304  Energy consumption for Natural convection – heating mode: Convection mode  Declared energy consumption for Forced convection Class – heating mode: Multi-cooking
 	This appliance conforms to the following European Economic Community directives: - 2006/95/EEC of 12/12/06 (Low Voltage) and subsequent amendments; - 89/336/EEC of 03/05/89 (Electromagnetic Compatibility) and subsequent amendments; - 93/68/EEC of 22/07/93 and subsequent amendments. - 2002/96/EC

# Description of the appliance

GB

## Overall view

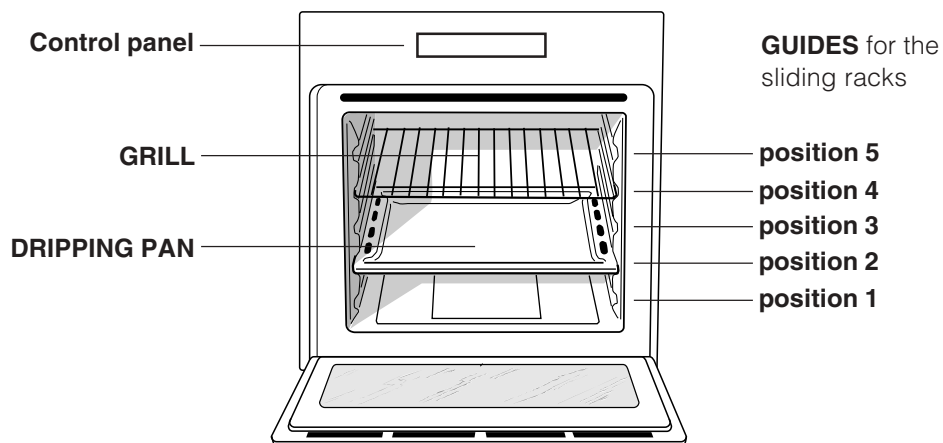

## Control panel

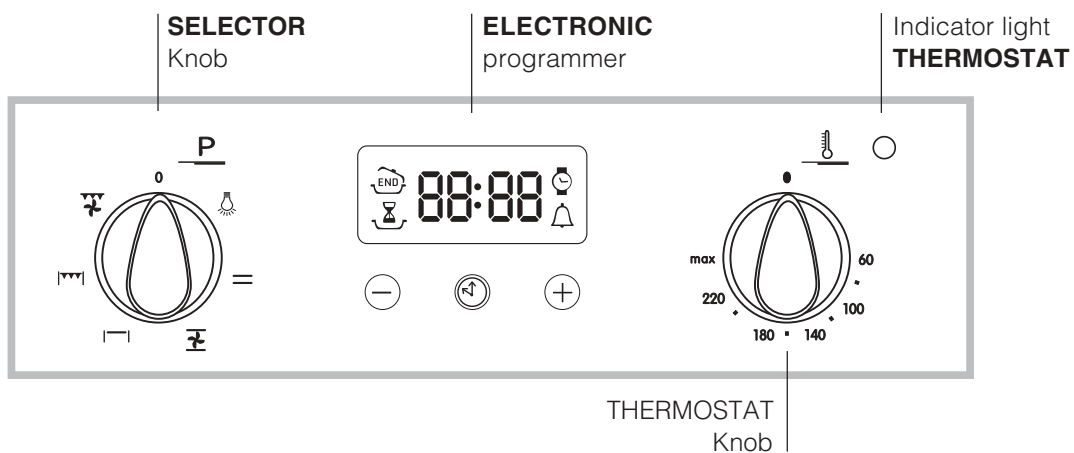

! The first time you use your appliance, heat the empty oven with its door closed at its maximum temperature for at least half an hour. Ensure that the room is well ventilated before switching the oven off and opening the oven door. The appliance may produce a slightly unpleasant odour caused by the burning away of protective substances used during the manufacturing process.

## Starting the oven

1. Select the desired cooking mode by turning the SELECTOR knob.
2. Select the desired temperature with the THERMOSTAT knob. See the Cooking advice table for cooking modes and the suggested cooking temperatures (*see Cooking Modes*).
3. When preheating is finished, the THERMOSTAT indicator light will stay on: place the food in the oven.
4. You may do the following during cooking:
  - change the cooking mode by turning the SELECTOR knob.
  - change the temperature by turning the THERMOSTAT knob.
  - stop cooking by turning the SELECTOR knob to the "0" position.

! Never put objects directly on the oven bottom to avoid damaging the enamel coating.

! Always place cookware on the rack(s) provided.

## Cooling ventilation

In order to cool down the external temperature of the oven, some models are fitted with a cooling fan that blows out air between the control panel and the oven door.

! Once the cooking has been completed, the cooling fan remains on until the oven has cooled down sufficiently.

## Oven light

It goes on when selecting  with the SELECTOR knob. It stays on when a cooking mode is selected.

# Cooking modes

GB

## Cooking modes

! A temperature value can be set for all cooking modes between 60°C and Max, except for

- GRILL (recommended: set only to MAX power level);
- GRATIN (recommended: do not exceed 200°C).

### **TRADITIONAL OVEN** mode

Both the top and bottom heating elements will come on. With this traditional cooking mode, it is best to use one cooking rack only; if more than one rack is used, the heat will be distributed unevenly.

### **MULTI-COOKING** mode

All the heating elements (top and bottom), as well as the fan, will come on. Since the heat remains constant throughout the oven, the air cooks and browns food uniformly. A maximum of two racks may be used at the same time.

### **TOP OVEN** mode

The top heating element comes on. This mode can be used to brown food at the end of cooking.

### **GRILL** mode

The top heating element comes on. The extremely high and direct temperature of the grill makes it possible to brown the surface of meats and roasts while locking in the juices to keep them tender. The grill is also highly recommended for dishes that require a high temperature on the surface: such as beef steaks, veal, rib steak, filets, hamburgers etc... Some grilling examples are included in the "Practical Cooking Advice" paragraph. Always cook in this mode with the oven door partially open.

### **GRATIN** mode

The top heating element, as well as the fan, will come on. This combination of features increases the effectiveness of the unidirectional thermal radiation of the heating elements through forced circulation of the air throughout the oven. This helps prevent food from burning on the surface, allowing the heat to penetrate right into the food. Always cook in this mode with the oven door closed.

## Practical cooking advice

! Do not place racks in position 1 and 5 during fan-assisted cooking. Excessive direct heat can burn temperature sensitive foods.

! In the GRILL and GRATIN cooking modes, place the dripping pan in position 1 to collect cooking residues (fat and/or grease).

### MULTI-COOKING

- Use position 2 and 4, placing the food that requires more heat on 2.
- Place the dripping pan on the bottom and the rack on top.

### GRILL

- Insert the rack in position 3 or 4. Place the food in the centre of the rack.
- We recommend that you set the maximum power level. The top heating element is regulated by a thermostat and may not always be on.

### PIZZA

- For best results when cooking pizza, use the MULTI-COOKING mode.
- Use a light aluminium pizza pan. Place it on the rack provided.  
For a crispy crust, do not use the dripping pan (prevents crust from forming by extending cooking time).
- If the pizza has a lot of toppings, we recommend adding the mozzarella cheese on top of the pizza halfway through the cooking process.

**Cooking advice table**

Cooking modes	Foods	Weight (in kg)	Rack position	Pre-heating time (min)	Recommended temperature	Cooking time (minutes)
<b>Convection Oven</b>	Duck	1	3	15	200	65-75
	Roast veal or beef	1	3	15	200	70-75
	Pork roast	1	3	15	200	70-80
	Biscuits (short pastry)	-	3	15	180	15-20
	Tarts	1	3	15	180	30-35
<b>Multi-cooking</b>	Pizza (on 2 racks)	1	2 and 4	15	230	15-20
	Lasagne	1	3	10	180	30-35
	Lamb	1	2	10	180	40-45
	Roast chicken + potatoes	1+1	2 and 4	15	200	60-70
	Mackerel	1	2	10	180	30-35
	Plum cake	1	2	10	170	40-50
	Cream puffs (on 2 racks)	0.5	2 and 4	10	190	20-25
	Biscuits (on 2 racks)	0.5	2 and 4	10	180	10-15
	Sponge cake (on 1 rack)	0.5	2	10	170	15-20
	Sponge cake (on 2 racks)	1	2 and 4	10	170	20-25
Savoury pies	1.5	3	15	200	25-30	
<b>Top oven</b>	Browning food to perfect cooking	-	3/4	15	220	-
<b>Grill</b>	Soles and cuttlefish	1	4	5	Max	8-10
	Squid and prawn kebabs	1	4	5	Max	6-8
	Cod filet	1	4	5	Max	10
	Grilled vegetables	1	3 or 4	5	Max	10-15
	Veal steak	1	4	5	Max	15-20
	Cutlets	1	4	5	Max	15-20
	Hamburgers	1	4	5	Max	7-10
	Mackerels	1	4	5	Max	15-20
	Toasts	4	4	5	Max	2-3
<b>Gratin</b>	Grilled chicken	1.5	2	5	200	55-60
	Cuttlefish	1.5	2	5	200	30-35

# The electronic cooking programmer

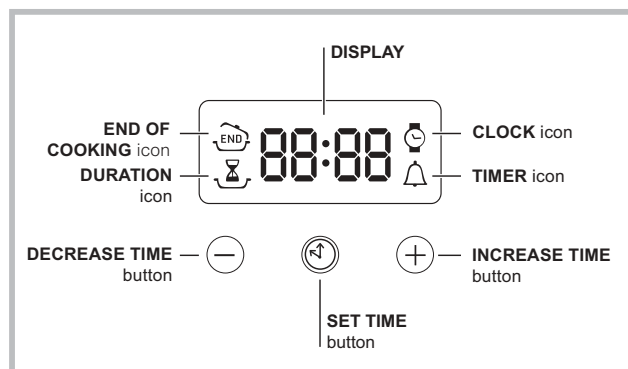

GB



## Setting the clock



! The clock may be set when the oven is switched off or when it is switched on, provided that a the end time of a cooking cycle has not been programmed previously.

After the appliance has been connected to the mains, or after a blackout, the  icon and the four numerical digits on the DISPLAY will begin to flash.

1. Press the  button several times until the  icon and the four digits on the display begin to flash.
2. Use the "+" and "-" buttons to adjust the time; if you press and hold either button, the display will scroll through the values more quickly, making it quicker and easier to set the desired value.
3. Wait for 10 seconds or press the  button again to finalise the setting.

## Setting the timer



! This function does not interrupt cooking and does not affect the oven; it is simply used to activate the buzzer when the set amount of time has elapsed.

1. Press the  button several times until the  icon and the three digits on the display begin to flash.
2. Use the "+" and "-" buttons to set the desired time; if you press and hold either button, the display will scroll through the values more quickly, making it quicker and easier to set the value.
3. Wait for 10 seconds or press the  button again to finalise the setting.  
The display will then show the time as it counts down. When this period of time has elapsed the buzzer will be activated.

## Programming cooking





! A cooking mode must be selected before programming can take place.

### Programming the cooking duration

1. Press the  button several times until the  icon and the three digits on the DISPLAY begin to flash.
2. Use the "+" and "-" buttons to set the desired duration; if you press and hold either button, the display will scroll through the values more quickly, making it quicker and easier to set the value.
3. Wait for 10 seconds or press the  button again to finalise the setting.
4. When the set time has elapsed, the text END appears on the DISPLAY, the oven will stop cooking and a buzzer sounds.
  - For example: it is 9:00 a.m. and a time of 1 hour and 15 minutes is programmed. The programme will stop automatically at 10:15 a.m.

### Setting the end time for a cooking mode

! A cooking duration must be set before the cooking end time can be scheduled.

1. Follow steps 1 to 3 to set the duration as detailed above.
2. Next, press the  button until the  icon and the four digits on the DISPLAY begin to flash.
3. use the "+" and "-" buttons to adjust the cooking end time; if you press and hold either button, the display will scroll through the values more quickly, making it quicker and easier to set the desired value.
4. Wait for 10 seconds or press the  button again to finalise the setting.
5. When the set time has elapsed, the text END appears on the DISPLAY, the oven will stop cooking and a buzzer sounds.  
Programming has been set when the  and  buttons are illuminated. The DISPLAY shows the cooking end time and the cooking duration alternately.

### Cancelling a programme

To cancel a programme:

- press the  button until the icon corresponding to the setting you wish to cancel and the digits on the display are no longer flashing. Press the "-" button until the digits 00:00 appear on the display.
- Press and hold the "+" and "-" buttons; this will cancel all the settings selected previously, including timer settings.



! The appliance was designed and manufactured in compliance with international safety standards. The following warnings are provided for safety reasons and must be read carefully.

## General safety

- The appliance was designed for domestic use inside the home and is not intended for commercial or industrial use.
- The appliance must not be installed outdoors, even in covered areas. It is extremely dangerous to leave the appliance exposed to rain and storms.
- When handling the appliance, always use the handles provided on the sides of the oven.
- Do not touch the appliance with bare feet or with wet or moist hands and feet.
- The appliance must be used to cook food by adults only and according to the instructions in this manual.
- **When the appliance is in use, the heating elements and some parts of the oven door become extremely hot. Make sure you don't touch them and keep children well away.**
- Ensure that the power supply cable of other electrical appliances does not come into contact with the hot parts of the oven.
- The openings used for ventilation and dispersion of heat must never be covered.
- Always grip the oven door handle in the centre: the ends may be hot.
- Always use oven gloves to place cookware in the oven or when removing it.
- Do not use aluminium foil to line the bottom of the oven.
- Do not place flammable materials in the oven: if the appliance is switched on by mistake, it could catch fire.
- Always make sure the knobs are in the “●”/“○” position when the appliance is not in use.
- When unplugging the appliance always pull the plug from the mains socket, do not pull on the cable.
- Never carry out any cleaning or maintenance work without having unplugged the plug from the mains.

- In the case of a malfunction, under no circumstances should you attempt to repair the appliance yourself. Repairs carried out by inexperienced persons may cause injury or further malfunctioning of the appliance. Contact a Service Centre (*see Assistance*).
- Do not rest heavy objects on the open oven door.
- The appliance should not be operated by people (including children) with reduced physical, sensory or mental capacities, by inexperienced individuals or by anyone who is not familiar with the product. These individuals should, at the very least, be supervised by someone who assumes responsibility for their safety or receive preliminary instructions relating to the operation of the appliance.
- Do not let children play with the appliance.

## Disposal

- Observe local environmental standards when disposing packaging material for recycling purposes. Observe existing legislation when disposing of the old appliance.
- The European Directive 2002/96/EC on Waste Electrical and Electronic Equipment (WEEE), requires that old household electrical appliances must not be disposed of in the normal unsorted municipal waste stream. Old appliances must be collected separately in order to optimise the recovery and recycling of the materials they contain and reduce the impact on human health and the environment. The crossed out “wheeled bin” symbol on the product reminds you of your obligation, that when you dispose of the appliance it must be separately collected. Consumers should contact their local authority or retailer for information concerning the correct disposal of their old appliance.

## Respecting and conserving the environment

- By using the appliance in the hours between late afternoon and early morning, you can help reduce the work load placed on electrical companies.
- Regularly check the door seals and wipe clean to ensure they are free of debris so that they stick properly to the door and do not allow heat to disperse.

# Maintenance and care

GB

## Switching the appliance off

Disconnect your appliance from the electricity supply before carrying out any work on it.

## Cleaning the appliance

- The stainless-steel or enamel-coated external parts as well as the rubber seals may be cleaned using a sponge that has been soaked in lukewarm water and neutral soap. If these stains are difficult to remove, use only specialised products. After cleaning, rinse and dry thoroughly. Do not use abrasive powders or corrosive substances.
- Ideally, the inside of the oven should be cleaned after each use, when it is still lukewarm. Use hot water and detergent, rinse and dry with a soft cloth. Do not use abrasive products.
- The accessories can be washed like everyday crockery (even in your dishwasher).

! Never use steam cleaners or pressure cleaners on the appliance.

## Cleaning the oven door

Clean the glass part of the oven door using a sponge and a non-abrasive cleaning product, then dry thoroughly with a soft cloth. Do not use rough abrasive material or sharp metal scrapers as these could scratch the surface and cause the glass to crack.

To clean more thoroughly, you can remove the oven door.

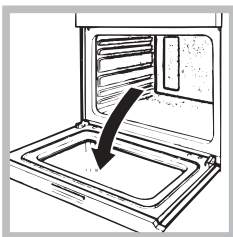

1. Open the oven door fully (see diagram)



2. Lift up and turn the small levers located on the two hinges (see diagram)

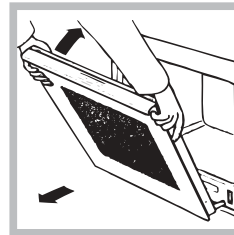

3. Grip the door on the two external sides and close it approximately half way. Then pull the door towards you lifting it out of its seat (see diagram).

To replace the door, reverse this sequence.

## Inspecting the seals

Check the door seals around the oven periodically. If the seals are damaged, please contact your nearest After-sales Service Centre (see Assistance). We recommend not using the oven until the seals have been replaced.

## Replacing the light bulb

To replace the oven light bulb:

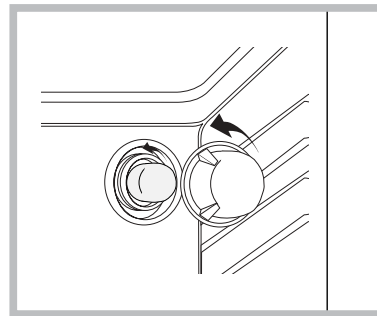

1. Remove the glass cover of the lamp-holder.
2. Remove the light bulb and replace it with a similar one: Wattage 25 W, cap E 14.
3. Replace the glass cover (see diagram).

## Assistance

### Communicating:

- appliance model (Mod.)
- serial number (S/N)

This information is found on the data plate located on the appliance and/or on the packaging.





## Free Manuals Download Website

<http://myh66.com>

<http://usermanuals.us>

<http://www.somanuals.com>

<http://www.4manuals.cc>

<http://www.manual-lib.com>

<http://www.404manual.com>

<http://www.luxmanual.com>

<http://aubethermostatmanual.com>

Golf course search by state

<http://golfingnear.com>

Email search by domain

<http://emailbydomain.com>

Auto manuals search

<http://auto.somanuals.com>

TV manuals search

<http://tv.somanuals.com>