

# Operating Instructions

OVEN

**GB**

English, 1

**FIE 56 K.B GB**

**FIE 56 K.B IX GB**

## Contents

### Installation, 2-3

Positioning  
Electrical connections  
Data plate

### Description of the appliance, 4

Overall view  
Control panel

### Start-up and use, 5

Starting the oven

### Cooking modes, 6-7

Cooking modes  
Practical cooking advice  
Cooking advice table

### The electronic cooking programmer, 8

### Precautions and tips, 9

General safety  
Disposal  
Respecting and conserving the environment

### Maintenance and care, 10

Switching the appliance off  
Cleaning the appliance  
Cleaning the oven door  
Replacing the light bulb  
Assistance

**GB**

 **INDESIT**

# Installation

GB

! Before placing your new appliance into operation please read these operating instructions carefully. They contain important information for safe use, for installation and for care of the appliance.

! Please keep these operating instructions for future reference. Pass them on to possible new owners of the appliance.

## Positioning

! Keep packaging material out of the reach of children. It can become a choking or suffocation hazard. (see *Precautions and tips*).

! The appliance must be installed by a qualified person in compliance with the instructions provided. Incorrect installation may cause harm to persons, animals or may damage property.

## Fitting the appliance

Use the appropriate cabinet to ensure that the appliance functions properly.

- The panels adjacent to the oven must be made of heat-resistant material.
- Cabinets with a veneer exterior must be assembled with glues which can withstand temperatures of up to 100°C.
- to install the oven under the counter (see *diagram*) and in a kitchen unit, the cabinet must have the following dimensions:

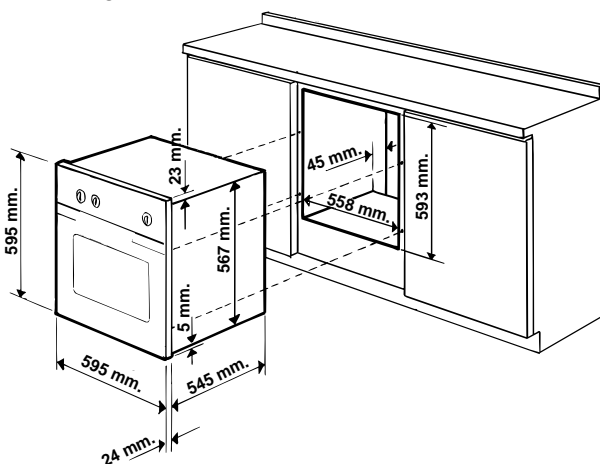

! The appliance must not come into contact with electrical parts once it has been installed. The consumption indications on the data plate have been calculated for this type of installation.

## Ventilation

To ensure good ventilation, the back panel of the cabinet must be removed. It is advisable to install the oven so that it rests on two strips of wood, or on a completely flat surface with an opening of at least 45 x 560 mm (see *diagrams*).

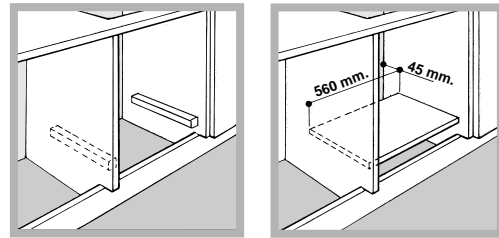

## Centring and fastening

Secure the appliance to the cabinet by opening the oven door and putting 4 screws into the 4 holes of the outer frame.

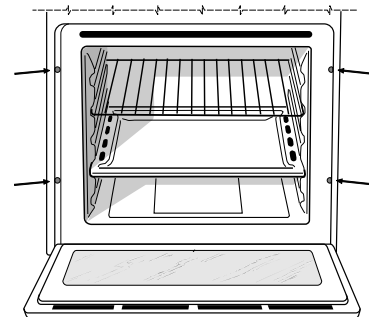

! All parts which ensure the safe operation of the appliance must not be removable without the aid of a tool.

## Electrical connection

! Ovens with a three-pole power supply cable are designed to operate with alternated current at the supply frequency and voltage indicated on the data plate (at the bottom of the oven dashboard). The earthing conductor of the cable is the yellow-green conductor.

**Two types of connection are provided:**

### Connection n° 1

#### Connecting the power supply cable to the mains.

Fit a normalized plug to the cable, which corresponds to the load indicated on the data plate; if the cooker is connected directly to the mains, an omnipolar circuit-breaker with a minimum opening of 3 mm between the contacts, suitable for the load indicated and complying with current directives, must be installed between the appliance and the mains (the earthing wire must not be interrupted by the circuit-breaker). The power supply cable must be positioned so that it does not exceed room temperature by 50°C at any point of its length. Before making the connection check that:

- the circuit breakers or fuses of the home system can support appliance load (see data plate);
- the power supply system has an efficient earthing connection which complies with the provisions of current regulations and the law;
- there is easy access to the socket or the omnipolar circuit-breaker once the cooker has been installed.

! do not use reducers, adapters or shunts as these could cause heating or burning.

### Connection n° 2

Disposing of the plug.

**! THIS APPLIANCE MUST BE EARTHED.**

Ensure that before disposing of the plug itself, you make the pins unusable so that it cannot be accidentally inserted into a socket. Instructions for connecting cable to an alternative plug:

! the wires in the mains lead are coloured in accordance with the following code:

Green & Yellow -Earth  
 Blue -Neutral  
 Brown -Live

If the colours of the wires in the mains lead do not correspond with the coloured markings identifying the terminals in your plug, proceed as follows.

Connect Green & Yellow wire to terminal marked "E" or 6 or coloured Green or Green & Yellow.

Connect Brown wire to terminal marked "L" or

coloured Red. Connect Blue wire to terminal marked "N" or coloured Black. If a 13 amp plug (BS 1363) is used it must be fitted with a 13 amp fuse.

A 15 amp plug must be protected by a 15 amp fuse, either in the plug or adaptor or at the distribution board. If you are in any doubt about the electrical supply to your machine, consult a qualified electrician before use.

### How to connect an alternative plug

The wires in this mains lead are coloured in accordance with the following code:

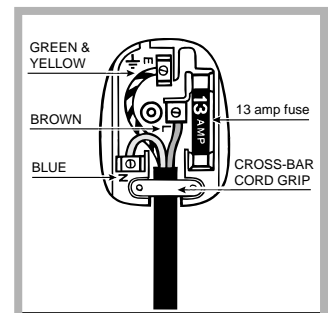

BLUE "NEUTRAL" (N)  
 BROWN "LIVE" (L)  
 GREEN AND YELLOW "EARTH" (E)



### Disposing of the appliance

When disposing of the appliance please remove the plug by cutting the mains cable as close as possible to the plug body and dispose of it as described above.

**! The plug and socket must be easily accessible.**

DATA PLATE	
<b>Dimensions</b>	width cm 43.5 height cm 32 depth cm 40
<b>Volume</b>	lt. 56
<b>Electrical connections</b>	voltage: 230-240V ~ 50Hz maximum power absorbed 2250W -2400W
<b>ENERGY LABEL</b>	Directive 2002/40/EC on the label of electric ovens. Standard EN 50304  Energy consumption for Natural convection – heating mode:  Convection mode  Declared energy consumption for Forced convection Class – heating mode:  Multi-cooking
	This appliance conforms to the following European Economic Community directives: 73/23/EEC of 19/02/73 (Low Voltage) and subsequent amendments; -89/336/EEC of 03/05/89 (Electromagnetic Compatibility) and subsequent amendments; 93/68/EEC of 22/07/93 and subsequent amendments.

# Description of the appliance

GB

## Overall view

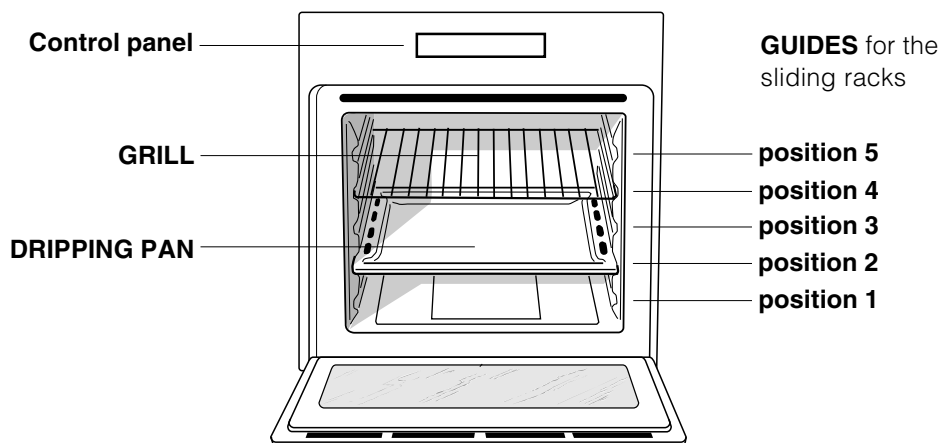

## Control panel

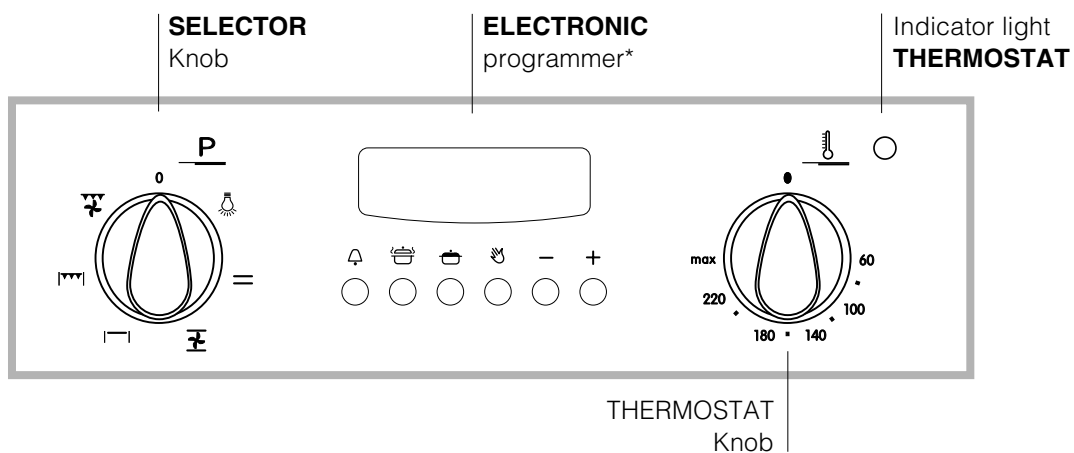



\* Only on certain models

! The first time you use your appliance, heat the empty oven with its door closed at its maximum temperature for at least half an hour. Ensure that the room is well ventilated before switching the oven off and opening the oven door. The appliance may produce a slightly unpleasant odour caused by the burning away of protective substances used during the manufacturing process.

## Starting the oven

1. Select the desired cooking mode by turning the SELECTOR knob.
2. Select the desired temperature with the THERMOSTAT knob. See the Cooking advice table for cooking modes and the suggested cooking temperatures (*see Cooking Modes*).
3. When preheating is finished, the THERMOSTAT indicator light will stay on: place the food in the oven.
4. You may do the following during cooking:
  - change the cooking mode by turning the SELECTOR knob.
  - change the temperature by turning the THERMOSTAT knob.
  - stop cooking by turning the SELECTOR knob to the "0" position.

! Should the appliance be equipped with an electronic programmer, to use the electric oven, just press button  (the symbol  will appear on the display) before selecting the desired cooking function.

! Never put objects directly on the oven bottom to avoid damaging the enamel coating.

! Always place cookware on the rack(s) provided.

## Cooling ventilation

In order to cool down the external temperature of the oven, some models are fitted with a cooling fan that blows out air between the control panel and the oven door.

! Once the cooking has been completed, the cooling fan remains on until the oven has cooled down sufficiently.

## Oven light

It goes on when selecting  with the SELECTOR knob. It stays on when a cooking mode is selected.

\* Only on certain models

# Cooking modes

GB

## Cooking modes

! A temperature value can be set for all cooking modes between 60°C and Max, except for

- GRILL (recommended: set only to MAX power level);
- GRATIN (recommended: do not exceed 200°C).

### **TRADITIONAL OVEN** mode

Both the top and bottom heating elements will come on. With this traditional cooking mode, it is best to use one cooking rack only; if more than one rack is used, the heat will be distributed unevenly.

### **MULTI-COOKING** mode

All the heating elements (top and bottom), as well as the fan, will come on. Since the heat remains constant throughout the oven, the air cooks and browns food uniformly. A maximum of two racks may be used at the same time.

### **TOP OVEN** mode

The top heating element comes on. This mode can be used to brown food at the end of cooking.

### **GRILL** mode

The top heating element comes on. The extremely high and direct temperature of the grill makes it possible to brown the surface of meats and roasts while locking in the juices to keep them tender. The grill is also highly recommended for dishes that require a high temperature on the surface: such as beef steaks, veal, rib steak, filets, hamburgers etc... Some grilling examples are included in the "Practical Cooking Advice" paragraph. Always cook in this mode with the oven door partially open.

### **GRATIN** mode

The top heating element, as well as the fan, will come on. This combination of features increases the effectiveness of the unidirectional thermal radiation of the heating elements through forced circulation of the air throughout the oven. This helps prevent food from burning on the surface, allowing the heat to penetrate right into the food. Always cook in this mode with the oven door closed.

## Practical cooking advice

! Do not place racks in position 1 and 5 during fan-assisted cooking. Excessive direct heat can burn temperature sensitive foods.

! In the GRILL and GRATIN cooking modes, place the dripping pan in position 1 to collect cooking residues (fat and/or grease).

### MULTI-COOKING

- Use position 2 and 4, placing the food that requires more heat on 2.
- Place the dripping pan on the bottom and the rack on top.

### GRILL

- Insert the rack in position 3 or 4. Place the food in the centre of the rack.
- We recommend that you set the maximum power level. The top heating element is regulated by a thermostat and may not always be on.

### PIZZA

- For best results when cooking pizza, use the MULTI-COOKING mode.
- Use a light aluminium pizza pan. Place it on the rack provided.  
For a crispy crust, do not use the dripping pan (prevents crust from forming by extending cooking time).
- If the pizza has a lot of toppings, we recommend adding the mozzarella cheese on top of the pizza halfway through the cooking process.

**Cooking advice table**

Cooking modes	Foods	Weight (in kg)	Rack position	Pre-heating time (min)	Recommended temperature	Cooking time (minutes)
<b>Convection Oven</b>	Duck	1	3	15	200	65-75
	Roast veal or beef	1	3	15	200	70-75
	Pork roast	1	3	15	200	70-80
	Biscuits (short pastry)	-	3	15	180	15-20
	Tarts	1	3	15	180	30-35
<b>Multi-cooking</b>	Pizza (on 2 racks)	1	2 and 4	15	230	15-20
	Lasagne	1	3	10	180	30-35
	Lamb	1	2	10	180	40-45
	Roast chicken + potatoes	1+1	2 and 4	15	200	60-70
	Mackerel	1	2	10	180	30-35
	Plum cake	1	2	10	170	40-50
	Cream puffs (on 2 racks)	0.5	2 and 4	10	190	20-25
	Biscuits (on 2 racks)	0.5	2 and 4	10	180	10-15
	Sponge cake (on 1 rack)	0.5	2	10	170	15-20
	Sponge cake (on 2 racks)	1	2 and 4	10	170	20-25
Savoury pies	1.5	3	15	200	25-30	
<b>Top oven</b>	Browning food to perfect cooking	-	3/4	15	220	-
<b>Grill</b>	Soles and cuttlefish	1	4	5	Max	8-10
	Squid and prawn kebabs	1	4	5	Max	6-8
	Cod filet	1	4	5	Max	10
	Grilled vegetables	1	3 or 4	5	Max	10-15
	Veal steak	1	4	5	Max	15-20
	Cutlets	1	4	5	Max	15-20
	Hamburgers	1	4	5	Max	7-10
	Mackerels	1	4	5	Max	15-20
	Toasts	4	4	5	Max	2-3
<b>Gratin</b>	Grilled chicken	1.5	2	5	200	55-60
	Cuttlefish	1.5	2	5	200	30-35

# The electronic cooking programmer

GB

This feature allows you to program the oven or the grill as follows:

- delayed cooking time for a specified period;
- immediate start for a specified period;
- timer.

## Button Functions:

 : Timer with hours and minutes;

 : cooking time;

 : end cooking time;





 : Manual change;

 : set cooking time (to count down);

 : set cooking time (to start from zero)

## How to reset the digital clock



After the appliance has been connected to the power supply, or after a power cut, the clock display will automatically reset to **0:00** and begin to blink.

- Press the  and  buttons consecutively and then reset the time (within 4 seconds) using the  and  buttons.

The button  advances the hours.

The button  decreases the hours.

The time can also be changed in the following two ways:

1. Repeat all of the steps above.
2. Press the  button, and then use the  and  buttons to reset the time.



## Manual operation of the oven

Once the time has been set, the programmer automatically switches to manual mode.

Note: Press the  button to restore the manual mode after every “Automatic” cooking session.



## Delayed cooking time for a specified period

The total cooking time as well as the time at which the cooking will finish must be set. If we assume that the time display reads 10:00:

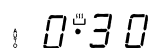
1. Turn the oven control knob to the setting and temperature desired (example: static oven mode at 200°C).
2. Press the button  and then set the cooking time (within four seconds) using the  and  buttons. Supposing the cooking time is set to 30 minutes, the display will read as follows:





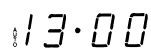

Release the button, and within 4 seconds, the current time will reappear with the  symbol along with the word “auto”

3. Press the button  and then use the  and  buttons to set the time for when the cooking program should end. Let us imagine this time to be 1:00 p.m.



4. After the button has been released, the current time will be displayed after approximately 4 seconds:





When “auto” is on, it indicates that the length of cooking time and the time it is due to finish have been programmed in automatic mode. At this point, the oven will turn on automatically at 12:30 and turn off after 30 minutes. When the oven is turned on, the symbol  will be displayed for the entire cooking time. The cooking duration can be displayed at any time by pressing the button , and the time it is due to finish may be displayed by pressing the button . Once cooking is completed, the timer will ring; to turn it off, simply press any button except the  and  buttons.

## Immediate start for a specified period

By programming just the duration (points 1 and 2 of the “Delayed cooking time for specified period” section), cooking will begin immediately.

## To cancel a cooking schedule already programmed

Press the  button, and use the  button to set the time to:

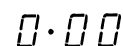



then press the manual cooking mode button .

## Timer Feature

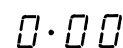

The timer feature allows you to enter a specific amount of time and begins to count down. This feature does not turn the oven on or off; it merely sounds when the time has elapsed.

When the button  has been pressed, the display will read as follows:



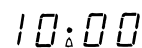

Then use the  and  buttons to set the desired time. As soon as the button has been released, the timer will start to count down and the current time will be displayed.



After the time has expired, an audible signal will be emitted, which can be turned off by pressing any button (except the  and  buttons). At this point the symbol  will also turn off.

## Correction/Cancellation of data

- The data entered can be changed at any time by pressing the corresponding button and the  or  buttons.
- When the data for the cooking duration is cancelled, the data for the time cooking is due to end is also cancelled automatically, and vice versa.
- If the oven has already been programmed, it will not accept times for the end of cooking which are before the start of the programmed cooking process.



! The appliance was designed and manufactured in compliance with international safety standards. The following warnings are provided for safety reasons and must be read carefully.

## General safety

- The appliance was designed for domestic use inside the home and is not intended for commercial or industrial use.
- The appliance must not be installed outdoors, even in covered areas. It is extremely dangerous to leave the appliance exposed to rain and storms.
- When handling the appliance, always use the handles provided on the sides of the oven.
- Do not touch the appliance with bare feet or with wet or moist hands and feet.
- The appliance must be used to cook food by adults only and according to the instructions in this manual.
- **When the appliance is in use, the heating elements and some parts of the oven door become extremely hot. Make sure you don't touch them and keep children well away.**
- Ensure that the power supply cable of other electrical appliances does not come into contact with the hot parts of the oven.
- The openings used for ventilation and dispersion of heat must never be covered.
- Always grip the oven door handle in the centre: the ends may be hot.
- Always use oven gloves to place cookware in the oven or when removing it.
- Do not use aluminium foil to line the bottom of the oven.
- Do not place flammable materials in the oven: if the appliance is switched on by mistake, it could catch fire.
- Always make sure the knobs are in the “●”/“○” position when the appliance is not in use.

- When unplugging the appliance always pull the plug from the mains socket, do not pull on the cable.
- Never carry out any cleaning or maintenance work without having unplugged the plug from the mains.
- In the case of a malfunction, under no circumstances should you attempt to repair the appliance yourself. Repairs carried out by inexperienced persons may cause injury or further malfunctioning of the appliance. Contact a Service Centre (*see Assistance*).
- Do not rest heavy objects on the open oven door.

## Disposal

- Observe local environmental standards when disposing packaging material for recycling purposes. Observe existing legislation when disposing of the old appliance.
- Contact your Local Organisation in charge of waste disposal.
- Make the appliance unusable by cutting off the electrical cable before disposal.

## Respecting and conserving the environment

- By using the appliance in the hours between late afternoon and early morning, you can help reduce the work load placed on electrical companies.
- Regularly check the door seals and wipe clean to ensure they are free of debris so that they stick properly to the door and do not allow heat to disperse.

# Maintenance and care

GB

## Switching the appliance off

Disconnect your appliance from the electricity supply before carrying out any work on it.

## Cleaning the appliance

- The stainless-steel or enamel-coated external parts as well as the rubber seals may be cleaned using a sponge that has been soaked in lukewarm water and neutral soap. If these stains are difficult to remove, use only specialised products. After cleaning, rinse and dry thoroughly. Do not use abrasive powders or corrosive substances.
- Ideally, the inside of the oven should be cleaned after each use, when it is still lukewarm. Use hot water and detergent, rinse and dry with a soft cloth. Do not use abrasive products.
- The accessories can be washed like everyday crockery (even in your dishwasher).

## Cleaning the oven door

Clean the glass door using non-abrasive products and sponges and dry it with a soft cloth.

To clean more thoroughly, you can remove the oven door.

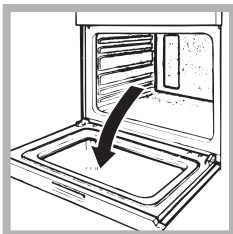

1. Open the oven door fully (*see diagram*)



2. Lift up and turn the small levers located on the two hinges (*see diagram*)

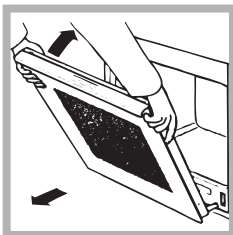

3. Grip the door on the two external sides and close it approximately half way. Then pull the door towards you lifting it out of its seat (*see diagram*). To replace the door, reverse this sequence.

## Inspecting the seals

Check the door seals around the oven periodically. If the seals are damaged, please contact your nearest After-sales Service Centre (*see Assistance*). We recommend not using the oven until the seals have been replaced.

## Replacing the light bulb

To replace the oven light bulb:

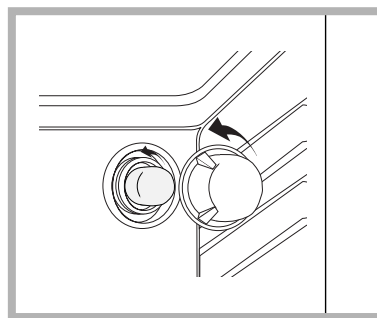

1. Remove the glass cover of the lamp-holder.
2. Remove the light bulb and replace it with a similar one: Wattage 25 W, cap E 14.
3. Replace the glass cover (*see diagram*).

## Assistance

### Communicating:

- appliance model (Mod.)
- serial number (S/N)

This information is found on the data plate located on the appliance and/or on the packaging.





## Free Manuals Download Website

<http://myh66.com>

<http://usermanuals.us>

<http://www.somanuals.com>

<http://www.4manuals.cc>

<http://www.manual-lib.com>

<http://www.404manual.com>

<http://www.luxmanual.com>

<http://aubethermostatmanual.com>

Golf course search by state

<http://golfingnear.com>

Email search by domain

<http://emailbydomain.com>

Auto manuals search

<http://auto.somanuals.com>

TV manuals search

<http://tv.somanuals.com>