

# Cooker with electric ventilated oven

Instructions for installation and use

**K 645 V.C/G**

**K 645R V.C/G**

**K 647R V.C/G**



**GB** **Cooker with electric ventilated oven**  
Instructions for installation and use

# Important safety warnings

To maintain the **EFFICIENCY** and **SAFETY** of this appliance, we recommend:

- use only the **MANUFACTURER Service**
- use only **ORIGINAL Spare Parts**

- 1 This owner's manual is for a class 1 appliance (installed independently) or class 2 - sub-class 1 appliances (installed between two cabinets).**
- 2 Before using the appliance, read the instructions in this owner's manual carefully since you should find all the instruction you require to ensure safe installation, use and maintenance.**  
**Always keep this owner's manual close to hand since you may need to refer to it in the future.**
- 3** When you have removed the packing, check that the appliance is not damaged. If you have any doubts, do not use the appliance, contact your nearest Ariston Service Centre. Never leave the packing components (plastic bags, foamed polystyrene, nails, etc.) within the reach of children since they are a source of potential danger.
- 4** The appliance must be installed only by a qualified person in compliance with the instructions provided. The manufacturer declines all responsibility for improper installation which may harm persons and animals and damage property.
- 5** The electrical safety of this appliance can only be guaranteed if the cooker is correctly and efficiently earthed, in compliance with current regulations on electrical safety. Always ensure that the earthing is efficient; if you have any doubts call in a qualified electrician to check the system. The manufacturer declines all responsibility for damage resulting from a system which has not been earthed.
- 6** Before connecting the appliance to the mains, check that the specifications indicated on the rating plate correspond to those of the electrical mains system of your home.
- 7** The cooker must be connected to the mains electrical supply via a earthed 13 or 15 amp. socket outlet, meeting the electrical current requirements detailed under "electrical Connection" in the installation section later in this book.
- 8** The openings and slots used for ventilation and dispersion of heat on the rear and below the control panel must never be covered.
- 9** This appliance must be used for the purpose for which it was expressly designed. Any other use (e.g. heating rooms) is considered to be improper and consequently dangerous. The manufacturer declines all responsibility for damage resulting from improper and irresponsible use.
- 10** A number of fundamental rules must be followed when using electrical appliances. The following are of particular importance:
  - do not touch the appliance when your hands or feet are wet
  - do not use the appliance barefooted
  - never allow the Mains Cable to be stretched, pulled or damaged if the Cooker is moved for cleaning etc. Do not use the cooker if the Mains Cable is damaged, consult a qualified electrician.
  - do not allow the cooker to be used unsupervised by children or persons unfamiliar with it.
- 11** Always switch off the electrical supply to the cooker and allow it to cool down before carrying out any cleaning operations etc.
- 12** In the case of faults and/or faulty operation, switch off the electricity supply to the cooker and do not tamper with it. For repairs call only an authorised after-sales servicing centre and request the use of original spare parts only. Failure to comply with the above may compromise the safety of the appliance.
- 13** Remember if you are discarding any domestic appliance with which children etc. may play, make it safe by removing the Mains Cable from it, after first disconnecting the electricity supply. Remove glass parts where possible, and consider sharp edges etc. which may now be exposed.
- 14** Oven gloves or similar protection should be used when moving containers in or out of hot ovens and care should be taken to avoid contact with hot surfaces by exposed skin on wrists or arms.
- 15** One of the commonest types of accident involving cooking appliances is burns to babies and young children. These can occur by:
  - a)** Touching hot parts
  - b)** Being splashed with hot liquids
  - c)** By pulling projecting pan handles and tipping hot liquids over themselves
- 16** Please remember that a small child's skin is far more sensitive and therefore easily burnt. You are, therefore, strongly advised to keep babies and young children well clear of this appliance during use and whilst it is cooling down after use.
- 17** Unstable or out of shape pans should not be used on the hob in case they cause spillage of hot liquids by tipping over.
- 18** Pans must only be placed in the centre of the burners. Placing pans off centre may cause cooking irregularities.
- 19** Special care should be taken when using chip pans etc. in order to avoid splashing or spillage of hot oil. They should not be used unattended since overheated oil may boil over and could also ignite.
- 20** Parts of this appliance, cooking surfaces, retain heat for considerable periods after switching off. Care should, therefore, be taken when touching these areas before they have completely cooled down.
- 21 Remember to keep children away from the appliance when you use the grill or oven, since these parts become very hot.**
- 22** Never use flammable liquids such as alcohol or gasoline, etc. near the appliance when it is in use.
- 23** Wear oven gloves when placing cookware in the oven or removing it.
- 24** Never use the oven as place to store flammable material.
- 25** When using small electric appliances near the hob, keep the supply cord away from the hot parts.
- 26** Make sure the knobs are in the "•"/"o" position when the appliance is not in use.
- 27 Warning:** open the door with care since if you are not careful you may hurt yourself in the hinge area.
- 28 Gas units need a regular air replacement for a correct functioning. Make sure that the requirements requested in the "Positioning" paragraph are all observed in the owner's manual.**
- 29** If the cooker is placed on a pedestal, take the necessary precautions to prevent the same from sliding off the pedestal itself.

# Installation

The following instructions should be read by a qualified technician to ensure that the appliance is installed, regulated and technically serviced correctly in compliance with current regulations.

**Important: remember to unplug the appliance from the mains before regulating the appliance or carrying out any maintenance work.**

## Positioning

**Important:** this unit may be installed and used only in permanently ventilated rooms according to the British Standards Codes Of Practice: B.S. 6172/B.S. 5440, Par.2 and B.S. 6891 Current Editions. The following requirements must be observed:

- The cooker should not be installed in a bed sitting room with a volume of less than 20m<sup>3</sup>. If it is installed in a room of volume less than 5m<sup>3</sup> an air vent of effective area of 110cm<sup>2</sup> is required, if it is installed in a room of volume between 5m<sup>3</sup> and 10m<sup>3</sup> a supplementary airvent area of 50cm<sup>2</sup> is required, if the volume exceeds 11m<sup>3</sup> no airvent is required. However, if the room has a door or a window which opens directly to the outside no air vent is required even when the volume is between 5m<sup>3</sup> and 11m<sup>3</sup>.
- During prolonged use of the appliance you may consider it necessary to open a window to the outside to improve ventilation.
- If there are other fuel burning appliances in the same room, B.S.5440 Part 2 Current Edition, should, be consulted to determine the requisite air vent requirements.

## Levelling your appliance (only on a few models)

Your cooker is supplied with feet for levelling the appliance. If necessary, these feet can be screwed into the housings in the corners of the cooker base.

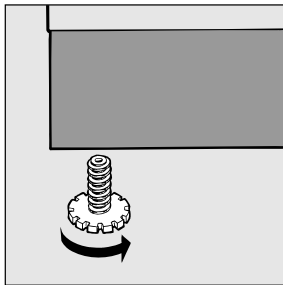

## Mounting the legs (only on a few models)

Press-fit legs are supplied which fit under the base of your cooker.

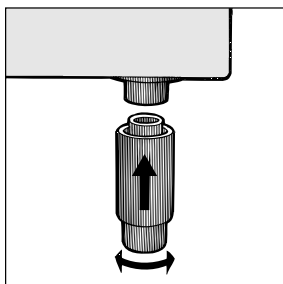

## Installation of the cooker

The appliance can therefore be installed next to cabinets, provided the height does not exceed that of the hob. If the cooker is placed touching walls or sides of neighbouring cabinets, these must be capable of withstanding a temperature rise of 50°C above room temperature. For a correct installation of the cooker the following precautions must be followed:

- The cooker may be located in a kitchen, a kitchen/diner or bed sitting room, but not in a bathroom or shower room.
- The furniture units next to the cooker, that is higher than the working boards, must be placed at least 110mm from the edge of the board. Curtains must not be fitted immediately behind the cooker or within 110 mm. of the sides of the cooker.
- The hoods must be installed according to the requirements in the hood handbook.
- Wall cabinets may be fitted in line with the sides of the base units, providing that the lower edge of the wall cabinet is a minimum of 420 mm. above the worktop. The minimum distance combustible material kitchen units can be fitted directly above the worktop is 700 mm (Fig. A).
- The wall in contact with the back of the cooker must be of flameproof material.
- The cooker is fitted with a safety chain that must be attached to a hook, secured to the wall behind the appliance.

**Note:** some models can have their gas connection inverted. It is important to make sure the safety chain is always situated on the side which corresponds to the hose holder (Fig. B).

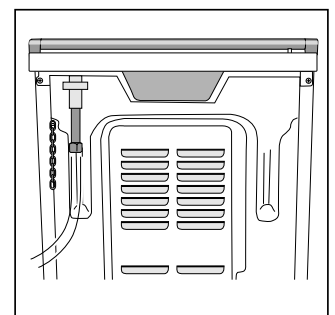
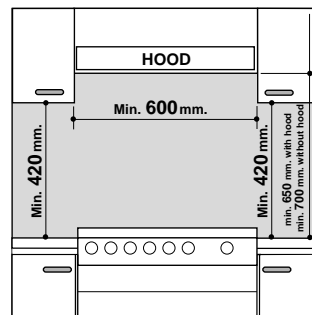
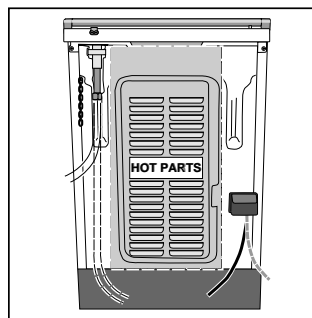

Fig. A

Fig. B

## Gas connection

The cooker should be connected to the gas-supply by a corgi registered installer. During installation of this product it is essential to fit an approved gas tap to isolate the supply from the appliance for the convenience of any subsequent removal or servicing. Connection of the appliance to the gas mains or liquid gas must be carried out according to the prescribed regulation in force, and only after it is ascertained that it is adaptable to the type of gas to be used. If not, follow the instructions indicated in the paragraph headed "Adaptation to different gas types". In the case of connection to liquid gas, by tank, use pressure regulators that conform to the regulation in force. The gas supply must be connected to the left of the appliance. Be sure that the hose does not pass through the rear of the cooker touching hot parts.



**Important:** make sure the supply pressure conforms with the values shown in the table entitled "Characteristics of the burners and nozzles". **When the cooker is installed between cabinets (recessed), the gas connection must be effected by an approved flexible hose with bayonet fitting (BS 669 Current Edition). The gas**

**inlet for the cookers is a threaded G 1/2 gas female fitting.**

### Connecting the gas supply

To make the connection, a flexible hose should be used corresponding to the current gas regulations which are:

- the hose must never be at any point in its length in contact with the "hot" parts of the cooker;
- the hose must never be longer than 1,5 metre;
- the hose must not be subject to any tension or torsional stress and it must not have any excessively narrow curves or bottlenecks;
- the hose must be easy to inspect along its entire length to check its condition;
- the hose must always be in good condition, never attempt to repair.

**Important:** the installation must comply with gas safety (installation and use) regulations 1984. In all cases for the above, by law, a qualified, corgi approved engineer must be called for installation.

### Electrical connection

Power supply voltage and frequency: 230-240V a.c. 50 Hz.

**Note:** the supply cable must be positioned so that it never reaches at any point a temperature 50°C higher than the room temperature. The cable must be routed away from the rear vents. Should you require it, you may use a longer cable, however, you must ensure that the cable supplied with the appliance is replaced by one of the same specifications in accordance with current standards and legislation.

Your appliance is supplied with a 13 amp fused plug that can be plugged into a 13 amp socket for immediate use. Before using the appliance please read the instructions below.

**WARNING - THIS APPLIANCE MUST BE EARTHED.**

**THE FOLLOWING OPERATIONS SHOULD BE CARRIED OUT BY A QUALIFIED ELECTRICIAN.**

### Replacing the fuse:

When replacing a faulty fuse, a 13 amp ASTA approved fuse to BS 1362 should always be used, and the fuse cover re-fitted. If the fuse cover is lost, the plug must not be used until a replacement is obtained.

### Replacement fuse covers:

If a replacement fuse cover is fitted, it must be of the correct colour as indicated by the coloured marking or the colour that is embossed in words on the base of the plug. Replacements can be obtained directly from your nearest Service Depot.

### Removing the plug:

If your appliance has a non-rewireable moulded plug and you should wish to remove it to add a cable extension or to re-route the mains cable through partitions, units etc., please ensure that either:

- the plug is replaced by a fused 13 amp re-wireable plug bearing the BSI mark of approval.
- or:
- the mains cable is wired directly into a 13 amp cable outlet, controlled by a switch, (in compliance with BS 5733) which is accessible without moving the appliance.

**Please note:** for appliances with a rating greater than 13 amp (eg: electric hob, double ovens and freestanding electric cookers etc.) the mains cable must be wired into a cooker output point with a rating of 45 amp. In this case the cable is not supplied.

### Disposing of the plug:

Ensure that before disposing of the plug itself, you make the pins unusable so that it cannot be accidentally inserted into a socket. Instructions for connecting cable to an alternative plug:

**Important:** the wires in the mains lead are coloured in accordance with the following code:

Green & Yellow	- Earth
Blue	- Neutral
Brown	- Live

If the colours of the wires in the mains lead do not correspond with the coloured markings identifying the terminals in your plug, proceed as follows:

Connect Green & Yellow wire to terminal marked "E" or  $\frac{\perp}{\perp}$  or coloured Green or Green & Yellow.

Connect Brown wire to terminal marked "L" or coloured Red.

Connect Blue wire to terminal marked "N" or coloured Black.

If a 13 amp plug (BS 1363) is used it must be fitted with a 13 amp fuse. A 15 amp plug must be protected by a 15 amp fuse, either in the plug or adaptor or at the distribution board. If you are in any doubt about the electrical supply to your machine, consult a qualified electrician before use.

### How to connect an alternative plug:

The wires in this mains lead are coloured in accordance with the following code:

<b>BLUE</b>	"NEUTRAL" ("N")
<b>BROWN</b>	"LIVE" ("L")
<b>GREEN AND YELLOW</b>	"EARTH" ("E")

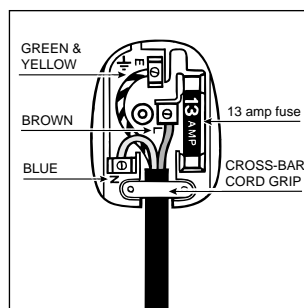

### Disposing of the appliance

When disposing of the appliance please remove the plug by cutting the mains cable as close as possible to the plug body and dispose of it as described above.

### Adapting the cooker to different types of gas

In order to adapt the cooker to a different type of gas with respect to the gas for which it was produced (indicated on the label attached to the lid), follow these steps:

- a) replace the hose holder mounted on the appliance with that supplied in the bag of "cooker accessories".

**Important:** the hose holder for liquid gas is marked 8, the hose holder for methane gas is marked 13. Always fit the sealing gasket.

- b) Replacing the burner nozzles on the hob:
  - remove the grids and slide the burners from their housings;
  - unscrew the nozzles using a 7 mm socket spanner, and replace them with nozzles for the new type of gas (see table 1 "Burner and nozzle characteristics").
  - replace all the components by repeating the steps in reverse order.

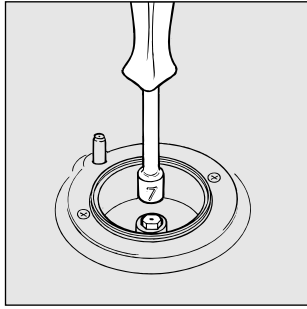

**c) Minimum regulation of the hob burners:**

- turn the tap to minimum;
- remove the knob and adjust the regulation screw, which is positioned in or next to the tap pin, until the flame is small but steady.

**N.B.:** in the case of liquid gas, the regulation screw must be screwed in to the bottom.

- check that the flame does not turn off when you turn the tap quickly from high to low.

**d) Regulating the primary air of the burners:**

The primary air of the burners requires no regulation.

**Important**

On completion of the operation, replace the old rating sticker with one indicating the new type of gas used. This sticker is available from our Service Centres.

**Note**

Should the pressure of the gas used be different (or vary) from the recommended pressure, it is necessary to fit a suitable pressure regulator onto the inlet pipe in compliance with current National Regulations relative to "regulators for channelled gas".

**Raised border assembly (only on a few models)**

To assemble the raised border correctly, please follow the instructions below:

- Unscrew the 4 screws and the 2 spacers on the rear part of the worktop;
- Place the raised border on the rear part of the worktop;
- Screw the raised border onto the worktop using the four screws you previously removed, ensuring that you reposition the spacers on the outermost screws.

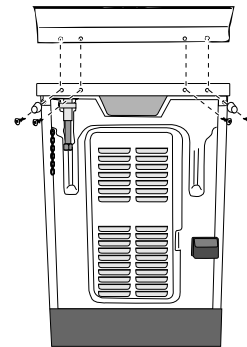

# Burner and nozzle characteristics

**Table 1**

Burner	Diameter (mm)	Thermal Power kW (p.c.s.*)		Liquid Gas				Natural Gas	
				By-Pass 1/100 (mm)	Nozzle 1/100 (mm)	Flow* g/h		Nozzle 1/100 (mm)	Flow* l/h
						***	**		
Fast (Large)(R)	100	Nominal 3.00	Reduced 0.7	41	86	218	214	116	286
Semi Fast (Medium)(S)	75	1.90	0.4	30	70	138	136	106	181
Auxiliary (Small)(A)	55	1.00	0.4	30	50	73	71	79	95
Triple Crown (TC)	130	3.25	1.5	63	91	236	232	133	309
Supply Pressures	Nominal (mbar)					28-30	37	20	
	Minimum (mbar)					20	25	17	
	Maximum (mbar)					35	45	25	

- \* At 15°C and 1013 mbar- dry gas
- \*\* Propane P.C.S. = 50,37 MJ/Kg
- \*\*\* Butane P.C.S. = 49,47 MJ/Kg
- Natural P.C.S. = 37,78 MJ/m<sup>3</sup>

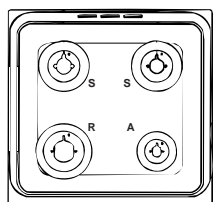

**K 645 V.C/G**  
**K 645R V.C/G**

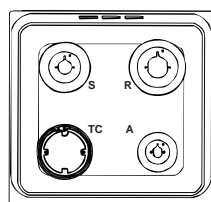

**K 647R V.C/G**

# Technical characteristics

## Mains frequency and voltage of the electric section and characteristics of the gas section

Model	Gas section		Electric section
	Class	Rated power kW (1)	Voltage
K 645 V.C/G K 645R V.C/G	II2H3+	7,80 (567 g/h - G30) (557 g/h - G31)	240V~ 50/60Hz 2200W
K 647R V.C/G	II2H3+	9,15 (665 g/h - G30) (653 g/h - G31)	240V~ 50/60Hz 2200W

(1) The values in g/h refer to the capacities with liquid gas (Butane, Propane).

### Inner dimensions of the oven:

Width: 40 cm  
Depth: 39 cm  
Height: 33 cm

### Inner Volume of the Oven:

52 lt

### Innder dimensions of the plate plate warmer:

Width: 43 cm  
Depth: 43 cm  
Height: 8 cm

### ENERGY LABEL

Directive 2002/40/EC on the label of electric ovens

Norm EN 50304

Declared energy consumption for Forced convection Class

heating mode: Fan assisted

### Voltage and Frequency of Power Supply:

see data plate

### Burners:

adaptable for use with all the types of gas indicated on the data plate



This appliance conforms with the following European Economic Community directives:

- 73/23/EEC of 19/02/73 (Low Voltage) and subsequent modifications;
- 89/336/EEC of 03/05/89 (Electromagnetic Compatibility) and subsequent modifications;
- 90/396/EEC of 29/06/90 (Gas) and subsequent modifications;
- 93/68/EEC of 22/07/93 and subsequent modifications.



# The cooker with electric ventilated oven

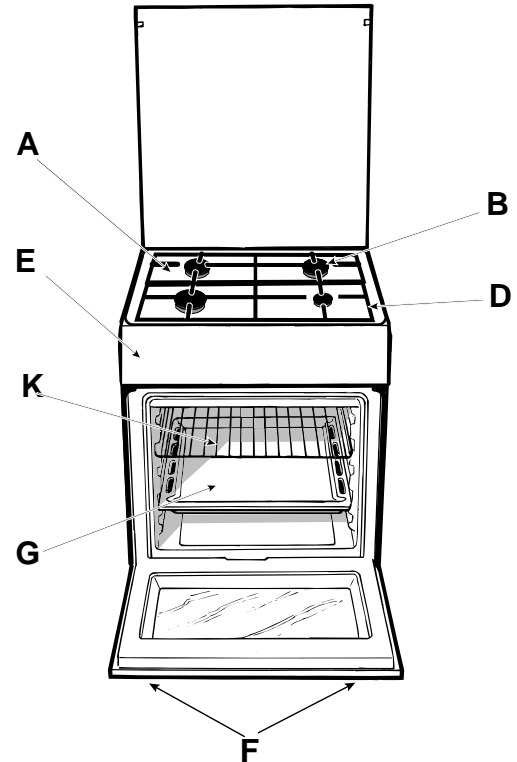
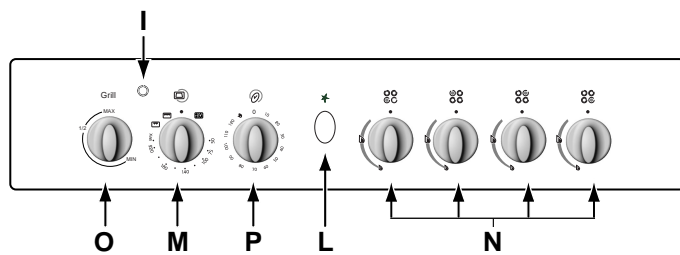
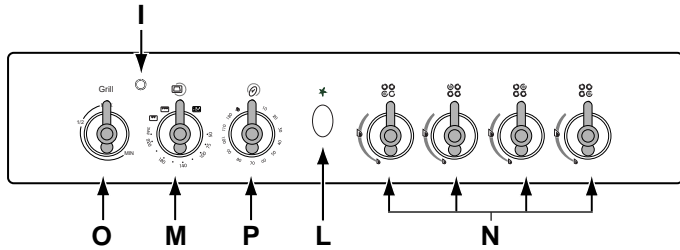
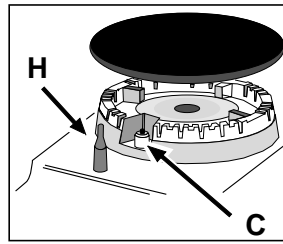

- A** Tray for Catching Overflows
- B** Gas Burner
- C** Instantaneous Electronic Lighting Device (only a few models)
- D** Top Grate
- E** Control Panel
- F** Adjustable Feet or Legs
- G** Dripping Pan or Baking Sheet
- H** Flame Failure Device for Cooktop Burners (only a few models)
- I** Thermostat Light
- K** Oven Rack
- L** Electronic Lighting for Hob Burners (only a few models)
- M** Oven Control Knob
- N** Control Knobs for Gas Burners on Hob
- O** Variable grill Knob
- P** Cooking Control Timer Knob (only a few models)

# The different functions and uses of the oven

The various functions included in the cooker are selected by operating the control devices located on the cooker control panel.

## Control Knobs for the Gas Burners on the Hob

The position of the gas burner controlled by each one of the knobs is shown by a symbol of a solid ring: ●. To light one of the burners, hold a lighted match or lighter near the burner. Press down and turn the corresponding knob in the counter-clockwise direction to the **maximum** ⤴ setting. Each burner can be operated at its maximum, minimum or intermediate power. Shown on the knob are the different symbols for off ● (the knob is on this setting when the symbol lines up with the reference mark on the control panel), for **maximum** ⤴ and **minimum** ⤵. To obtain these settings, turn the knob counter-clockwise with respect to the off position. To turn off the burner, turn the knob clockwise until it stops (corresponding again with the ● symbol).

## Electronic Lighting of the Hob Burners (only a few models)

Some models are equipped with instant electronic lighting of the gas burners located on the hob, which can be identified by the presence of an igniter device (see detail C). This device is activated by lighting pressing on the "L" button, identified by the ✨ symbol. To turn on a burner, simply press the "L" button and then press while, at the same time, pressing in and turning the control knob for the burner in the anticlockwise direction until the burner lights. **To light the burner immediately, it is recommended that the button be pressed first and then the knob turned.**

**Caution: If the burner accidentally goes out, turn off the burner using the knob and wait at least one minute before relighting.**

## Models with Flame Failure Device (only a few models)

These models are identified by the presence of a flame detection device (see detail H).

**Important:** Since the top burners are equipped with a safety device, after lighting the burner **keep the knob pressed in for about 6 seconds** to allow the gas to pass until the safety thermocouple is heated.

## Gas Cut Off (only a few models)

This cooker has a safety cut out feature which switches off the burners when you close the cover. This device is provided as a safety feature in case the cover is lowered with the burners on. Always turn off the gas and allow the burners to cool before closing the cover. Failure to follow these instructions may cause the glass cover to shatter. Keep the cover open when using the oven.

**Notice:** The first time you use your appliance, we recommend that you set the thermostat to the highest setting and leave the oven on for about half an hour with nothing in it, with the oven door shut. Then, open the oven door and let the room air. The odour that is often detected during this initial use is due to the evaporation of substances

used to protect the oven during storage and until it is installed.

**Attention:** Only use the bottom shelf of the oven when using the rotisserie to cook (where present). For all other types of cooking, never use the bottom shelf and never place anything on the bottom of the oven when it is in operation because this could damage the enamel. Always place your cookware (dishes, aluminium foil, etc. etc.) on the grate provided with the appliance inserted especially along the oven guides.

**Attention:** to use the oven in manual mode without the cooking control timer, match the indicator on the control panel with the ☺ symbol on the timer knob.

## Using the oven

When the oven control knob (M) is turned in a clockwise direction to the symbol ☺ the fan and oven light will come on to assist in the defrosting of frozen food. Rotating further to the complete range of temperatures shown on the dial you can choose which is most suitable for the food you are going to cook. The temperature is reached automatically and controlled by the oven thermostat (from 50°C to 240°C).

**Note:** Whilst using tag oven for conventional cooking knob (O) must be set with "MAX" in line with the reference mark on the control panel.

## Grill

The top centre heating element will come on and the rotisserie motor (if present) will be activated. On this setting, food is cooked by the thermal radiation given off in the downward direction by the electric heating element. The very high temperature and direct heat of the grill make it possible to brown meats on the surface while locking in the juices to keep them tender.

## Double Grill

Both of the top heating elements turn on and the rotisserie motor (if present) is activated.

This over-sized grill has a completely new design, which is the reason why cooking efficiency has increased by 50%. In addition, the double grill eliminates heat gaps in the corners of the oven.

**Important:** when using the grill, the oven door must be left partly open by positioning the deflector "D" between door and panel to prevent the cooker knobs from overheating.

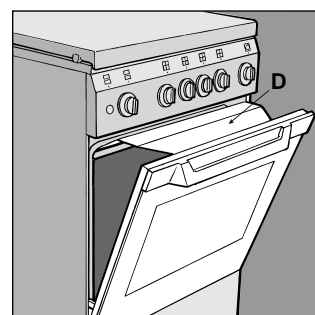



### Oven Light

The light comes on when the "M" knob is turned to the  setting. The light illuminates the oven and remains on when any of the heating elements is turned on.

### Thermostat Light (I)

This light indicates that the oven is heating. When it turns off, the temperature inside the oven has reached the setting made with the thermostat knob. At this point, the light will turn on and off as the oven maintains the temperature at a constant level.

### Cooking Control Timer Knob (only a few models)

Some models are equipped with a timer program to control when the oven shuts off during cooking. To use this feature, you must wind the "P" knob one full turn in the counter-clockwise direction ; Then, turn the knob in the clockwise direction , to set the time by matching up the indicator on the control panel with the number of minutes on the knob.

At the end of the programmed length of time, the timer will sound and automatically turn off the oven.

**Attention:** to use the oven in manual mode without the cooking control timer, match the indicator on the control panel with the  symbol on the timer knob. When the oven is not in use, the cooking control timer can be used like a normal timer.

### Practical advice for burner use

In order to get the maximum yield it is important to remember the following:

- Use appropriate cookware for each burner (see table) so as to avoid flames overshooting the edges.
- At boiling point turn the knob to minimum.
- Use cookware with lids.
- Always use cookware with flat bottoms.

Burner	∅ Cookware Diameter (cm)
Fast (R)	24 - 26
Semi Fast (S)	16 - 20
Auxiliary (A)	10 - 14
Triple Crown (TC)	24 - 26

**N.B.** On the models supplied with a reducer shelf, remember that this should be used only for the auxiliary burner when you use casserole dishes with a diameter under 12 cm.

## Cooking advice

When using the oven, only one rack or drip pan should be used at a time. The rack or pan should be inserted into the bottom or top guides depending on whether the food needs more heat from the top or bottom.

### Preheating

If the oven must be preheated (this is generally required for leavened foods), we recommend using the "conventional" oven feature which makes it possible to reach the temperature desired in a very short time. After the oven has been preheated, the red indicator light (I) will turn off. At this point, you can select the most suitable setting to cook the dish.

### Cooking Fish and Meat

Meat must weigh at least 1 Kg in order to prevent it from drying out. When cooking white meat, fowl and fish, use low temperature settings (150°C-175°C). For red meat that should be well done on the outside while tender and juicy in the inside, it is a good idea to start with a high temperature setting (200°C-220°C) for a short time, then turn the oven down afterwards. In general, the larger the roast, the lower the temperature setting. Place the meat on the centre of the rack and place the drip pan beneath it to catch the fat.

Make sure that the rack is inserted so that it is in the centre of the oven. If you would like to increase the amount of heat from below, use the low rack heights. For savory roasts (especially duck and wild game), dress the meat with lard or bacon on the top.

### Cooking Pastries

Always preheat the oven when cooking pastries. Do not open the door in order to prevent the pastry from dropping. The batter or dough should not be too liquidy so that the cooking time is not excessive. In general:

#### Pastry is too dry

Increase the temperature by 10°C and reduce the cooking time.

#### Pastry dropped

Use less liquid or lower the temperature by 10°C.

#### Pastry is too dark on top

Place it on a lower rack, lower the temperature, and increase the cooking time.

#### Cooked well on the inside but sticky on the outside

Use less liquid, lower the temperature, and increase the cooking time.



#### The pastry sticks to the pan

Grease the pan well and sprinkle it with a dusting of flour.

#### I used more than one level and they are not all at the same cooking point

Use a lower temperature setting. It is not necessary to remove the food from all the racks at the same time.

### Using the Grill

Grilling may be carried out with a two stage heating element situated in the top of the oven chamber. The centre, or the complete area of the grill can be selected by turning the oven control knob (M) in a clockwise direction to align the symbols ( for the centre,  for the complete area) with the mark on the control panel. The variable temperature control (O) is positioned to right of the oven knob. This knob will provide varying grill temperatures when rotated from "max" to "min" and may be adjusted to vary the level of heat at any time during the grilling operation.

#### To operate the grill

1. Turn the oven control knob (M) clockwise until the required grilling symbol is in line with the mark on the control panel. The element is now "on".
2. The variable grill control (O) can now be operated to select the required heat.

When utilizing the grill, place the rack at the lower levels (see cooking table). To catch grease or fat and prevent smoke, place a drip pan at the bottom rack level.

# Cooker routine maintenance and cleaning

**Before each operation, disconnect the cooker from the electricity.** To assure the long life of the cooker, it must be thoroughly cleaned frequently, keeping in mind that:

- **Do not use steam equipment to clean the appliance.**
- the enamelled parts and the self-cleaning panels are washed with warm water without using any abrasive powders or corrosive substances which could ruin them;
- the inside of the oven should be cleaned fairly often while it is still warm using warm water and detergent, followed by careful rinsing and drying;
- the flame spreaders should be washed frequently with hot water and detergent taking care to eliminate any scale;
- in cookers equipped with automatic lighting, the terminal part of the electronic instant lighting devices should be cleaned frequently and the gas outlet holes of the flame spreaders should be checked to make sure they are free of any obstructions;
- Stainless steel may become marked if it comes into contact with very hard water or harsh detergents (containing phosphorous) for long periods of time. After cleaning, it is advisable to rinse thoroughly and dry. It is also recommended to dry any water drops;
- On models with glass covers, the covers should be cleaned with hot water; the use of rough cloths or abrasives is to be avoided.

**N.B: avoid closing the cover while the gas burners are still warm. Remove any liquid from the lid before opening it.**

**Important:** periodically check the wear of the gas hose and substitute it if there are any defects; we recommended changing it every year.

## Replacing the oven lamp

- Unplug the oven from the mains;
- Remove the glass cover of the lamp-holder;
- Remove the lamp and replace with a lamp resistant to high temperatures (300°C) with the following characteristics::
  - Voltage 230V
  - Wattage 25W
  - Type E14

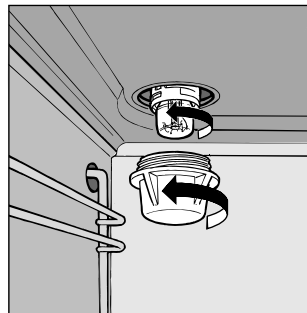

- Replace the glass cover and reconnect the oven to the mains.

## Greasing the Taps

The taps may jam in time or they may become difficult to turn. If so, the tap itself must be replaced.

**N.B.: This operation must be performed by a technician authorised by the manufacturer.**

## Practical advice for oven cooking

Food to be cooked	Wt. (wt)	Cooking position of shelves from	Temperature (°C)	Variable grill	Pre-heating time (min)	Cooking time (min.)
<b>Pasta</b>		<b>bottom</b>				
Lasagne	2.5	3	210		-	75-80
Cannelloni	2.5	3	210	MAX	-	75-80
Oven-baked noodles	2.5	3	210		-	75-80
<b>Meat</b>						
Veal	1.7	3	230		-	85-90
Chicken	1.5	3	220		-	110-115
Turkey	3.0	3	MAX	MAX	-	95-100
Duck	1.8	3	230		-	120/125
Rabbit	2	3	230		-	105/110
Pork	2.1	3	230		-	100/110
Lamb	1.8	3	230		-	90-95
<b>Fish</b>						
Mackerel	1.1	3	210-230		-	55-60
Dentex	1.5	3	210-230	MAX	-	60-65
Trout baked in paper	1.0	3	210-230		-	40-45
<b>Pizza</b>						
Napolitan	1.0	3	MAX	MAX	15	30-35
<b>Cake</b>						
Biscuits	0.5	3	180		15	30-35
Tarts	1.1	3	180	MAX	15	30-35
Chocolate cake	1	3	200		15	45-50
Raised Cakes	1	3	200		15	50/55
<b>Grill cooking</b>						
Toast	n.° 4	4				10
Pork chops	1.5	4		MAX-MIN		30
Mackerel	1.1	4				35

**Note:** cooking times are approximate and may vary according to personal taste.



# Merloni Elettrodomestici

Viale Aristide Merloni 47

60044 Fabriano

Italy

Tel +39 0732 6611

Fax +39 0732 662501

[www.merloni.com](http://www.merloni.com)

Cucina con forno elettrico ventilato variabile (Spec. GB)  
03/03 - 195038504.00 Xerox Business Services - Docutech



## Free Manuals Download Website

<http://myh66.com>

<http://usermanuals.us>

<http://www.somanuals.com>

<http://www.4manuals.cc>

<http://www.manual-lib.com>

<http://www.404manual.com>

<http://www.luxmanual.com>

<http://aubethermostatmanual.com>

Golf course search by state

<http://golfingnear.com>

Email search by domain

<http://emailbydomain.com>

Auto manuals search

<http://auto.somanuals.com>

TV manuals search

<http://tv.somanuals.com>