

GB

English, 1

K6C32/G

K6C320/G

Contents

Installation, 2-3

Positioning and levelling
Electrical connection
Technical data

Description of the appliance, 4

Overall view
Control panel

Start-up and use, 5

Starting the oven
Using the cooking timer

Cooking advice, 6-7

Oven cooking advice table

Using the glass ceramic hob, 8

Switching the cooking zones on and off
Cooking zones

Precautions and tips, 9

General safety
Disposal
Respecting and conserving the environment

Care and maintenance, 10

Switching the appliance off
Cleaning the appliance
Replacing the oven light bulb
Cleaning the glass ceramic hob
Assistance

Installation

GB

! Before operating your new appliance please read this instruction booklet carefully. It contains important information concerning the safe installation and operation of the appliance.

! Please keep these operating instructions for future reference. Make sure that the instructions are kept with the appliance if it is sold, given away or moved.

! The appliance must be installed by a qualified professional according to the instructions provided.

! Any necessary adjustment or maintenance must be performed after the appliance has been disconnected from the electricity supply.

Positioning and levelling

! It is possible to install the appliance alongside cupboards whose height does not exceed that of the hob surface.

! Make sure that the wall in contact with the back of the appliance is made from a non-flammable, heat-resistant material (T 90°C).

To install the appliance correctly:

- Place it in the kitchen, dining room or the bed-sit (not in the bathroom).
- If the top of the hob is higher than the cupboards, the appliance must be installed at least 200 mm away from them.

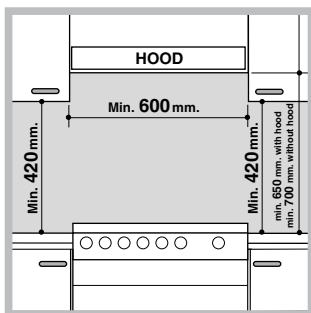

- If the cooker is installed underneath a wall cabinet, there must be a minimum distance of 420 mm between this cabinet and the top of the hob. This distance should be increased to 700 mm if the wall cabinets are flammable (see figure).

- Do not position blinds behind the cooker or less than 200 mm away from its sides.
- Any hoods must be installed according to the instructions listed in the relevant operating manual.

Levelling

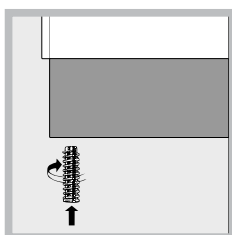

If it is necessary to level the appliance, screw the adjustable feet* into the places provided on each corner of the base of the cooker (see figure).

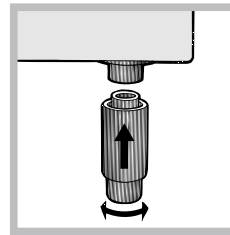

The legs* provided with the appliance fit into the slots on the underside of the base of the cooker.

Electrical connection

Electric cookers come without a power supply cable. The cooker is designed to operate on an electricity supply which conforms to the electrical data shown on the Rating Plate. The cooker can be connected to the mains only after removing the back panel of the cooker itself with a screwdriver.

! the following installation procedure must be carried out by a qualified electrician. The electrical installation must comply with the IEE Regulations, Building & local By-Lays.

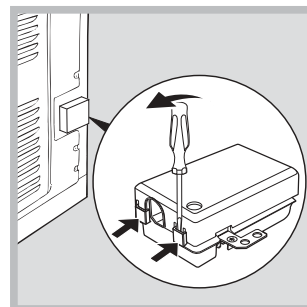

1. Open the terminal board by inserting a screwdriver into the side tabs of the cover. Use the screwdriver as a lever by pushing it down to open the cover (see diagram).

2. Loosen the cable clamp screw and remove it, using a screwdriver as a lever (see figure).

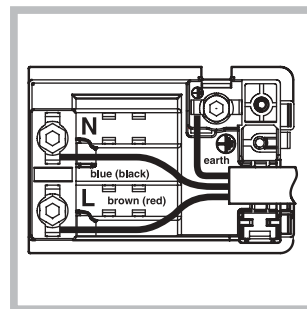

3. Remove the wire contact screws L-N- \perp , then fasten the wires under the screw heads, respecting the colour code: Black/Blue (N), Red/Brown (L) and Bare Wire/Yellow-Green (\perp).

- Once the connections have been made, tighten all the terminal screws fully.
- Fasten the supply cable in place with the clamp and close the cover of the terminal board.

* Only available in certain models.

Connecting the supply cable to the mains

WARNINGS: THIS APPLIANCE MUST BE EARTHED.

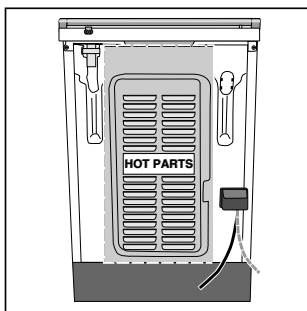

! The cooker must be connected to the mains by a switched (double pole) cooker outlet correctly fused with a capacity appropriate to that shown on the cooker Rating Plate. All electrical wiring from the consumer unit to the cooker, via the switched double pole cooker outlet, must be of an acceptable type and current rating as above.

! the supply cable must be positioned so that it never reaches at any point a temperature 50°C higher than the room temperature. The cable must be routed away from the rear vents.



Mains frequency and voltage of the electrical section

Model	Electric section	
	Voltage	Power (W)
K6C32/G K6C320/G	240V~ 50/60 Hz	8600

TECHNICAL DATA	
Oven dimensions (HxWxD)	32x43,5x40 cm
Volume	56 l
Useful measurements relating to the oven compartment	width 42 cm depth 44 cm height 8,5 cm
Power supply voltage and frequency	see data plate
Electric hob	
Front left	1700 W
Back left	1200 W
Back right	2100 W
Front right	1200 W
Maximum absorption of the electric hob	6200 W
ENERGY LABEL	<p>Directive 2002/40/EC on the label of electric ovens. Standard EN 50304</p> <p>Energy consumption for Natural convection – heating mode: Traditional mode;</p> <p>Declared energy consumption for Forced convection Class – heating mode: Fan assisted</p>
 	<p>EC Directives: 2006/95/ECC dated 12/12/06 (Low Voltage) and subsequent amendments - 89/336/EEC dated 03/05/89 (Electromagnetic Compatibility) and subsequent amendments - 93/68/EEC dated 22/07/93 and subsequent amendments - 2002/96/EC.</p>

Description of the appliance

Overall view

GB

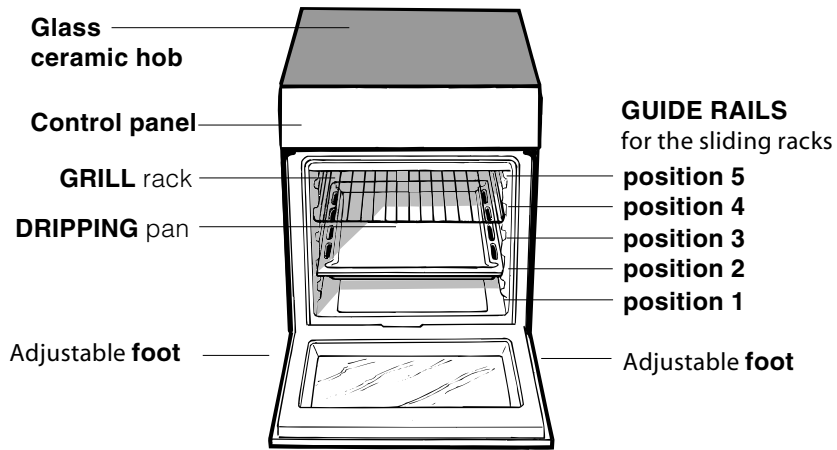

Control panel

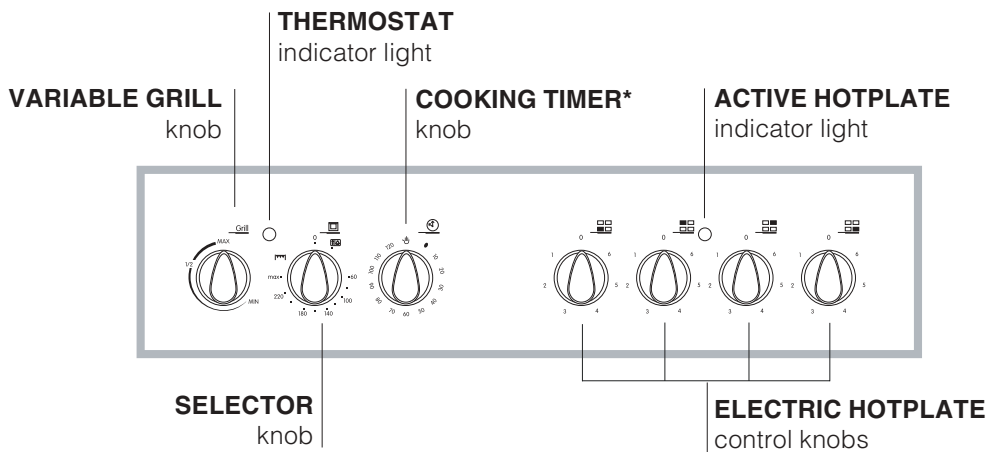

* Only on certain models

! The first time you use your appliance, heat the empty oven with its door closed at its maximum temperature for at least half an hour. Ensure that the room is well ventilated before switching the oven off and opening the oven door. The appliance may emit a slightly unpleasant odour caused by protective substances used during the manufacturing process burning away.

! Before operating the product, remove all plastic film from the sides of the appliance.

Starting the oven

When the SELECTOR knob is turned in a clockwise direction to the symbol  the fan and oven light will come on to assist in the defrosting of frozen food. Rotating further to the complete range of temperatures shown on the dial you can choose which is most suitable for the food you are going to cook (fan assisted mode). The temperature is reached automatically and controlled by the oven thermostat (from 60°C to 240°C).

! Whilst using tag oven for conventional cooking VARIABLE GRILL knob must be set with "MAX" in line with the reference mark on the control panel.

Grill

The top heating element will come on. On this setting, food is cooked by the thermal radiation given off in the downward direction by the electric heating element. The very high temperature and direct heat of the grill make it possible to brown meats on the surface while locking in the juices to keep them tender.

! Never put objects directly on the bottom of the oven; this will avoid the enamel coating being damaged. Only use position 1 in the oven when cooking with the rotisserie spit.

! Always place cookware on the rack(s) provided.

THERMOSTAT indicator light

When this is illuminated, the oven is generating heat. It switches off when the inside of the oven reaches the selected temperature. At this point the light illuminates and switches off alternately, indicating that the thermostat is working and is maintaining the temperature at a constant level.

Oven light

This is switched on by turning the SELECTOR knob to any position other than "0". It remains lit as long as the oven is operating. By selecting  with the knob, the light is switched on without any of the heating elements being activated.

Cooling ventilation*

In order to cool down the external temperature of the oven, some models are fitted with a cooling fan that blows out air between the control panel and the oven door.

! Once the cooking has been completed, the cooling fan remains on until the oven has cooled down sufficiently.

Using the cooking timer*

1. To set the buzzer, turn the COOKING TIMER knob clockwise almost one complete revolution.
2. Turn the knob anticlockwise to set the desired time: align the minutes shown on the COOKING TIMER knob with the indicator on the control panel.
3. When the selected time has elapsed, a buzzer sounds and the oven turns off.
4. When the oven is off the cooking timer can be used as a normal timer.

! To use the oven manually, in other words when you do not wish to use the end of cooking timer, turn the COOKING TIMER knob until it reaches the  symbol.

Using the grill pan kit

Position the handle on the grill pan so that it fits into the small recess (fig. 1), tilt it upwards and slide it towards the centre (fig. 2).

The food must be placed on the rack in the grill pan. Position the grill pan on top of the oven rack. The best results are achieved by placing the oven rack on the uppermost shelves. Pouring a little water into the grill pan will make the collection of grease particles more efficient and prevent the formation of smoke.

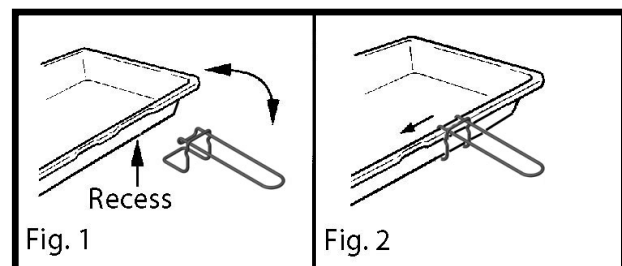

* Only on certain models

Cooking advice

GB

When using the oven, only one rack or drip pan should be used at a time. The rack or pan should be inserted into the bottom or top guides depending on whether the food needs more heat from the top or bottom.

Preheating

If the oven must be preheated (this is generally required for leavened foods), we recommend using the "conventional" oven feature which makes it possible to reach the temperature desired in a very short time. After the oven has been preheated, the thermostat light will turn off. At this point, you can select the most suitable setting to cook the dish.

Cooking Fish and Meat

Meat must weigh at least 1 Kg in order to prevent it from drying out. When cooking white meat, fowl and fish, use low temperature settings (150°C-175°C). For red meat that should be well done on the outside while tender and juicy in the inside, it is a good idea to start with a high temperature setting (200°C-220°C) for a short time, then turn the oven down afterwards. In general, the larger the roast, the lower the temperature setting. Place the meat on the centre of the rack and place the drip pan beneath it to catch the fat.

Make sure that the rack is inserted so that it is in the centre of the oven. If you would like to increase the amount of heat from below, use the low rack heights. For savory roasts (especially duck and wild game), dress the meat with lard or bacon on the top.

Cooking Pastries

Always preheat the oven when cooking pastries. Do not open the door in order to prevent the pastry from dropping.

The batter or dough should not be too liquidy so that the cooking time is not excessive. In general:

Pastry is too dry

Increase the temperature by 10°C and reduce the cooking time.

Pastry dropped

Use less liquid or lower the temperature by 10°C.

Pastry is too dark on top

Place it on a lower rack, lower the temperature, and increase the cooking time.

Cooked well on the inside but sticky on the outside

Use less liquid, lower the temperature, and increase the cooking time.

The pastry sticks to the pan

Grease the pan well and sprinkle it with a dusting of flour.

I used more than one level and they are not all at the same cooking point

Use a lower temperature setting. It is not necessary to remove the food from all the racks at the same time.

Using the Grill

Grilling may be carried out with a two stage heating element situated in the top of the oven chamber. The centre, or the complete area of the grill can be selected by turning the SELECTOR knob in a clockwise direction to align the symbols |▼▼▼| with the mark on the control panel. The VARIABLE GRILL knob is positioned to right of the SELECTOR knob. This knob will provide varying grill temperatures when rotated from "max" to "min" and may be adjusted to vary the level of heat at any time during the grilling operation.

To operate the grill

1. Turn the SELECTOR knob clockwise until the required grilling symbol is in line with the mark on the control panel. The element is now "on".
2. The VARIABLE GRILL knob can now be operated to select the required heat.

When utilizing the grill, place the rack at the lower levels (see cooking table). To catch grease or fat and prevent smoke, place a drip pan at the bottom rack level.

Oven cooking advice table

Food to be cooked	Wt. (wt)	Cooking position of shelves from bottom	Temperature (°C)	Variable grill	Pre-heating time (min)	Cooking time (min.)
Pasta						
Lasagne	2.5	3	210		-	75-80
Cannelloni	2.5	3	210	MAX	-	75-80
Oven-baked noodles	2.5	3	210		-	75-80
Meat						
Veal	1.7	3	230		-	85-90
Chicken	1.5	3	220		-	110-115
Turkey	3.0	3	MAX	MAX	-	95-100
Duck	1.8	3	230		-	120/125
Rabbit	2	3	230		-	105/110
Pork	2.1	3	230		-	100/110
Lamb	1.8	3	230		-	90-95
Fish						
Mackerel	1.1	3	210-230		-	55-60
Dentex	1.5	3	210-230	MAX	-	60-65
Trout baked in paper	1.0	3	210-230		-	40-45
Pizza						
Napolitan	1.0	3	MAX	MAX	15	30-35
Cake						
Biscuits	0.5	3	180		15	30-35
Tarts	1.1	3	180	MAX	15	30-35
Chocolate cake	1	3	200		15	45-50
Raised Cakes	1	3	200		15	50/55
Grill cooking						
Toast	n.° 4	4			5	5-6
Pork chops	1.5	4		3/4	5	20-30
Mackerel	1.1	4			5	20-30

Note: cooking times are approximate and may vary according to personal taste.

Using the glass ceramic hob

GB

! The glue applied on the gaskets leaves traces of grease on the glass. Before using the appliance, we recommend you remove these with a special non-abrasive cleaning product. During the first few hours of use there may be a smell of rubber which will disappear very quickly.

Switching the cooking zones on and off

To switch on a cooking zone, turn the corresponding knob in a clockwise direction.

To switch it off again, turn the knob in an anticlockwise direction until it is in the "0" position. If the ACTIVE HOTPLATE ON indicator light is lit, this shows that at least one hotplate on the hob is switched on.

Cooking zones

The hobs have been provided with radiant electric heaters. These heaters are incorporated under the surface of the hob as zones which redden while they are in use.

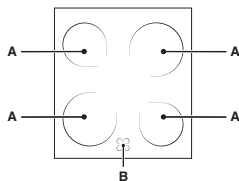

A. Cooking area
B. The residual heat indicator light: this indicates that the temperature of the corresponding cooking zone

is greater than 60°C, even when the heating element has been switched off but is still hot.

Cooking zones with heating elements

The radiant heating elements are composed of circular heating elements. They only become red after being turned on for 10-20 seconds.

! Do not stare directly at the halogen heating elements.

Turn the corresponding knob in a clockwise direction, to a position between 1 and 6.

Setting	Normal or Fast Plate
0	Off
1	Cooking vegetables, fish
2	Cooking potatoes (using steam) soups, chickpeas, beans.
3	Continuing the cooking of large quantities of food, minestrone
4	For roasting (average)
5	For roasting (above average)
6	For browning and reaching a boil in a short time.

Practical advice on using the hob

- Use pans with a thick, flat base to ensure that they adhere perfectly to the cooking zone.

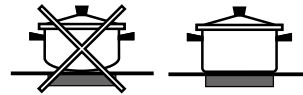

- Always use pans with a diameter that is large enough to cover the hotplate fully, in order to use all the heat produced.

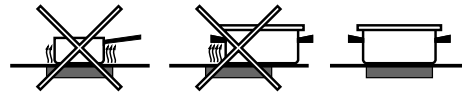

- Always make sure that the base of the pan is completely clean and dry: this ensures that the pans adhere perfectly to the cooking zones and that both the pans and the hob last for a longer period of time.
- Avoid using the same cookware that is used on gas burners: the heat concentration on gas burners may have warped the base of the pan, causing it not to adhere to the surface correctly.
- Never leave a cooking zone switched on without a pan on top of it, as doing so may cause the zone to become damaged.

! This appliance has been designed and manufactured in compliance with international safety standards. The following warnings are provided for safety reasons and must be read carefully.

General safety

- **These instructions are only valid for the countries whose symbols appear in the manual and on the serial number plate.**
- The appliance was designed for domestic use inside the home and is not intended for commercial or industrial use.
- The appliance must not be installed outdoors, even in covered areas. It is extremely dangerous to leave the appliance exposed to rain and storms.
- Do not touch the appliance with bare feet or with wet or damp hands and feet.
- The appliance must be used by adults only for the preparation of food, in accordance with the instructions provided in this booklet.
- The instruction booklet accompanies a class 1 (insulated) or class 2 - subclass 1 (recessed between 2 cupboards) appliance.
- **When the appliance is in use, the heating elements and some parts of the oven door become extremely hot. Make sure you don't touch them and keep children well away.**
- Make sure that the power supply cables of other electrical appliances do not come into contact with the hot parts of the oven.
- The openings used for the ventilation and dispersion of heat must never be covered.
- Do not place unstable or misshapen pans on the electric hotplates; this will help to avoid spills. Position them on the hob with the handles turned towards the centre of the appliance.
- Always use oven gloves when placing cookware in the oven or when removing it.
- Do not use flammable liquids (alcohol, petrol, etc...) near the appliance while it is in use.
- Do not place flammable material in the lower storage compartment or in the oven itself. If the appliance is switched on accidentally, it could catch fire.
- Always make sure the knobs are in the '0' position when the appliance is not in use.
- When unplugging the appliance, always pull the plug from the mains socket; do not pull on the cable.
- Never perform any cleaning or maintenance work without having disconnected the appliance from the electricity mains.
- If the appliance breaks down, under no circumstances should you attempt to repair the appliance yourself. Repairs carried out by inexperienced persons may cause injury or further malfunctioning of the appliance. Contact Assistance.
- Do not rest heavy objects on the open oven door.

- The internal surfaces of the compartment (where present) may become hot.
- The glass ceramic hob is resistant to mechanical shocks, but it may crack (or even break) if hit with a sharp object such as a tool. If this happens, disconnect the appliance from the electricity mains immediately and contact a Service Centre.
- If the surface of the hob is cracked, switch off the appliance to prevent electric shocks from occurring.
- Remember that the temperature of the cooking zones remains relatively high for at least thirty minutes after they have been switched off.
- Keep any object that could melt away from the hob, for example plastic and aluminium objects, or products with a high sugar content. Keep plastic or aluminium objects away from the hob: if you forget them on surfaces that are still hot, they may cause serious damage to the hob.
- The appliance should not be operated by people (including children) with reduced physical, sensory or mental capacities, by inexperienced individuals or by anyone who is not familiar with the product. These individuals should, at the very least, be supervised by someone who assumes responsibility for their safety or receive preliminary instructions relating to the operation of the appliance.

Disposal

- When disposing of packaging material: observe local legislation so that the packaging may be reused.
- The European Directive 2002/96/EC relating to Waste Electrical and Electronic Equipment (WEEE) states that household appliances should not be disposed of using the normal solid urban waste cycle. Exhausted appliances should be collected separately in order to optimise the cost of re-using and recycling the materials inside the machine, while preventing potential damage to the atmosphere and to public health. The crossed-out dustbin is marked on all products to remind the owner of their obligations regarding separated waste collection. Exhausted appliances may be collected by the public waste collection service, taken to suitable collection areas in the area or, if permitted by current national legislation, they may be returned to the dealers as part of an exchange deal for a new equivalent product. All major manufacturers of household appliances participate in the creation and organisation of systems for the collection and disposal of old and disused appliances.

Respecting and conserving the environment

- You can help to reduce the peak load of the electricity supply network companies by using the oven in the hours between late afternoon and the early hours of the morning.
- Check the door seals regularly and wipe them clean to ensure they are free of debris so that they adhere properly to the door, thus avoiding heat dispersion.

Care and maintenance

GB

Switching the appliance off

Disconnect your appliance from the electricity supply before carrying out any work on it.

Cleaning the appliance

! Never use steam cleaners or pressure cleaners on the appliance.

- Clean the glass part of the oven door using a sponge and a non-abrasive cleaning product, then dry thoroughly with a soft cloth. Do not use rough abrasive material or sharp metal scrapers as these could scratch the surface and cause the glass to crack.
- The stainless steel or enamel-coated external parts and the rubber seals may be cleaned using a sponge that has been soaked in lukewarm water and neutral soap. Use specialised products for the removal of stubborn stains. After cleaning, rinse and dry thoroughly. Do not use abrasive powders or corrosive substances.
- The inside of the oven should ideally be cleaned after each use, while it is still lukewarm. Use hot water and detergent, then rinse well and dry with a soft cloth. Do not use abrasive products.
- The accessories can be washed like everyday crockery, and are even dishwasher safe.
- Dirt and grease should be removed from the control panel using a non-abrasive sponge or a soft cloth.
- Stainless steel can be marked by hard water that has been left on the surface for a long time, or by aggressive detergents containing phosphorus. After cleaning, rinse well and dry thoroughly. Any remaining drops of water should also be dried.

Inspecting the oven seals

Check the door seals around the oven regularly. If the seals are damaged, please contact your nearest After-sales Service Centre. We recommend that the oven is not used until the seals have been replaced.

Replacing the oven light bulb

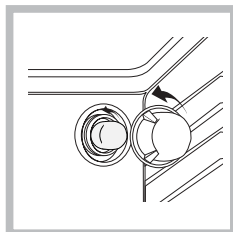

1. After disconnecting the oven from the electricity mains, remove the glass lid covering the lamp socket (*see figure*).
2. Remove the light bulb and replace it with a similar one: voltage 230 V, wattage 25 W, cap E 14.

3. Replace the lid and reconnect the oven to the electricity supply.

Cleaning the glass ceramic hob

! Do not use abrasive or corrosive detergents (for example, products in spray cans for cleaning barbecues and ovens), stain removers, anti-rust products, powder detergents or sponges with abrasive surfaces: these may scratch the surface beyond repair.

- It is usually sufficient simply to wash the hob using a damp sponge and dry it with absorbent kitchen roll.
- If the hob is particularly dirty, rub it with a special glass ceramic cleaning product, then rinse well and dry thoroughly.
- To remove more stubborn dirt, use a suitable scraper (this is not supplied with the appliance). Remove spills as soon as possible, without waiting for the appliance to cool, to avoid residues forming crusty deposits. You can obtain excellent results by using a rustproof steel wire sponge - specifically designed for glass ceramic surfaces - soaked in soapy water.
- If plastic or sugary substances have accidentally been melted on the hob, remove them immediately with the scraper, while the surface is still hot.
- Once it is clean, the hob may be treated with a special protective maintenance product: the invisible film left by this product protects the surface from drips during cooking. This maintenance should be carried out while the appliance is warm (not hot) or cold.
- Always remember to rinse the appliance well with clean water and dry it thoroughly: residues can become encrusted during subsequent cooking processes.

Glass ceramic hob cleaners	Available from
Window scraper Razor blade scrapers	DIY Stores
Replacement blades	DIY Stores, supermarkets, chemists
COLLO luneta HOB BRITE Hob Clean SWISSCLEANER	Boots, Co-op stores, department stores, Regional Electricity Company shops, supermarkets

Assistance

Please have the following information to hand:

- The appliance model (Mod.).
- The serial number (S/N).

This information can be found on the data plate located on the appliance and/or on the packaging.

Free Manuals Download Website

<http://myh66.com>

<http://usermanuals.us>

<http://www.somanuals.com>

<http://www.4manuals.cc>

<http://www.manual-lib.com>

<http://www.404manual.com>

<http://www.luxmanual.com>

<http://aubethermostatmanual.com>

Golf course search by state

<http://golfingnear.com>

Email search by domain

<http://emailbydomain.com>

Auto manuals search

<http://auto.somanuals.com>

TV manuals search

<http://tv.somanuals.com>