

GB

English,1

**IWDD 7123 S**

!  This symbol reminds you to read this instruction manual.

GB

### Contents

#### **Installation, 2-3-4-5**

Unpacking and levelling  
Connecting the electricity and water supplies  
The first wash cycle  
Technical data

#### **Description of the washer-dryer and starting a wash cycle, 6-7**

Control panel  
Indicator lights  
Starting a wash cycle

#### **Wash cycles, 8**

Table of wash cycles

#### **Personalisation, 9**

Setting the temperature  
Setting the drying cycle  
Functions

#### **Detergents and laundry, 10**

Detergent dispenser drawer  
Preparing the laundry  
Garments requiring special care  
Load balancing system

#### **Precautions and tips, 11**

General safety  
Disposal

#### **Care and maintenance, 12**

Cutting off the water or electricity supply  
Cleaning the washer-dryer  
Cleaning the detergent dispenser drawer  
Caring for the door and drum of your appliance  
Cleaning the pump  
Checking the water inlet hose

#### **Troubleshooting, 13**

#### **Service and Guarantee, 14-15-16**

Before calling for Assistance  
Guarantee

# Installation

GB

! This instruction manual should be kept in a safe place for future reference. If the washer-dryer is sold, transferred or moved, make sure that the instruction manual remains with the machine so that the new owner is able to familiarise himself/herself with its operation and features.

! Read these instructions carefully: they contain vital information relating to the safe installation and operation of the appliance.

## Unpacking and levelling

### Unpacking

1. Remove the washer-dryer from its packaging.
2. Make sure that the washer-dryer has not been damaged during the transportation process. If it has been damaged, contact the retailer and do not proceed any further with the installation process.

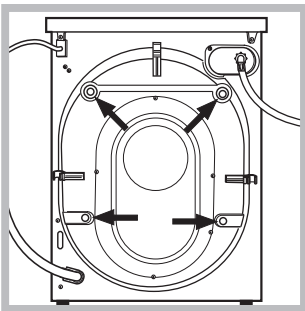

3. Remove the 4 protective screws (used during transportation) and the rubber washer with the corresponding spacer, located on the rear part of the appliance (see figure).

4. Close off the holes using the plastic plugs provided.
5. Keep all the parts in a safe place: you will need them again if the washer-dryer needs to be moved to another location.

! Packaging materials should not be used as toys for children.

### Levelling

1. Install the washer-dryer on a flat sturdy floor, without resting it up against walls, furniture cabinets or anything else.

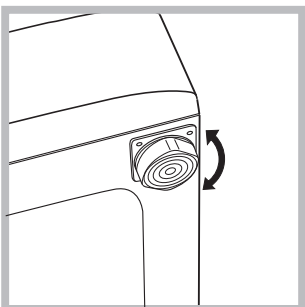

2. If the floor is not perfectly level, compensate for any unevenness by tightening or loosening the adjustable front feet (see figure); the angle of inclination, measured in relation to the worktop, must not exceed 2°.

Levelling the machine correctly will provide it with stability, help to avoid vibrations and excessive noise and prevent it from shifting while it is operating. If it is placed on carpet or a rug, adjust the feet in such a way as to allow a sufficient ventilation space underneath the washer-dryer.

## Connecting the electricity and water supplies

### Connecting the water inlet hose

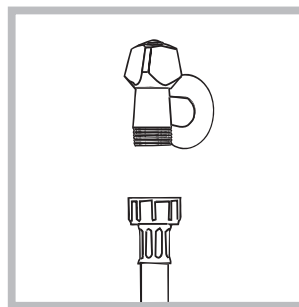

1. Connect the supply pipe by screwing it to a cold water tap using a 3/4 gas threaded connection (see figure). Before performing the connection, allow the water to run freely until it is perfectly clear.

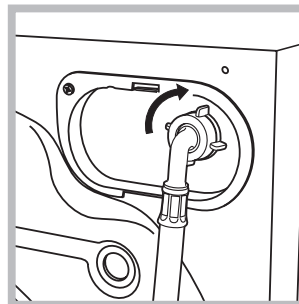

2. Connect the inlet hose to the washer-dryer by screwing it onto the corresponding water inlet of the appliance, which is situated on the top right-hand side of the rear part of the appliance (see figure).

3. Make sure that the hose is not folded over or bent.

! The water pressure at the tap must fall within the values indicated in the Technical details table (see next page).

! If the inlet hose is not long enough, contact a specialised shop or an authorised technician.

! Never use second-hand hoses.

! Use the ones supplied with the machine.

### Connecting the drain hose

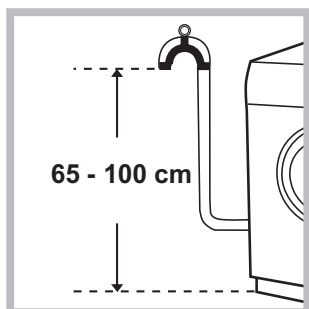

Connect the drain hose, without bending it, to a draining duct or a wall drain situated between 65 and 100 cm from the floor;

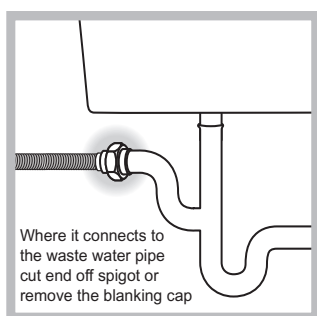

The drain hose may be connected to an under-sink trap. Before connecting the drain hose from the machine ensure that any blanks or removable ends have been taken off the spigot.

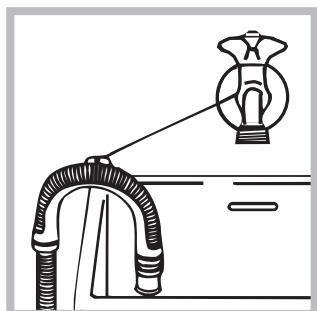

If it is place over the edge of a basin or sink be sure the free end of the hose should not be underwater.

**!** We advise against the use of hose extensions; in case of absolute need, the extension must have the same diameter as the original hose and must not exceed 150 cm in length.

Ensure that if the drain hose is pushed into a standpipe, that the end does not go down more than 15cms (6 inches). If the hose is pushed down too far, this may cause the machine to self-siphon ie. continuously empty as it is filling.

### Electric connection

Before plugging the appliance into the mains socket, make sure that:

- the socket is earthed and in compliance with the applicable law;
- the socket is able to sustain the appliance's maximum power load indicated in the Technical details table (see page 5);

- the supply voltage is included within the values indicated on the Technical details table (see page 5);
- the socket is compatible with the washing machine's plug. If this is not the case, replace the socket or the plug.

Your appliance is now supplied with a 13 amp fused plug it can be plugged into a 13 amp socket for immediate use. Before using the appliance please read the instructions below.

**WARNING - THIS APPLIANCE MUST BE EARTHED. THE FOLLOWING OPERATIONS SHOULD BE CARRIED OUT BY A QUALIFIED ELECTRICIAN.**

#### Replacing the fuse:

When replacing a faulty fuse, a 13 amp ASTA approved fuse to BS 1362 should always be used, and the fuse cover re-fitted. If the fuse cover is lost, the plug must not be used until a replacement is obtained.

#### Replacement fuse covers:

If a replacement fuse cover is fitted, it must be of the correct colour as indicated by the coloured marking or the colour that is embossed in words on the base of the plug. Replacements can be obtained directly from your nearest Service Depot.

#### Removing the plug:

If your appliance has a non-rewireable moulded plug and you should wish to re-route the mains cable through partitions, units etc., please ensure that either:

the plug is replaced by a fused 13 ampere re-wearable plug bearing the BSI mark of approval. or:

the mains cable is wired directly into a 13 amp cable outlet, controlled by a switch, (in compliance with BS 5733) which is accessible without moving the appliance.

#### Disposing of the plug:

Ensure that before disposing of the plug itself, you make the pins unusable so that it cannot be accidentally inserted into a socket.

Instructions for connecting cable to an alternative plug: Important: the wires in the mains lead are coloured in accordance with the following code:

<b>Green &amp; Yellow</b>	<b>Earth</b>
<b>Blue</b>	<b>Neutral</b>
<b>Brown</b>	<b>Live</b>

As the colours of the wires in the lead may not correspond with the coloured markings identifying the terminals in your plug, proceed as follows:  
 Connect Green & Yellow wire to terminal marked **E** or  $\perp$  or coloured Green or Green & Yellow.  
 Connect Brown wire to terminal marked **L** or coloured Red.  
 Connect Blue wire to terminal marked **N** or coloured Black.

If a 13 amp plug (BS 1363) is used it must be fitted with a 13 amp fuse, either in the plug or adaptor or at the distribution board.

If you are in any doubt the electrical supply to your machine, consult a qualified electrician before use.

How to connect an alternative plug:

The wires in this mains lead are coloured in accordance with the following code:

<b>BLUE</b>	<b>NEUTRAL (N)</b>
<b>BROWN</b>	<b>LIVE (L)</b>
<b>GREEN &amp; YELLOW</b>	<b>EARTH (E)</b>

#### *Disposing of the appliance:*

When disposing of the appliance please remove the plug by cutting the mains cable as close as possible to the plug body and dispose of it as described above.

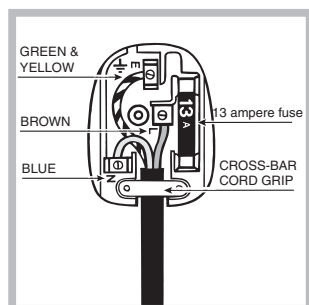

! The washing machine should not be installed in an outdoor environment, not even when the area is sheltered, because it may be very dangerous to leave it exposed to rain and thunderstorms.

! When the washing machine is installed, the mains socket must be within easy reach.

! Do not use extensions or multiple sockets.





! The power supply cable must never be bent or dangerously compressed.

! The power supply cable must only be replaced by an authorised serviceman.

Warning! The company denies all liability if and when these norms are not respected.

## **The first wash cycle**

Once the appliance has been installed, and before you use it for the first time, run a wash cycle with detergent and no laundry, setting the 90°C programme without a pre-wash cycle.

<b>Technical data</b>	
<b>Model</b>	IWDD 7123 S
<b>Dimensions</b>	width 59,5 cm height 85 cm depth 53,5 cm
<b>Capacity</b>	from 1 to 7 kg for the wash programme; from 1 to 5 kg for the drying programme
<b>Electrical connections</b>	please refer to the technical data plate fixed to the machine
<b>Water connections</b>	maximum pressure 1 MPa (10 bar) minimum pressure 0.05 MPa (0.5 bar) drum capacity 52 litres
<b>Spin speed</b>	up to 1200 rotations per minute
<b>Energy rated programmes according to regulation EN 50229</b>	<b>Wash:</b> programme 2; temperature 60°C; run with a load of 7 kg. <b>Drying:</b> first drying cycle performed with a 2 kg load and the DRYING knob on the  setting. Second drying cycle performed with a 5 kg load and the DRYING knob on the  setting.
  	This appliance conforms to the following EC Directives: - 89/336/EEC dated 03/05/89 (Electromagnetic Compatibility) and subsequent modifications - 2002/96/EC - 2006/95/EC Low Voltage)

# Description of the washer-dryer and starting a wash cycle

GB

## Control panel

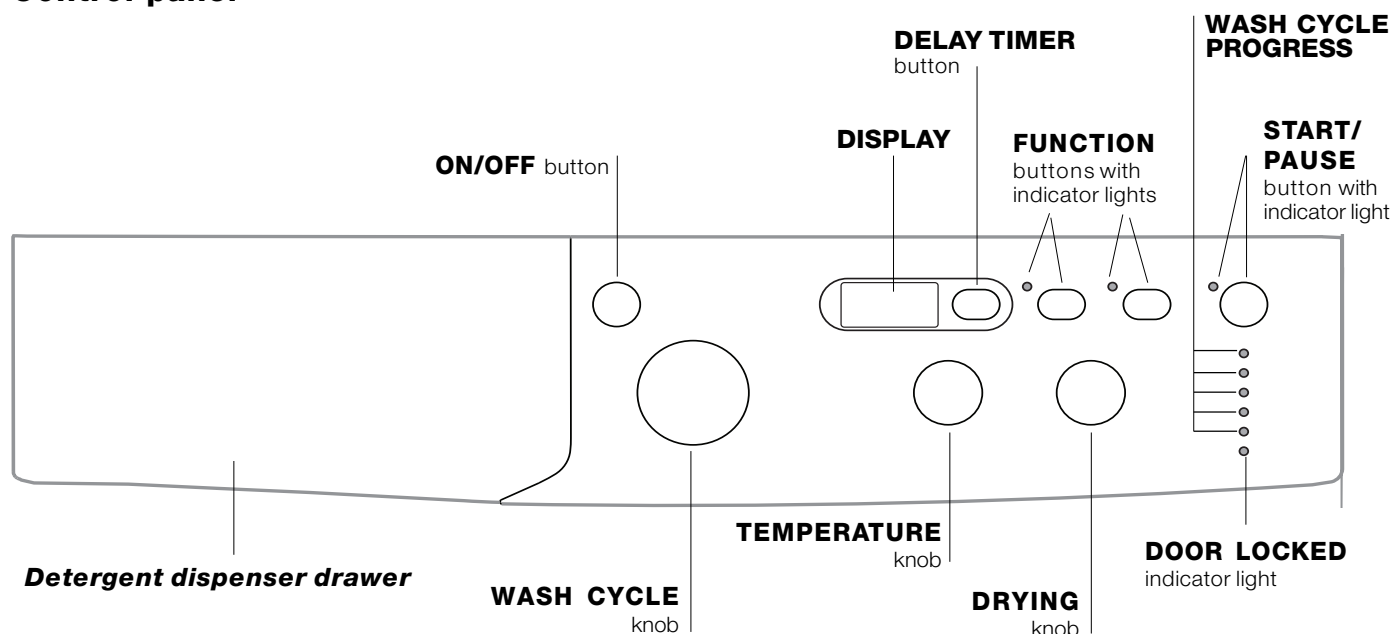

**Detergent dispenser drawer:** used to dispense detergents and washing additives (see “Detergents and laundry”).

**ON/OFF button:** switches the washing machine on and off.

**WASH CYCLE knob:** programmes the wash cycles. During the wash cycle, the knob does not move.

**FUNCTION buttons with indicator light:** used to select the available functions. The indicator light corresponding to the selected function will remain lit.

**TEMPERATURE knob:** sets the temperature or the cold wash cycle (see “Personalisation”).

**DRYING knob:** used to set the desired drying programme (see “Personalisation”).

**DISPLAY:** used to view the duration of the various cycles available and the remaining time of a cycle in progress; if the DELAY TIMER option has been selected, the countdown to the start of the selected cycle will appear.

**DELAY TIMER button** : press to set a delayed start time for the selected wash cycle. The delay time will be shown on the display.

**WASH CYCLE PROGRESS** indicator lights: used to monitor the progress of the wash cycle. The illuminated indicator light shows which phase is in progress.

**DOOR LOCKED** indicator light: indicates whether the door may be opened or not (see next page).

**START/PAUSE button with indicator light:** starts or temporarily interrupts the wash cycles.

**N.B.** To pause the wash cycle in progress, press this button; the corresponding indicator light will flash orange, while the indicator light for the current wash cycle phase will remain lit in a fixed manner. If the DOOR LOCKED  indicator light is switched off, the door may be opened.

To start the wash cycle from the point at which it was interrupted, press this button again.

### Standby mode





This washing machine, in compliance with new energy saving regulations, is fitted with an automatic standby system which is enabled after a few minutes if no activity is detected. Press the ON-OFF button briefly and wait for the machine to start up again.

## Indicator lights

The indicator lights provide important information. This is what they can tell you:

### Wash cycle phase indicator lights

Once the desired wash cycle has been selected and has begun, the indicator lights switch on one by one to indicate which phase of the cycle is currently in progress.

Wash	
Rinse	
Spin/Drain	
Drying	
End of wash cycle	

**Note:** when the drying cycle has finished, the DRYING knob should be returned to the “0” position.

### Function buttons and corresponding indicator lights

When a function is selected, the corresponding indicator light will illuminate.

If the selected function is not compatible with the programmed wash cycle, the corresponding indicator light will flash and the function will not be activated.

If the selected function is not compatible with another function which has been selected previously, the indicator light corresponding to the first function selected will flash and only the second function will be activated; the indicator light corresponding to the enabled option will remain lit.

### Door locked indicator light

When the indicator light is on, the porthole door is locked to prevent it from being opened; make sure the indicator light is off before opening the door (wait approximately 3 minutes). To open the door during a running wash cycle, press the START/PAUSE button; the door may be opened once the DOOR LOCKED indicator light turns off.

## Starting a wash cycle

1. Switch the washer-dryer on by pressing the ON/OFF button. All indicator lights will switch on for a few seconds, then they will switch off and the START/PAUSE indicator light will pulse.
2. Load the laundry and close the door.
3. Set the WASH CYCLE knob to the desired programme.
4. Set the washing temperature (see “Personalisation”).
5. Set the drying cycle if necessary (see “Personalisation”).
6. Measure out the detergent and washing additives (see “Detergents and laundry”).
7. Select the desired functions.
8. Start the wash cycle by pressing the START/PAUSE button and the corresponding indicator light will remain lit in a fixed manner, in green.



To cancel the set wash cycle, pause the machine by pressing the START/PAUSE button and select a new cycle.

9. At the end of the wash cycle the **END** indicator light will switch on. The door can be opened once the DOOR LOCKED  indicator light turns off. Take out your laundry and leave the appliance door ajar to make sure the drum dries completely. Switch the washer-dryer off by pressing the ON/OFF button.

# Wash cycles

GB

**Table of wash cycles**

Wash cycles	Description of the wash cycle	Max. temp. (°C)	Max. speed (rpm)	Drying	Detergents		Max. load (kg)		Cycle duration	
					Wash	Fabric softener	Normal	Eco Time		
<b>Daily</b>										
1	<b>White Cotton:</b> extremely soiled whites.	90°	1200	●	●	●	7	-	The duration of the wash cycles can be checked on the display.	
1	<b>White Cotton (1):</b> heavily soiled whites and resistant colours.	60°	1200	●	●	●	7	-		
1	<b>White Cotton (2):</b> heavily soiled whites and delicate colours.	40°	1200	●	●	●	7	-		
2	<b>Cotton:</b> heavily soiled whites and resistant colours.	60°	1200	●	●	●	7	3,5		
3	<b>Coloured Cotton (3):</b> lightly soiled whites and delicate colours.	40°	1200	●	●	●	7	3,5		
4	<b>Synthetics:</b> heavily soiled resistant colours.	50°	800	●	●	●	3	2		
<b>Special</b>										
5	<b>Wool:</b> for wool, cashmere, etc.	40°	600	-	●	●	1,5	-		
6	<b>Silk/Curtains:</b> for garments in silk and viscose, lingerie.	30°	0	-	●	●	1	-		
7	<b>Jeans</b>	40°	800	●	●	●	3	-		
<b>Sport</b>										
8	<b>Sport Intensive</b>	30°	600	-	-	●	3	-		
9	<b>Sport Light</b>	30°	600	-	●	●	3	-		
10	<b>Special Shoes</b>	30°	600	-	●	●	Max. 2 pairs	-		
<b>Dry</b>										
11	<b>Cotton</b>	-	-	●	-	-	5	-		
12	<b>Synthetics</b>	-	-	●	-	-	3	-		
13	<b>Express Wash &amp; Dry</b>	30°	1200	●	●	●	0,5	-		
<b>Partial wash cycles</b>										
	Rinse	-	1200	●	-	●	7	-		
	Spin	-	1200	●	-	-	7	-		
	Drain	-	0	-	-	-	7	-		

The information contained in the table is intended as a guide only.

**For all Test Institutes:**

- 1) Test wash cycle in compliance with regulation EN 50229: set wash cycle 1 with a temperature of 60°C.
- 2) Long wash cycle for cottons: set wash cycle 1 with a temperature of 40°C.
- 3) Short wash cycle for cottons: set wash cycle 3 with a temperature of 40°C.

**Specials wash cycles**

**Sport Intensive** (wash cycle 8) is for washing heavily soiled sports clothing fabrics (tracksuits, shorts, etc.); for best results, we recommend not exceeding the maximum load indicated in the "Table of wash cycles".

**Sport Light** (wash cycle 9) is for washing lightly soiled sports clothing fabrics (tracksuits, shorts, etc.); for best results, we recommend not exceeding the maximum load indicated in the "Table of wash cycles". We recommend using a liquid detergent and dosage suitable for a half-load.

**Special Shoes** (wash cycle 10) is for washing sports shoes; for best results, do not wash more than 2 pairs simultaneously.

**Express Wash & Dry** (wash cycle 13) was designed to wash and dry lightly soiled garments quickly. This cycle may be used to wash and dry a laundry load of up to 0.5 kg in just 35 minutes.

To achieve optimum results, use liquid detergent and pre-treat cuffs, collars and stains.



## Setting the temperature

Turn the TEMPERATURE knob to set the wash temperature (see *Table of wash cycles*).

The temperature may be lowered, or even set to a cold wash . The washer-dryer will automatically prevent you from selecting a temperature which is higher than the maximum value set for each wash cycle.

## Setting the drying cycle

Turn the DRYING knob to select the desired drying option. There are two options:

**A** - Based on time: From **40** minutes to **180**.

**B** - Based on the desired laundry dryness level:

*Iron dry* : suitable for clothes which will need ironing afterwards. the remaining dampness softens creases, making them easier to remove.

*Hanger dry* : ideal for clothes which do not need to be dried fully.



*Cupboard dry* : suitable for laundry which can be put back in a cupboard without being ironed.

If your laundry load to be washed and dried is much greater than the maximum stated load (see *adjacent table*), perform the wash cycle, and when the cycle is complete, divide the garments into groups and put some of them back in the drum. At this point, follow the instructions provided for a **"Drying only"** cycle. Repeat this procedure for the remainder of the load.

### Drying only

Use the cycle selector knob to select a drying cycle (**11-12**) in accordance with the type of fabric. The desired drying level or time may also be set using the DRYING knob.

**Table of Drying times (guideline values)**

Fabric type	Load type	Max. load (kg)	Cupboard dry 	Hanger dry 	Iron dry 
Cotton	Clothing of different sizes, Terry towels	5	180	170	140
Synthetics	Sheets, Shirts, Pyjamas, socks, etc.	3	140	120	100

## Functions

The various wash functions available with this washer-dryer will help to achieve the desired results, every time.

To activate the functions:

1. Press the button corresponding to the desired function;
2. the function is enabled when the corresponding indicator light is illuminated.

Note: If the indicator light flashes rapidly, this signals that this particular function may not be selected in conjunction with the selected wash cycle.



### Delay timer

To set a delayed start for the selected programme, press the corresponding button repeatedly until the required delay period has been reached. When this option is enabled, the  symbol lights up on the display. To remove the delayed start option press the button until the text "OFF" appears on the display.

! This option is enabled with all programmes.

### EcoTime

Selecting this option enables you to suitably adjust drum rotation, temperature and water to a reduced load of lightly soiled cotton and synthetic fabrics (refer to the *"Table of wash cycles"*). "EcoTime" enables you to wash in less time thereby saving water and electricity. We suggest using a liquid detergent suitably measured out to the load quantity.

! This function may not be used in conjunction with cycles 1, 5, 6, 7, 8, 9, 10, 11, 12, 13, , , .

### 1200-600

Press this button to reduce the spin speed

! This function may not be used in conjunction with cycles 6, 11, 12, 13, .

# Detergents and laundry

GB

## Detergent dispenser drawer

Good washing results also depend on the correct dose of detergent: adding too much detergent will not necessarily result in a more efficient wash, and may in fact cause build up on the inside of your appliance and contribute to environmental pollution.

! Do not use hand washing detergents because these create too much foam.

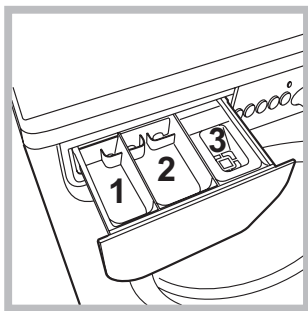

Open the detergent dispenser drawer and pour in the detergent or washing additive, as follows.

**compartment 1: Pre-wash detergent (powder)**  
**compartment 2: Detergent for the wash cycle (powder or liquid)**

Liquid detergent should only be poured in immediately prior to the start of the wash cycle.

**compartment 3: Additives (fabric softeners, etc.)**

The fabric softener should not overflow the grid.

## Preparing the laundry

- Divide the laundry according to:
  - the type of fabric/the symbol on the label
  - the colours: separate coloured garments from whites.
- Empty all garment pockets and check the buttons.
- Do not exceed the listed values, which refer to the weight of the laundry when dry:
  - Durable fabrics: max. 7 kg
  - Synthetic fabrics: max. 3 kg
  - Delicate fabrics: max. 2 kg
  - Wool: max. 1,5 kg
  - Silk: max. 1 kg

### How much does your laundry weigh?

- 1 sheet 400-500 g
- 1 pillow case 150-200 g
- 1 tablecloth 400-500 g
- 1 bathrobe 900-1200 g
- 1 towel 150-250 g

## Garments requiring special care

**Wool:** all wool garments can be washed using programme **5**, even those carrying the "hand-wash only"  label. For best results, use special detergents and do not exceed 1,5 kg of laundry.

**Silk:** use special wash cycle **6** to wash all silk garments. We recommend the use of special detergent which has been designed to wash delicate clothes.

**Curtains:** fold curtains and place them in a pillow case or mesh bag. Use wash cycle **6**.

**Jeans:** Turn garments inside-out before washing and use a liquid detergent. Use programme **7**.

## Load balancing system

Before every spin cycle, to avoid excessive vibrations and to distribute the load in a uniform manner, the drum rotates continuously at a speed which is slightly greater than the washing rotation speed. If, after several attempts, the load is not balanced correctly, the machine spins at a reduced spin speed. If the load is excessively unbalanced, the washer-dryer performs the distribution process instead of spinning. To encourage improved load distribution and balance, we recommend small and large garments are mixed in the load.

! This Washer-dryer was designed and constructed in accordance with international safety regulations. The following information is provided for safety reasons and must therefore be read carefully.

## General safety

- This appliance was designed for domestic use only.
- This appliance is not intended for use by persons (including children) with reduced physical, sensory or mental capabilities, or lack of experience and knowledge, unless they have been given supervision or instruction concerning use of the appliance by a person responsible for their safety. Children should be supervised to ensure that they do not play with the appliance.
- Do not dry unwashed items in the tumble dryer. Items that have been soiled with substances such as cooking oil, acetone, alcohol, petrol, kerosene, spot removers, turpentine, waxes and wax removers should be washed in hot water with an extra amount of detergent before being dried in the tumble dryer.  
Items such as foam rubber (latex foam), shower caps, waterproof textiles, rubber backed articles and clothes or pillows fitted with foam rubber pads should not be dried in the tumble dryer.  
Fabric softeners, or similar products, should be used as specified by the fabric softener instructions. The final part of a tumble dryer cycle occurs without heat (cool down cycle) to ensure that the items are left at a temperature that ensures that the items will not be damaged.  
WARNING: Never stop a tumble dryer before the end of the drying cycle unless all items are quickly removed and spread out so that the heat is dissipated.
- Do not touch the machine when barefoot or with wet or damp hands or feet.
- Do not pull on the power supply cable when unplugging the appliance from the electricity socket. Hold the plug and pull.
- Do not open the detergent dispenser drawer while the machine is in operation.
- Do not touch the drained water as it may reach extremely high temperatures.
- Never force the porthole door. This could damage the safety lock mechanism designed to prevent accidental opening.
- If the appliance breaks down, do not under any circumstances access the internal mechanisms in an attempt to repair it yourself.
- Always keep children well away from the appliance while it is operating.

- The door can become quite hot during the wash cycle.
- If the appliance has to be moved, work in a group of two or three people and handle it with the utmost care. Never try to do this alone, because the appliance is very heavy.
- Before loading laundry into the Washer-dryer, make sure the drum is empty.
- During the drying phase, the door tends to get quite hot.
- Do not use the appliance to dry clothes that have been washed with flammable solvents (e.g. trichlorethylene).
- Do not use the appliance to dry foam rubber or similar elastomers.
- Make sure that the water tap is turned on during the drying cycles.

## Disposal

- Disposing of the packaging materials: observe local regulations so that the packaging may be re-used.
- The European Directive 2002/96/EC on Waste Electrical and Electronic Equipment, requires that old household electrical appliances must not be disposed of in the normal unsorted municipal waste stream. Old appliances must be collected separately in order to optimise the recovery and recycling of the materials they contain and reduce the impact on human health and the environment. The crossed out "wheeled bin" symbol on the product reminds you of your obligation, that when you dispose of the appliance it must be separately collected.  
Consumers should contact their local authority or retailer for information concerning the correct disposal of their old appliance.

# Care and maintenance

## GB Cutting off the water and electricity supplies

- Turn off the water tap after every wash cycle. This will limit wear on the hydraulic system inside the washer-dryer and help to prevent leaks.
- Unplug the washer-dryer when cleaning it and during all maintenance work.

## Cleaning the washer-dryer

The outer parts and rubber components of the appliance can be cleaned using a soft cloth soaked in lukewarm soapy water. Do not use solvents or abrasives.

## Cleaning the detergent dispenser drawer

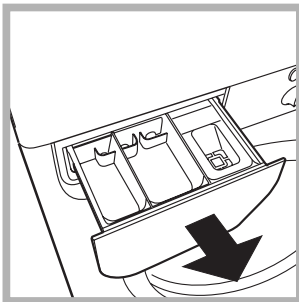

Remove the dispenser by raising it and pulling it out (see figure). Wash it under running water; this operation should be repeated frequently.

## Caring for the door and drum of your appliance

- Always leave the porthole door ajar in order to prevent unpleasant odours from forming.

## Cleaning the pump

The washer-dryer is fitted with a self-cleaning pump which does not require any maintenance. Sometimes, small items (such as coins or buttons) may fall into the pre-chamber which protects the pump, situated in its bottom part.

! Make sure the wash cycle has finished and unplug the appliance.

To access the pre-chamber:

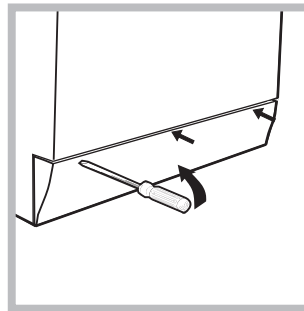

1. using a screwdriver, remove the cover panel on the lower front part of the washer-dryer (see figure);

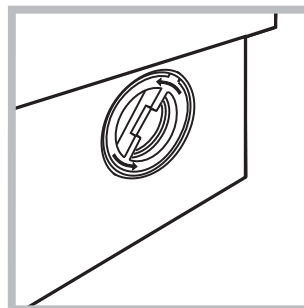

2. unscrew the lid by rotating it anti-clockwise (see figure): a little water may trickle out. This is perfectly normal;

3. clean the inside thoroughly;
4. screw the lid back on;
5. reposition the panel, making sure the hooks are securely in place before you push it onto the appliance.

## Checking the water inlet hose

Check the inlet hose at least once a year. If there are any cracks, it should be replaced immediately: during the wash cycles, water pressure is very strong and a cracked hose could easily split open.

! Never use second-hand hoses.

Your washer-dryer could fail to work. Before contacting the Technical Assistance Centre (see "Assistance"), make sure that the problem cannot be not solved easily using the following list.

## Problem:

**The Washer-dryer does not switch on.**

**The wash cycle does not start.**

**The washing machine does not take in water ("H2O" will flash on the display).**

**The Washer-dryer continuously takes in and drains water.**

**The Washer-dryer does not drain or spin.**

**The Washer-dryer vibrates a lot during the spin cycle.**

**The Washer-dryer leaks.**

**The "Functions" indicator lights and the "start/pause" indicator light flash, while one of the "phase in progress" indicator lights and the "door locked" indicator light will remain lit in a fixed manner.**

**There is too much foam.**

**The washer-dryer does not dry.**

## Possible causes / Solutions:

- The appliance is not plugged into the socket fully, or is not making contact.
- There is no power in the house.

- The Washer-dryer door is not closed properly.
- The ON/OFF button has not been pressed.
- The START/PAUSE button has not been pressed.
- The water tap has not been opened.
- A delayed start has been set.

- The water inlet hose is not connected to the tap.
- The hose is bent.
- The water tap has not been opened.
- There is no water supply in the house.
- The pressure is too low.
- The START/PAUSE button has not been pressed.

- The drain hose is not fitted at a height between 65 and 100 cm from the floor (see "Installation").
- The free end of the hose is under water (see "Installation").
- The wall drainage system is not fitted with a breather pipe.

If the problem persists even after these checks, turn off the water tap, switch the appliance off and contact the Assistance Service. If the dwelling is on one of the upper floors of a building, there may be problems relating to water drainage, causing the Washer-dryer to fill with water and drain continuously. Special anti-draining valves are available in shops and help to avoid this inconvenience.

- The wash cycle does not include draining: some wash cycles require the drain phase to be started manually.
- The drain hose is bent (see "Installation").
- The drainage duct is clogged.

- The drum was not unlocked correctly during installation (see "Installation").
- The Washer-dryer is not level (see "Installation").
- The Washer-dryer is trapped between cabinets and walls (see "Installation").

- The water inlet hose is not screwed on properly (see "Installation").
- The detergent dispenser drawer is blocked (for cleaning instructions, see "Care and maintenance").
- The drain hose is not fixed properly (see "Installation").

- Switch off the machine and unplug it, wait for approximately 1 minute and then switch it back on again.
- If the problem persists, contact the Technical Assistance Service.

- The detergent is not suitable for machine washing (it should display the text "for Washer-dryers" or "hand and machine wash", or the like).
- Too much detergent was used.

- The appliance is not plugged into the socket, or not enough to make contact.
- There has been a power failure.
- The appliance door is not shut properly.
- A delayed start has been set.
- DRYING knob is in the 0 position.

# Service

---

GB

## **Before calling for Assistance:**

- Check whether you can solve the problem alone (see “*Troubleshooting*”);
- Restart the programme to check whether the problem has been solved;
- If this is not the case, contact an authorised Technical Assistance Centre using the telephone number provided on the guarantee certificate.

! Always request the assistance of authorised technicians.

## **Have the following information to hand:**

- the type of problem;
- the appliance model (Mod.);
- the serial number (S/N).

This information can be found on the data plate applied to the rear of the washer-dryer, and can also be found on the front of the appliance by opening the door.

## 12 Months Parts and Labour Guarantee

Your appliance has the benefit of our manufacturer's guarantee, which covers the cost of breakdown repairs for twelve months from the date of purchase.

This gives you the reassurance that if, within that time, your appliance is proven to be defective because of either workmanship or materials, we will, at our discretion, either repair or replace the appliance at no cost to you.

This guarantee is subject to the following conditions:

- The appliance has been installed and operated correctly and in accordance with our operating and maintenance instructions.
- The appliance is used only on the electricity or gas supply printed on the rating plate.
- The appliance has been used for normal domestic purposes only.
- The appliance has not been altered, serviced, maintained, dismantled, or otherwise interfered with by any person not authorised by us.
- Any repair work must be undertaken by us or our appointed agent.
- Any parts removed during repair work or any appliance that is replaced become our property.
- The appliance is used in the United Kingdom or Republic of Ireland.

The guarantee does not cover:

- Damage resulting from transportation, improper use, neglect or interference or as a result of improper installation.
- Replacement of any consumable item or accessory . These include but are not limited to: plugs, cables, batteries, light bulbs, fluorescent tubes and starters, covers and filters.
- Replacement of any removable parts made of glass or plastic.

THIS GUARANTEE WILL NOT APPLY IF THE APPLIANCE HAS BEEN USED IN COMMERCIAL OR NON-DOMESTIC PREMISES.

## 5 Year Parts Guarantee

Indesit also offers you a free 5 year parts guarantee. This additional guarantee is conditional on you registering your appliance with us and the parts being fitted by one of our authorised engineers. There will be a charge for our engineer's time. To activate the extra parts warranty on your appliance, simply call our registration line on **08448 24 24 24 (Republic of Ireland 01 230 0800)**.

## Extended Guarantees

We offer a selection of repair protection plans that enable you to fully cover yourself against the expense of repair bills for the life of your policy. To find the ideal plan for you please call our advice line on **08448 226 226 (Republic of Ireland 01 230 0233)**.

## Free Helpdesk Service

We have a dedicated team who can provide free advice and assistance with your appliance if you experience any technical difficulties within the first 90 days of ownership. Simply call our Indesit Service Hotline on **08448 224 224 (Republic of Ireland 0818 313 413)** for telephone assistance, or, where necessary, to arrange for an engineer to call.

## After Sales Service

No one is better placed to care for your Indesit appliance during the course of its working life than us - the manufacturer.

## Essential Contact Information

### Indesit Service

We are the largest service team in Europe offering you access to 400 skilled telephone advisors and 1100 fully qualified engineers on call to ensure you receive fast, reliable, local service.

**UK: 08448 224 224**  
**Republic of Ireland: 0818 313 413**  
**[www.indesitservice.co.uk](http://www.indesitservice.co.uk)**

**Please note: Our advisors will require the following information:**

**Model number:**

**Serial number:**

### Parts and Accessories

We supply a full range of genuine replacement parts as well as accessory products that protect and hygienically clean your appliance to keep it looking good and functioning efficiently throughout its life.

**UK: 08448 225 225**  
**Republic of Ireland: 0818 313 413**  
**[www.indesitservice.co.uk](http://www.indesitservice.co.uk)**

### Appliance Registration

We want to give you additional benefits of Indesit ownership. To activate your free 5 year parts guarantee you must register your appliance with us.

**UK: 08448 24 24 24**  
**Republic of Ireland: 01 230 0800**  
**[www.indesitservice.co.uk](http://www.indesitservice.co.uk)**

**Indesit Company UK Ltd. Morley Way, Peterborough, PE2 9JB**  
Indesit Company Unit 49 Airways Industrial Estate, Dublin 17



## Recycling & Disposal Information

As part of Indesit's continued commitment to helping the environment, Indesit reserves the right to use quality, recycled components to keep down customer costs and minimise material wastage.

Please dispose of packaging and old appliances carefully. To minimise the risk of injury to children, remove the door, plug and cut the mains cable off flush with the appliance. Dispose of these parts separately to ensure that the appliance can no longer be plugged into a mains socket, and the door cannot be locked shut.



## Free Manuals Download Website

<http://myh66.com>

<http://usermanuals.us>

<http://www.somanuals.com>

<http://www.4manuals.cc>

<http://www.manual-lib.com>

<http://www.404manual.com>

<http://www.luxmanual.com>

<http://aubethermostatmanual.com>

Golf course search by state

<http://golfingnear.com>

Email search by domain

<http://emailbydomain.com>

Auto manuals search

<http://auto.somanuals.com>

TV manuals search

<http://tv.somanuals.com>