

WDG 1295

## Washer-dryer

Instructions for installation  
and use



**Thank you for choosing an Indesit product. This washer-dryer is reliable and easy to use. We suggest you read your owner's manual carefully. This will help you become familiar with your washer-dryer and its functions in order to obtain years of trouble free performance.**

## **Double-action wash**

Clothes are soaked in water and detergent, water then "rains" steadily through the clothes.

## **Saves while it washes**

The double action wash penetrates so deeply that at just 60°C you obtain the same results you would normally obtain at 90°C with a traditional washer.

# **Safety, a good habit to get into**

## **CAUTION**

**Please read the instructions in this handbook carefully, as they contain important information about safe installation, operating and servicing.**

**This washer-dryer is manufactured in compliance with international safety regulations designed to safeguard the consumer.**

1. This appliance is designed to be used indoors and under no circumstances should it be installed outside.
2. This appliance should only be used in a domestic environment by a responsible person to wash household laundry according to the instructions.
3. Under no circumstances should children be allowed to operate or tamper with this product.
4. Beware, this appliance is heavy, do not attempt to move it, unless you are able to do so.
5. Before the introduction of a new wash load into the machine, please ensure all previous items have been removed.
6. For electrical safety do not attempt to operate this machine with wet hands or feet.
7. Do not operate this appliance connected to an extension lead. If a longer supply cable is required this must be replaced with one of the same specifications in compliance with the current electrical regulations. This operation should be carried out by a qualified person.
8. After putting in the detergent, ensure the soap drawer is fully closed before operating the appliance. Only automatic detergent should be used, or too many suds will be produced and damage may occur to internal parts.
9. Do not pull the supply cable to disconnect the plug from the wall socket.

**10.** Beware that during the wash cycle the door glass can become hot. Children should not be left unsupervised whilst the appliance is in operation. During operation the door is locked at all times. On each stop position the door will release after an approximate 3 minute time delay. Do not attempt to open the door before this time otherwise damage may occur to the door release mechanism.

# Overview

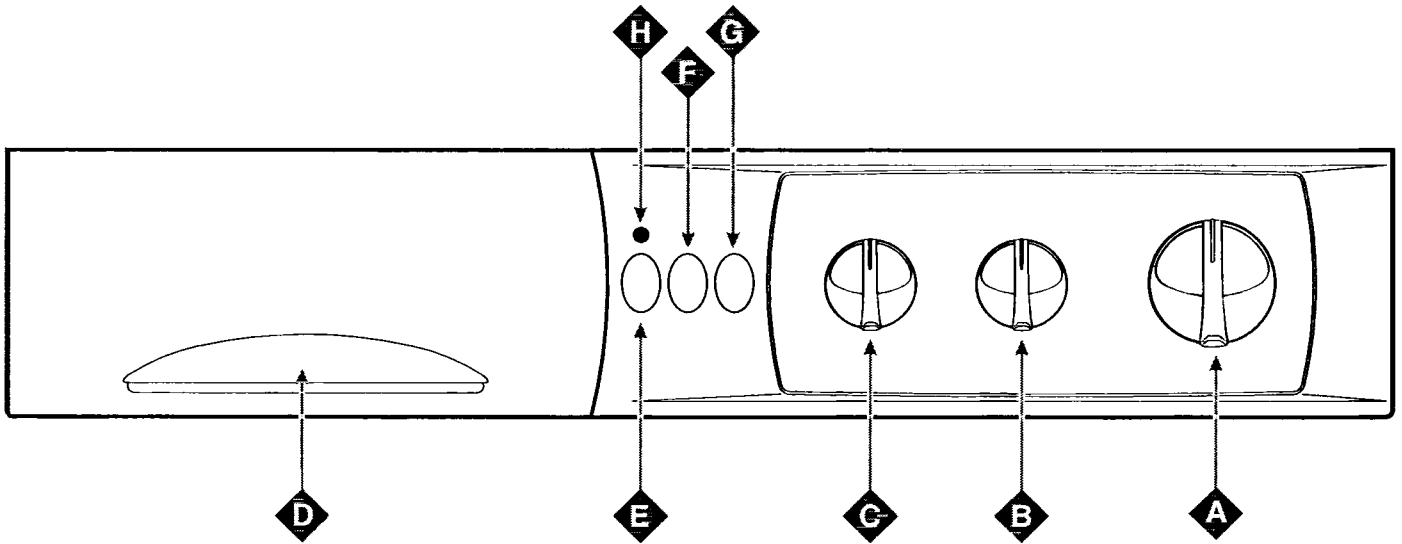

## A. Programme selector

Use this dial to select one of the 18 wash programmes available for all your laundry requirements (see programme table on page 6).

**Remember that this dial should be turned in a clockwise direction and only when the machine is off.**

## B. Dry programme selector

This knob allows you to select the most appropriate drying cycle for the type of fabric. Two separate cycles are available:

up to 120 min. for fast fabrics (**right sector**)

up to 80 min. for synthetic fabrics (**left sector**)

The cycle for fast fabrics has a cooling period at the end of the cycle itself.

## C. Temperature selector

Use this dial to set the wash temperature shown in the programme table (page 6). You may reduce the recommended wash temperature of the programme you have selected or run a cold wash (symbol ❄).

**Note: When using cycle number 2, do not use temperature settings below 60°C.**

## D. Detergent dispenser

The detergent dispenser has three compartments marked 1, 2 and 3:

- 1 prewash detergent
- 2 wash detergent
- 3 fabric softener.

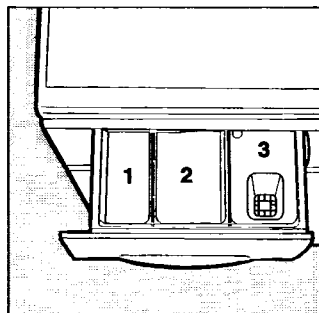

## E. ON-OFF button

This button turns your appliance ON/OFF. Press button E to turn on the washer-dryer and depress button E to turn off the washer-dryer.

## F. ECO-SENSE button

Use this button with programmes for washing linen and cotton. Your washer-dryer will automatically adjust the water and electric energy consumption according to your laundry load. Although this function only operates on the heavy and delicate cycles (not the wool cycle), it is not recommended to use this function for the delicate cycle.

## G. Rinse Hold button

This function interrupts the cycle so that the laundry is left soaking in water before the spin cycle.

This function is extremely useful because it stops delicate or synthetic fabrics from creasing (for example when one has to wait several hours before removing the laundry load). It should be used only with the programmes for synthetic fabrics and woollens.

**IMPORTANT:** Before opening the door, drain away the water by setting knob A on "drain". To carry out the spin cycle, simply press G.

## H. ON/OFF Indicator light

When this is lit, the machine is on.

# Using your washer

## Preparing your laundry....

Divide your laundry by fabric and colour fastness. Wash white and coloured items separately.

Remember to empty pockets, removing especially those small items like coins, paper, pins and badges that might jam the pump. Fasten or remove loose buttons and fasten zippers. Turn shirts inside out for better results.

## Check wash labels

Garments and laundry generally have wash instruction labels (which tell you if they should be dry-cleaned, hand washed or machine washed) showing the wash temperature, how to iron etc.

Important: fabrics should only be machine washed if their labels show the appropriate symbol (see table 1 page 4).

## Alternate small and large items when loading your washer-dryer

This washer-dryer has an electronic load balancing control: before carrying out the spin cycle, this device ensures that the laundry is arranged as evenly as possible in the drum, according to the type of fabric and the way it was initially loaded. This will minimize vibration and noise even during the fastest spin cycle. For best results however, we recommend you alternate small and large items when you load your washer-dryer remember to spread them out; never wash large loads of terry cloth items.

## Detergents and fabric softener

Open detergent dispenser **D** by pulling it outwards. Fill with detergent and conditioner using the quantities indicated by the manufacturer on the packet according to the load you are washing, the water hardness and how soiled your laundry is. As you become more familiar with your washer, you will regulate the quantities according to your own personal experience.

### Compartment 1

Prewash cycle detergent  
(powder)

### Compartment 2

Wash cycle detergent  
(powder or liquid)

### Compartment 3

Fabric softener

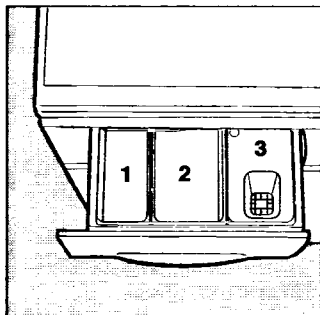

*Never fill compartment 3 above the grid.*





































Use compartment 2 for liquid detergent, filling the compartment just before you start the washer. Remember that liquid detergent is ideal for wash cycles with temperatures up to 60°C and for the programmes with no prewash cycle. Dispensers for liquid and powder detergents which are placed inside the drum of the washer, are sold on the market.

To improve the effectiveness of the washing cycle, we recommend that you insert a detergent dispenser in the drum before loading the laundry.

*Do not use hand washing detergents since these produce very heavy suds.*

*When using cold wash cycles, remember to reduce the detergent dosage.*

## 1. Understanding the labels

 <b>Wash</b>	<i>Strong action</i>	 Wash at 95°C	 Wash at 60°C	 Wash at 40°C	 Wash at 30°C	 Hand wash	 Not washable in water
	<i>Delicate action</i>	 Wash at 95°C	 Wash at 60°C	 Wash at 40°C	 Wash at 30°C	 Hand wash	 Not washable in water
 <b>Bleaching</b>		 Bleaching only in cold water	 Do not bleach				
 <b>Ironing</b>		 Hot iron at max 200°C	 Medium hot ironing at max 150°C	 Iron at max 100°C	 Not ironable		
 <b>Dry cleaning</b>		 Dry clean with any solvent	 Dry clean only with, perchloride, benzene av., pure alcohol, R111 and R113	 Dry clean with av. benzene, pure alcohol and R113		 Do not dry clean	
 <b>Drying</b>	<i>High Temperat.</i>	 Machine dryable	 Do not machine dry	 Spread to dry	 Hang to dry without spin drying	 Dry on clothes hanger	
	<i>Low Temperat.</i>	 Machine dryable	 Do not machine dry	 Spread to dry	 Hang to dry without spin drying	 Dry on clothes hanger	

## Starting up your washer-dryer

Run the first wash without laundry using programme 2 at 90°C.

### Wash only

Load your laundry in the washer-dryer, add the detergent and fabric softener (see pages 3) and remember to:

- shut the door properly
- plug the washer-dryer in at the mains
- turn on the water supply
- the knob **B** is on STOP ●
- check that button **E** is not pressed in (position **O**)

### Selecting the programme

The table on pages 6 will help you choose the right programme. Turn dial **A** to the programme number you have chosen. Set the temperature on dial **C** and, if necessary, press function button (**F**, **G**); set ON/OFF button **E** to position **I** (ON).

### At the end of the wash cycle...

To turn off the washer-dryer press the ON-OFF button **E** and wait approximately 3 minutes before opening the door. Once

you have removed your clean laundry from the washer-dryer, remember to leave the door open or at least ajar (this will prevent the formation of an unpleasant odour) and shut off the water supply.

### Drying only

**The glass part of the door becomes hot during the drying cycle and reaches very high temperatures. Avoid touching the glass or coming into contact with it.**

### Maximum drying loads

heavy fabrics maximum 2.5 Kg  
 mixed fabrics maximum 2 Kg  
 synthetics maximum 1.5 Kg

Load the laundry you wish to dry (max. 2.5 Kg) and check:

- that the door is firmly shut
- the plug is in the socket
- the water tap is open
- the button **E** is not pressed (position **O**)

## Now select the programme

Turn knob **A** to one of the two settings , select the drying time required with knob **B** (table 2 on page 5) and then press on/off button **E** (position **I**).

## At the end of the drying cycle...

Turn off the tumble dryer by pressing on/off button **E** and wait at least 3 minutes before opening the door. Remove the laundry and leave the door ajar to prevent the formation of bad odour; remember to turn off the water tap.

This appliance has two drying programmes to ensure best drying results and to prevent damage to your laundry: the first is for heavy fabrics (**right hand section**) from 0 to 120 min. and the second is for synthetic fabrics (**left hand section**) from 0 to 80 min. For smaller loads than those shown in the table, remember to reduce the drying time proportionally. Until you become familiar with your appliance, we suggest you programme shorter drying times than those indicated and to check that your laundry is quite dry at the end of the cycle. If not, simply shut the door and set extra drying time. This will allow you to acquire your own personal experience on drying times and will avoid over-dry laundry which is difficult to iron.

2.

Fabric	Load	Max. Load (Kg)	Drying knob sector	Drying time (Minutes)	
				Humid	Dry
Cotton, linen	Laundry of different sizes	2,5	Right	100	110
Cotton	Only terry towels	2,3	Right	100	110
Terital, cotton	Sheet and/or shirts	1,5	left	-	70
Acrylics	Pyjamas, socks, etc.	1	left	-	60
Nylon	Petticoats, stockings, etc.	1	left	-	40

## Washing and drying

**The glass part of the door becomes hot during the drying cycle and reaches very high temperatures. Avoid touching the glass or coming into contact with it.**

If you want to wash and dry a laundry load that is not above the maximum load shown (table 2 on page 5), you should follow the steps in the paragraph **washing only** but remember to set the drying time as well with knob **B** before pressing on/off button **E** (position **I**). In this way the appliance passes automatically from the washing cycle to the drying cycle.

If the laundry load you want to wash and dry is above the maximum (table 2 on pag. 5), follow the steps described in the paragraph **washing only**.

At the end of the wash cycle, remove the laundry, divide the laundry and return a part of the load in the appliance.

Now follow the steps described in the paragraph **drying only**.

Repeat the same steps for the remaining part of the laundry load.

**Important:** woollens may not be machine dried since the drying temperature would damage them.

Never dry items that have been laundered with inflammable solvents (es. trichloroethylene).

Do not dry items containing foam rubber or similar elastomers.

Check that the water tap to which the supply pipe of the appliance is connected, is open during the drying cycle.

This appliance must be used only for laundry washed in water.

# Selecting the programmes

The description of the wash programme by type of fabric is shown on the detergent dispenser.

Fabrics and degree of dirtiness	Program. knob	Temperat. knob	Prewash detergent	Wash detergent	Softner	Description of wash cycle
<b>COTTONS</b>						
Heavily soiled white laundry (sheet, table cloths. etc.)	1	MAX	◆	◆	◆	Warm prewash, wash at 90°C, rinse cycles, softener, spin cycle
Very soiled white fabrics and fast colours (coloured laundry, dressing gowns, vests, etc.)	2	MAX		◆	◆	Wash at 90°C, rinse cycles, softener, spin cycle
Lightly soiled white fabrics and resistant colours (coloured laundry, shirts etc.)	3	60°C		◆	◆	Wash at 60°C, rinse cycles, softener, spin cycle
Non fast colours (shirts, vests, dresses, etc.)	4	40°C		◆	◆	Wash at 40°C, rinse cycles, softener, spin cycle
Rinse cycles	5				◆	Rinse cycles, softener, spin cycles
Softner	6				◆	Rinse cycles, softener, spin cycles
Spin	7					Strong spin
Drying cycle for natural fibres	●					
<b>SYNTHETICS</b>						
Colour fast synthetics	8	60°C		◆	◆	Wash at 60°C, rinse cycles, softener, non crease or delicate spin
Normally soiled colour fast synthetics (bouses, skirts, etc.)	9	50°C		◆	◆	Wash at 50°C, rinse cycles, softener, non crease or delicate spin
Non fast coloured synthetics (all kinds of slightly soiled laundry)	10	40°C		◆	◆	Wash at 40°C, rinse cycles, softener, non crease or delicate spin
Rinse cycles	11				◆	Rinse cycles, softener, non crease, spin cycles
Softner	12				◆	Rinse cycles, softener, non crease, spin cycles
Spin	13					Delicate spin cycle
Drying cycle for synthetic fibres	●					
<b>DELICATE FABRICS</b>						
Woollens (machine washable)	14	40°C		◆	◆	Wash at 40°C, rinse cycles, softener, non crease or delicate spin
Rinse cycles	15				◆	Rinse cycles, softener, non crease, spin cycles
Softner	16				◆	Rinse cycles, softener, non crease, spin cycles
Spin	17					Delicate spin
Drain	18					Drain with no spin



# Washing tips

www.somanuals.com

## Stain removal

The most common stains will disappear during the wash. If they are particularly stubborn, soak the garment in water and rub a little detergent onto the stain before putting it in the washer-dryer.

Greasy marks (especially old ones) need treating with a stain-remover. Be careful not to mark the fabric with remover.

## Pre-treatment for awkward stains

- Ink: ball point/felt tip; Put a few drops of nail varnish remover or surgical spirit onto a piece of cotton wool and dab the stain. Wash at 90°C (NB. This is only suitable for colourfast cottons)

- Tar and oil; Scrape off any thick tar or oil on the surface. Soften the remainder with margarine or butter and wipe away with a clean cloth. Treat any residual stain with turpentine, then wash according to the fabric

- Wax; Scrape off, then put the stained garment between two pieces of blotting paper and press with a hot iron. Dab the stain immediately with cotton wool dipped in turpentine

- Chewing gum; Apply nail varnish remover to the gum, then remove it carefully

- Lipstick; Pretreat with a liquid detergent using the dosing ball, rub vigorously and rinse before washing

- Grass; Soak in a warm washing solution using a biological washing product, then wash according to the fabric. Alternatively, saturate the stain with white methylated spirit. Rinse and wash normally

- Paint: Water based latex, acrylic and school paints, emulsion paints; Treat stains while still wet. Rinse thoroughly under running water to flush out the paint, then wash according to the fabric.

Oil based paint/varnish; Sponge with white spirit or paint brush cleaner before washing in the normal way.

## Do not exceed the recommended weights shown in the table

For best washing results, do not exceed the recommended weights shown in the table; the weights shown refer to dry laundry.

Maximum dry laundry load	How heavy is your laundry?
heavy fabrics maximum 5 kg	1 sheet 400-500 g
delicate fabrics maximum 2 kg	1 pillow case 150-200 g
pure new wool maximum 1 kg	1 table cloth 400-500 g
mixed loads maximum 2,5 kg	1 bathrobe 900-1200 g
	1 bathroom towel 150-250 g

## What not to wash in your appliance?

- Torn, frayed or unhemmed items; in order to wash items of this kind, wrap them in a linen bag to prevent them from tearing during the wash.

- Dark coloured items with white items. Dark items should be washed separately.

## Curtains

Curtains tend to crease badly. Try this washing hint to prevent creases: fold the curtains carefully and place in a pillow case or loose mesh bag; wash separately ensuring that the weight is no more than a half wash load.

## Quilts, tennis shoes and wind-cheaters

Contrary to common belief, goose or duck down quilts and wind-cheaters, can in fact be machine washed, provided the instructions shown on the label are followed carefully. Remember however to load no more than 2-3 kg of laundry and to repeat the rinse cycle once or twice following with a gentle spin. In the case of tennis shoes, wipe off mud and then machine wash with denims or heavy fabrics (but not white fabrics).

## Energy saving hints

- Try to wash complete laundry loads: this saves unnecessary consumption of water and energy.
- Select the right programme for your laundry: this will obviously depend on the type of fabric and how soiled your laundry is; we recommend the use of programmes without prewash which will save you time, water and energy. The prewash cycle should in fact be used only for heavily soiled, cotton fabrics.
- Set the right temperature: use temperatures above 60°C only for very stubborn dirt but remember that modern detergents are very efficient even at low temperatures.
- Use the correct quantities of detergent: do not use too much detergent; remember that not only will this make rinsing more difficult but also pollutes the environment.
- Use the economy buttons: when washing small laundry loads use the Economy button if available on your washer-dryer and reduce the detergent quantity.

- Your washer-dryer features automatic consumption control, this means that you can wash laundry loads from 1 - 5 kg with considerable savings. Your washer-dryer will use just the right amount of water and electricity. All you need to do is dose the detergent.
- Fabric softeners: always use a softener; not only do these perfume and soften your laundry, they also make it easy to iron, saving you time.

## General maintenance

### After every wash

Leave the door open and wipe the door gasket dry after each wash so that damp or odours do not form.

### Remove the plug

Before cleaning or servicing always remove the plug from the socket. This is for safety reasons.

### No solvents or abrasive substance

You do not need solvents or abrasive substances to clean the outside of the washer-dryer and the rubber parts. Just use a cloth, warm water and soap.

### Detergent dispenser drawer

This can be removed and cleaned. Just pull it towards you, as shown in the diagram, and leave it under running water for a few minutes.

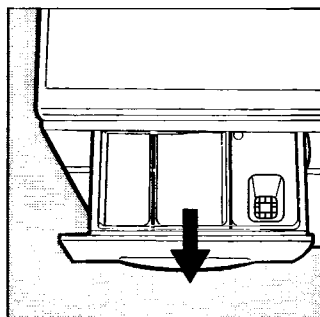

### Unplug the machine when you go away

It's best to unplug the machine when you go away, turn off the water supply and leave the machine door open or ajar. The drum and rubber door lining will dry and no unpleasant odours will form inside.

### When moving house

When you move, all you need to do is secure the inside of the machine with the transit screws (supplied with the packaging of the machine) so that it will not be damaged.

### Cleaning and special servicing

#### Hose

Check the hose once a year. It should be replaced if any signs of splitting or damage can be seen. The machine is under a lot of strain while operating and this may cause a cracked hose to split open suddenly.

#### Inspecting the drain pump

Your washer-dryer has a self-cleaning pump and therefore requires no cleaning or maintenance. Remember however that small items such as buttons or coins may accidentally fall into the pump. To remove these items, the pump comes equipped with an "prechamber" which is accessible from the front of the pump. To gain access to this prechamber simply remove the panel located on the bottom part of the washer-dryer (*figure 1*), place it on the ground near the machine (*figure 2*), and remove the lid by turning it in the counter clockwise direction. Carefully inspect the inside of the pump.

**Important:** before removing the lid check that the wash cycle has ended and unplug the washer-dryer from the mains. It is normal for a small quantity of water to spill out once the lid is removed. The panel positioned at the base of the machine will catch the water that spills out. Remember to shut the lid firmly when you replace it.

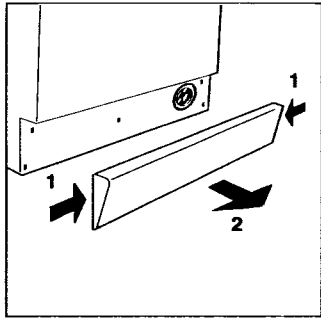

Fig. 1

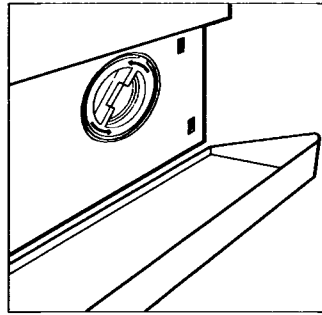

Fig. 2

## Removing limescale

Water contains increasing amounts of limescale because of pollution. If you live in a hard water area in addition to using water-softener in each wash, it is a good idea to put the machine through a cycle without laundry or detergent, just using limescale remover.

## Trouble shooting

If the machine does not seem to be working properly before calling the service engineer there are a number of things you can check. Perhaps you have forgotten to push in a button or you are not using the machine properly.

### Machine won't start

**Make sure:**  
the appliance is plugged to the mains socket; you have electricity in your home, the door is firmly shut, the ON/OFF button **E** is on **I**, the programming cycle knob, in washer-dryers which have one, is on **O**, the programme is properly set and the mains water tap is open.

### Machine won't fill

**Make sure:**  
the water tap is open and connected correctly to the hose; the water mains has not been cut off and that water pressure is sufficient; also check the hose for kinks.

### Water is pumping in and out all the time

**Make sure:**  
there are no kinks in the drain pipe and that it is at least at a height of 60-100 cm; the pipe mouth is not below water level and that the wall drain has no air outlet. If the problems continue even after you have checked these points, shut the water tap and turn off your washer-dryer.

### Problems with pumping out water or spinning

**Make sure:**  
the programme selected has a draining cycle; the non creasing "hydropstop" button, on washer-dryers which have one, has not been pressed accidentally; the drainage pump is not jammed; the drain pipe is bent; the drainage piping is plugged; any drainage pipe extensions are properly connected and do not prevent water flow.

### The washer-dryer is not drying

**Make sure:**  
the plug is inserted properly into the socket; there is electricity in the house; the washer-dryer door is closed; the ON-OFF button **E** is on the **I** setting; the programming cycle knob, in washer-dryers which have one, is on the **O** setting; the program knob **A** is on the **☉** setting; the dryer knob **B** is on the **O** setting.

### Lots of vibration during the spin

**Make sure:**  
the internal oscillating unit was released correctly at the time of installation (see installation instructions); the washer is levelled correctly or too tightly fitted between furniture units and the wall.

### Your washer is leaking.

**Make sure:**  
the ring nut of the supply pipe is firmly tightened; the detergent dispenser is not plugged and the drainage pipe is firmly fixed.

### Excessive formation of suds.

**Make sure:**  
the type of detergent you have used - is it suitable for an automatic washer - have you used too much detergent?

### The washer-dryer is not drying efficiently.

**Make sure:**  
the end of the drain hose is not immersed in water; the drain pump is not blocked (see "General maintenance"); the advice on maximum loads and drying times have been followed; the drying time selected is at least 20 minutes; the water tap is turned on.

If despite all this your washer-dryer is still not running properly, call your local **Authorized Service Centre** providing the following information:

- fault
- model code (Mod. ....)  
and serial number (S/N ....)  
shown on the data plate at the back of your washer.

*Never use the services of an unauthorised servicing technician and insist on the use of original spare parts.*

## Installation

### Transit packing

After removing the packing, check the appliance for damage. If you have any doubts do not use the washer and call a qualified technician. Keep the packaging components (plastic bags, polyester foam, nails etc.) out of the reach of children since they could be dangerous. The interior of the washer-dryer, has an oscillating unit which is fixed on the back by 3 screws during transport (*figure 3*). Before starting up the washer-dryer, release the unit, by unscrewing the 3 screws. Seal the screw holes with the plastic plugs supplied with the appliance.

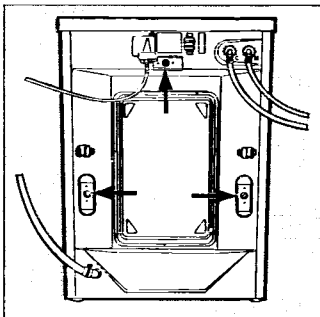

Fig. 3

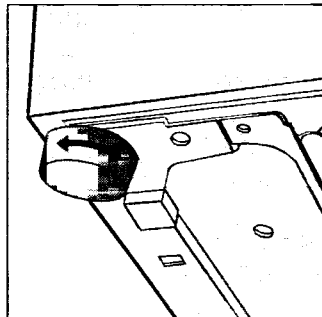

Fig. 4

### Levelling

The washer-dryer must be perfectly levelled. To level the appliance, only the front feet need to be adjusted (*see fig. 4*); remember that the inclination of the working surface must not be more than 2 degrees. If the washer-dryer is installed on a carpeted floor, check that there is sufficient ventilation space between the floor and the bottom of the washer-dryer.

### Water supply

Both hot and cold water supplies are preferable and they should be between 34.5kN/m<sup>2</sup>(5lb/in<sup>2</sup>) and 1034.2kN/m<sup>2</sup> (150lb/in<sup>2</sup>) pressure. The hose having the **red** end fitting should be encountered between the **hot** supply and the

threaded connection adjacent to the letter **H** on the rear of the machine. The hose having the **white** end fittings should be connected between the **cold** supply and the threaded connection adjacent to the letter **C** on the rear of the machine (*see fig. 5*). Remember to insert a sealing washer at each connection to ensure watertight joints. **Do not overtighten** the connections by using tools -hand tight is sufficient to prevent leaks. It is generally more convenient to have these supplies away from the sink taps. Where no suitable hot water supply is available or it does not meet these requirements, both inlet hoses may be connected to a cold supply by using two taps etc., or a «T» junction on the plumbing (*see fig. 6*) however, use of cold water only will increase programme times.

**Note:** the maximum temperature should not exceed 70°C (158°F).

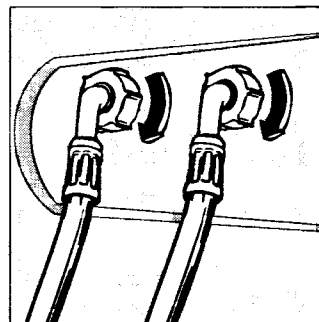

Fig. 5

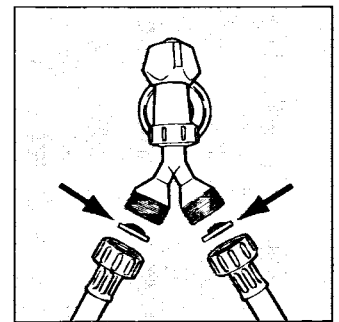

Fig. 6

### Drain hose

The drain hose (hooked pipe) is secured to the rear of the machine by support clips and may be routed to right or left as required (*see fig. 7*). The drain hose should be placed in a stand pipe with a minimum internal diameter of 38 mm (1½ inches) or it can be positioned over a sink (*see fig. 8*) or it can be connected as shown in *fig. 9*. The height of stand pipe or sink should be between 60 and 100 cm (24 and 40 inches). Care must be taken that the hose is not obstructed, twisted, submerged or kinked. If the hose is connected with an airtight joining, provision should be made to prevent syphoning.

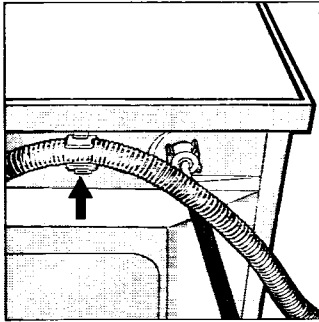

Fig. 7

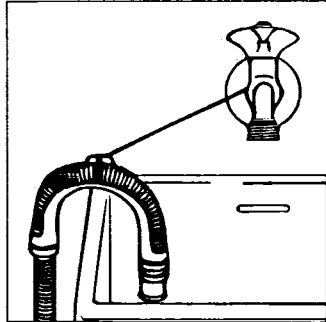

Fig. 8

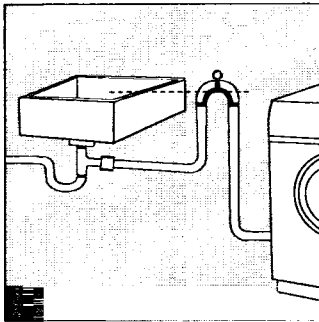

Fig. 9

### Electrical connection (figure 10)

Your appliance is now supplied with a 13 amp fused plug it can be plugged into a 13 amp socket for immediate use. Before using the appliance please read the instructions below.

**WARNING - THIS APPLIANCE MUST BE EARTHED.**  
THE FOLLOWING OPERATIONS SHOULD BE CARRIED OUT BY A QUALIFIED ELECTRICIAN.

#### Replacing the fuse:

When replacing a faulty fuse, a 13 amp ASTA approved fuse to BS 1362 should always be used, and the fuse cover refitted. If the fuse cover is lost, the plug must not be used until a replacement is obtained.

#### Replacement fuse covers:

If a replacement fuse cover is fitted, it must be of the correct colour as indicated by the coloured marking or the colour that is embossed in words on the base of the plug. Replacements can be obtained directly from your nearest Service Depot.

#### Removing the plug:

If your appliance has a non-rewireable moulded plug and you should wish to re-route the mains cable through partitions, units etc., please ensure that either:  
the plug is replaced by a fused 13 ampere re-wearable plug bearing the BSI mark of approval.

or:

the mains cable is wired directly into a 13 amp cable outlet, controlled by a switch, (in compliance with BS 5733) which is accessible without moving the appliance.

#### Disposing of the plug:

Ensure that before disposing of the plug itself, you make the pins unusable so that it cannot be accidentally inserted into a socket.

#### Instructions for connecting cable to an alternative plug:

**Important:** the wires in the mains lead are coloured in accordance with the following code:

Green & Yellow	<b>Earth</b>
Blue	<b>Neutral</b>
Brown	<b>Live</b>

As the colours of the wires in the lead may not correspond with the coloured markings identifying the terminals in your plug, proceed as follows:

Connect Green & Yellow wire to terminal marked **E** or or coloured Green or Green & Yellow.

Connect Brown wire to terminal marked **L** or coloured Red.

Connect Blue wire to terminal marked **N** or coloured Black. If a 13 amp plug (BS 1363) is used it must be fitted with a 13 amp fuse, either in the plug or adaptor or at the distribution board.

If you are in any doubt the electrical supply to your machine, consult a qualified electrician before use.

#### How to connect an alternative plug:

The wires in this mains lead are coloured in accordance with the following code:

BLUE	<b>NEUTRAL (N)</b>
BROWN	<b>LIVE (L)</b>
GREEN & YELLOW	<b>EARTH (E)</b>

#### Disposing of the appliance:

When disposing of the appliance please remove the plug by cutting the mains cable as close as possible to the plug body and dispose of it as described above.

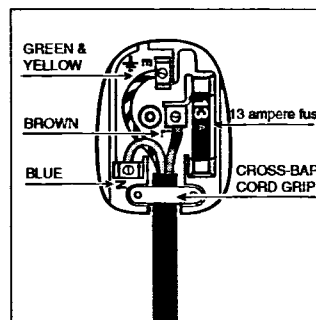

Fig. 10

# Technical characteristics

---

<b>model</b>	WDG 1295
<b>dimensions</b>	width cm 59,5 height cm 85 depth cm 55
<b>capacity</b>	1 - 5 Kg
<b>electrical connections</b>	voltage 240 Volt 50Hz maximum absorbed power 2300 W
<b>water connections</b>	maximum pressure 100 N/cm <sup>2</sup> minimum pressure 5 N/cm <sup>2</sup> drum capacity 42 litres
<b>spinning speed</b>	up to 1150 rpm

---



This appliance conforms with the following E.E.C. directives:  
- 73/23/EEC of 19/02/73 (Low Voltage) and subsequent modifications  
- 89/336/EEC of 03/05/89 (Electromagnetic Compatibility) and subsequent modifications

---



**Merloni Elettrodomestici spa**

Viale Aristide Merloni 47  
60044 Fabriano  
tel. (0732) 6611 - Italy

## Free Manuals Download Website

<http://myh66.com>

<http://usermanuals.us>

<http://www.somanuals.com>

<http://www.4manuals.cc>

<http://www.manual-lib.com>

<http://www.404manual.com>

<http://www.luxmanual.com>

<http://aubethermostatmanual.com>

Golf course search by state

<http://golfingnear.com>

Email search by domain

<http://emailbydomain.com>

Auto manuals search

<http://auto.somanuals.com>

TV manuals search

<http://tv.somanuals.com>