

Instructions for use

Washer-dryer

 This symbol reminds you to read this instruction manual.

GB

GB

English, 1

GR

Ελληνικά, 15

RO

Română, 29

XWDE 961480

Contents

Installation, 2-3

Unpacking and levelling
Connecting the electricity and water supplies
The first wash cycle
Technical data

Care and maintenance, 4

Cutting off the water and electricity supplies
Cleaning the washer-dryer
Cleaning the detergent dispenser drawer
Caring for the door and drum of your appliance
Cleaning the pump
Checking the water inlet hose

Precautions and tips, 5

General safety
Disposal
Opening the porthole door manually

Description of the washer-dryer, 6-7

Control panel
Display

How to run a wash cycle or a drying cycle, 8

Wash cycles and options, 9-10

Table of wash cycles
Wash options
Push&Wash+Dry

Detergents and laundry, 11-12

Detergent dispenser drawer
Bleach cycle
Preparing the laundry
Special wash cycles
Load balancing system

Troubleshooting, 13

Service, 14

 **INDESIT**

Installation

GB

! This instruction manual should be kept in a safe place for future reference. If the washer-dryer is sold, transferred or moved, make sure that the instruction manual remains with the machine so that the new owner is able to familiarise himself/herself with its operation and features.

! Read these instructions carefully: they contain vital information relating to the safe installation and operation of the appliance.

Unpacking and levelling

Unpacking

1. Remove the washer-dryer from its packaging.
2. Make sure that the washer-dryer has not been damaged during the transportation process. If it has been damaged, contact the retailer and do not proceed any further with the installation process.

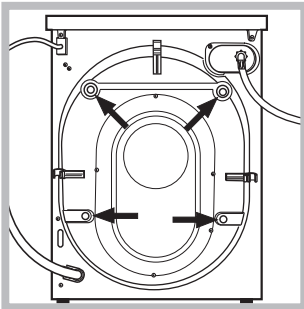

3. Remove the 4 protective screws (used during transportation) and the rubber washer with the corresponding spacer, located on the rear part of the appliance (see figure).

4. Close off the holes using the plastic plugs provided.
 5. Keep all the parts in a safe place: you will need them again if the washer-dryer needs to be moved to another location.
- ! Packaging materials should not be used as toys for children.

Levelling

1. Install the washer-dryer on a flat sturdy floor, without resting it up against walls, furniture cabinets or anything else.

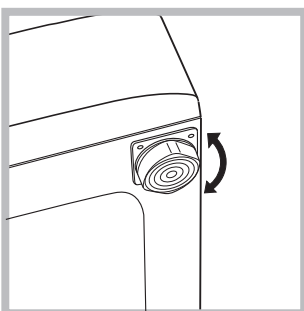

2. If the floor is not perfectly level, compensate for any unevenness by tightening or loosening the adjustable front feet (see figure); the angle of inclination, measured in relation to the worktop, must not exceed 2°.

Levelling the machine correctly will provide it with stability, help to avoid vibrations and excessive noise and prevent it from shifting while it is operating. If it is placed on carpet or a rug, adjust the feet in such a way as to allow a sufficient ventilation space underneath the washer-dryer.

Connecting the electricity and water supplies

Connecting the water inlet hose

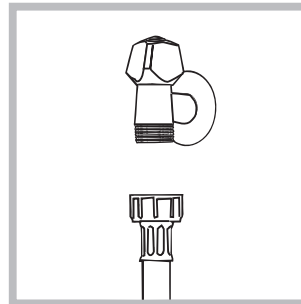

1. Connect the supply pipe by screwing it to a cold water tap using a $\frac{3}{4}$ gas threaded connection (see figure). Before performing the connection, allow the water to run freely until it is perfectly clear.

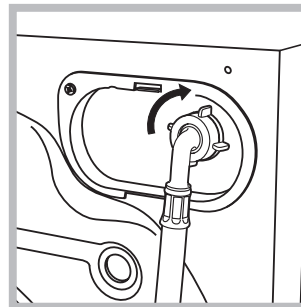

2. Connect the inlet hose to the washer-dryer by screwing it onto the corresponding water inlet of the appliance, which is situated on the top right-hand side of the rear part of the appliance (see figure).

3. Make sure that the hose is not folded over or bent.

! The water pressure at the tap must fall within the values indicated in the Technical details table (see next page).

! If the inlet hose is not long enough, contact a specialised shop or an authorised technician.

! Never use second-hand hoses.

! Use the ones supplied with the machine.

Connecting the drain hose

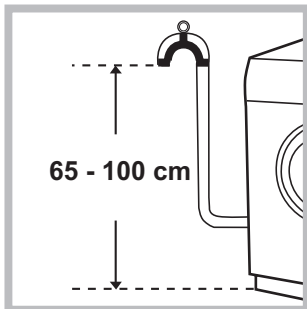

Connect the drain hose, without bending it, to a drainage duct or a wall drain located at a height between 65 and 100 cm from the floor;

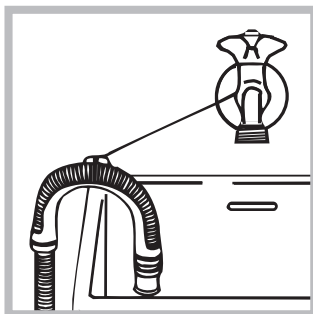

alternatively, rest it on the side of a washbasin or bathtub, fastening the duct supplied to the tap (see figure). The free end of the hose should not be underwater.

! We advise against the use of hose extensions; if it is absolutely necessary, the extension must have the same diameter as the original hose and must not exceed 150 cm in length.

Electrical connections

Before plugging the appliance into the electricity socket, make sure that:

- the socket is earthed and complies with all applicable laws;
- the socket is able to withstand the maximum power load of the appliance as indicated in the Technical data table (see opposite);
- the power supply voltage falls within the values indicated in the Technical data table (see opposite);
- the socket is compatible with the plug of the washer-dryer. If this is not the case, replace the socket or the plug.

! The washer-dryer must not be installed outdoors, even in covered areas. It is extremely dangerous to leave the appliance exposed to rain, storms and other weather conditions.

! When the washer-dryer has been installed, the electricity socket must be within easy reach.

! Do not use extension cords or multiple sockets.



! The cable should not be bent or compressed.

! The power supply cable must only be replaced by authorised technicians.

Warning! The company shall not be held responsible in the event that these regulations are not respected.

The first wash cycle

Once the appliance has been installed, and before you use it for the first time, run a wash cycle with detergent and no laundry, using the wash cycle “Auto Clean” (see “Cleaning the washer-dryer”).

Technical data	
Model	XWDE 961480
Dimensions	width 59.5 cm height 85 cm depth 60,5 cm
Capacity	from 1 to 9 kg for wash programme from 1 to 6 kg for the drying programme
Electrical connections	please refer to the technical data plate fixed to the machine
Water connections	maximum pressure 1 MPa (10 bar) minimum pressure 0.05 MPa (0.5 bar) drum capacity 62 litres
Spin speed	up to 1400 rotations per minute
Energy rated programmes according to regulation EN 50229	wash: programme 8; temperature 60°C; using a load of 9 kg. drying: the smaller load (3kg) must be dried by selecting the “☁” dryness level. The load must consist of 3 sheets, 2 pillowcases and 1 hand towel; the remainder of the load must be dried by selecting the “☀” dryness level.
 	This appliance conforms to the following EC Directives: - 2004/108/EC (Electromagnetic Compatibility) - 2006/95/EC (Low Voltage) - 2012/19/EU

Care and maintenance

GB

Cutting off the water and electricity supplies

- Turn off the water tap after every wash cycle. This will limit wear on the hydraulic system inside the washer-dryer and help to prevent leaks.
- Unplug the washer-dryer when cleaning it and during all maintenance work.

Cleaning the washer-dryer

- The outer parts and rubber components of the appliance can be cleaned using a soft cloth soaked in lukewarm soapy water. Do not use solvents or abrasives.
- The washer-dryer has a "Auto Clean" programme for its internal parts that **must be run with no load in the drum**.

For maximum performance you may want to use either the detergent (i.e. a quantity 10% the quantity specified for lightly-soiled garments) or special additives to clean the washer-dryer. We recommend running a cleaning programme every 40 wash cycles. To start the programme press buttons **A** and **B** simultaneously for 5 seconds (see figure). The programme will start automatically and will last approximately 70 minutes. To stop the cycle press the START/PAUSE button.

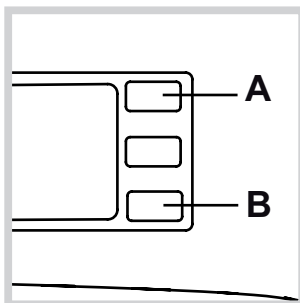

Cleaning the detergent dispenser drawer

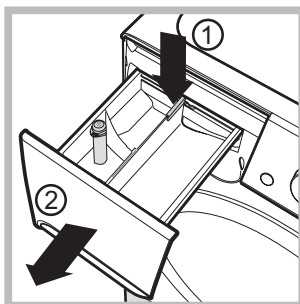

To remove the drawer, press lever (1) and pull the drawer outwards (2) (see figure). Wash it under running water; this procedure should be repeated frequently.

Caring for the door and drum of your appliance

- Always leave the porthole door ajar in order to prevent unpleasant odours from forming.

Cleaning the pump

The washer-dryer is fitted with a self-cleaning pump which does not require any maintenance. Sometimes, small items (such as coins or buttons) may fall into the protective pre-chamber at the base of the pump.

! Make sure the wash cycle has finished and unplug the appliance.

To access the pre-chamber:

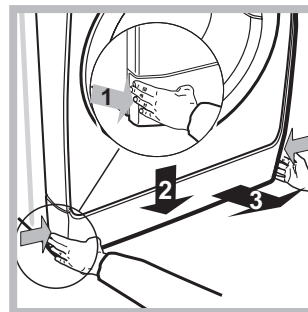

1. Take off the cover panel on the front of the machine by first pressing it in the centre and then pushing downwards on both sides until you can remove it (see figures).

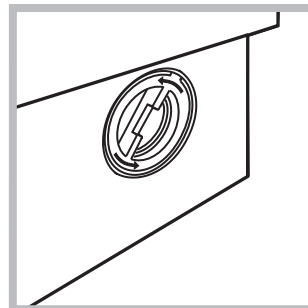

2. Unscrew the lid by rotating it anti-clockwise (see figure): a little water may trickle out. This is perfectly normal.

3. Clean the inside thoroughly.

4. Screw the lid back on.

5. Reposition the panel, making sure the hooks are securely in place before you push it onto the appliance.

Checking the water inlet hose

Check the inlet hose at least once a year. If there are any cracks, it should be replaced immediately: during the wash cycles, water pressure is very strong and a cracked hose could easily split open.

! Never use second-hand hoses.

! This washer-dryer was designed and constructed in accordance with international safety regulations. The following information is provided for safety reasons and must therefore be read carefully.

General safety

- This appliance was designed for domestic use only.
- This appliance is not intended for use by persons (including children) with reduced physical, sensory or mental capabilities, or lack of experience and knowledge, unless they have been given supervision or instruction concerning use of the appliance by a person responsible for their safety. Children should be supervised to ensure that they do not play with the appliance.
 - Do not dry unwashed items in the tumble dryer.
 - Items that have been soiled with substances such as cooking oil, acetone, alcohol, petrol, kerosene, spot removers, turpentine, waxes and wax removers should be washed in hot water with an extra amount of detergent before being dried in the tumble dryer.
 - Items such as foam rubber (latex foam), shower caps, waterproof textiles, rubber backed articles and clothes or pillows fitted with foam rubber pads should not be dried in the tumble dryer.
 - Fabric softeners, or similar products, should be used as specified by the fabric softener instructions.
 - The final part of a tumble dryer cycle occurs without heat (cool down cycle) to ensure that the items are left at a temperature that ensures that the items will not be damaged. **WARNING:** Never stop a tumble dryer before the end of the drying cycle unless all items are quickly removed and spread out so that the heat is dissipated.
- Do not touch the machine when barefoot or with wet or damp hands or feet.
- Do not pull on the power supply cable when unplugging the appliance from the electricity socket. Hold the plug and pull.
- Do not open the detergent dispenser drawer while the machine is in operation.
- Do not touch the drained water as it may reach extremely high temperatures.
- Never force the porthole door. This could damage the safety lock mechanism designed to prevent accidental opening.
- If the appliance breaks down, do not under any circumstances access the internal mechanisms in an attempt to repair it yourself.
- Always keep children well away from the appliance while it is operating.
- The door can become quite hot during the wash cycle.
- If the appliance has to be moved, work in a group of two or three people and handle it with the utmost care. Never try to do this alone, because the appliance is very heavy.
- Before loading laundry into the washer-dryer, make sure the drum is empty.
- During the drying phase, the door tends to get quite hot.
- Do not use the appliance to dry clothes that have been washed with flammable solvents (e.g. trichlorethylene).
- Do not use the appliance to dry foam rubber or similar elastomers.

- Make sure that the water tap is turned on during the drying cycles.

Disposal

- Disposing of the packaging materials: observe local regulations so that the packaging may be re-used.
- The European Directive 2012/19/EU on Waste Electrical and Electronic Equipment, requires that old household electrical appliances must not be disposed of in the normal unsorted municipal waste stream. Old appliances must be collected separately in order to optimise the recovery and recycling of the materials they contain and reduce the impact on human health and the environment. The crossed out “wheeled bin” symbol on the product reminds you of your obligation, that when you dispose of the appliance it must be separately collected. Consumers should contact their local authority or retailer for information concerning the correct disposal of their old appliance.

Opening the porthole door manually

In the event that it is not possible to open the porthole door due to a powercut, and if you wish to remove the laundry, proceed as follows:

1. remove the plug from the electrical socket.

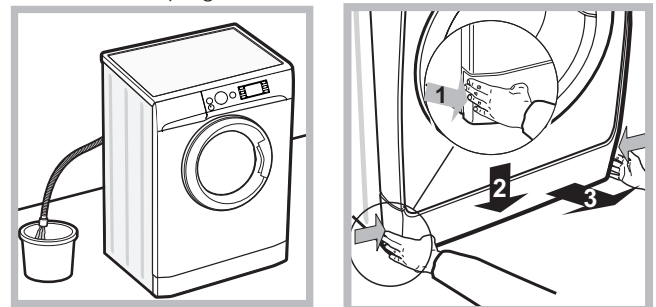

2. make sure the water level inside the machine is lower than the door opening; if it is not, remove excess water using the drain hose, collecting it in a bucket as indicated in the figure.

3. remove the cover panel on the lower front part of the washer-dryer (see figure).



4. pull outwards using the tab as indicated in the figure, until the plastic tie-rod is freed from its stop position; pull downwards and open the door at the same time.
5. reposition the panel, making sure the hooks are securely in place before you push it onto the appliance.

Description of the washer-dryer

GB

Control panel

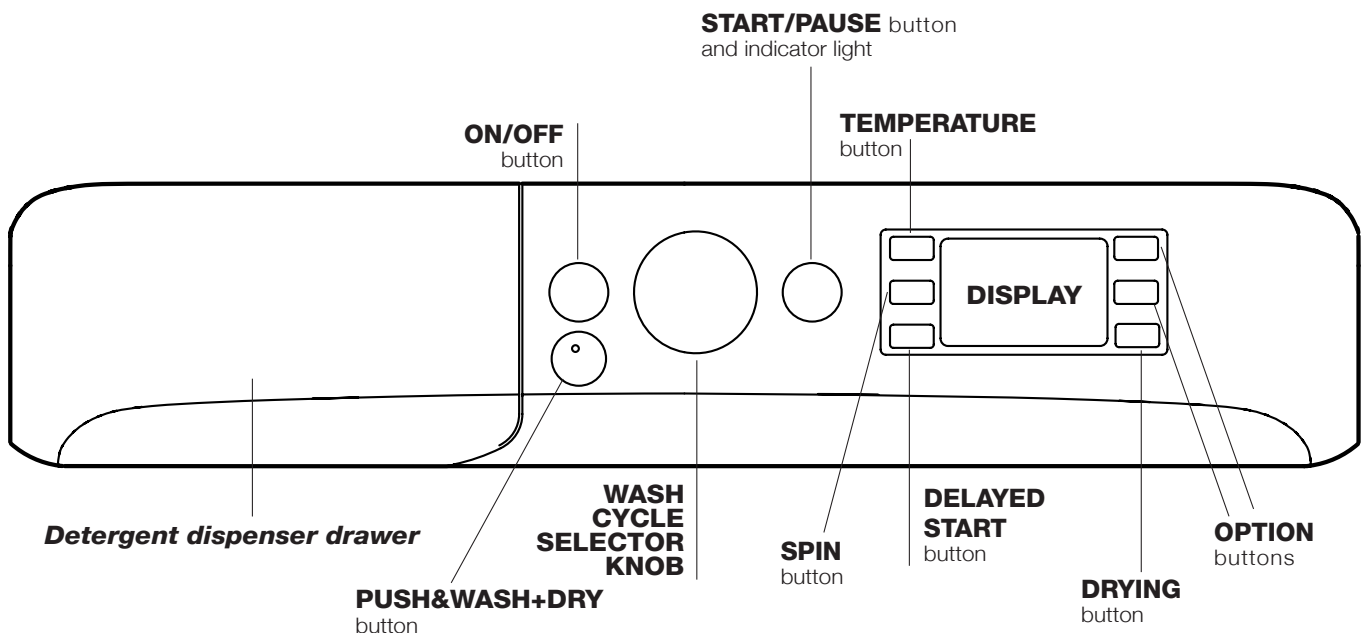

Detergent dispenser drawer: used to dispense detergents and washing additives (see “Detergents and laundry”).

ON/OFF  button: press this briefly to switch the machine on or off. The START/PAUSE indicator light which flashes slowly in a green colour shows that the machine is switched on. To switch off the washer-dryer during the wash cycle, press and hold the button for approximately 3 seconds; if the button is pressed briefly or accidentally the machine will not switch off.

If the machine is switched off during a wash cycle, this wash cycle will be cancelled.

PUSH&WASH+DRY button: (see “Wash cycles and options”).

WASH CYCLE SELECTOR KNOB: used to set the desired wash cycle (see “Table of wash cycles”).



OPTION buttons: press to select the available options. The indicator light corresponding to the selected option will remain lit.

TEMPERATURE  button: press to reduce or completely exclude the temperature; the value appears on the display.

SPIN  button: press to reduce or completely exclude the spin cycle; the value appears on the display.

DELAYED START  button: press to set a delayed start for the selected wash cycle; the delay period appears on the display.

DRYING button : press to decrease or exclude drying; the selected drying level or time will appear on the display (see “How to run a wash cycle or a drying cycle”).

START/PAUSE  button and indicator light: when the green indicator light flashes slowly, press the button to start a wash cycle. Once the cycle has begun the indicator light will remain lit in a fixed manner. To pause the wash cycle, press the button again; the indicator light will flash in an amber colour. If the  symbol is not illuminated, the door may be opened. To start the wash cycle from the point at which it was interrupted, press the button again.

Standby mode

This washer-dryer, in compliance with new energy saving regulations, is fitted with an automatic standby system which is enabled after about 30 minutes if no activity is detected. Press the ON-OFF button briefly and wait for the machine to start up again.

Consumption in off-mode: 0,5 W

Consumption in Left-on: 8 W

Display

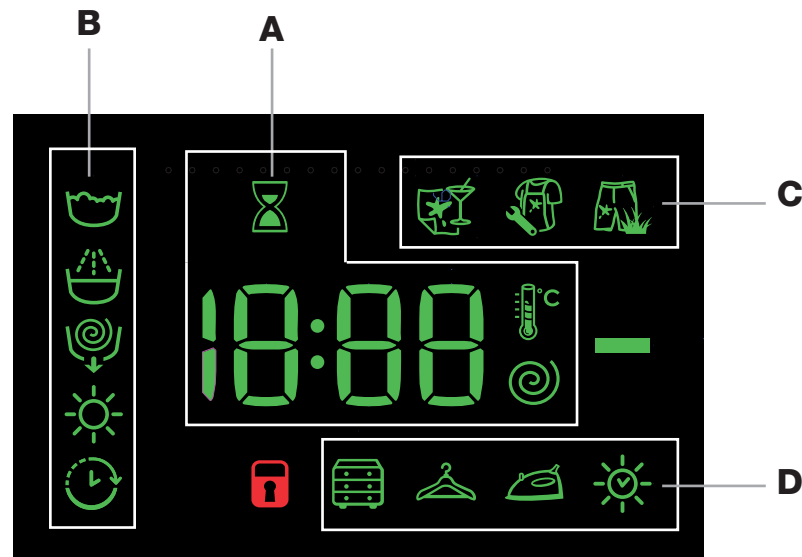

The display is useful when programming the machine and provides a great deal of information.

The duration of the available wash cycles and the remaining time of a running cycle appear in section **A**; if the DELAYED START option has been set, the countdown to the start of the selected wash cycle will appear.

Pressing the corresponding button allows you to view either the maximum spin speed, temperature and drying time values attained by the machine during the set wash cycle, or the values selected most recently (if compatible with the set wash cycle).

The hour-glass flashes while the machine processes the data on the basis of the selected programme. After a maximum of 10 minutes, the hour-glass icon remains lit in a fixed manner and the final amount of time remaining is displayed. The hour-glass icon will then switch off approximately 1 minute after the final amount of time remaining has appeared.

The “wash cycle phases” corresponding to the selected wash cycle and the “wash cycle phase” of the running wash cycle appear in section **B**:

-  Main wash
-  Rinse
-  Spin/Drain
-  Drying

The “delay” symbol , when lit, indicates that the set “delayed start” value has appeared on the display.

There are three levels in section **C** concerning the washing options.

Section **D** includes the icons related to the three different drying levels as well as the icon , which lights up when a timed drying option is set.

DOOR LOCKED indicator light:

The lit symbol indicates that the door is locked. To prevent any damage, wait until the symbol turns off before opening the door.

To open the door while a cycle is in progress, press the START/PAUSE button; if the DOOR LOCKED  symbol is switched off the door may be opened.

How to run a wash cycle or a drying cycle





GB

Rapid programming

1. **LOAD THE LAUNDRY.** Open the porthole door. Load the laundry, making sure you do not exceed the maximum load value indicated in the table of programmes and wash cycles on the following page.
2. **ADD THE DETERGENT.** Pull out the detergent dispenser drawer and pour the detergent into the relevant compartments as described in "Detergents and laundry".
3. **CLOSE THE DOOR.**
4. Press the "PUSH&WASH+DRY" button to start the programme.

Traditional programming

1. **SWITCH THE MACHINE ON.** Press the  button; the START/PAUSE indicator light will flash slowly in a green colour.
2. **LOAD THE LAUNDRY.** Open the porthole door. Load the laundry, making sure you do not exceed the maximum load value indicated in the table of programmes and wash cycles on the following page.
3. **ADD THE DETERGENT.** Pull out the detergent dispenser drawer and pour the detergent into the relevant compartments as described in "Detergents and laundry".
4. **CLOSE THE DOOR.**
5. **SELECT THE WASH CYCLE.** Use the WASH CYCLE SELECTOR knob to select the desired wash cycle. A temperature and spin speed is set for each wash cycle; these values may be adjusted. The duration of the cycle will appear on the display.
6. **CUSTOMISE THE WASH CYCLE.** Use the relevant buttons:

  **Modify the temperature and/or spin speed.** The machine automatically displays the maximum temperature and spin speed values set for the selected cycle, or the most recently-used settings if they are compatible with the selected cycle. The temperature can be decreased by pressing the  button, until the cold wash "OFF" setting is reached. The spin speed may be progressively reduced by pressing the  button, until it is completely excluded (the "OFF" setting). If these buttons are pressed again, the maximum values are restored.

! Exception: if the 8 programme is selected, the temperature can be increased up to a value of 90°C.

Setting the drying cycle

The first time the button  is pressed, the machine will automatically select the maximum drying cycle which is compatible with the selected wash cycle. Subsequent presses will decrease the drying level and then the drying time, until the cycle is excluded completely ("OFF").

Drying may be set as follows:

A- Based on the desired laundry dryness level:

Cupboard : suitable for laundry which can be put back in a cupboard without being ironed.

Hanger : ideal for clothes which do not need to be dried fully.

Iron : suitable for clothes which will need ironing afterwards. the remaining dampness softens creases, making them easier to remove.



B - Based on a set time period: between **210** and **30** minutes

If your laundry load to be washed and dried is much greater than the maximum stated load (see adjacent table of wash cycles), perform the wash cycle, and when the cycle is complete, divide the garments into groups and put some of them back in the drum. At this point, follow the instructions provided for a "Drying only" cycle. Repeat this procedure for the remainder of the load.

Note: a cooling-down period is always added to the end of each drying cycle.

Drying only

Press button  to perform the drying-only cycle.

After selecting the desired cycle (compatible with the type of garments), press button  to exclude the washing phase and start the drying phase at the maximum level for the selected cycle. The drying level or time may be set and changed by pressing the drying button .

(Not compatible with cycles 13 and 14).

Setting a delayed start.

To set a delayed start for the selected cycle, press the corresponding button repeatedly until the required delay period has been reached. When this option has been activated, the  symbol lights up on the display. To remove the delayed start setting, press the button until the text "OFF" appears on the display.



Modify the cycle settings.

- Press the button to enable the option; the indicator light corresponding to the button will switch on.
- Press the button again to disable the option; the indicator light will switch off.

! If the selected option is not compatible with the set wash cycle, the indicator light will flash and the option will not be activated.

! If the selected option is not compatible with another previously selected option, the indicator light will flash accompanied by a buzzer (3 beeps), and only the latter option will be activated; the indicator light corresponding to the activated option will turn on.

! The options may affect the recommended load value and/or the duration of the cycle.

7. **START THE WASH CYCLE.** Press the START/PAUSE button. The corresponding indicator light will turn green, remaining lit in a fixed manner, and the door will be locked (the DOOR LOCKED  symbol will be lit). To change a wash cycle while it is in progress, **pause the washer-dryer** using the START/PAUSE button (the START/PAUSE indicator light will flash slowly in an amber colour); then select the desired cycle and press the START/PAUSE button again. To open the door while a cycle is in progress, press the START/PAUSE button; if the DOOR LOCKED  symbol is switched off the door may be opened. Press the START/PAUSE button again to restart the wash cycle from the point at which it was interrupted.
8. **THE END OF THE WASH CYCLE.** This will be indicated by the text "END" on the display; when the DOOR LOCKED  symbol switches off the door may be opened. Open the door, unload the laundry and switch off the machine.

! If you wish to cancel a cycle which has already begun, press and hold the  button. The cycle will be stopped and the machine will switch off.

Table of wash cycles

Wash cycles	Description of the wash cycle	Max. temp. (°C)	Max. speed (rpm)	Drying	Maximum load for drying (Kg)	Detergents				Maximum load for washing (Kg)	Cycle duration
						Prewash	Wash	Fabric softener	Bleach		
Special											
1	Sport	30°	600	●	4	-	●	●	-	4	The duration of the wash cycles can be checked on the display.
2	Dark	30°	800	●	3	-	●	●	-	5	
3	Anti-odour (Cotton)	60°	1000	●	3,5	-	●	●	-	3,5	
3	Anti-odour (Synthetic)	40°	1000	●	3,5	-	●	●	-	3,5	
4	Delicate	30°	0	●	1	-	●	●	-	1	
5	Wool: for wool, cashmere, etc.	40°	800	●	2	-	●	●	-	2	
6	Rapid 30'	30°	800	●	3,5	-	●	●	-	3,5	
Standard											
7	Cottons with Pre-wash: extremely soiled whites.	90°	1400	●	6	●	●	●	-	9	
8	Cotton Standard 60° (1): heavily soiled whites and resistant colours.	60° (Max. 90°)	1400	●	6	-	●	●	-	9	
9	Synthetic: heavily soiled resistant colours.	60°	800	●	4	-	●	●	-	4,5	
10	Coloured (2)	40°	1400	●	6	-	●	●	-	9	
11	Eco Cotton 20°: lightly soiled whites and delicate colours.	20°	1400	●	6	-	●	●	-	9	
12	Eco Synthetic	20°	800	●	6	-	●	●	-	9	
Automatic											
13	Wash&Dry 45'	30°	1400	●	1	-	●	●	-	1	
14	AirFresh	-	-	●	1,5	-	-	-	-	-	
Partials											
	Rinse/Bleach	-	1400	●	6	-	-	●	●	9	
	Spin + Drain	-	1400	●	6	-	-	-	-	9	
	Drain only *	-	OFF	-	-	-	-	-	-	9	

* If you select programme and exclude the spin cycle, the machine will drain only.

The length of cycle shown on the display or in this booklet is an estimation only and is calculated assuming standard working conditions. The actual duration can vary according to factors such as water temperature and pressure, the amount of detergent used, the amount and type of load inserted, load balancing and any wash options selected.

For all Test Institutes:

- 1) Test wash cycle in compliance with regulation EN 50229: select wash cycle 8 with a temperature of 60°C.
- 2) Long wash cycle for cottons: select wash cycle 10 with a temperature of 40.

Wash options

Stain removal

This option allows for selecting the type of dirt so as to optimally adjust the cycle for removing the stains. The following types of dirt can be selected:

- **Food**, for stains caused by foodstuffs and beverages, for example.
- **Work**, for grease and ink stains, for example.
- **Outdoor**, for mud and grass stains, for example.

! The wash cycle duration varies according to the type of selected dirt.

! It cannot be used in conjunction with wash cycles 1-2-3-4-5-6-7-10-11-12-13-14--.

Push&Wash+Dry

This function makes it possible to start an automatic wash and drying cycle either when the machine is off without having to press the ON/OFF button in advance, or after switching on the machine without having activated any button and/or selector (otherwise the Push&Wash+Dry function will be deactivated). To start the Push&Wash+Dry cycle press and hold the button for 2 seconds. The indicator lights up to show that the cycle has started. The wash and drying cycle is ideal for cotton or synthetic fabrics, as it washes them at a temperature of 30° and a maximum spin speed of 1000 rpm. During the drying cycle the maximum temperature is 60°C. At the end of the cycle the residual humidity will be the same as for the “” level. Max recommended load 3 kg.

The time displayed is the maximum time allowed by the Push&Wash+Dry cycle. If the load is lower than the maximum load or most garment are made of synthetic materials, the actual time of the cycle will be shorter.

How does it work?

1. Load the laundry (cotton and/or synthetic garments) and close the door.
2. Pour the detergent and/or additives.
3. Start the cycle by pressing and holding the Push&Wash+Dry button for 2 seconds. The relevant indicator light will turn green and the door will lock (the DOOR LOCKED symbol is lit).
NB: starting the cycle through the Push&Wash+Dry button activates an automatic non-customisable wash and drying cycle recommended for cotton and synthetic fabrics.
4. The automatic cycle can be used only for washing, excluding the drying phase. Press the Push&Wash+Dry button and then the drying button ” level will switch off. Maximum load for washing-only is 4 kg. The cycle cannot be customised further.
To open the door while an automatic cycle is under way, press the START/PAUSE button. If the DOOR LOCKED symbol is off, the door may be opened only during the washing phase. Press the START/PAUSE button again to restart the wash cycle from the point at which it was interrupted.
5. At the end of the wash cycle the word END will light up.

Detergent dispenser drawer

Successful washing results also depend on the correct dose of detergent: adding too much detergent will not necessarily result in a more efficient wash, and may in fact cause build up on the inside of your appliance and contribute to environmental pollution.

! Do not use hand washing detergents because these create too much foam.

! Use powder detergent for white cotton garments, for pre-washing, and for washing at temperatures over 60°C.

! Follow the instructions given on the detergent packaging.

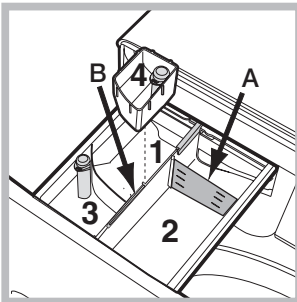

Open the detergent dispenser drawer and pour in the detergent or washing additive, as follows.

Compartment 1: Pre-wash detergent (powder)

Before pouring in the detergent, make sure that extra compartment 4 has been removed.

Compartment 2: Washing detergent (powder or liquid)

If liquid detergent is used, it is recommended that the removable plastic partition **A** (supplied) be used for proper dosage. If powder detergent is used, place the partition into slot **B**.

Compartment 3: Additives (fabric softeners, etc.)

The fabric softener must not exceed the "max" level indicated on the central pin.

Extra compartment 4: Bleach

Bleach cycle

Insert the additional compartment 4 (provided) into compartment 1. In pouring the bleach do not exceed the "max" level indicated on the central pin.

Perform bleaching by pouring the bleach into additional compartment 4 and set the programme .

! Traditional bleach should be used on resistant white fabrics, and delicate bleach for coloured and synthetics fabrics and for wool.

Preparing the laundry

- Divide the laundry according to:
 - the type of fabric/the symbol on the label
 - the colours: separate coloured garments from whites.
- Empty all garment pockets and check the buttons.
- Do not exceed the values listed in the "Table of wash cycles", which refer to the weight of the laundry when dry.

How much does your laundry weigh?

- 1 sheet 400-500 g
- 1 pillow case 150-200 g
- 1 tablecloth 400-500 g
- 1 bathrobe 900-1.200 g
- 1 towel 150-250 g

Special wash cycles

Sport (programme 1) is designed for washing lightly soiled sports clothing (tracksuits, shorts, etc.); for best results, we recommend not exceeding the maximum load indicated in the "Table of wash cycles". We recommend using liquid detergent, and adding the amount suitable for a half-load.

Dark: use programme 2 to wash dark-coloured garments. This programme is designed to maintain dark colours over time. We recommend using a liquid detergent for the best results when washing dark-coloured garments.

When you select the drying function, at the end of the washing cycle the machine will automatically perform a delicate drying cycle that preserves the colours of the garments. The display will show the level "A".

Max. load: 3 kg.

Anti-odour: use programme 3 for washing garments with bad odours (e.g. smoke, sweat, fried food). The programme is designed to remove bad odours while preserving the fabric fibres. Synthetics fabrics or mixed loads should be washed at 40°, and resistant cotton fabrics at 60°.

Delicate: use programme 4 to wash very delicate garments. It is advisable to turn the garments inside out before washing them. For best results, use liquid detergent on delicate garments.

When selecting an exclusively time-based drying function, a drying cycle is performed at the end of the wash cycle that is particularly delicate, thanks to light handling and appropriate temperature control of the water jet.

The recommended durations are:

- 1 kg of synthetic garments --> 150 min
- 1 kg of synthetic and cotton garments --> 180 min
- 1 kg of cotton garments --> 180 min

The degree of dryness depends on the load and fabric composition.

Wool: the wool wash programme of this machine has been tested and approved by The Woolmark Company for the washing of wool containing garments labelled as "hand wash" provided that the garments are washed according to the instructions on the garment label and those issued by the manufacturer of this washer-dryer.

(M1127)



In UK, Eire, Hong Kong and India the Woolmark trade mark is a Certification trade mark.

Rapid 30' (programme 6) this programme is designed to wash lightly soiled garments at 30° (excluding wool and silk) with a 3 kg maximum load in a short time: it only lasts 30 minutes and allows for saving time and energy

Coloured: use this programme 10 to wash bright coloured clothes. The programme is designed to maintain bright colours over time.

Eco Cotton 20° (programme 11) ideal for lightly soiled cotton loads. The effective performance levels achieved at cold temperatures, which are comparable to washing at 40°, are guaranteed by a mechanical action which operates at varying speed, with repeated and frequent peaks.

Eco Synthetic (programme **12**) ideal for mixed loads (cotton and synthetics) with a normal soil level. The effective performance levels achieved at cold temperatures are guaranteed by a mechanical action which operates at varying speed, across set average intervals.

Wash&Dry 45' select programme **13** for washing and drying lightly soiled garments (Cotton and Synthetic) in a short time. This cycle may be used to wash and dry a laundry load of up to 1 kg in just 45 minutes. To achieve optimum results, use liquid detergent and pre-treat cuffs, collars and stains.

AirFresh (programme **14**) ideal cycle to refresh garments and remove bad odours, in particular smoke, from cotton and synthetic items in 30' (max 1.5kg) without the washing phase.

Load balancing system

Before every spin cycle, to avoid excessive vibrations before every spin and to distribute the load in a uniform manner, the drum rotates continuously at a speed which is slightly greater than the washing rotation speed. If, after several attempts, the load is not balanced correctly, the machine spins at a reduced spin speed. If the load is excessively unbalanced, the washer-dryer performs the distribution process instead of spinning. To encourage improved load distribution and balance, we recommend small and large garments are mixed in the load.

Your washer-dryer could occasionally fail to work. Before contacting the Technical Assistance Service (see “Service”), make sure that the problem cannot be solved easily using the following list.

Problem:

Possible causes / Solutions:

The washer-dryer does not switch on.

- The appliance is not plugged into the socket fully, or not enough to make contact.
- There is no power in the house.

The wash cycle does not start.

- The washer-dryer door is not closed properly.
- The ON/OFF button has not been pressed.
- The START/PAUSE button has not been pressed.
- The water tap has not been opened.
- A delayed start has been set.

The washer-dryer does not fill with water (the text “H2O” on the display).

- The water inlet hose is not connected to the tap.
- The hose is bent.
- The water tap has not been opened.
- There is no water supply in the house.
- The pressure is too low.
- The START/PAUSE button has not been pressed.

The washer-dryer continuously takes in and drains water.

- The drain hose is not fitted at a height between 65 and 100 cm from the floor (see “Installation”).
- The free end of the hose is under water (see “Installation”).
- The wall drainage system is not fitted with a breather pipe.

If the problem persists even after these checks, turn off the water tap, switch the appliance off and contact the Technical Assistance Service. If the dwelling is on one of the upper floors of a building, there may be problems relating to water drainage, causing the washer-dryer to fill with water and drain continuously. Special anti-draining valves are available in shops and help to prevent this inconvenience.

The washer-dryer does not drain or spin.

- The wash cycle does not include draining: some cycles require the draining process to be enabled manually.
- The drain hose is bent (see “Installation”).
- The drainage duct is clogged.

The washer-dryer vibrates a lot during the spin cycle.

- The drum was not unlocked correctly during installation (see “Installation”).
- The washer-dryer is not level (see “Installation”).
- The washer-dryer is trapped between cabinets and walls (see “Installation”).

The washer-dryer leaks.

- The water inlet hose is not screwed on properly (see “Installation”).
- The detergent dispenser drawer is blocked (for cleaning instructions, see “Care and maintenance”).
- The drain hose is not fixed properly (see “Installation”).

The “option” and START/PAUSE indicator lights flash rapidly and an error code appears on the display (e.g.: F-01, F-...).

- Switch off the machine and unplug it, wait for approximately 1 minute and then switch it back on again.
- If the problem persists, contact the Technical Assistance Service.

There is too much foam.

- The detergent is not suitable for machine washing (it should display the text “for washer-dryers” or “hand and machine wash”, or the like).
- Too much detergent was used.

Push & Wash does not activate.

- After switching on the machine a control other than Push&Wash+Dry was activated. Switch the machine off and press the Push&Wash+Dry button.

The washer-dryer does not dry.

- The appliance is not plugged into the socket, or not enough to make contact.
- There has been a power failure.
- The appliance door is not shut properly.
- A DELAY TIMER has been set.
- DRYING is in the **OFF** position.

Service

GB

Before contacting the Technical Assistance Service:

- Check whether you can solve the problem alone (see "*Troubleshooting*").
- Restart the wash cycle to check whether the problem has been solved.
- If this is not the case, contact an authorised Technical Assistance Centre.

! Always request the assistance of authorised technicians.

Have the following information to hand:

- the type of problem;
- the appliance model (Mod.);
- the serial number (S/N).

This information can be found on the data plate applied to the rear of the washer-dryer, and can also be found on the front of the appliance by opening the door.

!  Το σύμβολο αυτό σου υπενθυμίζει να διαβάσεις αυτό το εγχειρίδιο οδηγιών.

GR

GR

Ελληνικά

XWDE 961480

Περιεχόμενα

Εγκατάσταση, 16-17

Αποσυσκευασία και οριζοντίωση
Υδραυλικές και ηλεκτρικές συνδέσεις
Πρώτος κύκλος πλυσίματος
Τεχνικά στοιχεία

Συντήρηση και φροντίδα, 18

Αποκλεισμός νερού και ηλεκτρικού ρεύματος
Καθαρισμός του πλυντηρίου
Καθαρισμός του συρταριού απορρυπαντικών
Φροντίδα της πόρτας και του κάδου
Καθαρισμός της αντλίας
Έλεγχος του σωλήνα τροφοδοσίας του νερού

Προφυλάξεις και συμβουλές, 19

Γενική ασφάλεια
Διάθεση
Χειρονακτικό άνοιγμα της πόρτας

Περιγραφή του πλυντηρίου, 20-21

Ταμπλό ελέγχου
Οθόνη

Πως διενεργείται ένας κύκλος πλυσίματος ή στεγνώματος, 22

Προγράμματα και δυνατότητες, 23-24

Πίνακας των Προγραμμάτων
Δυνατότητες πλυσίματος
Push&Wash+Dry

Απορρυπαντικά και μπουγάδα, 25-26

Θήκη απορρυπαντικών
Κύκλος λεύκανσης
Προετοιμασία της μπουγάδας
Ειδικά προγράμματα
Σύστημα ισοστάθμισης του φορτίου

Ανωμαλίες και λύσεις, 27

Υποστήριξη, 28

Εγκατάσταση

GR

! Είναι σημαντικό να διατηρήσετε το εγχειρίδιο αυτό για να μπορείτε να το συμβουλευέστε οποιαδήποτε στιγμή. Σε περίπτωση πώλησης, παραχώρησης ή μετακόμισης, βεβαιωθείτε ότι παραμένει μαζί με το πλυντήριο για να πληροφορεί τον νέο ιδιοκτήτη για τη λειτουργία και τις σχετικές προειδοποιήσεις.

! Διαβάστε προσεκτικά τις οδηγίες: υπάρχουν σημαντικές πληροφορίες για την εγκατάσταση, τη χρήση και την ασφάλεια.

Αποσυσκευασία και οριζόντιωση

Αποσυσκευασία

1. Αποσυσκευάστε το πλυντήριο.
2. Ελέγξτε αν το πλυντήριο έχει υποστεί ζημιές κατά τη μεταφορά. Αν έχει υποστεί ζημιές μην το συνδέετε και επικοινωνήστε με τον μεταπωλητή.

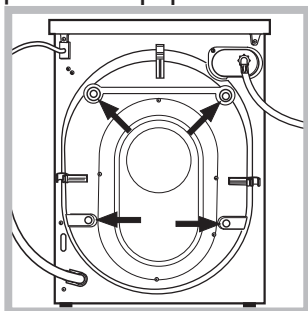

3. Αφαιρέστε τις 4 βίδες προστασίας για τη μεταφορά και το λαστιχάκι με το σχετικό διαχωριστικό, που βρίσκονται στο πίσω μέρος (βλέπε εικόνα).

4. Κλείστε τις οπές με τα πλαστικά πώματα που σας παρέχονται.
 5. Διατηρείστε και τα τρία τεμάχια: αν το πλυντήριο χρειαστεί να μεταφερθεί, θα πρέπει να ξαναμονταριστούν.
- ! Οι συσκευασίες δεν είναι παιχνίδια για μικρά παιδιά.

Ευθυγράμμιση

1. Εγκαταστήστε το πλυντήριο σε ένα δάπεδο επίπεδο και ανθεκτικό, χωρίς να το ακουμπήσετε σε τοίχους, έπιπλα ή άλλο.

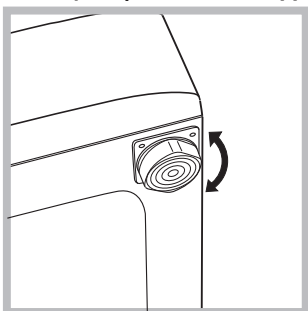

2. Αν το δάπεδο δεν είναι απόλυτα οριζοντιωμένο, αντισταθμίστε τις ανωμαλίες βιδώνοντας ή ξεβιδώνοντας τα πρόσθια ποδαράκια (βλέπε εικόνα). Η γωνία κλίσης, μετρημένη στην

επιφάνεια εργασίας, δεν πρέπει να ξεπερνάει τις 2°.

Μια φροντισμένη οριζόντιωση προσδίδει σταθερότητα στη μηχανή και αποσοβεί δονήσεις, θορύβους και μετατοπίσεις κατά τη λειτουργία. Σε περίπτωση μοκέτας ή τάπητα, ρυθμίστε τα ποδαράκια έτσι ώστε να υφίσταται κάτω από το πλυντήριο αρκετός χώρος για τον αερισμό.

Υδραυλικές και ηλεκτρικές συνδέσεις

Σύνδεση του σωλήνα τροφοδοσίας του νερού

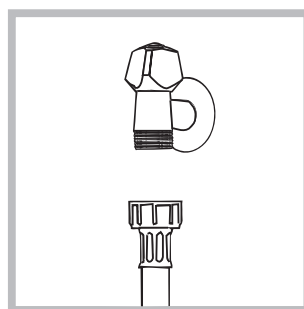

1. Συνδέστε το σωλήνα τροφοδοσίας βιδώνοντάς τον σε ένα κρουνό κρύου νερού με στόμιο σπειρώματος 3/4 gas (βλέπε εικόνα). Πριν τη σύνδεση, αφήστε να τρέξει το νερό μέχρι να γίνει διαυγές.

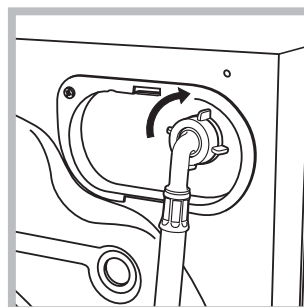

2. Συνδέστε το σωλήνα τροφοδοσίας στο πλυντήριο βιδώνοντάς τον στην αντίστοιχη είσοδο νερού, στο πίσω μέρος επάνω δεξιά (βλέπε εικόνα).

3. Προσέξτε ώστε στο σωλήνα να μην υπάρχουν ούτε πτυχώσεις, ούτε στενώσεις.

! Η πίεση νερού του κρουνού πρέπει να κυμαίνεται μεταξύ των τιμών του πίνακα Τεχνικά στοιχεία (βλέπε σελίδα δίπλα).

! Αν το μήκος του σωλήνα τροφοδοσίας δεν επαρκεί, απευθυνθείτε σε ένα ειδικευμένο κατάστημα ή σε εξουσιοδοτημένο τεχνικό.

! Μη χρησιμοποιείτε ποτέ χρησιμοποιημένους σωλήνες.

! Χρησιμοποιείτε εκείνους που σας παρέχονται με τη μηχανή.

Σύνδεση του σωλήνα αδειάσματος

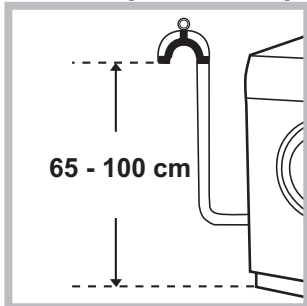

Συνδέστε το σωλήνα αδειάσματος, χωρίς να τον διπλώσετε, σε μια σωλήνωση αδειάσματος ή σε μια παροχέτευση επιτοίχια σε ύψος από το έδαφος μεταξύ 65 και 100 cm.

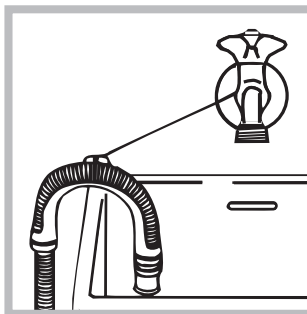

Ή στηρίξτε τον στο χείλος ενός νιπτήρα ή μιας λεκάνης, δένοντας τον οδηγό που σας παρέχεται στον κρουνό (βλέπε εικόνα). Το ελεύθερο άκρο του σωλήνα αδειάσματος δεν πρέπει να παραμένει βυθισμένο στο νερό. **! Δεν συνιστάται η χρήση προεκτάσεων**

σωλήνων. Αν απαιτείται, η προέκταση πρέπει να έχει την ίδια διάμετρο του αρχικού σωλήνα και να μην ξεπερνάει τα 150 cm.

Ηλεκτρική σύνδεση

Πριν εισάγετε το βύσμα στην ηλεκτρική πρίζα, βεβαιωθείτε ότι:

- η πρίζα διαθέτει γείωση και τηρεί τις εκ του νόμου προδιαγραφές.
- Η πρίζα να είναι σε θέση να υποφέρει το μέγιστο φορτίο ισχύος της μηχανής, που αναφέρεται στον πίνακα Τεχνικών στοιχείων (βλέπε δίπλα).
- Η τάση τροφοδοσίας να κυμαίνεται μεταξύ των τιμών που αναφέρονται στον πίνακα Τεχνικών στοιχείων (βλέπε δίπλα).
- Η πρίζα να είναι συμβατή με το βύσμα του πλυντηρίου. Σε αντίθετη περίπτωση, αντικαταστήστε την πρίζα ή το βύσμα.

! Το πλυντήριο δεν εγκαθίσταται σε ανοιχτό χώρο, ακόμη και αν ο χώρος είναι καλυμμένος, διότι είναι πολύ επικίνδυνο να το αφήνετε εκτεθειμένο σε βροχή και κακοκαιρία.

! Με την εγκατάσταση του πλυντηρίου, η πρίζα ρεύματος πρέπει να είναι εύκολα προσβάσιμη.

! Μη χρησιμοποιείτε προεκτάσεις και πολύπριζα.

! Το καλώδιο δεν πρέπει να φέρει πτυχές ή να είναι συμπιεσμένο.

! Το καλώδιο τροφοδοσίας πρέπει να αντικαθίσταται μόνο από εξουσιοδοτημένους τεχνικούς.

Προσοχή! Η επιχείρηση αποποιείται κάθε ευθύνης σε περίπτωση που δεν τηρούνται αυτοί οι κανόνες.

Πρώτος κύκλος πλυσίματος

Μετά την εγκατάσταση, πριν τη χρήση, διενεργήστε ένα κύκλο πλυσίματος με απορρυπαντικό και χωρίς ρούχα θέτοντας το πρόγραμμα “ΑΥΤΟ-ΚΑΘΑΡΙΣΜΟΣ” (βλέπε «Καθαρισμός του πλυντηρίου»).

Τεχνικά στοιχεία	
Μοντέλο	XWDE 961480
Διαστάσεις	πλάτος cm 59,5 ύψος cm 85 βάθος cm 60,5
Χωρητικότητα	από 1 έως 9 kg για το πλύσιμο από 1 έως 6 kg για το στέγνωμα
Ηλεκτρικές συνδέσεις	Βλέπε την πινακίδα χαρακτηριστικών επί της μηχανής
Συνδέσεις νερού	μέγιστη πίεση 1 MPa (10 bar) Ελάχιστη πίεση 0,05 MPa (0,5 bar) χωρητικότητα του κάδου 62 λίτρα
Ταχύτητα στυψίματος	μέχρι 1400 στροφές το λεπτό
Προγράμματα ελέγχου σύμφωνα με τον κανονισμό EN 50229	πλύσιμο: πρόγραμμα 8; θερμοκρασία 60°C; κτελούμενο με 9 kg μπουγάδας. στέγνωμα: το στέγνωμα του μικρότερου φορτίου (3kg) θα πρέπει να διενεργείται επιλέγοντας το επίπεδο στεγνώματος “”, το φορτίο της μπουγάδας θα πρέπει να αποτελείται από 3 σεντόνια, 2 μαξιλαροθήκες και 1 πετσέτες; Το στέγνωμα του υπόλοιπου φορτίου θα πρέπει να διενεργείται επιλέγοντας το επίπεδο στεγνώματος “”.
	Η συσκευή αυτή είναι σύμφωνη με τις ακόλουθες Κοινοτικές Οδηγίες: - 2004/108/CE (Ηλεκτρομαγνητική Συμβατότητα) - 2012/19/EU - 2006/95/CE (Χαμηλή Τάση)
θόρυβος (dB(A) re 1 pW)	Πλύσιμο: 54 Στύψιμο: 81

Συντήρηση και φροντίδα

GR

Αποκλεισμός νερού και ηλεκτρικού ρεύματος

- Κλείνετε τον κρουνοί του νερού μετά από κάθε πλύσιμο. Έτσι περιορίζεται η φθορά της υδραυλικής εγκατάστασης του πλυντηρίου και αποσοβείται ο κίνδυνος απωλειών.
- Να βγάζετε το βύσμα από το ρεύμα όταν καθαρίζετε το μηχάνημα και κατά τις εργασίες συντήρησης.

Καθαρισμός του πλυντηρίου

- Το εξωτερικό μέρος και τα λαστιχένια μέρη μπορούν να καθαρίζονται με ένα πανί βρεγμένο με χλιαρό νερό και σαπούνι. Μη χρησιμοποιείτε διαλύτες ή αποξυστικά.
- Το πλυντήριο διαθέτει ένα πρόγραμμα “ΑΥΤΟ-ΚΑΘΑΡΙΣΜΟΣ” των εσωτερικών μερών που πρέπει να διενεργείται **χωρίς κανένα τύπο φορτίου στον κάδο**. Το απορρυπαντικό (σε ποσότητα ίση με το 10% της προτεινόμενης για ρούχα λίγο λερωμένα) ή πρόσθετα ειδικά για τον καθαρισμό του πλυντηρίου, μπορούν να χρησιμοποιηθούν ως ενισχυτικά στο πρόγραμμα πλύσης. Συνιστάται να διενεργείτε το πρόγραμμα καθαρισμού κάθε 40 κύκλους πλυσίματος. Για την ενεργοποίηση του προγράμματος πατήστε το κουμπί **A** για 5 sec (βλέπε *Εικόνα*). Το πρόγραμμα θα ξεκινήσει αυτόματα και θα έχει διάρκεια περίπου 70 λεπτών. Για να σταματήσετε τον κύκλο πατήστε το κουμπί START/PAUSE.

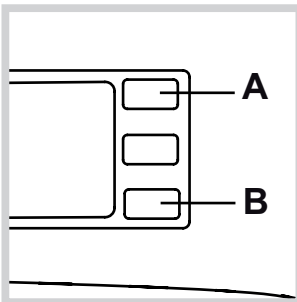

Καθαρισμός του συρταριού απορρυπαντικών

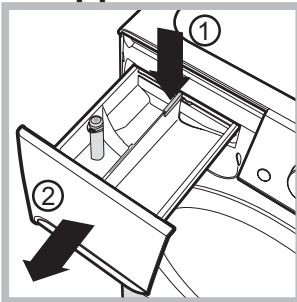

Για να βγάλετε το συρτάρι πατήστε το μοχλό (1) και τραβήξτε το προς τα έξω (2) (βλέπε *εικόνα*). Πλένετέ το κάτω από τρεχούμενο νερό. Ο καθαρισμός αυτός διενεργείται συχνά.

Φροντίδα της πόρτας και του κάδου

- Να αφήνετε πάντα μισόκλειστη την πόρτα για να μην παράγονται δυσοσμίες.

Καθαρισμός της αντλίας

Το πλυντήριο διαθέτει μια αντλία αυτοκαθαριζόμενη που δεν χρειάζεται συντήρηση. Μπορεί, όμως, να τύχει να πέσουν μικρά αντικείμενα (κέρματα, κουμπιά) στον προθάλαμο που προστατεύει την αντλία, που βρίσκεται στο κάτω μέρος αυτής.

! Βεβαιωθείτε ότι ο κύκλος πλυσίματος έχει τελειώσει και βγάλτε το βύσμα.

Για να έχετε πρόσβαση στον προθάλαμο:

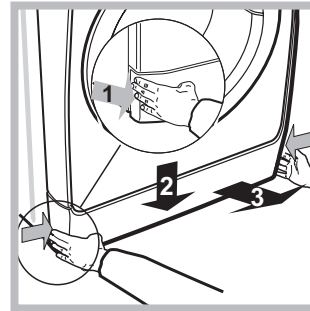

1. αφαιρέστε το πάνελ κάλυψης στο πρόσθιο πλευρό της μηχανής προς το κέντρο, κατόπιν ωθήστε προς τα κάτω αμφότερα τα πλευρά και βγάλτε το (βλέπε *εικόνας*).

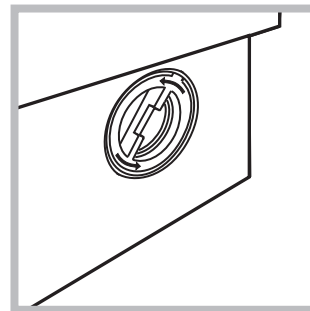

2. Ξεβιδώστε το καπάκι στρέφοντάς το αριστερόστροφα (βλέπε *εικόνα*): είναι φυσικό να βγαίνει λίγο νερό.

3. καθαρίστε επιμελώς το εσωτερικό
4. ξαναβιδώστε το καπάκι
5. ξαναμοντάρετε το πάνελ όντας σίγουροι, πριν το σπρώξετε προς τη μηχανή, ότι έχετε εισάγει τα γαντζάκια στις αντίστοιχες εσοχές.

Έλεγχος του σωλήνα τροφοδοσίας του νερού

Ελέγχετε το σωλήνα τροφοδοσίας τουλάχιστον μια φορά ετησίως. Αν παρουσιάζει σκασίματα και σχισμές αντικαθίσταται: κατά τα πλυσίματα οι ισχυρές πιέσεις θα μπορούσαν να προκαλέσουν αναπάντεχα σπασίματα.

! Μη χρησιμοποιείτε ποτέ χρησιμοποιημένους σωλήνες.

! Το πλυντήριο σχεδιάστηκε και κατασκευάστηκε σύμφωνα με τους διεθνείς κανόνες ασφαλείας. Αυτές οι προειδοποιήσεις παρέχονται για λόγους ασφαλείας και πρέπει να διαβάζονται προσεκτικά.

Γενική ασφάλεια

- Η συσκευή αυτή σχεδιάστηκε αποκλειστικά για οικιακή χρήση.
- Η συσκευή δεν πρέπει να χρησιμοποιείται από άτομα (συμπεριλαμβανομένων των παιδιών) με φυσικές, αισθητηριακές ή νοητικές ικανότητες και με εμπειρίες και γνώσεις ανεπαρκείς, εκτός κι αν η χρήση αυτή γίνεται υπό την επίβλεψη ή τις οδηγίες ενός ατόμου υπεύθυνου για την ασφάλειά τους. Τα παιδιά πρέπει να επιτηρούνται για να εξασφαλιστεί ότι δεν θα παίξουν με τη συσκευή.
 - Μη στεγνώνετε ρούχα μη πλυμένα.
 - Τα ρούχα λερωμένα με ουσίες όπως λάδι μαγειρέματος, ακετόνη, οινόπνευμα, βενζίνη, κηροζίνη, ξηλεκαστικά, τρεμεντίνη, κεριά και οι ουσίες για την απομάκρυνσή του πρέπει να πλένονται σε ζεστό νερό με μεγαλύτερη ποσότητα απορρυπαντικού πριν τα στεγνώσετε στο στεγνωτήριο.
 - Αντικείμενα όπως το διογκωμένο ελαστικό (αφρώδες ελαστικό), τα σκουφάκια μπάνιου, τα αδιάβροχα υφασμάτινα υλικά, τα είδη με ένα μέρος από ελαστικό και τα ενδύματα ή τα μαξιλάρια που έχουν μέρη από αφρώδες ελαστικό δεν πρέπει να στεγνώνονται στο στεγνωτήριο.
 - Μαλακτικά ή προϊόντα παρόμοια πρέπει να χρησιμοποιούνται σύμφωνα με τις οδηγίες του παραγωγού.
 - Το τελικό μέρος ενός κύκλου στεγνώματος γίνεται χωρίς θερμότητα (κύκλος ψύξης) για να εξασφαλιστεί ότι τα είδη δεν θα υποστούν ζημιά.
- ΠΡΟΣΟΧΗ: Μη σταματάτε ποτέ ένα στεγνωτήριο πριν το τέλος του προγράμματος στεγνώματος. Στην περίπτωση αυτή πάρτε γρήγορα όλα τα ασπρόρουχα και απλώστε τα για να κρυσώσουν γρηγορότερα.
- Μην αγγίζετε το μηχανήμα με γυμνά πόδια ή χέρια ή τα πόδια βρεγμένα.
- Μην βγάζετε το βύσμα από την ηλεκτρική πρίζα τραβώντας το καλώδιο, αλλά να πιάνετε την πρίζα.
- Μην αγγίζετε το νερό αδειάσματος, αφού μπορεί να φτάσει σε υψηλές θερμοκρασίες.
- Μην ζορίζετε σε καμία περίπτωση την πόρτα: θα μπορούσε να χαλάσει ο μηχανισμός ασφαλείας που προστατεύει από τυχαία ανοίγματα.
- Σε περίπτωση βλάβης, σε καμία περίπτωση να μην επεμβαίνετε στους εσωτερικούς μηχανισμούς προσπαθώντας να επισκευάσετε.
- Να ελέγχετε πάντα τα παιδιά να μην πλησιάζουν στο μηχανήμα σε λειτουργία.
- Αν πρέπει να μετατοπιστεί, συνεργαστείτε δύο ή τρία άτομα με τη μέγιστη προσοχή. Ποτέ μόνοι σας γιατί το μηχανήμα είναι πολύ βαρύ.
- Πριν εισάγετε τη μπουγάδα ελέγξτε αν ο κάδος είναι άδειος.
- Η πόρτα κατά το στέγνωμα τείνει να θερμαίνεται.
- Μη στεγνώνεις ρούχα πλυμένα με εύφλεκτους διαλύτες (π.χ. τριελίνη).
- Μη στεγνώνεις αφρώδη συνθετικά ή ανάλογα ελαστομερή.
- Βεβαιωθείτε ότι κατά τις φάσεις του στεγνώματος ο κρουσός του νερού είναι ανοιχτός.

Διάθεση

- Διάθεση του υλικού συσκευασίας: τηρείτε τους τοπικούς κανονισμούς, ώστε οι συσκευασίες να μπορούν να επαναχρησιμοποιηθούν.
- Η Ευρωπαϊκή Οδηγία 2012/19/CE για τα απορρίμματα ηλεκτρικών και ηλεκτρονικών συσκευών, προβλέπει ότι οι οικιακές ηλεκτρικές συσκευές δεν πρέπει να διατίθενται στην κανονική ροή των στερεών αστικών απορριμμάτων. Οι απορριπτόμενες συσκευές πρέπει να συλλέγονται χωριστά για να βελτιστοποιείται το ποσοστό ανάκτησης και ανακύκλωσης των υλικών που τις αποτελούν και να αποφεύγονται δυνητικές ζημιές για την υγεία και το περιβάλλον. Το σύμβολο του διαγραμμένου καλαθιού υπάρχει σε όλα τα προϊόντα για να θυμίζει τις υποχρεώσεις χωριστής συλλογής. Για περαιτέρω πληροφορίες, για τη σωστή απομάκρυνση των οικιακών ηλεκτρικών συσκευών, οι κάτοχοι θα μπορούν να απευθύνονται στην αρμόδια δημόσια υπηρεσία ή στους μεταπωλητές.

Χειρονακτικό άνοιγμα της πόρτας

Στην περίπτωση αδυναμίας ανοίγματος της πόρτας εξ αιτίας απουσίας ηλεκτρικής ενέργειας ενώ θέλετε να απλώσετε την μπουγάδα, προχωρήστε ως ακολούθως:

1. βγάλτε το βύσμα από την ηλεκτρική πρίζα.

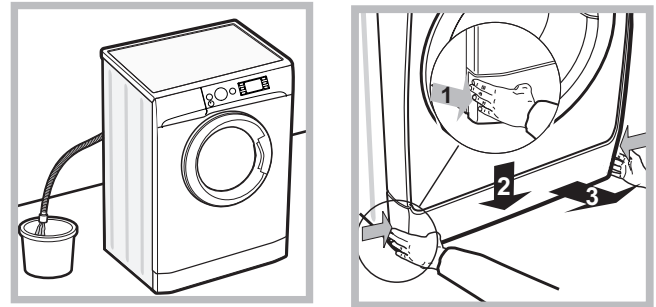

2. βεβαιωθείτε ότι η στάθμη του νερού στο εσωτερικό της μηχανής είναι χαμηλότερη σε σχέση με το άνοιγμα της πόρτας. Σε αντίθετη περίπτωση αφαιρέστε το σε περίσσεια νερό μέσω του σωλήνα αδειάσματος συλλέγοντάς το σε ένα κουβά όπως φαίνεται στην **εικόνα**.

3. αφαιρέστε το ταμπλό κάλυψης στο πρόσθιο πλευρό του πλυντηρίου (βλέπε **εικόνα**).

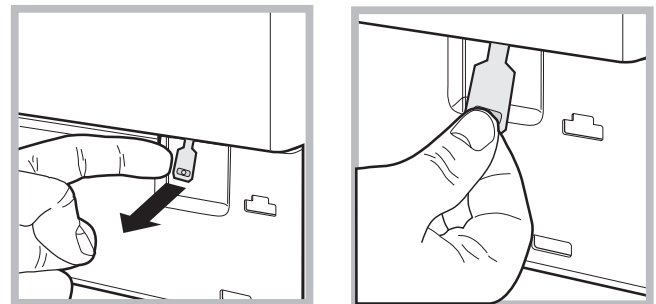

4. χρησιμοποιώντας τη γλωσσίσσα που φαίνεται στην **εικόνα** τραβήξτε προς τα έξω μέχρι να ελευθερώσετε το πλαστικό από το στοπ. Τραβήξτε το ακολούθως προς τα κάτω και ταυτόχρονα ανοίξτε την πόρτα.

5. ξαναμοντάρετε το πάνελ όντας σίγουροι, πριν το σπρώξετε προς τη μηχανή, ότι έχετε εισάγει τα γαντζάκια στις αντίστοιχες εσοχές.

Περιγραφή του πλυντηρίου

GR

Πίνακας ελέγχου

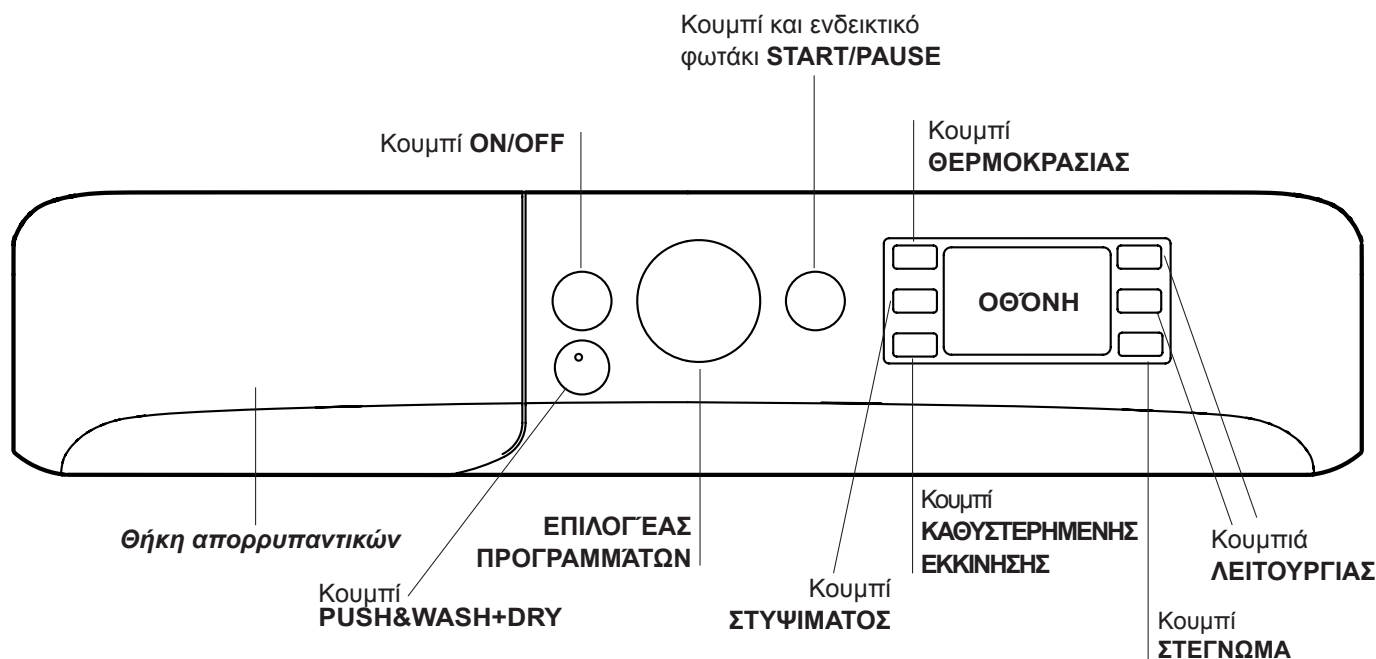

Θήκη απορρυπαντικών: για την προσθήκη απορρυπαντικών και πρόσθετων (βλέπε «Απορρυπαντικά και μπουγάδα»).

Κουμπί **ON/OFF** : πιέστε για λίγο το κουμπί για να ανάψετε ή να σβήσετε τη μηχανή. Το ενδεικτικό φωτάκι **START/PAUSE** πράσινου χρώματος που αναβοσβήνει αργά δείχνει ότι η μηχανή είναι αναμμένη. Για να σβήσετε το πλυντήριο κατά το πλύσιμο πρέπει να κρατάτε πατημένο το κουμπί πιο πολύ, περίπου 3 sec. Στιγμιαίο ή τυχαίο πάτημα δεν επιτρέπει το σβήσιμο της μηχανής. Το σβήσιμο της μηχανής κατά το πλύσιμο σε εξέλιξη ακυρώνει το ίδιο το πλύσιμο.

Κουμπί **PUSH&WASH+DRY**: (βλέπε «Προγράμματα και δυνατότητες»).

ΕΠΙΛΟΓΕΑΣ ΠΡΟΓΡΑΜΜΑΤΩΝ: Για να θέσετε το επιθυμητό πρόγραμμα (βλέπε τον «Πίνακα προγραμμάτων»).



Κουμπιά **ΔΥΝΑΤΟΤΗΤΑΣ:** για να επιλέξετε τις διαθέσιμες δυνατότητες. Το ενδεικτικό φωτάκι το σχετικό με τη δυνατότητα που επελέγη θα παραμείνει αναμμένο.

Κουμπί **ΘΕΡΜΟΚΡΑΣΙΑΣ** : Πιέστε για να μειώσετε ή να αποκλείσετε τελείως τη θερμοκρασία. Η τιμή φαίνεται στην οθόνη.

Κουμπί **ΣΤΥΨΙΜΑΤΟΣ** : πιέστε για να μειώσετε ή να αποκλείσετε τελείως το στύψιμο. Η τιμή φαίνεται στην οθόνη.

Κουμπί **ΕΚΚΙΝΗΣΗΣ ΜΕ ΥΣΤΕΡΗΣΗ** : πατήστε για να θέσετε μια εκκίνηση με υστέρηση του προεπιλεγμένου προγράμματος. Η καθυστέρηση υποδεικνύεται στην οθόνη.

Κουμπι **ΣΤΕΓΝΩΜΑ** : πιέστε για να μειώσετε ή να αποκλείσετε το στέγνωμα. Το επίπεδο ή ο επιλεγμένος χρόνος στεγνώματος φαίνεται στην οθόνη (βλέπε «Πως διενεργείται ένας κύκλος πλυσίματος ή στεγνώματος»).

Κουμπί και ενδεικτικό φωτάκι **START/PAUSE** : όταν το πράσινου ενδεικτικό φωτάκι αναβοσβήνει αργά, πατήστε το κουμπί για την εκκίνηση πλυσίματος. Με την εκκίνηση του κύκλου το ενδεικτικό φωτάκι σταθεροποιείται. Για να θέσετε μια παύση στο πλύσιμο, πατήστε εκ νέου το κουμπί. Το ενδεικτικό φωτάκι θα αναβοσβήνει με κεχριμπαρί χρώμα. Αν το σύμβολο  δεν φωτίζεται, μπορείτε να ανοίξετε την πόρτα. Για να ξεκινήσει πάλι το πλύσιμο από το σημείο διακοπής, πατήστε εκ νέου το κουμπί.

Τρόπος stand by

Το πλυντήριο αυτό, σύμφωνα με τις νέες διατάξεις για την εξοικονόμηση ενέργειας, διαθέτει ένα σύστημα αυτόματου σβήσιματος (stand by) που τίθεται σε λειτουργία εντός 30 λεπτών στην περίπτωση μη χρήσης. Πιέστε στιγμιαία το κουμπί **ON/OFF** και περιμένετε να ενεργοποιηθεί εκ νέου η μηχανή.

ΟΘΟΝΗ

GR

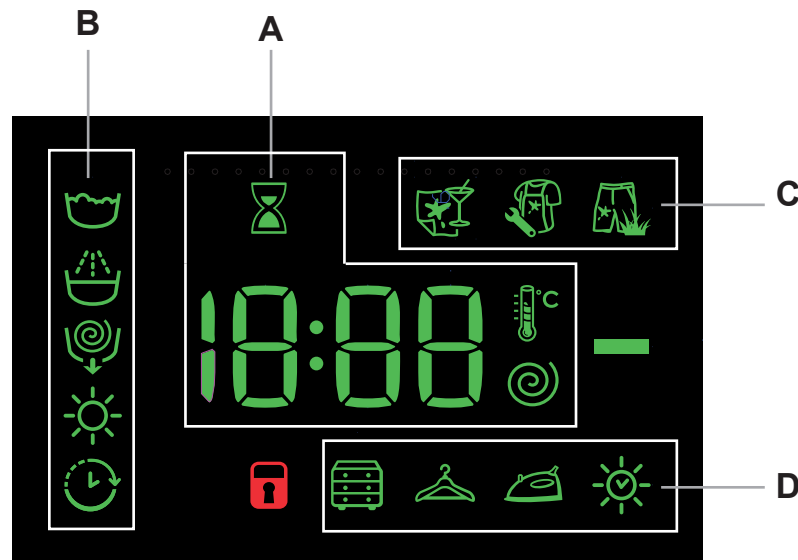

Η οθόνη είναι χρήσιμη για τον προγραμματισμό της μηχανής και παρέχει πολλαπλές πληροφορίες.

Στην ενότητα **A** απεικονίζεται η διάρκεια των διαφόρων διαθέσιμων προγραμμάτων και αφού έχει εκκινηθεί ο κύκλος, του υπολειπόμενου χρόνου για το τέλος αυτού. Στην περίπτωση που έχει τεθεί μια ΚΑΘΥΣΤΕΡΗΜΕΝΗ ΕΚΚΙΝΗΣΗ, απεικονίζεται ο χρόνος που υπολείπεται στην εκκίνηση του επιλεγμένου προγράμματος.

Ακόμη, πιέζοντας το σχετικό πλήκτρο, εμφανίζονται οι μέγιστες τιμές της θερμοκρασίας, της ταχύτητας φυγοκέντρησης και του χρόνου στεγνώματος που μπορεί να διενεργήσει η μηχανή με βάση το θεθέν πρόγραμμα ή τις τελευταίες επιλεγμένες τιμές αν είναι συμβατές με το επιλεγμένο πρόγραμμα.

Η κλεψύδρα αναβοσβήνει στη φάση που η μηχανή επεξεργάζεται τα δεδομένα με βάση το επιλεγμένο πρόγραμμα. Μετά από 10 λεπτά το πολύ από την εκκίνηση το εικονίδιο ⏳ σταθεροποιείται και απεικονίζεται ο οριστικά υπολειπόμενος χρόνος. Το εικονίδιο της κλεψύδρας θα σβήσει μετά από περίπου 1 λεπτό από την απεικόνιση του οριστικά υπολειπόμενου χρόνου.

Στην ενότητα **B** απεικονίζονται οι “φάσεις πλυσίματος” που προβλέπονται για τον επιλεγμένο κύκλο και με το πρόγραμμα εκκινηθέν η “φάση πλυσίματος” σε εξέλιξη:

- Πλύσιμο
- Ξέβγαλμα
- Στύψιμο/ Άδειασμα
- Στέγνωμα

Το σύμβολο “ΚΑΘΥΣΤΕΡΗΜΕΝΗ ΕΚΚΙΝΗΣΗ” ⌚ φωτισμένο δείχνει ότι στην οθόνη απεικονίζεται η τιμή της θεθείσας “Καθυστερημένης εκκίνησης”.

Στην ενότητα **C** υπάρχουν τα τρία επίπεδα σχετικά με τις δυνατότητες πλύσης.

Στην ενότητα **D** υπάρχουν τα εικονίδια σχετικά με τα τρία επίπεδα στεγνώματος και το εικονίδιο που φωτίζεται όταν καταχωρείται ένα στέγνωμα για συγκεκριμένο χρόνο.

Ενδεικτικό φωτάκι Πόρτα ασφαλισμένη

Το αναμμένο σύμβολο δείχνει ότι η πόρτα είναι μπλοκαρισμένη. Για την αποφυγή ζημιών πρέπει να περιμένετε να σβήσει το σύμβολο πριν ανοίξετε την πόρτα.

Για να ανοίξετε την πόρτα ενώ είναι σε εξέλιξη ένας κύκλος πιάστε το κουμπί START/PAUSE. Αν το σύμβολο ΠΟΡΤΑ ΑΣΦΑΛΙΣΜΕΝΗ είναι σβηστό θα μπορείτε να ανοίξετε την πόρτα.

Πως διενεργείται ένας κύκλος πλυσίματος

GR

Ταχύς προγραμματισμός

1. **ΦΟΡΤΩΣΗ ΡΟΥΧΩΝ.** Ανοίξτε την πόρτα. Φορτώστε τα ρούχα, προσέχοντας να μην ξεπεράσετε την ποσότητα φορτίου που υποδεικνύεται στον πίνακα προγραμμάτων της επόμενης σελίδας.
2. **ΔΟΣΟΛΟΓΙΑ ΤΟΥ ΑΠΟΡΡΥΠΑΝΤΙΚΟΥ.** Βγάλτε το συρτάρι και χύστε το απορρυπαντικό στις αντίστοιχες λεκανίτσες όπως εξηγείται στην “Απορρυπαντικά και μπουγάδα”.
3. **ΚΛΕΙΣΤΕ ΤΗΝ ΠΟΡΤΑ.**
4. ΠΑΤΗΣΤΕ ΤΟ ΚΟΥΜΠΙ “Push&Wash+Dry” για την εκκίνηση του προγράμματος.

Παραδοσιακός προγραμματισμός

1. **ΑΝΑΨΤΕ ΤΗ ΜΗΧΑΝΗ.** Πιέστε το κουμπί . Το ενδεικτικό φωτάκι START/PAUSE θα αναβοσβήνει αργά με πράσινου χρώμα.
2. **ΦΟΡΤΩΣΗ ΡΟΥΧΩΝ.** Ανοίξτε την πόρτα. Φορτώστε τα ρούχα, προσέχοντας να μην ξεπεράσετε την ποσότητα φορτίου που υποδεικνύεται στον πίνακα προγραμμάτων της επόμενης σελίδας.
3. **ΔΟΣΟΛΟΓΙΑ ΤΟΥ ΑΠΟΡΡΥΠΑΝΤΙΚΟΥ.** Βγάλτε το συρτάρι και χύστε το απορρυπαντικό στις αντίστοιχες λεκανίτσες όπως εξηγείται στην “Απορρυπαντικά και μπουγάδα”.
4. **ΚΛΕΙΣΤΕ ΤΗΝ ΠΟΡΤΑ.**
5. **ΕΠΙΛΕΞΤΕ ΤΟ ΠΡΟΓΡΑΜΜΑ.** Επιλέξτε με τον επιλογέα ΠΡΟΓΡΑΜΜΑΤΩΝ το επιθυμητό πρόγραμμα. Σε αυτό αντιστοιχεί μια θερμοκρασία και μια ταχύτητα στύψιματος που μπορούν να τροποποιηθούν. Στην οθόνη θα εμφανιστεί η διάρκεια του κύκλου.
6. **ΕΞΑΤΟΜΙΚΕΥΣΗ ΤΟΥ ΚΥΚΛΟΥ ΠΛΥΣΙΜΑΤΟΣ.** Ενεργήστε στα σχετικά κουμπιά:
 Τροποποιήστε τη θερμοκρασία ή/και το στύψιμο. Η μηχανή απεικονίζει αυτόματα τις μέγιστες θερμοκρασία και στύψιμο που προβλέπονται για το τεθέν πρόγραμμα ή τις τελευταίες επιλεγείσες αν είναι συμβατές με το επιλεγμένο πρόγραμμα. Πατώντας το κουμπί μειώνεται προοδευτικά η θερμοκρασία μέχρι το πλύσιμο σε κρύο νερό “OFF”. Πατώντας το κουμπί μειώνεται προοδευτικά το στύψιμο μέχρι τον αποκλεισμό του “OFF”. Περαιτέρω πάτημα των κουμπιών επαναφέρει τις τιμές στις μέγιστες προβλεπόμενες.
! Εξαιρέση: επιλέγοντας το πρόγραμμα 8 η θερμοκρασία μπορεί να αυξηθεί μέχρι 90°.

Θέστε το στέγνωμα

Με το πρώτο πάτημα του κουμπιού η μηχανή επιλέγει αυτόματα το μέγιστο επίπεδο στεγνώματος συμβατό με το επιλεγμένο πρόγραμμα. Τα επόμενα πατήματα μειώνουν το επίπεδο και ακολούθως το χρόνο στεγνώματος μέχρι τον αποκλεισμό του “OFF”. Μπορείτε να θέσετε το στέγνωμα:

A - με βάση το επίπεδο επιθυμητού στεγνώματος:

Ντουλάπα : κατάλληλο για την μπουγάδα που θα βάλετε στην ντουλάπα χωρίς σιδέρωμα.

Κρέμασμα : ιδανικό για τα ρούχα εκείνα που δεν απαιτούν πλήρες στέγνωμα.

Σιδέρωμα : ενδείκνυται για ρούχα που πρέπει μετά να σιδερωθούν. Το επίπεδο υπολειπόμενης υγρασίας μαλακώνει τις πτυχές και διευκολύνει την εξαφάνισή τους.

B - Με βάση το χρόνο: Από **210** έως **30** λεπτά.

Αν, εξαιρετικά, το φορτίο ρούχων για πλύσιμο και στέγνωμα είναι μεγαλύτερο του μέγιστου

προβλεπόμενου, διενεργήστε το πλύσιμο, και με το πέρας του προγράμματος, χωρίστε το φορτίο και ξαναβάλτε ένα μέρος στο καλάθι. Στο σημείο αυτό ακολουθήστε τις οδηγίες για να εκτελέσετε «**Μόνο το στέγνωμα**». Επανάλαβε τις ίδιες ενέργειες για το υπόλοιπο φορτίο.

ΠΑΡΑΤΗΡΗΣΗ: στο τέλος του στεγνώματος εκτελείται πάντα μια φάση ψύξης.

Μόνο το στέγνωμα

Πατήστε το κουμπί για να κάνετε μόνο στέγνωμα. Αφού επιλέξετε το επιθυμητό πρόγραμμα συμβατό με τον τύπο των ρούχων, με το πάτημα του κουμπιού αποκλείεται η φάση πλυσίματος και θα ενεργοποιηθεί το στέγνωμα με το μέγιστο προβλεπόμενο επίπεδο για το επιλεγμένο πρόγραμμα. Μπορείτε να τροποποιήσετε και να καταχωρήσετε το επίπεδο ή τη διάρκεια του στεγνώματος πατώντας το κουμπί στεγνώματος . (Δεν είναι συμβατό με τα προγράμματα 13 και 14).

Θέστε μια εκκίνηση με υστέρηση.

Για να θέσετε την εκκίνηση με υστέρηση του προεπιλεγμένου προγράμματος, πατήστε το σχετικό κουμπί μέχρι να επιτευχθεί ο χρόνος της επιθυμητής υστέρησης. Όταν η δυνατότητα αυτή είναι ενεργή, στην οθόνη φωτίζεται το σύμβολο . Για να απαλείψετε την εκκίνηση με υστέρηση πατήστε το κουμπί μέχρις ότου εμφανιστεί στην οθόνη η ένδειξη “OFF”.

Τροποποιήστε τα χαρακτηριστικά του κύκλου.

- Πατήστε το κουμπί για την ενεργοποίηση της δυνατότητας. Θα ανάψει το σχετικό ενδεικτικό φωτάκι.
- Πατήστε εκ νέου το κουμπί για την απενεργοποίηση της δυνατότητας. Το ενδεικτικό φωτάκι θα σβήσει.
! Αν η επιλεγμένη δυνατότητα δεν είναι συμβατή με το τεθέν πρόγραμμα, το ενδεικτικό φωτάκι θα αναβοσβήνει και η δυνατότητα δεν θα ενεργοποιηθεί.
! Αν η επιλεγμένη δυνατότητα δεν είναι συμβατή με μια άλλη προηγούμενως θεθείσα, η ασυμβατότητα θα επίσημανθεί με το αναβοσβήσιμο της ενδεικτικής λυχνίας και ένα ηχητικό σήμα (3 μπιπ) και θα ενεργοποιηθεί μόνο η δεύτερη, το ενδεικτικό φωτάκι της ενεργοποιημένης δυνατότητας θα φωτιστεί.
! Οι δυνατότητες μπορούν να αλλάξουν το προτεινόμενο φορτίο ή/και τη διάρκεια του κύκλου.

7. **ΕΚΚΙΝΗΣΗ ΤΟΥ ΠΡΟΓΡΑΜΜΑΤΟΣ.** Πατήστε το κουμπί START/PAUSE. Το σχετικό ενδεικτικό φωτάκι θα φωτιστεί πράσινου και η πόρτα θα μπλοκάρει (σύμβολο ΠΟΡΤΑ ΑΣΦΑΛΙΣΜΕΝΗ αναμμένο). Για να αλλάξετε ένα πρόγραμμα ενώ είναι σε εξέλιξη ένας κύκλος, **θέστε το πλυντήριο σε παύση πιέζοντας** το κουμπί START/PAUSE (το ενδεικτικό φωτάκι START/PAUSE θα αναβοσβήνει αργά με κεκριματάρι χρώμα). Κατόπιν επιλέξτε τον επιθυμητό κύκλο και πατήστε εκ νέου το κουμπί START/PAUSE. Για να ανοίξετε την πόρτα ενώ είναι σε εξέλιξη ένας κύκλος πιέστε το κουμπί START/PAUSE. Αν το σύμβολο ΠΟΡΤΑ ΑΣΦΑΛΙΣΜΕΝΗ είναι σβηστό θα μπορείτε να ανοίξετε την πόρτα. Πατήστε εκ νέου το κουμπί START/PAUSE για να ξεκινήσει πάλι το πρόγραμμα από το σημείο διακοπής.
8. **ΤΕΛΟΣ ΤΟΥ ΠΡΟΓΡΑΜΜΑΤΟΣ.** Υποδεικνύεται από την ένδειξη “END” στην οθόνη, όταν το σύμβολο ΠΟΡΤΑ ΑΣΦΑΛΙΣΜΕΝΗ σβήσει μπορείτε να ανοίξετε την πόρτα. Ανοίξτε την πόρτα, αδειάστε τα ρούχα και σβήστε τη μηχανή.

! Αν επιθυμείτε αν ακυρώσετε έναν ήδη εκκινηθέντα κύκλο, πατήστε επί μακρόν το κουμπί . Ο κύκλος θα διακοπεί και η μηχανή θα σβήσει.

Προγράμματα και δυνατότητες

Πίνακας των Προγραμμάτων

Προγράμματα	Περιγραφή του προγράμματος	Μέγιστη θερμοκρασία (°C)	Μέγιστη ταχύτητα στρόφους ανά λεπτό	Στέγνωμα	Μέγιστο φορτίο για το στέγνωμα (Kg)	Απορρυπαντικά και πρόσθετα				Μέγιστο φορτίο για το πλύσιμο (Kg)	Διάρκεια κύκλου	
						Προπλυσή	Πλυσίμο	μαλακτικό	Λευκαντικό			
Ειδικά												
1	Sport ελαφρύ	30°	600	●	4	-	●	●	-	4	Μπορείτε να ελέγξετε τη διάρκεια των προγραμμάτων πλυσίματος στην οθόνη.	
2	Σκουρόχρωμα	30°	800	●	3	-	●	●	-	5		
3	Αντι-δυσσομία (βαμβακερά)	60°	1000	●	3,5	-	●	●	-	3,5		
3	Αντι-δυσσομία (Συνθετικά)	40°	1000	●	3,5	-	●	●	-	3,5		
4	Ευαίσθητα	30°	0	●	1	-	●	●	-	1		
5	Μάλλινα: Για μάλλινα, cachemire, κλπ.	40°	800	●	2	-	●	●	-	2		
6	Ταχεία 30'	30°	800	●	3,5	-	●	●	-	3,5		
Standard												
7	Βαμβακερά με Πρόπλυση: Λευκά εξαιρετικά λερωμένα.	90°	1400	●	6	●	●	●	-	9		
8	κανονικό πρόγραμμα για βαμβακερά στους 60°C (1): Λευκά και χρωματιστά ανθεκτικά, πολύ λερωμένα.	60° (Max. 90°)	1400	●	6	-	●	●	-	9		
9	Συνθετικά: Χρωματιστά ανθεκτικά, πολύ λερωμένα.	60°	800	●	4	-	●	●	-	4,5		
10	Χρωματιστά (2)	40°	1400	●	6	-	●	●	-	9		
11	Eco βαμβακερά στους 20°: Λευκά λίγο λερωμένα και ευαίσθητα χρώματα.	20°	1400	●	6	-	●	●	-	9		
12	Eco Συνθετικά	20°	800	●	6	-	●	●	-	9		
αυτόματο												
13	ΚΑΘΑΡΑ&ΣΤΕΓΝΑ 45'	30°	1400	●	1	-	●	●	-	1		
14	AirFresh	-	-	●	1,5	-	-	-	-	-		
Επί μέρους												
	Ξέβγαλμα/Λευκαντικό	-	1400	●	6	-	-	●	●	9		
	Στύψιμο + Άδειασμα	-	1400	●	6	-	-	-	-	9		
	Μόνο άδειασμα *	-	OFF	-	-	-	-	-	-	9		

* Επιλέγοντας το πρόγραμμα και αποκλείοντας τη φυγοκέντρηση η συσκευή θα εκτελέσει μόνο το άδειασμα.

Η διάρκεια του κύκλου που φαίνεται στην οθόνη ή στο εγχειρίδιο αποτελεί μια εκτίμηση υπολογισμένη με βάση τις σπάνια συνθήκες. Ο πραγματικός χρόνος μπορεί να ποικίλει με βάση πολυάριθμους παράγοντες όπως θερμοκρασία και πίεση του εισερχόμενου νερού, θερμοκρασία περιβάλλοντος, ποσότητα απορρυπαντικού, ποσότητα και τύπος φορτίου, ισοστάθμιση του φορτίου, πρόσθετες επιλεγμένες δυνατότητες.

1) Πρόγραμμα ελέγχου σύμφωνα με την προδιαγραφή 1061/2010: θέστε το πρόγραμμα 8 σε μια θερμοκρασία 60°C.

Ο κύκλος αυτός είναι κατάλληλος για τον καθαρισμό φορτίου βαμβακερών με συνηθισμένη βρωμιά και είναι ο πλέον αποτελεσματικός σε όρους κατανάλωσης ενέργειας και νερού, προς χρήση σε ρούχα πλενόμενα στους 60 °C. Η πραγματική θερμοκρασία πλυσίματος μπορεί να διαφέρει από την υποδεικνυόμενη.

2) Πρόγραμμα ελέγχου σύμφωνα με την προδιαγραφή 1061/2010: θέστε το πρόγραμμα 9 σε μια θερμοκρασία 40°C.

Ο κύκλος αυτός είναι κατάλληλος για τον καθαρισμό φορτίου βαμβακερών με συνηθισμένη βρωμιά και είναι ο πλέον αποτελεσματικός σε όρους κατανάλωσης ενέργειας και νερού, προς χρήση σε ρούχα πλενόμενα στους 40 °C. Η πραγματική θερμοκρασία πλυσίματος μπορεί να διαφέρει από την υποδεικνυόμενη.

Για όλα τα Test Institutes:

2) Πρόγραμμα βαμβακερών μακρύ: θέστε το πρόγραμμα 9 σε μια θερμοκρασία 40°C.

3) Πρόγραμμα συνθετικών μεγάλης διάρκειας: θέστε το πρόγραμμα 10 σε μια θερμοκρασία 40°C.

Δυνατότητες πλυσίματος

Ξελέκισμα

Η δυνατότητα αυτή επιτρέπει την επιλογή του τύπου βρωμιάς έτσι ώστε να προσαρμοστεί ο κύκλος με τρόπο βέλτιστο για την απομάκρυνση των λεκέδων. Οι τύποι βρωμιάς είναι:

- **Τρόφιμα**, για λεκέδες π.χ. τροφίμων και ποτών.
- **Εργασία**, για λεκέδες π.χ. γράσου και μελάνης.
- **Outdoor**, για λεκέδες π.χ. λάσπης και χόρτων.

! Η διάρκεια του κύκλου πλύσης ποικίλει ανάλογα με τον τύπο βρωμιάς που επιλέχτηκε.

! Δεν είναι διαθέσιμη στα προγράμματα 1-2-3-4-5-6-7-10-11-12-13-14--.

Push&Wash+Dry

Η λειτουργία αυτή επιτρέπει την εκκίνηση ενός αυτόματου κύκλου πλυσίματος και στεγνώματος ακόμη και με τη μηχανή σβηστή χωρίς να χρειαστεί εκ των προτέρων να πατήσετε το κουμπί ON/OFF ή, μετά το άναμμα της μηχανής, χωρίς να έχετε ενεργοποιήσει κανένα κουμπί ή/και διακόπτη (αλλιώς το πρόγραμμα Push&Wash+Dry θα απενεργοποιηθεί). Για την εκκίνηση του κύκλου Push&Wash+Dry κρατήστε πατημένο το κουμπί για 2 δευτερόλεπτα. Το αναμμένο ενδεικτικό φωτάκι δείχνει ότι ο κύκλος έχει ξεκινήσει. Ο κύκλος πλυσίματος και στεγνώματος είναι ιδανικός για βαμβακερά και συνθετικά ρούχα λειτουργώντας σε μια θερμοκρασία πλυσίματος 30° και μια μέγιστη ταχύτητα στुψίματος ίση με 1000 στροφές ανά λεπτό. Κατά το στέγνωμα η μέγιστη επιτυγχανόμενη θερμοκρασία είναι περίπου 60°C. Στο τέλος του προγράμματος η υπολειπόμενη υγρασία είναι όση χρειάζεται για το “☁”. Μέγιστο προτεινόμενο φορτίο 3 kg.

Η εμφανιζόμενη διάρκεια στην οθόνη είναι η μέγιστη επιτρεπτή από τον κύκλο Push&Wash+Dry. Στην περίπτωση που το φορτίο είναι μικρότερο του μέγιστου ή με μια σύνθεση όπου υπερτερούν τα ρούχα από συνθετικό υλικό, η πραγματική διάρκεια του κύκλου θα είναι μικρότερη.

Πώς λειτουργεί?

1. Φορτώστε την μπουγάδα (βαμβακερά ή/και συνθετικά) και κλείστε την πόρτα.
2. Χύστε απορρυπαντικό ή/και πρόσθετα.
3. Εκκινήστε το πρόγραμμα κρατώντας πατημένο για 2 δευτερόλεπτα το κουμπί Push&Wash+Dry. Το σχετικό ενδεικτικό φωτάκι θα φωτιστεί πράσινο και η πόρτα θα μπλοκάρει (σύμβολο ασφαλισμένης πόρτας αναμμένο).

ΠΑΡΑΤΗΡΗΣΗ: Η έναρξη του πλυσίματος με το κουμπί Push&Wash+Dry ενεργοποιεί έναν αυτόματο κύκλο πλυσίματος και στεγνώματος προτεινόμενο για βαμβακερά και συνθετικά, μη εξατομικεύσιμο.

4. Μπορείτε να χρησιμοποιήσετε το αυτόματο πρόγραμμα μόνο για το πλύσιμο αποκλείοντας το στέγνωμα. Πατήστε, μετά το πάτημα του κουμπιού Push&Wash+Dry, το κουμπί στεγνώματος ☀, το εικονίδιο στεγνώματος του επιπέδου “☁” σβήνει. Το μέγιστο φορτίο μόνο για το πλύσιμο είναι 4 kg. Δεν μπορείτε να εξατομικεύσετε περαιτέρω το πρόγραμμα.

Για να ανοίξετε την πόρτα όσο ο αυτόματος κύκλος είναι σε εξέλιξη πατήστε το κουμπί START/PAUSE. Αν το σύμβολο πόρτας ασφαλισμένης είναι σβηστό μπορείτε να ανοίξετε την πόρτα αποκλειστικά κατά τη φάση πλυσίματος. Πατήστε εκ νέου το κουμπί START/PAUSE για να ξεκινήσει πάλι το πρόγραμμα από το σημείο διακοπής.

5. Στο τέλος του προγράμματος θα φωτιστεί η ένδειξη END.

Θήκη απορρυπαντικών

Το καλό αποτέλεσμα του πλυσίματος εξαρτάται επίσης και από τη σωστή δοσολογία του απορρυπαντικού: υπερβάλλοντας δεν πλένουμε αποτελεσματικότερα και συντελούμε στη δημιουργία κρούστας στα εσωτερικά μέρη του πλυντηρίου και στη μόλυνση του περιβάλλοντος.

! Μη χρησιμοποιείτε απορρυπαντικά για πλύσιμο στο χέρι, διότι παράγουν πολύ αφρό.

! Να χρησιμοποιείτε απορρυπαντικά σε σκόνη για ρούχα λευκά βαμβακερά και για την πρόπλυση και για πλυσίματα σε θερμοκρασία μεγαλύτερη των 60°C.

! Ακολουθήστε τις υποδείξεις που αναγράφονται στη συσκευασία του απορρυπαντικού.

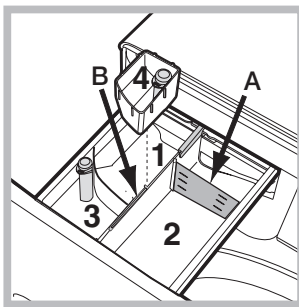

Βγάλτε τη θήκη απορρυπαντικών και εισάγετε το απορρυπαντικό ή το πρόσθετο ως εξής.

Διαμέρισμα 1: Απορρυπαντικό για πρόπλυση (σε σκόνη)

Πριν χύσετε το απορρυπαντικό ελέγξτε αν έχει εισαχθεί η πρόσθετη θήκη 4.

Διαμέρισμα 2: Απορρυπαντικό για πλύσιμο (σε σκόνη ή υγρό)

Σε περίπτωση χρήσης υγρού απορρυπαντικού, συστήνεται να χρησιμοποιείτε το δοσομετρητή **A** που σας παρέχεται για σωστή δοσολογία.

Για τη χρησιμοποίησή του απορρυπαντικού σε σκόνη αποθέστε το δοσομετρητή στην κοιλότητα **B**.

Διαμέρισμα 3: Πρόσθετα (μαλακτικό, κλπ.)

Το μαλακτικό δεν πρέπει να ξεπερνάει τη στάθμη «max» που υποδεικνύεται στον κεντρικό πείρο.

θήκη πρόσθετη 4: Λευκαντικό

Κύκλος λεύκανσης

Εισάγετε την πρόσθετη λεκανίτσα **4**, που σας παρέχεται, στο διαμέρισμα **1**. Στη δοσολογία του λευκαντικού μην ξεπεράσετε τη στάθμη «max» που υποδεικνύεται στον κεντρικό πείρο.

Για να κάνετε τη λεύκανση χύστε το λευκαντικό στην πρόσθετη λεκανίτσα **4** και θέστε το πρόγραμμα

! Η παραδοσιακή χλωρίνη χρησιμοποιείται για τα λευκά ανθεκτικά υφάσματα, η απαλή για τα χρωματιστά υφάσματα, τα συνθετικά και τα μάλλινα.

Προετοιμασία της μπουγάδας

- Χωρίστε τη μπουγάδα ανάλογα:
 - με το είδος του υφάσματος/ το σύμβολο της ετικέτας.
 - τα χρώματα: χωρίστε τα χρωματιστά ρούχα από τα λευκά.
- Εκκενώστε τις τσέπες και ελέγξτε τα κουμπιά.
- Μην ξεπερνάτε τις υποδεικνυόμενες τιμές στον “Πίνακα των Προγραμμάτων” σε σχέση με το βάρος της στεγνής μπουγάδας.

Πόσο ζυγίζει η μπουγάδα;

- 1 σεντόνι 400-500 gr.
- 1 μαξιλαροθήκη 150-200 gr.
- 1 τραπεζομάντιλο 400-500 gr.
- 1 μπουρνούζι 900-1200 gr.
- 1 πετσέτα 150-250 gr.

Ειδικά προγράμματα

Sport (πρόγραμμα **1**) σχεδιάστηκε για το πλύσιμο υφασμάτων αθλητικής ένδυσης (φόρμες, παντελονάκια, κλπ.) λίγο λερωμένα. Για να πετύχετε τα καλύτερα αποτελέσματα συστήνεται να μην ξεπερνάτε το μέγιστο φορτίο του “Πίνακα των Προγραμμάτων”. Συστήνεται η χρήση υγρού απορρυπαντικού, χρησιμοποιείτε μια δόση κατάλληλη για μισό φορτίο.

Σκουρόχρωμα: χρησιμοποιήστε το πρόγραμμα **2** για το πλύσιμο σκουρόχρωμων ρούχων. Το πρόγραμμα μελετήθηκε για τη διατήρηση των σκούρων χρωμάτων στο χρόνο. Για καλύτερα αποτελέσματα συνιστάται η χρήση υγρού απορρυπαντικού, κατά προτίμηση για το πλύσιμο σκουρόχρωμων ρούχων.

Επιλέγοντας τη λειτουργία στεγνώματος, στο τέλος του πλυσίματος εκτελείται αυτόματα ένα απαλό στέγνωμα που διατηρεί τα χρώματα των ρούχων. Η οθόνη θα εμφανίσει το επίπεδο “”. Μέγιστο Φορτίο: 3 kg.

Αντι-δυσσομία: χρησιμοποιήστε το πρόγραμμα **3** για το πλύσιμο των ρούχων για την απομάκρυνση των δυσσομιών (π.χ. τσιγαρίλα, ιδρώτας, τσίκνα). Το πρόγραμμα μελετήθηκε για την απομάκρυνση των δυσσομιών σεβόμενο τις ίνες των υφασμάτων.

Συστήνεται να πλένετε στους 40° τα συνθετικά ρούχα ή τα ανάμικτα φορτία και στους 60° τα ανθεκτικά βαμβακερά υφάσματα.

Ευαίσθητα: χρησιμοποιήστε το πρόγραμμα **4** για το πλύσιμο πολύ ευαίσθητων ρούχων. Συστήνεται το γύρισμα από την ανάποδη των ρούχων πριν το πλύσιμο. Για καλύτερα αποτελέσματα συστήνεται η χρήση υγρού απορρυπαντικού για ευαίσθητα ρούχα.

Επιλέγοντας τη λειτουργία στεγνώματος αποκλειστικά με χρόνο, στο τέλος του πλυσίματος εκτελείται ένα στέγνωμα ιδιαίτερα απαλό χάρη σε μια ελαφρά κίνηση και από ένα ρεύμα αέρα σε μια θερμοκρασία κατάλληλα ελεγχόμενη.

Οι προτεινόμενοι χρόνοι είναι:

1 kg συνθετικών --> 150 min.

1 kg συνθετικών και βαμβακερών --> 180 min.

1 kg βαμβακερών --> 180 min.

Ο βαθμός στεγνώματος εξαρτάται από το φορτίο και από τη σύνθεση του υφάσματος.

Μάλλινα: ο κύκλος πλυσίματος “Μάλλινα” αυτού του πλυντηρίου δοκιμάστηκε και εγκρίθηκε από την Woolmark Company για το πλύσιμο ρούχων που περιέχουν μάλλινες ίνες και που ταξινομούνται ως “πλενόμενα στο χέρι”, αρκεί το πλύσιμο να εκτελείται σύμφωνα με τις οδηγίες της ετικέτας του ενδύματος και τις υποδείξεις του κατασκευαστή του πλυντηρίου αυτού. (M1127)



Ταχεία 30' (πρόγραμμα **6**) αυτός κύκλος μελετήθηκε για το πλύσιμο ρούχων ελαφρά λερωμένων στους 30° (πλην μάλλινων και μεταξωτών) με ένα μέγιστο φορτίο 3 kg σε λίγο χρόνο: διαρκεί μόνο 30 λεπτά και έτσι εξοικονομεί χρόνο και ενέργεια.

Χρωματιστά: χρησιμοποιήστε τον κύκλο **10** για το πλύσιμο ανοιχτόχρωμων ρούχων. Το πρόγραμμα μελετήθηκε για τη διατήρηση της ζωντάνιας των χρωμάτων στο χρόνο.

Eco βαμβακερά 20° (πρόγραμμα **11**): ιδανικό για φορτία λερωμένων βαμβακερών. Οι καλές επιδόσεις και σε χαμηλή θερμοκρασία, συγκρίσιμες με ένα πλύσιμο στους 40°, εξασφαλίζονται από μια μηχανική δράση που λειτουργεί με μεταβολή ταχύτητας σε επαναλαμβανόμενες και κοντινές αυξομειώσεις.

Eco Συνθετικά (πρόγραμμα **12**) ιδανικό για ανάμικτα φορτία (βαμβακερά και συνθετικά) κανονικά λερωμένα. Οι καλές επιδόσεις πλυσίματος και σε χαμηλή θερμοκρασία εξασφαλίζονται από μια μηχανική δράση που λειτουργεί με μεταβολή ταχύτητας σε καθορισμένα και μεσαία διαστήματα.

ΚΑΘΑΡΑ&ΣΤΕΓΝΑ 45' (πρόγραμμα **13**) μελετήθηκε για πλύσιμο και στέγνωμα ρούχων ελαφρά λερωμένων σε λίγο χρόνο. Επιλέγοντας τον κύκλο αυτόν μπορείτε να πλύνετε και να στεγνώσετε μέχρι 1 kg μπουγάδας σε μόνο 45 λεπτά. Για να πετύχετε τα βέλτιστα αποτελέσματα χρησιμοποιείτε υγρό απορρυπαντικό. Προπλύνετε μανικέτια, λαιμούς και λεκέδες.

AirFresh (πρόγραμμα **14**) ιδανικός κύκλος για το φρεσκάρισμα και την απομάκρυνση σε 30' των δυσσομιών από βαμβακερά και συνθετικά (max 1,5kg), ειδικότερα του καπνού, χωρίς τη φάση πλυσίματος.

Σύστημα ισοστάθμισης του φορτίου

Πριν από κάθε στύψιμο, για να αποφύγετε δονήσεις υπερβολικές και για να κατανείμετε ομοιόμορφα το φορτίο, ο κάδος διενεργεί περιστροφές σε μια ταχύτητα ελαφρά ανώτερη εκείνης του πλυσίματος. Αν στο τέλος των διαδοχικών προσπαθειών το φορτίο δεν έχει ακόμη εξισορροπηθεί σωστά η μηχανή διενεργεί το στύψιμο σε μια ταχύτητα χαμηλότερη της προβλεπόμενης. Παρουσία υπερβολικής αστάθειας, το πλυντήριο διενεργεί την κατανομή αντί του στυψίματος. Για να ευνοηθεί καλύτερη κατανομή του φορτίου και της σωστής εξισορρόπησης συνιστάται η ανάμιξη ρούχων μεγάλων και μικρών διαστάσεων.

Μπορεί να συμβεί το πλυντήριο να μη λειτουργεί. Πριν τηλεφωνήσετε στην Υποστήριξη(βλέπε “Υποστήριξη”), ελέγξτε αν δεν πρόκειται για πρόβλημα που επιλύεται εύκολα με τη βοήθεια του ακόλουθου καταλόγου.

Ανωμαλίες:

Το πλυντήριο δεν ανάβει.

Ο κύκλος πλυσίματος δεν ξεκινάει.

Το πλυντήριο δεν φορτώνει νερό (Στην οθόνη απεικονίζεται η ένδειξη H2O να).

Το πλυντήριο φορτώνει και αδειάζει νερό συνεχώς.

Το πλυντήριο δεν φορτώνει ή δεν σύβει.

Το πλυντήριο δονείται πολύ κατά το σύψιμο.

Το πλυντήριο χάνει νερό.

Τα ενδεικτικά φωτάκια των “Δυνατοτήτων” και της “START/PAUSE” αναβοσβήνουν γρήγορα και η οθόνη απεικονίζει έναν κωδικό ανωμαλίας (π.χ.: F-01, F-..).

Σχηματίζεται πολύς αφρός.

Δεν ενεργοποιείται το Push&Wash+Dry.

Το Πλυντήριο με Στεγνωτήριο δεν στεγνώνει

Δυνατά αίτια / Λύση:

- Το βύσμα δεν έχει εισαχθεί στην ηλεκτρική πρίζα ή τουλάχιστον όχι αρκετά για να κάνει επαφή.
 - Στο σπίτι δεν υπάρχει ρεύμα.
 - Η πόρτα δεν είναι καλά κλειστή.
 - Το κουμπί ON/OFF δεν έχει πατηθεί.
 - Το κουμπί START/PAUSE δεν πατήθηκε.
 - Η βρύση του νερού δεν είναι ανοιχτή.
 - Τέθηκε μια καθυστέρηση στην ώρα εκκίνησης.
 - Ο σωλήνας τροφοδοσίας του νερού δεν είναι συνδεδεμένος στον κρουνό.
 - Ο σωλήνας είναι διπλωμένος.
 - Η βρύση του νερού δεν είναι ανοιχτή.
 - Στο σπίτι λείπει το νερό.
 - Δεν υπάρχει αρκετή πίεση.
 - Το κουμπί START/PAUSE δεν πατήθηκε.
 - Ο σωλήνας αδειάσματος δεν έχει εγκατασταθεί μεταξύ 65 και 100 cm από το έδαφος (βλέπε “Εγκατάσταση”).
 - Το άκρο του σωλήνα αδειάσματος είναι βυθισμένο στο νερό (βλέπε “Εγκατάσταση”).
 - Το επιποίχιο άδειασμα δεν έχει απαέρωση.
- Αν μετά από αυτούς τους ελέγχους το πρόβλημα δεν λύνεται, κλείστε τη βρύση του νερού, σβήστε το πλυντήριο και καλέστε την υποστήριξη. Αν η κατοικία βρίσκεται στους τελευταίους ορόφους ενός κτιρίου, μπορεί να διαπιστωθούν φαινόμενα σιφωνισμού, οπότε το πλυντήριο φορτώνει και αδειάζει νερό συνεχώς. Για την αντιμετώπιση του προβλήματος διατίθενται στο εμπόριο κατάλληλες βαλβίδες αντι-σιφωνισμού.
- Το πρόγραμμα δεν προβλέπει το άδειασμα: με ορισμένα προγράμματα πρέπει να το ενεργοποιείτε χειροκίνητα.
 - Ο σωλήνας αδειάσματος είναι διπλωμένος (βλέπε “Εγκατάσταση”).
 - Ο αγωγός αδειάσματος είναι βουλωμένος.
 - Ο κάδος, τη στιγμή της εγκατάστασης, δεν ξεμπλόκαρε σωστά (βλέπε “Εγκατάσταση”).
 - Το πλυντήριο δεν είναι οριζοντιωμένο (βλέπε “Εγκατάσταση”).
 - Το πλυντήριο είναι πολύ στενά μεταξύ τοίχου και επίπλων (βλέπε “Εγκατάσταση”).
 - Ο σωλήνας τροφοδοσίας του νερού δεν είναι καλά βιδωμένος (βλέπε “Εγκατάσταση”).
 - Η θήκη των απορρυπαντικών είναι βουλωμένη (για να την καθαρίσετε βλέπε “Συντήρηση και φροντίδα”).
 - Ο σωλήνας αδειάσματος δεν έχει στερεωθεί καλά (βλέπε “Εγκατάσταση”).
- Σβήστε τη μηχανή και βγάλτε το βύσμα από την πρίζα, περιμένετε περίπου 1 λεπτό μετά ξανανάψτε τη.
Αν η ανωμαλία επιμένει, καλέστε την Υποστήριξη.
- Το απορρυπαντικό δεν είναι ειδικό για πλυντήριο (πρέπει να υπάρχει η ένδειξη “για πλυντήριο”, “για πλύσιμο στο χέρι και στο πλυντήριο”, ή παρόμοια).
 - Η δοσολογία υπήρξε υπερβολική.
 - Μετά το άναμμα της μηχανής ενεργοποιήθηκε μια εντολή διαφορετική από το Push&Wash+Dry. Σβήστε τη μηχανή και πατήστε το κουμπί Push&Wash+Dry.
 - Το βύσμα δεν έχει εισαχθεί στην ηλεκτρική πρίζα, ή τουλάχιστον όχι αρκετά για να κάνει επαφή.
 - Στο σπίτι δεν υπάρχει ρεύμα.
 - Η πόρτα δεν είναι καλά κλειστή.
 - Τέθηκε μια καθυστέρηση στον χρόνο εκκίνησης.
 - Το ΣΤΕΓΝΩΜΑ είναι στη θέση **OFF**.

Υποστήριξη

GR

Πριν επικοινωνήσετε με την Υποστήριξη:

- Ελέγξτε αν την ανωμαλία μπορείτε να την αντιμετωπίσετε μόνοι σας (βλέπε “Ανωμαλίες και λύσεις”);
- Επανεκκινήστε το πρόγραμμα για να ελέγξετε αν το πρόβλημα αντιμετωπίστηκε;
- Σε αρνητική περίπτωση, επικοινωνήστε με ένα Κέντρο Τεχνικής Υποστήριξης.

! Μην καταφεύγετε ποτέ σε μη εξουσιοδοτημένους τεχνικούς.

Γνωστοποιήστε:

- το είδος της ανωμαλίας;
- το μοντέλο του μηχανήματος (Mod.);
- τον αριθμό σειράς (S/N).

Οι πληροφορίες αυτές βρίσκονται στην ταμπελίτσα που υπάρχει στο πίσω μέρος του πλυντηρίου και στο πρόσθιο μέρος ανοίγοντας την πόρτα.

!  Acest simbol îți amintește să citești acest manual de instrucțiuni.

RO

RO

Română

XWDE 961480

Sumar

Instalare, 30-31

Despachetare și punere la nivel
Racorduri hidraulice și electrice
Primul ciclu de spălare
Date tehnice

Întreținere și curățire, 32

Înteruperea alimentării cu apă și curent electric
Curățarea mașinii de spălat
Curățarea sertarului pentru detergenți
Îngrijirea ușii și a tamburului
Curățarea pompei
Controlarea furtunului de alimentare cu apă

Precauții și sfaturi, 33

Siguranța generală
Scoaterea aparatului din uz
Deschiderea manuală a ușii

Descrierea mașinii de spălat, 34-35

Panoul de control
Display

Cum se efectuează un ciclu de splare sau de uscare, 36

Programe și opțiuni, 37-38

Tabel de programe
Opțiuni de spălare
Push&Wash+Dry

Detergenți și rufe, 39-40

Sertarul detergenților
Ciclu de albire
Pregătirea rufelor
Programe particulare
Sistemul de echilibrare a încărcăturii

Anomalii și remedii, 41

Asistență, 42

Instalare

RO

! Este important să păstrați acest manual pentru a-l putea consulta în orice moment. În caz de vânzare, de cesiune sau de schimbare a locuinței, acesta trebuie să rămână împreună cu mașina de spălat pentru a informa noul proprietar cu privire la funcționare și la respectivele avertismente. ! Citiți cu atenție instrucțiunile: veți găsi informații importante cu privire la instalare, la folosire și la siguranță.

Despachetare și punere la nivel

Despachetare

1. Scoaterea din ambalaj a mașinii de spălat.
2. Controlați ca mașina de spălat să nu fi fost deteriorată în timpul transportului. Dacă este deteriorată, nu o conectați și contactați agentul de vânzare.

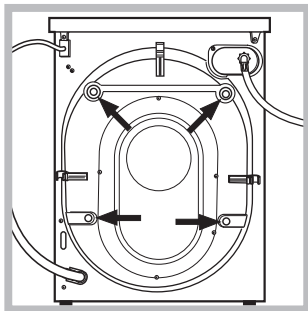

3. Scoateți cele 4 șuruburi de protecție pentru transport și cauciucul cu distanțierul respectiv, situate în partea posterioară (a se vedea figura).

4. Închideți orificiile cu dopurile din plastic aflate în dotare.
5. Păstrați toate piesele: pentru cazul în care mașina de spălat va trebui să fie transportată, piesele vor trebui montate din nou. ! Ambalajele nu sunt jucării pentru copii!

Punere la nivel

1. Instalați mașina de spălat pe un paviment plan și rigid, fără a o sprijini de ziduri, mobilă sau altceva.

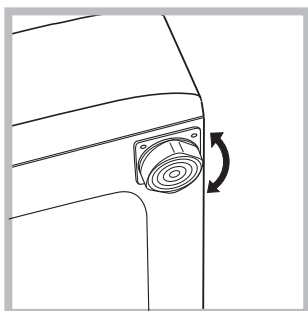

2. Dacă podeaua nu este perfect orizontală, compensați neregularitățile deșurubând sau înșurubând picioarele anterioare (a se vedea figura); unghiul de înclinare, măsurat pe planul de

lucru, nu trebuie să depășească 2°.

O nivelare precisă conferă stabilitate mașinii și evită vibrații, zgomote și deplasări pe timpul funcționării. În cazul mochetelor sau a unui covor, reglați picioarele astfel încât să mențineți sub mașina de spălat un spațiu suficient pentru ventilare.

Racorduri hidraulice și electrice

Racordarea furtunului de alimentare cu apă

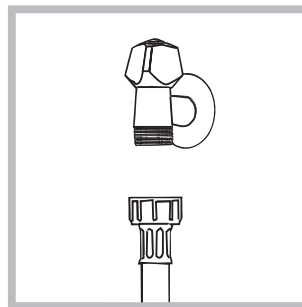

1. Conectați furtunul de alimentare, înșurubându-l la un robinet de apă rece cu gura filetată de l gaz (a se vedea figura). Înainte de conectare, lăsați apa să curgă până când nu a devenit limpede.

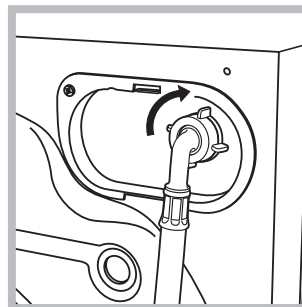

2. Conectați tubul de alimentare la mașina de spălat, înșurubându-l la priza de apă respectivă, amplasată în partea posterioară, sus în dreapta (a se vedea figura).

3. Fiți atenți ca furtunul să nu fie nici pliat, nici îndoit.

! Presiunea apei de la robinet trebuie să fie cuprinsă în valorile din tabelul cu Date tehnice (a se vedea pagina alăturată).

! Dacă lungimea furtunului de alimentare nu este suficientă, adresați-vă unui magazin specializat sau unui instalator autorizat.

! Nu folosiți niciodată tuburi folosite deja.

! Utilizați tuburile furnizate cu mașina.

Conectarea furtunului de golire

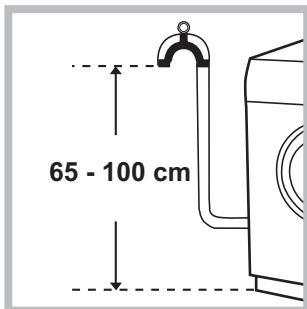

Conectați furtunul de evacuare, fără al îndoii, la o conductă sau la o gură de evacuare în zid, situate între 65 și 100 cm de pământ;

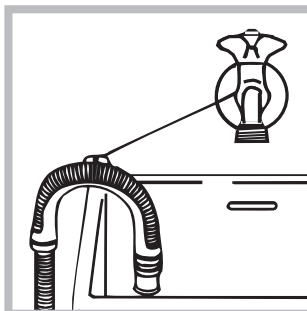

sau sprijiniți pe marginea unei chiuvete sau a unei căzi, legând elementul de ghidare la robinet (a se vedea figura). Capătul liber al furtunului de golire nu trebuie să rămână cufundat în apă.

! Nu se recomandă folosirea furtunurilor prelungitoare; dacă este indispensabil, acestea trebuie să aibă același diametru ca și furtunul original și nu trebuie să depășească 150 cm lungime.

Racordarea electrică

Înainte de a introduce ștecherul în priză de curent, asigurați-vă că:

- priza să fie cu împământare și conformă prevederilor legale;
- priza să poată suporta sarcina maximă de putere a mașinii, indicată în tabelul cu Date tehnice (a se vedea alături);
- tensiunea de alimentare să fie cuprinsă în valorile indicate în tabelul cu Date tehnice (a se vedea alături);
- priza să fie compatibilă cu ștecherul mașinii de spălat. În caz contrar înlocuiți priza sau ștecherul.

! Mașina de spălat nu trebuie instalată afară, nici chiar în cazul în care spațiul este adăpostit, deoarece este foarte periculoasă expunerea mașinii la ploaie și furtuni.

! După instalarea mașinii de spălat, priza de curent trebuie să fie ușor accesibilă.

! Nu folosiți prelungitoare și prize multiple.

! Cablul nu trebuie să fie îndoit sau comprimat.

! Cablul de alimentare trebuie să fie înlocuit doar de instalatorii autorizați.

Atenție! Firma își declină orice responsabilitate în cazul în care aceste norme nu se respectă.

Primul ciclu de spălare

După instalare, înainte de folosire, efectuați un ciclu de spălare cu detergent și fără rufe, selectând programul „AUTOCURĂȚARE” (a se vedea „Curățarea mașinii de spălat”).

Date tehnice

Model	XWDE 961480
Dimensiuni	lățime 59,5 cm înălțime 85 cm profundime 60,5 cm
Capacitate	de la 1 la 9 kg pentru spălare de la 1 la 6 kg pentru uscare
Legături electrice	Vezi placuta cu caracteristicile tehnice, aplicata pe masina.
Legături hidrice	presiune maximă 1 MPa (10 bari) presiune minimă 0,05 MPa (0,5 bari) capacitatea cuvei 62 litri
Viteza de centrifugare	până la 1400 de rotații pe minut
Programe de control pe baza normei EN 50229	spălare: programul 8 temperatura 60°C; efectuată cu 9 kg de rufe. uscare: uscarea cantității mai mici (3kg) trebuie efectuată selectând nivelul de uscare “☀”, cantitatea de lenjerie trebuie să se compună din 3 cearceafuri, 2 fețe de pernă și 1 prosoape; uscarea cantității rămase trebuie să se facă prin selectarea nivelului de uscare “☀”.
 	Acest aparat este conform cu următoarele Directive Comunitare: - 2004/108/CE (Compatibilitate Electromagnetică) - 2006/95/CE (Tensiuni Joase) - 2012/19/EU

Întreținere și curățare

RO

Înteruperea alimentării cu apă și curent electric

- Închideți robinetul de apă după fiecare spălare. Se limitează astfel uzura instalației hidraulice a mașinii de spălat și se elimină pericolul scurgerilor.
- Scoateți ștecărul din priza de curent atunci când curățați mașina de spălat și când se efectuează lucrări de întreținere.

Curățarea mașinii de spălat

• Partea externă și părțile din cauciuc pot fi curățate cu o lavetă înmuiată în apă caldă și săpun. Nu folosiți solvenți sau substanțe abrazive.

• Mașina de spălat este prevăzută cu un program de „AUTOCURĂȚARE” a pieselor interne care trebuie realizat **fără niciun fel de încărcătură în cuvă**.

Detergentul (în cantitate de 10% din cea recomandată pentru rufe puțin murdare) sau aditivii specifici pentru curățarea mașinii de spălat pot fi folosite ca mijloace auxiliare în programul de spălare. Se recomandă efectuarea programului de curățare la fiecare 40 de cicluri de spălare.

Pentru a activa programul, apăsați butoanele **A** și **B** în același timp pentru 5 secunde (a se vedea figura).

Programul pornește automat și durează aproximativ 70 de minute. Pentru a termina ciclul, apăsați butonul START/PAUSE.

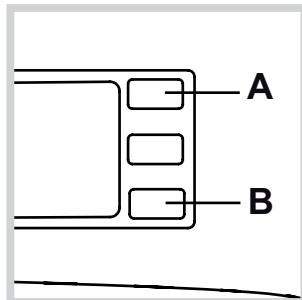

Curățarea sertarului pentru detergenți

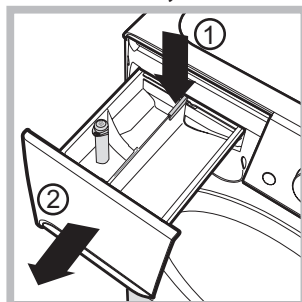

Pentru a scoate sertarul, apăsați pe levierul (1) și trageți-l spre exterior (2) (a se vedea figura).

Spălați-l sub un jet de apă; această operație trebuie efectuată cât mai des posibil.

Îngrijirea ușii și a tamburului

- Lăsați mereu ușa întredeschisă pentru a evita formarea de mirosuri neplăcute.

Curățarea pompei

Mașina de spălat este dotată cu o pompă de autocurățare care nu are nevoie de întreținere. Se poate întâmpla însă ca unele obiecte mici (monede, nasturi) să cadă în anticamera care protejează pompa, situată în partea inferioară a acesteia.

! Verificați ca ciclul de spălare să fie încheiat și scoateți ștecărul din priză.

Pentru a avea acces la anticameră:

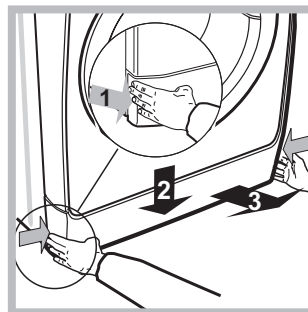

1. Îndepărtați panoul de acoperire de pe latura anterioară a mașinii, apăsând spre centru, apoi împingeți în jos de pe ambele laturi și scoateți-l (a se vedea figurile).

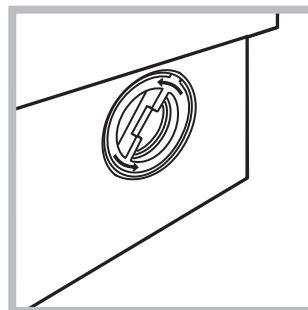

2. deșurubați capacul rotindu-l în sens antiorar (a se vedea figura). este normal să iasă puțină apă;

3. curățați cu grijă interiorul;
4. înșurubați la loc capacul;
5. montați din nou panoul verificând, înainte de a-l împinge spre mașină, de a fi introdus cârligele în orificiile respective.

Controlarea furtunului de alimentare cu apă

Controlați tubul de alimentare cel puțin o dată pe an. Dacă prezintă crăpături sau fisuri trebuie înlocuit: pe parcursul spălărilor, presiunea puternică ar putea provoca crăpături neașteptate.

! Nu folosiți niciodată tuburi folosite deja.

! Mașina de spălat a fost proiectată și construită conform normelor internaționale de protecție. Aceste avertizări sunt furnizate din motive de siguranță și trebuie să fie citite cu atenție.

Siguranța generală

- Acest aparat a fost conceput exclusiv pentru utilizarea în locuințe.
 - Aparatul nu trebuie utilizat de către persoane (inclusiv copii) cu capacități fizice, senzoriale sau mentale reduse și cu experiență sau cunoștințe insuficiente, exceptând cazul în care această utilizare are loc sub supravegherea sau instrucțiunile unei persoane responsabile cu securitatea lor. Copiii trebuie supravegheați pentru a vă asigura că nu se joacă cu aparatul.
 - Nu uscați rufele nespălate.
 - Rufe murdărite cu substanțe precum ulei comestibil, acetonă, alcool, benzină, kerosen, substanțe de scos petele, rășină, ceară și substanțele de îndepărtare a acestora trebuie spălate în apă caldă cu o cantitate mai mare de detergent înainte de a le usca în mașina de uscat.
 - Obiectele precum cauciuc expandat (spumă de latex), cască de duș, materiale textile impermeabile, articole cu o parte din cauciuc și haine sau perne care au părți din spumă de latex nu trebuie uscate în mașina de uscat.
 - Emolientele sau produsele similare trebuie folosite conform instrucțiunilor producătorului.
 - Partea finală a unui ciclu al mașinii de uscat are loc fără căldură (ciclu de răcire) pentru ca articolele să nu fie deteriorate.
- ATENȚIE: Nu opriți niciodată mașina înainte de terminarea programului de uscare. În acest caz scoateți repede toate rufe și întindeți-le pentru a le răci rapid.
- Nu atingeți mașina când sunteți desculți sau cu mâinile sau picioarele ude sau umede.
 - Nu scoateți ștecherul din priză trăgând de cablu, ci apucând ștecherul.
 - Nu deschideți sertarul detergentilor în timp ce mașina se află în funcțiune.
 - Nu atingeți apă de evacuare: poate avea o temperatură ridicată.
 - Nu forțați în nici un caz ușa: s-ar putea deteriora mecanismul de siguranță care evită deschiderea accidentală.
 - În caz de defecțiune, nu umblați în niciun caz la mecanismele din interior și nu încercați să o reparați singuri.
 - Controlați mereu ca în apropierea mașinii aflate în funcțiune, să nu se afle copii.
 - Pe durata spălării ușa se poate încălzi.
 - Dacă trebuie să deplasați mașina, cereți ajutor unei alte (sau 2) persoane și fiți foarte atenți. Niciodată nu deplasați mașina singuri deoarece aceasta este foarte grea.
 - Înainte de a introduce rufe, controlați ca și cuva să fie goală.
 - În timpul uscării, ușa mașinii de spălat se încălzește.
 - Nu uscați rufe pe care le-ați spălat cu solvenți inflamabili (de ex. trielină).
 - Nu uscați rufe cu aplicații din cauciuc sintetic sau elastomeri asemănători.
 - Fiți atenți ca pe durata fazelor de uscare robinetul de apă să fie deschis.

Scoaterea din uz

- Eliminarea ambalajelor: respectați reglementările locale, în acest fel ambalajele vor putea fi refolosite.
- Directiva Europeană 2012/19/EU cu privire la deșeurile care provin de la aparatura electrică sau electronică prevede ca aparatele electrocasnice să nu fie colectate împreună cu deșeurile urbane solide, obișnuite.

Aparatele scoase din uz trebuie să fie colectate separat atât pentru a optimiza rata de recuperare și de reciclare a materialelor componente cât și pentru a evita pericolele care pot afecta sănătatea omului sau polua mediul înconjurător. Simbolul tomberonului tăiat care apare pe toate produsele vă amintește tocmai obligația de a le colecta separat. Pentru informații suplimentare cu privire la scoaterea din uz a electrocasnicelor, deținătorii acestora pot apela la centrele de colectare a deșeurilor sau la vânzătorii de la care au achiziționat produsele respective.

Deschiderea manuală a ușii

Dacă nu este posibil să deschideți ușa din cauza întreruperii curentului electric și doriți totuși să întindeți rufe, procedați după cum urmează:

1. scoateți ștecherul din priză.

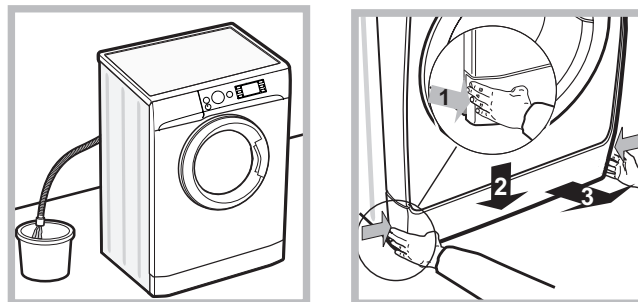

2. verificați ca nivelul de apă din mașină să fie sub marginea ușii; în caz contrar, scoateți apa în exces cu ajutorul furtunului de golire, punând-o într-un vas, după indicațiile din figura.
3. scoateți panoul de acoperire din partea din față a mașinii de spăla (a se vedea figura).

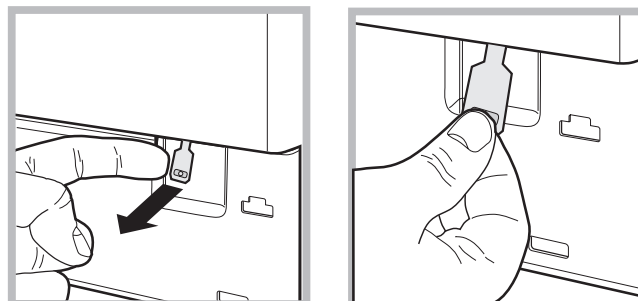

4. utilizând dispozitivul indicat în figură, trageți spre dumneavoastră până când eliberați tirantul de plastic din opritor; trageți apoi în jos și, în același timp, deschideți ușa.
5. montați din nou panoul verificând, înainte de a-l împinge spre mașină, de a fi introdus cârligele în orificiile respective.

Descrierea mașinii de spălat

RO

Panoul de control

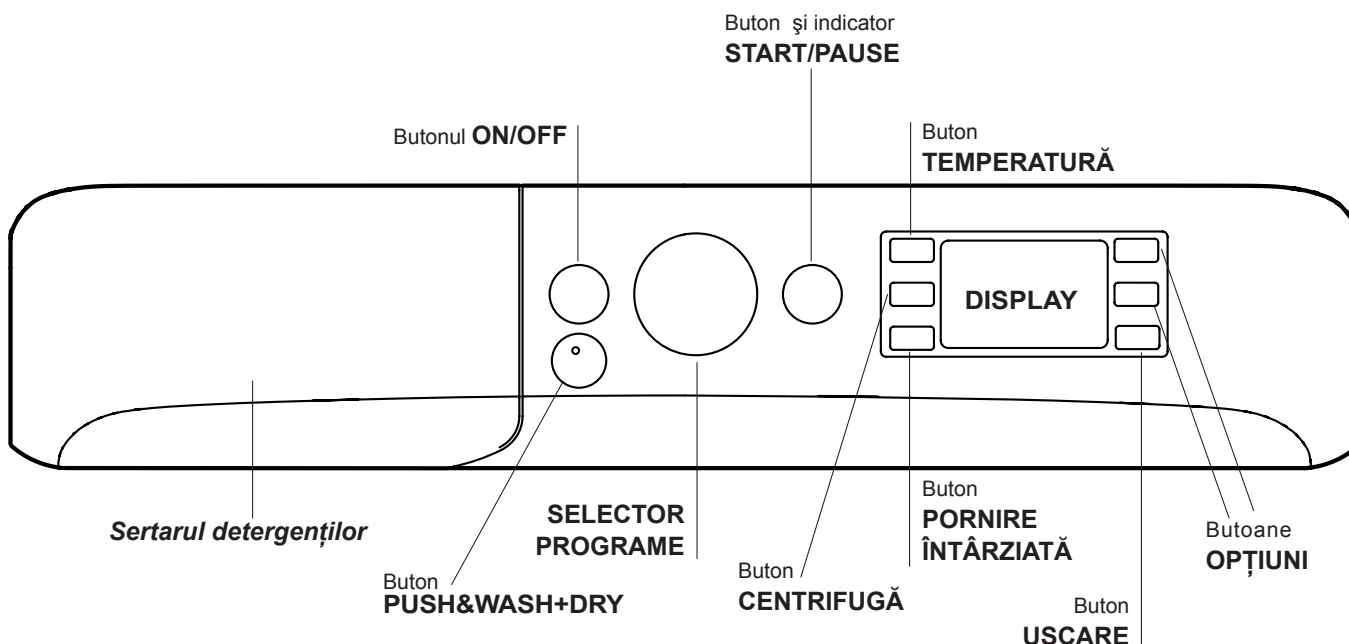

Sertarul detergenților: pentru a introduce detergenții sau aditivele (a se vedea "Detergenți și rufe").

Buton **ON/OFF** : apăsați scurt butonul pentru a porni sau opri mașina de spălat. Indicatorul **START/PAUSE** emite un semnal intermitent de culoare verde, ceea ce vă confirmă pornirea mașinii. Pentru a opri funcționarea mașinii de spălat în timpul spălării, este necesar să țineți apăsată butonul circa 3 secunde; o apăsare de scurtă durată sau accidentală nu va opri mașina. Oprirea mașinii de spălat în timpul executării unui ciclu va anula programul în curs de desfășurare.

Buton **PUSH&WASH+DRY**: (a se vedea "Programe și opțiuni").

SELECTOR PROGRAME: pentru a alege programul dorit (a se vedea "Tabel programe").



Butoane **OPȚIUNE**: pentru a selecta opțiunile disponibile. Indicatorul privind opțiunea selectată va rămâne aprins.

Buton **TEMPERATURĂ** : apăsați butonul pentru a diminua sau exclude temperatura; valoarea acesteia va fi afișată pe display.

Buton **CENTRIFUGĂ** : apăsați butonul pentru a reduce numărul de rotații sau a bloca storcătorul; numărul de turații se poate vedea pe display.

Buton **PORNIRE ÎNTÂRZIATĂ** : apăsați pentru a seta sau pornire întârziată a programului preselectat; întârzierea este indicată pe display.

Buton **USCARE** : apăsați pentru a reduce sau exclude uscarea; nivelul și durata de uscare alese vor fi afișate pe ecran (a se vedea „Cum se efectuează un ciclu de spălare sau de uscare”).

Buton și indicator **START/PAUSE** : când ledul verde emite un semnal intermitent, apăsați butonul pentru a porni ciclul de spălare. După activarea ciclului, ledul rămâne aprins. Pentru a introduce o pauză în timpul spălării, apăsați din nou butonul ledul va lumina intermitent, de culoare aurie. După stingerea indicatorului luminos , puteți deschide ușa. Pentru a continua spălarea, de unde a fost întreruptă, apăsați din nou butonul.

Modalitatea de stand by

Această mașină de spălat rufe, conform noilor norme legate de economia de curent electric, este dotată cu un sistem de oprire automat (stand-by) care intră în funcțiune după 30 minute de neutilizare. Apăsați scurt tasta **ON/OFF** și așteptați repunerea în funcțiune a mașinii.

Consum în off-mode: 0,5 W

Consum în Left-on: 8 W

Display

RO

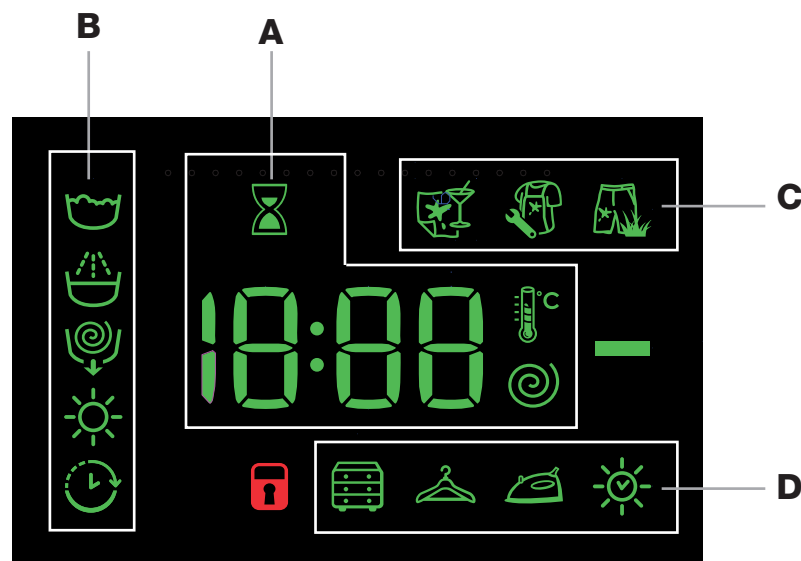

Ecranul este util pentru a programa mașina și a furniza numeroase informații.

În secțiunea **A** este afișată durata diferitelor programe la dispoziție și a celui rămas, în cazul unui ciclu de spălare deja în desfășurare; dacă a fost programat un interval de PORNIRE ÎNTÂRZIATĂ, este afișat intervalul rămas până la pornirea programului selectat.

În plus, prin apăsarea tastei corespunzătoare, sunt afișate valorile maxime ale vitezei de centrifugare, ale temperaturii și timpului de uscare pe care mașina le poate realiza în baza programului selectat sau a ultimelor valori selectate dacă sunt compatibile cu programul ales.

Clepsidra se va aprinde intermitent în momentul în care mașina elaborează datele în funcție de programul selectat. După max. 10 minute de la pornire pictograma "clepsidră" luminează continuu și se afișează timpul rămas definitiv. Pictograma clepsidră se va stinge apoi după circa 1 minut de la afișarea timpului rămas definitiv.

În secțiunea **B** sunt afișate „fazele de spălare” prevăzute pentru ciclul selecționat și cele în curs de desfășurare, în cazul unui program deja pornit:

-  Spălare
-  Clătire
-  Centrifugă/Golire
-  Uscare

Simbolul "Pornire întârziată"  iluminat indică faptul că pe display este afișată valoarea "Pornirii întârziată" setate.

În secțiunea **C** sunt prezente cele trei nivele referitoare la opțiunile de spălare.

În secțiunea **D** sunt prezente pictogramele referitoare la cele trei niveluri de uscare și pictograma  care se aprinde când se setează o uscare temporizată.

Indicator UȘĂ BLOCATĂ!

Iluminarea simbolului indică blocarea hubloului. Pentru a evita daune este necesar să se aștepte ca simbolul să se stingă înainte de a deschide ușa. Pentru a deschide ușa în timpul executării unui ciclu, apăsați butonul START/PAUSE; când simbolul UȘĂ BLOCATĂ!  se stinge, puteți deschide ușa.

Cum se efectuează un ciclu de spălare sau de uscare

RO

Programarea rapidă

- 1. INTRODUCEREA RUFELOR** Deschideți ușa. Introduceți rufe în mașină, fiind atenți să nu depășiți cantitatea indicată în tabelul de programe - a se vedea pagina următoare.
- 2. DOZAREA DETERGENTULUI** Extrageți sertarul și turnați detergent în compartimentele respective, după indicațiile din capitolul "Detergenți și rufe".
- 3. ÎNCHIDEȚI UȘA.**
4. Apăsăți tasta "Push&Wash+Dry" pentru a activa programul ales.

Programarea tradițională

- 1. PUNEREA ÎN FUNCȚIUNE A MAȘINII** Apăsăți butonul ; indicatorul START/PAUSE va lumina intermitent lent cu culoarea verde.
- 2. INTRODUCEREA RUFELOR** Deschideți ușa. Introduceți rufe în mașină, fiind atenți să nu depășiți cantitatea indicată în tabelul de programe - a se vedea pagina următoare.
- 3. DOZAREA DETERGENTULUI** Extrageți sertarul și turnați detergent în compartimentele respective, după indicațiile din capitolul "Detergenți și rufe".
- 4. ÎNCHIDEȚI UȘA.**
- 5. ALEGEREA PROGRAMULUI** Selectați cu butonul PROGRAME programul dorit; acestuia îi sunt asociate o temperatură și o viteză de centrifugă care pot fi modificate. Pe ecran va apărea și durata ciclului.
- 6. PERSONALIZAREA CICLULUI DE SPĂLARE.** Apăsăți butoanele: respective.
 Modificarea temperaturii și/sau a centrifugei. Mașina afișează automat temperatura și centrifuga maxime prevăzute pentru programul ales, sau ultimele selectate, dacă sunt compatibile cu programul. Apăsând butonul se reduce progresiv temperatura pînă spălarea rece "OFF". Apăsând butonul se reduce progresiv centrifuga pînă la excluderea sa "OFF". Din acest moment, apăsarea ulterioară a butonelor va aduce valorile la cele maxime prevăzute.
! Excepție: dacă selectați programul 8 temperatura poate fi crescută pînă la 90°.

Alegerea programului de uscare

La prima apăsare a tastei , mașina alege automat nivelul de uscare maxim, compatibil cu programul selectat. Următoarele apăsări reduc nivelul și ulterior durata de uscare, pînă la excluderea completă a fazei (OFF).

Sunt prevăzute două posibilități:

A - În funcție de gradul de umiditate al rufelor de uscat:

Uscat : Ideal ptr hainele de pus în dulap, fără călcare.

Mediu : Indicat ptr rufe care nu au nevoie de o uscare completă.

Călcare : Indicat ptr rufe ce necesită călcare. Nivelul de umiditate reziduală înmoaie pliurile și deci facilitează întinderea lor, prin călcare.

B - În funcție de timp: de la **210** la **30** de minute.

La încheierea procesului de uscare se activează o fază de răcire. Dacă în mod excepțional cantitatea de rufe de spălat și uscat este superioară maximumului prevăzut, efectuați spălarea, iar la încheierea programului, subdivizați cantitatea și repuneți o parte în mașină. După care urmați instrucțiunile prevăzute pentru efectuarea **doar a uscării**. Repetați aceeași procedură pentru rufe rămase.

N.B.: la sfârșitul uscării are loc întotdeauna o perioadă de răcire.

Doar uscare

Apăsăți tasta pentru a efectua doar uscarea. După ce ați selectat programul dorit compatibil cu tipul de rufe de tratat, la apăsarea tastei se exclude faza de spălare și va fi activată uscarea cu nivelul maxim prevăzut pentru programul selectat. Se poate modifica și seta nivelul sau durata uscării apăsând tasta uscare . (Nu este compatibil cu programele 13 și 14).

Setări pornirea întârziată.

Pentru a programa pornirea întârziată a mașinii, apăsăți butonul respectiv pentru a alege timpul de întârziere dorit. Când această opțiune este activată, pe display se aprinde simbolul . Pentru a șterge pornirea întârziată, apăsăți butonul pînă când pe ecran vedeți inscripția "OFF".

Modificarea caracteristicilor ciclului.

- Apăsăți butonul pentru a activa opțiunea; indicatorul corespunzător butonului se va aprinde.
- Apăsăți din nou butonul pentru a dezactiva această opțiune; indicatorul luminos respectiv se va stinge.

! Dacă opțiunea selectată nu este compatibilă cu programul ales, ledul corespunzător va semnaliza iar funcția nu se va activa.

! Dacă opțiunea selectată nu este compatibilă cu alta setată anterior, incompatibilitatea va fi semnalată prin aprinderea intermitentă a ledului și printr-un semnal acustic (3 bip) și va fi activată numai a doua, indicatorul opțiunii activate se va aprinde.

! Cantitatea de rufe admisă precum și durata ciclului pot varia în funcție de funcția aleasă.

- 7. ACTIVAREA UNUI PROGRAM.** Apăsăți butonul START/PAUSE. Indicatorul luminos se va aprinde - culoare verde și ușa se va bloca (simbolul UȘĂ BLOCATĂ se va aprinde). Pentru a modifica un program în timpul executării unui ciclu, apăsăți butonul START/PAUSE pentru a întrerupe momentan ciclul; indicatorul corespunzător butonul START/PAUSE se va aprinde intermitent (culoarea aurie) și alegeți noul ciclu dorit și apăsăți din nou butonul START/PAUSE. Pentru a deschide ușa în timpul executării unui ciclu, apăsăți butonul START/PAUSE; când simbolul UȘĂ BLOCATĂ se stinge, puteți deschide ușa. Apăsăți din nou butonul START/PAUSE pentru a relua programul de unde era oprit.
- 8. TERMINAREA PROGRAMULUI** La încheierea ciclului, pe ecran va apărea mesajul "END"; când simbolul UȘĂ BLOCATĂ se stinge, puteți deschide ușa. Deschideți ușa, scoateți rufe și opriți mașina de spălat.

! Dacă doriți să anulați un ciclu deja activat, apăsăți îndelung butonul . Ciclul se va întrerupe iar mașina se va opri.

Tabel de programe

Programe	Descrierea Programului	Temp. max. (°C)	Viteza max. (rotații pe minut)	Uscare	Cantitatea maximă pentru uscare (Kg)	Detergenți și aditivi				Cantitatea maximă pentru spălare (Kg)	Durata ciclului	
						Prespălare	Spălare	Balsam rufe	Decolorant			
Programe Speciale												
1	Sport	30°	600	●	4	-	●	●	-	4	Puteți vizualiza durata programelor de spălare pe display.	
2	Rufe Negre	30°	800	●	3	-	●	●	-	5		
3	Antimiroș (Bumbac)	60°	1000	●	3,5	-	●	●	-	3,5		
3	Antimiroș (Sintetice)	40°	1000	●	3,5	-	●	●	-	3,5		
4	Delicate	30°	0	●	1	-	●	●	-	1		
5	Lână: pentru lână, cașmir, etc.	40°	800	●	2	-	●	●	-	2		
6	Rapide 30'	30°	800	●	3,5	-	●	●	-	3,5		
Standard												
7	Bumbac cu prespălare: rufe albe foarte murdare.	90°	1400	●	6	●	●	●	-	9		
8	Program standard la 60°C pentru rufe din bumbac (1): albe și colorate rezistente foarte murdare.	60° (Max. 90°)	1400	●	6	-	●	●	-	9		
9	Sintetice: colorate rezistente foarte murdare.	60°	800	●	4	-	●	●	-	4,5		
10	Rufe colorate (2)	40°	1400	●	6	-	●	●	-	9		
11	Eco Bumbac 20°: albe puțin murdare și colorate delicate.	20°	1400	●	6	-	●	●	-	9		
12	Eco Sintetice 20°	20°	800	●	6	-	●	●	-	9		
Automat												
13	Spală&Uscă 45'	30°	1400	●	1	-	●	●	-	1		
14	AirFresh	-	-	●	1,5	-	-	-	-	-		
Parțiale												
	Clătire/Decolorant	-	1400	●	6	-	-	●	●	9		
	Centrifugă + Golire	-	1400	●	6	-	-	-	-	9		
	Numai golire *	-	OFF	-	-	-	-	-	-	9		

* Dacă selectați programul și excludeți centrifugarea, mașina va face doar evacuarea.

Durata ciclului indicată pe display sau în carte este calculată în baza unor condiții standard. Timpul efectiv poate varia în baza a numeroși factori, precum temperatura și presiunea apei la intrare, temperatura mediului, cantitatea de detergent, cantitatea și tipul încărcăturii, echilibrarea încărcăturii, opțiunile suplimentare selectate.

Pentru toate Instituțiile de Testare:

- 1) Programul de control conform normei 50229: selectați programul 8 și temperatura de 60°C.
- 2) Program pentru bumbac, prelungit: selectați programul 10 și temperatura de 40°C.

Opțiuni de spălare

Antipată

Această opțiune permite selectarea tipului de murdărie astfel încât să se adapteze ciclul în mod optim pentru îndepărtarea petelor. Tipurile de murdărie sunt:

- **Mâncare**, de exemplu, pentru petele de alimente și băuturi.
- **Muncă**, de exemplu, pentru petele de unsoare și cerneală.
- **Outdoor**, de exemplu, pentru petele de noroi și iarbă.

! Durata ciclului de spălare variază în funcție de tipul murdăriei selectate.

! Nu poate fi activată cu programele 1-2-3-4-5-6-7-10-11-12-13-14--.

Push&Wash+Dry

Această funcție permite pornirea unui ciclu automat de spălare și uscare și cu mașina oprită fără a trebui să apăsați în prealabil tasta ON/OFF sau, după pornirea mașinii, fără să fi acționat nicio altă tastă și/sau buton (în caz contrar, programul Push&Wash+Dry va fi dezactivat). Pentru a porni ciclul Push&Wash+Dry țineți apăsat butonul pentru 2 secunde. Indicatorul aprins arată că ciclul este pornit. Ciclul de spălare și uscare este ideal pentru articolele de bumbac și sintetice, funcționând la o temperatură de spălare de 30° și o viteză maximă de centrifugare de 1000 rotații pe minut. În timpul uscării, temperatura maximă atinsă este de aprox. 60°C. La terminarea programului, umiditatea reziduală este egală cu nivelul "☁". Cantitate max. recomandată 3kg.

Durata afișată pe display este cea maximă permisă de ciclul Push&Wash+Dry. În cazul în care cantitatea este inferioară celei maxime sau cu o compoziție predominantă de articole din material sintetic, durata efectivă a ciclului va fi mai mică.

Cum funcționează?

1. Introduceți rufele (articole de bumbac și/sau sintetice) și închideți ușa.
2. Turnați detergentul și/sau aditivii.
3. Porniți programul ținând apăsată pentru 2 secunde tasta Push&Wash+Dry. Indicatorul se va aprinde de culoare verde și ușa se va bloca (simbolul ușă blocată aprins).

N.B.: Pornirea spălării de la tasta Push&Wash+Dry activează un ciclu automat de spălare și uscare recomandat pentru bumbac și sintetice nepersonalizabil.

4. Se poate utiliza programul automat doar pentru spălare, excluzând uscarea. Apăsați, după apăsarea tastei Push&Wash+Dry, tasta uscare ☀, pictograma de uscare a nivelului "☁" se stinge. Cantitatea max doar pentru spălare este 4 kg. Nu se poate personaliza ulterior programul.

Pentru a deschide ușa în timpul executării unui ciclu automat, apăsați tasta START/PAUSE; când simbolul ușă blocată se stinge, puteți deschide ușa doar în timpul fazei de spălare. Apăsați din nou tasta START/PAUSE pentru a relua programul de unde era oprit.

5. La încheierea programului, se va aprinde indicatorul END.

Sertarul detergenților

Un rezultat bun la spălare depinde și de dozarea corectă a detergentului: excesul de detergent nu garantează o spălare mai eficientă, ci contribuie la în crustarea părților interne ale mașinii de spălat și la poluarea mediului înconjurător.

! Nu introduceți în mașină detergenții pentru spălarea manuală deoarece formează prea multă spumă.

! Utilizați detergenți praf pentru rufele albe de bumbac, pentru prespălare și pentru spălarea la temperaturi mai mari de 60°C.

! Respectați indicațiile de pe ambalajul detergentului.

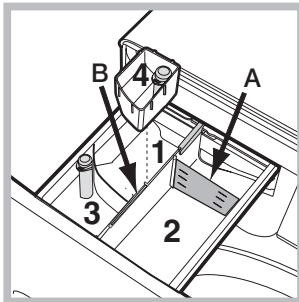

Extrageți sertarul pentru detergenți și introduceți detergentul sau aditivul după cum urmează:

Compartimentul 1: Detergent pentru prespălare (sub formă de praf)

Înainte de a adăuga

detergentul verificați ca sertarul adițional 4 să nu fie introdus.

Compartimentul 2: Detergent pentru spălare (sub formă de praf sau lichid)

Când utilizați detergent lichid este recomandat să folosiți peretele despărțitor **A** prevăzut pentru dozarea corectă. Pentru utilizarea de detergent praf puneți peretele despărțitor în cavitatea **B**.

Compartimentul 3: Aditivi (soluție de înmuiat, etc.)

Balsamul nu trebuie să depășească nivelul „max” indicat pe pivotul central.

sertar adițional 4: Decolorant

Ciclul de albire

Introduceți sertarul adițional **4** din dotare, în sertarul **1**. Când dozați decolorantul nu depășiți nivelul „max” indicat pe pivotul central. Pentru a efectua doar albirea vărsați decolorantul în sertarul adițional **4** și selectați programul .

! Decolorantul tradițional se folosește pentru țesături rezistente albe, cel delicat pentru țesături colorate, sintetice și pentru lână.

Pregătirea rufelor

- Subdivizați rufe în funcție de:
 - tipul de țesătură / simbolul de pe etichetă.
 - culori: separați rufe colorate de cele albe.
- Goliți buzunarele și controlați nasturii.
- Nu depășiți valorile indicate, referite la greutatea rufelor uscate: *a se vedea „Tabel de programe”*.

Cât cântăresc rufele?

- 1 cearceaf 400-500 g.
- 1 față de pernă 150-200 g.
- 1 față de masă 400-500 g.
- 1 halat de baie 900-1.200 g.
- 1 prosop 150-250 g.

Programe particulare

Sport (programul **1**) a fost studiat pentru spălarea țesăturilor utilizate la confecționarea hainelor sportive (echipamente, pantaloni scurți etc.) puțin murdare; pentru cele mai bune rezultate, se recomandă să nu depășiți cantitatea maximă admisă indicată în „Tabel de programe”. Se recomandă utilizarea detergentului lichid într-o cantitate adecvată unei încărcări pe jumătate a mașinii.

Rufe Negre: folosiți programul **2** pentru spălarea rufelor de culoare închisă. Programul este conceput pentru întreținerea culorilor închise în decursul timpului. Pentru cele mai bune rezultate, vă recomandăm utilizarea unui detergent lichid pentru rufe de culori închise.

Dacă selectați funcția de uscare, la terminarea spălării se efectuează automat o uscare delicată care protejează culorile rufelor. Pe display se va afișa nivelul . Sarcina Max.: 3 kg.

Antimiros: folosiți programul **3** pentru spălarea rufelor pentru a elimina mirosurile neplăcute (de ex. fum, transpirație, prăjeală). Programul este conceput pentru a elimina mirosurile neplăcute, protejând fibrele țesăturilor. Se recomandă spălarea la 40° a articolelor sintetice sau a încărcăturilor mixte și la 60° a țesăturilor din bumbac rezistent.

Delicate: folosiți programul **4** pentru spălarea rufelor foarte delicate. Se recomandă să întoarceți pe dos rufe înainte de spălare. Pentru cele mai bune rezultate, vă recomandăm utilizarea unui detergent lichid pentru rufe delicate.

Seleționând funcția de uscare bazată doar pe timp, la sfârșitul spălării va fi efectuată o uscare deosebit de delicată datorită unei mișcări ușoare și unui jet de aer la o temperatură controlată corespunzător.

Duratele recomandate sunt următoarele:

1 kg de material sintetic --> 150 min.

1 kg de material sintetic și bumbac --> 180 min.

1 kg de bumbac --> 180 min.

Gradul de uscare va depinde de încărcarea mașinii și de compoziția țesăturii.

Lână: ciclul de spălare “Lână” al acestei mașini de spălat a fost testat și aprobat de Woolmark Company pentru spălarea articolelor de lână clasificate ca fiind lavabile de mână, cu condiția ca spălarea să se efectueze în conformitate cu instrucțiunile specificate pe eticheta articolului și cu indicațiile furnizate de producătorul acestei mașini de spălat. (M1127)



Rapide 30' (programul **6**) acest ciclul este conceput pentru a spăla rufe ușor murdare la 30° (în afară de lână și mătase) cu o încărcătură maximă de 3 kg în scurt timp: durează doar 30 de minute și economisește energie și timp.

Rufe Colorate: folosiți programul **10** pentru spălarea rufelor de culori deschise. Programul este conceput pentru a păstra strălucirea vie a culorilor în timp.

Eco Bumbac 20° (programul **11**) ideal pentru rufe de bumbac murdare. Performanțele bune și la rece, comparabile cu o spălare la 40°, sunt garantate de o acțiune mecanică care lucrează.

Eco Sintetice 20° (programul **12**) ideal pentru rufe mixte (bumbac și sintetice) cu grad normal de murdărie. Performanțele bune de spălare și la rece sunt garantate de o acțiune mecanică care lucrează prin varierea vitezei la intervale medii și determinate.

Spală&Usucă 45' (programul **13**): este creat pentru a spăla și usca hainele puțin murdare în timp scurt. Alegând acest ciclu se pot spăla și usca max 1 kg de rufe în numai 45 de minute. Pentru a obține rezultate mai bune, folosiți un detergent lichid și, înainte a introduce rufe în mașină, puneți produsele de scos pete sau de albit pe gulere, manșete sau pete în general.

AirFresh (programul **14**) ciclul ideal pentru a reîmprospăta și elimina în 30' mirosurile neplăcute din articolele din bumbac și sintetice (max 1,5kg), în special de fum, fără faza de spălat.

Sistemul de echilibrare a sarcinii

Pentru a evita trepidațiile excesive, înainte de stoarcere, cava mașinii va distribui cantitatea de rufe în mod uniform, centrifuga efectuând câteva rotații la o viteză mai mare decât viteza de spălare. Dacă, după numeroase încercări, mașina nu reușește să echilibreze greutatea, stoarcerea rufelor se va face la o viteză mai mică decât cea prevăzută în program. Dacă instabilitatea este prea mare, mașina va distribui greutatea în locul centrifugei. Pentru a favoriza o mai bună repartizare a rufelor și echilibrarea corectă a mașinii, se recomandă să introduceți în mașină atât articole mari cât și mici.

Se poate întâmpla ca mașina de spălat să nu funcționeze. Înainte de a apela serviciul de Asistență (*a se vedea Asistența*), verificați dacă nu este vorba de o problemă ușor de rezolvat:

Anomalii:

Mașina de spălat nu pornește.

Cauze posibile / Rezolvare:

- Ștecărul nu este introdus în priză de curent, sau nu face contact.
- Aveți o pană de curent la domiciliu.

Ciclul de spălare nu pornește.

- Ușa nu este bine închisă.
- Butonul ON/OFF nu a fost apăsată.
- Butonul START/PAUSE nu a fost apăsat.
- Robinetul de apă nu este deschis.
- A fost setată o întârziere față de ora pornirii.

Mașina de spălat nu încarcă apă (Pe display este vizualizat scris "H2O").

- Furtunul de alimentare cu apă nu este racordat la robinet.
- Furtunul este îndoit.
- Robinetul de apă nu este deschis.
- Apa la domiciliul dvs. este oprită.
- Apa nu are presiune suficientă.
- Butonul START/PAUSE nu a fost apăsat.

Mașina de spălat încarcă și descarcă apă încontinuu.

- Furtunul de golire nu a fost instalat la o înălțime cuprinsă între 65 și 100 cm de pământ (*a se vedea "Instalare"*).
- Capătul furtunului de evacuare este cufundat în apă (*a se vedea "Instalare"*).
- Evacuarea din perete nu are răsuflare pentru aer.

Dacă după aceste verificări problema nu se rezolvă, închideți robinetul de apă, stingeți mașina de spălat și chemați Asistența. Dacă locuința se află la ultimele etaje ale unui edificiu, este posibil să aibă loc fenomene de sifonare, motiv pentru care mașina de spălat încarcă și descarcă apă încontinuu. Pentru a elimina acest inconvenient, se găsesc în comerț supape anti-sifonare.

Mașina de spălat nu se golește sau nu stoarce.

- Programul nu prevede golirea apei: cu unele programe trebuie pornit manual.
- Furtunul de golire este îndoit (*a se vedea "Instalare"*).
- Conducta de descărcare este înfundată.

Mașina de spălat vibrează foarte mult în timpul stoarcerii.

- Cuva, în momentul instalării, nu a fost deblocată în mod corespunzător (*a se vedea "Instalare"*).
- Mașina de spălat este în pantă (*a se vedea "Instalare"*).
- Mașina de spălat este prea aproape de pereți și mobilier (*a se vedea "Instalare"*).

Mașina de spălat pierde apă.

- Furtunul de alimentare cu apă nu este bine înșurubat (*a se vedea "Instalare"*).
- Sertarul detergenților este înfundat (pentru a-l curăța *a se vedea "Întreținere și curățare"*).
- Furtunul de golire nu este bine fixat (*a se vedea "Instalare"*).

Indicatoarele Opțiunilor și ale START/PAUSE luminează intermitent repede și display-ul afișează un cod de anomalie (ex.: F-01, F-..).

- Opriti mașina și scoateți ștecărul din priză; așteptați aprox. 1 minut înainte de a o reaprinde.
- Dacă nu obțineți nici un rezultat, apelați Centrul de Service pentru asistență.

Se formează prea multă spumă.

- Detergentul nu este compatibil cu mașina de spălat (trebuie să fie scris "pentru mașina de spălat", "de mână și în mașina de spălat", sau ceva asemănător).
- Dozajul a fost excesiv.

Nu se activează Push&Wash+Dry.

- După pornirea mașinii s-a acționat altă comandă decât Push&Wash+Dry. Stingeți mașina și apăsați butonul Push&Wash+Dry.

Mașina de spălat nu usucă.

- Ștecherul nu este introdus sau nu a fost suficient introdus în priză de curent astfel încât să existe conexiune electrică.
- În casă nu este curent electric.
- Hubloul nu este bine închis.
- A fost fixată o întârziere de pornire.
- USCARE este poziționat în dreptul valorii **OFF**.

Asistență

RO

Înainte de a lua legătura cu Asistența:

- Verificați dacă puteți rezolva singuri problema (*a se vedea "Anomalii și remedii"*);
- Porniți din nou programul pentru a controla dacă inconvenientul a fost eliminat;
- În caz negativ, contactați un Centru de Asistență Tehnică.

! Nu apelați niciodată la persoane neautorizate.

Comunicați:

- tipul de anomalie;
- modelul mașinii (Mod.);
- numărul de serie (S/N).

Aceste informații sunt specificate pe plăcuța cu date tehnice, lipită în partea din spate a mașinii de spălat precum și în partea anterioară, după ce deschideți ușa.

Atenționări în conformitate cu legislația în vigoare

- Conform prevederilor legislației privind gestionarea deșeurilor, este interzisă eliminarea deșeurilor de echipamente electrice și electronice (DEEE) alături de deșeurile municipale nesortate. Ele trebuie predate la punctele municipale de colectare, societățile autorizate de colectare/reciclare sau distribuitori (în cazul în care se achiziționează echipamente noi de același tip).
- Autoritățile locale trebuie să asigure spațiile necesare pentru colectarea selectivă a deșeurilor precum și funcționalitatea acestora. Contactați societatea de salubritate sau compartimentul specializat din cadrul primăriei pentru informații detaliate.
- Deșeurile de echipamente electrice și electronice pot fi predate și distribuitorilor, la achiziționarea de echipamente noi de același tip (schimb 1 la 1).
- Predarea, de către utilizatori, a deșeurilor de echipamente electrice și electronice, la punctele de colectare municipale, societățile autorizate de colectare/reciclare sau distribuitori (în cazul în care se achiziționează echipamente noi de același tip) facilitează re folosirea, reciclarea sau alte forme de valorificare a acestora.
- Deșeurile de echipamente electrice și electronice pot conține substanțe periculoase care pot avea un impact negativ asupra mediului și sănătății umane în cazul în care DEEE nu sunt colectate selectiv și gestionate conform prevederilor legale.
- Simbolul alăturat (o pubela cu roți, barata cu două linii în forma de X), aplicat pe un echipament electric sau electronic, semnifică faptul că acesta face obiectul unei colectări separate și nu poate fi eliminat împreună cu deșeurile municipale nesortate.



RO

Free Manuals Download Website

<http://myh66.com>

<http://usermanuals.us>

<http://www.somanuals.com>

<http://www.4manuals.cc>

<http://www.manual-lib.com>

<http://www.404manual.com>

<http://www.luxmanual.com>

<http://aubethermostatmanual.com>

Golf course search by state

<http://golfingnear.com>

Email search by domain

<http://emailbydomain.com>

Auto manuals search

<http://auto.somanuals.com>

TV manuals search

<http://tv.somanuals.com>