

# Instructions for use

## WASHING MACHINE

GB

English,1

IWC 71450

### Contents

#### Installation, 2-3-4-5

Unpacking and levelling  
Connecting the electricity and water supplies  
The first wash cycle  
Technical data

#### Description of the washing machine and starting a wash cycle, 6-7

Control panel  
Indicator lights  
Starting a wash cycle

#### Wash cycles, 8

Table of wash cycles

#### Personalisation, 9

Setting the temperature  
Setting the spin speed  
Functions

#### Detergents and laundry, 10

Detergent dispenser drawer  
Preparing the laundry  
Garments requiring special care  
Load balancing system

#### Precautions and tips, 11

General safety  
Disposal

#### Care and maintenance, 12

Cutting off the water or electricity supply  
Cleaning the washing machine  
Cleaning the detergent dispenser drawer  
Caring for the door and drum of your appliance  
Cleaning the pump  
Checking the water inlet hose

#### Troubleshooting, 13-14

#### Assistance, 15-16

 **INDESIT**

# Installation

GB

! This instruction manual should be kept in a safe place for future reference. If the washing machine is sold, transferred or moved, make sure that the instruction manual remains with the machine so that the new owner is able to familiarise himself/herself with its operation and features.

! Read these instructions carefully: they contain vital information relating to the safe installation and operation of the appliance.

## Unpacking and levelling

### Unpacking

1. Remove the washing machine from its packaging.
2. Make sure that the washing machine has not been damaged during the transportation process. If it has been damaged, contact the retailer and do not proceed any further with the installation process.

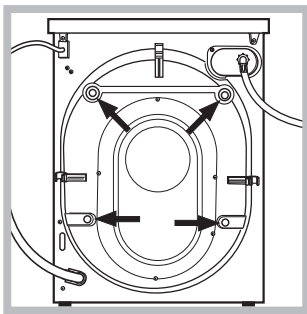

3. Remove the 4 protective screws (used during transportation) and the rubber washer with the corresponding spacer, located on the rear part of the appliance (see figure).

4. Close off the holes using the plastic plugs provided.
5. Keep all the parts in a safe place: you will need them again if the washing machine needs to be moved to another location.

! Packaging materials should not be used as toys for children.

### Levelling

1. Install the washing machine on a flat sturdy floor, without resting it up against walls, furniture cabinets or anything else.

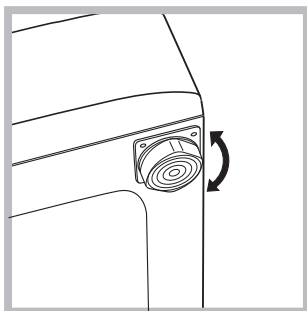

2. If the floor is not perfectly level, compensate for any unevenness by tightening or loosening the adjustable front feet (see figure); the angle of inclination, measured in relation to the worktop, must not exceed 2°.

Levelling the machine correctly will provide it with stability, help to avoid vibrations and excessive noise and prevent it from shifting while it is operating. If it is placed on carpet or a rug, adjust the feet in such a way as to allow a sufficient ventilation space underneath the washing machine.

## Connecting the electricity and water supplies

### Connecting the water inlet hose

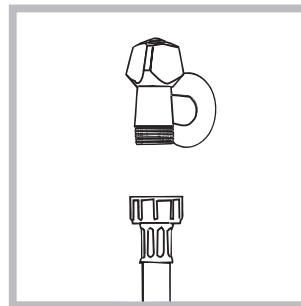

1. Connect the supply pipe by screwing it to a cold water tap using a 3/4 gas threaded connection (see figure). Before performing the connection, allow the water to run freely until it is perfectly clear.

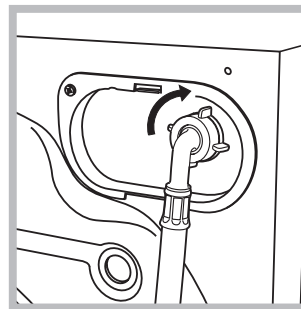

2. Connect the inlet hose to the washing machine by screwing it onto the corresponding water inlet of the appliance, which is situated on the top right-hand side of the rear part of the appliance (see figure).

3. Make sure that the hose is not folded over or bent.

! The water pressure at the tap must fall within the values indicated in the Technical details table (see next page).

! If the inlet hose is not long enough, contact a specialised shop or an authorised technician.

! Never use second-hand hoses.

! Use the ones supplied with the machine.

### Connecting the drain hose

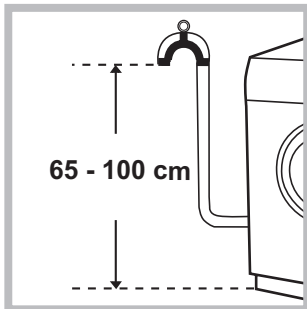

Connect the drain hose, without bending it, to a draining duct or a wall drain situated between 65 and 100 cm from the floor;

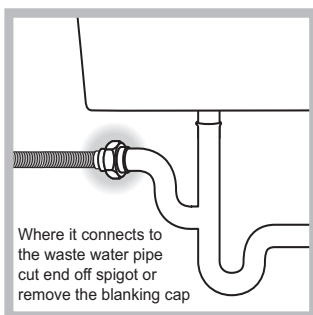

The drain hose may be connected to an under-sink trap. Before connecting the drain hose from the machine ensure that any blanks or removable ends have been taken off the spigot.

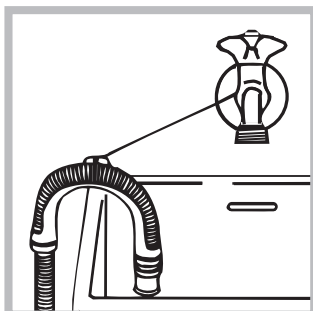

If it is placed over the edge of a basin or sink be sure the free end of the hose should not be underwater.

**!** We advise against the use of hose extensions; in case of absolute need, the extension must have the same diameter as the original hose and must not exceed 150 cm in length.

Ensure that if the drain hose is pushed into a standpipe, that the end does not go down more than 15cms (6 inches). If the hose is pushed down too far, this may cause the machine to self-siphon ie. continuously empty as it is filling.

### Electric connection

Before plugging the appliance into the mains socket, make sure that:

- the socket is earthed and in compliance with the applicable law;
- the socket is able to sustain the appliance's maximum power load indicated in the Technical details table (see page 5);

- the supply voltage is included within the values indicated on the Technical details table (see page 5);
- the socket is compatible with the washing machine's plug. If this is not the case, replace the socket or the plug.

Your appliance is now supplied with a 13 amp fused plug it can be plugged into a 13 amp socket for immediate use. Before using the appliance please read the instructions below.

**WARNING - THIS APPLIANCE MUST BE EARTHED. THE FOLLOWING OPERATIONS SHOULD BE CARRIED OUT BY A QUALIFIED ELECTRICIAN.**

#### Replacing the fuse:

When replacing a faulty fuse, a 13 amp ASTA approved fuse to BS 1362 should always be used, and the fuse cover re-fitted. If the fuse cover is lost, the plug must not be used until a replacement is obtained.

Replacement fuse covers:

If a replacement fuse cover is fitted, it must be of the correct colour as indicated by the coloured marking or the colour that is embossed in words on the base of the plug. Replacements can be obtained directly from your nearest Service Depot.

#### Removing the plug:

If your appliance has a non-rewireable moulded plug and you should wish to re-route the mains cable through partitions, units etc., please ensure that either: the plug is replaced by a fused 13 ampere re-wearable plug bearing the BSI mark of approval.

or:

the mains cable is wired directly into a 13 amp cable outlet, controlled by a switch, (in compliance with BS 5733) which is accessible without moving the appliance.

#### Disposing of the plug:

Ensure that before disposing of the plug itself, you make the pins unusable so that it cannot be accidentally inserted into a socket.

Instructions for connecting cable to an alternative plug: Important: the wires in the mains lead are coloured in accordance with the following code:

<b>Green &amp; Yellow</b>	<b>Earth</b>
<b>Blue</b>	<b>Neutral</b>
<b>Brown</b>	<b>Live</b>

As the colours of the wires in the lead may not correspond with the coloured markings identifying the terminals in your plug, proceed as follows:

Connect Green & Yellow wire to terminal marked **E** or  or coloured Green or Green & Yellow.

Connect Brown wire to terminal marked **L** or coloured Red.

Connect Blue wire to terminal marked **N** or coloured Black. If a 13 amp plug (BS 1363) is used it must be fitted with a 13 amp fuse, either in the plug or adaptor or at the distribution board.

If you are in any doubt about the electrical supply to your machine, consult a qualified electrician before use.

How to connect an alternative plug:

The wires in this mains lead are coloured in accordance with the following code:

- |                           |                    |
|---------------------------|--------------------|
| <b>BLUE</b>               | <b>NEUTRAL (N)</b> |
| <b>BROWN</b>              | <b>LIVE (L)</b>    |
| <b>GREEN &amp; YELLOW</b> | <b>EARTH (E)</b>   |

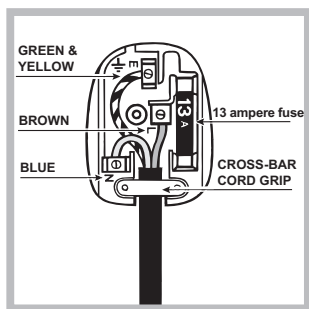

*Disposing of the appliance:*

When disposing of the appliance please remove the plug by cutting the mains cable as close as possible to the plug body and dispose of it as described above.

! The washing machine should not be installed in an outdoor environment, not even when the area is sheltered, because it may be very dangerous to leave it exposed to rain and thunderstorms.

! When the washing machine is installed, the mains socket must be within easy reach.

! Do not use extensions or multiple sockets.

! The power supply cable must never be bent or dangerously compressed.

! The power supply cable must only be replaced by an authorised serviceman.

Warning! The company denies all liability if and when these norms are not respected.

## The first wash cycle

Once the appliance has been installed, and before you use it for the first time, run a wash cycle with detergent and no laundry, setting the 90°C programme without a pre-wash cycle.

<b>Technical data</b>	
<b>Model</b>	IWC 71450
<b>Dimensions</b>	width 59.5 cm height 85 cm depth 53,5 cm
<b>Capacity</b>	from 1 to 7 kg
<b>Electrical connections</b>	please refer to the technical data plate fixed to the machine
<b>Water connection</b>	maximum pressure 1 MPa (10 bar) minimum pressure 0.05 MPa (0.5 bar) drum capacity 52 litres
<b>Spin speed</b>	up to 1400 rotations per minute
<b>Energy rated programmes according to regulation EN 60456</b>	programme 1; temperature 60°C; using a load of 7 kg.
	<p>This appliance conforms to the following EC Directives:</p> <ul style="list-style-type: none"> <li>- 2004/108/EC (Electromagnetic Compatibility)</li> <li>- 2002/96/EC</li> <li>- 2006/95/EC (Low Voltage)</li> </ul>

# Description of the washing machine and starting a wash cycle

## Control panel

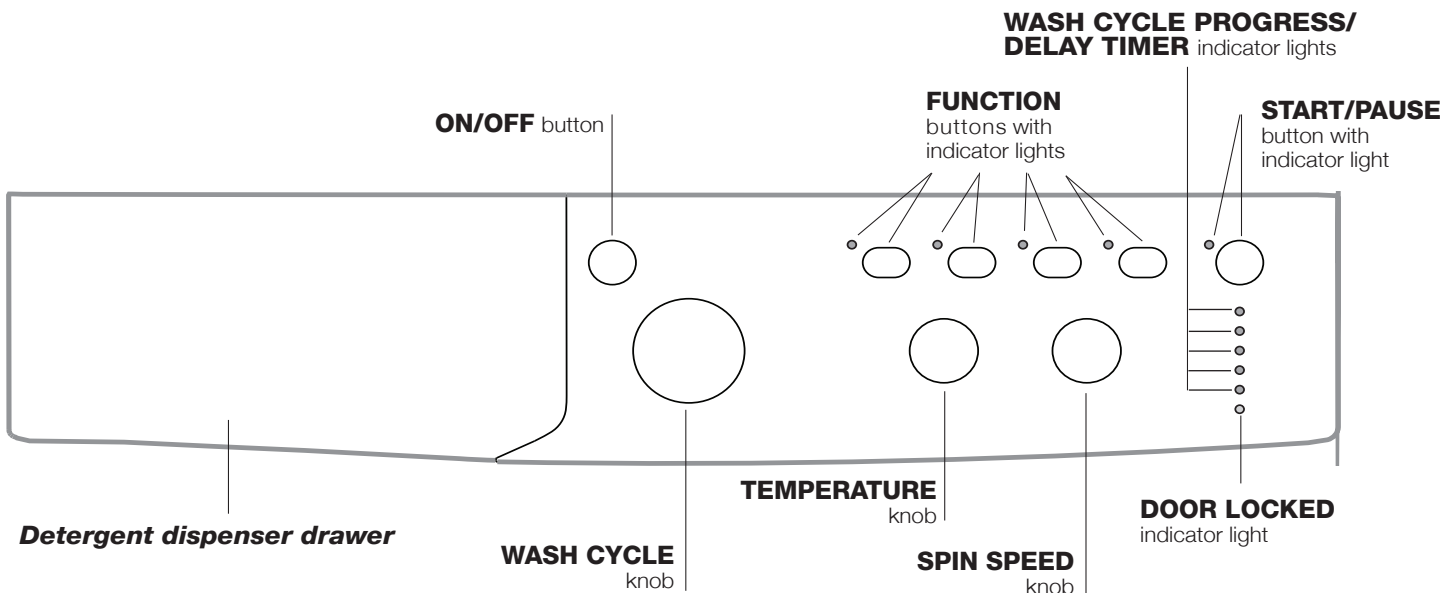

**Detergent dispenser drawer:** used to dispense detergents and washing additives (see “Detergents and laundry”).

**ON/OFF button:** switches the washing machine on and off.

**WASH CYCLE knob:** programmes the wash cycles. During the wash cycle, the knob does not move.

**FUNCTION buttons with indicator light:** used to select the available functions. The indicator light corresponding to the selected function will remain lit.

**TEMPERATURE knob:** sets the temperature or the cold wash cycle (see “Personalisation”).

**SPIN SPEED knob:** sets the spin speed or exclude the spin cycle completely (see “Personalisation”).

**WASH CYCLE PROGRESS/DELAY TIMER indicator lights:** used to monitor the progress of the wash cycle. The illuminated indicator light shows which phase is in progress.  
If the Delay Timer function has been set, the time remaining until the wash cycle starts will be indicated (see next page).

**DOOR LOCKED indicator light:** indicates whether the door may be opened or not (see next page).

**START/PAUSE button with indicator light:** starts or temporarily interrupts the wash cycles.

**N.B.** To pause the wash cycle in progress, press this button; the corresponding indicator light will flash orange, while the indicator light for the current wash cycle phase will remain lit in a fixed manner. If the DOOR LOCKED  indicator light is switched off, the door may be opened. To start the wash cycle from the point at which it was interrupted, press this button again.

### Standby mode

This washing machine, in compliance with new energy saving regulations, is fitted with an automatic standby system which is enabled after about 30 minutes if no activity is detected. Press the ON-OFF button briefly and wait for the machine to start up again.

## Indicator lights

The indicator lights provide important information. This is what they can tell you:

### Delayed start

If the DELAY TIMER function has been activated (see "Personalisation"), after the wash cycle has been started the indicator light corresponding to the selected delay period will begin to flash:







As time passes, the remaining delay will be displayed and the corresponding indicator light will flash:



The set programme will start once the selected time delay has expired.

### Wash cycle phase indicator lights

Once the desired wash cycle has been selected and has begun, the indicator lights switch on one by one to indicate which phase of the cycle is currently in progress.

Wash	
Rinse	
Spin	
Drain	
End of wash cycle	

### Function buttons and corresponding indicator lights

When a function is selected, the corresponding indicator light will illuminate.

If the selected function is not compatible with the programmed wash cycle, the corresponding indicator light will flash and the function will not be activated.

If the selected function is not compatible with another function which has been selected previously, the indicator light corresponding to the first function selected will flash and only the second function will be activated; the indicator light corresponding to the enabled option will remain lit.

### Door locked indicator light

When the indicator light is on, the porthole door is locked to prevent it from being opened; make sure the indicator light is off before opening the door (wait approximately 3 minutes). To open the door during a running wash cycle, press the START/PAUSE button; the door may be opened once the DOOR LOCKED indicator light turns off.



## Starting a wash cycle

1. Switch the washing machine on by pressing the ON/OFF button. All indicator lights will switch on for a few seconds, then they will switch off and the START/PAUSE indicator light will pulse.
2. Load the laundry and close the door.
3. Set the WASH CYCLE knob to the desired programme.
4. Set the washing temperature (see "Personalisation").
5. Set the spin speed (see "Personalisation").
6. Measure out the detergent and washing additives (see "Detergents and laundry").
7. Select the desired functions.
8. Start the wash cycle by pressing the START/PAUSE button and the corresponding indicator light will remain lit in a fixed manner, in green. To cancel the set wash cycle, pause the machine by pressing the START/PAUSE button and select a new cycle.
9. At the end of the wash cycle the **END** indicator light will switch on. The door can be opened once the DOOR LOCK  indicator light turns off. Take out your laundry and leave the appliance door ajar to make sure the drum dries completely. Switch the washing machine off by pressing the ON/OFF button.

# Wash cycles

GB

**Table of wash cycles**

Wash cycles	Description of the wash cycle	Max. temp. (°C)	Max. speed (rpm)	Detergents		Max. load (kg)		Cycle duration	
				Wash	Fabric softener	Normal	Eco Time	Normal	Eco Time
<b>Daily</b>									
1	<b>White Cotton:</b> extremely soiled whites.	90°	1400	●	●	7	-	165	-
1	<b>White Cotton (1):</b> heavily soiled whites and resistant colours.	60°	1400	●	●	7	-	170	-
1	<b>White Cotton (2):</b> lightly soiled whites and delicate colours.	40°	1400	●	●	7	-	165	-
2	<b>Cotton:</b> heavily soiled whites and resistant colours.	60°	1400	●	●	7	3.5	130	105
3	<b>Coloured Cotton (3):</b> lightly soiled and delicate colours.	40°	1400	●	●	7	3.5	90	80
4	<b>Cotton:</b> lightly soiled whites and resistant colours.	30°	1400	●	●	7	3.5	85	75
5	<b>Synthetics:</b> heavily soiled resistant colours.	50°	800	●	●	3	2	80	70
<b>Special</b>									
6	<b>Wool:</b> for wool, cashmere, etc.	40°	600	●	●	1.5	-	55	-
7	<b>Silk/Curtains:</b> for garments in silk and viscose, lingerie.	30°	0	●	●	1	-	55	-
8	<b>Jeans</b>	40°	800	●	●	3	-	70	-
9	<b>Express 15':</b> to refresh lightly soiled garments quickly (not suitable for wool, silk and clothes which require washing by hand).	30°	800	●	●	1,5	-	15	-
10	<b>Flash Cotton</b>	60°	1400	●	●	3.5	-	60	-
<b>Sport</b>									
11	<b>Sport Intensive</b>	30°	600	●	●	3	-	80	-
12	<b>Sport Light</b>	30°	600	●	●	3	-	70	-
13	<b>Special Shoes</b>	30°	600	●	●	Max. 2 pairs	-	50	-
<b>Partial wash cycles</b>									
	Rinse	-	1400	-	●	7	-	35	-
	Spin	-	1400	-	-	7	-	15	-
	Drain	-	0	-	-	7	-	2	-

The length of cycle shown on the display or in this booklet is an estimation only and is calculated assuming standard working conditions. The actual duration can vary according to factors such as water temperature and pressure, the amount of detergent used, the amount and type of load inserted, load balancing and any wash options selected.

For all Test Institutes:

- 1) Test wash cycle in compliance with regulation EN 60456: set wash cycle 1 with a temperature of 60°C.
- 2) Long wash cycle for cottons: set wash cycle 1 with a temperature of 40°C.
- 3) Short wash cycle for cottons: set wash cycle 3 with a temperature of 40°C.

## Specials wash cycles

**Express 15'** (wash cycle 9) this wash cycle was designed to wash lightly soiled garments quickly: it lasts just 15 minutes and therefore saves both energy and time. By selecting this wash cycle (9 at 30°C), it is possible to wash different fabrics together (except for wool and silk items), with a maximum load of 1.5 kg.

**Sport Intensive** (wash cycle 11) is for washing heavily soiled sports clothing fabrics (tracksuits, shorts, etc.); for best results, we recommend not exceeding the maximum load indicated in the "Table of wash cycles".

**Sport Light** (wash cycle 12) is for washing lightly soiled sports clothing fabrics (tracksuits, shorts, etc.); for best results, we recommend not exceeding the maximum load indicated in the "Table of wash cycles". We recommend using a liquid detergent and dosage suitable for a half-load.

**Special Shoes** (wash cycle 13) is for washing sports shoes; for best results, do not wash more than 2 pairs simultaneously.



## Setting the temperature

Turn the TEMPERATURE knob to set the wash temperature (see *Table of wash cycles*).

The temperature may be lowered, or even set to a cold wash .

The washing machine will automatically prevent you from selecting a temperature which is higher than the maximum value set for each wash cycle.

## Setting the spin speed

Turn the SPIN SPEED knob to set the spin speed for the selected wash cycle.

The maximum spin speeds available for each wash cycle are as follows:

Wash cycles	Maximum spin speed
Cottons	1400 rpm
Synthetics	800 rpm
Wool	600 rpm
Silk	drain only

The spin speed may be lowered, or the spin cycle can be excluded altogether by selecting the symbol .

The washing machine will automatically prevent you from selecting a spin speed which is higher than the maximum speed set for each wash cycle.

## Functions

The various wash functions available with this washing machine will help to achieve the desired results, every time.



To activate the functions:

1. Press the button corresponding to the desired function;
2. the function is enabled when the corresponding indicator light is illuminated.

Note: If the indicator light flashes rapidly, this signals that this particular function may not be selected in conjunction with the selected wash cycle.

### EcoTime

Selecting this option enables you to suitably adjust drum rotation, temperature and water to a reduced load of lightly soiled cotton and synthetic fabrics (refer to the *“Table of wash cycles”*). “EcoTime” enables you to wash in less time thereby saving water and electricity. We suggest using a liquid detergent suitably measured out to the load quantity.

! This function may not be used in conjunction with wash cycles 1, 6, 7, 8, 9, 10, 11, 12, 13, , , .

### Intensive Wash

Because a greater quantity of water is used in the initial phase of the cycle, and because of the increased cycle duration, this function offers a high-performance wash.

! This function may not be used in conjunction with wash cycles 6, 7, 8, 9, 10, 11, 12, 13, , , .

### Extra Rinse

By selecting this option, the efficiency of the rinse is increased and optimal detergent removal is guaranteed. It is particularly useful for sensitive skin.

! This function may not be used in conjunction with wash cycles 9, , .

### Delay Timer

This timer delays the start time of the wash cycle by up to 12 hours.

Press the button repeatedly until the indicator light corresponding to the desired delay time switches on. The fifth time the button is pressed, the function will be disabled.

**N.B.** Once the START/PAUSE button has been pressed, the delay time can only be modified by decreasing it until launching the set programme.

! This option is enabled with all programmes.

# Detergents and laundry

GB

## Detergent dispenser drawer

Good washing results also depend on the correct dose of detergent: adding too much detergent will not necessarily result in a more efficient wash, and may in fact cause build up on the inside of your appliance and contribute to environmental pollution.

! Do not use hand washing detergents because these create too much foam.



Open the detergent dispenser drawer and pour in the detergent or washing additive, as follows.

! Do not pour detergent into the compartment **1**. Detergent should only be poured into the compartment **2**.  
**compartment 2: Detergent for the wash cycle (powder or liquid)**

Liquid detergent should only be poured in immediately prior to the start of the wash cycle.

**compartment 3: Additives (fabric softeners, etc.)**

The fabric softener should not overflow the grid.

## Preparing the laundry

- Divide the laundry according to:
  - the type of fabric/the symbol on the label
  - the colours: separate coloured garments from whites.
- Empty all garment pockets and check the buttons.
- Do not exceed the listed values, which refer to the weight of the laundry when dry:
  - Durable fabrics: max. 7 kg
  - Synthetic fabrics: max. 3 kg
  - Delicate fabrics: max. 2 kg
  - Wool: max. 1.5 kg
  - Silk: max. 1 kg

### How much does your laundry weigh?

- 1 sheet 400-500 g
- 1 pillow case 150-200 g
- 1 tablecloth 400-500 g
- 1 bathrobe 900-1200 g
- 1 towel 150-250 g

## Garments requiring special care

**Wool:** all wool garments can be washed using programme **6**, even those carrying the “hand-wash only”  label.

For best results, use special detergents and do not exceed 1,5 kg of laundry.

**Silk:** use special wash cycle **7** to wash all silk garments. We recommend the use of special detergent which has been designed to wash delicate clothes.

**Curtains:** fold curtains and place them in a pillow case or mesh bag. Use wash cycle **7**.

**Jeans:** Turn garments inside-out before washing and use a liquid detergent. Use programme **8**.

## Load balancing system

Before every spin cycle, to avoid excessive vibrations and to distribute the load in a uniform manner, the drum rotates continuously at a speed which is slightly greater than the washing rotation speed. If, after several attempts, the load is not balanced correctly, the machine spins at a reduced spin speed. If the load is excessively unbalanced, the washing machine performs the distribution process instead of spinning. To encourage improved load distribution and balance, we recommend small and large garments are mixed in the load.

! This washing machine was designed and constructed in accordance with international safety regulations. The following information is provided for safety reasons and must therefore be read carefully.

Consumers should contact their local authority or retailer for information concerning the correct disposal of their old appliance.

GB

## General safety

- This appliance is not intended for use by persons (including children) with reduced physical, sensory or mental capabilities, or lack of experience and knowledge, unless they have been given supervision or instruction concerning use of the appliance by a person responsible for their safety. Children should be supervised to ensure that they do not play with the appliance.
- This appliance was designed for domestic use only.
- Do not touch the machine when barefoot or with wet or damp hands or feet.
- Do not pull on the power supply cable when unplugging the appliance from the electricity socket. Hold the plug and pull.
- Do not open the detergent dispenser drawer while the machine is in operation.
- Do not touch the drained water as it may reach extremely high temperatures.
- Never force the porthole door. This could damage the safety lock mechanism designed to prevent accidental opening.
- If the appliance breaks down, do not under any circumstances access the internal mechanisms in an attempt to repair it yourself.
- Always keep children well away from the appliance while it is operating.
- The door can become quite hot during the wash cycle.
- If the appliance has to be moved, work in a group of two or three people and handle it with the utmost care. Never try to do this alone, because the appliance is very heavy.
- Before loading laundry into the washing machine, make sure the drum is empty.

## Disposal

- Disposing of the packaging materials: observe local regulations so that the packaging may be re-used.
- The European Directive 2002/96/EC on Waste Electrical and Electronic Equipment, requires that old household electrical appliances must not be disposed of in the normal unsorted municipal waste stream. Old appliances must be collected separately in order to optimise the recovery and recycling of the materials they contain and reduce the impact on human health and the environment. The crossed out “wheeled bin” symbol on the product reminds you of your obligation, that when you dispose of the appliance it must be separately collected.

# Care and maintenance

GB

## Cutting off the water and electricity supplies

- Turn off the water tap after every wash cycle. This will limit wear on the hydraulic system inside the washing machine and help to prevent leaks.
- Unplug the washing machine when cleaning it and during all maintenance work.

## Cleaning the washing machine

The outer parts and rubber components of the appliance can be cleaned using a soft cloth soaked in lukewarm soapy water. Do not use solvents or abrasives.

## Cleaning the detergent dispenser drawer

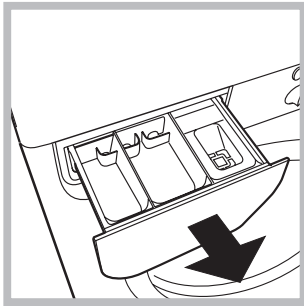

Remove the dispenser by raising it and pulling it out (see figure). Wash it under running water; this operation should be repeated frequently.

## Caring for the door and drum of your appliance

- Always leave the porthole door ajar in order to prevent unpleasant odours from forming.

## Cleaning the pump

The washing machine is fitted with a self-cleaning pump which does not require any maintenance. Sometimes, small items (such as coins or buttons) may fall into the pre-chamber which protects the pump, situated in its bottom part.

! Make sure the wash cycle has finished and unplug the appliance.

To access the pre-chamber:

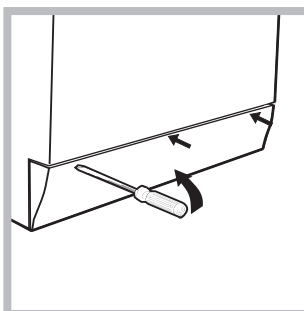

1. using a screwdriver, remove the cover panel on the lower front part of the washing machine (see figure);

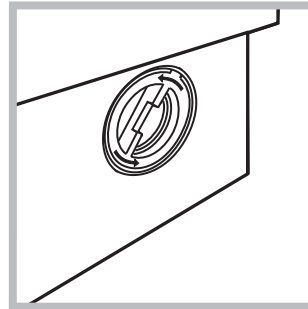

2. unscrew the lid by rotating it anti-clockwise (see figure); a little water may trickle out. This is perfectly normal;

3. clean the inside thoroughly;
4. screw the lid back on;
5. reposition the panel, making sure the hooks are securely in place before you push it onto the appliance.

## Checking the water inlet hose

Check the inlet hose at least once a year. If there are any cracks, it should be replaced immediately: during the wash cycles, water pressure is very strong and a cracked hose could easily split open.

! Never use second-hand hoses.

Your washing machine could fail to work. Before contacting the Technical Assistance Centre (see "Assistance"), make sure that the problem cannot be not solved easily using the following list.

## Problem:

## Possible causes / Solutions:

### The machine does not switch on.

- The appliance is not plugged into the socket fully, or not enough to make contact.
- There is no power to the socket, or the fuse has blown in the mains plug.

### The wash cycle does not start.

- The door is not closed properly.
- The ON/OFF button has not been pressed.
- The START/PAUSE button has not been pressed.
- The water tap has not been turned on to allow water to flow into the machine.
- A delayed start has been set.

### The machine does not fill with water or the indicator light for the first wash cycle stage flashes rapidly.

- The water inlet hose is kinked.
- The water inlet hose is not connected to the water supply.
- The water pressure is too low.
- The water tap has not been turned on to allow water to flow into the machine.
- There is no water supply to the house.
- The inlet valve filter is blocked.
- The START/PAUSE button has not been pressed.

### The machine continuously fills with water and continually drains away or Water left in the drum or Stuck on wash.

- The top of the drain hose is too low - It must be fitted at a height between 65 and 100 cm from the floor (see "Installation").
- The drain hose is connected incorrectly to the sink trap allowing water to run into the machine, the drain hose must be positioned higher than the bottom of the sink to prevent water flowing down the drain hose.
- The end of the drain hose has been pushed too far down the standpipe, the 'U' bracket should be fitted 100 mm from the end of the drain hose.

### The machine does not drain or spin.

- The Pump filter is blocked.
- The drain hose is kinked (see "Installation").
- New Installation - The blanking cap or spigot has not been removed if connected under a sink.
- The drain hose or sink trap is blocked.
- The wash cycle does not include draining, some wash cycles require the drain phase to be started manually.
- The 'Spin Speed' selector knob is in the "0" position.

### The machine does not heat or poor wash results.

- The 'Temperature' selector knob is in the "❄" position.

### The programme takes too long.

- Programme times will vary due to water pressure, the incoming water temperature and if the wash load goes out of balance. This will increase the programme times accordingly (see 'The machine wont spin properly' below).

### The machine vibrates a lot during the spin cycle.

- The feet have not been adjusted, enabling the machine to rock.
- New Installation - Either the Transit Bolts including the plastic spacers, or the Polystyrene Packaging have not been removed when installing the machine.
- The machine is trapped between cabinets and/or walls.
- The load is in a slight out of balance condition and machine is spinning, but at a lower speed.

**The machine is noisy.**

- There will always be some motor, pump and drum noise during spin.

**The machine wont spin properly.**

- Out of Balance detected when attempting to go into a spin cycle - If this happens the machine will continue to try to repeat the distribution of the load required before the machine will go into higher spin speeds - This will increase the programme time accordingly. This is a safety feature to prevent damage. Out of Balance can be caused by washing a single heavy item (eg duvet, quilt, etc). - Try the programme again using a different load.

**The machine leaks from the dispenser.**

- The dispenser drawer is blocked with detergent and requires cleaning.
- The water pressure is too high and requires turning down - turn down the tap on the water supply pipe slightly and try again.
- The machine is tilting forwards - It must be level when in its final position.

**The machine leaks (other than dispenser).**

- The fill hose is loose, check both the cabinet and tap ends.
- The fill hose is tight but still leaks, if so replace the rubber washers, or the fill hose is missing the rubber washer.
- The drain hose is not fixed in properly.

**The indicator lights on the console are flashing rapidly.**

- Switch off the machine and unplug it, wait for approximately 1 minute and then switch it back on again If the problem persists contact the Technical Assistance Service.

**The machine smells.**

- The machine requires a service wash. Run a 90 degree wash cycle with detergent and no laundry.

**The machine door cannot be opened.**

- The door will not open until the door lock indicator light goes out shortly after the program has finished.

**Door Seal damaged at the bottom.**

- The door seal has drainage holes at the bottom - This is normal.

**The water level is too low when the machine is washing.**

- The water level is correct if it can be seen at the bottom of the door.

**There is too much foam.**

- The detergent is not suitable for machine washing (it should display the text 'for washing machines' or 'hand and machine wash' or the like).
- Too much detergent was used - less detergent is required in soft water.

**After completing the programme, or before starting a programme, the machine has turned itself off (no lights).**

- To comply with new energy saving regulations the machine is fitted with an automatic standby system. Press 'ON/OFF' button for 3 seconds to activate the machine, it can then either be switched off or a new programme selected.

**General.**

- Your washing machine contains sensors that monitor progress during the wash cycle (eg: Water Levels, Temperatures, Out of Balance loads, Wash time/progress). Normally, if your machine successfully completes the cycle, there is unlikely to be anything wrong!

**Remember, you will be charged for a service call for problems caused by incorrect installation, as listed above.**

**Not emptying contents from pockets may cause pump or drain blockages, or may damage the machine.**

**Do not wash items which do not have a wash label, or wash items that are not intended as machine washable.**

## 12 Months Parts and Labour Guarantee

Your appliance has the benefit of our manufacturer's guarantee, which covers the cost of breakdown repairs for twelve months from the date of purchase.

This gives you the reassurance that if, within that time, your appliance is proven to be defective because of either workmanship or materials, we will, at our discretion, either repair or replace the appliance at no cost to you.

This guarantee is subject to the following conditions:

- The appliance has been installed and operated correctly and in accordance with our operating and maintenance instructions.
- The appliance is used only on the electricity or gas supply printed on the rating plate.
- The appliance has been used for normal domestic purposes only.
- The appliance has not been altered, serviced, maintained, dismantled, or otherwise interfered with by any person not authorised by us.
- Any repair work must be undertaken by us or our appointed agent.
- Any parts removed during repair work or any appliance that is replaced become our property.
- The appliance is used in the United Kingdom or Republic of Ireland.

The guarantee does not cover:

- Damage resulting from transportation, improper use, neglect or interference or as a result of improper installation.
- Replacement of any consumable item or accessory . These include but are not limited to: plugs, cables, batteries, light bulbs, fluorescent tubes and starters, covers and filters.
- Replacement of any removable parts made of glass or plastic.

THIS GUARANTEE WILL NOT APPLY IF THE APPLIANCE HAS BEEN USED IN COMMERCIAL OR NON-DOMESTIC PREMISES.

## 5 Year Parts Guarantee

Indesit also offers you a free 5 year parts guarantee. This additional guarantee is conditional on you registering your appliance with us and the parts being fitted by one of our authorised engineers. There will be a charge for our engineer's time. To activate the extra parts warranty on your appliance, simply call our registration line on **08448 24 24 24 (Republic of Ireland 01 230 0800)**

## Extended Guarantees

We offer a selection of repair protection plans that enable you to fully cover yourself against the expense of repair bills for the life of your policy. To find the ideal plan for you please call our advice line on **08448 226 226 (Republic of Ireland 01 230 0233)**.

## Free Helpdesk Service

We have a dedicated team who can provide free advice and assistance with your appliance if you experience any technical difficulties within the first 90 days of ownership. Simply call our Indesit Service Hotline on **08448 224 224 (Republic of Ireland 0818 313 413)** for telephone assistance, or, where necessary, to arrange for an engineer to call.

## After Sales Service

No one is better placed to care for your Indesit appliance during the course of its working life than us - the manufacturer.

### Essential Contact Information

#### Indesit Service

We are the largest service team in Europe offering you access to 400 skilled telephone advisors and 1100 fully qualified engineers on call to ensure you receive fast, reliable, local service.

**UK: 08448 224 224**

**Republic of Ireland: 0818 313 413**

**[www.indesitservice.co.uk](http://www.indesitservice.co.uk)**

**Please note: Our advisors will require the following information:**

**Model number:**

**Serial number:**

#### Parts and Accessories

We supply a full range of genuine replacement parts as well as accessory products that protect and hygienically clean your appliance to keep it looking good and functioning efficiently throughout its life.

**UK: 08448 225 225**

**Republic of Ireland: 0818 313 413**

**[www.indesitservice.co.uk](http://www.indesitservice.co.uk)**

#### Appliance Registration

We want to give you additional benefits of Indesit ownership. To activate your free 5 year parts guarantee you must register your appliance with us.

**UK: 08448 24 24 24**

**Republic of Ireland: 01 230 0800**

**[www.indesitservice.co.uk](http://www.indesitservice.co.uk)**

**Indesit Company UK Ltd. Morley Way, Peterborough, PE2 9JB**

Indesit Company Unit 49 Airways Industrial Estate, Dublin 17



### Recycling & Disposal Information

As part of Indesit's continued commitment to helping the environment, Indesit reserves the right to use quality, recycled components to keep down customer costs and minimise material wastage.

Please dispose of packaging and old appliances carefully. To minimise the risk of injury to children, remove the door, plug and cut the mains cable off flush with the appliance. Dispose of these parts separately to ensure that the appliance can no longer be plugged into a mains socket, and the door cannot be locked shut.



## Free Manuals Download Website

<http://myh66.com>

<http://usermanuals.us>

<http://www.somanuals.com>

<http://www.4manuals.cc>

<http://www.manual-lib.com>

<http://www.404manual.com>

<http://www.luxmanual.com>

<http://aubethermostatmanual.com>

Golf course search by state

<http://golfingnear.com>

Email search by domain

<http://emailbydomain.com>

Auto manuals search

<http://auto.somanuals.com>

TV manuals search

<http://tv.somanuals.com>