

GB

English,1

PWDE 8148 W

!  This symbol reminds you to read this instruction manual.

GB

Contents

Installation, 2-3-4-5

Unpacking and levelling
Connecting the electricity and water supplies
The first wash cycle
Technical data

Description of the washer-dryer, 6-7

Control panel
Display

How to run a wash cycle or a drying cycle, 8

Wash cycles and options, 9

Table of programmes and wash cycles
Wash options

Detergents and laundry, 10

Detergent dispenser drawer
Preparing the laundry
Special wash cycles

Precautions and advice, 11

General safety
Disposal
Opening the porthole door manually

Care and maintenance, 12

Cutting off the water and electricity supplies
Cleaning the washer-dryer
Cleaning the detergent dispenser drawer
Cleaning the pump
Checking the water inlet hose

Troubleshooting, 13

Service and Guarantee, 14-15-16

Before calling for Assistance
Guarantee

Installation

GB

! This instruction manual should be kept in a safe place for future reference. If the washer-dryer is sold, transferred or moved, make sure that the instruction manual remains with the machine so that the new owner is able to familiarise himself/herself with its operation and features.

! Read these instructions carefully: they contain vital information relating to the safe installation and operation of the appliance.

Unpacking and levelling

Unpacking

1. Remove the washer-dryer from its packaging.
2. Make sure that the washer-dryer has not been damaged during the transportation process. If it has been damaged, contact the retailer and do not proceed any further with the installation process.

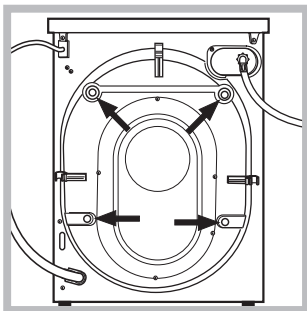

3. Remove the 4 protective screws (used during transportation) and the rubber washer with the corresponding spacer, located on the rear part of the appliance (see figure).

4. Close off the holes using the plastic plugs provided.
5. Keep all the parts in a safe place: you will need them again if the washer-dryer needs to be moved to another location.

! Packaging materials should not be used as toys for children.

Levelling

1. Install the washer-dryer on a flat sturdy floor, without resting it up against walls, furniture cabinets or anything else.

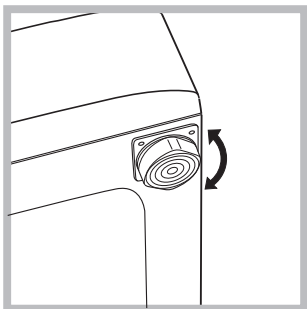

2. If the floor is not perfectly level, compensate for any unevenness by tightening or loosening the adjustable front feet (see figure); the angle of inclination, measured in relation to the worktop, must not exceed 2°.

Levelling the machine correctly will provide it with stability, help to avoid vibrations and excessive noise and prevent it from shifting while it is operating. If it is placed on carpet or a rug, adjust the feet in such a way as to allow a sufficient ventilation space underneath the washer-dryer.

Connecting the electricity and water supplies

Connecting the water inlet hose

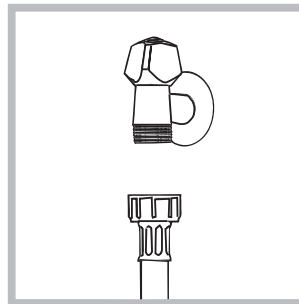

1. Connect the inlet hose by screwing it to a cold water tap using a 3/4 gas threaded connection (see figure). Before performing the connection, allow the water to run freely until it is perfectly clear.

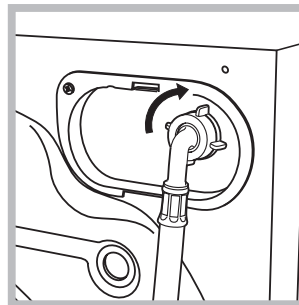

2. Connect the inlet hose to the washer-dryer by screwing it onto the corresponding water inlet of the appliance, which is situated on the top right-hand side of the rear part of the appliance (see figure).

3. Make sure that the hose is not folded over or bent.

! The water pressure at the tap must fall within the range of values indicated in the Technical data table (see next page).

! If the inlet hose is not long enough, contact a specialised shop or an authorised technician.

! Never use second-hand hoses.

! Use the ones supplied with the machine.

Connecting the drain hose

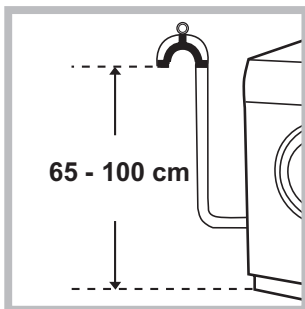

Connect the drain hose, without bending it, to a draining duct or a wall drain situated between 65 and 100 cm from the floor;

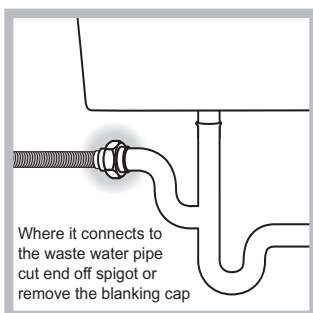

The drain hose may be connected to an under-sink trap. Before connecting the drain hose from the machine ensure that any blanks or removable ends have been taken off the spigot.

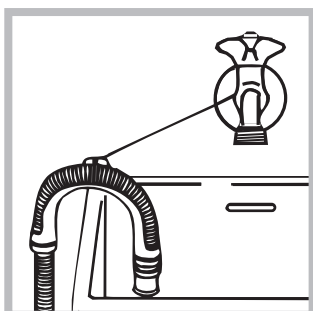

If it is place over the edge of a basin or sink be sure the free end of the hose should not be underwater.

! We advise against the use of hose extensions; in case of absolute need, the extension must have the same diameter as the original hose and must not exceed 150 cm in length.

Ensure that if the drain hose is pushed into a standpipe, that the end does not go down more than 15cms (6 inches). If the hose is pushed down too far, this may cause the machine to self-siphon ie. continuously empty as it is filling.

Electric connection

Before plugging the appliance into the mains socket, make sure that:

- the socket is earthed and in compliance with the applicable law;
- the socket is able to sustain the appliance's maximum power load indicated in the Technical details table (see page 5);

- the supply voltage is included within the values indicated on the Technical details table (see page 5);

- the socket is compatible with the washing machine's plug. If this is not the case, replace the socket or the plug.

Your appliance is now supplied with a 13 amp fused plug it can be plugged into a 13 amp socket for immediate use. Before using the appliance please read the instructions below.

WARNING - THIS APPLIANCE MUST BE EARTHED. THE FOLLOWING OPERATIONS SHOULD BE CARRIED OUT BY A QUALIFIED ELECTRICIAN.

Replacing the fuse:

When replacing a faulty fuse, a 13 amp ASTA approved fuse to BS 1362 should always be used, and the fuse cover re-fitted. If the fuse cover is lost, the plug must not be used until a replacement is obtained.

Replacement fuse covers:

If a replacement fuse cover is fitted, it must be of the correct colour as indicated by the coloured marking or the colour that is embossed in words on the base of the plug. Replacements can be obtained directly from your nearest Service Depot.

Removing the plug:

If your appliance has a non-rewireable moulded plug and you should wish to re-route the mains cable through partitions, units etc., please ensure that either:

the plug is replaced by a fused 13 ampere re-wearable plug bearing the BSI mark of approval.

or:

the mains cable is wired directly into a 13 amp cable outlet, controlled by a switch, (in compliance with BS 5733) which is accessible without moving the appliance.

Disposing of the plug:

Ensure that before disposing of the plug itself, you make the pins unusable so that it cannot be accidentally inserted into a socket.

Instructions for connecting cable to an alternative plug: Important: the wires in the mains lead are coloured in accordance with the following code:

Green & Yellow	Earth
Blue	Neutral
Brown	Live

As the colours of the wires in the lead may not correspond with the coloured markings identifying the terminals in your plug, proceed as follows:
 Connect Green & Yellow wire to terminal marked **E** or \perp or coloured Green or Green & Yellow.
 Connect Brown wire to terminal marked **L** or coloured Red.
 Connect Blue wire to terminal marked **N** or coloured Black.

If a 13 amp plug (BS 1363) is used it must be fitted with a 13 amp fuse, either in the plug or adaptor or at the distribution board.

If you are in any doubt the electrical supply to your machine, consult a qualified electrician before use.

How to connect an alternative plug:

The wires in this mains lead are coloured in accordance with the following code:

BLUE	NEUTRAL (N)
BROWN	LIVE (L)
GREEN & YELLOW	EARTH (E)

Disposing of the appliance:

When disposing of the appliance please remove the plug by cutting the mains cable as close as possible to the plug body and dispose of it as described above.

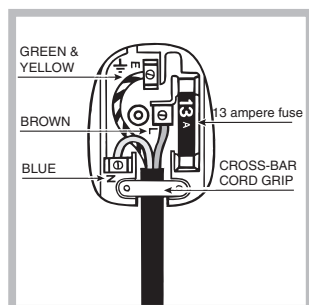

! The washing machine should not be installed in an outdoor environment, not even when the area is sheltered, because it may be very dangerous to leave it exposed to rain and thunderstorms.

! When the washing machine is installed, the mains socket must be within easy reach.

! Do not use extensions or multiple sockets.

! The power supply cable must never be bent or dangerously compressed.

! The power supply cable must only be replaced by an authorised serviceman.

Warning! The company denies all liability if and when these norms are not respected.

The first wash cycle

Once the appliance has been installed, and before you use it for the first time, run a wash cycle with detergent and no laundry, setting the 90°C programme without a pre-wash cycle.

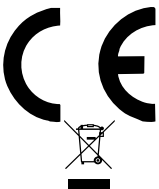
Technical data	
Model	PWDE 8148 W
Dimensions	width 59,5 cm height 85 cm depth 62 cm
Capacity	from 1to 8 kg for wash programme from 1 to 6 kg for the drying programme
Electrical connections	please refer to the technical data plate fixed to the machine
Water connections	maximum pressure 1 MPa (10 bar) minimum pressure 0.05 MPa (0.5 bar) drum capacity 62 litres
Spin speed	up to 1400 rotations per minute
Energy rated programmes according to regulation EN 50229	Wash: programme 1; temperature 60°C; using a load of 8 kg. Drying: first drying cycle performed with a 2 kg load, by selecting the drying level "A1" (IRON); Second drying cycle performed with a 6 kg load, selecting the maximum drying level "A4" (EXTRA).
	This appliance conforms to the following EC Directives: - 89/336/EEC dated 03/05/89 (Electromagnetic Compatibility) and subsequent modifications - 2006/95/EC (Low Voltage) - 2002/96/EC

Description of the washer-dryer

GB

Control panel

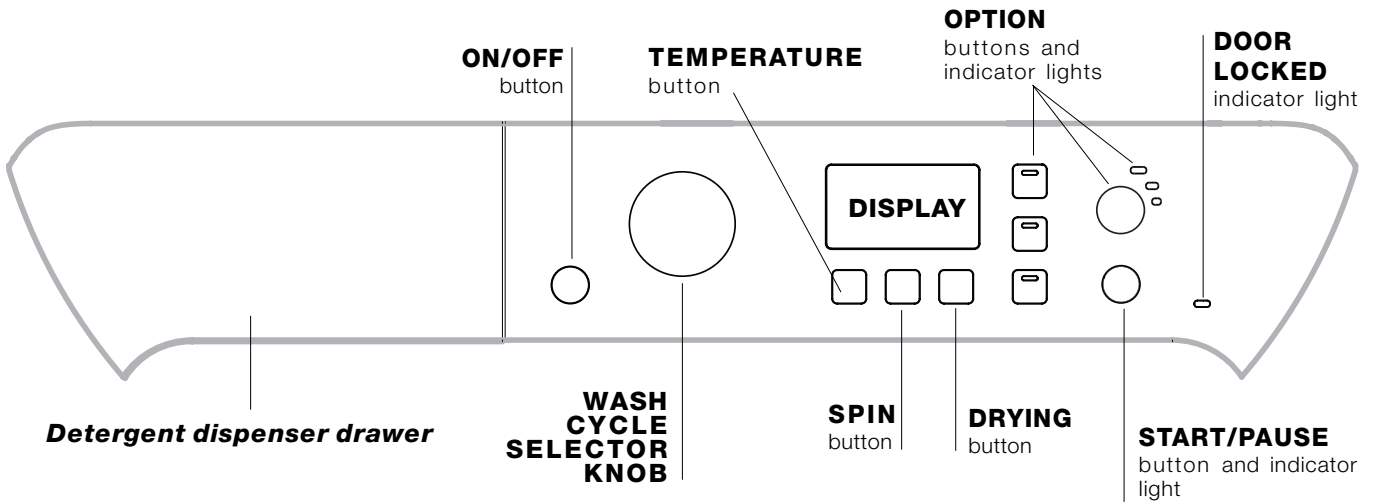

Detergent dispenser drawer: used to dispense detergents and washing additives (see “Detergents and laundry”).

ON/OFF  button: press this briefly to switch the machine on or off. The START/PAUSE indicator light which flashes slowly in a blue colour shows that the machine is switched on. To switch off the washer-dryer during the wash cycle, press and hold the button for approximately 3 seconds; if the button is pressed briefly or accidentally the machine will not switch off.

If the machine is switched off during a wash cycle, this wash cycle will be cancelled.



WASH CYCLE SELECTOR KNOB: used to set the desired wash cycle (see “Table of programmes and wash cycles”).

OPTION buttons and indicator lights: press to select the available options. The indicator light corresponding to the selected option will remain lit.

SPIN  button: press to reduce or completely exclude the spin cycle; the value appears on the display.

TEMPERATURE  button: press to reduce or completely exclude the temperature; the value appears on the display.

DRYING button : press to decrease or exclude drying; the selected drying level or time will appear on the display (see “How to run a wash cycle or a drying cycle”).

START/PAUSE  button and indicator light: when the blue indicator light flashes slowly, press the button to start a wash cycle. Once the cycle has begun the indicator light will remain lit in a fixed manner. To pause the wash cycle, press the button again; the indicator light will flash in an amber colour. If the  symbol is not illuminated, the door may be opened. To start the wash cycle from the point at which it was interrupted, press the button again.

DOOR LOCKED  indicator light:

The lit symbol indicates that the door is locked. To prevent any damage, wait until the symbol turns off before opening the door.

To open the door while a cycle is in progress, press the START/PAUSE button; if the DOOR LOCKED  symbol is switched off the door may be opened.

Standby mode

This washer-dryer, in compliance with new energy saving regulations, is fitted with an automatic standby system which is enabled after a few minutes if no activity is detected. Press the ON-OFF button briefly and wait for the machine to start up again.

Display

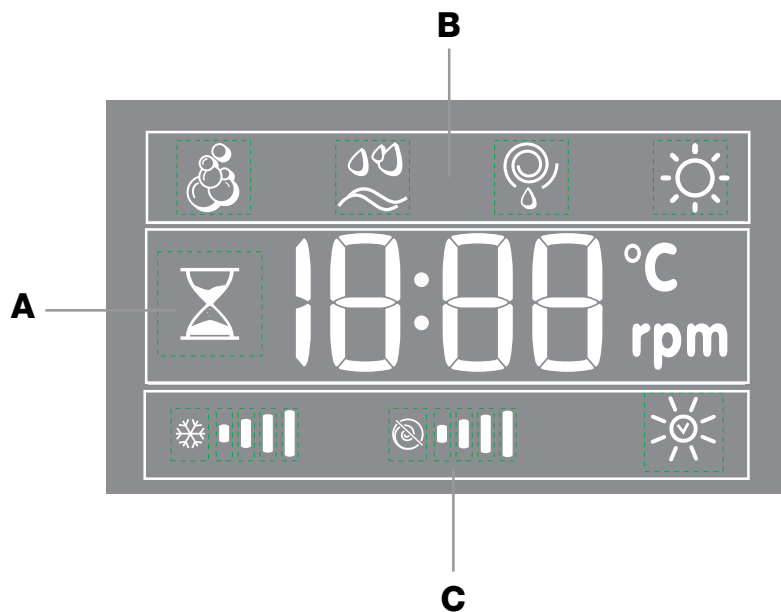







The display is useful when programming the machine and provides a great deal of information.

The duration of the available wash cycles and the remaining time of a running cycle appear in section **A**; if the DELAYED START option has been set, the countdown to the start of the selected wash cycle will appear. Furthermore, pressing the corresponding button allows you to view the maximum temperature, spin speed and drying level or time values attained by the machine during the selected cycle.

The hour-glass flashes while the machine is processing data, depending on the wash cycle and Smart level selected. After a maximum of 10 minutes, the “hour-glass” icon remains lit in a fixed manner and the final amount of time remaining is displayed. The hour-glass icon will then switch off approximately 1 minute after the final amount of time remaining has appeared.

The phases scheduled for the selected cycle and, once the cycle has begun, the current phase of the wash cycle (and drying cycle, if applicable) appear in section **B**:





-  Main wash
-  Rinse
-  Spin/Drain
-  Drying

The icons corresponding to “temperature”, “spin” and “drying” (working from the left) are displayed in section **C**. The “temperature” bars  indicate the maximum temperature level which may be selected for the set cycle. The “spin” bars  indicate the maximum spin level which may be selected for the set cycle. The  symbol lights up while the drying settings are being adjusted.

How to run a wash cycle or a drying cycle

GB

1. **SWITCH THE MACHINE ON.** Press the  button; the START/PAUSE indicator light will flash slowly in a blue colour.
2. **LOAD THE LAUNDRY.** Open the porthole door. Load the laundry, making sure you do not exceed the maximum load value indicated in the table of programmes and wash cycles on the following page.
3. **MEASURE OUT THE DETERGENT.** Pull out the detergent dispenser drawer and pour the detergent into the relevant compartments as described in "Detergents and laundry".
4. **CLOSE THE DOOR.**
5. **SELECT THE WASH CYCLE.** Use the WASH CYCLE SELECTOR knob to select the desired wash cycle. A temperature and spin speed is set for each wash cycle; these values may be adjusted. The duration of the cycle will appear on the display.
6. **CUSTOMISE THE WASH CYCLE.** Use the relevant buttons:

  **Modify the temperature and/or spin speed.** The machine automatically displays the maximum temperature and spin speed values set for the selected cycle, or the most recently-used settings if they are compatible with the selected cycle. The temperature can be decreased by pressing the  button, until the cold wash "OFF" setting is reached. The spin speed may be progressively reduced by pressing the  button, until it is completely excluded (the "OFF" setting). If these buttons are pressed again, the maximum values are restored.

Setting the drying cycle

The first time the button  is pressed, the machine will automatically select the maximum drying cycle which is compatible with the selected wash cycle. Subsequent presses will decrease the drying level and then the drying time, until the cycle is excluded completely ("OFF"). If these buttons are pressed again, the maximum values are restored.

Drying may be set as follows:

A- Based on the desired laundry dryness level:

Iron: suitable for clothes which will need ironing afterwards. the remaining dampness softens creases, making them easier to remove. "A1" appears on the display.

Hanger: ideal for clothes which do not need to be dried fully. "A2" appears on the display.

Cupboard: suitable for laundry which can be put back in a cupboard without being ironed. "A3" appears on the display.

Extra: suitable for garments which need to be dried completely, such as sponges and bathrobes. "A4" appears on the display.

B - Based on a set time period: between **30** and **180** minutes (Max. load 4 kg).

If your laundry load to be washed and dried is much greater than the maximum stated load (see *adjacent table of programmes*), perform the wash cycle, and when the cycle is complete, divide the garments into groups and put some of them back in the drum. At this point, follow the instructions provided for a "Drying only" cycle. Repeat this procedure for the remainder of the load. A cooling-down period is always added to the end of each drying cycle.

Drying only

Use the cycle selector knob to select a drying cycle (**11-12-13**) in accordance with the type of fabric. The desired drying level or time may also be set using the DRYING button .

SMART **Modify the cycle settings.**



- Press the button to enable the option; the indicator light corresponding to the button will switch on.
- Press the button again to disable the option; the indicator light will switch off.

! If the selected option is not compatible with the set wash cycle, the indicator light will flash and the option will not be activated.

! If the selected option is not compatible with a previously selected one, the indicator light corresponding to the first function selected will flash and only the second option will be activated; the indicator light for the option which has been activated will be illuminated.

Note: if the SMART option has been selected, none of the incompatible options may be activated.

! The options may affect the recommended load value and/or the duration of the cycle.

7. **START THE WASH CYCLE.** Press the START/PAUSE button. The corresponding indicator light will turn blue, remaining lit in a fixed manner, and the door will be locked (the DOOR LOCKED  symbol will be lit). To change a wash cycle while it is in progress, **pause the washer-dryer** using the START/PAUSE button (the START/PAUSE indicator light will flash slowly in an amber colour); then select the desired cycle and press the START/PAUSE button again. To open the door while a cycle is in progress, press the START/PAUSE button; if the DOOR LOCKED  symbol is switched off the door may be opened. Press the START/PAUSE button again to restart the wash cycle from the point at which it was interrupted.
8. **THE END OF THE WASH CYCLE.** This will be indicated by the text "END" on the display; when the DOOR LOCKED  symbol switches off the door may be opened. Open the door, unload the laundry and switch off the machine.

! If you wish to cancel a cycle which has already begun, press and hold the  button. The cycle will be stopped and the machine will switch off.

Table of programmes and wash cycles

Wash cycles	Description of the wash cycle	Max. temp. (°C)	Max. speed (rpm)	Drying	Detergents			Max. load (kg)	Cycle duration
						Main wash	Fabric softener		
Smart cycles.									
1	White Cotton: extremely soiled whites.	90°	1400	•		•		•	8
1	White Cotton (1): heavily soiled whites and resistant colours.	60°	1400	•		•		•	8
1	White Cotton (2): heavily soiled whites and delicate colours.	40°	1400	•		•		•	8
2	Cotton: heavily soiled whites and resistant colours.	60°	1400	•		•		•	8
3	Coloured Cotton(3): lightly soiled whites and delicate colours.	40°	1400	•		•		•	8
4	Synthetics: heavily soiled resistant colours.	40°	800	•		•		•	3,5
5	Jeans	40°	800	•		•		•	4
6	Shirts	40°	600	•		•		•	2
Special cycles									
7	Wool: for wool, cashmere, etc.	40°	800	•		•		•	2
8	Delicates: for garments in silk and viscose, lingerie.	30°	0	-		•		•	2
9	Duvet: for down-stuffed garments	30°	1000	-		•		•	3
10	Sport Shoes	30°	600	-		•		•	Max. 2 pairs
Dry cycles									
11	Cottons	-	-	•		-		-	6
12	Synthetics	-	-	•		-		-	3,5
13	Wool	-	-	•		-		-	2
Partial cycles									
	Rinse	-	1400	•		-		•	8
	Spin	-	1400	•		-		-	8
	Drain	-	0	-		-		-	8

The duration of the wash cycles can be checked on the display.

For all Test Institutes:

- 1) Test wash cycle in compliance with regulation EN 50229: select wash cycle 1 with a temperature of 60°C.
- 2) Long wash cycle for cottons: select wash cycle 1 with a temperature of 40.
- 3) Short wash cycle for cottons: select wash cycle 3 with a temperature of 40.

Wash options

SMART

The **SMART** option optimises washing to suit the quantity of laundry loaded into the machine, thereby reducing the overall wash cycle duration while minimising water and energy consumption. Press the **SMART** button to select the type of wash cycle desired:

Intense: vigorous wash cycle for garments with a heavy soil level.

Perform: standard wash cycle for garments with a normal soil level.

Fast: quick wash cycle for garments with a light soil level.

! This may only be used in conjunction with wash cycles 1, 2, 3, 4 (all three levels) and 5, 6 (**Perform** and **Fast** levels).

Easy iron

By selecting this function, the wash and spin cycles will be modified in order to reduce the formation of creases. At the end of the cycle the washer-dryer will perform slow rotations of the drum, while the **EASY IRON** and **START/PAUSE** indicator lights will flash (blue and orange respectively). To end the cycle, press the **START/PAUSE** button or the **EASY IRON** button. For wash cycles number 8, the machine will end the cycle while the laundry is soaking; the **EASY IRON** and **START/PAUSE** indicator lights will flash. To drain the water so that the laundry may be removed, press the **START/PAUSE** button or the **EASY IRON** button.

! It cannot be used in conjunction with wash cycles 7, 10, 11, 12, 13, , , .

Note: If you also want to run the drying cycle, this option is enabled only if combined with level "A1" (Iron dry).

Cool Wash

The **Cool Wash** function saves energy by not heating the water used to wash your laundry – an advantage both to the environment and to your energy bill.

Instead, intensified wash action and water optimisation ensure great wash results in the same average time of a standard cycle.

For the best washing results we recommend the usage of a liquid detergent.

! It cannot be used in conjunction with wash cycles 6, 7, 8, 9, 10, 11, 12, 13, , , .

Delayed start

To set a delayed start for the selected cycle, press the corresponding button repeatedly until the required delay period has been reached. When this option is enabled, the corresponding indicator light will remain lit. To remove the delayed start setting, press the button until the text "OFF" appears on the display.

! This option can be used in conjunction with all cycles.

Detergents and laundry

GB

Detergent dispenser drawer

Successful washing results also depend on the correct dose of detergent: adding too much detergent will not necessarily result in a more efficient wash, and may in fact cause build up on the inside of your appliance and contribute to environmental pollution.

! Do not use hand washing detergents; they create too much foam.

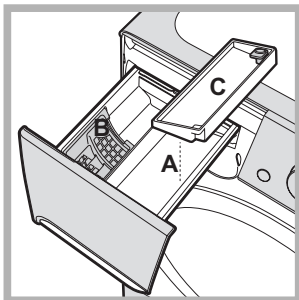

Open the detergent dispenser drawer and pour in the detergent or washing additive, as follows.

Compartment A: Washing detergent (powder or liquid)

Liquid detergent should only be poured in immediately prior to the start of the wash cycle.

Compartment B: Additives (fabric softeners, etc.)

The fabric softener should not overflow the grid.

extra compartment C: we recommend this compartment is used for liquid detergent.

Preparing the laundry

- Divide the laundry according to:
 - the type of fabric/the symbol on the label
 - the colours: separate coloured garments from whites.
- Empty all garment pockets and check the buttons.
- Do not exceed the listed values, which refer to the weight of the laundry when dry:
 - Durable fabrics: max. 8 kg
 - Synthetic fabrics: max. 3,5 kg
 - Delicate fabrics: max. 2 kg
 - Wool: max. 2 kg
 - Silk: max. 2 kg

How much does your laundry weigh?

- 1 sheet 400-500 g
- 1 pillow case 150-200 g
- 1 tablecloth 400-500 g
- 1 bathrobe 900-1,200 g
- 1 towel 150-250 g

Special wash cycles

Jeans: turn the garments inside out before washing and use liquid detergent. Use wash cycle **5**.

Shirts: use special wash cycle **6** to wash shirts in various fabrics and colours.

It guarantees maximum care is taken of the garments and minimises the formation of creases.

Wool: wash cycle **7** can be used to wash all woollen garments in the machine, even those carrying the “hand wash only”  label. To achieve the best results, use a special detergent and do not exceed the maximum load of 2 kg.

Delicates: use special wash cycle **8** to wash all silk garments. We recommend the use of special detergent which has been designed to wash delicate clothes.

Curtains: we recommend you fold the curtains and place them in a pillow case or mesh bag. Use wash cycle **8**.

Duvet: to wash double or single duvets (the weight of which should not exceed 3 kg), cushions or clothes padded with goose down such as puffer jackets, use the special wash cycle number **9** “Duvet”. We recommend that duvets are placed in the drum with their edges folded inwards (see figure) and that no more than $\frac{3}{4}$ of the total volume of the drum is used.

To achieve the best results, we recommend that a liquid detergent is used and placed inside the detergent dispenser drawer.

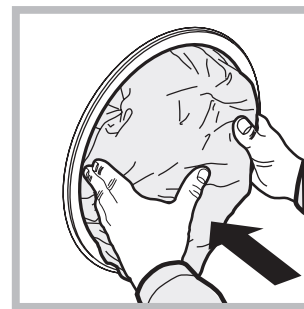

Sport Shoes (wash cycle 10): is for washing sports shoes; for best results, do not wash more than 2 pairs simultaneously.

Load balancing system

Before every spin cycle, to avoid excessive vibrations before every spin and to distribute the load in a uniform manner, the drum rotates continuously at a speed which is slightly greater than the washing rotation speed. If, after several attempts, the load is not balanced correctly, the machine spins at a reduced spin speed. If the load is excessively unbalanced, the washer-dryer performs the distribution process instead of spinning. To encourage improved load distribution and balance, we recommend small and large garments are mixed in the load.

! This washer-dryer was designed and constructed in accordance with international safety regulations. The following information is provided for safety reasons and must therefore be read carefully.

General safety

- This appliance is not intended for use by persons (including children) with reduced physical, sensory or mental capabilities, or lack of experience and knowledge, unless they have been given supervision or instruction concerning use of the appliance by a person responsible for their safety. Children should be supervised to ensure that they do not play with the appliance.
- Do not dry unwashed items in the tumble dryer. Items that have been soiled with substances such as cooking oil, acetone, alcohol, petrol, kerosene, spot removers, turpentine, waxes and wax removers should be washed in hot water with an extra amount of detergent before being dried in the tumble dryer. Items such as foam rubber (latex foam), shower caps, waterproof textiles, rubber backed articles and clothes or pillows fitted with foam rubber pads should not be dried in the tumble dryer. Fabric softeners, or similar products, should be used as specified by the fabric softener instructions. The final part of a tumble dryer cycle occurs without heat (cool down cycle) to ensure that the items are left at a temperature that ensures that the items will not be damaged.
WARNING: Never stop a tumble dryer before the end of the drying cycle unless all items are quickly removed and spread out so that the heat is dissipated.
- This appliance was designed for domestic use only.
- Do not touch the machine when barefoot or with wet or damp hands or feet.
- Do not pull on the power supply cable when unplugging the appliance from the electricity socket. Hold the plug and pull.
- Do not open the detergent dispenser drawer while the machine is in operation.
- Do not touch the drained water as it may reach extremely high temperatures.
- Never force the porthole door. This could damage the safety lock mechanism designed to prevent accidental opening.
- If the appliance breaks down, do not under any circumstances access the internal mechanisms in an attempt to repair it yourself.
- Always keep children well away from the appliance while it is operating.
- The door can become quite hot during the wash cycle.
- If the appliance has to be moved, work in a group of two or three people and handle it with the utmost care. Never try to do this alone, because the appliance is very heavy.
- Before loading laundry into the washer-dryer, make sure the drum is empty.
- During the drying phase, the door tends to get quite hot.
- Do not use the appliance to dry clothes that have been washed with flammable solvents (e.g. trichlorethylene).

- Do not use the appliance to dry foam rubber or similar elastomers.
- Make sure that the water tap is turned on during the drying cycles.

Disposal

- Disposing of the packaging materials: observe local regulations so that the packaging may be re-used.
- The European Directive 2002/96/EC relating to Waste Electrical and Electronic Equipment (WEEE) states that household appliances should not be disposed of using the normal solid urban waste cycle. Exhausted appliances should be collected separately in order to optimise the cost of re-using and recycling the materials inside the machine, while preventing potential damage to the atmosphere and to public health. The crossed-out dustbin is marked on all products to remind the owner of their obligations regarding separated waste collection. For more information relating to the correct disposal of household appliances, owners should contact their local authorities or appliance dealer.

Opening the porthole door manually

In the event that it is not possible to open the porthole door due to a powercut, and if you wish to remove the laundry, proceed as follows:

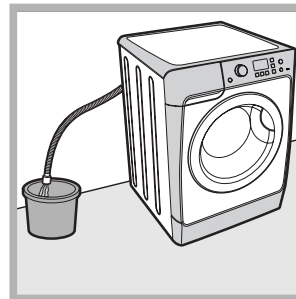

1. Remove the plug from the electrical socket.
2. Make sure the water level inside the machine is lower than the door opening; if it is not, remove excess water using the drain hose, collecting it in a bucket as indicated in the figure.

3. Remove the cover panel on the lower front part of the washer-dryer (see overleaf).

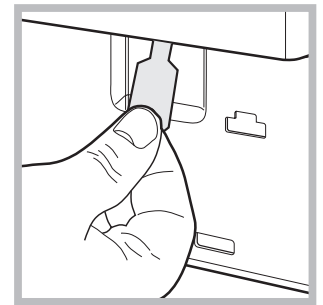
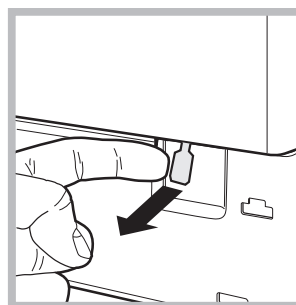

4. Pull outwards using the tab as indicated in the figure, until the plastic tie-rod is freed from its stop position; pull downwards and open the door at the same time.
5. Reposition the panel, making sure the hooks are securely in place before you push it onto the appliance.

Care and maintenance

GB

Cutting off the water and electricity supplies

- Turn off the water tap after every wash cycle. This will limit wear on the hydraulic system inside the washer-dryer and help to prevent leaks.
- Unplug the washer-dryer when cleaning it and during all maintenance work.

Cleaning the washer-dryer

The outer parts and rubber components of the appliance can be cleaned using a soft cloth soaked in lukewarm soapy water. Do not use solvents or abrasives.

Cleaning the detergent dispenser drawer

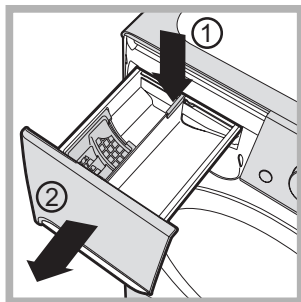

To remove the drawer, press lever (1) and pull the drawer outwards (2) (see figure). Wash it under running water; this procedure should be repeated frequently.

Cleaning the pump

The washer-dryer is fitted with a self-cleaning pump which does not require any maintenance. Sometimes, small items (such as coins or buttons) may fall into the protective pre-chamber at the base of the pump.

! Make sure the wash cycle has finished and unplug the appliance.

To access the pre-chamber:

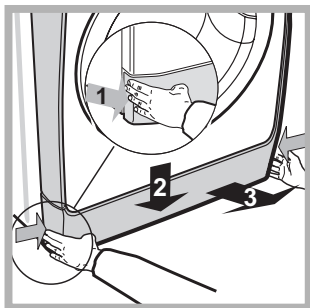

1. Take off the cover panel on the front of the machine by first pressing it in the centre and then pushing downwards on both sides until you can remove it (see figures).

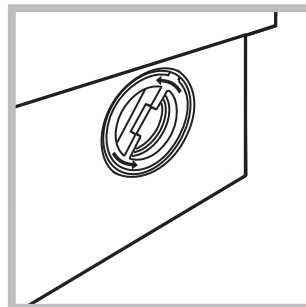

2. Unscrew the lid by rotating it anti-clockwise (see figure): a little water may trickle out. This is perfectly normal.

3. Clean the inside thoroughly.
4. Screw the lid back on.
5. Reposition the panel, making sure the hooks are securely in place before you push it onto the appliance.

Checking the water inlet hose

Check the inlet hose at least once a year. If there are any cracks, it should be replaced immediately: during the wash cycles, water pressure is very strong and a cracked hose could easily split open.

! Never use second-hand hoses.

Your washer-dryer could occasionally fail to work. Before contacting the Technical Assistance Service (see “Service”), make sure that the problem cannot be not solved easily using the following list.

Problem:

Possible causes / Solutions:

The washer-dryer does not switch on.

- The appliance is not plugged into the socket fully, or not enough to make contact.
- There is no power in the house.

The wash cycle does not start.

- The washer-dryer door is not closed properly.
- The ON/OFF button has not been pressed.
- The START/PAUSE button has not been pressed.
- The water tap has not been opened.
- A delayed start has been set.

The washer-dryer does not fill with water (the text “H2O” flashes on the display).

- The water inlet hose is not connected to the tap.
- The hose is bent.
- The water tap has not been opened.
- There is no water supply in the house.
- The pressure is too low.
- The START/PAUSE button has not been pressed.

The washer-dryer continuously takes in and drains water.

- The drain hose is not fitted at a height between 65 and 100 cm from the floor (see “Installation”).
- The free end of the hose is under water (see “Installation”).
- The wall drainage system is not fitted with a breather pipe.

If the problem persists even after these checks, turn off the water tap, switch the appliance off and contact the Technical Assistance Service. If the dwelling is on one of the upper floors of a building, there may be problems relating to water drainage, causing the washer-dryer to fill with water and drain continuously. Special anti-draining valves are available in shops and help to prevent this inconvenience.

The washer-dryer does not drain or spin.

- The wash cycle does not include draining: some cycles require the draining process to be enabled manually.
- The EASY IRON option is enabled: To complete the wash cycle, press the START/PAUSE button (see “Wash cycles and options”).
- The drain hose is bent (see “Installation”).
- The drainage duct is clogged.

The washer-dryer vibrates a lot during the spin cycle.

- The drum was not unlocked correctly during installation (see “Installation”).
- The washer-dryer is not level (see “Installation”).
- The washer-dryer is trapped between cabinets and walls (see “Installation”).

The washer-dryer leaks.

- The water inlet hose is not screwed on properly (see “Installation”).
- The detergent dispenser drawer is blocked (for cleaning instructions, see “Care and maintenance”).
- The drain hose is not fixed properly (see “Installation”).

The “option” and START/PAUSE indicator lights flash rapidly and an error code appears on the display (e.g.: F-01, F-..).

- Switch off the machine and unplug it, wait for approximately 1 minute and then switch it back on again.
If the problem persists, contact the Technical Assistance Service.

There is too much foam.

- The detergent is not suitable for machine washing (it should display the text “for washer-dryers” or “hand and machine wash”, or the like).
- Too much detergent was used.

The washer-dryer does not dry.

- The appliance is not plugged into the socket, or not enough to make contact.
- There has been a power failure.
- The appliance door is not shut properly.
- A DELAY TIMER has been set.
- DRYING is in the OFF position.

Service

GB

Before contacting the Technical Assistance Service:

- Check whether you can solve the problem alone (see “*Troubleshooting*”).
- Restart the wash cycle to check whether the problem has been solved.
- If this is not the case, contact an authorised Technical Assistance Centre.

! Always request the assistance of authorised technicians.

Have the following information to hand:

- the type of problem;
- the appliance model (Mod.);
- the serial number (S/N).

This information can be found on the data plate applied to the rear of the washer-dryer, and can also be found on the front of the appliance by opening the door.

12 Months Parts and Labour Guarantee

Your appliance has the benefit of our manufacturer's guarantee, which covers the cost of breakdown repairs for twelve months from the date of purchase.

This gives you the reassurance that if, within that time, your appliance is proven to be defective because of either workmanship or materials, we will, at our discretion, either repair or replace the appliance at no cost to you.

This guarantee is subject to the following conditions:

- The appliance has been installed and operated correctly and in accordance with our operating and maintenance instructions.
- The appliance is used only on the electricity or gas supply printed on the rating plate.
- The appliance has been used for normal domestic purposes only.
- The appliance has not been altered, serviced, maintained, dismantled, or otherwise interfered with by any person not authorised by us.
- Any repair work must be undertaken by us or our appointed agent.
- Any parts removed during repair work or any appliance that is replaced become our property.
- The appliance is used in the United Kingdom or Republic of Ireland.

The guarantee does not cover:

- Damage resulting from transportation, improper use, neglect or interference or as a result of improper installation.
- Replacement of any consumable item or accessory . These include but are not limited to: plugs, cables, batteries, light bulbs, fluorescent tubes and starters, covers and filters.
- Replacement of any removable parts made of glass or plastic.

THIS GUARANTEE WILL NOT APPLY IF THE APPLIANCE HAS BEEN USED IN COMMERCIAL OR NON-DOMESTIC PREMISES.

5 Year Parts Guarantee

Indesit also offers you a free 5 year parts guarantee. This additional guarantee is conditional on you registering your appliance with us and the parts being fitted by one of our authorised engineers. There will be a charge for our engineer's time. To activate the extra parts warranty on your appliance, simply call our registration line on **08448 24 24 24 (Republic of Ireland 01 230 0800)**.

Extended Guarantees

We offer a selection of repair protection plans that enable you to fully cover yourself against the expense of repair bills for the life of your policy. To find the ideal plan for you please call our advice line on **08448 226 226 (Republic of Ireland 01 230 0233)**.

Free Helpdesk Service

We have a dedicated team who can provide free advice and assistance with your appliance if you experience any technical difficulties within the first 90 days of ownership. Simply call our Indesit Service Hotline on **08448 224 224 (Republic of Ireland 0818 313 413)** for telephone assistance, or, where necessary, to arrange for an engineer to call.

After Sales Service

No one is better placed to care for your Indesit appliance during the course of its working life than us - the manufacturer.

Essential Contact Information

Indesit Service

We are the largest service team in Europe offering you access to 400 skilled telephone advisors and 1100 fully qualified engineers on call to ensure you receive fast, reliable, local service.

UK: 08448 224 224

Republic of Ireland: 0818 313 413

www.indesitservice.co.uk

Please note: Our advisors will require the following information:

Model number:

Serial number:

Parts and Accessories

We supply a full range of genuine replacement parts as well as accessory products that protect and hygienically clean your appliance to keep it looking good and functioning efficiently throughout its life.

UK: 08448 225 225

Republic of Ireland: 0818 313 413

www.indesitservice.co.uk

Appliance Registration

We want to give you additional benefits of Indesit ownership. To activate your free 5 year parts guarantee you must register your appliance with us.

UK: 08448 24 24 24

Republic of Ireland: 01 230 0800

www.indesitservice.co.uk

Indesit Company UK Ltd. Morley Way, Peterborough, PE2 9JB

Indesit Company Unit 49 Airways Industrial Estate, Dublin 17



Recycling & Disposal Information

As part of Indesit's continued commitment to helping the environment, Indesit reserves the right to use quality, recycled components to keep down customer costs and minimise material wastage.

Please dispose of packaging and old appliances carefully. To minimise the risk of injury to children, remove the door, plug and cut the mains cable off flush with the appliance. Dispose of these parts separately to ensure that the appliance can no longer be plugged into a mains socket, and the door cannot be locked shut.

Free Manuals Download Website

<http://myh66.com>

<http://usermanuals.us>

<http://www.somanuals.com>

<http://www.4manuals.cc>

<http://www.manual-lib.com>

<http://www.404manual.com>

<http://www.luxmanual.com>

<http://aubethermostatmanual.com>

Golf course search by state

<http://golfingnear.com>

Email search by domain

<http://emailbydomain.com>

Auto manuals search

<http://auto.somanuals.com>

TV manuals search

<http://tv.somanuals.com>