

# Instructions for use

## WASHING MACHINE

GB

GB

English, 1

**SIXL 145 SK**

### Contents

#### **Installation, 2-3-4-5**

Unpacking and levelling  
Connecting the electricity and water supplies  
Technical details

#### **Description of the machine, 6-7**

Self-cleaning detergent dispenser drawer  
Control panel  
Load balancing system

#### **Running a wash cycle, 8**

#### **Wash programmes, 9**

#### **Detergents and laundry, 10**

Preparing the laundry  
Washing recommendations

#### **Precautions and advice, 11**

General safety  
Disposal  
Saving energy and respecting the environment  
Drip-tray system

#### **Care and maintenance, 12**

Cutting off the water or electricity supply  
Cleaning the machine  
Cleaning the detergent dispenser drawer  
Caring for the door and drum of your appliance  
Cleaning the pump  
Checking the water inlet hose

#### **Troubleshooting, 13**

#### **Service and Guarantee, 14-15-16**

Before calling for Assistance  
Guarantee

# Installation

GB

! Keep this instruction manual in a safe place for future reference. Should the appliance be sold, transferred or moved, make sure the instruction manual accompanies the washing machine to inform the new owner as to its operation and features.

! Read these instructions carefully: they contain vital information on installation, use and safety.

## Unpacking and levelling

### Unpacking

1. Unpack the washing machine.
2. Check whether the washing machine has been damaged during transport. If this is the case, do not install it and contact your retailer.

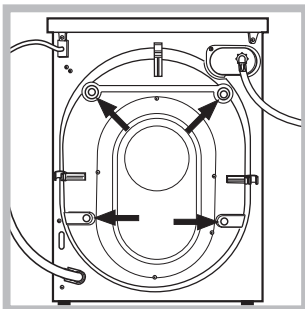

3. Remove the 4 protective screws and the rubber bush with the respective spacer, situated on the rear of the appliance (see also the installation leaflet).  
**NB:** The plastic spacers may fall down inside the machine once the bolt

has been removed, and will not interfere with the operation of the machine.

4. Seal the gaps using the plastic plugs provided.
5. Keep all the parts: you will need them again if the washing machine needs to be moved to another location.

! Packaging materials are not children's toys.

### Levelling

Your machine may make a considerable amount of noise if the two front feet have not been adjusted correctly.

1. Install the washing machine on a flat sturdy floor, without resting it up against walls, furniture cabinets or other.

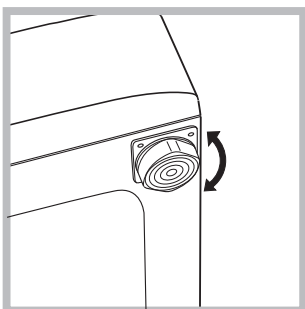

2. If the floor is not perfectly level, compensate for any unevenness by tightening or loosening the adjustable front feet (see figure); the angle of inclination, measured according to the worktop, must not exceed 2°.

Levelling your appliance correctly will provide it with stability and avoid any vibrations, noise and shifting during operation. If it is placed on a fitted or loose carpet, adjust the feet in such a way as to allow enough room for ventilation beneath the washing machine.

## Electric and water connections

### Connecting the water inlet hose

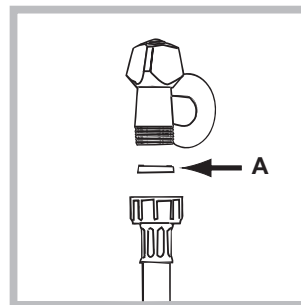

1. Insert seal A into the end of the inlet hose and screw the latter onto a cold water tap with a 3/4 gas threaded mouth (see figure). Before making the connection, allow the water to run freely until it is perfectly clear.

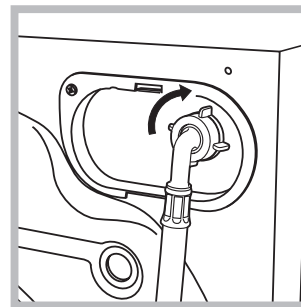

2. Connect the other end of the water inlet hose to the washing machine, screwing it onto the appliance's cold water inlet, situated on the top right-hand side on the rear of the appliance (see figure).

3. Make sure there are no kinks or bends in the hose.

! The water pressure at the tap must be within the values indicated in the Technical details table (on the next page).

! If the water inlet hose is not long enough, contact a specialist store or an authorised serviceman.

! Ensure that the supply taps are allowing water through. Old taps may seize in the closed position and thus prevent water reaching the machine.

### Connecting the drain hose

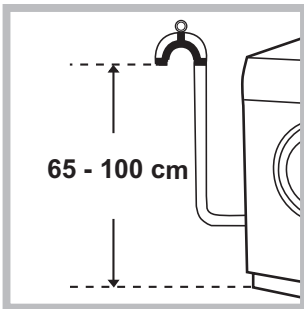

Connect the drain hose, without bending it, to a draining duct or a wall drain situated between 65 and 100 cm from the floor;

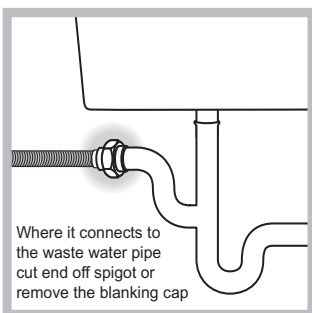

The drain hose may be connected to an under-sink trap. Before connecting the drain hose from the machine ensure that any blanks or removable ends have been taken off the spigot.

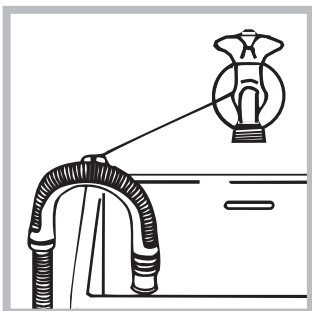

If it is place over the edge of a basin or sink be sure the free end of the hose should not be underwater.

**!** We advise against the use of hose extensions; in case of absolute need, the extension must have the same diameter as the original hose and must not exceed 150 cm in length.

Ensure that if the drain hose is pushed into a standpipe, that the end does not go down more than 15cms (6 inches). If the hose is pushed down too far, this may cause the machine to self-siphon ie. continuously empty as it is filling.

### Electric connection

Before plugging the appliance into the mains socket, make sure that:

- the socket is earthed and in compliance with the applicable law;
- the socket is able to sustain the appliance's maximum power load indicated in the Technical details table (see page 5);

- the supply voltage is included within the values indicated on the Technical details table (see page 5);
- the socket is compatible with the washing machine's plug. If this is not the case, replace the socket or the plug.

Your appliance is now supplied with a 13 amp fused plug it can be plugged into a 13 amp socket for immediate use. Before using the appliance please read the instructions below.

**WARNING - THIS APPLIANCE MUST BE EARTHED. THE FOLLOWING OPERATIONS SHOULD BE CARRIED OUT BY A QUALIFIED ELECTRICIAN.**

#### Replacing the fuse:

When replacing a faulty fuse, a 13 amp ASTA approved fuse to BS 1362 should always be used, and the fuse cover re-fitted. If the fuse cover is lost, the plug must not be used until a replacement is obtained.

#### Replacement fuse covers:

If a replacement fuse cover is fitted, it must be of the correct colour as indicated by the coloured marking or the colour that is embossed in words on the base of the plug. Replacements can be obtained directly from your nearest Service Depot.

#### Removing the plug:

If your appliance has a non-rewireable moulded plug and you should wish to re-route the mains cable through partitions, units etc., please ensure that either:

the plug is replaced by a fused 13 ampere re-wearable plug bearing the BSI mark of approval. or:

the mains cable is wired directly into a 13 amp cable outlet, controlled by a switch, (in compliance with BS 5733) which is accessible without moving the appliance.

#### Disposing of the plug:

Ensure that before disposing of the plug itself, you make the pins unusable so that it cannot be accidentally inserted into a socket.

Instructions for connecting cable to an alternative plug: Important: the wires in the mains lead are coloured in accordance with the following code:

<b>Green &amp; Yellow</b>	<b>Earth</b>
<b>Blue</b>	<b>Neutral</b>
<b>Brown</b>	<b>Live</b>

As the colours of the wires in the lead may not correspond with the coloured markings identifying the terminals in your plug, proceed as follows:  
 Connect Green & Yellow wire to terminal marked **E** or  $\equiv$  or coloured Green or Green & Yellow.  
 Connect Brown wire to terminal marked **L** or coloured Red.  
 Connect Blue wire to terminal marked **N** or coloured Black.

If a 13 amp plug (BS 1363) is used it must be fitted with a 13 amp fuse, either in the plug or adaptor or at the distribution board.

If you are in any doubt the electrical supply to your machine, consult a qualified electrician before use.

How to connect an alternative plug:

The wires in this mains lead are coloured in accordance with the following code:

<b>BLUE</b>	<b>NEUTRAL (N)</b>
<b>BROWN</b>	<b>LIVE (L)</b>
<b>GREEN &amp; YELLOW</b>	<b>EARTH (E)</b>

#### *Disposing of the appliance:*

When disposing of the appliance please remove the plug by cutting the mains cable as close as possible to the plug body and dispose of it as described above.

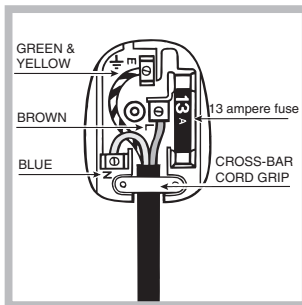

! The washing machine should not be installed in an outdoor environment, not even when the area is sheltered, because it may be very dangerous to leave it exposed to rain and thunderstorms.



! When the washing machine is installed, the mains socket must be within easy reach.

! Do not use extensions or multiple sockets.

! The power supply cable must never be bent or dangerously compressed.

! The power supply cable must only be replaced by an authorised serviceman.

Warning! The company denies all liability if and when these norms are not respected.

<b>Technical details</b>	
<b>Model</b>	SIXL 145 SK
<b>Dimensions</b>	59.5 cm wide 85 cm high 53.5 cm deep
<b>Capacity</b>	from 1 to 6 kg
<b>Electric connections</b>	please refer to the technical data plate fixed to the machine
<b>Water connections</b>	maximum pressure 1 MPa (10 bar) minimum pressure 0.05 MPa (0.5 bar) drum capacity 52 litres
<b>Spin speed</b>	up to 1400 rpm
<b>Control programmes according to EN 60456 directive</b>	programme  : run with a load of 6 kg.
 	This appliance is compliant with the following European Community Directives: - 89/336/CEE of 03/05/89 (Electromagnetic Compatibility) and subsequent amendments - 2002/96/CE - 2006/95/CE (Low Voltage)

# Description of the machine

GB

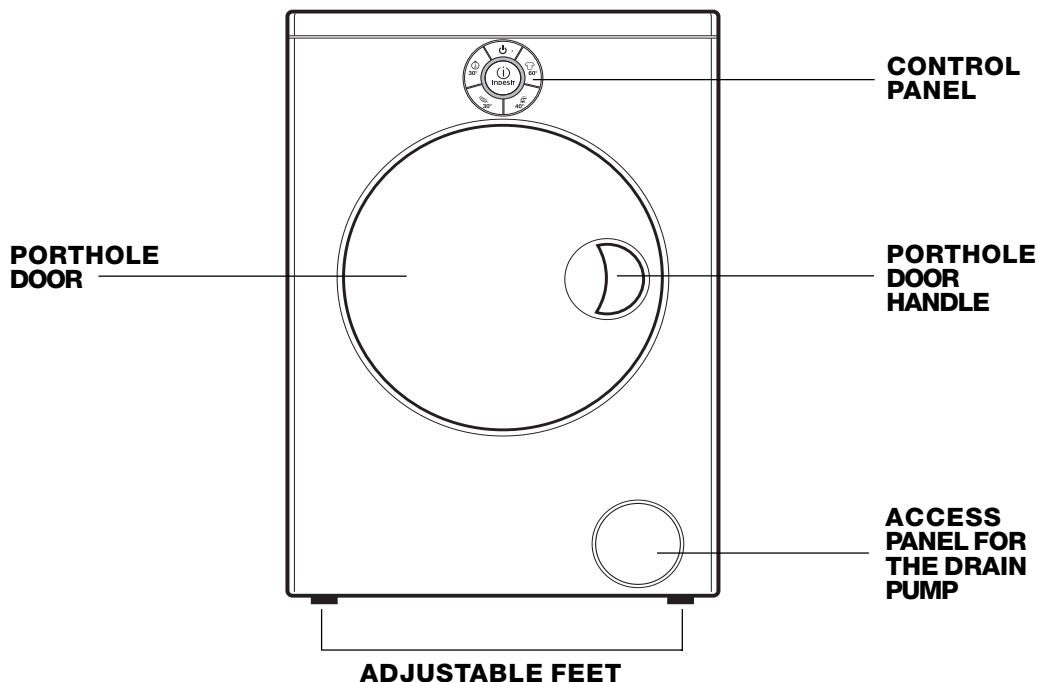

## Self-cleaning detergent dispenser drawer

This washing machine is fitted with an innovative self-cleaning detergent drawer which enhances the quality of each wash.

The drawer is located inside the porthole door.

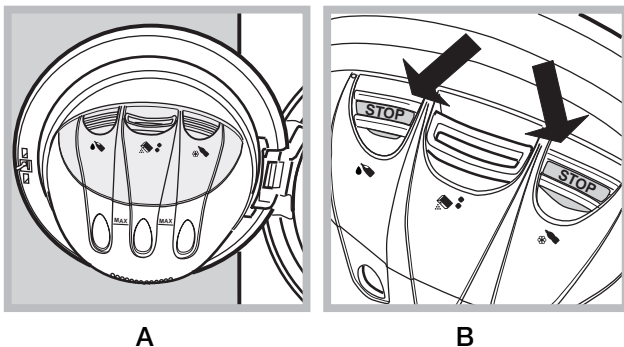

1. Open the porthole door to access the detergent dispenser drawer (see figure A).
2. Pour the detergent or the additive into the compartments, over the protective grilles, as follows:  
**Compartment** : detergent and additives in liquid form.  
**Compartment** : detergent in powder or tablet form and powder additives.  
To place the tablets inside, **lift up the grille** protecting the drawer.  
**Compartment** : fabric softener.

**!** Pouring liquid detergent or additives into the central compartment may cause leakages to occur.

The detergent level can be seen through the corresponding transparent windows provided on the compartment.

**!** Inside compartments and , there are also floating indicators (see figure B) . When the maximum quantity of detergent/fabric softener has been measured out, the indicators rise until they touch the grilles protecting the compartments.

**!** We recommend that the maximum levels indicated on the detergent dispenser drawer are not exceeded.

**!** We recommend that the dosage instructions on the detergent packaging are followed carefully. If using certain particularly thick types of detergent, we suggest that these are placed directly inside the drum and not in the detergent dispenser drawer.

Exceeding the maximum levels indicated on the machine may cause the detergent to leak out of the bottom part of the drawer.

Exceeding the stated amount of detergent does not result in a more effective wash; it simply pollutes the environment more.

The water used during the wash cycle will remove any excess detergent from the drawer. It is, however, possible **to remove the drawer manually** (see "Care and Maintenance").

To facilitate the process of measuring out the detergents, we recommend that the dosing device supplied with the washing machine is used.

The maximum capacity of the drawer is as follows:

- liquid detergents: 1 1/2 measures
- powder detergents: 2 measures
- fabric softener: 1 measure

## Control panel

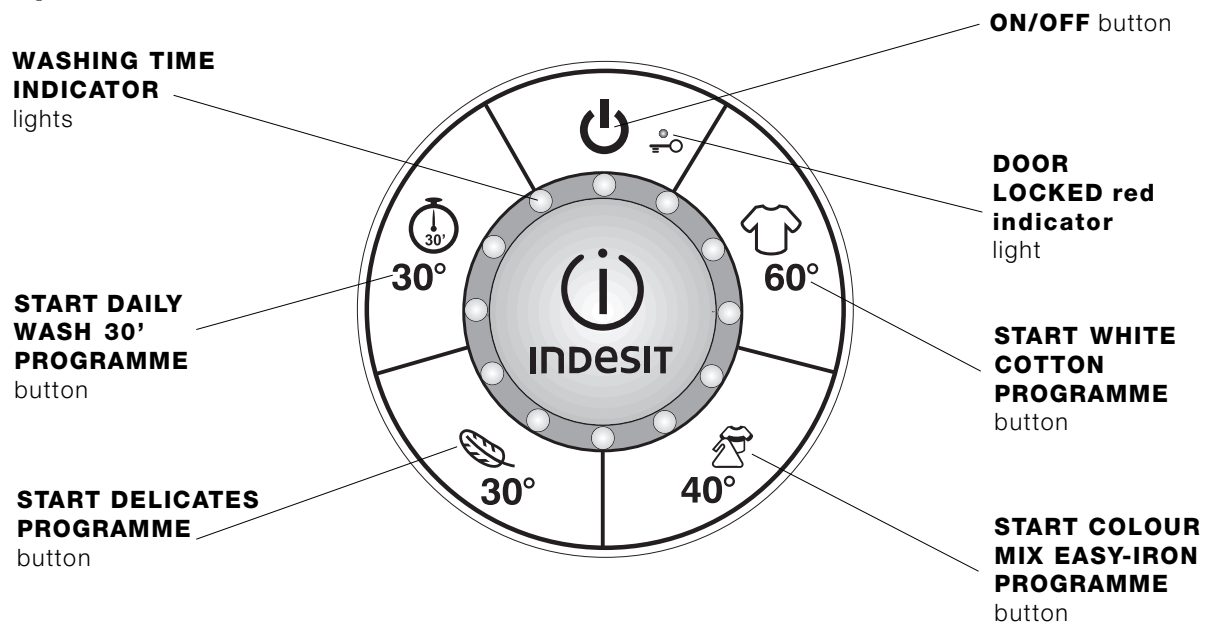

GB

**ON/OFF button:** press this to switch the machine on or off. **When the machine is switched on, the buttons used to start various programmes begin to flash, while the washing time indicator lights illuminate in a fixed manner.**

**To cancel the cycle,** press and hold the on/off button for approximately 2 seconds while the wash cycle is in progress.

The  indicator light **will flash for a few seconds** and the machine will automatically drain the water in the tub.

**DOOR LOCKED red indicator light:** when the indicator light is illuminated the door is locked to prevent it being opened accidentally; to avoid damaging the appliance, **wait for the light to switch off before opening the door after the cycle has ended or when the cycle is paused. The light will remain lit for approximately two minutes after the washing programme has finished.**

**!** Rapid flashing of the DOOR LOCKED indicator light indicates a fault (see *"Troubleshooting"*).

**START PROGRAMME buttons:** press one of these to start the selected washing programme.

- button lit in a fixed manner: programme in progress.
- buttons flashing: awaiting selection.

**WASHING TIME INDICATOR lights:** these light up in sequence to indicate the progress of the washing programme. At the end of the programme all the indicator lights begin to flash. For further details, please refer to the chapter entitled *"Running a wash cycle"*.

### Load balancing system

To avoid excessive vibrations before every spin, the machine distributes the load in a uniform manner by rotating the drum continuously at a speed which is slightly greater than the washing rotation speed. When, despite repeated attempts, the load is not perfectly distributed, the machine spins at a lower speed than stated for the wash cycle. If the load is excessively unbalanced, the machine performs the distribution process instead of spinning. Balancing attempts may increase the total duration of the cycle, up to a maximum of 10 minutes.

# Running a wash cycle

GB

**Note:** Once the appliance has been installed, and before you use it for the first time, run a wash cycle with detergent and no laundry, using the  programme.

1. SWITCH ON THE MACHINE by pressing the ON/OFF  button. The icons for the START PROGRAMME buttons begin to flash and the WASHING TIME INDICATOR lights light up in a fixed manner, to indicate that the washing machine is ready to receive instructions.
2. LOAD THE LAUNDRY. Open the door using the handle. Load the laundry, making sure you do not exceed the maximum load value indicated in the table of programmes on the following page.
3. MEASURE OUT THE DETERGENT AND ADDITIVES. Pour the detergents into the drawer located inside the porthole door, taking care not to exceed the maximum levels indicated on the surface of the drawer and by the floating indicators. For further details, please refer to the chapter entitled "Description of the machine".
4. CLOSE THE DOOR.

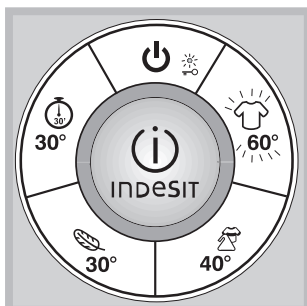

5. START THE WASHING PROGRAMME by pressing the corresponding START PROGRAMME BUTTON. The icon corresponding to the selected programme illuminates in a fixed

manner, and all the wash time indicator lights switch off. The DOOR LOCKED indicator light illuminates in a fixed manner, to signal the activation of the door safety device.

For a description of the wash programmes available, please refer to the chapter entitled "Wash programmes".

**! The procedure used to start the DELICATES  programme is different; see paragraph "Delicates 30°" on the following page.**

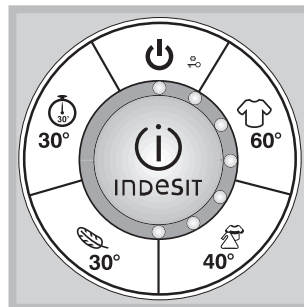

During the programme the WASH TIME INDICATOR lights illuminate in sequence, indicating how much of the programme has already been completed.

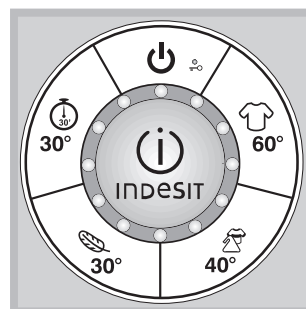

The diagram at the side refers to a situation in which approximately 50% of the cycle has been completed.



At the end of the cycle, all the WASHING TIME INDICATOR lights begin to flash.

6. The WASH PROGRAMME can be SUSPENDED by pressing the illuminated start programme button which begins to flash. After approximately two minutes the DOOR LOCKED indicator light will switch off to indicate that the door may be opened. If you wish to add more detergent, make sure that the MAX floating indicator is not in a raised position. To restart the wash programme, close the door again and press the corresponding start button once more. To guarantee maximum safety, whenever there is a quantity of water in the drum which could leak out of the machine, it will not be possible to open the door (the DOOR LOCKED indicator light will remain lit even after the two minutes have passed). The machine, in this case, should be switched off by pressing for approximately 2 seconds the ON/OFF  button, then waiting for the water to be drained automatically.
7. AT THE END OF THE PROGRAMME At the end of the wash programme, the icon corresponding to the selected programme remains lit in a fixed manner, while **all the washing time indicator lights begin to flash.** To start a new wash cycle the machine must be switched off and switched back on again, by pressing the ON/OFF  button TWO TIMES.



Button	Fabrics	Max. load (kg)	Temperature	Spin speed (rpm)	Cycle duration (minutes)	Wash cycle description
<b>WHITE COTTON</b>						
60°	Durable white cotton	6	60°C	1400	145	Wash cycle, rinse cycles, intermediate and final spin cycles
<b>COLOR MIX 40° / EASY IRON</b>						
40°	Coloured cotton and synthetics	4,5	40°C	1000	105	Wash cycle, rinse cycles and delicate spin cycle
<b>DELICATES</b>						
30° +  30°	Wool (final delicate spin cycle)	1,5	30°C	600	50	Wash cycle, rinse cycles and delicate spin cycle
30° +  30°	Silk and curtains (without final spin cycle)	1,5	30°C	no*	50	Wash cycle, rinse cycles and drainage
<b>DAILY WASH / COLD WATER RINSE</b>						
30°	Cotton and synthetics	3	30°/cold water**	800	30	Wash cycle (only if the "Rapid wash" programme activated), rinse cycles, delicate spin cycle

The duration of the programmes indicated in the table are for guidance purposes only, and are calculated based on an average load quantity.

**\*Note:** for information relating to excluding the spin cycle in the delicates programme, please refer to the "Delicates 30°" paragraph further down the page.

**\*\*Note:** for information relating to rinsing hand-washed clothes in cold water, please refer to the "Daily wash 30' / Cold water rinse" paragraph further down the page.

## 60° WHITE COTTON 60°

Designed for the washing of all durable white cotton garments. Higher washing temperatures offer improved washing results in Class A appliances.

## 40° COLOUR MIX 40° / EASY-IRON

This programme can be used to wash all your coloured garments, whether cotton or synthetic fabric. The spin cycle is carefully controlled during the entire wash cycle, so as to reduce the formation of creases in the fabric and make it easier to iron.

Cotton and synthetic garments can be washed at the same time.

## DELICATES 30°

A cycle designed for the washing of all woollen, silk and delicate garments. **As these garments have different features, this programme requires an activation process which is different from the others:**

30° + 30° **DELICATES CYCLE WITH FINAL SPIN** (for woollen garments): press the START DELICATES PROGRAMME 30° button. **After approximately 3 seconds**, the START DELICATES PROGRAMME 30° and START DAILY WASH PROGRAMME 30° buttons **begin to flash**. Press the START DELICATES PROGRAMME 30° button to perform the wash, which ends with a delicate spin cycle. This programme includes drum movements which have been carefully researched to remove excess water from the fabric, thereby reducing friction and helping to protect your woollen garments.

30° + 30° **DELICATES CYCLE WITH SPIN PHASE EXCLUDED** (for silk and viscose garments and for curtains; not to be used for washing wool): press the START DELICATES PROGRAMME 30°

button. **After approximately 3 seconds**, the START DELICATES PROGRAMME 30° and START DAILY WASH PROGRAMME 30° buttons **begin to flash**. Press the START DAILY WASH PROGRAMME 30° button to perform the wash without the final spin cycle. At the end of the cycle, the machine will automatically drain the water contained in the drum. We recommend that the garments are removed from the washing machine straight away, in order to limit the formation of creases.

## 30° DAILY WASH 30' / COLD WATER RINSE

This programme can be used to wash lightly soiled cotton or synthetic fabrics, or garments with the "wash at 30°" 30° instruction on the label, in just 30 minutes. It is also possible to rinse cotton or synthetic garments which have been washed by hand (this does not include wool or silk).

**Thanks to its special sensors, the washing machine is able to recognise when the garments placed in the drum have detergent on them.**

- if no detergent is detected on the clothes, the DAILY WASH 30' cycle will be performed;
- if detergent is detected (cloths which have been washed by hand), the COLD WATER RINSE cycle will be performed automatically.

## AUTOMATIC RINSE MANAGEMENT

The rinse function is monitored and controlled in every programme by special sensors. **If the garments are very soapy at the end of the wash, the rinse cycle will be extended automatically until the detergent is removed completely.** In this case the wash programme duration may be slightly increased in relation to the information given in the table of programmes.

# Detergents and laundry

GB

## Preparing the laundry

- Divide the laundry according to:
  - the type of fabric/the symbol on the label;
  - the colours: separate coloured garments from whites.
- Empty all garment pockets and check the buttons.
- Do not exceed the load values indicated for the "Wash programmes".

### How much does your laundry weigh?

1 sheet	400-500 g
1 pillow case	150-200 g
1 tablecloth	400-500 g
1 bathrobe	900-1.200 g
1 towel	150-250 g
1 pair of jeans	400-500 g
1 shirt	150-200 g



## Washing recommendations

**Bed and bathroom laundry (sheets, towels, bathrobes, etc.):** use the WHITE COTTON  programme which guarantees the most efficient wash in Class A appliances. The intensive spin cycle eliminates all excess water efficiently.

**White cotton garments (shirts, T-shirts, tablecloths, etc.):** use the WHITE COTTON 60° programme. If there are any stubborn stains, they should be pre-treated with solid soap before the wash cycle is started.

**Coloured cotton garments (shirts, T-shirts, underwear, etc.):** use the COLOUR MIX 40°  programme, which maximises the performance of the wash without damaging the colours. The spin cycle phase, thanks to the incorporated EASY IRON function, reduces the formation of creases at the end of the wash, making the fabric easier to iron. We recommend the use of liquid detergent.

**White or coloured synthetic garments (shirts, T-shirts, underwear, etc.):** use the COLOUR MIX 40°  programme. We recommend that white and coloured garments are not washed in the same wash cycle, to prevent any colour leakage from seeping into the white clothing. We recommend the use of liquid detergent.

**Coloured synthetic and cotton garments, with "wash at 30°"  instruction on the care label:** use the DAILY WASH 30'  programme. The low washing temperature protects the coloured fabrics. We recommend the use of liquid detergent.

**Woollen garments (jumpers, scarves, etc.):** use the DELICATES 30° programme with final spin . The movement of the drum during the wash and the delicate spin cycle reduces fabric matting. We recommend the use of detergents specifically designed for woollen garments. We recommend that the maximum load level is not exceeded.

**Silk garments (shirts, underwear, etc.):** use the DELICATES 30° programme with the spin excluded . Try not to leave the laundry in the drum for too long after the wash cycle has finished, to prevent excessive creasing.

**Curtains:** use the DELICATES 30° programme with the spin excluded . We recommend they are folded and placed inside a pillowcase or a mesh bag. Wash them separately, making sure the maximum load level is not exceeded.

! This machine was designed and constructed in accordance with international safety regulations. The following information is provided for safety reasons and must therefore be read carefully.

## General safety

- This appliance was designed for domestic use only.
- The machine must only be used by adults, in accordance with the instructions given in this manual.
- Do not touch the machine when barefoot or with wet or damp hands or feet.
- Do not pull on the power supply cable when unplugging the appliance from the electricity socket. Hold the plug and pull.
- Do not touch the drained water as it may reach extremely high temperatures.
- Never force the porthole door. This could damage the safety lock mechanism designed to prevent accidental opening.
- If the appliance breaks down, do not under any circumstances access the internal mechanisms in an attempt to repair it yourself.
- Always keep children well away from the appliance while it is operating.
- The door can become quite hot during the wash cycle.
- If the appliance has to be moved, work in a group of two or three people and handle it with the utmost care. Never try to do this alone, because the appliance is very heavy.
- Before loading laundry into the washing machine, make sure the drum is empty.

## Disposal

- Disposing of the packaging materials: observe local regulations so that the packaging may be re-used.
- The European Directive 2002/96/EC on Waste Electrical and Electronic Equipment, requires that old household electrical appliances must not be disposed of in the normal unsorted municipal waste stream. Old appliances must be collected separately in order to optimise the recovery and recycling of the materials they contain and reduce the impact on human health and the environment. The crossed out "wheeled bin"

symbol on the product reminds you of your obligation, that when you dispose of the appliance it must be separately collected.

Consumers should contact their local authority or retailer for information concerning the correct disposal of their old appliance.

GB

## Saving energy and respecting the environment

### Saving detergents, water, energy and time

- To avoid wasting resources, the washing machine should be used with a full load. One full load instead of two half loads saves up to 50% of the energy used.
- Treating stains with a stain remover, or leaving them to soak before they are washed, reduces the need to wash the garments at high temperatures.
- Use the correct quantity of detergent, in accordance with the water hardness, how soiled the garments are and the amount of laundry you have, in order to avoid wastage and to protect the environment: although they are biodegradable, detergents still contain ingredients which alter the balance of nature. Avoid using fabric softener wherever possible.
- If you use your washing machine between late afternoon and the early hours of the morning, you will help to reduce the peak load of the electricity board.

## Drip-tray system

The machine is fitted with a drip-tray system on the inside of the door, which catches any residual drips of water at the end of the cycle.

We recommend that the dampness level of the sponge inside the drip-tray compartment is checked regularly. If necessary, it may be cleaned or replaced as follows:

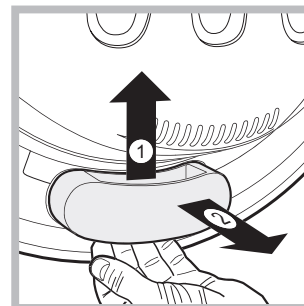

1. Remove the compartment by applying a light pressure to the lower part.
2. Remove the sponge inside it, rinse it under running water and wring it out thoroughly. It may also be replaced with one of the spare sponges provided.

3. Place the sponge back inside the compartment.
4. Replace the compartment in the door, **making sure the springs on the door are correctly inserted into the corresponding slots on the compartment.**
5. Make sure that the compartment is slotted back into position correctly.

# Care and maintenance

GB

## Cutting off the water and electricity supply

- Turn off the water tap after every wash. This will limit wear on the hydraulic system in the machine and help to prevent leaks.
- Unplug the appliance when cleaning it and during all maintenance work.

## Cleaning the machine

The outer parts and rubber components of the appliance can be cleaned using a soft cloth soaked in lukewarm soapy water. Do not use solvents or abrasives.

## Cleaning the detergent dispenser drawer

! We recommend you check that there is no detergent or water inside the detergent drawer before removing it. If these substances are present, proceed with care as they may leak out of the drawer while it is being removed.

The detergent dispenser drawer in this machine is cleaned automatically during the wash cycles. However, residues may form very occasionally after certain detergents have been used. To clean the drawer, proceed as follows:

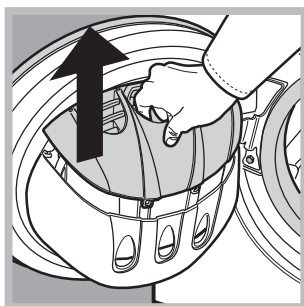

1. Open the door to access the drawer.
2. Remove the drawer by pulling upwards, holding it by the central compartment as indicated in the *figure*. Do not grip the drawer by the grille as this may damage it.

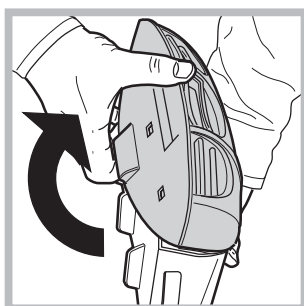

3. Unhook the drawer cover to access the compartment, as indicated in the *figure*.
4. Clean the drawer under running water.
5. Re-hook the cover and replace the drawer, pushing until it clicks into place.

## Caring for the door and drum of your appliance

- Always leave the porthole door ajar in order to prevent unpleasant odours from forming.

## Cleaning the pump

The washing machine is fitted with a self-cleaning pump which does not require any maintenance. Sometimes, small items (such as coins or buttons) may fall into the pre-chamber which protects the pump, situated in its bottom part.

! Make sure the wash cycle has finished and unplug the appliance.

To access the pre-chamber:

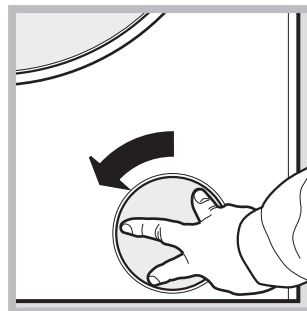

1. remove the protective casing on the lower part of the washing machine, turning it in an **anticlockwise direction** (see *figure*);

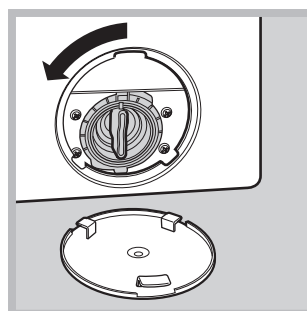

2. unscrew the lid by rotating it anti-clockwise (see *figure*): a little water may trickle out. This is perfectly normal;

3. clean the inside thoroughly;
4. screw the lid back on;
5. screw the protective cap back on by turning it in a **clockwise direction**, making sure the arrow on the inside part of the cap is facing upwards.

## Checking the water inlet hose

Check the inlet hose at least once a year. If there are any cracks, it should be replaced immediately: during the wash cycles, water pressure is very strong and a cracked hose could easily split open.

! Never use second-hand hoses.

Your washing machine could occasionally fail to work. Before contacting the Technical Assistance Centre (see "Service"), make sure that the problem is not easily solved using the following list.

GB

## Problem:

## Possible causes / Solutions:

**The washing machine does not switch on.**

- The appliance is not plugged into the socket fully, or is not making contact.
- There is no power in the house.

**The wash cycle won't start.**

- The washing machine door is not closed properly.
- The ON/OFF button has not been pressed.
- The START PROGRAMME buttons have not been pressed (they are still flashing).
- The water tap has not been opened.

**The washing machine does not fill with water (the DOOR LOCKED indicator light flashes rapidly).**

- The water inlet hose is not connected to the tap.
- The hose is bent.
- The water tap has not been opened.
- There is no water supply in the house.
- The pressure is too low.
- The START PROGRAMME buttons have not been pressed (they are still flashing).

**The machine continuously fills with water and drains.**

- The drain hose is not fitted at a height between 65 and 100 cm from the floor ( see "Installation").
- The free end of the hose is under water (see "Installation").
- The wall drainage system is not fitted with a breather pipe.

If the problem persists even after these checks, shut off the water tap, switch the appliance off and contact the Technical Assistance Service. If the dwelling is on one of the upper floors of a building, there may be problems relating to water drainage, causing the washing machine to fill with water and drain continuously. Special anti-draining valves are available in shops and help to avoid this inconvenience.

**The washing machine does not drain or spin.**

- The drain hose is bent (see "Installation").
- The drainage duct is clogged.

**The machine vibrates a lot during the spin cycle.**

- The protective screws (used during transportation) were not removed when the appliance was installed. Remove the screws (see "Installation").
- The machine is not level (see "Installation").
- The machine is trapped between cabinets and walls (see "Installation").

**The washing machine leaks.**

- The water inlet hose is not screwed on properly (see "Installation").
- The detergent dispenser is blocked (to clean it, see "Care and maintenance").
- The drain hose is not fixed in place properly (see "Installation").
- The drip-tray system is full. Clean the sponge or replace it (see "Precautions and advice").

**The DOOR LOCKED indicator light flashes rapidly.**

- Switch off the machine and unplug it, wait for approximately 1 minute and then switch it back on again. The wash cycle will have to be started again from the beginning. If the problem persists, contact the Technical Assistance Service.

**Too much foam.**

- The detergent is not suitable for machine washing (it should bear the description "for washing machines" or "hand and machine wash", or similar instructions).
- Too much detergent was used.

# Service

---

GB

## **Before calling for Assistance:**

- Check whether you can solve the problem alone (see *"Troubleshooting"*);
- Restart the programme to check whether the problem has been solved;
- If it has not, contact the Authorised Technical Assistance Service.

! If the machine has been installed or used incorrectly, you may be charged for the maintenance callout service.

! Always request the assistance of authorised technicians.

## **Have the following information to hand:**

- the type of problem;
- the appliance model (Mod.);
- the serial number (S/N).

The above information can be found on the data plate located on the appliance itself.

## 12 Months Parts and Labour Guarantee

Your appliance has the benefit of our manufacturer's guarantee, which covers the cost of breakdown repairs for twelve months from the date of purchase.

This gives you the reassurance that if, within that time, your appliance is proven to be defective because of either workmanship or materials, we will, at our discretion, either repair or replace the appliance at no cost to you.

This guarantee is subject to the following conditions:

- The appliance has been installed and operated correctly and in accordance with our operating and maintenance instructions.
- The appliance is used only on the electricity or gas supply printed on the rating plate.
- The appliance has been used for normal domestic purposes only.
- The appliance has not been altered, serviced, maintained, dismantled, or otherwise interfered with by any person not authorised by us.
- Any repair work must be undertaken by us or our appointed agent.
- Any parts removed during repair work or any appliance that is replaced become our property.
- The appliance is used in the United Kingdom or Republic of Ireland.

The guarantee does not cover:

- Damage resulting from transportation, improper use, neglect or interference or as a result of improper installation.
- Replacement of any consumable item or accessory . These include but are not limited to: plugs, cables, batteries, light bulbs, fluorescent tubes and starters, covers and filters.
- Replacement of any removable parts made of glass or plastic.

THIS GUARANTEE WILL NOT APPLY IF THE APPLIANCE HAS BEEN USED IN COMMERCIAL OR NON-DOMESTIC PREMISES.

## 5 Year Parts Guarantee

Indesit also offers you a free 5 year parts guarantee. This additional guarantee is conditional on you registering your appliance with us and the parts being fitted by one of our authorised engineers. There will be a charge for our engineer's time. To activate the extra parts warranty on your appliance, simply call our registration line on **08448 24 24 24 (Republic of Ireland 01 230 0800)**.

## Extended Guarantees

We offer a selection of repair protection plans that enable you to fully cover yourself against the expense of repair bills for the life of your policy. To find the ideal plan for you please call our advice line on **08448 226 226 (Republic of Ireland 01 230 0233)**.

## Free Helpdesk Service

We have a dedicated team who can provide free advice and assistance with your appliance if you experience any technical difficulties within the first 90 days of ownership. Simply call our Indesit Service Hotline on **08448 224 224 (Republic of Ireland 0818 313 413)** for telephone assistance, or, where necessary, to arrange for an engineer to call.

## After Sales Service

No one is better placed to care for your Indesit appliance during the course of its working life than us - the manufacturer.

### Essential Contact Information

#### Indesit Service

We are the largest service team in Europe offering you access to 400 skilled telephone advisors and 1100 fully qualified engineers on call to ensure you receive fast, reliable, local service.

**UK: 08448 224 224**  
**Republic of Ireland: 0818 313 413**  
**[www.indesitservice.co.uk](http://www.indesitservice.co.uk)**

**Please note: Our advisors will require the following information:**

**Model number:**

**Serial number:**

#### Parts and Accessories

We supply a full range of genuine replacement parts as well as accessory products that protect and hygienically clean your appliance to keep it looking good and functioning efficiently throughout its life.

**UK: 08448 225 225**  
**Republic of Ireland: 0818 313 413**  
**[www.indesitservice.co.uk](http://www.indesitservice.co.uk)**

#### Appliance Registration

We want to give you additional benefits of Indesit ownership. To activate your free 5 year parts guarantee you must register your appliance with us.

**UK: 08448 24 24 24**  
**Republic of Ireland: 01 230 0800**  
**[www.indesitservice.co.uk](http://www.indesitservice.co.uk)**

**Indesit Company UK Ltd. Morley Way, Peterborough, PE2 9JB**  
Indesit Company Unit 49 Airways Industrial Estate, Dublin 17



### Recycling & Disposal Information

As part of Indesit's continued commitment to helping the environment, Indesit reserves the right to use quality, recycled components to keep down customer costs and minimise material wastage.

Please dispose of packaging and old appliances carefully. To minimise the risk of injury to children, remove the door, plug and cut the mains cable off flush with the appliance. Dispose of these parts separately to ensure that the appliance can no longer be plugged into a mains socket, and the door cannot be locked shut.



## Free Manuals Download Website

<http://myh66.com>

<http://usermanuals.us>

<http://www.somanuals.com>

<http://www.4manuals.cc>

<http://www.manual-lib.com>

<http://www.404manual.com>

<http://www.luxmanual.com>

<http://aubethermostatmanual.com>

Golf course search by state

<http://golfingnear.com>

Email search by domain

<http://emailbydomain.com>

Auto manuals search

<http://auto.somanuals.com>

TV manuals search

<http://tv.somanuals.com>