

# Instructions for use

## WASHING MACHINE

**GB**

**English, 1**

**WI 101**

**GB**

### **Contents**

#### **Installation, 2-3-4-5**

Unpacking and levelling, 2  
Electric and water connections, 2-3  
The first wash cycle, 4  
Technical details, 5

#### **Washing machine description, 6-7**

Control panel, 6  
Leds, 7

#### **Starting and Programmes, 8**

Briefly: how to start a programme, 8  
Programme table, 8

#### **Personalisations, 9**

Setting the temperature, 9  
Functions, 9

#### **Detergents and laundry, 10**

Detergent dispenser, 10  
Preparing your laundry, 10  
Special items, 10

#### **Precautions and advice, 11**

General safety, 11  
Disposal, 11  
Saving energy and respecting the environment, 11

#### **Care and maintenance, 12**

Cutting off the water or electricity supply, 12  
Cleaning your appliance, 12  
Cleaning the detergent dispenser, 12  
Caring for your appliance door and drum, 12  
Cleaning the pump, 12  
Checking the water inlet hose, 12

#### **Troubleshooting, 13**

#### **Service, 14**

Before calling for Assistance, 14

 **INDESIT**

# Installation

GB

! Keep this instruction manual in a safe place for future reference. Should the appliance be sold, transferred or moved, make sure the instruction manual accompanies the washing machine to inform the new owner as to its operation and features.

! Read these instructions carefully: they contain vital information on installation, use and safety.

## Unpacking and levelling

### Unpacking

1. Unpack the washing machine.
2. Check whether the washing machine has been damaged during transport. If this is the case, do not install it and contact your retailer.

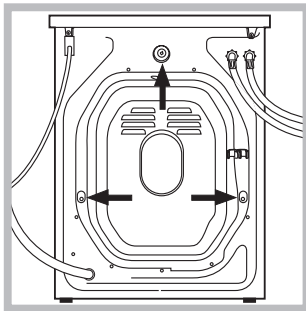

3. Remove the 3 protective screws and the rubber bush with the respective spacer, situated on the rear of the appliance (see also the installation leaflet). **NB:** The plastic spacers may fall down inside the machine once the bolt

has been removed, and will not interfere with the operation of the machine.

4. Seal the gaps using the plastic plugs provided.
5. Keep all the parts: you will need them again if the washing machine needs to be moved to another location.

! Packaging materials are not children's toys.

### Levelling

1. Install the washing machine on a flat sturdy floor, without resting it up against walls, furniture cabinets or other.

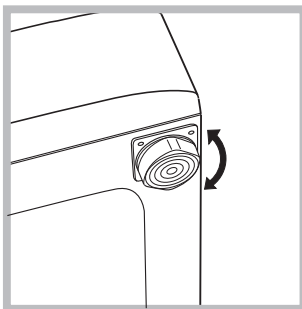

2. If the floor is not perfectly level, compensate for any unevenness by tightening or loosening the adjustable front feet (see figure); the angle of inclination, measured according to the worktop, must not exceed 2°.

Levelling your appliance correctly will provide it with stability and avoid any vibrations, noise and shifting during operation. If it is placed on a fitted or loose carpet, adjust the feet in such a way as to allow enough room for ventilation beneath the washing machine.

## Electric and water connections

### Connecting the water inlet hose

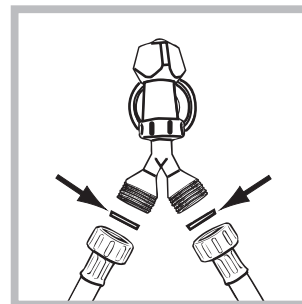

1. Connect the supply pipe to the water mains, fitting the rubber gasket and the filter supplied with the appliance and ensuring that they are firmly tightened to the taps.

The water supply marked **C** must be connected to

the cold water tap; the pipe marked **H** must be connected to the hot water tap. Both pipes may be connected to the cold water tap using the special **Y** connection with multiple attachments, supplied with the appliance (see figure).

Before making the connection, allow the water to run freely until it is perfectly clear.

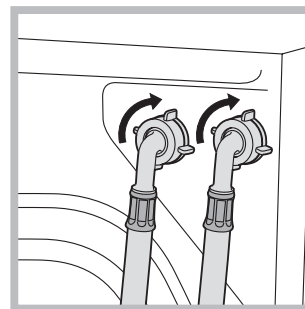

2. Connect the other end of the water inlet hose to the washing machine, screwing it onto the appliance's cold water inlet, situated on the top right-hand side on the rear of the appliance (see figure).

3. Make sure there are no kinks or bends in the hose.

! The water pressure at the tap must be within the values indicated in the Technical details table (on the next page).

! If the water inlet hose is not long enough, contact a specialist store or an authorised serviceman.

! Ensure that the supply taps are allowing water through. Old taps may seize in the closed position and thus prevent water reaching the machine.

### Connecting the drain hose

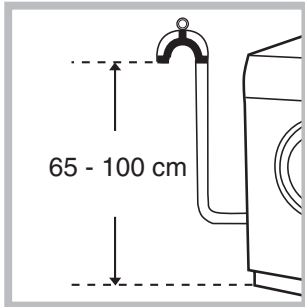

Connect the drain hose, without bending it, to a draining duct or a wall drain situated between 65 and 100 cm from the floor;

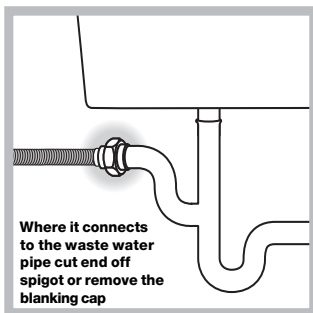

The drain hose may be connected to an under-sink trap. Before connecting the drain hose from the machine ensure that any blanks or removable ends have been taken off the spigot.

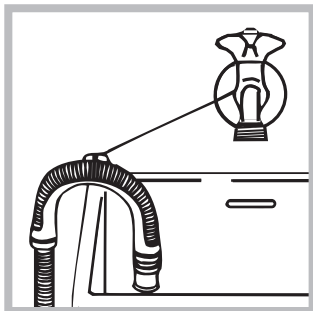

If it is place over the edge of a basin or sink be sure the free end of the hose should not be underwater.

**!** We advise against the use of hose extensions; in case of absolute need, the extension must have the same diameter as the original hose and must not exceed 150 cm in length.

Ensure that if the drain hose is pushed into a standpipe, that the end does not go down more than 15cms (6 inches). If the hose is pushed down too far, this may cause the machine to self-siphon ie. continuously empty as it is filling.

### Electric connection

Before plugging the appliance into the mains socket, make sure that:

- the socket is earthed and in compliance with the applicable law;
- the socket is able to sustain the appliance's maximum power load indicated in the Technical details table (see page 5);

- the supply voltage is included within the values indicated on the Technical details table (see page 5);

- the socket is compatible with the washing machine's plug. If this is not the case, replace the socket or the plug.

Your appliance is now supplied with a 13 amp fused plug it can be plugged into a 13 amp socket for immediate use. Before using the appliance please read the instructions below.

**WARNING - THIS APPLIANCE MUST BE EARTHED. THE FOLLOWING OPERATIONS SHOULD BE CARRIED OUT BY A QUALIFIED ELECTRICIAN.**

#### Replacing the fuse:

When replacing a faulty fuse, a 13 amp ASTA approved fuse to BS 1362 should always be used, and the fuse cover re-fitted. If the fuse cover is lost, the plug must not be used until a replacement is obtained.

#### Replacement fuse covers:

If a replacement fuse cover is fitted, it must be of the correct colour as indicated by the coloured marking or the colour that is embossed in words on the base of the plug. Replacements can be obtained directly from your nearest Service Depot.

#### Removing the plug:

If your appliance has a non-rewireable moulded plug and you should wish to re-route the mains cable through partitions, units etc., please ensure that either:

the plug is replaced by a fused 13 ampere re-wearable plug bearing the BSI mark of approval. or:

the mains cable is wired directly into a 13 amp cable outlet, controlled by a switch, (in compliance with BS 5733) which is accessible without moving the appliance.

#### Disposing of the plug:

Ensure that before disposing of the plug itself, you make the pins unusable so that it cannot be accidentally inserted into a socket.

Instructions for connecting cable to an alternative plug: Important: the wires in the mains lead are coloured in accordance with the following code:

<b>Green &amp; Yellow</b>	<b>Earth</b>
<b>Blue</b>	<b>Neutral</b>
<b>Brown</b>	<b>Live</b>

GB

Installation

Description

Programmes

Detergents

Precautions

Care

Troubleshooting

Service

As the colours of the wires in the lead may not correspond with the coloured markings identifying the terminals in your plug, proceed as follows:  
 Connect Green & Yellow wire to terminal marked **E** or  $\perp$  or coloured Green or Green & Yellow.  
 Connect Brown wire to terminal marked **L** or coloured Red.  
 Connect Blue wire to terminal marked **N** or coloured Black.

If a 13 amp plug (BS 1363) is used it must be fitted with a 13 amp fuse, either in the plug or adaptor or at the distribution board.

If you are in any doubt the electrical supply to your machine, consult a qualified electrician before use.

How to connect an alternative plug:

The wires in this mains lead are coloured in accordance with the following code:

<b>BLUE</b>	<b>NEUTRAL (N)</b>
<b>BROWN</b>	<b>LIVE (L)</b>
<b>GREEN &amp; YELLOW</b>	<b>EARTH (E)</b>

#### *Disposing of the appliance:*

When disposing of the appliance please remove the plug by cutting the mains cable as close as possible to the plug body and dispose of it as described above.

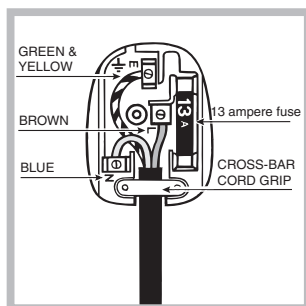

! The washing machine should not be installed in an outdoor environment, not even when the area is sheltered, because it may be very dangerous to leave it exposed to rain and thunderstorms.

! When the washing machine is installed, the mains socket must be within easy reach.

! Do not use extensions or multiple sockets.



! The power supply cable must never be bent or dangerously compressed.

! The power supply cable must only be replaced by an authorised serviceman.

Warning! The company denies all liability if and when these norms are not respected.

## **The first wash cycle**

Once the appliance has been installed, and before you use it for the first time, run a wash cycle with detergent and no laundry, setting the 90°C programme without a pre-wash cycle.

Technical details	
<b>Model</b>	WI 101
<b>Dimensions</b>	59.5 cm wide 85 cm high 52.5 cm deep
<b>Capacity</b>	from 1 to 5 kg
<b>Electric connections</b>	voltage 230/240 Volts 50 Hz maximum absorbed power 2050 W
<b>Water connections</b>	maximum pressure 1 MPa (10 bar) minimum pressure 0.05 MPa (0.5 bar) drum capacity 46 litres
<b>Spin speed</b>	up to 1000 rpm
<b>Control programmes according to IEC456 directive</b>	programme 3; temperature 60°C; run with a load of 5 kg.
 	<p>This appliance is compliant with the following European Community Directives:</p> <ul style="list-style-type: none"> <li>- 73/23/CEE of 19/02/73 (Low Voltage) and subsequent amendments</li> <li>- 89/336/CEE of 03/05/89 (Electromagnetic Compatibility) and subsequent amendments</li> <li>- 2002/96/CE</li> </ul>

**GB**
**Installation**
**Description**
**Programmes**
**Detergents**
**Precautions**
**Care**
**Troubleshooting**
**Service**

# Washing machine description

GB

## Control panel

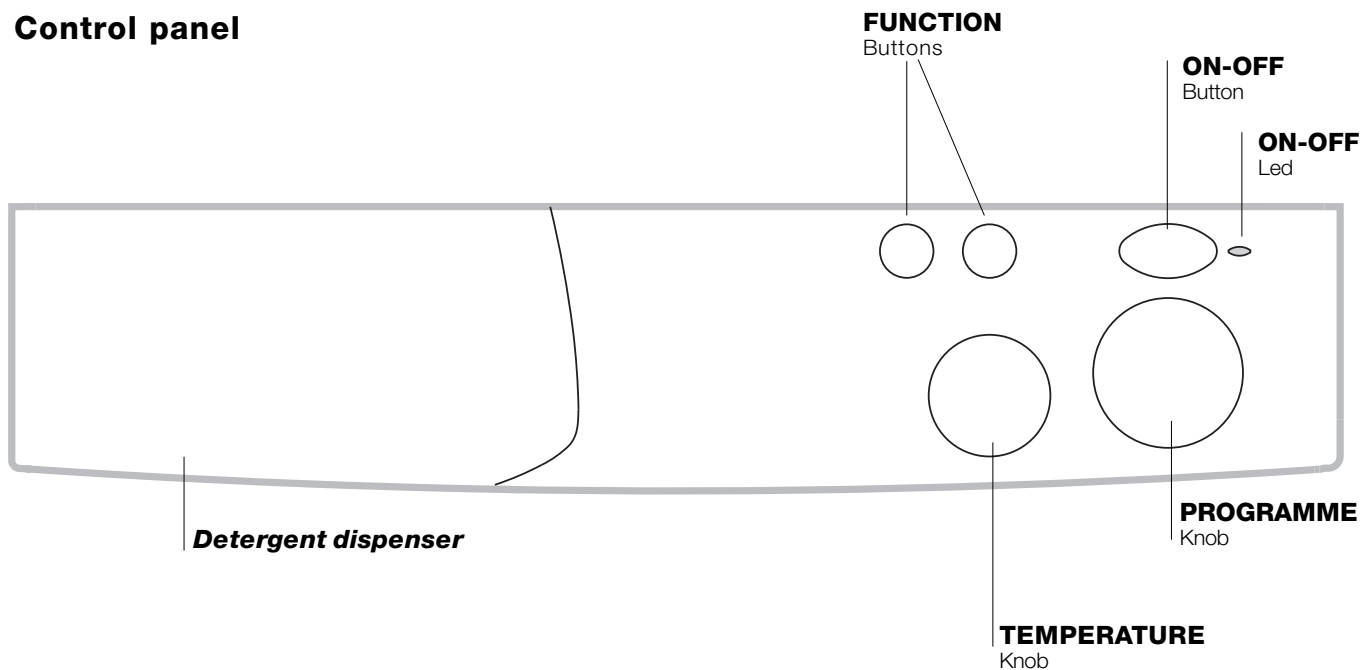

**Detergent dispenser:** to add detergent and fabric softener (see page 10).

**FUNCTION** buttons: to select the functions available.

**TEMPERATURE** knob: to set the temperature or the cold wash cycle (see page 9).

**ON/OFF** button, to turn the washing machine on and off.  
Turning the machine off does not cancel the selected programme.

**ON/OFF** led, to find out whether the washing machine is on and if the programme set has been accepted (see page 7).

**PROGRAMME** knob: to select the wash programmes.

*Note:* After the wash cycle has been set and accepted by the washing machine, any changes to the position of the knob will be of no use (except in the ■ Stop/Reset position).  
Turn this knob clockwise only.

## Leds

The LEDS provide important information.  
This is what they can tell you:

### ON-OFF Led

Led flashes when the appliance is switched on and awaiting a programme to be set. A steady light means the appliance has accepted the selected programme.

GB

Installation

Description

Programmes

Detergents

Precautions

Care

Troubleshooting

Service

# Starting and Programmes

GB

## Briefly: starting a programme











1. Set the desired programme.
2. Set the wash temperature (see page 9).
3. Load your laundry into the appliance and shut the door.
4. Add the detergent and any fabric softener (see page 10).
5. Turn the appliance on by pressing button . The ON/OFF led begins to flash, after 5 seconds, the setting is accepted, the led stops flashing (staying on) and the wash cycle begins.

6. To cancel the cycle set, select one of the symbols  (Stop/Reset) and wait 5 seconds: when the cancellation has been accepted, the ON/OFF led flashes, and you can turn the appliance off and set a new cycle.

*Note:* if you wish to set a programmed start, see page 5.

7. When the programme is completed, the DOOR LOCK led will turn off to indicate that the appliance door can be opened. Turn the washing machine off by pressing button . Take out your laundry and leave the appliance door ajar to allow the drum to dry thoroughly.

## Programme table

Type of fabric and degree of soil	Progr.	Temperature	Detergent		Fabric softener	Cycle length (minutes)	Max. Spin Speeds (r.p.m.)	Description of wash cycle
			pre-wash	wash				
<b>Cotton</b>								
Extremely soiled whites (sheets, tablecloths, etc.)	1	90°C	•	•	•	135	Max.	Pre-wash, wash cycle, rinse cycles, intermediate and final spin cycles
Extremely soiled whites (sheets, tablecloths, etc.)	2	90°C		•	•	125	Max.	Wash cycle, rinse cycles, intermediate and final spin cycles
Heavily soiled whites and fast colours	3	60°C		•	•	110	Max.	Wash cycle, rinse cycles, intermediate and final spin cycles
Heavily soiled whites and fast colours	4	40°C		•	•	140	Max.	Wash cycle, rinse cycles, intermediate and final spin cycles
Slightly soiled whites and delicate colours (shirts, jumpers, etc.)	5	40°C		•	•	70	Max.	Wash cycle, rinse cycles, intermediate and final spin cycles
Rinse cycles					•		Max.	Rinse cycles, intermediate and final spin cycles
Spin cycle							Max.	Draining and final spin cycle
Stop/Reset							-	Interrupts/Cancel the selected programme
<b>Synthetics</b>								
Heavily soiled fast colour synthetics (baby linen, etc.)	6	60°C		•	•	75	800	Wash cycle, rinse cycles, anti-crease or delicate spin cycle
Heavily soiled fast colour synthetics (baby linen, etc.)	7	50°C		•	•	70	800	Wash cycle, rinse cycles, anti-crease or delicate spin cycle
Delicate colour synthetics (all types of slightly soiled garments)	8	40°C		•	•	60	800	Wash cycle, rinse cycles, anti-crease or delicate spin cycle
Delicate colour synthetics (all types of slightly soiled garments)	9	30°C		•	•	30	800	Wash cycle, rinse cycles and delicate spin cycle
Rinse cycles					•		800	Rinse cycles, anti-crease or delicate spin cycle
Fabric Softener					•		800	Rinse cycles with automatic introduction of softener, anti-crease or delicate spin cycle
Spin cycle							800	Draining and delicate spin cycle
Stop/Reset							-	Interrupts/Cancel the selected programme
<b>Delicates</b>								
Wool (Hand wash)	10	40°C		•	•	50	600	Wash cycle, rinse cycles, anti-crease and delicate spin cycle
Particularly delicate garments and fabrics (curtains, silk, viscose, etc.)	11	30°C		•	•	45	no	Wash cycle, rinse cycles, anti-crease or draining
Rinse cycles					•		600	Rinse cycles, anti-crease or draining
Spin cycle							600	Draining and delicate spin cycle
Drain							no	Drain
Stop/Reset							-	Interrupts/Cancel the selected programme

## Notes

For the description of the Anti-crease function, please see page 9. The information contained in the table is purely indicative.

## Special programmes

*Daily wash* (programme 9 for Synthetics) is designed to wash lightly soiled garments in a short amount of time: it only lasts 30 minutes and allows you to save on both time and energy. By setting this programme (9 at 30°C), you can wash different fabrics together (except for woollen and silk items), with a maximum load of 3 kg. *We recommend the use of liquid detergent.*

*"A class at 40°"*, the washing machine has a special programme to allow you to obtain optimum results even at low temperatures. By setting programme 4 at a temperature of 40° C, the results you will obtain will be the same as you would normally obtain at 60°C thanks to the washing machine's action and the length of the wash cycle.







## Setting the temperature

Turn the TEMPERATURE knob to set the wash temperature (see Programme table on page 8).  
The temperature can be lowered, or even set to a cold wash (❄).

## Functions

To enable the functions, press the button corresponding to the desired function, according to the table below:

Function	Effect	Comments
 <b>Rapid wash</b>	Cuts the duration of the wash cycle by 30%.	
 <b>Anti crease</b>	This function allows you to interrupt a programme (on symbol  ) keeping the washing soaking in water before the spin cycle. It is a very useful button in particular because it can be used for delicates and synthetics. It is only to be used with wash programmes for synthetic fabrics, silk and curtains when it is impossible for you to take the washing out immediately.	<p>Before opening the washing machine door, finish the wash cycle as follows:</p> <p><i>Silk and curtains:</i> press button <b>Anticrease</b> and the washing machine will drain the water.  <i>Synthetic fabrics:</i> press button <b>Anticrease</b> if you want a spin cycle, or turn knob PROGRAMME to symbol  if you want the water to be drained.</p> <p><i>With "Daily wash" programme, this function is not enabled.</i></p>

! The machine has an intelligent built in check for out of balance loads. To let protect your machine it may reduce the final spin speed if an unbalanced load is detected.

GB

Installation

Description

Programmes

Detergents

Precautions

Care

Troubleshooting

Service

# Detergents and laundry

GB

## Detergent dispenser

Good washing results also depend on the correct dose of detergent: adding too much detergent won't necessarily make for a more efficient wash, and may in fact cause build up on the interior of your appliance and even pollute the environment.

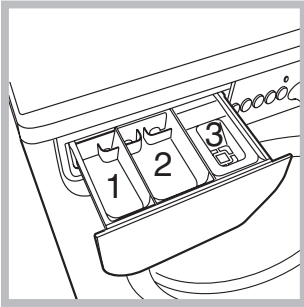

Open up the detergent dispenser and pour in the detergent and fabric softener, as follows.

**compartment 1: Detergent for pre-wash (powder)**

**compartment 2: Detergent for the wash cycle (powder or liquid)**

Liquid detergent should only be poured in immediately prior to the wash cycle start.

**compartment 3: Additives (fabric softeners, etc.)**

The fabric softener should not overflow from the grid.

**!** Do not use hand wash detergent because it may form too much foam.

## Preparing your laundry

- Divide your laundry according to:
  - the type of fabric/the symbol on the label.
  - the colours: separate coloured garments from whites.
- Empty all pockets and check for loose buttons.
- Do not exceed the weight limits stated below, which refer to the weight when dry:
  - Sturdy fabrics: max 5 kg
  - Synthetic fabrics: max 2.5 kg
  - Delicate fabrics: max 2 kg
  - Wool: max 1 kg

### How much does your laundry weigh?

- 1 sheet 400-500 g
- 1 pillow case 150-200 g
- 1 tablecloth 400-500 g
- 1 bathrobe 900-1,200 g
- 1 towel 150-250 g

## Special items

**Curtains:** fold curtains and place them in a pillow case or mesh bag. Wash them separately without exceeding half the appliance load. Use programme 11 which excludes the spin cycle automatically.

**Quilted coats and windbreakers:** if they are padded with goose or duck down, they can be machine-washed. Turn the garments inside out and load a maximum of 2-3 kg, repeating the rinse cycle once or twice and using the delicate spin cycle.

**Trainers:** remove any mud. They can be washed together with jeans and other tough garments, but not with whites.

**Wool:** for best results, use a specific detergent, taking care not to exceed a load of 1 kg.

! The washing machine was designed and built in compliance with the applicable international safety regulations. The following information is provided for your safety and should consequently be read carefully.

## General safety

- This appliance has been designed for non-professional, household use and its functions must not be changed.
- This washing machine should only be used by adults and in accordance with the instructions provided in this manual.
- Never touch the washing machine when barefoot or with wet or damp hands or feet.
- Do not pull on the power supply cable to unplug the appliance from the electricity socket. Pull the plug out yourself.
- Do not open the detergent dispenser while the appliance is in operation.
- Do not touch the drain water as it could reach very high temperatures.
- Never force the washing machine door: this could damage the safety lock mechanism designed to prevent any accidental openings.
- In the event of a malfunction, do not under any circumstances touch internal parts in order to attempt repairs.
- Always keep children well away from the appliance while in operation.
- The appliance door tends to get quite hot during the wash cycle.
- Should it have to be moved, proceed with the help of two or three people and handle it with the utmost care. Never try to do this alone, because the appliance is very heavy.
- Before loading your laundry into the washing machine, make sure the drum is empty.

## Disposal

- Disposing of the packaging material: observe local regulations, so the packaging can be re-used.
- The European Directive 2002/96/EC on Waste Electrical and Electronic Equipment, requires that old household electrical appliances must not be disposed of in the normal unsorted municipal waste stream. Old appliances must be collected separately in order to optimise the recovery and

recycling of the materials they contain and reduce the impact on human health and the environment. The crossed out "wheeled bin" symbol on the product reminds you of your obligation, that when you dispose of the appliance it must be separately collected.

Consumers should contact their local authority or retailer for information concerning the correct disposal of their old appliance.

## Saving energy and respecting the environment

### Environmentally-friendly technology

If you only see a little water through your appliance door, this is because thanks to the latest Ariston technology, your washing machine only needs less than half the amount of water to get the best results: an objective reached to respect the environment.

### Saving on detergent, water, energy and time

- To avoid wasting resources, the washing machine should be used with a full load. A full load instead of two half loads allows you to save up to 50% on energy.
- The pre-wash cycle is only necessary on extremely soiled garments. Avoiding it will save on detergent, time, water and between 5 and 15% energy.
- Treating stains with a stain remover or leaving them to soak before washing will cut down the need to wash them at high temperatures. A programme at 60°C instead of 90°C or one at 40°C instead of 60°C will save up to 50% on energy.
- Use the correct quantity of detergent depending on the water hardness, how soiled the garments are and the amount of laundry you have, to avoid wastage and to protect the environment: despite being biodegradable, detergents do contain ingredients that alter the natural balance of the environment. In addition, avoid using fabric softener as much as possible.
- If you use your washing machine from late in the afternoon until the early hours of the morning, you will help reduce the electricity board's peak load.
- If your laundry has to be dried in a tumble dryer, select a high spin speed. Having the least water possible in your laundry will save you time and energy in the drying process.

GB

Installation

Description

Programmes

Detergents

Precautions

Care

Troubleshooting

Service

# Care and maintenance

GB

## Cutting off the water or electricity supply

- Turn off the water tap after every wash. This will limit the wear of your appliance's water system and also prevent leaks.
- Unplug your appliance when cleaning it and during all maintenance operations.

## Cleaning your appliance

The exterior and rubber parts of your appliance can be cleaned with a soft cloth soaked in lukewarm soapy water. Do not use solvents or abrasives.

## Cleaning the detergent dispenser

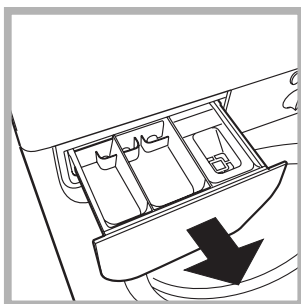

Remove the dispenser by pulling it out (see figure). Wash it under running water; this operation should be repeated frequently.

## Caring for your appliance door and drum

- Always leave the appliance door ajar to prevent unpleasant odours from forming.

## Cleaning the pump

The washing machine is fitted with a self-cleaning pump that does not require any maintenance. Sometimes, small items (such as coins or buttons) may fall into the pre-chamber that protects the pump, situated in the lower part of the same.

**!** Make sure the wash cycle has ended and unplug the appliance.

To access the pre-chamber:

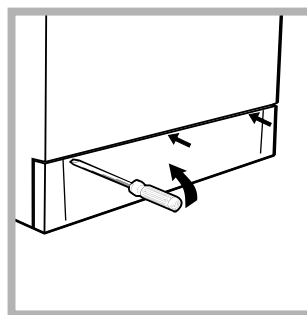

1. using a screwdriver, remove the cover panel on the lower front of the washing machine (see figure);

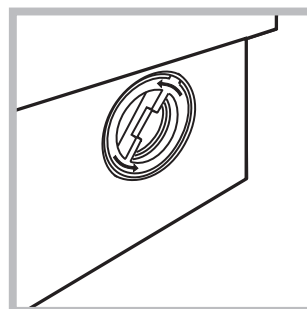

2. unscrew the lid rotating it anti-clockwise (see figure): a little water may trickle out. This is perfectly normal;

3. clean the interior thoroughly;
4. screw the lid back on;
5. reposition the panel, making sure the hooks are securely in place before you push it onto the appliance.

## Checking the water inlet hose

Check the water inlet hose at least once a year. If you see any cracks, replace it immediately: during the wash cycles, water pressure is very strong and a cracked hose could easily split open.

**!** Never use hoses that have already been used.

Your washing machine could fail to work. Before calling for Assistance (see page 14), make sure the problem can't easily be solved by consulting the following list.

## Problem

## Possible causes/Solution:

**The washing machine won't start.**

- The appliance is not plugged into the socket, or not enough to make contact.
- There has been a power failure.
- The appliance door is not shut properly.
- The (I) button has not been pressed.  
**NB:** It should be held minimum one second.
- The water tap is not turned on.

**The washing machine does not fill with water.**

- The water inlet hose is not connected to the tap.
- The hose is bent.
- The water tap is not turned on.
- There is a water shortage.
- The water pressure is insufficient.

**The machine continuously fills and empties with water.**

- The drain hose is too low or too far in to the stand pipe (see page 3) for correct installation.
- The wall drainage system doesn't have a standard pipe (min. 38 mm).

**The washing machine does not drain or spin.**

- Some programs have a slower final spin to take best care of the fabrics. See page 8 for details of the final spin speed for each program.
- The programme does not foresee the draining: some programmes require enabling the draining manually (see page 8).
- The Anticrease function is enabled (where available): This function requires enabling the draining manually.
- The drain hose is bent (see page 3).
- Remove the drain hose from the standpipe or under-sink trap and check for blockages, ensuring that the water can drain freely away from the machine.

**The washing machine vibrates too much during the spin cycle.**

- Check that the transit bolts were removed correctly during installation (carefully read pages 2 and 3).
- The washing machine is not level (see page 2).
- The washing machine is closed in between furniture cabinets and the wall (see page 2).

**The washing machine leaks.**

- The water inlet hose is not screwed on correctly (see page 2).
- The detergent dispenser is obstructed (to clean it, see page 12).
- The drain hose is not secured properly (see page 3).

**The programme selector knob keeps turning?**

- Wait a few minutes for the drain pump to empty the tub, switch the washer off, select one of the symbols stop/reset ■, then switch it back on. If the knob continues to turn, call for assistance because it is showing an anomaly.

**There is too much foam.**

- The detergent is not suitable for machine washing (it should bear the definition "for washing machines" or "hand and machine wash", or the like).
- You used too much detergent.

GB

Installation

Description

Programmes

Detergents

Precautions

Care

Troubleshooting

Service

# Service

---

GB

## **Before calling for Assistance:**

- Check whether you can solve the problem on your own (*see page 13*);
- Restart the programme to check whether the problem has been solved;
- If this is not the case, contact an authorised Technical Service Centre on the telephone number provided on the guarantee certificate.

! Always request the assistance of authorised servicemen.

## **Notify the operator of:**

- the type of problem;
- the appliance model (Mod.);
- the serial number (S/N).

This information can be found on the data plate situated on the rear of the washing machine.

**GB****Installation****Description****Programmes****Detergents****Precautions****Care****Troubleshooting****Service**





## Free Manuals Download Website

<http://myh66.com>

<http://usermanuals.us>

<http://www.somanuals.com>

<http://www.4manuals.cc>

<http://www.manual-lib.com>

<http://www.404manual.com>

<http://www.luxmanual.com>

<http://aubethermostatmanual.com>

Golf course search by state

<http://golfingnear.com>

Email search by domain

<http://emailbydomain.com>

Auto manuals search

<http://auto.somanuals.com>

TV manuals search

<http://tv.somanuals.com>