

60,000 R.P.M. PENCIL GRINDER

Models: 7978-()



WARNING

**READ THIS MANUAL CAREFULLY BEFORE INSTALLING,
OPERATING OR SERVICING THIS EQUIPMENT.**

FAILURE TO OBSERVE THE FOLLOWING WARNINGS COULD RESULT IN INJURY.

To aid the operator's understanding of proper and safe use of grinders, the publications, "Use, Care and Protection of Abrasive Wheels", A.N.S.I. B7.1, and "Safety Code for Portable Air Tools", A.N.S.I. B186.1, can be purchased from:

American National Standards Institute, Inc.
1430 Broadway
New York, New York 10018

WARNING

- Operate this tool at 90 p.s.i.g. (6.2 bar) maximum air pressure at the air inlet of the tool.
- Disconnect air supply from tool before removing/installing mounted wheel or performing other maintenance procedures.
- Keep hands, clothing and long hair away from rotating end of tool.
- Anticipate and be alert for sudden changes in motion during start up and operation of any power tool.
- Never exceed rated r.p.m. of tool.
- Wear suitable eye and hearing protection while operating tool.
- Tool shaft can continue to rotate briefly after throttle is released.
- Do not lubricate tools with flammable or volatile liquids such as kerosene, diesel or jet fuel.
- Use tool only for purposes for which it was intended.
- Never use mounted stone or carbide burr with speed rating lower than r.p.m. rating of tool.

- Do not use excessive work pressure.
- Allow only people who have received training in "proper grinder operation" to operate grinder.
- Do not remove any labels. Replace any damaged label.
- Use only accessories recommended by ARO.

WARNING

Repeated prolonged operator exposure to vibrations which may be generated in the use of certain hand-held tools may produce Raynaud's phenomenon, commonly referred to as Whitefinger disease. The phenomenon produces numbness and burning sensations in the hand and may cause circulation and nerve damage as well as tissue necrosis. Repetitive users of hand-held tools who experience vibrations should closely monitor duration of use and their physical condition.

NOTICE

- The use of other than genuine ARO replacement parts may result in safety hazards, decreased tool performance and increased maintenance and may invalidate all warranties.
- ARO is not responsible for customer modification of tools for applications on which ARO was not consulted.
- Tool maintenance and repair should be performed by authorized, trained, competent personnel. Consult your nearest ARO authorized servicer.
- It is the responsibility of the employer to place the information in this manual into the hands of the operator.

For parts and service information, contact your local ARO distributor, or the Customer Service Dept. of the Ingersoll-Rand Distribution Center, White House, TN at PH: (615) 672-0321, FAX: (615) 672-0801.

ARO Tool Products

Ingersoll-Rand Company

1725 U.S. No. 1 North • P.O. Box 8000 • Southern Pines, NC 28388-8000

©2000 INGERSOLL-RAND COMPANY • PRINTED IN U.S.A.

Download from www.Somanuals.com. All Manuals Search And Download.

FAILURE TO OBSERVE THE FOLLOWING WARNINGS COULD RESULT IN INJURY.

⚠ WARNING



Wear eye protection when operating or performing maintenance on this tool.

⚠ WARNING



Wear hearing protection when operating this tool.

⚠ WARNING



Turn off air supply and disconnect air supply hose before installing, removing or adjusting any accessory on this tool, or before performing any maintenance on this tool.

⚠ WARNING



Air powered tools can vibrate in use. Vibration, repetitive motions or uncomfortable positions may be harmful to your hands and arms. Stop using any tool if discomfort, tingling feeling or pain occurs. Seek medical advice before resuming use.

⚠ WARNING



Do not carry the tool by the hose.

⚠ WARNING



Do not use damaged, frayed or deteriorated air hoses and fittings.

⚠ WARNING



Do not overreach when operating this tool. Keep body stance balanced and firm.

⚠ WARNING

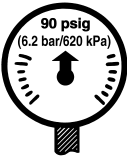

Operate at 90 p.s.i.g. (6.2 bar/620 kPa) maximum air pressure.

NOTICE

<p>⚠ WARNING</p> <p>Read the manual before operating this tool. Operate at 90 psig/6.2 bar max.</p>	
<p>PN 48176-1 LABEL (NON-EU MODELS)</p>	<p>PN 49883 LABEL (-EU MODELS)</p>

This label must appear on the tool at all times. If it is lost or damaged, a replacement label is available at no cost.

WARNING = Hazards or unsafe practices which could result in severe personal injury, death or substantial property damage.

CAUTION = Hazards or unsafe practices which could result in minor personal injury or product or property damage.

NOTICE = Important installation, operation or maintenance information.

ROUTINE LUBRICATION REQUIREMENTS

Lack of or an excessive amount of lubrication will affect the performance and life of this tool. Use only recommended lubricants at below time intervals:

EVERY 8 HOURS OF TOOL OPERATION – Fill lubricator reservoir of recommended F.R.L. with spindle oil (29665). If an in line or air line lubricator is not used, apply several drops of spindle oil (29665) in air inlet.

EVERY 40 HOURS OF TOOL OPERATION – Flush tool with a solution of three (3) parts cleaning solvent to one (1) part spindle oil.

AIR SUPPLY REQUIREMENTS



For maximum operating efficiency, the following air supply specifications should be maintained to this air tool:

- AIR PRESSURE – 90 p.s.i.g. (6.2 bar)
- AIR FILTRATION – 50 micron
- LUBRICATED AIR SUPPLY
- HOSE SIZE – 3/16" (5 mm) I.D.

An ARO® model 128121–800 air line FILTER/REGULATOR/LUBRICATOR (F.R.L.) is recommended to maintain the above air supply specifications.

RECOMMENDED LUBRICANTS

After disassembly is complete, all parts, except sealed or shielded bearings, should be washed with solvent. To relubricate parts, or for routine lubrication, use the following recommended lubricants:

 Where Used	 ARO Part #	Description
Air Motor	29665	1 qt Spindle Oil
"O" Rings	36460	4 oz. Stringy Lubricant
Bearings	33153	5 lb. "EP" - NLGI #1 Grease

MOUNTING INSTRUCTIONS

- Be sure collet is in good condition and properly secured to grinder spindle.
- Insert shaft of mounted wheel to the full depth of gripping jaws of collet. At least one-half of shaft length shall be inserted into collet jaws.
- Be sure mounted stone or carbide bur is compatible with the speed of the grinder.

CAPACITIES (MAXIMUM)

- Carbide Bur – 1/4"
- Mounted Stone – 1/4"

INSPECTION, MAINTENANCE AND INSTALLATION

Disconnect air supply from the tool or shut off air supply and exhaust (drain) line of compressed air before performing maintenance or service to the tool.

It is important that the tools be serviced and inspected at regular intervals for maintaining safe, trouble-free operation of the tool.

Be sure the tool is receiving adequate lubrication, as failure to lubricate can create hazardous operating conditions resulting from excessive wear.

Be sure that the air supply lines and connectors are of proper size to provide a sufficient quantity of air to the tool.

Tool maintenance and repair shall be performed by authorized, trained, competent personnel. Tools, hose and fittings shall be replaced if unsuitable for safe operation and responsibility should be assigned to be sure that all tools requiring guards or other safety devices shall be kept in legible condition. Maintenance and repair records should be maintained on all tools. Frequency of repair and the nature of the repairs can reveal unsafe application. Scheduled maintenance by competent authorized personnel should detect any mistreatment or abuse of the tool and worn parts. Corrective action should be taken before returning the tool for use.

Disassembly should be done on a clean work bench with a clean cloth spread to prevent the loss of small parts. After disassembly is completed, all parts should be thoroughly washed in a clean solvent, blown dry with air and inspected for wear levels, abuse and contamination. Double sealed or shielded bearings should never be placed in solvent unless a good method of re-lubricating the bearing is available. Open bearings may be washed but should not be allowed to spin while being blown dry.

Upon reassembling, lubricate parts where required. Use 33153 grease, or equivalent, in bearings. Use 36460 lubricant for "O" ring assembly. When assembling "O" rings or parts adjacent "O" rings, care must be exercised to prevent damage to the rubber sealing surfaces. A small amount of grease will usually hold steel balls and other small parts in place while assembling.

When replacement parts are necessary, consult drawing containing the part for identification.

Always use clean, dry air. Dust, corrosive fumes and/or excessive moisture can damage the motor of an air tool. An air line filter can greatly increase the life of an air tool. The filter removes rust, scale, moisture and other debris from the air lines. Low air pressure (less than 90 p.s.i.g.) reduces the speed of the air tool. High air pressure (more than 90 p.s.i.g.) raises performance beyond the rated capacity of the tool and could cause injury. Shown below is a typical piping arrangement.

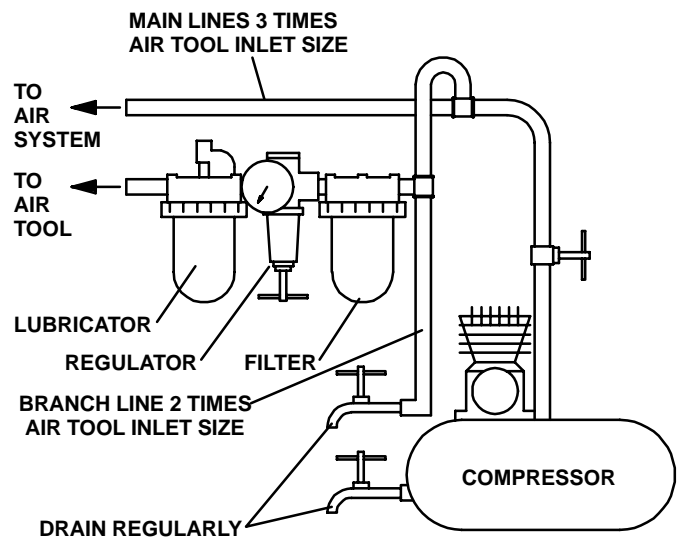

MODEL IDENTIFICATION

MODEL NUMBER	HOUSING	MOTOR ASSEMBLY	COLLET ASSEMBLY	COLLET CAPACITY
7978	46114	46112	46119-2	1/8"
7978-1	46114	46112-1	46119-3	3 mm
7978-2	46114	46112-2	46119-1	3/32"
7978-EU	49914	46112-1	46119-3	3 mm

MODELS WITH -EU SUFFIX ARE "EC" COMPLIANT MODELS.

DISASSEMBLY/ASSEMBLY INSTRUCTIONS

Disconnect air supply from tool or shut off air supply and drain line of compressed air before performing maintenance or service to tool.

Before starting to disassemble or assemble this tool (any part or completely), be sure to read "Inspection, Maintenance and Installation" section.

To minimize the possibility of parts damage and for convenience, the steps for disassembly or assembly listed on the following pages are recommended.

The basic sections and instructions for removing them from the

tool are as follows:

THROTTLE SECTION

Remove hose assembly from tool. Using 11/16" diameter blocks, clamp housing (46114 or 49914) in a vise (see grip area below) and unthread throttle section from housing. NOTE: Thread adhesive has been applied to these threads.

MOTOR SECTION

After removal of throttle section, motor assembly can be removed from the housing.

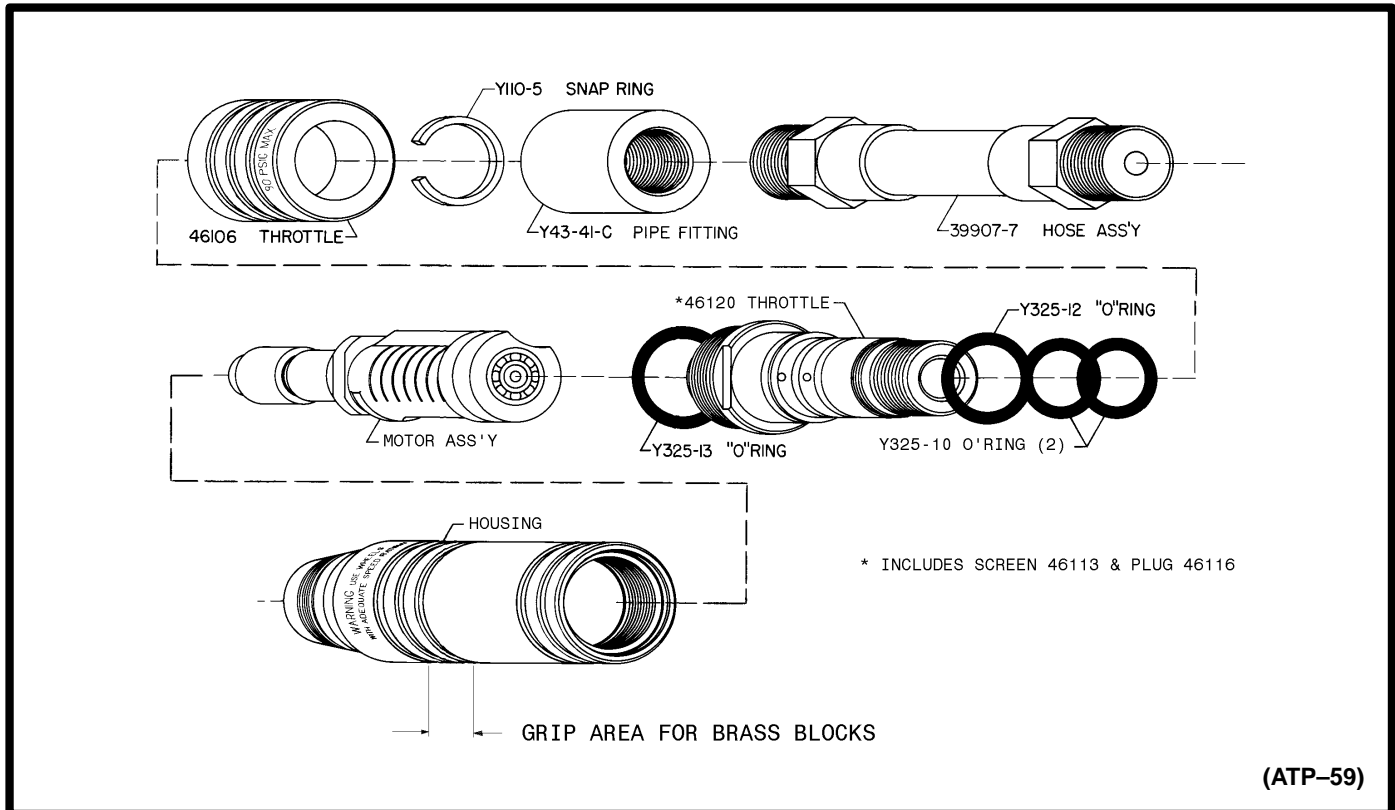

THROTTLE SECTION

DISASSEMBLY

- Remove throttle as outlined above.
- Remove pipe fitting (Y43-41-C) from throttle.
- Remove snap ring (Y110-5).
- Remove sleeve (46106) for access to two "O" rings (Y325-10) and "O" ring (Y325-12).

ASSEMBLY

- NOTE: Throttle contains an internal filter screen. Wash throttle thoroughly in clean solvent and blow air backward thru throttle

to clean screen. Whenever a part containing "O" rings has been removed from the tool, it is recommended the "O" rings be replaced with new ones before assembling the part to the tool. Lubricate all "O" rings with ARO 36460 lubricant at assembly.

- Assemble two "O" rings (Y325-10) and "O" ring (Y325-12) to throttle.
- Assemble "O" ring (Y325-13) to throttle.
- Slide sleeve (46106) onto throttle and secure with snap ring (Y110-5).
- Assemble pipe fitting (Y43-41-C) to end of throttle.

MOTOR SECTION

M10
15

DISASSEMBLY

- Remove motor assembly as outlined on page 4.
- Grasp cylinder in one hand and, with the same hand, hold a punch against the rear of the rotor. Tap punch to remove bearing (46110) and end plate (46107) from rotor. Remove cylinder and blades from rotor.
- Using brass blocks (1/4" diameter) in a vise; clamp on rotor and remove collet body, bearing, end plate and spacer from rotor.

ASSEMBLY

- Pack bearing (46109) with ARO 33153 grease and assemble to end plate (46108), with shielded side out.

- Assemble end plate (46108), with spacer (46103), to rotor. Using brass blocks in a vise, as for disassembly, clamp on rotor and assemble collet body to rotor (apply thread adhesive to threads) and tighten to 20 – 25 in. lbs torque.
- Coat i.d. of cylinder with spindle oil and assemble to rotor. Assemble blades to rotor.
- Pack bearing (46110) with ARO 33153 grease and assemble to end plate (46107).
- Assemble end plate to rotor. Push rotor to rear and press inner race of bearing (46110) to remove axial play.
- Be sure rotor does not bind. If rotor binds, tap rear of rotor lightly with punch as for motor disassembly.
- Assemble motor assembly to housing and assemble throttle to housing using thread adhesive on threads and tighten securely.

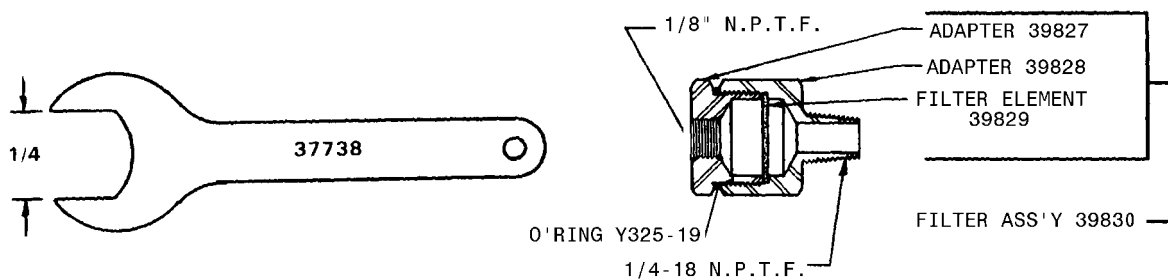
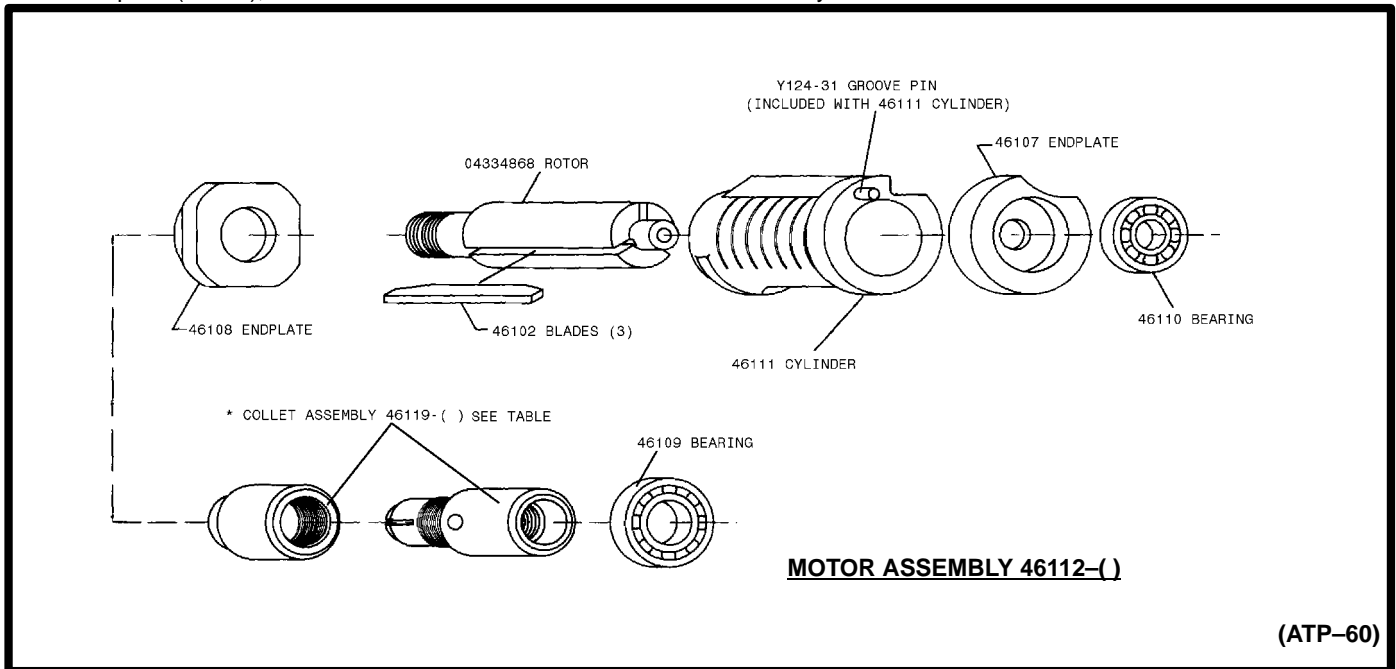

37738 WRENCH (FURNISHED WITH TOOL)

OPTIONAL FILTER ASSEMBLY (1/4")

(ATP-56)

TYPICAL CROSS SECTION OF TOOL

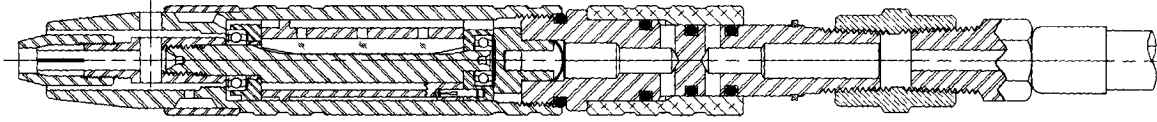

(ATP-57)

DIMENSIONAL DATA

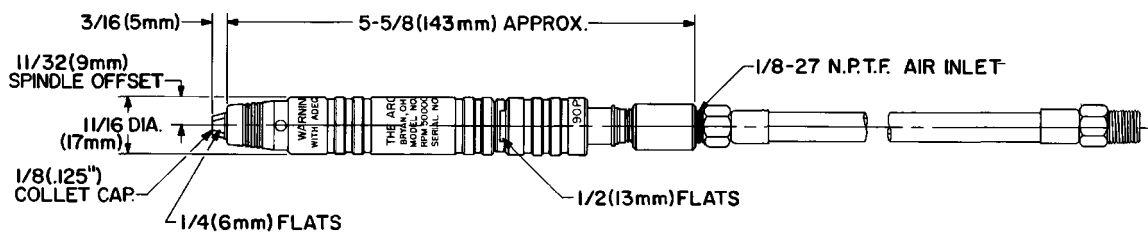

(ATP-58)

PN 49999-247
04607560

Free Manuals Download Website

<http://myh66.com>

<http://usermanuals.us>

<http://www.somanuals.com>

<http://www.4manuals.cc>

<http://www.manual-lib.com>

<http://www.404manual.com>

<http://www.luxmanual.com>

<http://aubethermostatmanual.com>

Golf course search by state

<http://golfingnear.com>

Email search by domain

<http://emailbydomain.com>

Auto manuals search

<http://auto.somanuals.com>

TV manuals search

<http://tv.somanuals.com>