

# User Guide



Blu-Ray Disc Player

**NS-BRDVD3**



## Contents

---

Important safety instructions .....	1
Introduction .....	2
Features .....	2
Package contents .....	2
Front .....	2
Back .....	2
Remote control .....	3
Setting up your player .....	4
Installing remote control batteries .....	4
Connecting a TV using an HDMI cable (best) .....	4
Connecting a TV using a component video cable (better) .....	5
Connecting a TV using an A/V cable (good) .....	6
Connecting a USB flash drive .....	6
Connecting to the Internet .....	6
Using your player .....	6
Playable discs .....	6
About Blu-ray Discs .....	6
Playing a Blu-ray Disc or DVD .....	7
Controlling Blu-ray Disc or DVD playback .....	7
Playing files on a data disc or USB memory stick .....	7
Playing an audio CD .....	8
Controlling audio CD playback .....	8
Displaying Blu-ray Disc information .....	9
Searching for a title, chapter, or elapsed time .....	9
Repeating a title, chapter, or CD track .....	9
Creating a playback loop on a DVD or audio CD .....	9
Viewing photographs .....	9
Using PIP (picture-in-picture) mode .....	10
Using a disc popup menu .....	10
Selecting the audio mode .....	10
Selecting a viewing angle .....	10
Selecting the on-screen menu language .....	10
Selecting the disc menu language .....	10
Selecting the audio language .....	11
Selecting the subtitle language .....	11
Determining whether an HDMI TV is connected .....	11
Automatically determining the best HDMI resolution .....	11
Selecting the video output resolution .....	12
Selecting the TV aspect ratio .....	12
Turning film mode on or off .....	12
Selecting the PCM downsampling rate .....	13
Selecting the digital audio output mode .....	13
Turning dynamic range control on or off .....	13
Setting the parental control password .....	14
Turning parental controls on or off .....	14
Selecting the parental control country .....	14
Setting the parental control level .....	14
Setting automatic disc playback mode .....	15

- Setting the BD-Live Internet access level ..... 15
- Viewing available BD-Live storage space ..... 15
- Erasing BD-Live storage ..... 15
- Setting the screen saver activation time ..... 16
- Resetting settings to the factory defaults ..... 16
- Downloading player update software ..... 16
- Determining if the network connection is active ..... 16
- Configuring the Internet connection ..... 17
- Maintaining ..... 17**
  - General guidelines ..... 17
  - Electrical disturbance ..... 17
  - Condensation ..... 17
  - Storing discs ..... 17
  - Handling discs ..... 18
  - Cleaning discs ..... 18
- FAQ (frequently asked questions) ..... 18**
- Troubleshooting ..... 18**
  - Resetting your player ..... 18
  - Power ..... 18
  - Operation ..... 19
  - TV screen and video ..... 19
  - HDMI connections ..... 20
  - BD-Live and USB connections ..... 20
  - Other playback problems ..... 20
- Specifications ..... 21**
  - System and outputs ..... 21
  - General ..... 21
  - Video file requirement (USB/DISC) ..... 21
  - MP3/WMA audio file requirement (USB/DISC) ..... 21
  - Photo file requirement (USB/DISC) ..... 21
- Legal notices ..... 21**
- One-year limited warranty ..... 23**





**CAUTION**  
**RISK OF ELECTRIC SHOCK**  
**DO NOT OPEN**



The lightning flash with arrowhead symbol within an equilateral triangle is intended to alert you to the presence of uninsulated dangerous voltage within your player's enclosure that may be of sufficient magnitude to constitute a risk of electric shock to persons.



The exclamation point within an equilateral triangle is intended to alert you to the presence of important operating and maintenance (servicing) instructions in the literature that came with your player.



This symbol is the symbol for CLASS II (Double Insulation).

### Warning

Your player employs a laser system. Use of controls, adjustments, or the performance of procedures other than those specified may result in hazardous radiation exposure.

Visible laser radiation is present when open and interlocks defeated. **Do not stare into the beam.**



### Disposal of your old appliance

1. When this crossed-out wheeled bin symbol is attached to a product, it means the product is covered by the European Directive 2002/96/EC.
2. All electrical and electronic products should be disposed of separately from the municipal waste stream via designated collection facilities appointed by the government or the local authorities.
3. The correct disposal of your old appliance will help prevent potential negative consequences for the environment and human health.
4. For more detailed information about disposal of your old appliance, please contact your city office, waste disposal service or the shop where you purchased the product.

## Important safety instructions

- 1 Read these instructions.
- 2 Keep these instructions.
- 3 Heed all warnings.
- 4 Follow all instructions.
- 5 Do not use this apparatus near water.
- 6 Clean only with a dry cloth.
- 7 Do not block any ventilation openings. Install in accordance with the manufacturer's instructions.
- 8 Do not install near any heat sources such as radiators, heat registers, stoves, or other apparatus (including amplifiers) that produce heat.

- 9 Do not defeat the safety purpose of the polarized or grounding-type plug. A polarized plug has two blades with one wider than the other. A grounding type plug has two blades and a third grounding prong. The wide blade or the third prong are provided for your safety. If the provided plug does not fit into your outlet, consult an electrician for replacement of the obsolete outlet.
- 10 Protect the power cord from being walked on or pinched particularly at plugs, convenience receptacles, and the point where they exit from the apparatus.
- 11 Only use attachments/accessories specified by the manufacturer.
- 12 Use only with the cart, stand, tripod, bracket, or table specified by the manufacturer, or sold with the apparatus. When a cart is used, use caution when moving the cart/apparatus combination to avoid injury from tip-over. 
- 13 Unplug this apparatus during lightning storms or when unused for long periods of time.
- 14 Refer all servicing to qualified service personnel. Servicing is required when the apparatus has been damaged in any way, such as power-supply cord or plug is damaged, liquid has been spilled or objects have fallen into the apparatus, the apparatus has been exposed to rain or moisture, does not operate normally, or has been dropped.
- 15 To reduce the risk of fire or electric shock, do not expose this device to rain, moisture, dripping, or splashing, and no objects filled with liquids, such as vases, shall be placed on it.
- 16 An apparatus with a three-prong, grounding-type plug is a Class I apparatus, which needs to be grounded to prevent possible electric shock. Make sure that you connect this Class I device to a grounding-type, three-prong outlet.
- 17 The wall plug is the disconnecting device. The plug must remain readily operable.
- 18 Keep a minimum distance of 4 inches (10cm) around the apparatus for sufficient ventilation.
- 19 Do not install this equipment in a confined space such as book case or similar unit. The ventilation should not be impeded by covering the ventilation openings with items such as newspaper, table-cloths, or curtains.
- 20 Batteries should not be exposed to excessive heat such as sunshine, fire, or the like.

### Caution

Danger of explosion if battery is incorrectly replaced. Replace only with the same or equivalent type.

# Blu-Ray Disc Player

## Introduction

Congratulations on your purchase of a high-quality Insignia product. Your NS-BRDVD3 represents the state of the art in Blu-ray Disc player design and is designed for reliable and trouble-free performance.

## Features

- Full high-definition video playback at up to 1080p resolution for an amazing viewing experience.
- Upconversion of standard definition DVDs for enhanced picture quality at up to 1080p over an HDMI connection.
- Deep color
- Rich multi-channel surround sound.
- Easy and simple HDTV connection using a single HDMI cable (cable not included).
- Multiple outputs for connecting your home theater system or amplifier.
- PIP functionality that lets you display primary and secondary video at the same time (if available on the Blu-ray Disc).
- Pop-up menu display without interrupting playback (if available on the Blu-ray Disc).
- HDMI 1080p/fps output (Blu-ray Disc only) that provides smooth playback of video with a frame rate of 60 frames per second (TV must be connected with an HDMI cable and be compatible with an HDMI cable and be compatible with 1080p 60 frame).

## Package contents

- Blu-ray Disc player
- A/V cable
- Remote control
- AAA batteries (2)
- *User Guide*

### Front

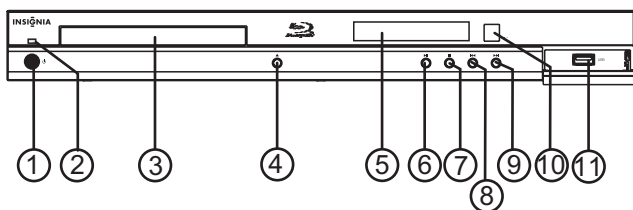

#	Item	Description
①	⏻ (standby/on)	Press to turn on your player or put your player in standby mode. When your player is in standby mode, power is still entering your player. To disconnect power, unplug the power cord.
②	Power indicator	Lights blue when your player is turned off (standby mode). Turned off when your player is turned on.
③	Disc tray	Insert a disc with the label side up into this tray. To open or close the tray, press ▲ (open/close).

#	Item	Description
④	▲ (open/close)	Press to open or close the disc tray.
⑤	VFD screen	Displays status information.
⑥	▶   (play/pause)	Press to start or pause playback.  Press to stop playback. The <i>Setup</i> menu is displayed. To resume playback, press ◀▶ ▲ or ▼ to select <b>DVD/BD-ROM</b> , then press <b>ENTER</b> . Depending on the disc, playback starts where it stopped or at the beginning of the disc.  If you press ■ (stop) twice, playback stops completely. To start playback again, press ▶   (play/pause).
⑦	■ (stop)	
⑧	◀◀ (previous)	Press to go to the previous title, chapter, or track.
⑨	▶▶ (next)	Press to go to the next title, chapter, or track.
⑩	Remote control sensor	Receives signals from the remote control. Do not block.
⑪	USB port	Connect a USB flash drive to this port.

### Back

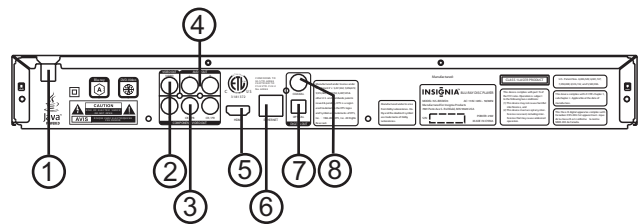

#	Item	Description
①	Power connector	Plug the power cord into a power outlet.
②	VIDEO OUT	Connect a TV to this jack and to the AUDIO OUT L/R jacks using a composite video cable (provided).
③	COMPONENT VIDEO OUT	Connect a TV to these jacks and to the AUDIO OUT L/R jacks using a component video cable and audio cable.
④	AUDIO OUT L/R	Connect the audio for a composite TV or component video TV to these jacks.
⑤	HDMI	Connect a TV to this jack using an HDMI cable. An HDMI cable carries both video and audio. You do not need to make an audio connection.
⑥	ETHERNET	Connect an ethernet cable to this jack and to a broadband Internet jack to download BD-Live information.
⑦	OPTICAL DIGITAL OUT	Connect an optical digital amplifier to this jack to play the sound from the TV through the amplifier's speakers.
⑧	COAXIAL DIGITAL OUT	Connect a coaxial digital amplifier to this jack to play the sound from the TV through the amplifier's speakers.

**Remote control**

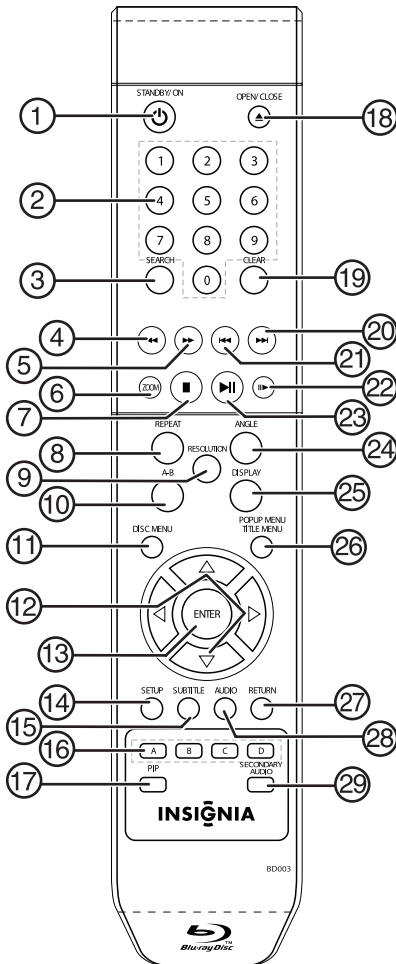

#	Item	Description
1	STANDBY/ON	Press to turn on your player or put your player in standby mode. When your player is in standby mode, power is still entering your player. To disconnect power, unplug the power cord.
2	Number buttons	In playback mode, press <b>SEARCH</b> , then press the number buttons to enter a title, chapter, track, or time. In menu mode, press to enter the parental code password.
3	SEARCH	Press to search for a title, chapter, or specific time on a disc. For more information, see "Searching for a title, chapter, or elapsed time" on page 9.
4	◀◀ (fast reverse)	Press to fast reverse. Each time you press this button, the fast-reverse speed decreases from Fast x 2, Fast x 4, Fast x 8, Fast x 16, Fast x 32, Fast x 64, Fast x 128. Press ▶▶ (play/pause) to resume normal playback.
5	▶▶ (fast forward)	Press to fast forward. Each time you press this button, the fast-forward speed increases from Fast x 2, Fast x 4, Fast x 8, Fast x 16, Fast x 32, Fast x 64, Fast x 128. Press ▶▶ (play/pause) to resume normal playback.
6	ZOOM	Press to zoom in on a video. Each time you press this button, the magnification level changes. This button is only used for DVD discs.

#	Item	Description
7	■ (stop)	Press to stop playback. The <i>Setup</i> menu is displayed. To resume playback, press ◀▶ ▲ or ▼ to select <b>DVD/BD-ROM</b> , then press <b>ENTER</b> . Depending on the disc, playback starts where it stopped or at the beginning of the disc. If you press ■ (stop) twice, playback stops completely. To start playback again, press ▶▶ (play/pause).
8	REPEAT	Press to repeat the current title, chapter, track, or repeat all. For more information, see "Repeating a title, chapter, or CD track" on page 9.
9	RESOLUTION	Press to select the video resolution. For more information, see "Selecting the video output resolution" on page 12.
10	A-B	Press to create a playback loop. For more information, see "Creating a playback loop on a DVD or audio CD" on page 9.
11	DISC MENU	During DVD playback, press to open the DVD root menu where you can select DVD playback options. (This button is valid for DVDs that have a multi-layer menu.)
12	◀▶ ▲ ▼	If a disc menu opens when playing a Blu-ray Disc or DVD, press to select a menu option, then press <b>ENTER</b> . During media file browsing, press to select a file on the popup menu, then press <b>ENTER</b> . When a menu is open, press to select an option, then press <b>ENTER</b> .
13	ENTER	Press to confirm selection in a menu.
14	SETUP	Press to open the setup menu where you can adjust options.
15	SUBTITLE	Press to select a subtitle language or to turn subtitles off.
16	A (red), B (green), C (yellow), D (blue)	When playing a Blu-ray Disc that has a Java™ application, press to control playback. For more information, see the documentation that came with the Blu-ray Disc.
17	PIP	Press to turn PIP (picture-in-picture) mode on or off. For more information, see "Using PIP (picture-in-picture) mode" on page 10.
18	▲ OPEN/CLOSE	Press to open or close the disc tray.
19	CLEAR	Press to clear an input error.
20	▶▶ (next)	Press to go to the next title, chapter, or track.
21	◀◀ (previous)	Press to go to the previous title, chapter, or track.
22	▶ (step)	Press to advance one frame at a time. Press ▶▶ (play/pause) to resume normal playback.
23	▶▶ (play/pause)	Press to start or pause playback.
24	ANGLE	Press to select a viewing angle if multiple angles are available on the disc. For more information, see "Selecting a viewing angle" on page 10.
25	DISPLAY	Press to display disc information.
26	POPUP MENU/TITLE MENU	During Blu-ray Disc playback, press to open a menu that lets you control Blu-ray Disc playback. During DVD playback, press to open the DVD menu (if available). For more information, see "Using a disc popup menu" on page 10.
27	RETURN	Press to return to the previous menu.
28	AUDIO	Press to select the audio mode. For more information, see "Selecting the audio mode" on page 10.
29	SECONDARY AUDIO	In PIP mode, press to turn the audio for the secondary video on or off. For more information, see "Using PIP (picture-in-picture) mode" on page 10.

## Setting up your player

### Installing remote control batteries

To install remote control batteries:

- 1 Remove the battery compartment cover.

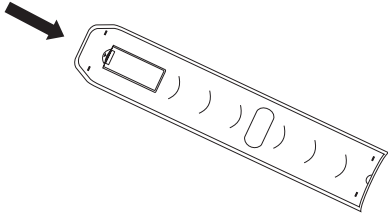

- 2 Insert two AAA batteries into the battery compartment. Make sure that the + and - symbols on the batteries match the + and - symbols in the battery compartment.

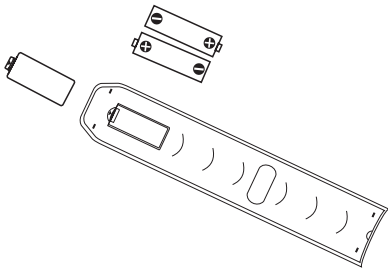

- 3 Replace the battery compartment cover.

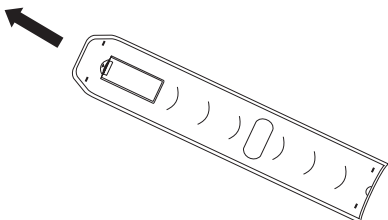

#### Notes

- Make sure that you insert the batteries correctly.
- Do not heat, open, or short-circuit batteries.
- Do not throw batteries into a fire.
- Do not mix different types of batteries or mix old and new batteries.
- Do not try to recharge non-rechargeable batteries.
- If the remote control does not function correctly or if the operating range becomes reduced, replace the batteries.

### Connecting a TV using an HDMI cable (best)

To connect a TV using an HDMI cable:

- Connect an HDMI cable to the **HDMI** jack on the back of your player and to the **HDMI IN** jack on the TV.

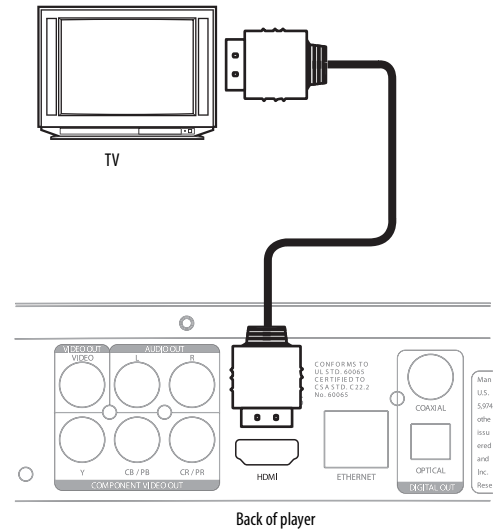

#### Notes

- Only the HDMI is capable of 1080i/1080p video output and the highest definition audio codes.
- An HDMI cable carries both video and audio. If you want to use TV speakers, you do not need to make an audio connection. If you want to use an audio receiver, connect an HDMI cable between your player and the HDMI input jack on the receiver. Then connect a second HDMI cable between the HDMI output jack on the receiver and the HDMI input jack on the TV.



**Connecting a TV using a component video cable (better)**

**Notes**

The following task shows connecting the audio to a receiver. If you want to use the TV speakers instead of a receiver, connect the audio cable to the TV's audio in jacks on the TV.

**Using an digital audio receiver**

**To connect a component-capable TV to a digital audio receiver:**

- 1 Connect a component video cable to the **COMPONENT VIDEO OUT** jacks on the back of your player and to the **COMPONENT VIDEO IN** jacks on the TV.

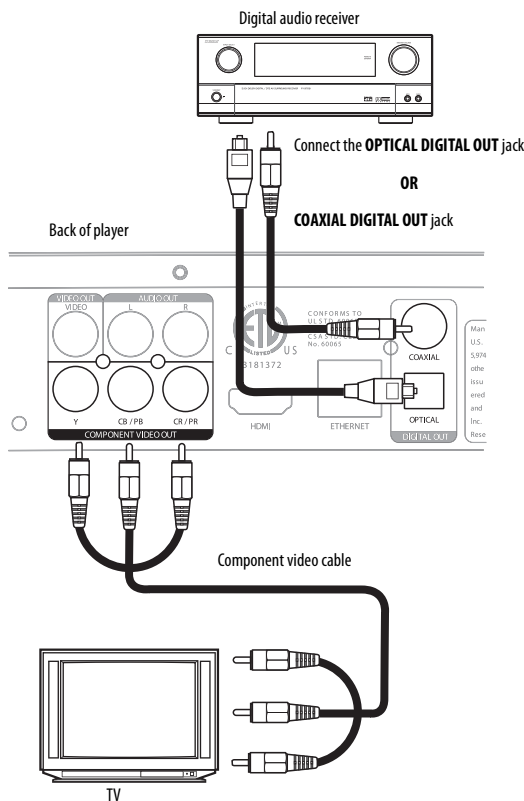

- 2 Connect a digital optical cable to the **OPTICAL DIGITAL OUT** jack on the back of your TV and to the **OPTICAL DIGITAL IN** jack on the receiver.
- Or
- Connect a digital coaxial cable to the **COAXIAL DIGITAL OUT** jack on the back of your TV and to the **COAXIAL DIGITAL IN** jack on the receiver.
- 3 Connect a second optical or digital cable to the **DIGITAL OUT** jack on the receiver and to the **DIGITAL IN** jack on the TV.

**Using an analog audio receiver**

**To connect a component-capable TV to an analog audio receiver:**

- 1 Connect a component video cable to the **COMPONENT VIDEO OUT** jacks on the back of your player and to the **COMPONENT VIDEO IN** jacks on the TV.

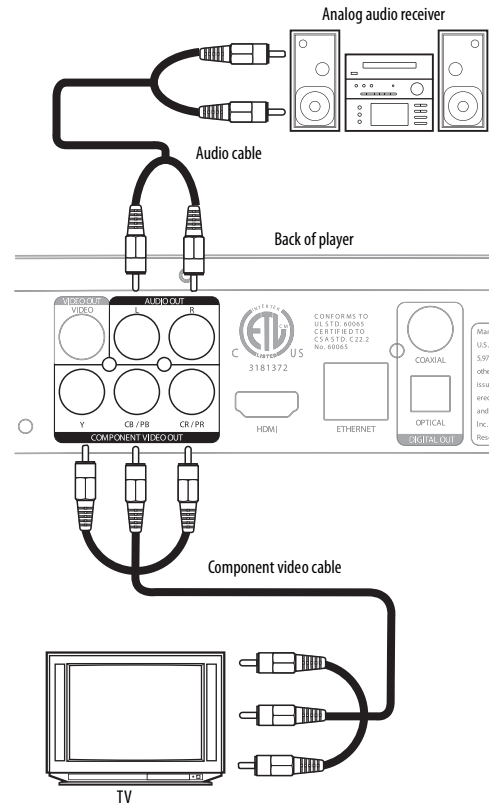

- 2 Connect an audio cable to the **AUDIO OUT L/R** jacks on the back of your player and to the **AUDIO IN L/R** jacks on the receiver.
- 3 Connect a second audio cable to the **AUDIO OUT L/R** jacks on the receiver and to the **AUDIO IN L/R** jacks on the TV.

## Connecting a TV using an A/V cable (good)

### To connect a TV using an AV cable:

- Connect an A/V cable to the **VIDEO OUT** and **AUDIO OUT L/R** jacks on the back of your player and to the **VIDEO IN** and **AUDIO IN L/R** jack on the TV. Jacks and cable connectors are usually color-coded. Make sure that you match the colors.

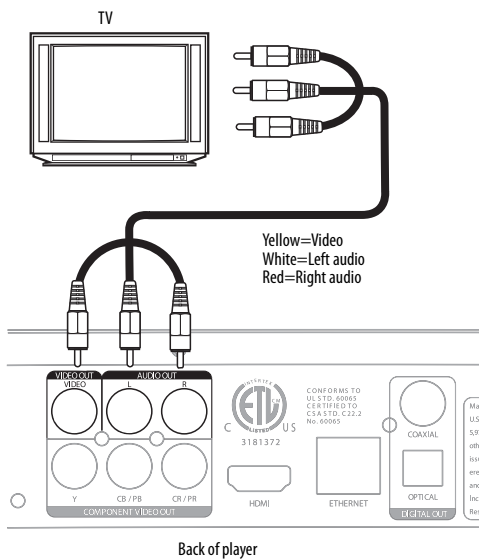

## Using your player

### Note

Unless otherwise noted, all tasks in this section are based on using the remote control.

### Playable discs

Disc type	Logo	Disc type	Logo
Blu-ray Disc		DVD-R	
DVD-video (DVD-ROM)		Audio CDs (CDDA)	
DVD-RAM		DTS-CD	
DVD-RW		MP3/WMA/JPEG/Data CD	

### Notes

- Writeable DVD discs (DVD-RAM, DVD-RW, DVD-R) must be finalized, VR-mode only.
- Your player supports discs that are compatible with DVD-RAM Standard Version 2.0.
- Playback may not work for some types of discs, or when specific operations, such as angle change and aspect ratio adjustment, are being performed. Information about the discs is written in detail on the box.
- Do not allow the disc to become dirty or scratched. Fingerprints, dirt, dust, scratches or deposits of cigarette smoke on the recording surface may make it impossible to use the disc for playback.
- CD-R/-RW, DVD-RAM/-RW/-R recorded with UDF or ISO9660 format can be played back.
- Windows Media Audio (WMA) files must be written to the disc with a .wma file extension in order to be recognized and played back correctly.
- High bitrate or variable bitrate .wma files may not play back correctly.
- JPEG picture files must be written to the disc with a .jpeg or .jpg file extension in order to be recognized and played back correctly.

## Connecting a USB flash drive

### To connect a USB flash drive:

- Plug the USB flash drive into the **USB** port on the front of your player.

## Connecting to the Internet

### To connect to the Internet:

- Connect a network cable into the **INTERNET** jack on the back of your player and into a network jack.

## About Blu-ray Discs

The massive storage capacity of a Blu-ray Disc allows a higher standard of picture and audio quality and a wealth of special effects and enhanced features not available on DVDs.

### Java

Your player features Java support so you can get the most out of the latest Blu-ray Discs. When a Blu-ray Disc loads, explore the title menu to enjoy these extra features.

### HDMI

HDMI is the only domestic medium capable of transmitting the huge volumes of data required by the high picture resolutions and advanced digital audio codecs that make Blu-ray such an exciting medium.

## Playing Blu-ray Discs

Playing Blu-ray Discs are a lot like playing DVDs, except Blu-ray Discs have a higher level of interactivity.

Most of the standard features of DVD playback work the same with Blu-ray Disc playback. The two most common exceptions are:

- **Resume play**—Not available on Blu-ray Java discs
- **A-B repeat** (playback loop)—Not available on some Blu-ray Discs

## Color buttons

The red, green, yellow and blue buttons on the remote control are used with interactive menus when operating a Blu-ray Disc that includes Java applications. For more information about using this kind of disc, see the instructions that came with the disc.

## Playing a Blu-ray Disc or DVD

### To play a Blu-ray Disc or DVD:

- 1 Press **STANDBY/ON**.
- 2 Turn on the TV, then select the input setting on the TV that matches the connection method you used to connect your player.
- 3 Press **OPEN/CLOSE** to open the disc tray.
- 4 Place a disc on the disc tray with the label facing up, then press **OPEN/CLOSE** to close the disc tray. It may take a few seconds for the disc to load.
- 5 If a Blu-ray Disc or DVD menu opens, press **▶▶▲** or **▼** to select **PLAY**, then press **ENTER**.
- 6 To eject the disc, press **OPEN/CLOSE**.

## Controlling Blu-ray Disc or DVD playback

### Note

If  appears on the screen, the current action is not permitted by the disc or your player. For example, many discs do not let you fast-forward through the warning information at the beginning of the disc.

### To control Blu-ray Disc or DVD playback:

- To start or pause playback, press **▶||** (play/pause). The sound is muted when your player is in pause mode. To resume normal playback, press **▶||** (play/pause).
- To stop playback, press **■** (stop). The *Setup* menu is displayed. To resume playback, press **◀▶▲** or **▼** to select **DVD/BD-ROM**, then press **ENTER**. Depending on the disc, playback starts where it stopped or at the beginning of the disc. If you press **■** (stop) twice, playback stops completely. To start playback again, press **▶||** (play/pause). Playback starts at the beginning of the disc.
- To fast-forward, press **▶▶**. Each time you press this button, the fast-forward speed changes in the following sequence: Fast x 2, Fast x 4, Fast x 8, Fast x 16, Fast x 32, Fast x 64, Fast x 128. Press **▶||** (play/pause) to resume normal playback.
- To fast-reverse, press **◀◀**. Each time you press this button, the fast-reverse speed changes in the following sequence: Fast x 2, Fast x 4, Fast x 8, Fast x 16, Fast x 32, Fast x 64, Fast x 128. Press **▶||** (play/pause) to resume normal playback.

- To go to the previous chapter, press **◀◀** within two seconds after the current chapter starts. To go to the beginning of the chapter, press **◀◀** any time after playing the first five seconds of the chapter.
- To go to the next chapter, press **▶▶**.
- To play one frame at a time, press **||▶** (step). Each time you press this button, the video advances one frame. Press **▶||** (play/pause) to resume normal playback.

## Playing files on a data disc or USB memory stick

When you insert a data disc or USB memory stick containing picture, music, or video files into your player, icons are added to the menu to indicate that video, music, or picture files are available for playback.

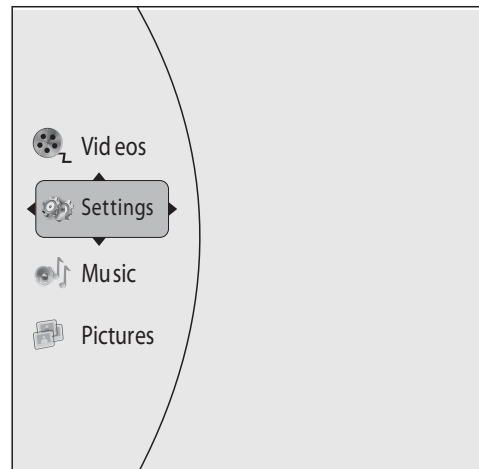

### To play audio or video files:

- 1 Press **▲** or **▼** to select **Music** or **Videos**, then press **ENTER**. A menu opens.
- 2 Press **▲** or **▼** to select **Play Files**, then press **ENTER**. The *Please select Play mode* box opens.

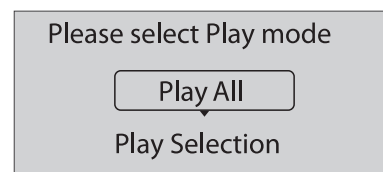

- Press **▲** or **▼** to select **Play All** (plays all files) or **Play Selection** (plays files added to the playlist), then press **ENTER**. The file(s) play and the following menu opens.

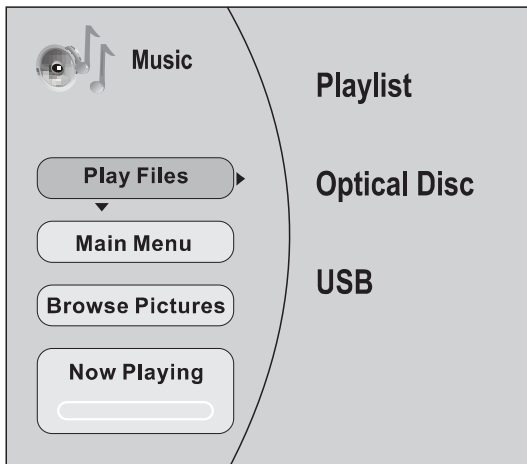

- If you are playing music files and want to view JPG picture files at the same time, press **RETURN**, then press **▲** or **▼** to select **Browse Pictures**, then press **ENTER**. Select the JPG files you want to view.
- If you want to see information about the file that is playing, press **▲** or **▼** to select **Now Playing**, then press **ENTER**. The following display appears

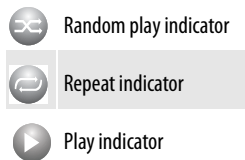

### To create a playlist:

- Insert a disc or plug in a USB flash drive, select **Music**, **Videos**, or **Pictures**, then press **▶**.
- Press **▲** or **▼** to select **Optical Disc** or **USB**, then press **ENTER**. A file browser window opens with a list of files and folders.
- Press **▲** or **▼** to select a file or folder, then press **ENTER**. If you selected a folder, the files in the folder are displayed. Press **▲** or **▼** to select a file, then press **ENTER**. The following menu opens:



- Press **▲** or **▼** to select **Add to playlist**, then press **ENTER**. The file is added to the playlist.

#### Note

If the file you selected is already in the playlist, **Remove from playlist** appears.

When you add a file to the playlist, **Remove all from playlist** appears on the screen automatically. You can use **Remove all from playlist**, **Previous Folder**, **Play Files**, **Browse Pictures**, and **Now Playing** to control playback.

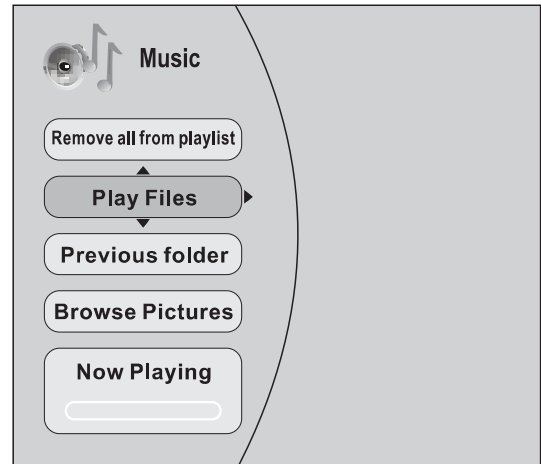

## Playing an audio CD

### To play an audio CD:

- Press **⏻** **STANDBY/ON**.
- Press **⏻** **OPEN/CLOSE** to open the disc tray.
- Place a CD on the disc tray with the label facing up, then press **⏻** **OPEN/CLOSE** to close the disc tray. It may take a few seconds for the CD to load.
- Press **ENTER** to start playback.
- To eject the CD, press **⏻** **OPEN/CLOSE**.

## Controlling audio CD playback

### To control audio CD playback:

- To start or pause playback, press **⏮** (play/pause). The sound is muted when your player is in pause mode. To resume normal playback, press **⏮** (play/pause).
- To stop playback completely, press **⏹** (stop) To start playback again, press **⏮** (play/pause). Playback starts at the beginning of the CD.
- To fast-forward, press **⏭**. To resume normal playback, press **⏮** (play/pause).
- To fast reverse, press **⏪**. To resume normal playback, press **⏮** (play/pause).
- To go to the previous track, press **⏪**. To go to the next track, press **⏭**.
- To select a track, press **SEARCH**, enter the track number with the number buttons, then press **ENTER**.

Or,

Enter the track number by pressing the appropriate number buttons.

## Displaying Blu-ray Disc information

### Note

The information displayed for discs other than Blu-ray Discs will be different.

### To display Blu-ray Disc information:

- Press **DISPLAY**. Your player displays information about the Disc, such as type of disc, current elapsed time in title, total amount of time in title, current chapter, and total number of chapters.
- Press **DISPLAY** again to close the display.

## Searching for a title, chapter, or elapsed time

### To search for a title, chapter, or elapsed time:

- 1 During playback, press **SEARCH** one or more times to select a search mode.
  - One press selects **Goto Title - - -** mode.
  - Two presses selects **Goto Chapter - - -** mode.
  - Three presses selects **Goto Time --:--:--** mode.
- 2 Press the number buttons to enter the title number, chapter number, or time, then press **ENTER**. Your player goes to the title, chapter, or time you entered.

## Repeating a title, chapter, or CD track

### To repeat a title, chapter, or CD track:

- To repeat a title or chapter, press **REPEAT** one or more times to select a repeat mode. You can select **Off**, **Repeat Title**, **Repeat Chapter**, **Repeat track**, **Repeat all**, or **Random**.

## Creating a playback loop on a DVD or audio CD

### Note

Blu-ray Discs do not normally support playback loops.

### To create a playback loop:

- 1 Play the disc until you reach the point where you want the loop to start, then press **A-B**.
- 2 Play the disc until you reach the point where you want the loop to stop, then press **A-B**. Your player plays the loop you created repeatedly.
- 3 Press **A-B** to cancel the loop and return to normal playback.

## Viewing photographs

Your player can display digital photograph files that have been burned onto a data disc, DVD+/-R, DVD+/-R/(W), or Blu-ray Disc.

### To view photographs:

- 1 Insert the disc with photographs into your Blu-ray player. The following menu opens:

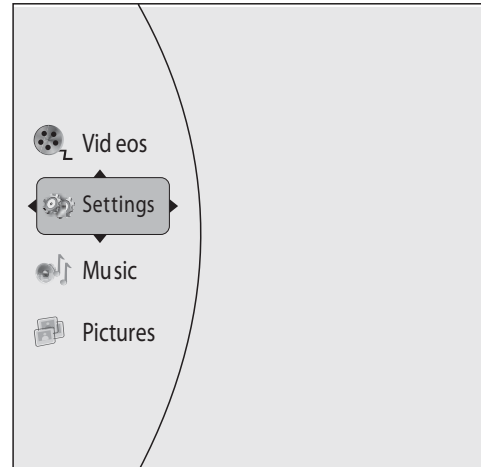

- 2 Press **▲** or **▼** to select **Pictures**, then press **ENTER**. A menu opens.
  - **Main Menu**—Returns to the main menu.
  - **Play Files**—Open the *Please Select Play Mode* box. Press **▲** or **▼** to select an option, then press **ENTER**.
    - **Play All**—Plays all files.
    - **Play Current Folder**—Plays the current JPG files.
    - **Browse Music**—Opens the music playing menu where you can select music files to play while you view photographs.
    - **Now Playing**—Opens a progress bar.

### To create a playlist:

- 1 Insert a disc or plug in a USB flash drive, then press **▶**.
- 2 Press **▲** or **▼** to select **Optical Disc** or **USB**, then press **ENTER**. A file browser window opens with a list of files and folders.
- 3 Press **▲** or **▼** to select a file or folder, then press **ENTER**. If you selected a folder, the files in the folder are displayed. Press **▲** or **▼** to select a file, then press **ENTER**.
- 4 Press **◀**. A menu appears.
- 5 Press **▲** or **▼** to select an option, then press **ENTER**. You can select:
  - **Remove all from playlist**—Deletes all files in playlist.
  - **Previous folder**—Returns the previous menu.
  - **Play files**—Play all files or play files in the playlist.
  - **Browse Music**—Opens the music playing menu where you can select music files to play while you view photographs.
  - **Now playing**—Opens a progress bar.

### To add a JPG file to the playlist:

- 1 Insert a disc or plug in a USB flash drive, then press **▶**.
- 2 Press **▲** or **▼** to select **Optical Disc** or **USB**, then press **ENTER**.
- 3 Press **▲** or **▼** to select a file or folder, then press **ENTER**. If you selected a folder, the files in the folder are displayed. Press **▲** or **▼** to select a file, then press **ENTER**. The following menu opens:

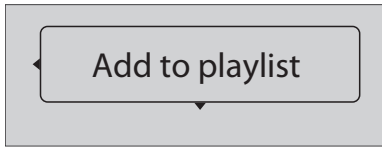

- 4 Press **ENTER**.
- 5 Press **▲** or **▼** to select **Play File**, then press **ENTER**. The file starts playing.
- 6 During playback, press **DISC MENU** to open the **SLIDE SHOW** menu where you can select the slide show mode and picture switching time.

### Using PIP (picture-in-picture) mode

Some Blu-ray Discs and DVDs are compatible with picture-in-picture (PIP) mode. In PIP mode, the primary video is displayed on the full screen, and the secondary video is displayed in a small window.

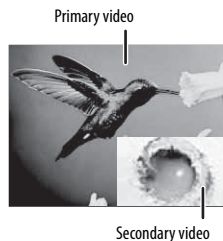

See the documentation that came with the disc for playback instructions.

#### To use PIP mode:

- 1 Press **PIP** to turn PIP mode on or off.
- 2 If PIP mode is on, press **SECONDARY AUDIO** to turn the audio for the video in the PIP window on or off.

### Using a disc popup menu

#### To use a disc popup menu:

- 1 During Blu-ray or DVD playback, press **POPUP MENU/TITLE MENU**. The Blu-ray popup menu or DVD disc menu opens.
- 2 Press **▲** **▼** **◀** or **▶** to select an option, then press **ENTER**.

### Selecting the audio mode

#### To select the audio mode:

- 1 Press **AUDIO**. Your player displays audio channel information, such as "01/03 Eng Dolby Digital." "01" indicates the currently selected audio channel. "03" indicates the total number of audio channels. "Eng" (English) indicates the audio language. "Dolby Digital" describes the currently selected audio format.
- 2 Press **▶** to select an audio mode.

### Selecting a viewing angle

#### Note

Not all discs are recorded with multiple viewing angles and not all scenes on a disc have multiple viewing angles.

#### To select the viewing angle:

- During playback, press **ANGLE**. Your player displays "Angle X of X." The first "X" indicates the current viewing angle, and the second "X" indicates the total number of viewing angles.

### Selecting the on-screen menu language

#### To select the on-screen menu language:

- 1 Press **ENTER**. The *Settings* menu opens.

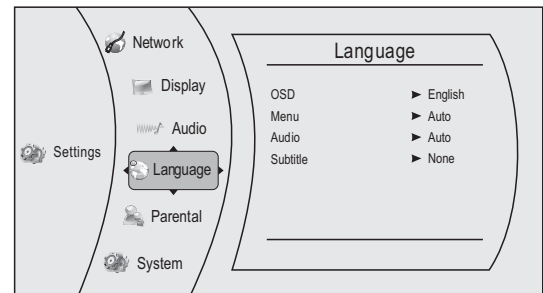

- 2 Press **▲** or **▼** to select **Language**. The *Language* menu opens.
- 3 Press **▶** to select **OSD**, then press **ENTER**.
- 4 Press **▲** or **▼** to select the language you want, then press **ENTER**. You can select **English**, **French**, or **Spanish**.
- 5 Press **◀** to go to the previous menu.

### Selecting the disc menu language

#### To select the disc menu language:

- 1 Press **ENTER**. The *Settings* menu opens.

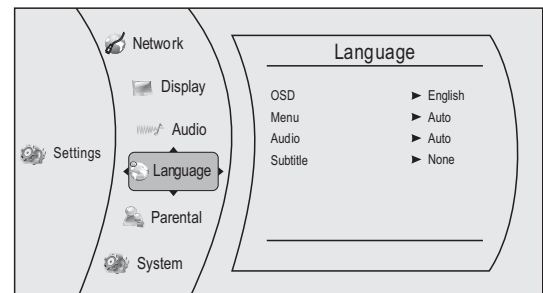

- 2 Press **▲** or **▼** to select **Language**. The *Language* menu opens.
- 3 Press **▶**, press **▲** or **▼** to select **Menu**, then press **ENTER**.
- 4 Press **▲** or **▼** to select the language you want, then press **ENTER**.

**Notes**

- Not all languages are available on all discs.
- Most discs only have one menu language.

- 5 Press **◀** to go to the previous menu.

### Selecting the audio language

**To select the on-screen menu language:**

- 1 Press **ENTER**. The *Settings* menu opens.

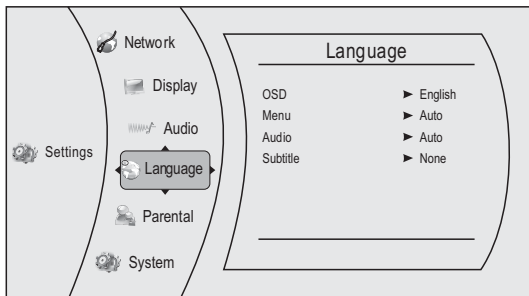

- 2 Press **▲** or **▼** to select **Language**. The *Language* menu opens.
- 3 Press **▶**, press **▲** or **▼** to select **Audio**, then press **ENTER**.
- 4 Press **▲** or **▼** to select the language you want, then press **ENTER**.

**Notes**

- Not all languages are available on all discs.
- Some discs do not let you select the audio language using your player's menu. Instead, you have to select the audio language from the disc setup menu (the menu that appears after you insert the disc).

- 5 Press **◀** to go to the previous menu.

### Selecting the subtitle language

**To select the subtitle language:**

- 1 Press **ENTER**. The *Settings* menu opens.

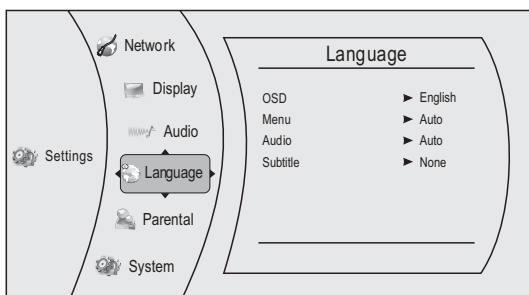

- 2 Press **▲** or **▼** to select **Language**. The *Language* menu opens.
- 3 Press **▶**, press **▲** or **▼** to select **Subtitle**, then press **ENTER**.

- 4 Press **▲** or **▼** to select the language you want, then press **ENTER**.

**Notes**

- Not all languages are available on all discs.
- Some discs do not let you select the subtitle language from your player. Instead, you have to select the subtitle language from the disc setup menu (the menu that appears after you insert the disc).

You can also select the subtitle language from the Subtitle menu in the on-screen menu.

### Determining whether an HDMI TV is connected

**To determine whether an HDMI TV is connected:**

- 1 Press **ENTER**. The *Settings* menu opens.

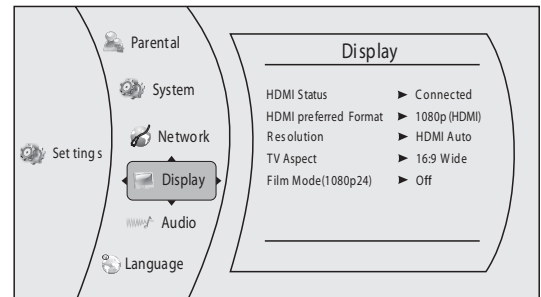

- 2 Press **▲** or **▼** to select **Display**. The *Display* menu opens.
- If an HDMI TV is connected, **Connected** appears. If an HDMI TV is not connected **Disconnected** appears
- 3 Press **◀** to go to the previous menu.

### Automatically determining the best HDMI resolution

**To automatically determine the best HDMI resolution:**

- 1 Press **ENTER**. The *Settings* menu opens.

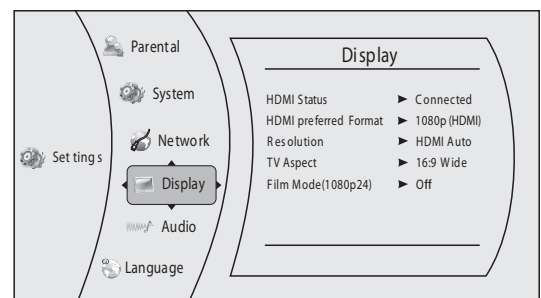

- 2 Press **▲** or **▼** to select **Display**. The *Display* menu opens. Your player displays the best HDMI format for the connected TV.
- 3 Press **◀** to go to the previous menu.

## Selecting the video output resolution

To select the video output resolution:

- 1 Press **ENTER**. The *Settings* menu opens.

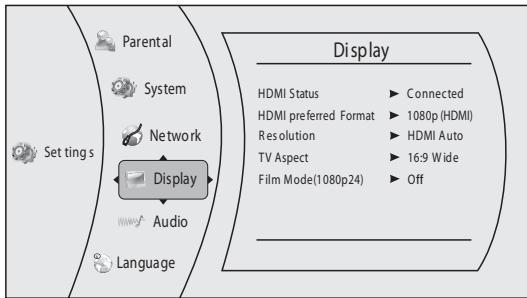

- 2 Press **▲** or **▼** to select **Display**. The *Display* menu opens.
- 3 Press **▶**, to select **Resolution**, then press **ENTER**.
- 4 Press **▲** or **▼** to select the resolution you want, then press **ENTER**.

TV type	Resolution
If your TV is a standard-definition NTSC TV (American or Asian SD TV)	480i
If your TV is an enhanced-definition TV (EDTV)	480p
If your TV is a high-definition TV (HDTV) capable of 720p only	720p
If your TV is a high-definition TV (HDTV) capable of 1080i only	1080i
If the TV is a high-definition TV (HDTV) capable of 1080p (any frame rate) connected to the HDMI jack on your player	1080p (HDMI)
If your TV is a high-definition TV (HDTV) connected to the HDMI jack on your player and you want your player to set the output resolution based on information exchanged between the TV and your player over the HDMI cable	HDMI Auto

### Notes

- Selecting a resolution the TV does not support could result in an unstable picture or loss of the picture. See the documentation that came with the TV to find the resolutions the TV supports.
- Only the HDMI output on your player supports 1080p video output at any frame rate. If the TV is connected to the component output, the video output is limited to 1080i.

- 5 Press **◀** to go to the previous menu.

## Selecting the TV aspect ratio

- 1 Press **ENTER**. The *Settings* menu opens.

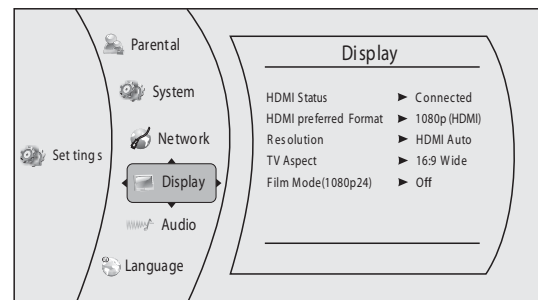

- 2 Press **▲** or **▼** to select **Display**. The *Display* menu opens.
- 3 Press **▶**, press **▲** or **▼** to select **TV Aspect**, then press **ENTER**.
- 4 Press **▲** or **▼** to select the aspect ratio you want, then press **ENTER**. You can select **16:9 Pillarbox**, **4:3 Pan & Scan**, **4:3 Letter Box**, or **16:9 wide**.

### Notes

- If your TV has a rectangular (16:9) aspect ratio, choose one of the 16:9 aspect ratios. If your TV has a square (4:3) aspect ratio, choose one of the 4:3 aspect ratios.
- Setting your player for one of the 16:9 settings when connected to a 4:3 TV or setting your player for one of the 4:3 settings when connected to a 16:9 TV will produce unpredictable results.
- In the standard-definition (480p) mode, your player has 16:9 and 4:3 aspect ratios. In the high-definition (720p/1080i/1080p) mode, your player has only 16:9 aspect ratio.

- 5 Press **◀** to go to the previous menu.

## Turning film mode on or off

Movies are recorded on film at a rate of 24 pictures (frames) per second. Many of the movies on Blu-ray Discs are recorded on the discs at this frame rate. However, not all TVs can display 24 progressive frames/second of video. If the TV cannot display this frame rate, you need to turn off **Film Mode (1080p24)**.

To turn film mode on or off:

- 1 Press **ENTER**. The *Settings* menu opens.

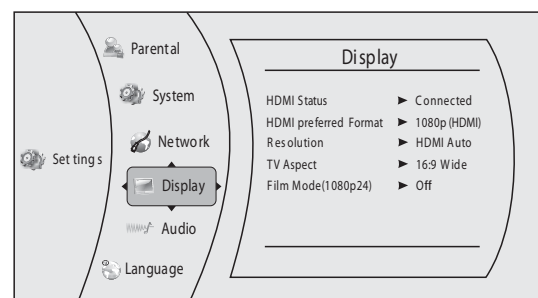

- 2 Press **▲** or **▼** to select **Display**. The *Display* menu opens.
- 3 Press **▶**, press **▲** or **▼** to select **Film Mode (1080p24)**, then press **ENTER**.



- 4 Press **▲** or **▼** to select **On** or **Off**. **Off** selects a 60 frames/second output format.
- 5 Press **◀** to go to the previous menu.

## Selecting the PCM downsampling rate

To select the PCM downsampling rate:

- 1 Press **ENTER**. The *Settings* menu opens.

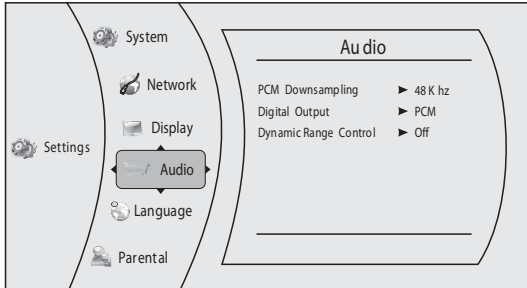

- 2 Press **▶**, press **▲** or **▼** to select **Audio**. The *Audio* menu opens.
- 3 Press **▶** to select **PCM Downsampling**, then press **ENTER**.
- 4 Press **▶** one or more times to select the PCM downsampling rate you want. You can select **48KHz**, **96KHz**, or **Off**.

- If you have a surround sound amplifier connected to your player through the **SPDIF** jack, select the highest sampling rate the receiver supports. See the documentation that came with the receiver.
- If you do not have a surround sound amplifier connected to your player, select **48KHz**.
- If you have a surround sound amplifier connected to your player through the analog audio L and R jacks, select **48KHz**.
- If you have a surround sound amplifier connected to your player through the **HDMI** output, select **48KHz**.

### Note

Incorrectly setting the digital audio output's PCM sampling rate may result in unpredictable audio playback.

- 5 Press **◀** to go to the previous menu.

## Selecting the digital audio output mode

To select the digital audio output mode:

- 1 Press **ENTER**. The *Settings* menu opens.

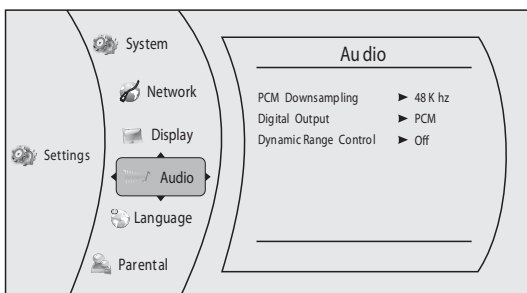

- 2 Press **▲** or **▼** to select **Audio**. The *Audio* menu opens.

- 3 Press **▶**, press **▲** or **▼** to select **Digital Output**, then press **ENTER**.
- 4 Press **▲** or **▼** to select the digital output mode you want, then press **ENTER**. You can select:

- **PCM**—Sends mixed digital audio over the HDMI connection in 7.1CH PCM (if supported by HDMI device) and the SPDIF connection in two-channel PCM format.
  - **Bitstream HD**—Sends the original bitstream from the disc over the HDMI and SPDIF connections using highest quality possible. HDMI has the higher quality capabilities with advanced audio codecs like TrueHD and DTS-HD. Blu-ray audio is limited to the soundtrack for the main movie (no PIP audio and no effects audio).
  - **Bitstream Legacy**—Sends the original bitstream from the disc over the HDMI and SPDIF connections using legacy audio formats. Blu-ray audio is limited to the soundtrack for the main movie (no PIP audio and no effects audio).
  - **Bitstream mixed**—Sends mixed and encoded Blu-ray audio streams in a single bitstream. This mode is primarily intended for use with SPDIF 5.1CH receivers to produce mixed Blu-ray audio in surround sound.
- 5 Press **◀** to go to the previous menu.

## Turning dynamic range control on or off

Dynamic range control is only active when a Dolby Digital signal is detected.

When **Dynamic Range Control** is set to **Off**, movie soundtracks are played with the standard dynamic range.

When movie soundtracks are played at low volume or from smaller speakers, you can set **Dynamic Range Control** to **On**. Your player applies appropriate compression to make low-level content more intelligible and prevent dramatic passages from getting too loud.

To turn dynamic range control on or off:

- 1 Press **ENTER**. The *Settings* menu opens.

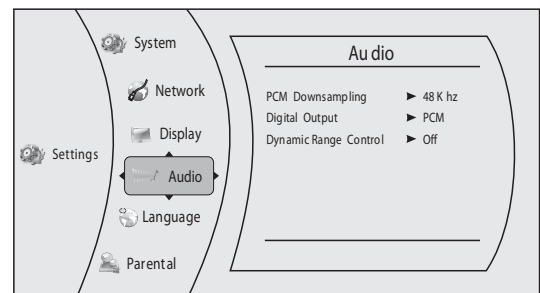

- 2 Press **▲** or **▼** to select **Audio**. The *Audio* menu opens.
- 3 Press **▶**, press **▲** or **▼** to select **Dynamic Range Control**, then press **ENTER**.
- 4 Press **▲** or **▼** to select **On** or **Off**.
- 5 Press **◀** to go to the previous menu.

## Setting the parental control password

### To set the parental control password:

- 1 Press **ENTER**. The *Settings* menu opens.

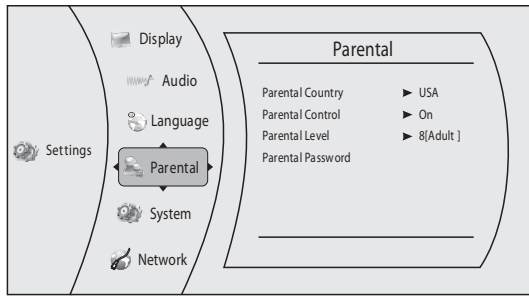

- 2 Press **▲** or **▼** to select **Parental**. The *Parental* menu opens.
- 3 Press **▶**. The password screen opens.
- 4 Enter the default password (**0000**). If you forget your password, reset your player to the factory defaults. The password will be reset to **0000**. For more information, see "Resetting settings to the factory defaults" on page 16
- 5 Press **◀** to go to the previous menu.

## Turning parental controls on or off

### To turn parental controls on or off:

- 1 Press **ENTER**. The *Settings* menu opens.

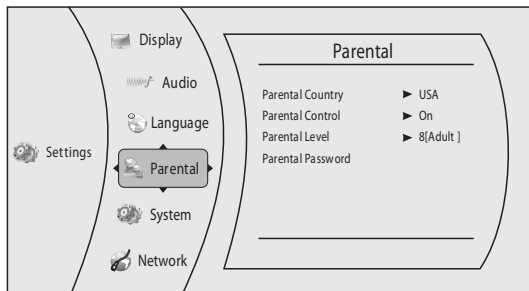

- 2 Press **▲** or **▼** to select **Parental**. The *Parental* menu opens.
- 3 Press **▶**. The password screen opens.
- 4 Enter the password. If you forget your password, reset your player to the factory defaults. The password will be reset to **0000**. For more information, see "Resetting settings to the factory defaults" on page 16
- 5 Press **▲** or **▼** to select **Parental Control**, then press **ENTER**.
- 6 Press **▲** or **▼** to select **On** or **Off**, then press **ENTER**. If you select **On**, you can change the other parental control options. If you select **Off**, you cannot change the other parental control options.

## Selecting the parental control country

If a Blu-ray Disc has parental rating systems for more than one country, you can select the country you want to use.

### To set the parental control country:

- 1 Press **ENTER**. The *Settings* menu opens.

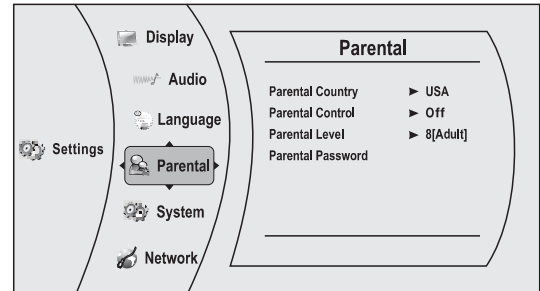

- 2 If the **Parental Control** option is set to **On**, set the option to **Off**. See "Turning parental controls on or off" on page 14.
- 3 Press **▲** or **▼** to select **Parental**. The *Parental* menu opens.
- 4 Press **▶** to select **Parental Country**, then press **ENTER**.

#### Note

Some Blu-ray Discs do not have multiple countries encoded for parental controls.

- 5 Press **▶** one or more times to select the country you want.
- 6 Press **◀** to go to the previous menu.

## Setting the parental control level

### To set the parental control level:

- 1 Press **ENTER**. The *Settings* menu opens.

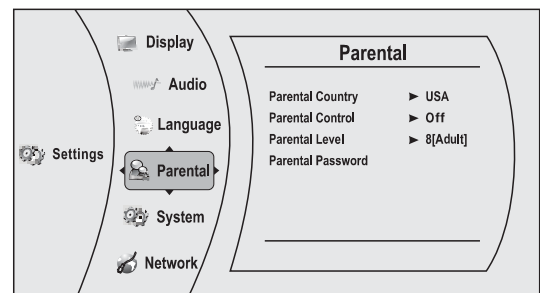

- 2 Press **▲** or **▼** to select **Parental**. The *Parental* menu opens.
- 3 If the **Parental Control** option is set to **On**, set the option to **Off**. See "Turning parental controls on or off" on page 14.
- 4 Press **▲** or **▼** to select **Parental Level**, then press **ENTER**.

- 5 Press **▲** or **▼** to select the rating level you want to block, then press **ENTER**. That rating and all higher ratings will be blocked. You can select:
  - **1[Kid Safe]**—Suitable for all children.
  - **2[G]**—General audiences.
  - **3[PG]**—Parental guidance suggested.
  - **4[PG-13]**—Not suitable for anyone under 13.
  - **5[PGR]**—Parental guidance recommended.
  - **6[R]**—Not suitable for anyone under 17 unless supervised by a parent or adult guardian.
  - **7[NC-17]**—Not suitable for anyone under 17.
  - **8[Adult]**—All DVDs can be played.

**Note**

These ratings are for DVDs only.

- 6 Press **▲** or **▼** to select **Parental Control**, then press **ENTER**. Press **▲** or **▼** to select **On**.
- 7 Press **◀** to go to the previous menu.

### Setting automatic disc playback mode

**To set automatic disc playback mode:**

- 1 Press **ENTER**. The *Settings* menu opens.

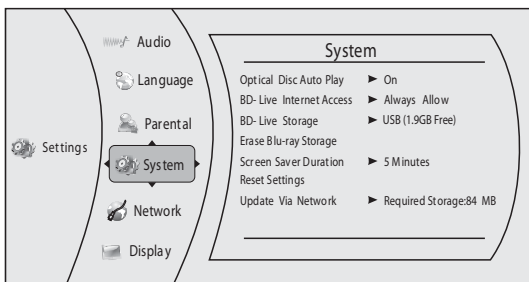

- 2 Press **▲** or **▼** to select **System**. The *System* menu opens.
- 3 Press **▶** to select **Optical Disc Autoplay**, then press **ENTER**.
- 4 Press **▲** or **▼** to **On** or **Off**. When **On** is selected and you insert a Blu-ray Disc, files play back automatically. When **Off** is selected and you insert a Blu-ray Disc, the disc you can select are displayed on the *Settings* menu.
- 5 Press **◀** to go to the previous menu.

### Setting the BD-Live Internet access level

You can set the BD-Live Internet access level to control access to BD-Live.

**To set the BD-Live Internet access level:**

- 1 Press **ENTER**. The *Settings* menu opens.

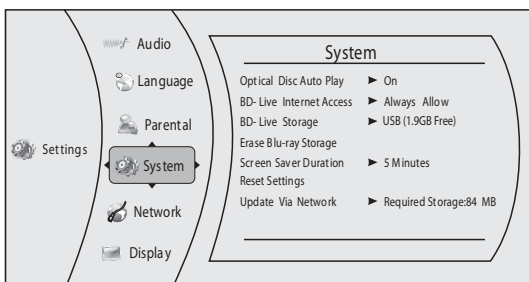

- 2 Press **▲** or **▼** to select **System**. The *System* menu opens.
- 3 Press **▶**, press **▲** or **▼** to select **BD-Live Internet Access**, then press **ENTER**.
- 4 Press **▶** one or more times to select the access level you want. You can select:
  - **Limit Access**—Allows Internet access with valid "BD-Live" network access approval.
  - **Always Allow Access**—Always allows BD-Live Internet access.
  - **Prohibit Access**—Never allows BD-Live Internet access.
- 5 Press **◀** to go to the previous menu.

### Viewing available BD-Live storage space

**To view available BD-Live storage space:**

- 1 Press **ENTER**. The *Settings* menu opens.

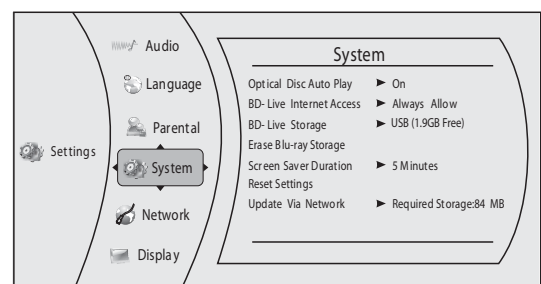

- 2 Press **▲** or **▼** to select **System**. The *System* menu opens. The available storage space is displayed next to **BD-Live Storage**.
- 3 Press **◀** to go to the previous menu.

### Erasing BD-Live storage

**To erase BD-Live storage:**

- 1 Press **ENTER**. The *Settings* menu opens.

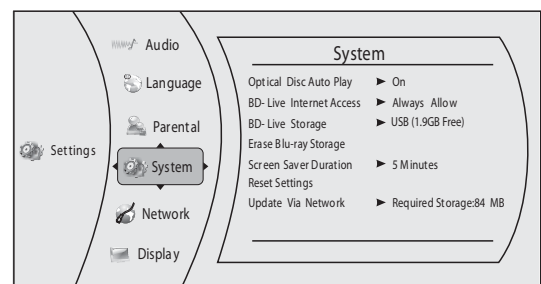

- 2 Press **▲** or **▼** to select **System**. The *System* menu opens.
- 3 Press **▶**, press **▲** or **▼** to select **Erase BD-Live Storage**, then press **ENTER**.
- 4 Press **◀** or **▶** to select **OK**, then press **ENTER**. All bookmarks and BD-live content saved in memory are deleted.
- 5 Press **◀** to go to the previous menu.

## Setting the screen saver activation time

Your player has a screen saver feature that turns the screen black when your player is inactive. You can set the amount of time you want your player to wait before activating the screen saver.

### To set the screen saver activation time:

- 1 Press **ENTER**. The *Settings* menu opens.

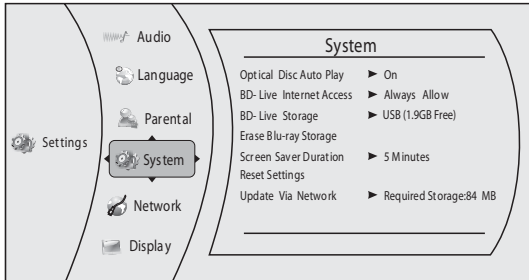

- 2 Press **▲** or **▼** to select **System**. The *System* menu opens.
- 3 Press **▶**, press **▲** or **▼** to select **Screen Saver Duration**, then press **ENTER**.
- 4 Press **▶** one or more times to select the amount of time you want the player to wait before activating the screen saver feature.
- 5 Press **◀** to go to the previous menu.

## Resetting settings to the factory defaults

### To reset settings to the factory defaults:

- 1 Press **ENTER**. The *Settings* menu opens.

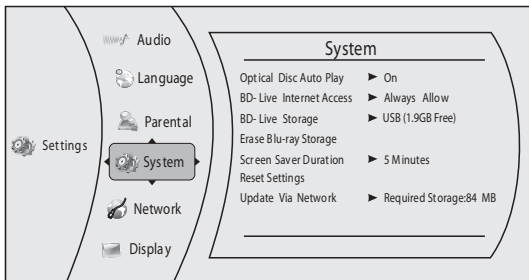

- 2 Press **▲** or **▼** to select **System**. The *System* menu opens.
- 3 Press **▶**, press **▲** or **▼** to select **Reset Settings**, then press **ENTER**. A message appears asking you to confirm your selection.
- 4 Select **OK**, then press **ENTER** to close the message box.
- 5 Press **◀** to go to the previous menu.

## Downloading player update software

### To download player update software:

- 1 Press **ENTER**. The *Settings* menu opens.

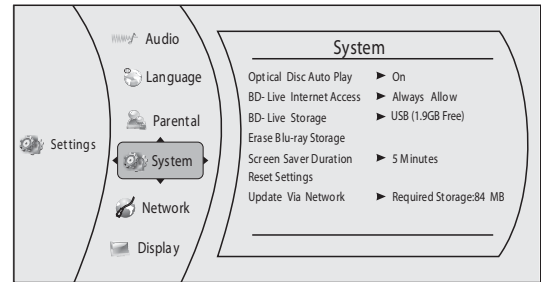

- 2 Press **▲** or **▼** to select **System**. The *System* menu opens.
- 3 Press **▶**, press **▲** or **▼** to select **Update Via Network**, then press **ENTER**.
- 4 Follow the on-screen instructions for updating the software.
- 5 Press **◀** to go to the previous menu.

## Determining if the network connection is active

### To determine if the network connection is active:

- 1 Press **ENTER**. The *Settings* menu opens.

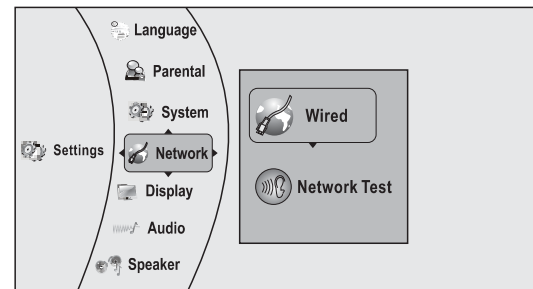

- 2 Press **▲** or **▼** to select **Network**.
- 3 Press **▶**, press **▲** or **▼** to select **Wired**, then press **ENTER**. The *IP Settings* screen opens. If the network connection is active, **Link Up** appears next to **Link Status**. If the network connection is not active, **Link Down** appears next to **Link Status**.

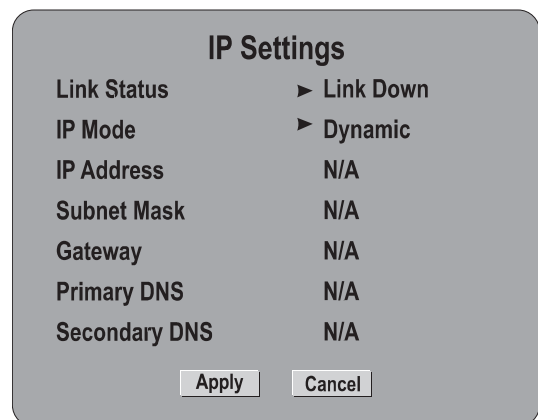

- 4 Press **◀** to go to the previous menu.

## Configuring the Internet connection

### To configure the Internet connection:

- 1 Press **ENTER**. The *Settings* menu opens.

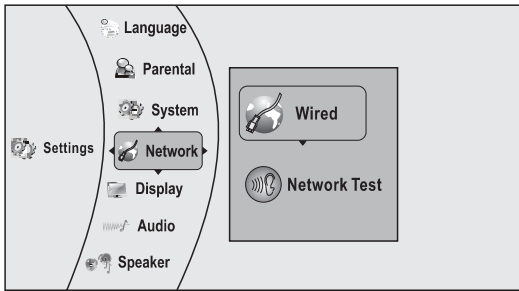

- 2 Press **▲** or **▼** to select **Network**, then press **ENTER**.
- 3 Press **▶**, press **▲** or **▼** to select **Wired**, then press **ENTER**. The *IP Settings* screen opens. The *IP Settings* screen opens.

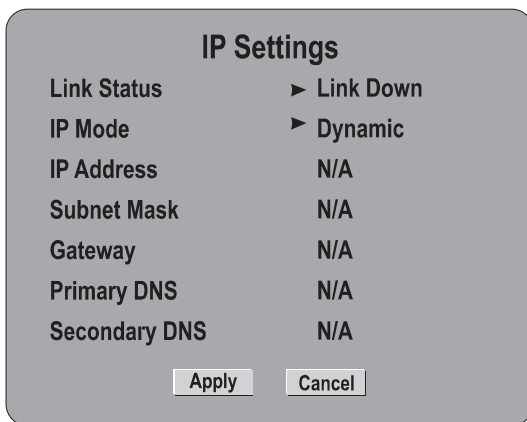

- 4 Press **▲** or **▼** to select **IP Mode**, then press **ENTER**.
- 5 Press **▶** to select an IP mode. You can select:
  - **Dynamic**—Uses DHCP to automatically obtain an IP address.
  - **Manual**—Lets you manually configure network settings, such as IP address, subnet mask, and gateway settings.
  - **Off**—Disables the network interface.
- 6 Press **◀** to go to the previous menu.

## Maintaining

### General guidelines

- The top and back panels of your player may become hot after a long period of use. This is not a malfunction.
- When you are not using your player, make sure that you remove the disc and put your player into standby mode.
- If you do not use your player for a long period of time, it may not function correctly. Turn on and use your player occasionally.
- Do not place objects on the disc tray.
- Do not locate your player:
  - Near heating devices or in an enclosed vehicle
  - In an area with a temperature over 104°F (40°C) or humidity over 90%
  - Dirty places
  - In an area with direct exposure to sunlight
  - Do not install this equipment in a confined space such as a book case or similar unit. The ventilation should not be impeded by covering the ventilation openings with items such as newspapers, table-cloths, or curtains.
- Make sure that you leave a minimum of 4 inches (10 cm) around your player for sufficient ventilation.

### Electrical disturbance

If you place your player next to a radio, TV, or VCR, the image may be poor and the sound may be distorted. In this case, move your player away from the radio, TV, or VCR.

### Condensation

Condensation may form inside your player when:

- You move your player from a cold area to a warm area
- You use it in a cold room where you have just turned on a heater
- Air conditioning is blowing directly on your player
- Your player is in a damp place

If condensation forms inside your player, your player will not work correctly. Turn on your player, remove the disc and leave the tray open, then leave your player on for two to three hours.

To minimize condensation problems, keep the power cord connected to a power outlet.

### Storing discs

- Do not store discs in a place that is exposed to direct sunlight or heat.
- Do not store discs in a place that is exposed to moisture and dust, such as a bathroom or near a humidifier.
- Store discs vertically in their cases. Stacking discs or placing objects on discs when not in their cases may cause warping.

## Handling discs

- To keep a disc clean, do not touch the play side (non-label side) of the disc.
- Do not attach paper or tape to the disc.



## Cleaning discs

- Before playback, wipe the disc outwards from the center (not in a circle) with a clean cloth.



## FAQ (frequently asked questions)

Question	Answer
What do I need to play multi channel surround sound?	Connect the appropriate amplifier/receiver to the <b>HDMI</b> jack, the <b>DIGITAL AUDIO OUT</b> jack ( <b>OPTICAL</b> or <b>COAXIAL</b> ).
Can I connect headphones to my player?	You cannot directly connect headphones to your player. Connect headphones to the connected TV or sound system.
My television has COMPOSITE VIDEO IN, COMPONENT(YUV) IN and HDMI IN jacks.	HDMI provides the best video and audio. Component video provides better video than composite video, but not as good as HDMI video. Composite video provides good video. <b>Note:</b> When you connect a TV using HDMI, the picture takes longer to display.
Can I play Blu-ray Discs and DVDs bought in another country?	You can play them if the video standard is NTSC. However, you cannot play: <ul style="list-style-type: none"> <li>• Blu-ray Discs that do not include region code A.</li> <li>• DVDs that do not include region code 1 or ALL.</li> </ul> Region codes are on the discs or disc packaging.

Question	Answer
Can I play Blu-ray Discs and DVDs that do not have a region code?	No. Region codes indicate that a disc conforms to industry standards. You cannot play a disc that does not have a region code.
What types of discs will my player play?	Your player can play: <ul style="list-style-type: none"> <li>• Blu-ray Discs</li> <li>• DVD-Video, DVD-RAM (DVD Video Recording format, AVCHD format, and JPEG format), DVD-R/RW (DVD Video format and DVD Video Recording format), DVD-R DL (DVD Video format and DVD Video Recording format), DVD+R, DVD+RW, and DVD+R DL</li> <li>• Audio CD</li> <li>• CD-R/RW discs which have been recorded in one of the following standards: CD-DA and still pictures (JPEG). Close the session after recording.</li> </ul> <b>Note:</b> Your player cannot write to discs.

## Troubleshooting

Check the following information for the possible cause and solution for a problem before contacting the nearest service center or dealer for repairs.

The following do not indicate a problem with your player:

- Regular disc rotation sounds.
- Image disturbance during search.

### Resetting your player

#### To reset your player:

- If your player "freezes," press **⏻** **STANDBY/ON** on the front of your player. Wait five seconds then press **⏻** **STANDBY/ON** again. This resets your player but does not change any settings.
- To reset all settings (include parental control settings) to the factory default, select **Reset Settings** in the *System* menu.

### Power

Problem	Solution
No power	Make sure that the power cord is plugged into a power outlet and that the outlet is supplying power.
The player switches to standby mode	After a period of inactivity, your player switches to standby mode automatically. This is a power saving feature. If your player switches to standby mode unexpectedly, a safety device may have been activated. Press <b>⏻</b> <b>STANDBY/ON</b> on the front of your player.

## Operation

Problem	Solution
Remote control does not work	<ul style="list-style-type: none"> <li>Make sure that you are pointing the remote control at the remote control sensor on the front of your player.</li> <li>Make sure that there are no obstructions between the remote control and the remote control sensor on the front of your player.</li> <li>Make sure that there is no colored glass between the remote control and the remote control sensor on the front of your player. Colored glass, such as the glass door of an entertainment center, can interfere with signal reception.</li> <li>Make sure that the remote control sensor is not exposed to direct sunlight or bright light. These can interfere with signal reception.</li> <li>Replace the batteries.</li> </ul>
Some or all functions do not work	<ul style="list-style-type: none"> <li>Some functions are not allowed by the disc, for example, fast-forwarding through the warning information at the beginning of the disc.</li> <li>Condensation may have formed inside your player. Turn off your player and wait one to two hours for the condensation to evaporate.</li> <li>Reset your player. For instructions, see "Resetting your player" on page 18.</li> </ul>
Playback fails to start or starts then stops even when ►   (play/pause) is pressed	<ul style="list-style-type: none"> <li>Make sure that the disc is inserted face up in the disc tray.</li> <li>Make sure that the disc is not dirty. For instructions, see "Cleaning discs" on page 18.</li> <li>The disc may be blank or incompatible with your player. Try another disc.</li> </ul>
Start up is slow and audio and video output takes a long time	<ul style="list-style-type: none"> <li>If power has been interrupted or the power cord has just been connected, startup is slow. This is not a defect.</li> <li>If your player is connected to the TV with an HDMI cable, startup is slow. This is not a defect.</li> </ul>
When reading a disc, the disc tray opens	<ul style="list-style-type: none"> <li>Make sure that the disc is not dirty. For instructions, see "Cleaning discs" on page 18.</li> <li>The disc may be incompatible with your player. Try another disc.</li> <li>Reset your player. For instructions, see "Resetting your player" on page 18.</li> </ul>
Audio or video pause during playback	<ul style="list-style-type: none"> <li>Make sure that the disc is not dirty. For instructions, see "Cleaning discs" on page 18.</li> <li>Reset your player. For instructions, see "Resetting your player" on page 18.</li> </ul>

Problem	Solution
The player is on and the logo and menu appear, but there is no image from the disc	<ul style="list-style-type: none"> <li>Make sure that the disc is not dirty. For instructions on cleaning a disc, see "Cleaning discs" on page 18.</li> <li>Reset your player. For instructions, see "Resetting your player" on page 18.</li> </ul>
The player freezes when reading a CD-R or DVD-R	<ul style="list-style-type: none"> <li>Reset your player. For instructions, see "Resetting your player" on page 18. When you see "loading" on the screen, press ▲ (open/close) to open the disc tray and remove the disc. Clean the disc. (For instructions, see "Cleaning discs" on page 18), then try the disc again.</li> <li>If your player freezes again, the disc may contain some content that is not compatible with your player. Do not try playing the disc with your player.</li> </ul>

## TV screen and video

Problem	Solution
Video does not appear on the TV screen or the picture is distorted	<ul style="list-style-type: none"> <li>Make sure that the TV is connected to the correct jacks on the back of your player.</li> <li>Make sure that the TV is set to the correct video input source.</li> <li>The TV may be in screen saver mode. Check the documentation that came with the TV for instructions about "waking" your TV.</li> <li>Reset your player. For instructions, see "Resetting your player" on page 18.</li> </ul>
Video is not output in high definition	<ul style="list-style-type: none"> <li>High definition video cannot be output through the VIDEO OUT jack. You must connect the TV to your player using the COMPONENT OUT jacks or HDMI jack.</li> <li>Make sure that the correct HDMI or component video resolution has been selected in the Setup menu. See "Selecting the video output resolution" on page 12.</li> <li>Depending on the Blu-ray Disc, output from the COMPONENT VIDEO OUT jacks may be restricted to 480p.</li> </ul>
The 4:3 aspect ratio picture expands left and right or the picture size is incorrect	<ul style="list-style-type: none"> <li>Use the TV to change the aspect ratio. See the documentation that came with the TV.</li> <li>When using a component video cable, set <b>TV Aspect</b> to <b>4:3 Pan &amp; Scan</b>.</li> </ul>

Problem	Solution
There is no apparent change in the picture quality when the picture settings are changed in the <i>Setup</i> menu	<ul style="list-style-type: none"> <li>Depending on the video type, changes may not be apparent.</li> </ul>
When playing a BD-Live disc, the screen is black	<ul style="list-style-type: none"> <li>Erase BD Storage. See "Erasing BD-Live storage" on page 15.</li> <li>Make sure that your Internet connection is working.</li> <li>Make sure that the Internet cable is connected securely and correctly to your player and the Internet jack. Some discs require an Internet connection to play.</li> </ul>

## HDMI connections

Problem	Solution
The 4:3 aspect ratio picture expands left and right or the picture size is incorrect	<ul style="list-style-type: none"> <li>Change <b>TV Aspect</b> to <b>16:9</b>. See "Selecting the TV aspect ratio" on page 12.</li> </ul>

## BD-Live and USB connections

Problem	Solution
Cannot connect to the Internet	<ul style="list-style-type: none"> <li>Make sure that the BD-Live Disc you are using is a legal copy.</li> <li>Make sure that the USB flash drive is connected correctly and securely.</li> <li>Make sure that the network connection is working.</li> </ul>
After connecting to the Internet, cannot download a file	<ul style="list-style-type: none"> <li>Erase BD Storage. See "Erasing BD-Live storage" on page 15.</li> <li>Make sure that the Internet connection is working.</li> <li>Try a different USB flash drive.</li> </ul>
File was downloaded, but playback from file pauses	<ul style="list-style-type: none"> <li>Make sure that the USB flash drive is a USB 2.0 device. Using a USB 1.1 device may cause pausing.</li> <li>Try a different USB flash drive.</li> </ul>

## Other playback problems

Problem	Solution
Audio and video pause momentarily	<ul style="list-style-type: none"> <li>This happens when your player is changing chapters in a playlist.</li> <li>When playing a disc that is recorded on both layers, audio and video may pause when your player is changing layers.</li> </ul>
Blu-ray Disc or DVD does not play	<ul style="list-style-type: none"> <li>Make sure that the disc has the correct region code.</li> <li>Check the rating on the disc. You may have set parental controls to block that rating.</li> <li>Some Blu-ray discs will only play over an HDMI connection.</li> </ul>
Picture-in-Picture (PIP) does not work on a Blu-ray Disc	<ul style="list-style-type: none"> <li>Make sure that the disc supports PIP mode.</li> </ul>
No subtitles	<ul style="list-style-type: none"> <li>Turn on subtitles. See "Selecting the subtitle language" on page 11.</li> <li>Make sure that the disc was recorded with subtitles. If the disc has subtitles, a subtitle option should appear on the disc's menu.</li> </ul>
Cannot change the viewing angle	<ul style="list-style-type: none"> <li>Some discs are not recorded with multiple viewing angles. Check the documentation that came with the disc.</li> <li>Not all scenes on a disc have multiple viewing angles. Check the documentation that came with the disc.</li> </ul>
Resume function does not work	<ul style="list-style-type: none"> <li>If you press <b>■</b> (stop) twice, the resume information is erased.</li> <li>Some discs do not support the resume function.</li> </ul>



# Specifications

Specifications are subject to change without notice.

## System and outputs

Media	BD-ROM, BD-JAVA 1.1, DVD-Video, DVD+RW/+R, DVD-RW/-R, CD-RW/-R
TV signal system	NTSC
Video output	Electric level output: 1.0 Vp-p Resistance: 75S Output connector: Pin jack (1 system)
Component video (Y, CB,CR)	Y output level: 1.0 Vp-p Resistance: 75 PB output level: 0.7 Vp-p Resistance: 75 PR output level: 0.7 Vp-p Resistance: 75 Output connector: Pin jack (Y: green, PB: blue, PR: red)(1 set) Output format: 480i, 480p, 720p, 1080i
Audio output (analog)	Output level: 2 Vrms (1 kHz, 0 dB) Output connector: Pin jack Number of connectors: 2-channel (1)
Audio output (digital)	Optical digital output (1) Coaxial digital output (pin jack) (1)
Audio performance (frequency response)	DVD (linear audio): <ul style="list-style-type: none"> <li>4 Hz to 22 kHz (48 kHz sampling)</li> <li>4 Hz to 44 kHz (96 kHz sampling)</li> </ul> CD-Audio: 4 Hz to 20 kHz S/N ratio: 90 dB Dynamic range: 80 dB Total harmonic distortion: 0.004%
HDMI output	Output format: 480i, 480p, 720p, 1080i, 1080p Output Connector: Type A (19 pin)

## General

Power	110V-120V ~ 50/60Hz
Power consumption	25 W
Dimensions L x W x H	16.93 x 10.0 x 1.89 inches (430 x 254 x 48 mm)
Weight	7.5 lbs. (3.4 kg)
Operating temperature	41°F to 95°F (5°C to 35°C)
Operating humidity	10% to 75%

## Video file requirement (USB/DISC)

Video file compatibility with your player is limited as follows:

- Available resolution size: 1920x1080 (W x H) pixels
- File extensions: .wmv
- Playable Audio format: Dolby Digital , DTS , MP3 , WMA , AAC , AC3
- Sampling frequency: within 32 to 48kHz (WMA), within 16-48kHz (Mp3)
- Bit rate: within 20-320kbps (WMA), within 32-320kbps (Mp3)
- CD-R/RW, DVD R/RW, BD-R/RE Format: ISO 9660+JOLIET, UDF and UDF Bridge format
- Maximum Files/Folder: Less than 2000. The movie file name and subtitle are limited to 180 characters.
- Not all of the WMA and AAC Audio formats are compatible with your player.

- HD movie files contained on a 1.0/1.1 CD or USB flash drive may not play correctly. Blu-ray, DVD, or USB 2.0 are recommended to play back HD movie files.
- Your player does not support files that are recorded with GMC (Global Motion Compensation) or Qpel (Quarter pixel). Those are video encoding techniques in MPEG4 standard, like DivX or XVID.

## MP3/WMA audio file requirement (USB/DISC)

- File extensions: .mp3, .wma
- Sampling frequency: Within 8 to 48kHz (WMA), within 11 to 48kHz (Mp3)
- Bit rate: Within 8-320kbps (WMA, Mp3)
- CD-R/RW, DVD R/RW, BD-R/RE Format: ISO 9660+JOLIET, UDF and UDF Bridge format
- Maximum Files/Folder: Less than 2000 (total number of files and folders)
- Depending on the size and number of the MP3/WMA files, it may take several minutes to read the contents of the media.
- Your player does not support the ID3 Tag embedded in the MP3 file.
- The total playback time indicated on the screen may not correct for VBR files.

## Photo file requirement (USB/DISC)

- File extensions: .jpg , .jpeg , .png
- Recommended size:
  - Less than 4,000 x 3,000 x 24 bit/pixel
  - Less than 3,000 x 3,000 x 32 bit/pixel
- CD-R/RW, DVD R/RW, BD-R/RE Format: ISO 9660+JOLIET, UDF, and UDF Bridge format
- Maximum Files/Folder: Less than 2000 (total number of files and folders)
- Progressive and lossless compression photo image files are not supported.
- Depending on the size and number of the photo files, it may take several minutes to read the contents of the media.

# Legal notices

### FCC Part 15

This device complies with Part 15 of the FCC Rules. Operation of this product is subject to the following two conditions: (1) this device may not cause harmful interference, and (2) this device must accept any interference received, including interference that may cause undesired operation.

This equipment has been tested and found to comply within the limits for a class B digital device, pursuant to Part 15 of the FCC Rules. These limits are designed to provide reasonable protection against harmful interference in a residential installation. This equipment generates, uses, and can radiate radio frequency energy and, if not installed and used in accordance with the instructions, may cause harmful interference to radio communications. However, there is no guarantee that interference will not occur in a particular installation. If this equipment does cause harmful interference to radio or television reception, which can be determined by turning the equipment off and on, the user is encouraged to try to correct the interference by one or more of the following measures:

- Reorient or relocate the receiving antenna.
- Increase the separation between the equipment and receiver.
- Connect the equipment into an outlet on a circuit different from that to which the receiver is connected.
- Consult the dealer or an experienced technician for help.

**FCC warning**

Changes or modifications not expressly approved by the party responsible for compliance with the FCC Rules could void the user's authority to operate this equipment.

**DHHS and FDA safety certification**

This product is made and tested to meet safety standards of the FCC, requirements and compliance with safety performance of the U.S. Department of Health and Human Services, and also with FDA Radiation Performance Standards 21 CFR Subchapter J.

**Canada ICES-003 statement**

This Class B digital apparatus complies with Canadian ICES-003.

**Macrovision**

This product incorporates copyright protection technology that is protected by U.S. patents and other intellectual property rights. Use of this copyright protection technology must be authorized by Macrovision, and is intended for home and other limited viewing uses only unless otherwise authorized by Macrovision. Reverse engineering or disassembly is prohibited.

**Dolby Laboratories**

Manufactured under license from Dolby Laboratories. Dolby and the double-D symbol are trademarks of Dolby Laboratories.

**DTS, Inc.**

Manufactured under license under U.S. Patent #'s: 5,451,942; 5,956,674; 5,974,380; 5,978,762; 6,487,535 & other U.S. and worldwide patents issued & pending. DTS is a registered trademark and the DTS logos, symbol, DTS-HD and DTS-HD Advanced Digital Out are trademarks of DTS, Inc. 1996-2008 DTS, Inc. All rights reserved.

## One-year limited warranty

Insignia Products ("Insignia") warrants to you, the original purchaser of this new product ("Product"), that the Product shall be free of defects in the original manufacture of the material or workmanship for a period of one (1) year from the date of your purchase of the Product ("Warranty Period"). This Product must be purchased from an authorized dealer of Insignia brand products and packaged with this warranty statement. This warranty does not cover refurbished Product. If you notify Insignia during the Warranty Period of a defect covered by this warranty that requires service, terms of this warranty apply.

### How long does the coverage last?

The Warranty Period lasts for 1 year (365 days) from the date you purchased the Product. The purchase date is printed on the receipt you received with the Product.

### What does this warranty cover?

During the Warranty Period, if the original manufacture of the material or workmanship of the Product is determined to be defective by an authorized Insignia repair center or store personnel, Insignia will (at its sole option): (1) repair the Product with new or rebuilt parts; or (2) replace the Product at no charge with new or rebuilt comparable products or parts. Products and parts replaced under this warranty become the property of Insignia and are not returned to you. If service of Products or parts are required after the Warranty Period expires, you must pay all labor and parts charges. This warranty lasts as long as you own your Insignia Product during the Warranty Period. Warranty coverage terminates if you sell or otherwise transfer the Product.

### How to obtain warranty service?

If you purchased the Product at a retail store location, take your original receipt and the Product to the store you purchased it from. Make sure that you place the Product in its original packaging or packaging that provides the same amount of protection as the original packaging. If you purchased the Product from an online web site, mail your original receipt and the Product to the address listed on the web site. Make sure that you put the Product in its original packaging or packaging that provides the same amount of protection as the original packaging.

To obtain in-home warranty service for a television with a screen 30 inches or larger, call 1-888-BESTBUY. Call agents will diagnose and correct the issue over the phone or will have an Insignia-approved repair person dispatched to your home. Should the Insignia-approved repair person not correct the issue on the first call, an Insignia television (size and features to be determined by Insignia) will be loaned to you until your TV is repaired and returned, at no charge to you. This feature is only available to Insignia television consumers residing in the United States.

### Where is the warranty valid?

This warranty is valid only to the original purchaser of the product in the United States, Canada, and Mexico.

### What does the warranty not cover?

This warranty does not cover:

- Customer instruction
- Installation
- Set up adjustments
- Cosmetic damage
- Damage due to acts of God, such as lightning strikes
- Accident
- Misuse
- Abuse
- Negligence
- Commercial use
- Modification of any part of the Product, including the antenna
- Plasma display panel damaged by static (non-moving) images applied for lengthy periods (burn-in).

This warranty also does not cover:

- Damage due to incorrect operation or maintenance
- Connection to an incorrect voltage supply
- Attempted repair by anyone other than a facility authorized by Insignia to service the Product
- Products sold as is or with all faults
- Consumables, such as fuses or batteries
- Products where the factory applied serial number has been altered or removed

REPAIR REPLACEMENT AS PROVIDED UNDER THIS WARRANTY IS YOUR EXCLUSIVE REMEDY. INSIGNIA SHALL NOT BE LIABLE FOR ANY INCIDENTAL OR CONSEQUENTIAL DAMAGES FOR THE BREACH OF ANY EXPRESS OR IMPLIED WARRANTY ON THIS PRODUCT, INCLUDING, BUT NOT LIMITED TO, LOST DATA, LOSS OF USE OF YOUR PRODUCT, LOST BUSINESS OR LOST PROFITS. INSIGNIA PRODUCTS MAKES NO OTHER EXPRESS WARRANTIES WITH RESPECT TO THE PRODUCT, ALL EXPRESS AND IMPLIED WARRANTIES FOR THE PRODUCT, INCLUDING, BUT NOT LIMITED TO, ANY IMPLIED WARRANTIES OF AND CONDITIONS OF MERCHANTABILITY AND FITNESS FOR A PARTICULAR PURPOSE, ARE LIMITED IN DURATION TO THE WARRANTY PERIOD SET FORTH ABOVE AND NO WARRANTIES, WHETHER EXPRESS OR IMPLIED, WILL APPLY AFTER THE WARRANTY PERIOD. SOME STATES, PROVINCES AND JURISDICTIONS DO NOT ALLOW LIMITATIONS ON HOW LONG AN IMPLIED WARRANTY LASTS, SO THE ABOVE LIMITATION MAY NOT APPLY TO YOU. THIS WARRANTY GIVES YOU SPECIFIC LEGAL RIGHTS, AND YOU MAY ALSO HAVE OTHER RIGHTS, WHICH VARY FROM STATE TO STATE OR PROVINCE TO PROVINCE.

Contact Insignia:

For customer service please call 1-877-467-4289  
www.insigniaproducts.com

Distributed by Best Buy Purchasing, LLC  
7601 Penn Avenue South, Richfield, Minnesota, U.S.A.  
55423-3645

© 2009 Best Buy Enterprise Services, Inc.  
All rights reserved. INSIGNIA is a trademark of Best Buy Enterprise Services, Inc. Registered in some countries. All other products and brand names are trademarks of their respective owners.



[www.insigniaproducts.com](http://www.insigniaproducts.com) (877) 467-4289

Distributed by Best Buy Purchasing, LLC  
7601 Penn Avenue South, Richfield, MN USA 55423-3645  
© 2009 Best Buy Enterprise Services, Inc.

All rights reserved. INSIGNIA is a trademark of Best Buy Enterprise Services, Inc. Registered in some countries.  
All other products and brand names are trademarks of their respective owners.

ENGLISH  
09-0844

## Free Manuals Download Website

<http://myh66.com>

<http://usermanuals.us>

<http://www.somanuals.com>

<http://www.4manuals.cc>

<http://www.manual-lib.com>

<http://www.404manual.com>

<http://www.luxmanual.com>

<http://aubethermostatmanual.com>

Golf course search by state

<http://golfingnear.com>

Email search by domain

<http://emailbydomain.com>

Auto manuals search

<http://auto.somanuals.com>

TV manuals search

<http://tv.somanuals.com>