

**User Guide**  
**7" Digital Picture Frame**

**INSIGNIA™**

**NS- DPF0712G**



# 7" Digital Picture Frame

## Contents

<b>Introduction</b> .....	<b>2</b>
<b>Safety information</b> .....	<b>3</b>
<b>Features</b> .....	<b>4</b>
<b>Setting up your picture frame</b> .....	<b>10</b>
<b>Using your picture frame</b> .....	<b>13</b>
<b>Maintaining</b> .....	<b>28</b>
<b>Troubleshooting</b> .....	<b>29</b>
<b>Specifications</b> .....	<b>30</b>
<b>Legal notices</b> .....	<b>31</b>
<b>6-month limited warranty</b> .....	<b>33</b>

## Introduction

Congratulations on your purchase of a high-quality Insignia product. Your new digital picture frame is designed for reliable and trouble-free performance.

## Safety information

Always follow these basic safety precautions when using your digital picture frame. This will reduce the risk of fire, electric shock, and injury.

### Warnings

To reduce the risk of fire or shock hazard, do not expose the frame to rain or moisture and unplug the frame during lightning storms.

To prevent the risk of electric shock, do not remove the cover. There are no user-serviceable parts inside. Refer all servicing to qualified personnel.

There is a risk of explosion if the battery is incorrectly replaced. Replace only with the same or equivalent type of battery.

**Placement**—To prevent fire or electric shock, do not expose this digital picture frame to rain or moisture. To prevent it from falling do not place it on an unstable cart, stand, tripod, bracket, or table. Keep the unit away from strong magnets, heat sources, direct sunlight, and excessive dust.

**Installation**—Make sure that the digital picture frame is used in accordance with the instructions and illustrations provided in this manual.

**Objects and liquids**—Do not push objects of any kind into the digital picture frame through openings. Do not spill or spray liquid of any kind on or in the digital picture frame (this may result in a fire or electric shock). Do not place anything heavy on the unit. To ensure proper ventilation and proper operation, never cover or block the slots and openings with a cloth or other material.

**Disassembly**—Do not attempt to disassemble the frame. There is a risk of electric shock. Contact qualified service personnel if your digital picture frame is in need of repair.

**Cleaning the digital picture frame**—When cleaning, make sure the frame is unplugged from the power source. Use the supplied cleaning cloth, or a cloth slightly dampened with water for cleaning the exterior of the frame only.

## Features

- Displays digital pictures (JPEG format) and picture slideshows without a computer
- Displays pictures directly from an inserted portable memory device (not included)
- Bright, clear TFT LCD screen
- Compatible with a wide variety of memory cards, including:
  - Secure Digital™ (SD)
  - SDHC™
  - MultimediaCard (MMC™)
  - Memory Stick®
  - Memory Stick Pro Duo™ (requires an adapter - not included)
  - xD™
  - microSD™ (requires an adapter - not included)
- Compatible with USB flash drives
- Mini-USB port to connect the digital picture frame to your PC
- Multi-image mode displays multiple pictures at the same time in a slideshow
- Auto Rotate—pictures are rotated based on your photos' embedded EXIF data

**Note**

EXIF (Exchangeable Image File) data is information stored by a digital camera as it records a photo. This information includes what orientation the camera is in when a photo is captured.

- On-frame button controls and infrared remote control
- 128 MB internal memory

## Package contents

- Digital picture frame
- AC power adapter
- USB cable
- *User Guide*
- *Quick Setup Guide*
- Remote control with battery (CR2025)
- Cleaning cloth

## Back

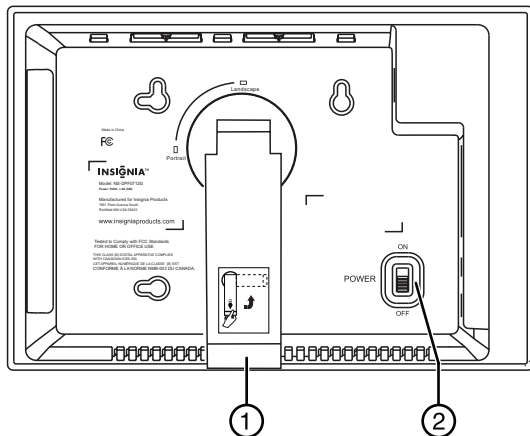

#	Description
1	Adjustable stand
2	Power On/Off switch

## Sides

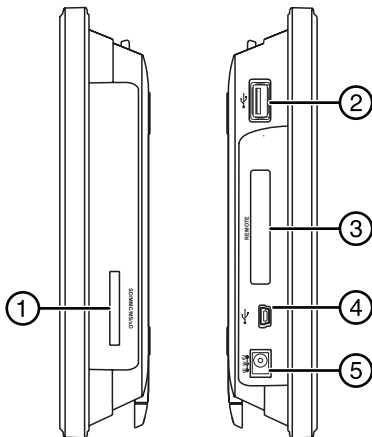

#	Description
1	Memory card slot, supports: <ul style="list-style-type: none"> <li>• Secure Digital™ (SD)</li> <li>• SDHC™</li> <li>• MultimediaCard (MMC™)</li> <li>• Memory Stick®</li> <li>• Memory Stick Pro Duo™ (requires an adapter - not included)</li> <li>• xD™</li> <li>• microSD™ (requires an adapter - not included)</li> </ul>
2	USB (type A) port
3	Remote control slot
4	Mini USB port
5	DC 5 V power connector

## Top (buttons)

You can access most of the frame's features by using either the buttons on top of the frame or by using the remote control. Selecting files for copying, deleting, or viewing requires the remote control, and the instructions in this guide refer to remote control buttons (except where noted).

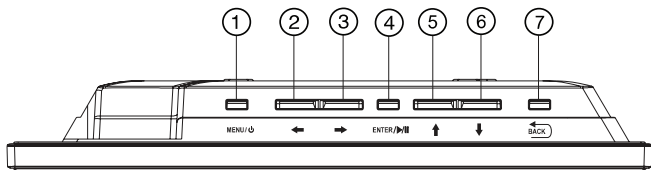





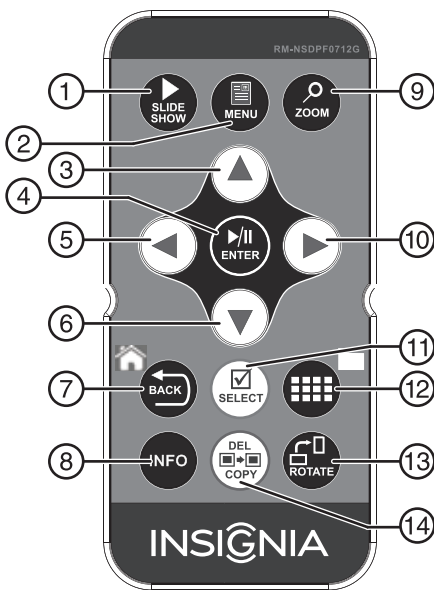

#	Button	Description
1	MENU/⏻	To open the setup menu, quickly press and release. To enter Standby mode, press and hold for two seconds.
2	← (left)	Press to move the menu selection left or to display the previous picture.
3	→ (right)	Press to move the menu selection right or to display the next picture.
4	ENTER/▶/⏸	Press to select menu items. During a slideshow, press to pause or resume.
5	↑ (up)	Press to navigate up.
6	↓ (down)	Press to navigate down.
7	← BACK	Go back to previous selection or screen.

## Remote control



#	Button	Description
1	▶ SLIDESHOW	Press to start a slideshow.
2	☰ MENU	Press to display the setup menu.
3	▲ (Up)	Press to move the selection up.
4	▶/   ENTER	Press to select the highlighted option or to pause and resume the slideshow.



#	Button	Description
5	◀ (Left) PREV	Press to move the menu selection left, display the previous picture, or select the previous file.
6	▼ (Down)	Press to move the menu selection down.
7	 BACK	Press to go back a screen.
8	INFO	Press to display information about the picture.
9	 ZOOM	Press to magnify the picture.
10	▶ (Right) NEXT	Press to move the menu selection right, display the next picture, or select the next file.
11	 SELECT	Press to select a picture or file to copy or delete.
12	 (thumbnail/ folder)	Press to enter Thumbnail mode or to display files and folders.
13	 ROTATE	Press to rotate the picture.
14	 DEL/COPY	When reviewing pictures from <b>internal</b> memory, press to delete selected pictures. When reviewing pictures from an <b>external</b> , portable memory device, press to copy selected pictures. <b>Note:</b> Pressing this button does not delete photos on the portable memory device.

# Setting up your picture frame

## Setting up the remote control

### To set up the remote control:

- Remove the plastic tab that extends past the bottom edge of the remote control. This tab protects the battery. The remote control will not work until it is removed.



## Setting up the frame

### To set up the frame:

- 1** Pull out the stand to set the frame in landscape orientation.
- 2** Turn the stand counterclockwise 90° if you want to set the frame in portrait orientation.

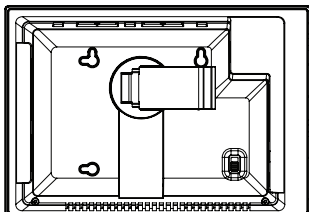
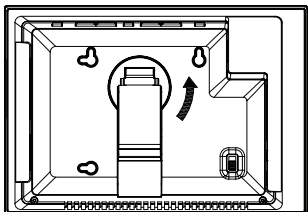

- 3** Extend the stand from the back of the frame, then place the frame on a flat surface. Gently push or pull the stand to adjust the viewing angle.

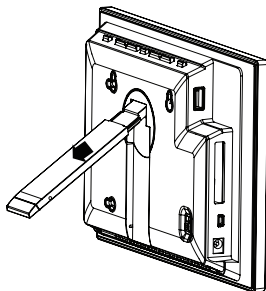

- 4 Plug the AC power adapter into the frame's DC power connector and into an AC power outlet.

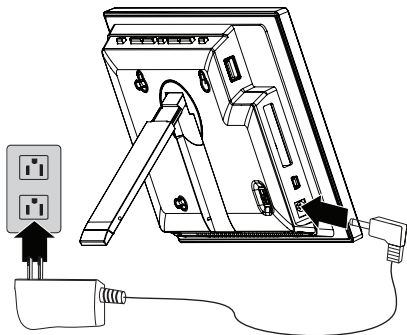

- 5 Slide the power switch to the **ON** position. The frame automatically turns on and starts playing a slideshow of the pictures stored in internal memory. This slideshow is called Demo mode.

To turn off Demo mode, point the remote control at the front of the frame and press ►/|| **ENTER**.

**Tip**

You can also disable and re-enable Demo mode from the menu. For instructions, see "Setup options" on page 25.

## Using your picture frame

You can use your digital picture frame to:

- Play a slideshow of pictures
- Adjust a picture's view
- Change display settings

## Playing slideshows

### To play an instant slideshow from a portable memory device:

- 1 Insert a portable memory device into one of the available memory slots or the USB port.  
A slideshow of pictures from the portable memory device automatically starts to play.

#### Caution

Memory cards fit into the card slots in only one direction. The label side of the card should face the screen. Do not force a memory card into a slot. The card should fit snugly when inserted correctly. Some cards require an adapter to fit correctly. For more information on supported memory cards, see "Specifications" on page 30.

- 2 Press **ENTER/▶/||** to pause the slideshow on a particular picture. Press **ENTER/▶/||** again to resume the slideshow.

## To manually play a slideshow from an inserted portable memory device or from internal memory:

- 1 If the pictures you want to use are on a portable memory device, insert the device into one of the available memory slots or the USB port. A slideshow of pictures from the portable memory device automatically starts to play.
- 2 Press **BACK** (BACK) repeatedly until the *Home* menu opens.



- 3 Press **◀** or **▶** to select a portable memory device or internal memory, then press **ENTER/▶/||**.

### Note

The option to select a portable memory device is disabled if there is no device of that type in the corresponding slot or port.

- 4 Press **▶ SLIDESHOW**. A slideshow begins that displays the pictures contained in the portable memory device or internal memory.

### Tip

Press **▶ SLIDESHOW** during a slideshow to switch to multi-image slideshow mode. Press **▶ SLIDESHOW** again to return to single-image display mode.

## Copying pictures to internal memory

You can copy a single picture, multiple pictures, or all pictures from an inserted portable memory device to the frame's internal memory.

### Notes

Using the frame alone, you cannot copy pictures from the internal memory to an inserted portable memory device, and you cannot copy pictures from one inserted portable memory device to another.

Because you cannot copy pictures back from the frame to a portable memory device using the frame, the frame should not be considered your primary picture storage method. Make sure that you have the pictures stored elsewhere (such as a memory card).

### To copy selected pictures from a portable memory device:

- 1 Press **BACK** (BACK) repeatedly until the *Home* menu opens.



- 2 Press ◀ or ▶ to highlight the portable memory device you want to copy from, then press **ENTER/▶/||**. The *Thumbnail* screen opens.



**Tip**

You can press  (thumbnail/file list) to switch between thumbnail mode and file list mode. Thumbnail mode displays all files in the selected portable memory device, and file list mode displays files and folders.

- 3 Press ◀ or ▶ to highlight each picture you want to copy, then press  **SELECT** to mark it. A check mark appears in the upper-right corner of each marked thumbnail. Mark as many pictures as you want to copy.





- 4 Press   **DEL/COPY**, then press **▲** or **▼** to select **Copy Selected** (to copy the pictures you select) or **Copy All** (to copy all pictures).
- 5 Press **▶**, press **▲** or **▼** to select **Yes**, then press **ENTER/▶/||**. The pictures are copied.

### To copy pictures from your PC to internal memory or portable memory device:

- 1 Make sure that your computer has been started before you begin.
- 2 Connect the mini plug of the supplied USB cable to the mini USB port on the digital picture frame, then connect the other end to an available USB port on your computer.

**Note**

The frame displays the message "PC connection established. Remote is temporarily inoperative!".

- 3 Navigate to "Computer" or "My Computer" (Windows operating systems). The frame's internal memory and any inserted portable memory devices appear as "removable disks." Each memory area appears as a separate removable disk.  
On a Mac computer, the frame's internal memory or an external, inserted portable memory device appears as a USB drive.
- 4 Use your computer's standard drag and drop or copy and paste procedures to move pictures on your computer to the frame's internal memory or a portable memory device you inserted in the frame.

## To copy pictures from your internal memory or inserted portable memory device to your computer:

- 1 Make sure that your computer has been started before you begin.
- 2 Connect the mini plug of the supplied USB cable to the mini USB port on the digital picture frame, then connect the other end to an available USB port on your computer.

**Note**

The frame displays the message "PC connection established. Remote is temporarily inoperative!".

- 3 Navigate to "Computer" or "My Computer" (Windows operating systems). The frame's internal memory and any inserted portable memory devices appear as "removable disks." Each memory area appears as a separate removable disk.  
On a Mac computer, the frame's internal memory or an external, inserted portable memory device appears as a USB drive.
- 4 Use your computer's standard drag and drop or copy and paste procedures to move pictures from the frame's internal memory or an inserted portable memory device to your computer.

## Deleting pictures from internal memory

**Note**

You cannot delete pictures from an inserted portable memory device. The frame should not be considered your primary picture storage method. Make sure that you have the pictures stored elsewhere (such as a memory card).

### To delete pictures from internal memory:

- 1 Press  (**BACK**) until the *Home* menu opens.



- 2 Press  or  to highlight **Internal Memory**, then press **ENTER**//||. The *Thumbnail* screen opens.



- 3 Press ◀/▶/▲/▼ to highlight each picture you want to delete, then press  **SELECT** to mark it. A check mark appears in the upper-right corner of each marked thumbnail. Mark as many pictures as you want to delete.



- 4 Press  →  **DEL/COPY**, then press ▲ or ▼ to select **Delete Selected** (to delete only the pictures you select) or **Delete All** (to delete all pictures in memory).
- 5 Press ▶ to open the submenu, press ▲ or ▼ to select **Yes**, then press **ENTER/▶/||**. The pictures are deleted.

### To delete pictures with your computer:

- 1 Make sure that your computer is on before you begin.
- 2 Connect the mini plug of the supplied USB cable to the mini USB port on the digital picture frame, and connect the other end to an available USB port on your computer.
- 3 Navigate to "Computer" or "My Computer" (Windows operating systems). The frame's internal memory and any inserted portable memory devices appear as "removable disks." Each memory area appears as a separate removable disk.  
On a Mac computer, the frame's internal memory or an external, inserted portable memory device appears as a USB drive.

- 4 Find and highlight the pictures you want to delete, then use your computer's standard procedures to delete pictures from the frame's internal memory or an inserted portable memory device.

## Customizing slideshows

You can set up a slideshow using either all of the pictures or selected pictures.

### To set up a slideshow of selected pictures:

**Tip**

A slideshow of selected pictures can only be set up by using the remote control.

- 1 Press  (thumbnails).

- OR -

If a slideshow is in progress, press  (**BACK**) to access the thumbnail screen. The *Thumbnails* screen opens.



- 2 Press ◀ or ▶ to highlight the picture you want to include in the slideshow, then press  **SELECT**. A check mark appears at the upper-right corner of the thumbnail.



- 3 Repeat until all pictures you want to add to the slideshow are selected.
- 4 Press  →  **DEL/COPY**, then press ▲ or ▼ to select **Play Selected**.
- 5 Press ▶ to open the submenu, press ▲ or ▼ to select **Yes**, then press **ENTER/▶/||**. A slideshow of the selected pictures is played.
- 6 To end the slideshow and clear the selected items, press  (BACK). This returns you to the *Thumbnail* screen. From there, you can select a photo to view or begin another slideshow.





## Customizing the picture display

You can rotate, magnify, and display information about any picture that the frame displays.

### To rotate a picture:

- 1 While a picture is displayed full screen (not as a thumbnail), press  **ROTATE**. The picture is rotated 90° clockwise with each press of the button.
- 2 Press **ENTER/▶/||** to continue the slideshow.

### To rotate a picture based on frame orientation

- 1 While a picture is displayed full screen (not as a thumbnail), use the adjustable stand to set the frame in landscape orientation or turn the stand counter-clockwise by 90° to set the frame in the portrait orientation.
- 2 Press  **MENU**, then press  to select **Frame Orientation**, then press **ENTER/▶/||**.
- 3 Press  or  to select **Landscape** or **Portrait**, then press **ENTER/▶/||**. Pictures are rotated based on the **Frame Orientation** setting.
- 4 To start the slideshow, press **ENTER/▶/||**.

### To magnify a picture:

- 1 While a picture is displayed full screen (not a thumbnail), press  **ZOOM**. The picture is magnified in size each time you press the button (there are three zoom levels), until it returns to the normal size.

**Tip**

While the picture is magnified, press the arrow buttons to pan the picture so you can see the different parts that are off the screen.

- 2 Press **ENTER/▶/||** to continue the slideshow. The next picture is displayed at normal size.

## Setting viewing options

You can change all of the viewing options in the *Setup* menu using the buttons on the top of the frame or on the remote control. You can display the *Setup* menu at any time by pressing **MENU**. Only the available setup options are displayed for each menu.

### To set viewing options:

- 1 Press **BACK** (BACK) until the *Home* menu opens.



- 2 Press the arrow buttons to highlight the **SETUP** icon, then press **ENTER/▶/||**. The *Setup* menu opens.
- 3 Press **▲** or **▼** to highlight a display option, then press **ENTER/▶/||** to select the option. A second menu opens, listing the available settings. A square icon (■) to the right of an option shows the current setting.
- 4 Press **▲** or **▼** to highlight a setting, then press **ENTER/▶/||** to select the setting.
- 5 When you are finished, press **BACK** (BACK) to close the *Setup* menu and return to the previous screen.



## Setup options

The following table lists and describes setup menu options:

Menu option	Settings	Description
Slideshow Settings	Slideshow interval <ul style="list-style-type: none"> <li>• 5 Seconds</li> <li>• 10 Seconds</li> <li>• 30 Seconds</li> <li>• 60 Seconds</li> <li>• 60 Minutes</li> <li>• 24 Hours</li> </ul>	Sets the interval between each picture transition in a slideshow.
	Slideshow transition <ul style="list-style-type: none"> <li>• Normal</li> <li>• Random</li> <li>• Fade</li> <li>• Curtain</li> <li>• Left-Right</li> <li>• Curtain Top-Bottom</li> <li>• Open-Door</li> <li>• Cross-Comb</li> <li>• Cross-Fade</li> </ul>	Sets the special effects used to transition from one picture to the next in a slideshow. The <b>Normal</b> setting plays slideshows without any special transition effects. The <b>Random</b> setting cycles through the available special transition effects during slideshows.
	Slideshow shuffle <ul style="list-style-type: none"> <li>• On</li> <li>• Off</li> </ul>	Displays pictures in a different (random) order than they appear on the portable memory device.
	Date/Time stamp <ul style="list-style-type: none"> <li>• On</li> <li>• Off</li> </ul>	Displays the date and time that a picture was taken. This feature is not available in multi-image display mode.
	Color Enhancement <ul style="list-style-type: none"> <li>• On</li> <li>• Off</li> </ul>	Corrects colors in the image.

Menu option	Settings	Description
Slideshow Settings (continued)	Panorama Scroll <ul style="list-style-type: none"><li>• On</li><li>• Off</li></ul>	When Panorama Scroll is enabled, pictures that were taken in panorama mode are scrolled across the screen during slideshows rather than resized to fit the screen.
Frame Orientation	Landscape Portrait	Changes the display orientation of images.
Image display format	Normal Zoom Wide Cinema	Adjusts how the image is sized to fit the screen. If the pictures you are viewing are in 4:3 format, they will have black bars on the sides of the screen with the <b>Normal</b> setting enabled. Selecting one of the other modes hides the black bars by zooming in on the image and cropping it.
Copy type	Normal	Maintains the picture's original resolution when a picture file is copied from a portable memory device to the frame's internal memory.
	Resize	Optimizes (resizes) a picture file when it is copied from a portable memory device to the frame's internal memory. Enabling this feature lets you store more files in your frame's internal memory. Using this setting lets you store the maximum number of pictures in your frame's internal memory.

<b>Menu option</b>	<b>Settings</b>	<b>Description</b>
Power saving	Off 15 Minutes 30 Minutes 1 Hour 2 Hours 4 Hours	Sets the power save option. If the buttons on the frame or remote control are not used for the specified time, the frame enters Power Saving (Standby) mode. To turn the frame back on, press any button on the frame.
Language	English Spanish French	Sets the language used in the setup menus.
Sort image mode	File name A-Z File name Z-A Date, oldest to newest Date, newest to oldest	Lets you sort files in the order you select.
Factory Settings	Demo Mode <ul style="list-style-type: none"> <li>• On</li> <li>• Off</li> </ul>	Displays pictures from internal memory for demo purposes.
	Reset All Settings <ul style="list-style-type: none"> <li>• No</li> <li>• Yes</li> </ul>	Resets all settings to factory default values.
	Erase Internal Memory <ul style="list-style-type: none"> <li>• No</li> <li>• Yes</li> </ul>	Erases all files from the internal memory.
	Software Version	Displays the software (firmware) version.

# Maintaining

## Cleaning the digital picture frame

Make sure the frame is unplugged from the power source. Use the supplied cleaning cloth, or a cloth slightly dampened with water for cleaning the exterior of the frame only.

## Replacing the remote control battery

### To replace the remote control battery:

- 1** Turn the remote control over.
- 2** While pressing down on the ridged area of the battery cover, slide the battery tray out and remove the old battery.
- 3** Place a new CR2025 (or equivalent) lithium battery in the tray, with the positive (+) side facing up.
- 4** Slide the battery tray back into the remote control.

# Troubleshooting

Problem	Solution
The frame will not turn on.	The power adapter is not securely connected to the picture frame, or the power switch is not on. Check power adapter connections, then switch the power on.
A portable memory device is inserted in the frame, but you can't view your pictures.	<ul style="list-style-type: none"> <li>• Make sure that the portable memory device is one of the supported formats and that the files on the device are JPEG image files.</li> <li>• Turn the digital picture frame off and make sure that the portable memory device is inserted all the way into the slot or port and is inserted correctly, then turn it back on. After a few seconds, you should see your first picture.</li> <li>• Try formatting the portable memory device.           <p><b>Caution:</b> Formatting the device erases all files on the device. Back up the files on the device to your computer before attempting to format the device.</p> </li> <li>• Some digital cameras save images in formats other than JPEG. Refer to your camera's manual for details.</li> </ul>
The frame displays some pictures more slowly than others.	Higher resolution pictures load more slowly. Try using lower resolution pictures or down-sampling (compressing or resizing) them. See your camera's user guide for instructions on down-sampling your pictures, or see "Setting viewing options" on page 24 for instructions on automatically resizing and compressing your pictures while copying from them from an inserted portable memory device to the frame's internal memory.

# Specifications

Screen size	7" (178 mm)
Screen format	Widescreen
Memory card formats	<ul style="list-style-type: none"><li>• Secure Digital™ (SD)</li><li>• SDHC™</li><li>• MultimediaCard (MMC™)</li><li>• Memory Stick</li><li>• Memory Stick PRO Duo™ (requires an adapter - not included)</li><li>• xD™</li><li>• microSD™ (requires adapter - not included)</li></ul>
File formats	Standard JPEG
USB	USB (type A) port and Mini-USB port
Power input	100 V~240 V AC, 50~60 Hz
Power output	5 V DC, 1 A
Certification	FCC/ICES-003 and CUL/International Efficiency Marking Level V (adapter)
Internal memory	128 MB

# Legal notices

## ***FCC Statement***

This equipment has been tested and found to comply with the limits for a Class B digital device, pursuant to part 15 of the FCC Rules. These limits are designed to provide reasonable protection against harmful interference in a residential installation. This equipment generates, uses and can radiate radio frequency energy and, if not installed and used in accordance with the instructions, may cause harmful interference to radio communications. However, there is no guarantee that interference will not occur in a particular installation. If this equipment does cause harmful interference to radio or television reception, which can be determined by turning the equipment off and on, the user is encouraged to try to correct the interference by one or more of the following measures:

- Reorient or relocate the receiving antenna.
- Increase the separation between the equipment and receiver.
- Connect the equipment into an outlet on a circuit different from that to which the receiver is connected.
- Consult the dealer or an experienced radio/TV technician for help.

## ***FCC Caution***

Changes or modifications not expressly approved by the part responsible for compliance could void the user's authority to operate the equipment.

## ***Image use restrictions***

Use of the images pre-loaded on the digital picture frame is limited to personal, non-commercial use. Consumer may not modify, duplicate, distribute, retransmit, republish, reproduce, or create derivative works from the pre-loaded images.

## ***Canada ICES-003 statement***

This Class B digital apparatus complies with Canadian ICES-003.





## 6-month limited warranty

Insignia Products ("Insignia") warrants to you, the original purchaser of this new NS-DPF0712G ("Product"), that the Product shall be free of defects in the original manufacture of the material or workmanship for a period of 6 months from the date of your purchase of the Product ("Warranty Period"). This Product must be purchased from an authorized dealer of Insignia brand products and packaged with this warranty statement. This warranty does not cover refurbished Product. If you notify Insignia during the Warranty Period of a defect covered by this warranty that requires service, terms of this warranty apply.

### ***How long does the coverage last?***

The Warranty Period lasts for 6 months from the date you purchased the Product. The purchase date is printed on the receipt you received with the Product.

### ***What does this warranty cover?***

During the Warranty Period, if the original manufacture of the material or workmanship of the Product is determined to be defective by an authorized Insignia repair center or store personnel, Insignia will (at its sole option): (1) repair the Product with new or rebuilt parts; or (2) replace the Product at no charge with new or rebuilt comparable products or parts. Products and parts replaced under this warranty become the property of Insignia and are not returned to you. If service of Products or parts are required after the Warranty Period expires, you must pay all labor and parts charges. This warranty lasts as long as you own your Insignia Product during the Warranty Period. Warranty coverage terminates if you sell or otherwise transfer the Product.

### ***How to obtain warranty service?***

If you purchased the Product at a retail store location, take your original receipt and the Product to the store you purchased it from. Make sure that you place the Product in its original packaging or packaging that provides the same amount of protection as the original packaging. If you purchased the Product from an online web site, mail your original receipt and the Product to the address listed on the web site. Make sure that you put the Product in its original packaging or packaging that provides the same amount of protection as the original packaging.

To obtain in-home warranty service for a television with a screen 25 inches or larger, call 1-888-BESTBUY. Call agents will diagnose and correct the issue over the phone or will have an Insignia-approved repair person dispatched to your home.

## **Where is the warranty valid?**

This warranty is valid only to the original purchaser of the product in the United States, Canada, and Mexico.

## **What does the warranty not cover?**

This warranty does not cover:

- Customer instruction
- Installation
- Set up adjustments
- Cosmetic damage
- Damage due to acts of God, such as lightning strikes
- Accident
- Misuse
- Abuse
- Negligence
- Commercial use
- Modification of any part of the Product, including the antenna
- Plasma display panel damaged by static (non-moving) images applied for lengthy periods (burn-in).

This warranty also does not cover:

- Damage due to incorrect operation or maintenance
- Connection to an incorrect voltage supply
- Attempted repair by anyone other than a facility authorized by Insignia to service the Product
- Products sold as is or with all faults
- Consumables, such as fuses or batteries
- Products where the factory applied serial number has been altered or removed

REPAIR REPLACEMENT AS PROVIDED UNDER THIS WARRANTY IS YOUR EXCLUSIVE REMEDY. INSIGNIA SHALL NOT BE LIABLE FOR ANY INCIDENTAL OR CONSEQUENTIAL DAMAGES FOR THE BREACH OF ANY EXPRESS OR IMPLIED WARRANTY ON THIS PRODUCT, INCLUDING, BUT NOT LIMITED TO, LOST DATA, LOSS OF USE OF YOUR PRODUCT, LOST BUSINESS OR LOST PROFITS. INSIGNIA PRODUCTS MAKES NO OTHER EXPRESS WARRANTIES WITH RESPECT TO THE PRODUCT, ALL EXPRESS AND IMPLIED WARRANTIES FOR THE PRODUCT, INCLUDING, BUT NOT LIMITED TO, ANY IMPLIED WARRANTIES OF AND CONDITIONS OF MERCHANTABILITY AND FITNESS FOR A PARTICULAR PURPOSE, ARE LIMITED IN DURATION TO THE WARRANTY PERIOD SET FORTH ABOVE AND NO WARRANTIES, WHETHER EXPRESS OR IMPLIED, WILL APPLY AFTER THE WARRANTY PERIOD. SOME STATES, PROVINCES AND JURISDICTIONS DO NOT ALLOW LIMITATIONS ON HOW LONG AN IMPLIED WARRANTY LASTS, SO THE ABOVE LIMITATION MAY NOT APPLY TO YOU. THIS WARRANTY GIVES YOU SPECIFIC LEGAL RIGHTS, AND YOU MAY ALSO HAVE OTHER RIGHTS, WHICH VARY FROM STATE TO STATE OR PROVINCE TO PROVINCE.

Contact Insignia:

For customer service please call 1-877-467-4289

[www.insigniaproducts.com](http://www.insigniaproducts.com)

Distributed by Best Buy Purchasing, LLC

7601 Penn Avenue South, Richfield, Minnesota, U.S.A. 55423-3645

© 2012 BBY Solutions, Inc.

All rights reserved. INSIGNIA is a trademark of BBY Solutions, Inc.

Registered in some countries. All other products and brand names are trademarks of their respective owners.

# INSIGNIA

[www.insigniaproducts.com](http://www.insigniaproducts.com) (877) 467-4289

Distributed by Best Buy Purchasing, LLC  
7601 Penn Avenue South, Richfield, MN 55423-3645 USA

© 2012 BBY Solutions, Inc.

All rights reserved. INSIGNIA is a trademark of BBY Solutions, Inc. Registered in some countries.  
All other products and brand names are trademarks of their respective owners.

ENGLISH  
12-0792

## Free Manuals Download Website

<http://myh66.com>

<http://usermanuals.us>

<http://www.somanuals.com>

<http://www.4manuals.cc>

<http://www.manual-lib.com>

<http://www.404manual.com>

<http://www.luxmanual.com>

<http://aubethermostatmanual.com>

Golf course search by state

<http://golfingnear.com>

Email search by domain

<http://emailbydomain.com>

Auto manuals search

<http://auto.somanuals.com>

TV manuals search

<http://tv.somanuals.com>