

KODAK ESP 3200 Series All-in-One Printer

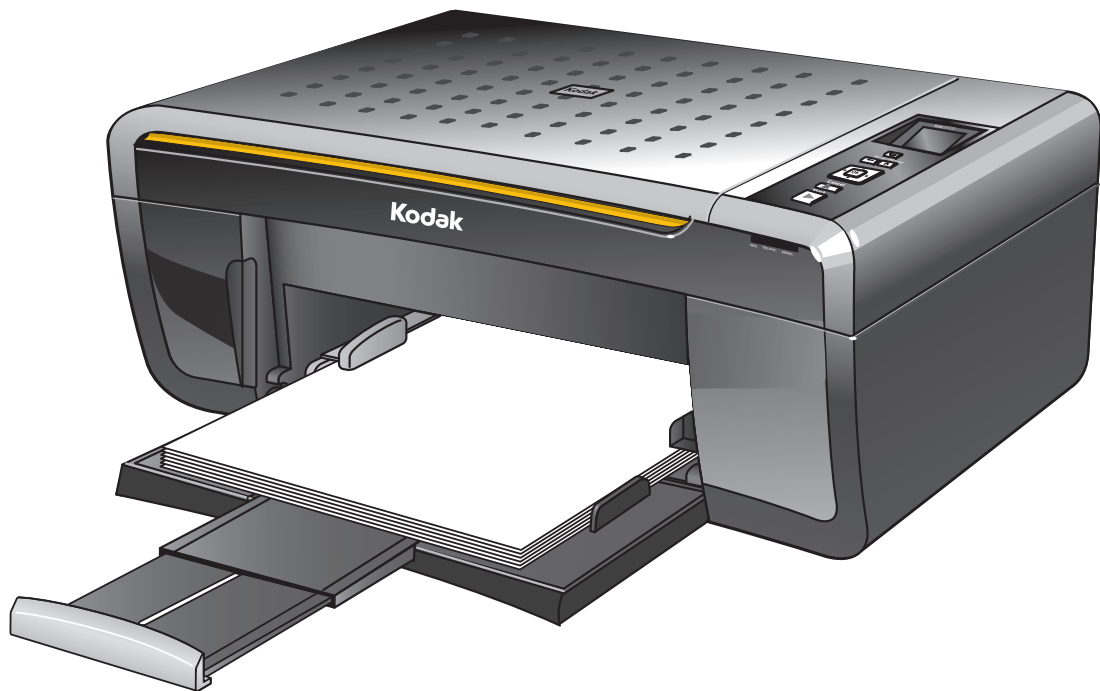

Includes Information for the:

ESP 3250 All-in-One Printer

ESP 3260 All-in-One Printer

Extended User Guide

Kodak

Eastman Kodak Company
Rochester, NY 14650

© Eastman Kodak Company, 2009

Kodak, EasyShare, and Perfect Touch are trademarks of Eastman Kodak Company.

Specifications subject to change without notice.

P/N 1K5832

September 2009

Table of contents

1 Printer Overview

Components.....	1
Control panel.....	2
Home Center Software	3
Home Center Software for WINDOWS OS-based computers	3
Home Center Software for MACINTOSH Computers	3

2 Configuring Your Printer

Configuring printer settings	4
Configuring basic printer settings	4
Setting your printer as the default printer	5
Connecting to another KODAK All-in-One Printer.....	5

3 Handling Paper

Paper types.....	7
Paper sizes.....	7
Envelope sizes.....	8
Loading paper	8
Loading plain paper	8
Loading photo paper	9
Loading envelopes.....	10

4 Printing Pictures

Changing Print Photos Options / Defaults	11
Printing pictures from a memory card	12
Types of memory cards	12
Printing a picture using the default settings.....	12
Printing pictures using non-default photo options	13
Printing tagged pictures.....	14
Printing panoramic pictures.....	15
Transferring pictures to a computer	15
Transferring pictures to a WINDOWS OS-based computer	15
Transferring pictures to a MACINTOSH Computer	15

5 Copying

Making a copy.....	16
Changing copy options.....	16
Changing copy document options	16
Changing copy photo options	18
Adjusting copy settings.....	19
Enlarging or reducing a document	19
Enlarging or reducing a photo	19
Darkening or lightening copies	20

6 Scanning

Before you begin scanning	21
Simple scanning	21
Scanning multiple pictures simultaneously	22
Scanning multiple pictures with a WINDOWS OS-based computer	22
Scanning multiple pictures with a MACINTOSH Computer	22

7 Maintaining Your Printer

General care and cleaning	23
Cleaning the scanner glass	24
Cleaning inside the scanner lid	25
Replacing ink cartridges	26
Replacing the printhead	29
Upgrading the printer software and firmware	33
Upgrading software and firmware on a WINDOWS OS-based computer	33
Upgrading software and firmware on a MACINTOSH Computer	33
Monitoring and adjusting printer performance	34
Checking ink levels	34
Resetting factory defaults	34

8 Troubleshooting

Basic troubleshooting	35
Status light	36
Power status light	36

9 Product and Safety Specifications

Specifications and features	37
Print performance	37
Photo printing features	37
Copy document features	38
Copy photo features	38
Scanning features	38
Paper tray features	39
Ink cartridges	39
Connectivity	39
Software support	39
Physical specifications	40
Warranty	40
System requirements	40

Safety information 42

Regulatory compliance..... 44

 FCC statement 44

 Canadian statements..... 44

 German compliance statement 45

 REACH Article 33 declarations..... 45

 Waste electrical and electronic equipment labeling..... 45

ENERGY STAR® Qualified 45

Warranty Information..... 46

Declaration of Conformity 47

Index

1

Printer Overview

This printer lets you print, copy, and scan pictures and documents.

Components



- | | | | |
|---|----------------------------|----|---|
| 1 | Memory card slot | 8 | Printhead with ink cartridges installed |
| 2 | Control panel | 9 | Right paper-edge guide |
| 3 | LCD | 10 | Paper tray |
| 4 | USB port | 11 | Paper tray extender / paper stop |
| 5 | Power cord connection port | 12 | Left paper-edge guide |
| 6 | Rear-access cleanout area | 13 | Scanner glass |
| 7 | Printer access door | 14 | Scanner lid |

Control panel

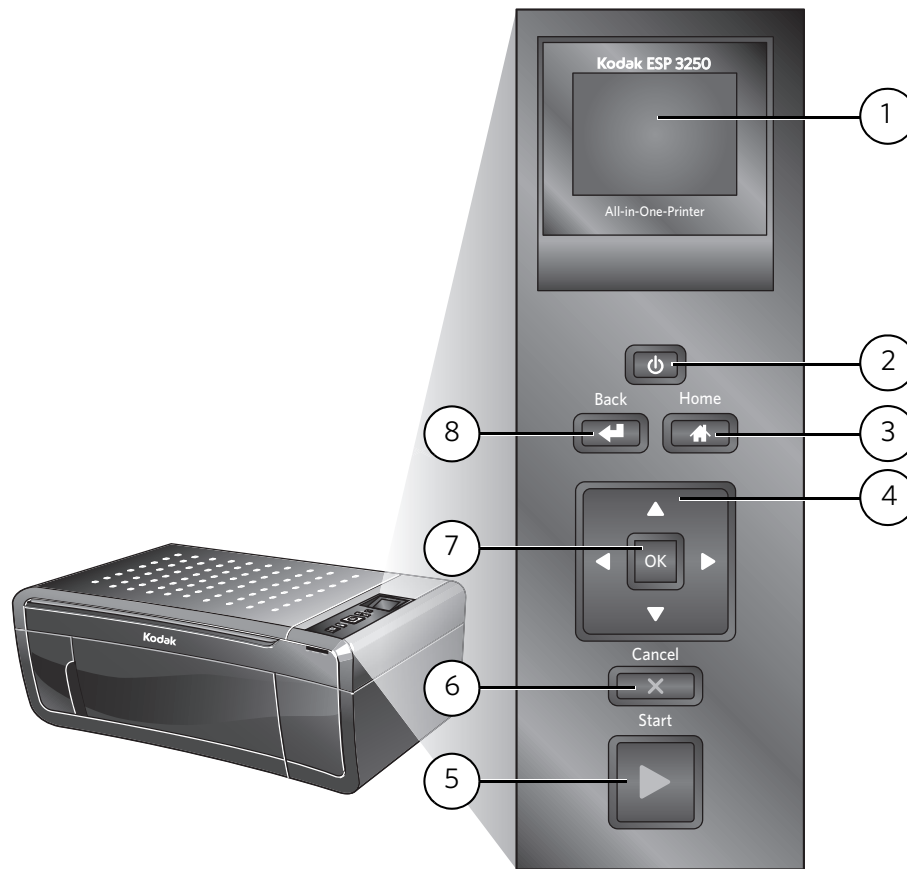

Feature	Description
1 LCD	Displays pictures, messages, and menus
2 On/Off button	Turns the printer on or off
3 Home button	Displays the main menu, and toggles between screens
4 Navigation buttons	Used to navigate menus, scroll through pictures
5 Start button	Begins copying, scanning, printing, maintenance task, and file transfer
6 Cancel button	Stops the current operation and returns to the menu; returns to previous item when navigating menus
7 OK button	Selects a menu item, accepts a zoom setting, and lets you continue with the current operation
8 Back button	Displays the previous screen

Home Center Software



KODAK Home Center Software is installed as part of the software installation on your computer. The Home Center icon will appear on your desktop. Use this icon to start Home Center Software.



Home Center Software for WINDOWS OS-based computers

On a WINDOWS OS-based computer, you can use Home Center Software to browse and edit pictures, print, copy, scan, order supplies, access the Extended User Guide, and configure your all-in-one printer from your computer. You can also access the KODAK Tips and Projects Center Web site or upgrade your printer with a newer version of software and/or firmware.

Clicking one of the three icons located in the upper-right corner of Home Center Software does the following:

-  **Home** - takes you to the main Home Center Software window from other functions within Home Center Software
-  **Tools** - displays menu options, including links to Kodak sites, troubleshooting, and maintenance functions
-  **Help** - displays a Help panel for Home Center Software

Home Center Software for MACINTOSH Computers

On a MACINTOSH Computer, Home Center Software has three panes: Select, Tools, and Maintenance. These panes let you do the following:

Select pane — select your printer from a list of connected printers and check the printer ink levels.

Tools pane — start a scan, select scanning settings, change Home Center Software settings, and restore all factory default settings.

Maintenance pane — print a test page, align and clean the printhead, and initiate an upload of diagnostic data for service personnel.

From any pane, you can order supplies from the KODAK Web site and view the status of your printer.

From the File menu of Home Center Software, you can check for software updates.

Configuring Your Printer

This chapter presumes that you have set up your printer and that you may or may not have installed the printer software.

Configuring printer settings

Configuring basic printer settings NOTE: When you first power on the printer, the printer automatically steps you through the process of selecting the **Language**.

To set or change basic printer settings:

1. Press **Home**.
2. Press ▼ to select **Printer Settings**, then press **OK**.
3. Press ▼ to select one of the following settings:
 - **Date and Time***
 - Press **OK**, then press ▼ to select **Year, Month, Day, Hour, or Minute**. Press ◀ or ▶ to change the values; press **OK** when you are done.
 - **Time to Low Power**
 - Press ▶ to change the time to energy-saving low power (select from 1 to 4 hours in 0.5 hour increments). After the Time to Low Power, the printer goes into a low-power mode.
 - **Tagged Images Printing** (see [Printing tagged pictures, page 14](#))
 - Press ▶ to select **On** or **Off**.
If you select **On**, when you are printing pictures, the printer LCD prompts you to verify that you want to print pictures that were tagged (or marked) using your camera. Different cameras use different terminology; KODAK Digital Cameras use "marked" images; others use either tagged images or DPOF.
 - **Language**
 - Press **OK**, press ▼ to select a language, then press **OK**.
 - **Reset All Settings** (see [Resetting factory defaults, page 34](#))

NOTE: Resetting factory defaults does not change the date and time, language, or country/region.

4. Press **Back**.

* You can also synchronize the printer's date and time to your computer from **Home Center Settings** under **Tools** in Home Center Software.

Setting your printer as the default printer

If you have more than one printer, and after installation your all-in-one printer was not the default printer, you can make your all-in-one printer your default printer.

For all computers and operating systems: If you haven't yet installed the printer software, insert the software CD that came with your printer and follow the on-screen instructions to install the software.

For WINDOWS XP OS-based computers

1. Select **Start > Control Panel > Printers and Faxes**.
2. Right-click your printer, and select **Set as Default Printer**.

For WINDOWS VISTA OS-based computers

1. Select **Start > Control Panel > Hardware and Sound > Printers**.
2. Right-click your printer, and select **Set as Default Printer**.

For WINDOWS 7 OS-based computers

1. Select **Start > Control Panel > Hardware and Sound > Devices and Printers**.
2. Right-click your printer, and select **Set as Default Printer**.

For MACINTOSH Computers

When a new printer is installed, it becomes the default printer. If your all-in-one printer is not the default printer:

1. From the dock, open **System Preferences**.
2. In the **Hardware** section, click **Print & Fax**.
3. Select your printer from the drop-down list next to **Default Printer**.

Connecting to another KODAK All-in-One Printer

If you are connecting to a newer model printer (for example, you already have an ESP 7 printer and now you adding an ESP 3250 printer), you must install the software for the newer model.

If you are connecting to another ESP 3250 printer or to an older model:

- On a WINDOWS OS-based computer:
 - a. Select **Start > All Programs > Kodak > Kodak Printer Network Setup Utility**.
 - b. If your all-in-one printer **is not** listed:
 - Select **No, my printer is not listed**, then click **Next**.
 - From the drop-down list, select your printer.
 - Select **USB Cable - connect your cable now**.
 - Connect the USB cable to the computer and printer.
 - Click **Next**.

When your printer is detected, driver installation begins

- c. If your all-in-one printer **is** listed:
 - Highlight the all-in-one printer that is connected to your network.
 - Select **Yes, my printer is listed**, then click **Next**.
When your printer is detected, driver installation begins.
 - d. When driver installation is complete, click **Done**.
-
- On a MACINTOSH Computer:
 - a. From the dock, open **System Preferences**.
 - b. Click **Print & Fax**.
 - c. Click the **+** sign to add the printer.
 - d. Select the printer from the list of available printers, then click **Add**.

Handling Paper

For the best photo printing results, use KODAK Photo Papers, which are optimized to work with KODAK All-in-One Printers.

For the best document printing results, use KODAK Document Papers or a paper with the COLORLOK Technology logo on the package. Use only paper that is designed for inkjet printers.

When handling paper:

- Hold the paper by the edges; avoid placing your fingerprints on it.
- Do not touch the glossy side of photo paper.
- Store paper flat, away from direct sunlight and heat.

Paper types

You can use:

- Plain paper — 20 to 24 lb / 75 to 90 gsm
- Photo paper — up to 12 mil (290 gsm)
- Card stock — 110 lb / 200 gsm, max
- Envelopes — most standard types
- Transparencies — inkjet variety with white stripe
- Labels — all inkjet varieties on 8.5 x 11-in. or A4 sheets
- Iron-on transfers — all inkjet varieties on 8.5 x 11-in. or A4 sheets

Paper sizes

The printer accepts the following paper sizes:

- 4 x 6 in. / 101 x 152 mm
- 4 x 7 in. / 101 x 178 mm
- 4 x 12 in. / 101 x 305 mm
- 5 x 7 in. / 127 x 178 mm
- 8 x 10 in. / 203 x 254 mm
- 8.5 x 11 in. / 216 x 279 mm
- 8.5 x 14 in. / 216 x 356 mm
- A4 (8.27 x 11.69 in. / 210 x 297 mm)
- A5 (5.83 x 8.27 in. / 148 x 210 mm)
- A6 (4.13 x 5.83 in. / 105 x 148 mm)
- B5 (6.93 x 9.48 in. / 176 x 250 mm)

NOTE: Do not load paper smaller than 4 x 6 in. / 101 x 152 mm or A6.

Envelope sizes

The printer accepts the following envelope sizes:

- C5 (6.38 x 9 in. / 162 x 229 mm)
- C6 (4.5 x 6.38 in. / 114 x 162 mm)
- DL (4.31 x 8.69 in. / 110 x 220 mm)
- US #7 $\frac{3}{4}$ (3.88 x 7.5 in. / 98 x 190 mm)
- US #9 (3.88 x 8.88 in. / 98 x 225 mm)
- US #10 (4.13 x 9.5 in. / 105 x 241 mm)

IMPORTANT: *Do not load envelopes with cutouts or with cellophane windows.*

Loading paper

Loading plain paper

The paper tray capacity is 100 sheets of plain paper.

To load plain paper:

1. Open the paper tray.

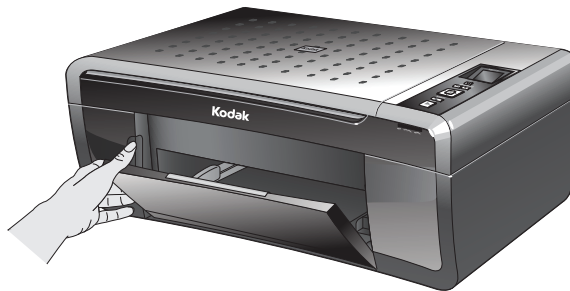

2. Pull out the paper tray extender until it is fully extended.
3. Lift the paper stop.
4. Make sure the left paper-edge guide is to the far left.

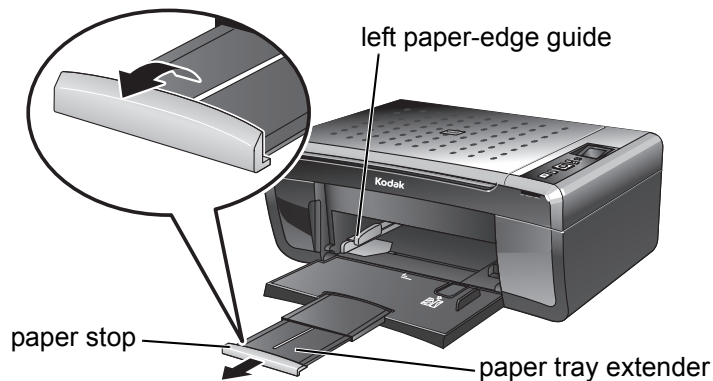

5. Carefully fan and stack the paper, then insert it into the tray.
6. Move the paper forward until it stops.
7. Move the left paper-edge guide until it touches the paper.

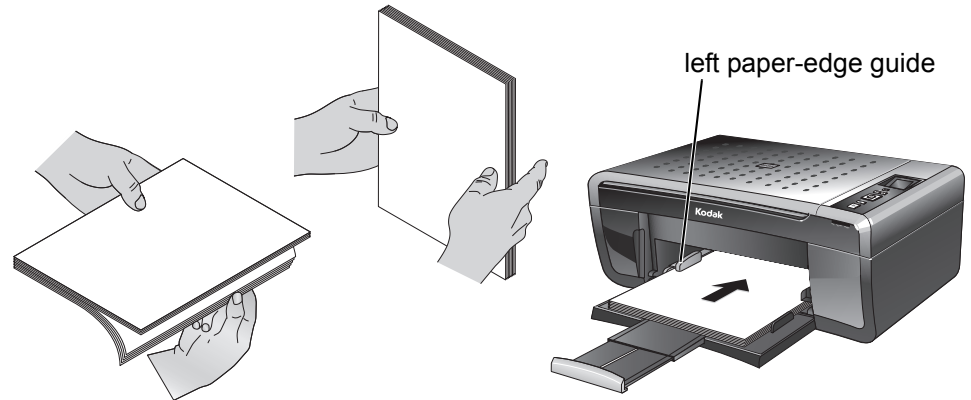

Loading photo paper

The paper tray capacity is 20 sheets of photo paper.

To load photo paper:

1. Remove any paper from the tray.
2. Carefully fan and stack the photo paper, then insert the paper (short side first) into the tray with the **logo side facing up**.
3. Move the paper forward until it stops.
4. Move the left paper-edge guide until it touches the paper.

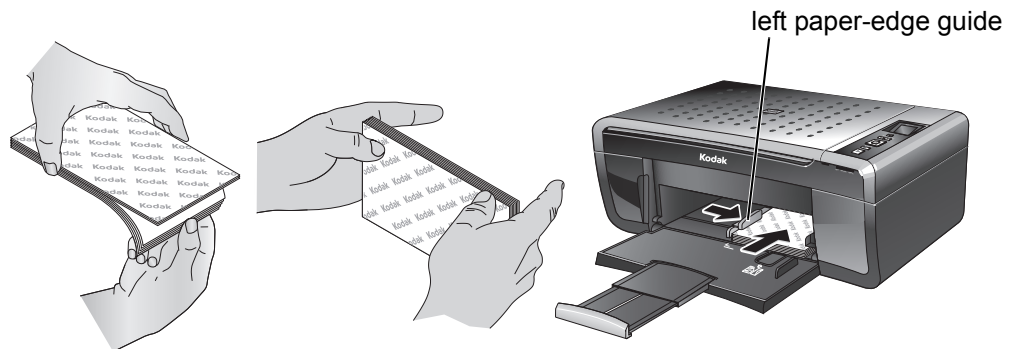

Loading envelopes

The paper tray capacity is 20 envelopes.

To load envelopes:

1. Remove any paper from the tray.
2. Insert the envelope(s) into the tray with the flap up and against the right side of the tray.
3. Move the left paper-edge guide until it touches the envelope(s).

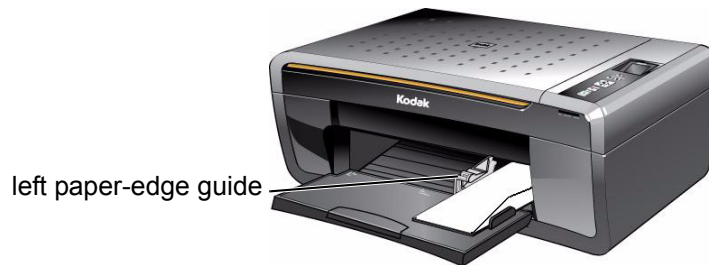

4

Printing Pictures

The quickest way to print pictures is from a memory card inserted into the printer.

Another way to print pictures is to use Home Center Software on your computer running the WINDOWS Operating System. Home Center Software lets you edit and enhance your pictures on your computer before printing. Open Home Center Software, select **Print Pictures**, then follow the on-screen instructions.

If you have a MACINTOSH Computer, print your pictures using KODAK EASYSHARE Software, iPhoto, or another picture-editing program.

Changing Print Photos Options / Defaults

You can change the print photos options for an individual picture or group of pictures, or you can change the settings and save them as the default.

To change print photos options:

1. Press **Home**.
2. If necessary, press ▼ to select **View and Print Photos**, then press **OK**.
3. Press ◀ or ▶ as needed to change the settings below.

Print Photos Option	Settings	Description
View Photos	--	Scroll through the pictures on the memory card.
Transfer All to PC	--	To transfer all the pictures on the memory card to your computer, press OK then Start . (Your printer and computer must be connected with a USB cable.)
Quantity	1 (default) to 99	The number of copies that print.
Print Size	2 x 3 3.5 x 5 4 x 6 (default) 4 x 7 5 x 7 4 x 12 8 x 10 8.5 x 11 or A4	If the selected copy size is smaller than the paper in the paper tray, the printer automatically arranges the pictures to best fit the paper size.
Plain Paper Quality	Normal (default)	Good quality output; prints faster than Best.
	Best	The highest quality.
	Draft	The fastest print speed.
Photo Paper Quality	Automatic (default)	The printer detects when you load photo paper and sets Best quality automatically.

Print Photos Option	Settings	Description
Color	Color (default)	Prints full color.
	Black & White	Prints black and white (gray scale).
Scene Balance	On (default) Off	Adjusts the image brightness to correct for underexposure and reduces the variation in contrast in different areas of the picture.
Add Date to Prints	No (default) Yes	Prints the date of the picture(s) (the date the picture was taken or last edited) in a corner of the print.
Save as Defaults	No (default) Yes	To save settings as the new default, press OK , select Yes , then press OK .

Printing pictures from a memory card

Types of memory cards Your printer accepts the following memory cards:

- SD Card
- SDHC Card
- MMC Card
- Memory Stick
- Variations of the memory cards listed above that require an adapter (for example, MEMORY STICK Duo, miniSD, and microSD)

IMPORTANT: *If you use a memory card with an adapter, make sure you insert and remove the adapter and the memory card as a unit; do not remove the memory card while leaving the adapter in the printer.*

Printing a picture using the default settings If you use the default settings, one 4 x 6 in. / 101 x 152 mm picture is printed.
To print a picture:

1. Load photo paper with the logo side facing up (see [Loading photo paper, page 9](#)), and move the left paper-edge guide until it touches the paper.

2. Insert the memory card into the memory card slot.



3. Press ◀ or ▶ to display the picture you want to print.
4. Press **Start** to begin printing.

IMPORTANT: *To prevent loss of data from your memory card, do not remove it from the printer while printing.*

Printing pictures using non-default photo options

To print pictures with options other than the default settings (such as a different print size, black-and-white instead of color, or a date on the print):

1. Load photo paper with the logo side facing up (see [Loading photo paper, page 9](#)), and move the left paper-edge guide until it touches the paper.



2. Press **Back**.
3. If necessary, use the navigation buttons to select **View and Print Photos**.
4. Press **OK**.

5. Press ▼ to select the option you want to change (for example, Quantity, Print Size, Color, Scene Balance, or Add Date to Print).

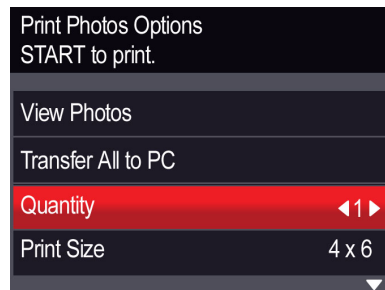

6. Press ► to change the selection.
7. Repeat steps 5 and 6 for each option you want to change.
8. When you are done changing options, press ▲ to select **View Photos**, then press **OK**.
9. Insert the memory card into the memory card slot.
10. Press ◀ or ▶ to select the picture you want to print, then press **OK**. A check mark on the LCD indicates the picture is selected.

NOTE: To deselect the picture, press **OK** again.

11. To select additional pictures, press ◀ or ▶ until the picture is displayed, then press **OK**.
12. When you are done selecting pictures, press **Start** to begin printing.

IMPORTANT: To prevent loss of data from your memory card, do not remove it from the printer while printing.

Printing tagged pictures

Some digital cameras let you tag (or “mark”) pictures on the memory card for printing. This creates a tag that is recognized by the printer. If you choose to print tagged pictures, they will be printed according to the default settings on your printer (unless otherwise specified by the tag from the camera).

NOTE: Refer to your camera user guide to determine whether your camera supports tagged (also “marked” or “DPOF”) functionality.

To print tagged pictures:

1. Load photo paper with the logo side facing up (see [Loading photo paper, page 9](#)), and move the left paper-edge guide until it touches the paper.

2. Insert the memory card into the memory card slot.



3. When the "Print tagged images?" message appears, press **Start**.

Printing panoramic pictures

To print a panoramic picture, load 4 x 12 in. / 101 x 305 mm paper, or US letter or A4 paper.

Transferring pictures to a computer

You can transfer .jpg, .mov, and .wav files from a memory card in the printer to your computer. To transfer these files, the printer **must** be connected to your computer with a USB cable.

NOTE: If you have large video files or a large number of pictures (400 or more), we recommend that you use a memory card reader attached directly to your computer to transfer them.

Transferring pictures to a WINDOWS OS-based computer

1. Insert the memory card into the memory card slot on the printer.
2. Press **Back**.
3. If necessary, use the navigation buttons to select **View and Print Photos**.
4. Press **OK**.
5. Press ▼ to select **Transfer All to PC**, then press **OK**.
6. Press **Start**.
7. Follow the on-screen instructions on your computer.

Transferring pictures to a MACINTOSH Computer

1. Insert the memory card into the memory card slot on the printer.
2. Press **Back**.
3. If necessary, use the navigation buttons to select **View and Print Photos**.
4. Press **OK**.
5. Press ▼ to select **Transfer All to PC**, then press **OK**.
6. Press **Start**.
7. Use iPhoto or Image Capture on your computer to complete the transfer.

5

Copying

You can copy documents and pictures with your all-in-one printer. The printer produces high-quality color or black-and-white copies on a variety of paper types (see [Paper types, page 7](#)).

Making a copy

To copy a document or a picture using the default settings:

1. Lift the scanner lid, and place the document or picture face down on the glass.

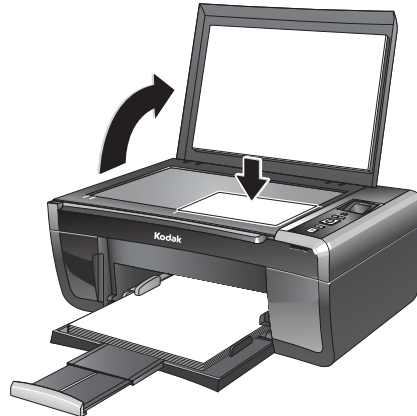

2. Close the lid.

NOTE: Single-button document copy is a feature that lets you put paper on the scanner and immediately press **Start**, without following the remaining steps below. You can use this feature when the printer has been idle or when it is turned on; the printer automatically goes to Copy Document mode.

3. Press **Home**.
4. If needed, press ▼ or ▲ to select **Copy Document** or **Copy Photo**.
5. Press **Start** to begin copying.

Changing copy options

You can change the copy options for an individual copy, or you can change the settings for copying documents or copying photos, and save them as the defaults.

Changing copy document options

To change the copy document options:

1. Press **Home**.
2. If necessary, press ▲ to select **Copy Document**.
3. Press **OK**.

4. Press ▼ to go through the options, and press ◀ or ▶ as needed to change the settings below:

Copy Document Option	Settings	Description
Quantity	1 (default) to 99	The number of copies that print.
Copy Size	Same Size (default)	The copy is the same size as the original.
	Fit to Page	The printer detects the size of the original on the scanner glass and the size of the paper in the paper tray, and automatically reduces or enlarges the original so that the copy fits on the paper.
	20% to 500%	Reduces up to 20% or enlarges up to 500% of the original size.
Plain Paper Quality	Normal (default)	Good quality output; prints faster than Best.
	Best	The highest quality, but the slowest print speed; eliminates the banding effect that sometimes occurs when printing Draft or Normal.
	Draft	The fastest print speed, but the lowest quality.
Photo Paper Quality	Automatic (default)	The printer detects when you load photo paper and sets Best quality automatically.
Color	Color (default)	Prints full color.
	Black & White	Prints black and white (gray scale).
Brightness	-3 to +3 (0 is default)	Lightens or darkens the copy. 0 (Normal) is no change from the original; -3 is the darkest; +3 is the lightest.
Save as Defaults	No / Yes	To save settings as the new default: press OK , select Yes , then press OK .

Changing copy photo options

To change the copy photo options:

1. Press **Home**.
2. If necessary, press ▼ to select **Copy Photo**.
3. Press **OK**.
4. Press ▼ to view the options, and press ◀ or ▶ as needed to change the settings below:

Copy Photo Option	Settings	Description
Quantity	1 (default) to 99	The number of copies that print.
Copy Size	2 x 3 3.5 x 5 4 x 6 (default) 4 x 7 5 x 7 4 x 12 8 x 10 8.5 x 11 or A4	If the selected copy size is smaller than the paper in the paper tray, the printer automatically arranges the pictures to best fit the paper size.
Plain Paper Quality	Normal (default)	Good quality output; prints faster than Best.
	Best	The highest quality.
	Draft	The fastest print speed.
Photo Paper Quality	Automatic (default)	The printer detects when you load photo paper and sets Best quality automatically.
Color	Color (default)	Prints full color.
	Black & White	Prints black and white (gray scale).
Brightness	-3 to +3 (0 is default)	Lightens or darkens the copy. 0 (Normal) is no change from the original; -3 is the darkest; +3 is the lightest.
Save as Defaults	No / Yes	To save settings as the new default: press OK , select Yes , then press OK .

Adjusting copy settings

You can change the copy settings for individual copy tasks. A few of the common tasks are described below.

Enlarging or reducing a document

To enlarge or reduce the size of your copy:

1. Lift the scanner lid, and place the document face down on the glass.
Note the orientation of the paper on the glass and make sure the paper is flush to the edges.

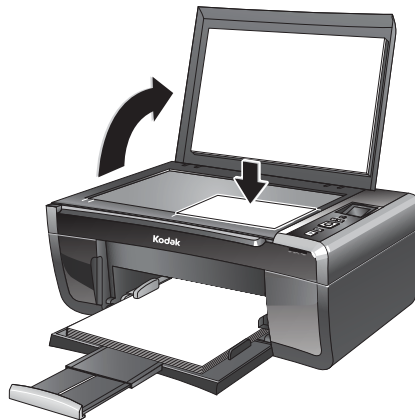

2. Close the lid.
3. Press **Home**.
4. If needed, press ▼ or ▲ to select **Copy Document**.
5. Press **OK**.
6. Press ▼ to select **Copy Size**.
7. Press ◀ or ▶ to select the enlargement or reduction you want.

NOTE: If you select **Fit to Page**, the printer detects the size of the original on the scanner glass and the size of the paper in the paper tray, and automatically reduces or enlarges the original so that the copy fits on the paper

8. Press **Start** to begin copying.

Enlarging or reducing a photo

To enlarge or reduce the size of your copy:

1. Lift the scanner lid, and place the photo face down on the glass.
2. Close the lid.
3. Press **Home**.
4. If needed, press ▼ or ▲ to select **Copy Photo**.
5. Press **OK**.
6. Press ▼ to select **Copy Size**.
7. Press ◀ or ▶ to select the photo size you want.
8. Press **Start** to begin copying.

Darkening or lightening copies

If the original document or picture is too light or too dark, you can make the copy darker or lighter.

To darken or lighten the copy:

1. Lift the scanner lid, and place the document face down on the glass.

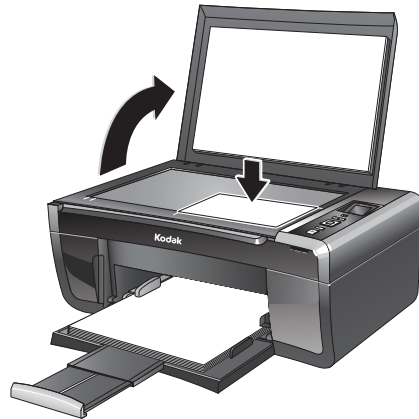

2. Close the lid.
3. Press **Home**.
4. If needed, press ▼ or ▲ to select **Copy Document** or **Copy Photo**.
5. Press **OK**.
6. Press ▼ to select **Brightness**.
7. Press ◀ to select a number below zero for a darker copy, or press ▶ to select a number above zero for a lighter copy.
8. Press **Start** to begin copying.

6

Scanning

Scanning converts the text and images from the documents and pictures that you place on the scanner glass into electronic data, and then sends the data to your computer. To scan with your all-in-one printer, it must be connected to a computer with a USB cable.

You save the scanned file(s) to your computer; you cannot save to a memory card in the printer.

Before you begin scanning

Change the default scan settings in the Home Center Software. (Click the Tool icon, then select **Printer Scan Settings**.) You can adjust the following settings for scanned pictures and documents:

- Color / black-and-white / gray scale
- Resolution (dpi)
- File format (.pdf, .rtf, .tif, .jpg for documents; .jpg, .bmp, .tif for pictures)
- Base name (by default, scanned files are named "scan1", "scan2", etc)
- Location (folder) where the scanned files will be saved

Before saving a scanned file, you can preview it in Home Center Software, and crop the output as desired. See the Home Center Software Help (? icon) for instructions.

Simple scanning

To scan a single document or picture:

1. Lift the scanner lid, and place the document or picture face down on the glass.

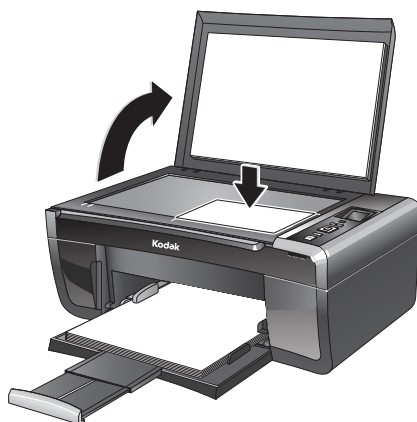

2. Close the lid.
3. Open Home Center Software, then:
 - On a WINDOWS OS-based computer, select **Scan Pictures and Documents**, then follow the on-screen instructions.
 - On a MACINTOSH Computer, select **Tools > Scan Application**, then follow the on-screen instructions.

Scanning multiple pictures simultaneously

Using Home Center Software, you can scan multiple pictures simultaneously and save them as separate files.

NOTE: For Home Center Software to interpret two or more pictures, the scan option must be set to Picture.

When scanning multiple pictures, leave space between the pictures so that the printer can detect the separate pictures. Any pictures that overlap are interpreted as a single picture.

Scanning multiple pictures with a WINDOWS OS-based computer

To scan multiple pictures simultaneously and save them as separate files:

1. Lift the scanner lid, and place the pictures face down on the glass leaving space between the pictures.
2. Close the lid.
3. Open Home Center Software, then select **Scan Pictures and Documents**.
4. Open the Tools panel, if it is not open, by clicking the **Tools** icon.
5. Click **Printer Scan Settings**.
6. Select the **Picture** tab.
7. Select **Automatically Detect Pictures**, if it is not selected, then click **OK**.
8. Make sure **Picture** is selected, then follow the on-screen instructions.

NOTE: Click the Help icon for additional instructions.

Scanning multiple pictures with a MACINTOSH Computer

To scan multiple pictures simultaneously and save them as separate files:

1. Lift the scanner lid, and place the pictures face down on the glass leaving space between the pictures.
2. Close the lid.
3. Open Home Center Software, then select the **Tools** tab.
4. Select **Color Picture** or **Black and White Picture**.
5. Click the **Scan Application** button.
6. Select **Automatically detect multiple pictures**, if it is not selected.
7. Click **Preview** or **Scan All**, and follow the on-screen instructions.

NOTE: Click the Help icon for additional instructions.

Maintaining Your Printer

Your printer requires little maintenance. However, Kodak recommends cleaning the scanner glass and lid regularly to remove dust and fingerprints, which affect the quality and accuracy of scanning.

Except for cleaning the printer, keep the printer plugged in with AC power turned on. If you use a power strip, don't turn off the power strip.

Keep the printhead and ink cartridges in the printer at all times. This helps prevent damage to the printhead.

Service agreements are available in some countries. Contact dealers of KODAK Products for more information.

For recycling and/or disposal information, contact your local authorities. In the US, go to the Electronics Industry Alliance at www.eia.org or go to www.kodak.com/go/recycle.

General care and cleaning

 CAUTION:

Always disconnect the power to the printer before cleaning it. Do not use harsh or abrasive cleaners or organic solvents on the printer or any of its parts.

- To clean the printer, wipe the outside with a clean, dry cloth.
- Keep the surrounding area vacuumed and litter-free.
- Protect the printer from tobacco smoke, dust, sand, other small particles (such as crumbs), and liquid spills.
- Do not place objects on the printer.
- Keep the printer supplies away from direct sunlight and out of high-temperature environments.
- Do not allow chemicals, such as suntan lotion, to come into contact with the painted surface of the printer.
- If the printer has been exposed to bad weather or has water inside it, turn it off and let it dry completely. If this does not solve the problem, contact Kodak Service & Support.

Cleaning the scanner glass

For good quality copies and scans, ensure the printer's scanner glass and lid backing are clean; dust the exterior as needed.

 CAUTION:

Do not use abrasives, acetone, benzene, or carbon tetrachloride on the glass, as these chemicals may damage it. Do not pour or spray liquid directly on the glass; the liquid might seep under the glass and damage the printer.

To clean the scanner glass:

1. Unplug the printer and raise the scanner lid.



2. Wipe the glass with a soft cloth or sponge, slightly moistened with a nonabrasive glass cleaner.
3. Dry the glass with a lint-free cloth.
4. When finished cleaning, plug in the printer.

Cleaning inside the scanner lid

Minor debris can accumulate on the white document backing located under the scanner lid.



CAUTION:

Do not use paper-based wipes, as they can scratch the underside of the scanner lid. Do not use harsh or abrasive cleaners or organic solvents on the printer or any of its parts.

To clean the white document backing under the scanner lid:

1. Unplug the printer and raise the scanner lid.



2. Gently clean the underside of the lid with a soft cloth or sponge, slightly moistened with a mild soap and warm water.
3. Dry the underside with a chamois or soft cloth.
4. If the white document backing needs further cleaning, use isopropyl (rubbing) alcohol on a soft cloth, then wipe thoroughly with a cloth dampened with water to remove any residual alcohol.
5. When finished cleaning, plug in the printer.

Replacing ink cartridges

Your printer uses both black and color ink cartridges. You can check the approximate ink levels on the LCD (see [Checking ink levels, page 34](#)) or in Home Center Software. When an ink cartridge is out of ink, the printer LCD displays a message stating that the black or color ink cartridge needs replacing.

IMPORTANT: Do not use non-Kodak brand or refilled ink cartridges.

To replace an ink cartridge:

1. Make sure your printer is on.
2. Lift the printer access door, and wait for the carriage to move to the access position.



The black and color ink cartridges are located in the printhead.

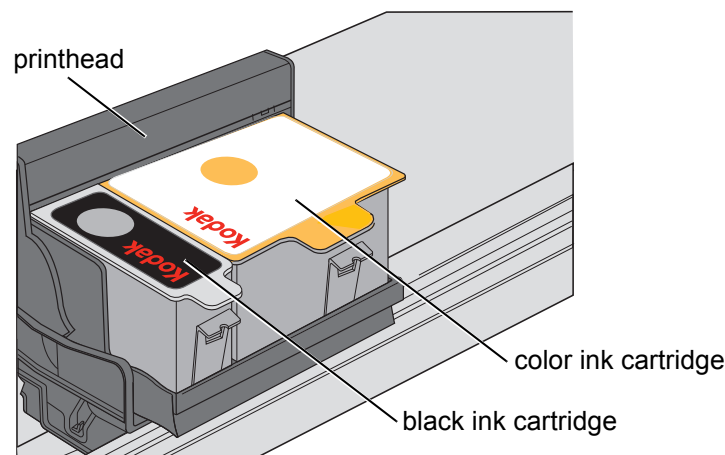

3. Pinch the latch on the ink cartridge and lift it out of the printhead.

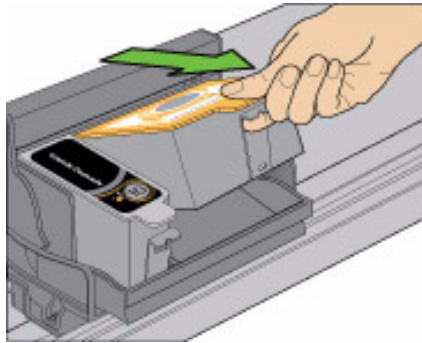

4. Remove the ink cartridge from its bag.

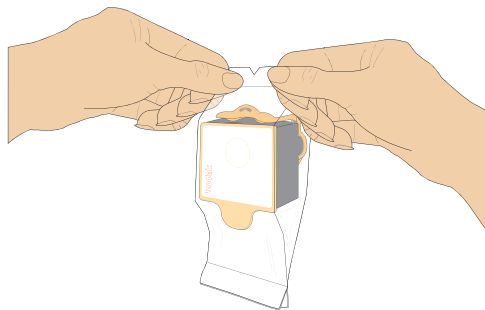

IMPORTANT: Insert the ink cartridge into the printhead immediately to prevent the printhead from drying out.

5. Remove the protective cap from the cartridge.

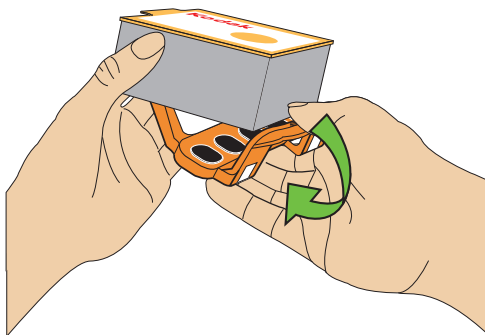

6. Insert the ink cartridge into the printhead.

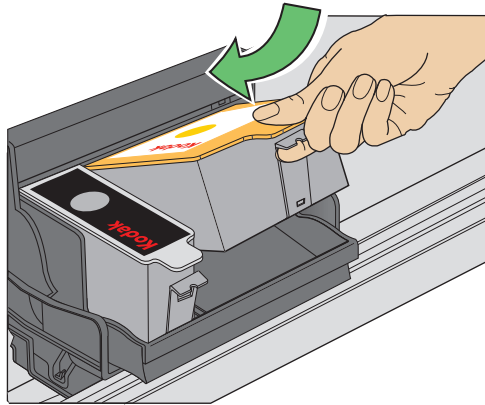

7. Press down on the tab until you hear a click.

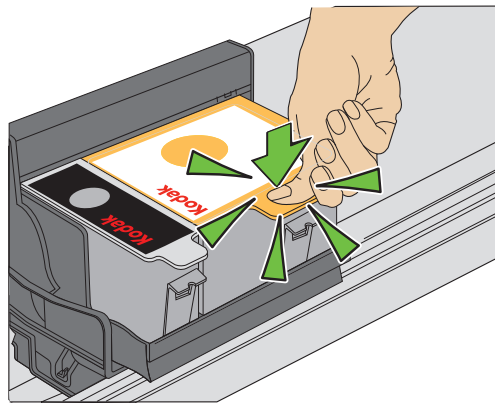

8. Close the printer access door.

Replacing the printhead

IMPORTANT: Replacing the printhead is not a regular maintenance procedure. Replace the printhead only if you receive a new printhead from Kodak.

To replace the printhead:

1. Make sure your printer is on.
2. Lift the printer access door, and wait for the carriage to move to the access position.



3. Remove any paper that may be loaded in the printer.
4. Remove both ink cartridges and set them aside.

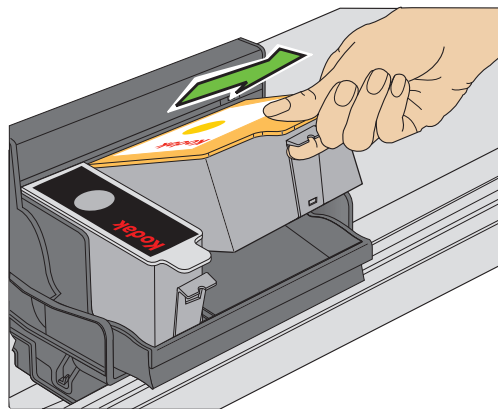

5. Unlatch the used printhead by lifting the button in the center of the carriage.

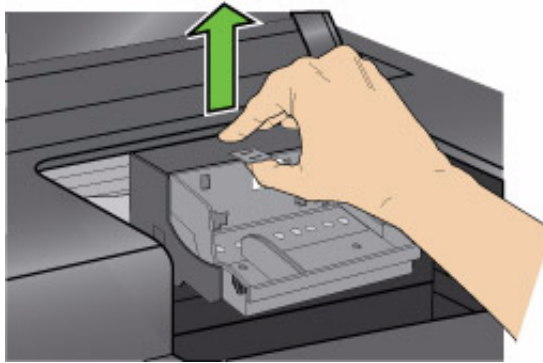

6. Lift the used printhead out of the carriage.



7. Remove the new printhead from its bag.



⚠ CAUTION:
Do not touch the copper contacts on the printhead, as this may damage it.

8. Remove the two plastic protective shields.

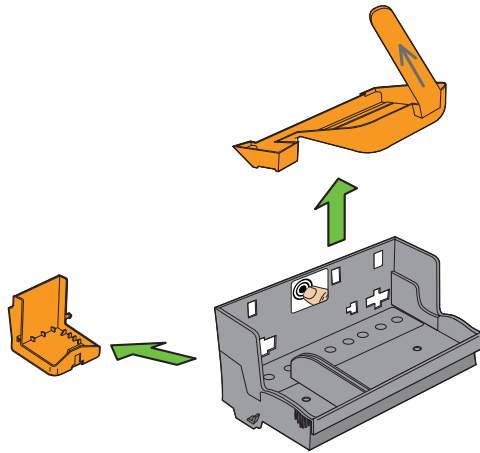

9. Place the new printhead into the carriage. Insert it at the angle shown.

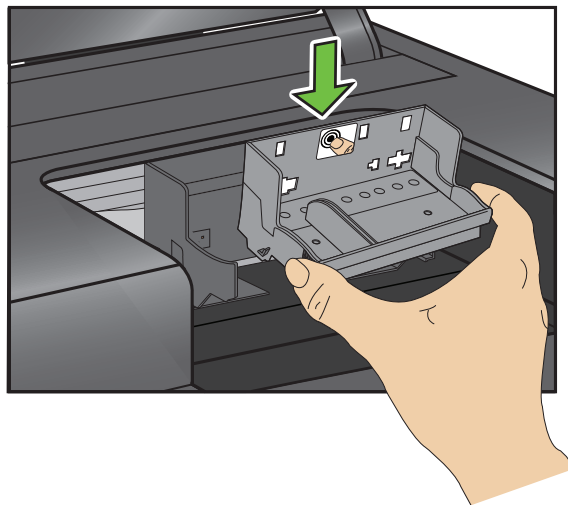

10. Push firmly against the target label of the printhead until you hear a loud snap.

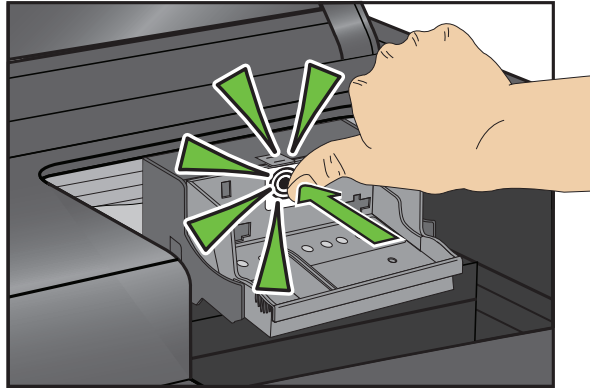

11. Insert the black ink cartridge into the printhead.
12. Press down on the ink cartridge until you hear it click into position.

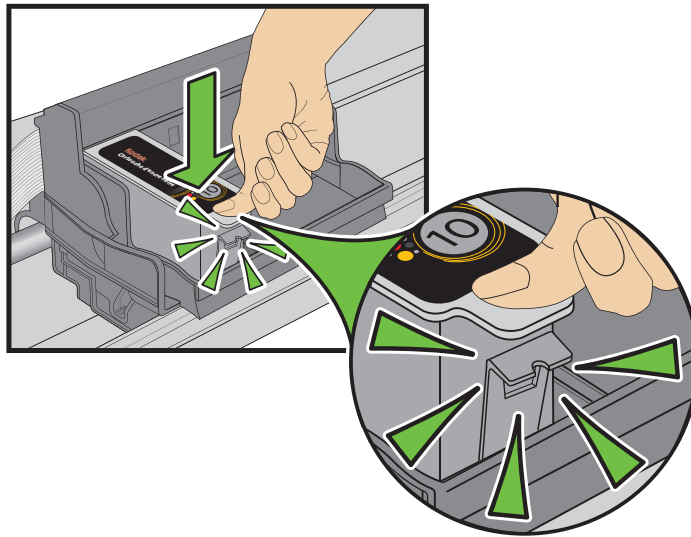

13. Repeats steps 11 - 12 for the color ink cartridge.
14. Close the printer access door.
The printer detects the new printhead. Follow the instructions on the LCD to calibrate your printer.

Upgrading the printer software and firmware

Using the latest software and firmware helps ensure optimal performance of your printer.

When you upgrade to the latest version of Home Center Software, it comes with the latest drivers, which are programmed links between the computer and printer. The drivers allow communication between the printer, scanner, and computer.

Firmware is data or programs that are written to the memory and control functionality of your printer.

When you open Home Center Software, the software automatically checks for software and firmware updates (firmware updates on WINDOWS OS-based computers only). Use these procedure when you want to upgrade manually.

NOTE: Your printer must be connected to the computer with a USB cable to upgrade firmware.

Upgrading software and firmware on a WINDOWS OS-based computer

To upgrade the software and firmware:

1. Make sure that your computer is connected to the Internet.
2. Connect the printer to the computer with a USB cable (if not currently connected).
3. Open Home Center Software.
4. Click the Tools icon to open the side navigation pane.
5. Under Web Links, click **Software Updates** to check whether software updates are available.
6. If there are updates, click **Next** and follow the on-screen instructions.
7. Under Web Links, click **Firmware Updates** to check whether firmware updates are available.
8. If there are updates, click **Next** and follow the on-screen instructions.

Upgrading software and firmware on a MACINTOSH Computer

To upgrade the software:

1. Make sure that your computer is connected to the Internet.
2. Open Home Center Software.
3. On the File menu, select **Check for Updates**.
4. If there are software updates, follow the on-screen instructions for upgrading your software.

To upgrade the firmware:

1. Go to www.kodak.com/go/esp3250downloads.
2. Connect the printer to the computer with a USB cable (if not currently connected).
3. Select your operating system from the drop-down list.
4. Click **Select** in the Firmware box.
5. Read the instructions, click **Download**, then follow the on-screen instructions.

Monitoring and adjusting printer performance

From the control panel, you can perform many tasks to help you keep the printer functioning well.

Checking ink levels

To check the ink levels:

1. Press **Home**.
2. Press ▼ to select Maintenance.

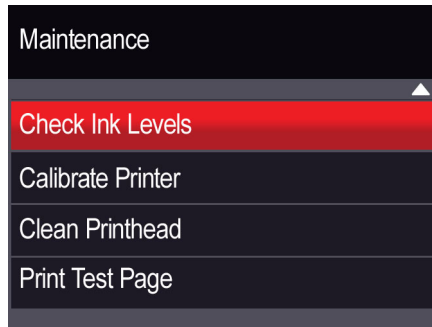

3. With **Check Ink Levels** selected, press **OK**.
The LCD shows approximate levels of ink in the cartridges so you know when it's time to order replacement cartridges.

Resetting factory defaults

To reset all defaults to the factory default settings:

1. Press **Home**.
2. Press ▼ to select **Printer Settings**.
3. Press ▼ to select **Reset All Settings**, then press **OK**.
4. When you see the message, "This will reset printer settings to factory defaults," press **OK**.

Basic troubleshooting

Some problems can be resolved quickly by power cycling the printer: Turn off your printer. Wait five seconds. Turn on the printer.

Use the following information to help troubleshoot problems with your printer.

For more troubleshooting information, go to:

- www.kodak.com/go/itg to use our Step-by-Step Solutions and Repair tool for help with problems such as paper jams and image quality.
- www.kodak.com/go/esp3250support for FAQs and links to other support for your printer.
- www.kodak.com/go/esp3250downloads to download the latest software and firmware files.
- www.kodak.com/go/esp3250specs for the recommended system requirements.

Problem	Possible Solutions
Printer does not power on	<ul style="list-style-type: none"> ▪ Make sure you are using the power cord that came with your printer. ▪ Make sure the power cord is connected to the AC adapter and is plugged into an outlet or power strip. ▪ If the USB 2.0 cable was disconnected from the printer, then reconnected, or if power to the printer was interrupted, restart the computer.
Printer not detected	<ul style="list-style-type: none"> ▪ Make sure your printer is plugged in and turned on. ▪ Make sure: <ul style="list-style-type: none"> - you have a USB 2.0 cable. - that the USB cable is connected to both your printer and your computer.
Printhead carriage jam	<ul style="list-style-type: none"> ▪ Open the printer access door and clear any obstructions. ▪ Check that the printhead and ink cartridges are installed correctly. (The printhead and ink cartridges are installed correctly when you hear them click into place.)
Image quality problems	<ul style="list-style-type: none"> ▪ For best results, use KODAK Paper or a paper with the COLORLOK Technology logo on the package. ▪ Make sure the paper is loaded correctly. See Loading paper, page 8 5. For more help, go to www.kodak.com/go/itg, select All-in-one printer, then Print Quality (missing colors, blank prints, etc).
Ink cartridge problems	<ul style="list-style-type: none"> ▪ Check that KODAK Ink Cartridge(s) are installed. Do not use non-Kodak brand or refilled ink cartridges. ▪ Remove, then install the cartridges again. Make sure the cartridges click into place.

Problem	Possible Solutions
Paper jam	<ul style="list-style-type: none"> ▪ Check for paper in the rear-access cleanout area. ▪ Open the printer access door and gently remove any paper from inside the printer. ▪ Make sure the paper in the tray is free of tears or creases. ▪ Make sure you do not overload the paper tray. <p>For more information, see www.kodak.com/go/itg. Select All-in-one printer, then Paper jam.</p>
Error messages or other problems you cannot resolve	<p>If you need to contact Kodak (see www.kodak.com/go/contact), have the following information available:</p> <ul style="list-style-type: none"> ▪ Kodak Service Number (located inside or on the outside of the printer) ▪ Printer mode number (located on the back of the printer) ▪ Computer model, operating system, and version of Home Center Software ▪ Exact wording of any error message(s)

For more troubleshooting information, go to www.kodak.com/go/esp3250support.

Status light

The status light indicates the condition of the printer.

Power status light

Power light	What it means
Off	<ul style="list-style-type: none"> ▪ The printer is turned off. <ul style="list-style-type: none"> - Press the on/off button to turn on power. ▪ The printer does not have power. <ul style="list-style-type: none"> - Make sure that the power cord is plugged into the back of the printer and into an electrical outlet, and that the electrical outlet has power.
Blinking	<ul style="list-style-type: none"> ▪ The printer is busy. <ul style="list-style-type: none"> - Wait for the printer to finish the task.
On	<ul style="list-style-type: none"> ▪ The printer is ready

Product and Safety Specifications

Specifications for this KODAK ESP 3200 Series All-in-One Printer are described in the tables below.

Specifications and features

Print performance

Print Performance	
Black Print Speed	Up to 30 pages per minute on plain paper
Color Print Speed	Up to 29 pages per minute on plain paper
Print Technology	Continuous-tone, thermal inkjet
Print Quality Modes	Draft, Normal, and Best on plain paper Photo quality mode on photo paper

Photo printing features

Photo Printing Features	
Quantity	Up to 99 (may vary for different models of the 3200 series printers)
Print Sizes	2 x 3 in. (5 x 7.6 cm) 3.5 x 5 in. (9 x 12.7 cm) 4 x 6 in. (10 x 15 cm) 4 x 7 in. (10 x 18 cm) (Panoramic) 4 x 12 in. (10 x 30 cm) 5 x 7 in. (13 x 18 cm) 8 x 10 in. (20 x 25 cm) US Letter - 8.5 x 11 in. (22 x 28 cm) A4 (21 x 30 cm)
Quality	Best, Normal, Draft
Auto-detect Media	Auto-detect plain paper, photo paper, and transparency Optimize image quality for KODAK Photo Papers with barcode
Image Enhancement	KODAK PERFECT TOUCH Technology with Home Center Software
Add Dates to Prints	Yes, No
Color	Color, Black-and-white
Scene Balance	On, Off

Copy document features

Copy Document Features	
Color	Black-and-white or color
Quantity	1 to 99 copies (may vary for different models of the 3200 series printers)
Copy Sizes	Same Size, Fit-to-Page, 20% to 500% (may vary for different models of the 3200 series printers)
Plain Paper Quality	Best, Normal, Draft
Brightness	- 3 to + 3

Copy photo features

Copy Photo Features	
Color	Black-and-white or color
Quantity	1 to 99 copies (may vary for different models of the 3200 series printers)
Copy Sizes	2 x 3 in. (5 x 7.6 cm) 3.5 x 5 in. (9 x 12.7 cm) 4 x 6 in. (10 x 15 cm) 4 x 7 in. (10 x 18 cm) (Panoramic) 4 x 12 in. (10 x 30 cm) 5 x 7 in. (13 x 18 cm) 8 x 10 in. (20 x 25 cm) US Letter - 8.5 x 11 in. (22 x 28 cm) A4 (21 x 30 cm)
Quality	Automatic
Brightness	- 3 to + 3

Scanning features

Scanning Features	
Scanner Type	Contact Image Sensor (CIS)
Maximum Scan Size	8.5 x 11.7 in. (21.6 x 29.7 cm)
Functions	Segmentation scanning Auto-destination OCR

Paper tray features

Paper Tray Features	
Paper Capacity	100 sheets of 20 lb plain paper 20 sheets of photo paper, up to 12 mil (290 gsm) 20 envelopes
Tray Size	4 x 6 in. to 8.5 x 14 in. (10 x 15 cm to 21.6 x 36 cm)

Ink cartridges

Ink Cartridges	
Ink Handling	2-cartridge, 6-ink system
Ink Life	1-year warranty from date of purchase

Connectivity

Connectivity	
Protocols Supported	USB 2.0, DPOF, MIPC
Devices Supported	WINDOWS OS-based and MACINTOSH Computers, memory cards (SD, MS/Duo, MMC, SDHC)
Image Formats Supported	Image printing supports JPEG (EXIF v2.2); does not support progressive JPEG format
Number of USB Ports	One rear device port (high speed)
Protocols Supported	USB 2.0, DPOF (Tagged image printing), MIPC

Software support

Software Support	
Application Support	KODAK EASYSHARE Software for photos or third-party image management applications; optical character reader (OCR) support for documents
Media Support	Plain paper, photo paper, envelopes, greeting cards, transparencies with white stripe, labels
Scanner Support	TWAIN and WIA, WIA2 (VISTA OS) import, including EASYSHARE Software, segmentation scanning
Update Support	Software and firmware updates available through Web support

Physical specifications

Physical Specifications	
Power	US: 110-120 V AC, 50-60 Hz at 2 A WW: 110-240 V AC, 50-60 Hz at 2 A Output: 36 V DC at 1.6 A
Dimensions	422 x 98 x 181 mm [L x H x D] (16.6. x 11.7. x 7.1 in.)
Weight	5.6 kg (12.3 lb)
Operating Range	5°C (41°F) to 35°C (95°F), 15 to 85% RH (non-condensing and atmospheric pressure to approximately 10,000 ft ASL)
Full image Quality Environmental Range	15°C (59°F) to 30°C (86°F), and 20 to 80% RH. ENERGY STAR® Qualified

Warranty

Warranty	
Product	One year from purchase (with proof of purchase)
Printhead	One year from purchase (with proof of purchase)

System requirements

The following specifications are subject to change without notice.

WINDOWS OS-based computer

WINDOWS OS-Based Computer	Minimum	Recommended
Operating System	MICROSOFT WINDOWS XP SP2 OS	MICROSOFT WINDOWS VISTA OS
CPU	Celeron	32- or 64-bit processor
Clock Speed	1.2 GHz	2 GHz
Memory	512 MB RAM	1024 MB RAM
Available Disk Space	500 MB available	500 MB available
Interface	USB 2.0	USB 2.0
Removable Drive	CD-ROM	CD-ROM
Other	Internet access capability	Internet access capability

MACINTOSH Computers

MACINTOSH Computers	Minimum	Recommended
Operating System	MACINTOSH OS X 10.4.8	OS X 10.4.8 or later
CPU	PowerPC G4, G5, or Intel Based Mac	Intel Based Mac
Clock Speed	1.2 GHz	2 GHz
Memory	512 MB RAM	1024 MB RAM
Available Disk Space	200 MB available	200 MB available
Interface	USB 2.0 Full Speed	USB 2.0 High Speed
Removable Drive	CD-ROM	CD-ROM
Other	Internet access capability	Internet access capability

Paper types supported

Paper Types Supported	
Plain Paper	20 to 24 lb (60 to 90 gsm)
Photo Paper	Up to 12 mil (290 gsm)
Card Stock	110 lb index max (200 gsm)
Envelopes	20 to 24 lb (75 to 90 gsm)
Transparencies	All commercially available inkjet varieties (with a white stripe)
Labels	All commercially available inkjet varieties on 8.5 x 11 in. and A4 size sheets
Iron-on Transfers	All commercially available inkjet varieties on 8.5 x 11 in. and A4 size sheets

Paper sizes supported

Paper Sizes Supported	
Usage	Size
Document Page Sizes Labels	A4 (210 x 297 mm) A5 (148 x 210 mm) A6 (105 x 148 mm) B5 (176 x 250 mm) US Executive (7.25 x 10.5 in.) (184 x 266 mm) US Letter (8.5 x 11 in.) (216 x 280 mm) US Legal (8.5 x 14 in.) (216 x 356 mm) Custom sizes from 4–8.5 in. wide and 6–14 in. long
Index Card Stock	4 x 6 in. index cards (101 x 152 mm) 5 x 7 in. index cards (127 x 178 mm)
Transparency Iron-on Transfer	A4 (210 x 297 mm) US Letter (8.5 x 11 in.) (216 x 280 mm)
Label Sizes	C5 (6.38 x 9 in.) (162 x 299 mm) C6 (4.49 x 6.38 in.) (114 x 162 mm) A2 (4.37 x 5.75 in.) (111 x 146 mm) DL (designated long) (4.33 x 8.66 in.) (110 x 220 mm) US #10 (4.12 x 9.5 in.) (105 x 241 mm)
Photo	4 x 6 in. (102 x 152 mm) 4 x 7 in. (102 x 178 mm) 4 x 12 in. (102 x 305 mm) 5 x 7 in. (127 x 178 mm) 8 x 10 in. (203 x 254 mm) US Letter (8.5 x 11 in.) (216 x 280 mm) A4 (210 x 297 mm)
Greeting card	4 x 5.5 in. (101 x 140 mm) 4 x 8 in. (101 x 203 mm)

Safety information

- Always follow all warnings and instructions marked on the product.
- Use only the power source indicated on the product regulatory label.
- Use only the power cord that comes with the product. Using another power cord may cause fire and/or shock. Do not use the included power cord with any other equipment.

- If you do not use this product for a long period of time, unplug it from the electrical outlet.
- Always turn this product off by using the On/Off button. Wait until the On/Off button stops flashing before removing the power plug from the outlet.
- Do not allow the power cord to become damaged or frayed.
- If you need to use an extension cord with this product, make sure that the ampere rating of the product does not exceed the ampere rating of the extension cord.
- Place the product on a flat, stable surface that extends beyond the product's base in all directions. This product will not operate properly if tilted or at an angle.
- When storing or transporting this product, do not tilt or stand it on its side. Never turn this product upside down (ink can leak out of the product).
- Avoid placing this product in an environment that is subject to rapid changes in temperature or humidity, mechanical shocks, vibration, or dust. Do not place near radiators, heating vents, or in direct sunlight.
- Leave enough room around this product for sufficient ventilation.
- Do not block this product's covers or openings, or insert any objects through slots.
- Do not use aerosol products inside or around this product.
- Do not spill any liquid on this product.
- Do not attempt to repair or service this product.
- If the power cord or plug is damaged, if any liquid has been spilled onto the product, if the product has been dropped or the case damaged, if the product does not operate normally or exhibits a major change in performance level, unplug this product and contact Kodak at www.kodak.com/go/contact.

LCD screen safety

- Use only a dry, soft cloth to clean the LCD screen. Do not use any liquid or chemical cleaners.
- If the LCD screen is damaged, contact Kodak immediately. If any of the solution from the display gets on your hands, wash then thoroughly with soap and water. If the liquid crystal solution gets into your eyes, flush your eyes immediately with water. If any discomfort or change in vision persists after washing, seek medical attention immediately.

Ink cartridge safety

- Keep all ink cartridges out of the reach of children.
- If ink gets on your skin, wash with soap and water. If ink gets into your eyes, flush immediately with water. If any discomfort or change in vision persists after washing, seek medical attention immediately.
- For MSDS information on inks, go to www.kodak.com/go/MSDS.

Regulatory compliance

FCC statement

The United States Federal Communications Commission (in CFR 47 Part 15.105) has specified that the following notice be brought to the attention of the users of this product:

Note: This equipment has been tested and found to comply with the limits for a Class B digital device, pursuant to part 15 of the FCC Rules. These limits are designed to provide reasonable protection against harmful interference in a residential installation. This equipment generates, uses, and can radiate radio frequency energy and, if not installed and used in accordance with the instructions, may cause harmful interference to radio communications. However, there is no guarantee that interference will not occur in a particular installation. If this equipment does cause harmful interference to radio or television reception, which can be determined by turning the equipment off and on, the user is encouraged to try to correct the interference by one or more of the following measures:

- Reorient or relocate the receiving antenna.
- Increase the separation between the equipment and receiver
- Connect the product into an outlet on a circuit different from that to which the receiver is connected.
- Consult the dealer or an experienced radio/TV technician for help.

 CAUTION:

Pursuant to Part 15.21 of the FCC Rules, any changes or modifications to this product not expressly approved by Eastman Kodak Company might cause harmful interference and void the FCC authorization to operate this product.

The radiated energy from this product is well below the FCC radio frequency exposure limits. Nevertheless, the product shall be used in such a manner that the potential for human contact during normal operation is minimized. This product and any attached external antenna, if supported, shall be placed in such a manner to minimize the potential for human contact during normal operation. In order to avoid the possibility of exceeding the FCC exposure limits, human proximity shall not be less than 20 cm (8 inches) during normal operation.

Canadian statements

This product meets the applicable Industry Canada technical specifications.

Operation is subject to the following two conditions: (1) this device may not cause interference, and (2) this device must accept any interference, including interference that may cause undesired operation of the device.

This Class B digital apparatus complies with Canadian ICES-003.

Industry Canada (IC) Radiation Exposure Statement

This equipment complies with IC radiation exposure limits set forth for an uncontrolled environment. This equipment should be installed and operated with a minimum distance of 20 cm between the radiator and your person.

German compliance statement

Noise emissions for this equipment do not exceed 70 dBa.

This equipment is not intended for use in the work place in accordance with BildscharbV regulations.

“Das Gerät ist nicht für die Benutzung am Bildschirmarbeitsplatz gemäß BildscharbV vorgesehen.”

REACH Article 33 declarations

Go to www.kodak.com/go/REACH for information about the presence of substances included on the candidate list according to article 59(1) of Regulation (EC) No. 1907/2006 (REACH).

Waste electrical and electronic equipment labeling



In the European Union, do not discard this product as unsorted municipal waste. Contact your local authorities or go to www.kodak.com/go/recycle for recycling program information.

ENERGY STAR® Qualified



ENERGY STAR and the ENERGY STAR mark are registered U.S. service marks. As an ENERGY STAR partner, KODAK has determined that this product meets ENERGY STAR Guidelines for energy efficiency. For more information on the ENERGY STAR program, see www.energystar.gov.

Warranty Information

Limited Warranty

Kodak warrants Kodak consumer electronic products and accessories ("Products"), excluding batteries, to be free from malfunctions and defects in both materials and workmanship for one year from the date of purchase. Retain the original dated sales receipt. Proof of the date of purchase will be required with any request for warranty repair.

Limited Warranty Coverage

Warranty service is only available from within the country where the Products were originally purchased. You may be required to send Products, at your expense, to the authorized service facility for the country where the Products were purchased. Kodak will repair or replace Products if they fail to function properly during the warranty period, subject to any conditions and/or limitations stated herein. Warranty service will include all labor as well as any necessary adjustments and/or replacement parts. If Kodak is unable to repair or replace a Product, Kodak will, at its option, refund the purchase price paid for the Product provided the Product has been returned to Kodak together with proof of the purchase price paid. Repair, replacement, or refund of the purchase price are the sole remedies under this warranty. If replacement parts are used in making repairs, those parts may be remanufactured or may contain remanufactured materials. If it is necessary to replace the entire Product, it may be replaced with a remanufactured Product. Remanufactured Products, parts and materials are warranted for the remaining warranty term of the original Product, or 90 days after the date of repair or replacement, whichever is longer.

Limitations

This warranty does not cover circumstances beyond Kodak's control. This warranty does not apply when failure is due to shipping damage, accident, alteration, modification, unauthorized service, misuse, abuse, use with incompatible accessories or attachments (such as third party ink or ink tanks), failure to follow Kodak's operation, maintenance or repacking instructions, failure to use items supplied by Kodak (such as adapters and cables), or claims made after the duration of this warranty. KODAK MAKES NO OTHER EXPRESS OR IMPLIED WARRANTY FOR THIS PRODUCT, AND DISCLAIMS THE IMPLIED WARRANTIES AND CONDITIONS OF MERCHANTABILITY AND FITNESS FOR A PARTICULAR PURPOSE. In the event that the exclusion of any implied warranty is ineffective under the law, the duration of the implied warranty will be one year from the purchase date or such longer period as required by law. The option of repair, replacement, or refund is Kodak's only obligation. Kodak will not be responsible for any special, consequential or incidental damages resulting from the sale, purchase, or use of this product regardless of the cause. Liability for any special consequential or incidental damages (including but not limited to loss of revenue or profit, downtime costs, loss of the use of the equipment, cost of substitute equipment, facilities or services or claims of your customers for such damages resulting from the purchase, use or failure of the Product), regardless of cause, or for breach of any written or implied warranty is expressly disclaimed.

Your Rights

Some states or jurisdictions do not allow exclusion or limitation of incidental or consequential damages, so the above limitation or exclusion may not apply to you. Some states or jurisdictions do not allow limitations on how long an implied warranty lasts, so the above limitation may not apply to you. This warranty gives you specific rights, and you may have other rights which vary from state to state or by jurisdiction. Your statutory rights are not affected.

Outside the United States and Canada

In countries other than the United States and Canada, the terms and conditions of this warranty may be different. Unless a specific Kodak warranty is communicated to the purchaser in writing by a Kodak company, no warranty or liability exists beyond any minimum requirements imposed by law, even though defect, damage, or loss may be by negligence or other act.

Declaration of Conformity



Manufacturer's Name: Eastman Kodak Company
Manufacturer's Address: 16275 Technology Drive
San Diego, CA 92127, USA

Declares our sole responsibility that the product

Product Name: KODAK ESP 3250 All-in-One Printer
Power adapters: HP-A0601R3, VP-09500084-000
Radio Module Number: US101

conforms to the following Product Specifications:

Safety: IEC 60950-1:2001
EN 60950-1:2001 + A11:2004
UL 60950-1:2003 R7.06
CAN/CSA-C22.2 No. 60950-1-03

EMC: EN 55022:2006+A1:2007, Class B
CISPR 22:1997 Class B
EN 61000-3-2:2006, Class A
EN 61000-3-3:1995+A1:2001 + A2:2005
AS/NZS CISPR 22:2006, Class B
EN 61000-4-2:1995 + A1:1998 + A2:2001
EN 61000-4-3:2006 + A1:2008
EN 61000-4-4:2004
EN 61000-4-11:2004
EN 61000-4-8:2001 ED 1.1
CFR 47, FCC Part 15, Subpart B, Class B
EN 61000-4-5:2006
EN 61000-4-6:2007
ICES-003:2004 Class B
ANSI C63.4-2003

Radio: EN 301 489-1 V1.8.1 (2008-04)
EN 301 489-17 V1.3.2 (2008-04)
AS/NZS 4268:2003 + A1:2005 + A2:2006

The product herewith complies with the requirements of the Low Voltage Directive 2006/95/EC, the EMC Directive 2004/108/EC and carries the CE marking. In addition, it complies with the WEEE Directive 2002/96/EC and RoHS Directive 2002/95/EC.

The product was tested in a typical configuration.

Index

B

Back button, 2
Black print speed, 38

C

Cancel button, 2
Changing ink cartridges. *See* Replacing ink cartridges
Cleaning the printer, 24
Components, printer, 1
Configuring your printer, 4
 basic printer settings, 4
 setting printer as the default printer, 5
Control panel, 1, 2
Copies
 adjusting settings, 20
 changing document options, 17
 changing photo options, 19
 darkening or lightening, 21
 enlarging or reducing a photo, 20
 enlarging or reducing documents, 20
 making, 17
Copy document features, 39
Copy photo features, 39

D

Darkening copies, 21
Date and time
 setting, 4
 synchronizing to your computer, 4
Default printer settings, resetting, 4
Document paper sizes, 43
Downloading latest software and firmware, 36
DPOF. *See* Tagged images printing

E

Energy Star qualification, 46
Enlarging or reducing a copy
 document, 20
 photo, 20
Envelopes
 capacity, 11
 loading, 11
 sizes, 9
Extender, paper tray, 1

F

FAQs, Web support, 36
Firmware, downloading, 36

G

Glass, scanner, 1
Greeting card size paper, 43
Guides
 left paper-edge, 1
 right paper-edge, 1

H

Home button, 2
Home Center Software, 3
 for MACINTOSH Computers, 3
 Maintenance pane, 3
 Select pane, 3
 Tools pane, 3
 for WINDOWS OS-based computers, 3
Help icon, 3
Home icon, 3
Tools icon, 3

I

Image Capture software, 16
Image formats supported, 40
Index card stock sizes, 43
Ink cartridge
 replacing, 27
Ink levels, 27
iPhoto software, 16
Iron-on transfers, 43

K

KODAK Home Center Software. *See* Home Center Software

L

Label sizes, 43
Language, setting, 4
LCD, 1, 2
Left paper-edge guide, 1
Lid, scanner, 1
Lightening copies, 21
Lights
 power status, 37
Loading paper
 envelopes, 11
 photo, 10
 plain, 9

M

Maintenance, 24
 Marked images, printing. *See* Tagged images
 Media supported, 42
 Memory card slot, 1
 Memory cards
 printing pictures from, 13
 types compatible with printer, 13
 Monitoring printer performance, 35

N

Navigation buttons, 2

O

OK button, 2
 On/Off button, 2
 Overview of printer, 1

P

Panoramic photos, printing, 16
 Paper, 8
 loading
 envelopes, 11
 photo paper, 10
 plain paper, 9
 sizes, 8
 sizes supported, 43
 types, 8
 types supported, 42
 Paper stop, 1
 Paper tray, 1
 Paper tray capacity
 envelopes, 11
 photo paper, 10
 plain paper, 9
 Paper tray extender, 1
 Photo paper
 capacity, 10
 loading, 10
 Photo paper sizes, 43
 Photo printing features, 38
 Plain paper
 capacity, 9
 loading, 9
 Ports
 power cord connection, 1
 USB, 1
 Power status light, 37
 Print photos options, 12
 Print sizes, 38
 Printer access door, 1
 Printer performance, monitoring and
 adjusting, 35

Printer supplies
 maintaining, 24
 recycling, 24
 Printhead
 removing, 31
 replacing, 30
 Printhead with ink cartridges installed, 1
 Printing
 panoramic photos, 16
 tagged image photos, 15
 Protecting the printer, 24

R

Rear-access cleanout area, 1
 Recycling printer or supplies, 24
 Reducing or enlarging a copy
 document, 20
 photo, 20
 Removing the printhead, 31
 Replacing ink cartridges, 27
 Right paper-edge guide, 1

S

Scanner
 glass, 1
 lid, 1
 Scanning, 22
 changing settings in Home Center
 Software, 22
 multiple pictures simultaneously, 23
 Service agreements, 24
 Settings
 basic printer, 4
 Software support, 40
 Software, downloading, 36
 Start button, 2
 Step-by-step solutions and repair, 36
 Stop, paper, 1
 System requirements, 36

T

Tagged images
 printing, 15
 setting, 4
 Time to low power, setting, 4
 Transferring pictures to a computer, 16
 Transparency sizes, 43
 Tray capacity
 envelopes, 11
 photo paper, 10
 plain paper, 9
 Tray, paper, 1
 Troubleshooting, 36

U

USB port, 1

W

Warranty, 40

Water exposure, troubleshooting, 24

Web support

www.kodak.com/go/esp3250downloads, 36

www.kodak.com/go/esp3250specs, 36

www.kodak.com/go/esp3250support, 36

www.kodak.com/go/inkjetnetworking, 36

www.kodak.com/go/itg, 36

www.kodak.com/go/recycle, 24

Free Manuals Download Website

<http://myh66.com>

<http://usermanuals.us>

<http://www.somanuals.com>

<http://www.4manuals.cc>

<http://www.manual-lib.com>

<http://www.404manual.com>

<http://www.luxmanual.com>

<http://aubethermostatmanual.com>

Golf course search by state

<http://golfingnear.com>

Email search by domain

<http://emailbydomain.com>

Auto manuals search

<http://auto.somanuals.com>

TV manuals search

<http://tv.somanuals.com>