

Installation and Operating Guide | Warranty

Model Number | DVT412 | DVD/CD Player • AM-FM Receiver with Speaker System
(Speakers: LHS-D6245T/LHS-D6245W)



© Copyright 2004, LG Electronics U.S.A., Inc.



Safety Precautions

This lightning flash with arrowhead symbol within an equilateral triangle is intended to alert the user to the presence of uninsulated dangerous voltage within the product's enclosure that may be of sufficient magnitude to constitute a risk of electric shock to persons.

The exclamation mark within an equilateral triangle is intended to alert the user to the presence of important operating and maintenance (servicing) instructions in the instructions accompanying the product.

WARNING: Do not install this equipment in a confined space such as a book case or similar unit.

CAUTION:

This Digital Disc Receiver employs a Laser System.

To ensure proper use of this product, please read this owner's manual carefully and retain it for future reference. Should the unit require maintenance, contact an authorized service center—see back page for instructions.

Performing controls, adjustments, or carrying out procedures other than those specified herein may result in hazardous radiation exposure.

To prevent direct exposure to laser beam, do not try to open the enclosure. Visible laser radiation when open. **DO NOT STARE INTO BEAM.**

CAUTION: The apparatus should not be exposed to water (dripping or splashing) and no objects filled with liquids, such as vases, should be placed on the apparatus.

REGULATORY INFORMATION:

FCC Part 15

This product has been tested and found to comply with the limits for a Class B digital device, pursuant to Part 15 of the FCC Rules. These limits are designed to provide reasonable protection against harmful interference when the product is operated in a residential installation. This product generates, uses and can radiate radio frequency energy and, if not installed and used in accordance with the instruction manual, may cause harmful interference to radio communications. However, there is no guarantee that interference will not occur in a particular installation. If this product does cause harmful interference to radio or television reception, which can be determined by turning the product off and on, the user is encouraged to try to correct the interference by one or more of the following measures:

- Reorient or relocate the receiving antenna.
- Increase the separation between the product and receiver.
- Connect the product into an outlet on a circuit different from that to which the receiver is connected.
- Consult the dealer or an experienced radio/TV technician for help.

FCC WARNING: This equipment may generate or use radio frequency energy. Changes or modifications to this equipment may cause harmful interference unless the modifications are expressly approved in the instruction manual. The user could lose the authority to operate this equipment if an unauthorized change or modification is made.

FCC COMPLIANCE: The responsible party for this product's compliance is:

LG Electronics U.S.A., Inc.
1000 Sylvan Avenue
Englewood Cliffs, NJ
07632, USA
Phone: 1-201-816-2125

Notes on copyrights:

It is forbidden by law to copy, broadcast, show, broadcast via cable, play in public, or rent copyrighted material without permission.

This product is equipped with copy protection measures developed by Macrovision. Copy protection signals are recorded on some discs. When recording these discs on a VCR, picture noise will appear during playback.

This product incorporates copyright protection technology that

IMPORTANT SAFETY INSTRUCTIONS

CAUTION: PLEASE READ AND OBSERVE ALL WARNINGS AND INSTRUCTIONS IN THIS OWNER'S MANUAL AND THOSE MARKED ON THE UNIT. RETAIN THIS MANUAL FOR FUTURE REFERENCE.

This set has been designed and manufactured to assure personal safety. Improper use can result in electric shock or fire hazard. The safeguards incorporated in this unit will protect you if you observe the following procedures for installation, use, and servicing.

This unit does not contain any parts that can be repaired by the user.

DO NOT REMOVE THE CABINET COVER, OR YOU MAY BE EXPOSED TO DANGEROUS VOLTAGE. REFER SERVICING TO QUALIFIED SERVICE PERSONNEL ONLY.

- 1. Read these instructions.** - All these safety and operating instructions should be read before the product is operated.
- 2. Keep these instructions.** - The safety, operating and use instructions should be retained for future reference.
- 3. Heed all warnings.** - All warnings on the product and in the operating instructions should be adhered to.
- 4. Follow all instructions.** - All operating and use instructions should be followed.
- 5. Do not use this apparatus near water.** - For example: near a bath tub, wash bowl, kitchen sink, laundry tub, in a wet basement; or near a swimming pool; and like.
- 6. Clean only with dry cloth.** - Unplug this product from the wall outlet before cleaning. Do not use liquid cleaners.
- 7. Do not block any ventilation openings. Install in accordance with the manufacturer's instructions.** - Slots and openings in the cabinet are provided for ventilation and to ensure reliable operation of the product and to protect it from over- heating. The openings should never be blocked by placing the product on a bed, sofa, rug or other similar surface. This product should not be placed in a built-in installation such as a bookcase or rack unless proper ventilation is provided or the manufacturer's instructions have been adhered to.
- 8. Do not install near any heat sources such as radiators, heat registers, stoves, or other apparatus (including amplifiers) that produce heat.**
- 9. Do not defeat the safety purpose of the polarized or grounding-type plug. A polarized plug has two blades with one wider than the other. A grounding type plug has two blades and a third grounding prong. The wide blade or the third prong are provided for your safety. If the provided plug does not fit into your outlet, consult an electrician for replacement of the obsolete outlet.**
- 10. Protect the power cord from being walked on or pinched particularly at plugs, convenience receptacles, and the point where they exit from the apparatus.**
- 11. Only use attachments/accessories specified by the manufacturer.**
- 12. Use only with the cart, stand, tripod, bracket, or table specified by the manufacturer, or sold with apparatus. When a cart is used, use caution when moving the cart/apparatus combination to avoid injury from tip-over.**
- 13. Unplug this apparatus during lightning storms or when unused for long periods of time.**
- 14. Refer all servicing to qualified service personnel. Servicing is required when the apparatus has been damaged in any way, such as power-supply cord or plug is damaged, liquid has been spilled or objects have fallen into the apparatus, the apparatus has been exposed to rain or moisture, does not operate normally, or has been dropped.**



Table of Contents

Introduction

Safety Precautions	2
IMPORTANT SAFETY INSTRUCTIONS	3
Table of Contents	4
Overview	5-6
Playable Discs	5
Precautions	6
Notes about Discs	6
About Symbols	6
Front Panel Controls and Display Window	
Indicators	7
Remote Control Buttons	8
Rear Panel Connections	9

Installation

Connections	10-14
TV Connections	10
External Equipment Connections	11
AM-FM Antenna Connections	12
Speaker System Connections	13
Speaker Placement	14
Pre-operation	15-19
Mini Glossary for Audio Stream & Surround	
Mode	15
Sound Mode	15
DVD/CD player Overview	16
On-Screen Displays	16
Initial Setup	17-19
• <i>Initial Setup and Operation Overview</i>	17
• <i>Language</i>	17
• <i>Picture</i>	17
• <i>Speaker Setup</i>	18
• <i>Others</i>	19
• <i>Parental Control</i>	19

Operation

DVD Operation	20-22
DVD Playback	20
General Features	20
• <i>TITLE Selection</i>	20
• <i>CHAPTER/TRACK Selection</i>	20
• <i>Search</i>	20
• <i>Pause</i>	20
• <i>Still Picture and Frame-by-Frame Playback</i>	21
• <i>Slow Motion</i>	21
• <i>Repeat A-B</i>	21
• <i>Repeat</i>	21
• <i>Time Search</i>	21
• <i>3D Surround</i>	22
• <i>Zoom</i>	22
• <i>Marker Search</i>	22
Special DVD Features	22
• <i>Title Menu</i>	22
• <i>Disc Menu</i>	22
• <i>Camera Angles</i>	22
• <i>Changing the Audio Language</i>	22
• <i>Changing the Audio Channel</i>	22
• <i>Subtitles</i>	22

Audio CD and MP3/WMA Disc Operation 23-24

Playing Audio CD or MP3/WMA Discs	23
Notes on MP3/WMA Recordings	23
• <i>Pause</i>	24
• <i>Changing Tracks</i>	24
• <i>Repeat Track/All/Off</i>	24
• <i>Search</i>	24
• <i>Repeat A-B</i>	24
• <i>3D Surround</i>	24
• <i>Changing Audio Channels</i>	24

JPEG File Operation 25

Viewing JPEG Files	25
• <i>Changing Files</i>	25
• <i>Still Picture</i>	25
• <i>Flipping the Picture</i>	25
• <i>Rotating the Picture</i>	25
• <i>Notes on JPEG Files</i>	25

Programmed Playback 26

Audio CD and MP3/WMA Disc Programmed	
Playback	26

Speaker Setup 27

Additional Information 27

Radio Operation 28

Presetting Radio Stations	28
Listening to the Radio	28

Other Functions 29

Sleep Timer Setup	29
Dimmer	29
Mute	29
Using Headphones	29

Reference

Language Code List	30
Country Code List	31
Troubleshooting	32-33
Specifications	34

About the symbols for instructions

 Indicates hazards likely to harm the unit itself or cause other material damage.

 Indicates special operating features of this unit.



 Indicates tips and hints for making the task easier.

Manufactured under license from Dolby Laboratories. "Dolby", "Pro Logic", "MLP Lossless" and the double-D symbol are trademarks of Dolby Laboratories.

Manufactured under license from Digital Theater Systems, Inc. US Pat. No. 5,451,942 5,956,674, 5,974,380, 5,978,762 and other worldwide patents issued and pending. "DTS" and "DTS Digital Surround" are registered trademarks of Digital Theater Systems, Inc. Copyright 1996, 2000 Digital Theater Systems, Inc. All rights reserved.

Before Use

Playable Discs

	DVD (8 cm / 12 cm disc)
	Audio CD (8 cm / 12 cm disc)

In addition, this unit can play a DVD-RW, DVD+RW, Kodak PICTURE CD, CD-R or CD-RW that contains audio titles, MP3, WMA, or JPEG files.

Notes

- Depending on the conditions of the recording equipment or the CD-R/RW (or DVD-RW, DVD+RW) disc itself, some CD-R/RW (or DVD-RW, DVD+RW) discs cannot be played on the unit.
- Do not attach any seal or label to either side (the labeled side or the recorded side) of a disc.
- Do not use irregularly shaped CDs (e.g., heart-shaped or octagonal). It may result in malfunctions.

Notes on DVDs

Some playback operations for DVDs may be intentionally fixed by the software manufacturer. As this unit plays DVDs according to disc content designed by the software manufacturer, some playback features of the unit may not be available or other functions may be added. Make sure to also refer to the instructions supplied with the DVDs. Some DVDs made for business purposes may not be able to be played on the unit.

Regional code of the DVD/CD player and DVDs

This DVD/CD player is designed and manufactured for playback of region "1" encoded DVD software. The region code on the labels of some DVDs indicates which type of player can play those discs. This unit can only play DVDs labeled "1" or "ALL". If you try to play any other discs, the message "Check Regional Code" will appear on the TV screen. Some DVDs that have no region code label may still be subject to area restrictions and therefore not playable.



Disc-related terms

Title (DVD only)

The main film content, accompanying feature content, additional feature content, or music album. Each title is assigned a title reference number enabling you to locate it easily.

Chapter (DVD only)

Sections of a picture or a musical piece that are smaller than titles. A title can be composed of only one or several chapters. Each chapter is assigned a chapter number, enabling you to locate the chapter you want. Depending on the disc, chapters may not be recorded.

Track (Audio CD only)

Sections of a picture or a musical piece on an audio CD. Each track is assigned a track number, enabling you to locate the track you want.

Before Use (Continued)

Precautions

Handling the unit

Shipping the unit

Use the original shipping carton and packing materials may come in handy. For maximum protection, re-pack the unit as it was originally packed at the factory.

Setting up the unit

The picture and sound of a nearby TV, VCR, or radio may be affected during DVD playback. In this case, position the unit away from the TV, VCR, or radio, or remove the disc and turn off the unit.

Keeping the exterior surfaces clean

Do not use volatile liquids, such as insecticide spray, near the unit. Do not leave rubber or plastic products in contact with the unit for a long period of time. They will leave marks on the surface.

Cleaning the unit

To clean the cabinet

Use a soft, dry cloth. If the surfaces are extremely dirty, use a soft cloth lightly moistened with a mild detergent solution. Do not use strong solvents such as alcohol, benzene, or thinner, as these might damage the surface of the unit.

To obtain a clear picture

The DVD/CD player is a high-tech, precision device. If the optical pick-up lens and disc drive parts are dirty or worn, the picture quality will be poor. Regular inspection and maintenance are recommended after every 1,000 hours of use. (This depends on the operating environment.) For details, please contact your nearest dealer.

Notes on Discs

Disc Handling

Do not touch the playback side of the disc. Hold the disc by the edges so that fingerprints will not get on the surface. Do not stick paper or tape on the disc.

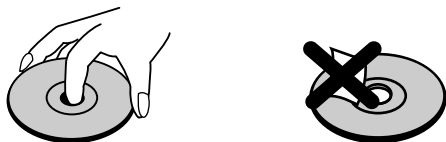

Storing discs

After playing, store the disc in its case. Do not expose the disc to direct sunlight or sources of heat, or leave it in a parked car exposed to direct sunlight, as there may be a considerable temperature increase inside the car.

Cleaning discs

Fingerprints and dust on the disc can distort the picture or reduce sound quality. Before playing, clean the disc with a clean cloth. Wipe the disc from the centre outwards.

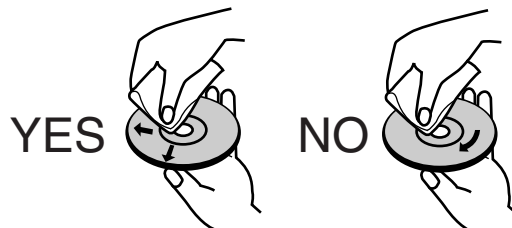

Do not use strong solvents such as alcohol, benzene, thinner, commercially available cleaners, or anti-static spray intended for vinyl records.





About Symbols

About the symbol display

" " may appear on the TV screen during operation. This icon means the function explained in this owner's manual is not available on that specific DVD video disc.

About the disc symbols for instructions

A section whose title has one of the following symbol is applicable only to the disc represented by the symbol.

-  DVD
-  Audio CDs.
-  MP3 disc.
-  WMA disc.
-  JPEG files on a disc.

Front Panel Controls/ Display Window Indicators

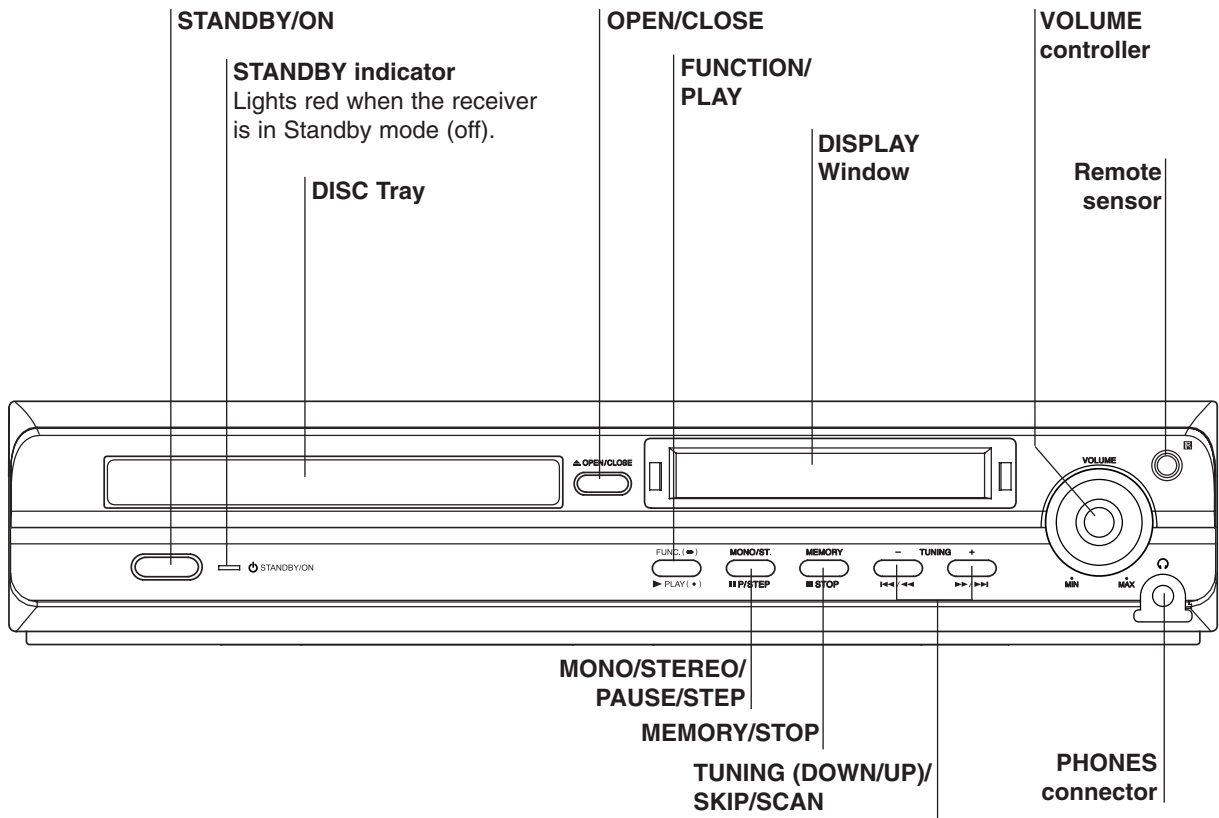

INTRODUCTION

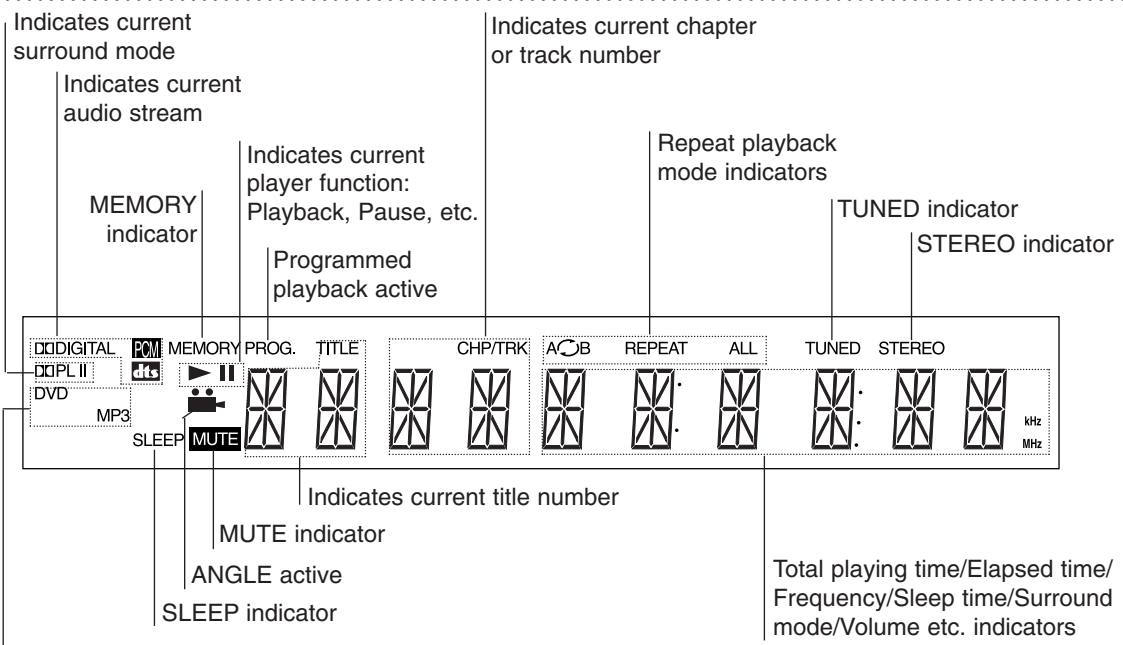

DVD DVD disc loaded
MP3 MP3 disc loaded

Remote Control Buttons

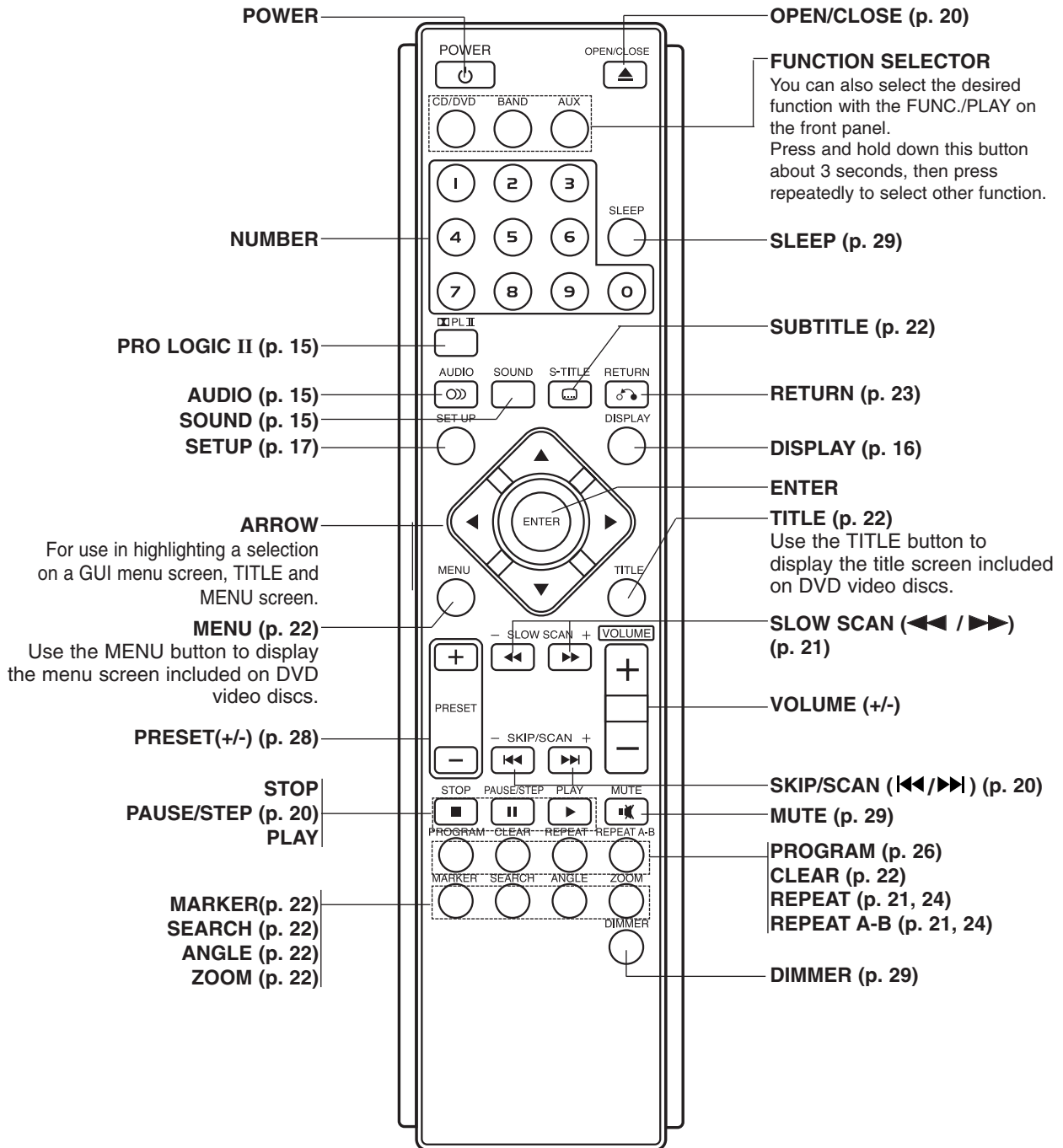

Remote Control Operation Range

Point the remote control at the remote sensor and press the buttons.

- **Distance:** About 23 ft (7 m) from the front of the remote sensor
- **Angle:** About 30° in each direction in front of the remote sensor

Remote control battery installation

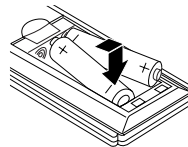

Remove the battery cover on the rear of the remote control, and insert two R03 (size AAA) batteries with **+** and **-** aligned correctly.

⚠ Caution

Do not mix old and new batteries. Never mix different types of batteries (standard, alkaline, etc.).

Rear Panel Connections

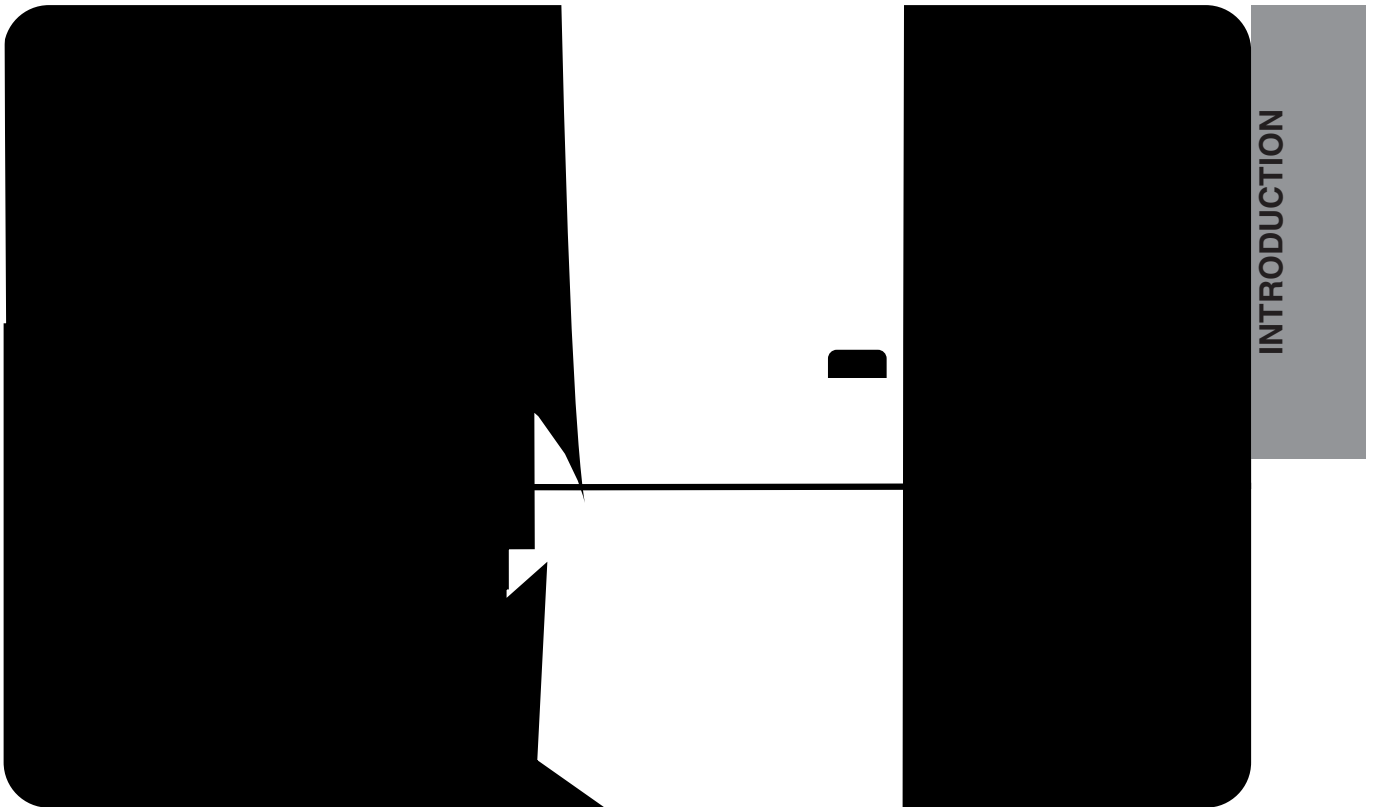

Do not touch the inner pins of the jacks on the rear panel. Electrostatic discharge may cause permanent damage to the unit.

Connections

TV Connections

- Make one of the following connections, depending on the capabilities of your existing equipment.

Tips

- Depending on your TV and other equipment you wish to connect, there are various ways you could connect the DVD/CD player. Use one of the connections described below.
- Please refer to the manuals of your TV, VCR, Stereo System or other devices as necessary to make the best connections.

Caution

- Make sure the DVD/CD player is connected directly to the TV. Select the correct AV input on your TV.
- Do not connect your DVD/CD player to TV via your VCR. The DVD image could be distorted by the copy protection system.

Video connection

Connect the MONITOR OUT jack from the DVD/CD player to the video in jack on the TV using the video cable supplied (**V**).

S-Video connection

Connect the S-VIDEO OUT jack on the DVD/CD player to the S-Video in jack on the TV using the S-Video cable (**S**).

Component Video (Color Stream®) connection

Connect the COMPONENT VIDEO OUT/PROGRESSIVE SCAN jacks from the DVD/CD player to the corresponding in jacks on the TV using an Y Pb Pr cable (**C**).

Progressive Scan (ColorStream® pro) connection

- If your television is a high-definition or “digital ready” television, you may take advantage of the DVD/CD player’s progressive scan output for the highest video resolution possible.
- If your TV does not accept the Progressive Scan format, the picture will appear scrambled if you try Progressive Scan on the DVD/CD player.

Connect the COMPONENT VIDEO OUT/ PROGRESSIVE SCAN jacks from the DVD/CD player to the corresponding in jacks on the TV using an optional Y Pb Pr cable (**C**).

Note

- Set the Progressive to “On” on the Setup menu for progressive signal, see page 17.

Rear of TV

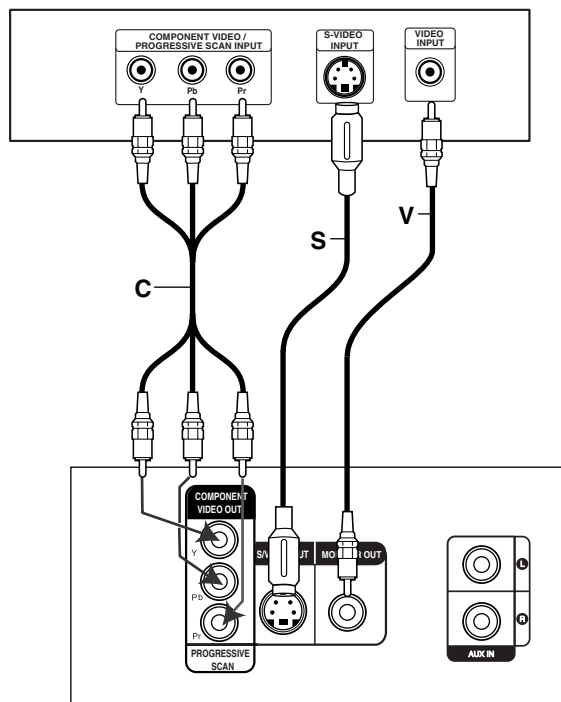

Rear of DVD/CD player

Connections (Continued)

External Equipment Connections

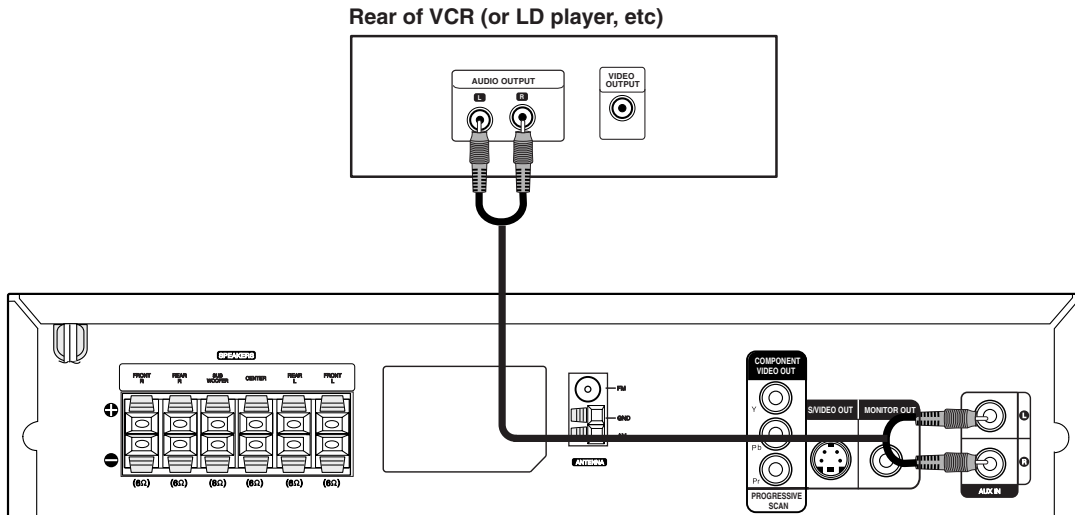

Connection

Connect the AUX IN (L/R) jacks on the DVD/CD receiver to the AUDIO OUT (L/R) jacks on the VCR, LD player, etc using the audio cables.

Tip

Press AUX on the remote control to select input to these jacks. AUX appears on the Display Window.

Connections

AM-FM Antenna Connections

Connect the supplied FM/AM antennas for listening to the radio.

- Connect the AM loop antenna to the AM antenna terminals.
- Connect the FM wire antenna to the FM antenna terminals.

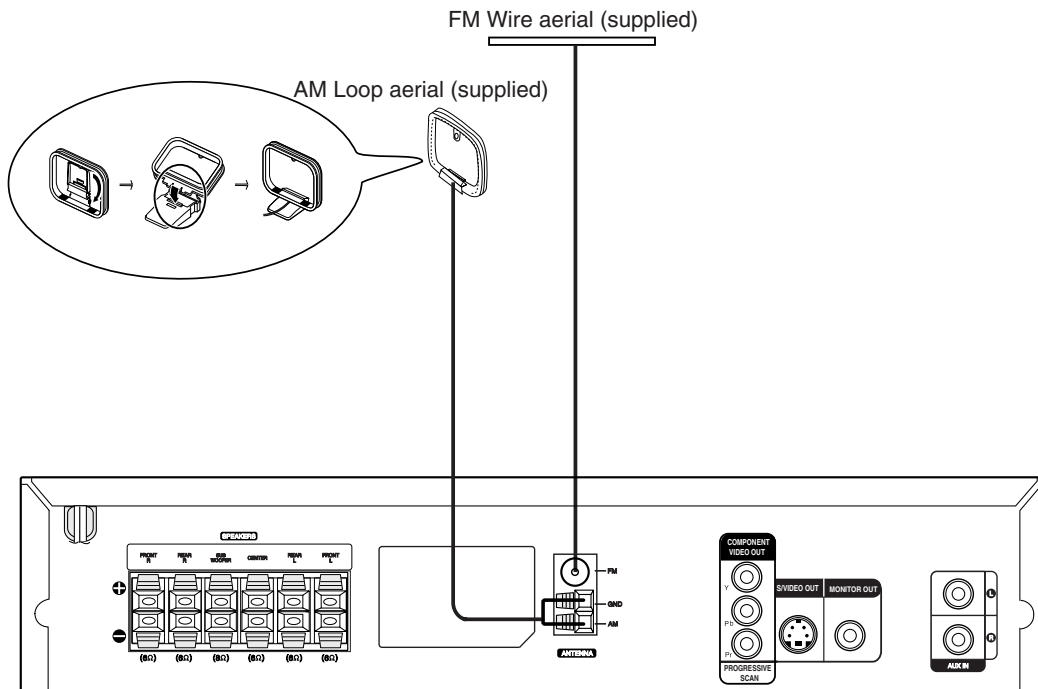

Notes

- To prevent noise pickup, keep the AM loop antenna away from the DVD/CD receiver and other components.
- Be sure to fully extend the FM wire antenna.
- After connecting the FM wire antenna, keep it as horizontal as possible.

Connections (Continued)

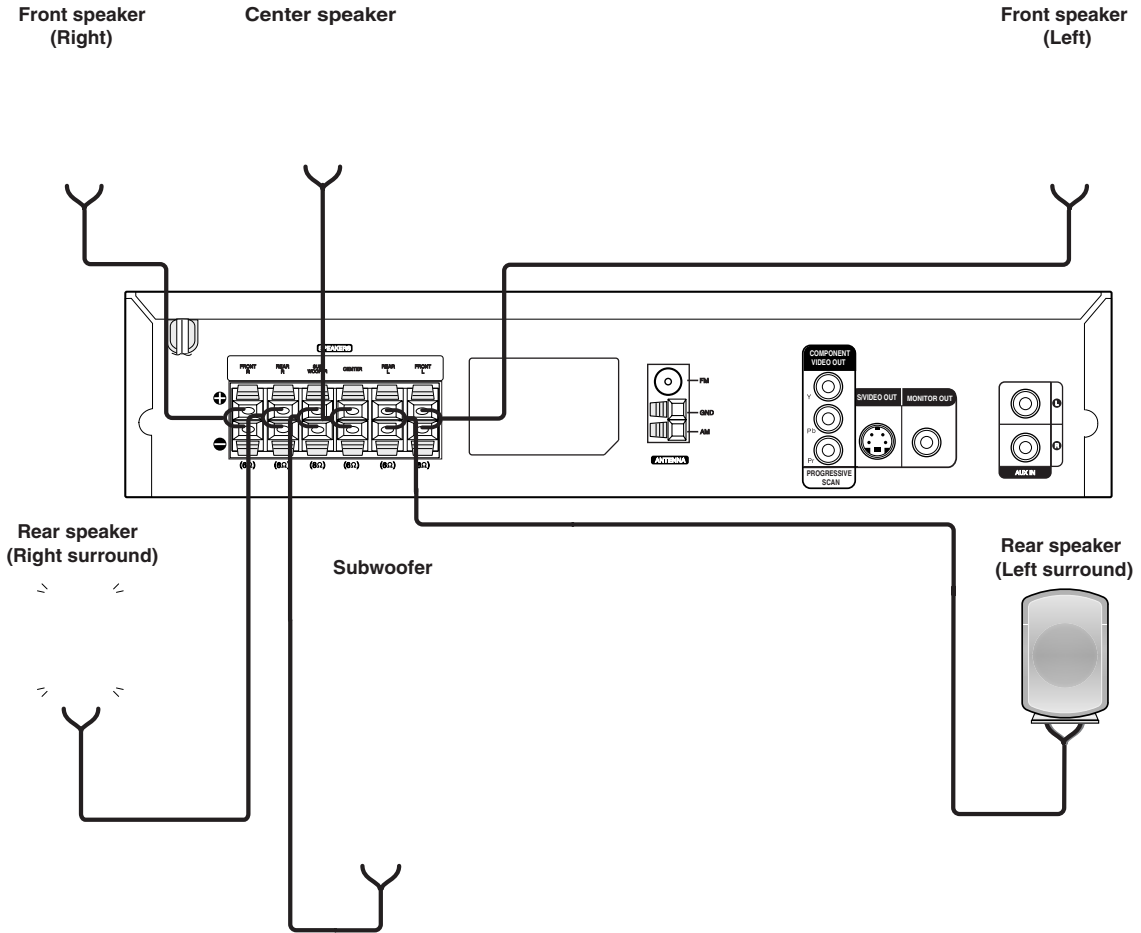

PREPARATION

Connections (Continued)

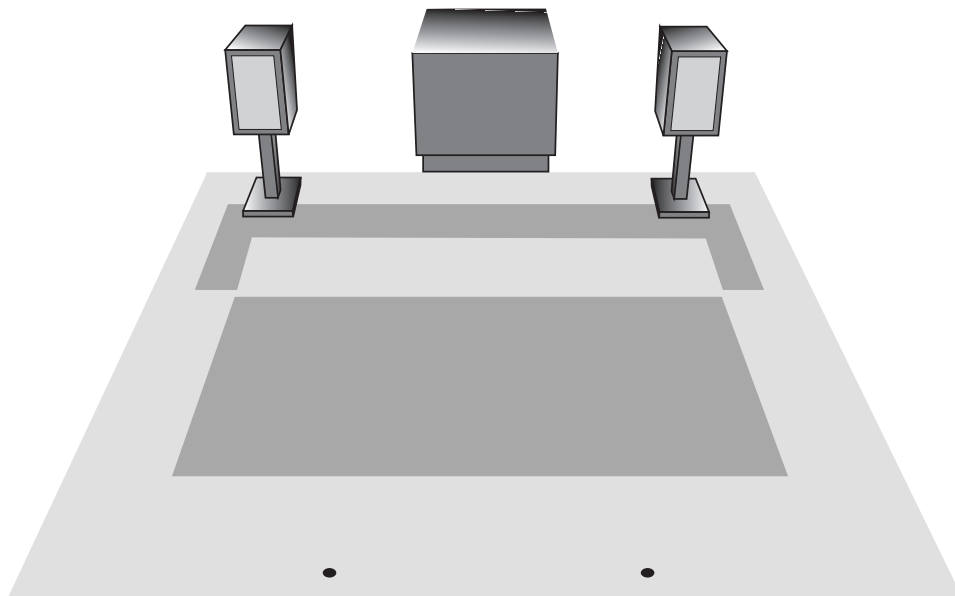

Operation

Glossary for Audio Stream

Surround mode

5.1 (or 6) discrete channels of high frequency audio from program sources such as disc or digital sources bearing the trademark. DTS is a registered trademark of Digital Theater Systems, Inc. (DTS Technology, Ltd.). DTS is a 5.1 (or 6) channels of transparent digital audio (original masters) and results in a 360 degree sound field. DTS is a registered trademark of DTS Technology, Ltd. DTS is a registered trademark of DTS Technology, Ltd.

you can enjoy a more spacious sound field. The effect of the front/back/left/right channel arrangement, as well as the sense of fixity, is much clearer and more dynamic.

or Dolby Digital. This mode provides a more concert house - an effect obtained through DOLBY DIGITAL. The effect of the front/back/left/right channel arrangement, as well as the sense of fixity, is much clearer and more dynamic.

Dolby Digital creates five full-bandwidth output channels from two channel sources. This is done using an advanced, high resolution surround decoder that extracts the spatial information from the original recording without adding any new colorations.

mode is for use with stereo television shows and all audio encoded in Dolby Surround. The result is enhanced directional sound that approaches the quality of discrete channel sound.

Music Mode:

Music mode is for use with any stereo music recording.

MATRIX Mode:

Matrix mode is the same as the Music mode except that the directional enhancement logic is turned off. It may be used to enhance mono signals by making them seem "larger." Matrix mode may also find use in auto systems, where situations from poor FM stereo reception can otherwise be disturbing surround signals from a logic decoder. A "cure" for poor FM stereo reception may be to switch audio to mono.

3D SURROUND

This unit can produce a 3D Surround Sound effect using Sound technology, which simulates sound coming back from two conventional speakers or more speakers normally. The audio from a home theater system encoded with Dolby Digital is also available.

BYPASS

Software bypass is available for all audio sources.

When is it used?

You can select the surround mode of DVD (Dolby Digital, DTS, PRO LOGIC) by pressing the **AUDIO** button repeatedly on the remote during playback. Although the DVD contents differ from disc-to-disc, the following explains the basic operation when this feature is used.

Each time you press **AUDIO** button, the sound mode of DVD is changed in the following order;

Matrix → DTS → Dolby Digital → Stereo

Remembers the last mode

Can be individually.

Encoding format of program

packaging.

Programs are labeled with the  logo.

Programs are labeled with the  logo.

Programs are labeled with the  logo.

Sampling frequency

48 kHz (sampling

is used.

Pre-Operation (Continued)

DVD/CD player Overview

This manual gives basic instructions for operating the DVD/CD player. Some DVDs require specific operation or allow only limited operation during playback. When this occurs, the symbol  appears on the TV screen, indicating that the operation is not permitted by the DVD/CD player or is not available on the disc.







On-Screen Displays

General playback status can be displayed on the TV screen. Some menu options can be changed on the menu.

On-screen display operation

- 1** Press DISPLAY during playback.
- 2** Use ▲/▼ to select a menu option.
The selected option will be highlighted.
- 3** Use ◀/▶ to change the setting of a option.
The number buttons can be also be used for setting numbers (e.g., title number). For some functions, press ENTER to execute the setting.







Playback Status Displays

-  TITLE Repeat Title
-  CHAPT Repeat Chapter
-  A B Repeat A-B
-  OFF Repeat Off
-  II Resume play from this point
-  Action prohibited or not available

Notes

- Some discs may not provide all of the features on the on-screen display example shown below.
- If no button is pressed for 10 seconds, the on-screen display disappears.

DVD

Menu Options	Function (Use ▲/▼ to select desired option)	Selection Method
Title Number  1 / 3	Shows the current title number and total number of titles, and skips to the desired title number.	◀ / ▶, or Numbers, ENTER
Chapter Number  1 / 12	Shows the current chapter number and total number of chapters, and skips to the desired chapter number.	◀ / ▶, or Numbers, ENTER, SKIP
Time search  0:20:09	Shows the elapsed playing time, and searches the point directly from the elapsed time.	Numbers, ENTER
Audio language and Digital Audio Output mode  1 ENG □□□□ 5.1 CH	Shows the current audio soundtrack language, encoding method, and channel number, and changes the setting.	◀ / ▶, or AUDIO
Subtitle language  OFF	Shows the current subtitles language, and changes the setting.	◀ / ▶, or SUBTITLE
Angle  1 / 1	Shows the current angle number and total number of angles, and changes the angle number.	◀ / ▶, or ANGLE
Sound  BYPASS	Shows the current sound mode, and changes the setting.	◀ / ▶, or SOUND

PRE-OPERATION

Pre-Operation (Continued)

Speaker Setup

5.1 Speaker settings **DVD**

Select speaker settings, including volume balance and delay time, or test the speaker settings.

Speaker settings are only active on the Analog Multi-Channel Output. (See "Speaker Setup", on page 27.)

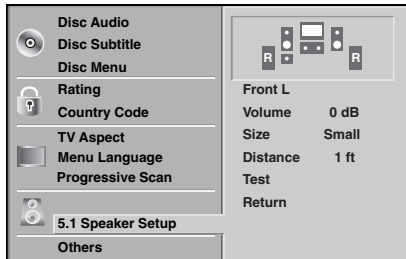

Auto Play **DVD**

You can set up the DVD/CD player so a DVD disc automatically starts playing whenever a DVD is inserted.

If Auto Play mode is set to On, this DVD/CD player will search a title that playback time is longest and then play back the title automatically.

On: Auto Play function is active.

Off: Auto Play function is not active.



The Auto Play function may not work for some DVDs.

Others

DRC, Vocal and Auto Play settings are adjustable.

- Use ▲/▼ to select the desired menu option and press ENTER. The setting of the selected menu option is switched between On and Off.

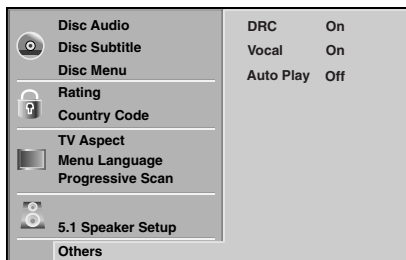

Dynamic Range Control (DRC)

With the DVD format, you can hear a program's soundtrack in the most accurate and realistic presentation possible, thanks to digital audio technology. However, you may wish to compress the dynamic range of the audio output (the difference between the loudest sounds and the quietest ones). Then, you may listen to a movie at a lower volume without losing clarity of sound. Set DRC to On for this effect.

Vocal

Set Vocal to On only when a multi-channel karaoke DVD is playing. The karaoke channels on the disc will mix into normal stereo sound.

Pre-Operation (Continued)

Parental Control

Rating **DVD**

Movies on DVDs may contain scenes not suitable for children. Therefore, discs may contain Parental Control information that applies to the complete disc or to certain scenes on the disc. These scenes are rated from 1 to 8, and alternatively, more suitable scenes are available for selection on some discs. Ratings are country-dependent. The Parental Control feature allows you to prevent discs from being played by your children or to have certain discs played with alternative scenes.

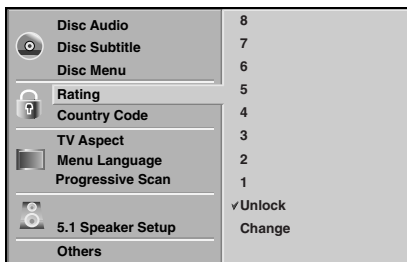

1 Select "Rating" on the Setup menu using the ▲▼ buttons.

2 While "Rating" is selected, press ►.

3 When you have not entered a password. Enter a 4-digit password using the number buttons to create a personal 4-digit security password. then press ENTER. Enter the 4-digit password again and press ENTER to verify.

When you have already registered a password; Enter a 4-digit password using the numbered buttons to confirm the personal 4-digit security password, then press ENTER.

If you make a mistake before pressing ENTER, press CLEAR and enter 4-digit security password again.

4 Select a rating from 1 to 8 using the ▲▼ buttons. One (1) has the least playback restrictions. Eight (8) has the most playback restrictions.

Unlock: If you select Unlock, Parental Control is not active. The disc will play in full.

Ratings 1 to 8: Some discs contain scenes not suitable for children. If you set a rating for the player, all disc scenes with the same rating or lower will be played. Higher rated scenes will not be played unless an alternative scene is available on the disc. The alternative must have the same rating or a lower one. If no suitable alternative is found, playback will stop. You must enter the 4-digit password or change the rating level in order to play the disc.

5 Press ENTER to confirm your rating selection, then press SETUP to exit the menu.

Note

This function may not work for some DVDs.

Country Code **DVD**

Enter the code of a country/area whose standards were used to rate the DVD video disc, referring to the list (See "Country Code List", page 31.).

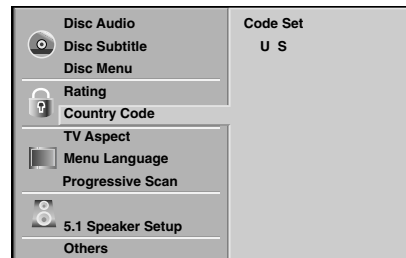

1 Select Country Code using the ▲▼ buttons on the Setup menu.

2 While Country Code is selected, press ►.

3 Follow step 3 of "Rating" on left.

4 Select the first character using the ▲▼ buttons.

5 Shift the cursor using ► button and select the second character using ▲▼ buttons.

6 Press ENTER to confirm your Country Code selection, then press SETUP to exit the menu.

Note

Confirmation of the 4-digit password is necessary when the code is changed (see "Changing the 4-digit code" below.).

Changing the 4-digit code

- 1 Follow Steps 1-2 as shown above to the left (Rating).
- 2 Enter the old code, then press ENTER.
- 3 Select Change using ▲▼ buttons then press ENTER.
- 4 Enter the new 4-digit code, then press ENTER.
- 5 Enter exactly the same code a second time and verify by pressing ENTER.
- 6 Press SETUP to exit the menu.

If you forget your 4-digit code

If you forgot your password, to clear the current password, follow the procedure below.

- 1 Press SETUP to display the Setup menu.
- 2 Use the Number buttons to enter the 6-digit number "210499".
The 4-digit password is cleared.
- 3 Enter a new code as shown above to the left (Rating).

DVD Operation

DVD Playback

Playback Setup **DVD**

- Turn on the TV and select the video input source connected to the DVD/CD player.
- Audio system: Turn on the audio system and select the input source connected to the DVD/CD player.

1 Press OPEN/CLOSE to open the disc tray.

2 Load your chosen disc in the tray, with the playback side facing down.

3 Press OPEN/CLOSE to close the tray. READING appears on the TV screen, and playback starts automatically. If playback does not start, press PLAY. In some cases, the disc menu might appear instead.

If a menu screen is displayed

The menu screen may be displayed first after loading a DVD which offers a menu.

DVD

Use the ◀ ▶▲▼ buttons to select the title/chapter you want to view, then press ENTER to start playback. Press TITLE or MENU to return to menu display.

Notes

- If Parental Control is set and the disc is not within the Rating settings (not authorized), the 4-digit code must be entered and/or the disc must be authorized (see “Parental Control”, on page 19).
- DVDs may have a regional code. Your receiver will not play discs that have a regional code different from your receiver. The regional code for this receiver is 1 (one).

General Features

Note

Unless stated otherwise, all operations described use the remote control. Some features may also be available on the Setup menu.

TITLE Selection



When a disc has more than one title/group, you can move to another title as follows:

- Press DISPLAY, then use the appropriate number button (0-9) to select a title/group number.

CHAPTER/TRACK Selection **DVD**



When a title on a disc has more than one chapter or a disc has more than one track, you can move to another chapter/track as follows:

- Press SKIP/SCAN ◀◀ or ▶▶ briefly during playback to select the next chapter/track or to return to the beginning of the current chapter/track.
- Press ◀◀ twice briefly to step back to the previous chapter/group/track.
- To go directly to any chapter during DVD playback, press DISPLAY. Then, press ▲▼ to select the chapter/group/track icon. Then, enter the chapter/track number using the numbered buttons (0-9).

Note

For two-digit numbers, press the numbered buttons (0-9) in rapid succession.

Search **DVD**

- 1 Press and hold SKIP/SCAN ◀◀ or ▶▶ for about two seconds during playback. The receiver will now go into SEARCH mode.
- 2 Press and hold SKIP/SCAN ◀◀ or ▶▶ repeatedly to select the required speed: ◀◀X2, ◀◀X4, ◀◀X16, ◀◀X100 (backward) or ▶▶X2, ▶▶X4, ▶▶X16, ▶▶X100 (forward).
- 3 To return to normal play, press PLAY.

Pause **DVD**

- 1 Press PAUSE/STEP during playback.
- 2 To return to playback, press PLAY.

DVD Operation (Continued)

General Features (continued)

Still Picture and Frame-by-Frame playback

DVD

1. Press PAUSE/STEP during playback.
The DVD/CD player will now go into PAUSE mode.
2. You can advance the picture frame-by-frame by pressing PAUSE/STEP repeatedly on the remote control.
3. To return to normal playback, press PLAY.

Slow Motion DVD-V

1. Press SLOW SCAN - ◀◀ or ▶▶ + during playback.
The receiver will enter SLOW mode.
2. Use the SLOW SCAN - ◀◀ or ▶▶ + to select the required speed: ◀◀ 1/16, ◀◀ 1/8, ◀◀ 1/4 or ◀◀ 1/2 (backward), or ▶▶ 1/16, ▶▶ 1/8, ▶▶ 1/4 or ▶▶ 1/2 (forward).
3. To exit slow motion mode, press PLAY

Repeat A-B DVD

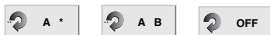

To repeat a sequence in a title or group:

1. Press REPEAT A-B at your chosen starting point.
“A *” appears briefly on the TV screen.
2. Press REPEAT A-B again at your chosen ending point.
“A B” appears briefly on the TV screen, and the repeat sequence begins (“A↔B” appears the display window).
3. To cancel the sequence, press REPEAT A-B.

Repeat DVD



DVD Video Discs - Repeat Chapter/Title/Off

1. To repeat the currently playing chapter, press REPEAT.
The Repeat Chapter icon appears on the TV screen.
2. To repeat the title currently playing, press REPEAT a second time.
The Repeat Title icon appears on the TV screen.
3. To exit Repeat mode, press REPEAT a third time.
The Repeat Off icon appears on the TV screen.

Time Search DVD



The Time Search function allows you to start playing at any chosen time on the disc.

1. Press DISPLAY during playback. The on-screen display appears on the screen.
The Time Search box shows the elapsed playing time of the current disc.
2. Within 10 seconds, use ▲/▼ to select the Time Search icon in the on-screen display.
The “-:-:--” appears in the Time Search box.
3. Within 10 seconds, use the number buttons to enter the required start time. Enter hours, minutes, and seconds from left to right in the box.
If you enter the wrong numbers, press CLEAR to remove the numbers you entered. Then enter the correct numbers.
4. Within 10 seconds, press ENTER to confirm the start time.
Playback starts from the selected time on the disc. If you enter an invalid time, playback will continue from the current point.

DVD Operation (Continued)

General Features (continued)

3D Surround

This unit can produce a 3D Surround effect, which simulates multi-channel audio playback from two conventional stereo speakers, instead of the five or more speakers normally required to listen to multi-channel audio from a home theater system.

1. Press SOUND MODE to select "3D SUR" during playback.
2. To turn off the 3D Surround effect, press SOUND MODE again to select "BYPASS".

Zoom

The Zoom function allows you to enlarge the video image and to move through the enlarged image.

1. Press ZOOM during playback or still playback to activate the Zoom function.
If you press ZOOM repeatedly, the magnification level increases up to six steps.
2. Use the ◀▶▲▼ buttons to move through the zoomed picture.
3. Press CLEAR to resume normal playback or return to the paused image.

Note

- The zoom function may not work on some DVDs.

Marker Search



You can start playback from a memorized point. Up to nine points can be memorized. To enter a mark, follow these steps.

1. During disc playback, press MARKER when playback reaches the spot that you want to memorize.
The Marker icon will appear on the TV screen briefly.
2. Repeat Step 1 to enter up to nine Marker points on a disc.

To Recall Marked Scenes

1. During disc playback, press SEARCH.
The MARKER SEARCH menu will appear on the screen.
2. Within 10 seconds, use ◀▶ to select the Marker number that you want to recall.
3. Press ENTER.
Playback will start from the Marked scene.
4. To remove the MARKER SEARCH menu, press SEARCH.

To Clear a Marked Scene

1. During disc playback, press SEARCH.
The MARKER SEARCH menu will appear on the screen.
2. Use ◀▶ to select the Marker number that you want to erase.

3. Press CLEAR.
The Marker number will be erased from the list.
4. Repeat steps 2 and 3 to erase additional Marker numbers.
5. To remove the MARKER SEARCH menu, press SEARCH.

Special DVD Features

Checking the contents of DVD Video discs: Menus

DVDs may offer menus that allow you to access special features. To use the disc menu, press MENU. Then, press the appropriate number button to select an option. Or, use the ◀▶▲▼ buttons to highlight your selection, then press ENTER.

Title Menu

1. Press TITLE.
If the current title has a menu, the menu will appear on the screen. Otherwise, the disc menu may appear.
2. The menu can list camera angles, spoken language and subtitle options, and chapters for the title.
3. To remove the title menu, press TITLE again.

Disc Menu

1. Press MENU.
The disc menu is displayed.
2. To remove the disc menu, press MENU again.

Camera Angle

If the disc contains scenes recorded at different camera angles, you can change to a different camera angle during playback.

- Press ANGLE repeatedly during playback to select a desired angle.
The number of the current angle appears on the display.

Changing the Audio Language



Press AUDIO repeatedly during playback to hear a different audio language or audio track.

Changing the Audio Channel

Press AUDIO repeatedly during playback to hear a different audio channel (STER., LEFT or RIGHT).

Subtitles

Press SUBTITLE repeatedly during playback to see the different subtitle languages available.

Note

If  appears, the feature is not available on the disc.

Audio CD and MP3/WMA Disc Operation

Playing Audio CD or MP3/WMA Discs

CD MP3 WMA

The DVD/CD player can play MP3/WMA formatted recordings on CD-ROM, CD-R, or CD-RW discs. Before playing MP3/WMA recordings, read the notes on MP3/WMA Recordings on right.

1 Insert a disc and close the tray.

Audio CD: Audio CD menu appears on the TV screen go to step 4.

MP3/WMA disc: The MP3/WMA-JPEG choice menu appears on the TV screen. Go to step 2



2 Use ▲▼ to select the MP3/WMA option then press ENTER.

The MP3/WMA menu appears on the TV screen. Press RETURN to move to the MP3/WMA-JPEG choice menu.

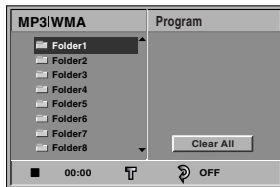

3 Use ▲▼ to select a folder, and ENTER.

A list of files in the folder appears.

4 Use ▲▼ to select a track then press PLAY or ENTER.

Playback starts.

During playback, the current track's elapsed playing time will appear on the display window and menu. Playback will stop at the end of the disc.

Press TITLE to move to the next page.

Press MENU to move to the previous page.

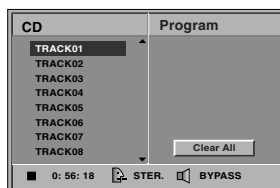

Audio CD Menu

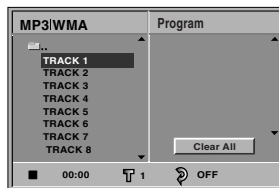

MP3/WMA Menu



If you are in a file list and want to return to the Folder list, use ▲▼ to highlight and press ENTER to return to the previous menu screen.

5 To stop playback at any other time, press STOP.

Notes on MP3/WMA Recordings

About MP3

- An MP3 file is audio data compressed by using the MPEG1 audio layer-3 file-coding scheme. We call files that have the ".mp3" file extension "MP3 files".
- The player can not read an MP3 file that has a file extension other than ".mp3".

About WMA(Window Media Audio)

- A WMA file is a Microsoft audio compression technology.
- WMA(Windows Media Audio) offers double the audio compression of the MP3 format.

MP3/WMA Disc compatibility with this DVD/CD player is limited as follows:

1. Sampling Frequency / only at 44.1kHz (MP3), 32 - 44.1kHz (WMA)
2. Bit rate / within 32 - 320kbps (MP3), 32 - 128kbps (WMA)
3. CD-R physical format should be "ISO 9660"
4. If you record MP3/WMA files using the software which cannot create a FILE SYSTEM, for example "Direct-CD" etc., it is impossible to playback MP3/WMA files. We recommend that you use "Easy-CD Creator", which is the default in most software.
5. A single session disc requires MP3/WMA files in the first track. If there is no MP3/WMA file in the 1st track, it cannot playback MP3/WMA files. If you wish to playback MP3/WMA files, format all the data in the disc or use a new one.
6. File names should be named using 8 letters or less and must incorporate ".mp3" or ".wma" extension e.g. "*****.MP3" or "*****.WMA".
7. Do not use special letters such as "/ : * ? " < > " etc.
8. Total number of files on the disc should be less than 650.

This DVD/CD player requires discs/recordings to meet certain technical standards in order to achieve optimal playback quality. Pre-recorded DVDs are automatically set to these standards. There are many different types of recordable disc formats (including CD-R containing MP3 or WMA files). That require certain pre-existing conditions (see above) to insure compatible playback.

Customers should also note that permission is required in order to download MP3/WMA files and music from the Internet. Our company has no right to grant such permission. Permission should always be sought from the copyright owner.

Audio CD and MP3/WMA Disc Operation (Continued)

Pause **CD** **MP3** **WMA**

1. Press PAUSE/STEP during playback.
2. To return to playback, press PLAY or press PAUSE/STEP again.

Changing Tracks **CD** **MP3** **WMA**

- Press SKIP/SCAN **⏮** or **⏭** briefly during playback to go to the next track or to return to the beginning of the current track.
- Press SKIP/SCAN **⏮** twice briefly to step back to the previous track.
- For audio CDs, to go directly to any track, enter the track number using the numbered buttons (0-9) during playback.

Repeat Track/All/Off **CD** **MP3** **WMA**

1. To repeat the track currently playing, press REPEAT. The Repeat icon and "TRACK" appear on the menu screen.
2. To repeat all tracks on a disc, press REPEAT a second time. The Repeat icon and "ALL" appear on the menu screen.
3. To cancel Repeat mode, press REPEAT a third time. The Repeat icon and "OFF" appear on the menu screen.

Search **CD** **MP3** **WMA**

1. Press and hold SKIP/SCAN **⏮** or **⏭** for about two seconds during playback. The player will now go into SEARCH mode.
2. Press and hold SKIP/SCAN **⏮** or **⏭** repeatedly to select the required speed: **⏮X2**, **⏮X4**, **⏮X8** (backward) or **⏭X2**, **⏭X4**, **⏭X8** (forward). Search speed and direction are indicated on the menu screen.
3. To exit SEARCH mode, press PLAY.

Repeat A-B **CD**

To repeat a sequence.

1. During disc playback, press REPEAT A-B at your chosen start point. The Repeat icon and "A * " appears on the menu screen.
2. Press REPEAT A-B again at your chosen end point. The Repeat icon and "A B" appear on the menu screen, and the sequence begins to play repeatedly.
3. To exit the sequence and return to normal play, press REPEAT A-B again. The Repeat icon and "OFF" appear on the menu screen.

3D Surround **CD**

This unit can produce a 3D Surround effect, which simulates multi-channel audio playback from two conventional stereo speakers, instead of the five or more speakers normally required to listen to multi-channel audio from a home theater system.

1. Use SOUND to select "3D SUR" during playback.
2. To turn off the 3D Surround effect, use SOUND to select "BYPASS."

Changing Audio Channel **CD**

Press AUDIO repeatedly during playback to hear a different audio channel (STER., LEFT, or RIGHT).

JPEG File Operation

Viewing JPEG Files **JPEG**

This DVD/CD player can play discs with JPEG files and Kodak picture CDs. Before viewing JPEG files, read the notes on JPEG files on the right.

- 1 Insert a disc and close the tray.**
The MP3/WMA-JPEG selection menu appears on the TV screen.



- 2 Use ▲/▼ to select the JPEG option then press ENTER.**
The JPEG menu appears on the TV screen.



- 3 Use ▲/▼ to select a folder, and ENTER.**
A list of files in the folder appears.
Press RETURN to move to the MP3/WMA-JPEG selection menu.

T Tip

If you are in a file list and want to return to the Folder list, use the ▲/▼ buttons on the remote to highlight “⋮” and press ENTER to return to the previous menu screen.

- 4 If you want to view a particular file, use ▲/▼ to highlight a file and press ENTER or PLAY.**
Viewing the file starts.
While viewing a file, press RETURN to move to the previous menu (JPEG menu).
Press TITLE to move to the next page.
Press MENU to move to the previous page.

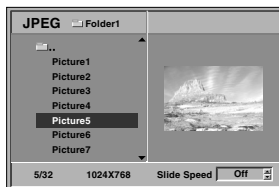

T ip

There are three viewing Slide Speed options: Fast, Normal, Slow, and Off. Use ◀▶ to highlight the Slide Speed option then use ▲/▼ to select the option you want to use, and press ENTER.

- 5 To stop viewing at any other time, press STOP.**
The JPEG menu appears.

Changing Files

Press SKIP/SCAN ◀◀ or ▶▶ once while viewing a picture to advance to the next file or to the previous file.

Still Picture

- Press PAUSE/STEP while viewing a slide show.
The DVD/CD player will now go into PAUSE mode.
- To return to the slide show, press PLAY or press PAUSE/STEP again.

Flipping the picture

Use ▲/▼ while viewing a picture to flip the picture horizontally or a vertically.

Rotating the picture

Use ◀▶ while viewing a picture to rotate the picture clockwise or counter clockwise.

Notes on JPEG Files

- Depending upon the size and number of the JPEG files, it could take a long time for the DVD/CD player to read the disc's contents. If you don't see an on-screen display after several minutes, some of the files are too big — reduce the resolution of the JPEG files to less than 2 mega pixels and burn another disc.
- Total number of files and folders on the disc should be less than 650.
- Some disc may be incompatible due to different recording format or condition of disc.
- Ensure that all the selected files have the “.jpg” extensions when copying into the CD layout.
- If the files have “.jpe” or “.jpeg” extensions, please rename them as “.jpg” files.
- File names without “.jpg” extension will not be able to be read by this DVD/CD player, even though the files are shown as JPEG image files in windows explorer.

Programmed Playback **CD** **MP3** **WMA**

Audio CD and MP3/WMA Disc Programmed Playback

The Program function enables you to store your favorite tracks from any disc in the player's memory.

Program can contain 30 tracks.

1 Press PROGRAM during playback or in the Stop mode to enter the Program Edit mode.

The  mark will appear to the right of the word Program on the right side of the menu display.

Note

Press PROGRAM to exit the Program Edit mode; the  mark will disappear.

2 Select a track, then press ENTER to place the selected track on the Program list.

3 Repeat step 2 to place additional tracks on the Program list.

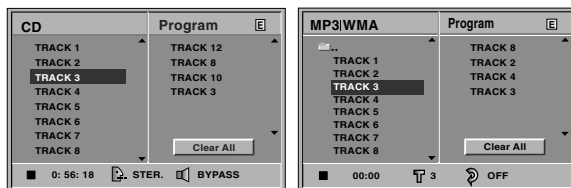

Audio CD menu

MP3/WMA menu

4 Press ►.

The programmed track you selected last is highlighted on the program list.

5 Use ▲/▼ to select the track you want to start playing.

Press TITLE to move to the next page.

Press MENU to move to the previous page.

6 Press PLAY to start.

Playback begins in the order in which you programmed the tracks and "PROG." appears on the menu display. Playback stops after all of the tracks on the Program list have played once.

7 To resume normal playback from programmed playback, select a track of CD (or MP3/WMA) list and then press ENTER.

"PROG." indicator disappears from the on the menu display.

Repeat Programmed Tracks

- To repeat the track currently playing, press REPEAT. The Repeat icon and "TRACK" appear on the menu display.
- To repeat all tracks on the program list, press REPEAT a second time. The Repeat icon and "ALL" appear on the menu display.
- To cancel Repeat mode, press REPEAT a third time. The Repeat icon and "OFF" appear on the menu display.

Erasing a Track from the Program List

1. Press PROGRAM during playback (Audio CD and MP3/WMA disc only) or in the stop mode to enter the Program Edit mode.

The  mark will appear.

2. Press ► to move to the Program list.
3. Use ▲/▼ to select the track that you wish to erase from the Program list.
4. Press CLEAR.
The track will be erased from the Program list.

Erasing the Complete Program List

1. Follow steps 1-2 of "Erasing a Track from Program List" as above.
2. Use ▲/▼ to select "Clear All", then press ENTER.
The complete Program for the disc will be erased. The programs are also cleared when the disc is removed.

Speaker Setup

Adjust the following settings for the built-in 5.1 channel surround decoder.

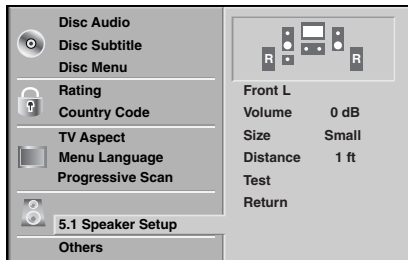

- 1** Select “5.1 Speaker Setup” on the Setup menu using the ▲/▼ buttons.
- 2** While “5.1 Speaker Setup” is selected, press ► button.
- 3** Use ► buttons to select the desired speaker.
- 4** Adjust options by using ▲▼◀▶ buttons.

Speaker selection

Select a speaker that you want to adjust. ((Front speakers (Left), Front speakers (Right), Center Speaker, Rear speakers (Left), Rear speakers (Right), or Subwoofer))

Volume

Use ◀/▶ to adjust the output level of the selected speaker. (-6dB ~ +6dB)

Size

Since the speaker settings are fixed, you cannot change the settings.

Distance

If you connected speakers to your DVD/CD player, setting the Distance lets the speakers know how far the sound has to travel to reach your listening point. This allows the sound from each speaker to reach the listener at the same time. (1 ft = 30.48 cm)

Note

You can not set the distance for the subwoofer speaker.

Test

Press ENTER to test the signals of each speaker. Adjust the volume to match the volume of test signals memorized in the system.

- Front Left (L) → Centre → Front Right (R) → Rear Right (R) → Rear Left (L) → Subwoofer

Return

Press ENTER to return to the previous menu.

Additional Information

Last Condition Memory

DVD **CD**

This DVD/CD player memorizes the user settings for the last disc that you have viewed. Settings remain in memory even if you remove the disc from the player or switch off the player. If you load a disc that has its settings memorized, the latest stop position is automatically recalled.

Notes

- Settings are stored in memory for use any time.
- This player does not memorize settings of a disc if you switch off the DVD/CD player before commencing to play it.

Radio Operation

Presetting Radio stations

You can preset 50 stations for FM and AM (MW). Before tuning, make sure that you have turned down the volume.

- 1 Use BAND on the remote control to access FM or AM (MW) in the display window.**
- 2 Thereafter, each time you press BAND, FM and AM (MW) change alternately.**
- 3 Press and hold TUNING ◀◀ ◀◀ or ▶▶ ▶▶ on the front panel for about two seconds until the frequency indication starts to change, then release.**

Scanning stops when the DVD/CD Receiver tunes in a station. "TUNED" and "STEREO" (for stereo program) appear in the display window.

Note

"TUNED" only appears when the signal is FM and STEREO.

- 4 Press MEMORY on the front panel.**
A preset number will flash in the display window.
- 5 Press TUNING ◀◀ ◀◀ or ▶▶ ▶▶ on the front panel to select the preset number you want.**
- 6 Press MEMORY on the front panel again.**
The station is stored.
- 7 Repeat steps 3 to 6 to store other stations.**

To tune in a station with a weak signal

Press TUNING ◀◀ ◀◀ or ▶▶ ▶▶ repeatedly in step 3 to tune in the station manually.

To clear all the stored stations

Press and hold MEMORY for about two seconds. "CLEAR ALL" is appears in the display window, then press MEMORY again, the stations are cleared.

- If you have accidentally entered into the "CLEAR ALL" mode and you do not wish to clear the memory, do not press any key. After a few seconds, the "CLEAR ALL" display will go off by itself and change to normal mode.

Note

If all stations have already been entered, the FULL message will appear in the display window for a moment and then a preset number will flash. To change the preset number, follow the steps 5-6 as above.

Listening to the radio

Preset radio stations in the DVD/CD player's memory first (see "Presetting radio stations" on the left).

- 1 Press BAND repeatedly until AM (MW) or FM appears in the display window.**
The last received station is tuned in.
- 2 Press PRESET +/- repeatedly to select the preset station you want.**
Each time you press the button, the DVD/CD player tunes in one preset station at a time.
- 3 Adjust the volume by rotating VOLUME on the front panel or by pressing VOLUME + or - on the remote control repeatedly.**

To turn the radio Off

Press POWER to turn the DVD/CD player off or select another function mode (CD/DVD or AUX).

To listen to non-preset radio stations

- Use manual or automatic tuning in step 2.
- For manual tuning, press TUNING ◀◀ ◀◀ or ▶▶ ▶▶ on the front panel repeatedly.
- For automatic tuning, press and hold TUNING ◀◀ ◀◀ or ▶▶ ▶▶ for about two seconds on the front panel.

To select a preset radio station directly

You can use the number buttons on the remote control to select a preset radio station directly. For example, to listen to preset station 4, press 4 on the remote control. To listen to preset station 19, press 1 then 9 (within 3 seconds).

For your reference

- **If a FM program is noisy**
Press MONO/ST. repeatedly on the front panel so that "STEREO" disappears from the display window. There will be no stereo effect, but the reception will improve. Press the button again to restore the stereo effect.
- **To improve reception**
Reorient the supplied antennas.

Other Functions

Sleep Timer Setup

You can set up the DVD/CD player to turn off automatically at a specified time.

- 1 Press SLEEP to set up a sleep time.**
The SLEEP indicator and sleep time appears in the display window.
- 2 Each time you press SLEEP the setting changes in the following order.**
SLEEP 90 → 80 → 70 → 60 → 50 → 40 → 30 → 20 → 10 → OFF

Note

- **You can check the time remaining before the DVD/CD player turns off.**
Press SLEEP. The remaining time appears in the display window.

Dimmer

This function changes the brightness of the display window on the front panel during power-on status.

Press DIMMER repeatedly.

Mute

Press MUTE to remove the sound.

You can mute your unit in order, for example, to answer the telephone, "MUTE" indicator flashes in the display window.

Press MUTE again to restore the sound.

Using Headphones

Connect a stereo headphone plug (ø3.5mm) into the **PHONES input jack**.

The speakers are automatically disconnected when you plug in a headphone (not supplied).

Language Code List

Enter the appropriate code number for the initial setup "Disc Audio", "Disc Subtitle" and/or "Disc Menu"
(See page 17).

Code	Language	Code	Language	Code	Language	Code	Language
6566	Abkhazian	7074	Fiji	7678	Lingala	8373	Singhalese
6565	Afar	7073	Finnish	7684	Lithuanian	8375	Slovak
6570	Afrikaans	7082	French	7775	Macedonian	8376	Slovenian
8381	Albanian	7089	Frisian	7771	Malagasy	8379	Somali
6577	Ameharic	7176	Galician	7783	Malay	6983	Spanish
6582	Arabic	7565	Georgian	7776	Malayalam	8385	Sudanese
7289	Armenian	6869	German	7784	Maltese	8387	Swahili
6583	Assamese	6976	Greek	7773	Maori	8386	Swedish
6588	Aymara	7576	Greenlandic	7782	Marathi	8476	Tagalog
6590	Azerbaijani	7178	Guarani	7779	Moldavian	8471	Tajik
6665	Bashkir	7185	Gujarati	7778	Mongolian	8465	Tamil
6985	Basque	7265	Hausa	7865	Nauru	8484	Tatar
6678	Bengali; Bangla	7387	Hebrew	7869	Nepali	8469	Telugu
6890	Bhutani	7273	Hindi	7879	Norwegian	8472	Thai
6672	Bihari	7285	Hungarian	7982	Oriya	6679	Tibetan
6682	Breton	7383	Icelandic	8065	Panjabi	8473	Tigrinya
6671	Bulgarian	7378	Indonesian	8083	Pashto, Pushto	8479	Tonga
7789	Burmese	7365	Interlingua	7065	Persian	8482	Turkish
6669	Byelorussian	7165	Irish	8076	Polish	8475	Turkmen
7577	Cambodian	7384	Italian	8084	Portuguese	8487	Twi
6765	Catalan	7465	Japanese	8185	Quechua	8575	Ukrainian
9072	Chinese	7487	Javanese	8277	Rhaeto-Romance	8582	Urdu
6779	Corsican	7578	Kannada	8279	Rumanian	8590	Uzbek
7282	Croatian	7583	Kashmiri	8285	Russian	8673	Vietnamese
6783	Czech	7575	Kazakh	8377	Samoan	8679	Volapük
6865	Danish	7589	Kirghiz	8365	Sanskrit	6789	Welsh
7876	Dutch	7579	Korean	7168	Scots Gaelic	8779	Wolof
6978	English	7585	Kurdish	8382	Serbian	8872	Xhosa
6979	Esperanto	7679	Laothian	8372	Serbo-Croatian	7473	Yiddish
6984	Estonian	7665	Latin	8378	Shona	8979	Yoruba
7079	Faroese	7686	Latvian, Lettish	8368	Sindhi	9085	Zulu

Country Code List

Enter the appropriate code number for the initial setup "Country Code" (See page 19).

Code	Country	Code	Country	Code	Country	Code	Country
AD	Andorra	ER	Eritrea	LC	Saint Lucia	SC	Seychelles
AE	United Arab Emirates	ES	Spain	LI	Liechtenstein	SD	Sudan
AF	Afghanistan	ET	Ethiopia	LK	Sri Lanka	SE	Sweden
AG	Antigua and Barbuda	FI	Finland	LR	Liberia	SG	Singapore
AI	Anguilla	FJ	Fiji	LS	Lesotho	SH	Saint Helena
AL	Albania	FK	Falkland Islands	LT	Lithuania	SI	Slovenia
AM	Armenia	FM	Micronesia	LU	Luxembourg	SJ	Svalbard and Jan Mayen Islands
AN	Netherlands Antilles	FO	Faroe Islands	LV	Latvia	SK	Slovak Republic
AO	Angola	FR	France	LY	Libya	SL	Sierra Leone
AQ	Antarctica	FX	France (European Territory)	MA	Morocco	SM	San Marino
AR	Argentina	GA	Gabon	MC	Monaco	SN	Senegal
AS	American Samoa	GB	Great Britain	MD	Moldavia	SO	Somalia
AT	Austria	GD	Grenada	MG	Madagascar	SR	Suriname
AU	Australia	GE	Georgia	MH	Marshall Islands	ST	Saint Tome and Principe
AW	Aruba	GF	French Guyana	MK	Macedonia	SU	Former USSR
AZ	Azerbaijan	GH	Ghana	ML	Mali	SV	El Salvador
BA	Bosnia-Herzegovina	GI	Gibraltar	MM	Myanmar	SY	Syria
BB	Barbados	GL	Greenland	MN	Mongolia	SZ	Swaziland
BD	Bangladesh	GM	Gambia	MO	Macau	TC	Turks and Caicos Islands
BE	Belgium	GN	Guinea	MP	Northern Mariana Islands	TD	Chad
BF	Burkina Faso	GP	Guadeloupe (French)	MQ	Martinique (French)	TF	French Southern Territories
BG	Bulgaria	GQ	Equatorial Guinea	MR	Mauritania	TG	Togo
BH	Bahrain	GR	Greece	MS	Montserrat	TH	Thailand
BI	Burundi	GS	S. Georgia & S. Sandwich Isls.	MT	Malta	TJ	Tadjikistan
BJ	Benin	GT	Guatemala	MU	Mauritius	TK	Tokelau
BM	Bermuda	GU	Guam (USA)	MV	Maldives	TM	Turkmenistan
BN	Brunei Darussalam	GW	Guinea Bissau	MW	Malawi	TN	Tunisia
BO	Bolivia	GY	Guyana	MX	Mexico	TO	Tonga
BR	Brazil	HK	Hong Kong	MY	Malaysia	TP	East Timor
BS	Bahamas	HM	Heard and McDonald Islands	MZ	Mozambique	TR	Turkey
BT	Bhutan	HN	Honduras	NA	Namibia	TT	Trinidad and Tobago
BV	Bouvet Island	HR	Croatia	NC	New Caledonia (French)	TV	Tuvalu
BW	Botswana	HT	Haiti	NE	Niger	TW	Taiwan
BY	Belarus	HU	Hungary	NF	Norfolk Island	TZ	Tanzania
BZ	Belize	ID	Indonesia	NG	Nigeria	UA	Ukraine
CA	Canada	IE	Ireland	NI	Nicaragua	UG	Uganda
CC	Cocos (Keeling) Islands	IL	Israel	NL	Netherlands	UK	United Kingdom
CF	Central African Republic	IN	India	NO	Norway	UM	USA Minor Outlying Islands
CG	Congo	IO	British Indian Ocean Territory	NP	Nepal	US	United States
CH	Switzerland	IQ	Iraq	NR	Nauru	UY	Uruguay
CI	Ivory Coast	IR	Iran	NU	Niue	UZ	Uzbekistan
CK	Cook Islands	IS	Iceland	NZ	New Zealand	VA	Vatican City State
CL	Chile	IT	Italy	OM	Oman	VC	Saint Vincent & Grenadines
CM	Cameroon	JM	Jamaica	PA	Panama	VE	Venezuela
CN	China	JO	Jordan	PE	Peru	VG	Virgin Islands (British)
CO	Colombia	JP	Japan	PF	Polynesia (French)	VI	Virgin Islands (USA)
CR	Costa Rica	KE	Kenya	PG	Papua New Guinea	VN	Vietnam
CS	Former Czechoslovakia	KG	Kyrgyzstan	PH	Philippines	VU	Vanuatu
CU	Cuba	KH	Cambodia	PK	Pakistan	WF	Wallis and Futuna Islands
CV	Cape Verde	KI	Kiribati	PL	Poland	WS	Samoa
CX	Christmas Island	KM	Comoros	PM	Saint Pierre and Miquelon	YE	Yemen
CY	Cyprus	KN	Saint Kitts & Nevis Anguilla	PN	Pitcairn Island	YT	Mayotte
CZ	Czech Republic	KP	North Korea	PR	Puerto Rico	YU	Yugoslavia
DE	Germany	KR	South Korea	PT	Portugal	ZA	South Africa
DJ	Djibouti	KW	Kuwait	PW	Palau	ZM	Zambia
DK	Denmark	KY	Cayman Islands	PY	Paraguay	ZR	Zaire
DM	Dominica	KZ	Kazakhstan	QA	Qatar	ZW	Zimbabwe
DO	Dominican Republic	LA	Laos	RE	Reunion (French)		
DZ	Algeria	LB	Lebanon	RO	Romania		
EC	Ecuador			RU	Russian Federation		
EE	Estonia			RW	Rwanda		
EG	Egypt			SA	Saudi Arabia		
EH	Western Sahara			SB	Solomon Islands		

Troubleshooting

Check the following guide for the possible cause of a problem before contacting service.

Symptom	Cause	Possible Solution(s)
No power.	<ul style="list-style-type: none"> The power cord is disconnected. 	<ul style="list-style-type: none"> Plug the power cord securely into the wall power outlet.
The power is on, but the DVD/CD player does not work.	<ul style="list-style-type: none"> No disc is inserted. 	<ul style="list-style-type: none"> Insert a disc. (Check that the DVD or, audio CD indicator in the DVD display is lit.)
No picture.	<ul style="list-style-type: none"> The TV is not set to receive DVD signal output. 	<ul style="list-style-type: none"> Select the appropriate video input mode on the TV so the picture from the DVD/CD receiver appears on the TV screen.
	<ul style="list-style-type: none"> The video cable is not connected securely. 	<ul style="list-style-type: none"> Connect the video cable into the jacks securely.
	<ul style="list-style-type: none"> The connected TV power is turned off. 	<ul style="list-style-type: none"> Turn on the TV.
There is no sound or only a very low-level sound is heard.	<ul style="list-style-type: none"> The equipment connected with the audio cable is not set to receive DVD signal output. 	<ul style="list-style-type: none"> Select the correct input mode of the audio receiver so you can hear the sound from the DVD/CD player.
	<ul style="list-style-type: none"> The audio cables are not connected securely. 	<ul style="list-style-type: none"> Insert the audio cables into the jacks securely.
	<ul style="list-style-type: none"> The power of the equipment connected with the audio cable is turned off. 	<ul style="list-style-type: none"> Turn on the equipment connected with the audio cable.
	<ul style="list-style-type: none"> The audio connecting cable is damaged. 	<ul style="list-style-type: none"> Replace it with new one.
The playback picture is poor.	<ul style="list-style-type: none"> The disc is dirty. 	<ul style="list-style-type: none"> Clean the disc.
The DVD/CD player does not start playback.	<ul style="list-style-type: none"> No disc is inserted. 	<ul style="list-style-type: none"> Insert a disc. (Check that the DVD, or audio CD indicator in the DVD display is lit.)
	<ul style="list-style-type: none"> An unplayable disc is inserted. 	<ul style="list-style-type: none"> Insert a playable disc. (Check the disc type, color system and Regional code.)
	<ul style="list-style-type: none"> The disc is placed upside down. 	<ul style="list-style-type: none"> Place the disc with the playback side down.
	<ul style="list-style-type: none"> The disc is not placed within the guide. 	<ul style="list-style-type: none"> Place the disc on the disc tray correctly inside the guide.
	<ul style="list-style-type: none"> The disc is dirty. 	<ul style="list-style-type: none"> Clean the disc.
	<ul style="list-style-type: none"> A menu is on the TV screen. 	<ul style="list-style-type: none"> Press the SETUP button to remove the menu display.
	<ul style="list-style-type: none"> A parental control restriction is set. 	<ul style="list-style-type: none"> Cancel the restriction or change the rating level.
Loud hum or noise is heard.	<ul style="list-style-type: none"> The plugs and jacks are dirty. 	<ul style="list-style-type: none"> Wipe them with a cloth slightly moistened with alcohol.
	<ul style="list-style-type: none"> The disc is dirty. 	<ul style="list-style-type: none"> Clean the disc.
	<ul style="list-style-type: none"> The speakers and components are connected poorly. 	<ul style="list-style-type: none"> Connect the speakers and components securely.
	<ul style="list-style-type: none"> The DVD/CD player is located too close to the TV. 	<ul style="list-style-type: none"> Move your TV away from the audio components.

Troubleshooting (Cont'd)

Symptom	Cause	Possible Solution(s)
Radio stations cannot be tuned in.	<ul style="list-style-type: none"> The antenna is positioned or connected poorly. 	<ul style="list-style-type: none"> Connect the antenna securely. Adjust the antennas and connect an external antenna if necessary.
	<ul style="list-style-type: none"> The signal strength of the stations is too weak (when tuning in with automatic tuning). 	<ul style="list-style-type: none"> Tune in the station manually.
	<ul style="list-style-type: none"> No stations have been preset or preset stations have been cleared (when tuning by scanning preset stations). 	<ul style="list-style-type: none"> Preset the stations (page 28).
The remote control does not work properly.	<ul style="list-style-type: none"> The remote control is not pointed at the remote sensor of the DVD/CD player. 	<ul style="list-style-type: none"> Point the remote control at the remote sensor of the DVD/CD player.
	<ul style="list-style-type: none"> The remote control is too far from the DVD/CD player. 	<ul style="list-style-type: none"> Use the remote control within about 23 ft (7 m).
	<ul style="list-style-type: none"> There is an obstacle in the path of the remote control and the DVD/CD receiver. 	<ul style="list-style-type: none"> Remove the obstacle.
	<ul style="list-style-type: none"> The batteries in the remote control are exhausted. 	<ul style="list-style-type: none"> Replace the batteries with new ones.
The sound mode or Pro Logic II mode cannot be changed.	<ul style="list-style-type: none"> The system cannot change while playing MP3 or WMA discs. 	<ul style="list-style-type: none"> Eject disc, change mode, reinsert disc.
The front panel display is too dim.	<ul style="list-style-type: none"> Nothing is displayed on the front panel display. 	<ul style="list-style-type: none"> Press DIMMER on the remote control.

Specification

[General]	Power supply	Refer to main label		
	Power consumption	Refer to main label		
	Mass	8.4 lbs		
	External dimensions (W x H x D)	14.1 x 2.9 x 12.3 inches		
	Operating conditions	Temperature: 5°C to 35°C, Operation status: Horizontal		
	Operating humidity	5% to 85%		
[CD/DVD]	Laser	Semiconductor laser, wavelength 650 nm		
	Signal system	NTSC 525/60		
	Frequency response (audio)	200 Hz to 18 kHz		
	Signal-to-noise ratio (audio)	More than 70 dB (1 kHz, NOP, 20 kHz LPF/A-Filter)		
	Dynamic range (audio)	More than 65 dB		
	Harmonic distortion (audio)	1.0 % (1 kHz, at 12W position) (20 kHz LPF/A-Filter)		
[Video]	Video output	1.0 V (p-p), 75 Ω, negative sync., RCA jack		
	S-video output	(Y) 1.0 V (p-p), 75 Ω, negative sync., Mini DIN 4-pin x 1 (C) 0.3 V (p-p), 75 Ω		
[Tuner]	[FM]	Tuning Range	87.5 - 108.0 MHz or 65.0 - 74.0 MHz, 87.5 - 108.0 MHz	
		Intermediate Frequency	10.7 MHz	
		Signal-to Noise Ratio	55 dB (Mono)	
	[AM [MW]]	Frequency Response	180 - 10,000 Hz	
		Tuning Range	522 - 1,611 kHz or 530 - 1,610 kHz	
		Intermediate Frequency	450 kHz	
[Amplifier]	Stereo mode	30W + 30W (6 Ω at 1 kHz, THD 10 %)		
	Surround mode	Front: 30W + 30W (THD 10 %)		
	(* Depending on the sound mode settings and the source, there may be no sound output.)	Center*: 30W Surround*: 30W + 30W (6Ω at 1 kHz, THD 10 %) Subwoofer*: 50W (8Ω at 30 Hz, THD 10 %)		
	Outputs	S-VIDEO MONITOR PHONES: (32 Ω, 20mW)		
[Speakers]		Satellite Speaker (LHS-D6245T)	Passive Subwoofer (LHS-D6245W)	
	Type	1 Way 1 Speaker	1 Way 1 Speaker	
	Impedance	6 Ω	8 Ω	
	Frequency Response	130 - 20,000 Hz	50 - 1,500 Hz	
	Sound Pressure Level	85 dB/W (1m)	82 dB/W (1m)	
	Rated Input Power	30W	50W	
	Max. Input Power	60W	100W	
	Net Dimensions (W x H x D)	3.5 x 5.5 x 3.9 inches	6.2 x 13.7 x 13.5 inches	
Net Weight	1.9 lbs	9.9 lbs		
[Supplied Accessories]	<ul style="list-style-type: none"> • Speakers6 • Remote control1 • AM loop antenna1 • Speaker cables5 • Batteries (AAA)2 • FM antenna1 			

* Designs and specifications are subject to change without notice.

Notes

LG Electronics, Inc.
DVD/CD/Radio Combination Home Theater System DVT412
LIMITED WARRANTY – USA

LG will repair or replace your product, at LG's option, if it proves to be defective in material or workmanship under normal use, during the warranty period ("Warranty Period") listed below, effective from the date ("Date of Purchase") of original purchase of the product. This limited warranty is good only to the original purchaser of the product and effective only when used in the United States, excluding U.S. Territories.

<p>WARRANTY PERIOD:</p> <p>LABOR: 90 days from the Date of Purchase.</p> <p>PARTS: 1 Year from the Date of Purchase.</p> <p>* Parts replaced are warranted for the remaining portion of the original warranty period.</p>	<p>HOW SERVICE IS HANDLED:</p> <p>Carry-In Service: Please retain dealer's dated bill of sale or delivery ticket as evidence of the Date of Purchase for proof of warranty, and submit a copy of the bill of sale to the service person at the time warranty service is provided.</p> <p>Please call 1-877-993-6484 to locate your nearest Authorized Service Center.</p> <p>Or visit our website at http://www.zenithservice.com</p>
--	---

THIS WARRANTY IS IN LIEU OF ANY OTHER WARRANTY, EXPRESS OR IMPLIED, INCLUDING WITHOUT LIMITATION, ANY WARRANTY OF MERCHANTABILITY OR FITNESS FOR A PARTICULAR PURPOSE. TO THE EXTENT ANY IMPLIED WARRANTY IS REQUIRED BY LAW, IT IS LIMITED IN DURATION TO THE EXPRESS WARRANTY PERIOD ABOVE. LG WILL NOT BE LIABLE FOR ANY INCIDENTAL, CONSEQUENTIAL, INDIRECT, SPECIAL, OR PUNATIVE DAMAGES OF ANY NATURE, EVEN IF ADVISED OF THE POSSIBILITY OF SUCH DAMAGES, INCLUDING WITHOUT LIMITATION, LOST REVENUES OR PROFITS, LOST OR CORRUPTED PROGRAMMING OR DATA, OR ANY OTHER DAMAGE WHETHER BASED IN CONTRACT, TORT, OR OTHERWISE.

Some states do not allow the exclusion or limitation of incidental or consequential damages or limitations on how long an implied warranty lasts, so the above exclusion or limitation may not apply to you. This warranty gives you specific legal rights and you may also have other rights that vary from state to state.

THIS LIMITED WARRANTY DOES NOT APPLY TO:

- Damage caused in shipping or transit
- Service required as a result of improper installation, including incorrect or insufficient AC supply (Please consult the owner's manual for power supply requirements)
- Installation or repair of other components in a video system
- Set-up or adjustment on consumer controls, or damage caused by improper adjustments
- Damage cause by other system components
- Damage (including cosmetic damage), failure, loss or personal injury due to misuse, abuse, negligence, improper maintenance or storage, or to acts of nature or other causes beyond LG's control (Causes beyond

LG's control include but are not limited to lightning strike, power surges, power outages, and water damage)

- Repair or replacement of warranted parts by other than Authorized Service Centers
- Units purchased or serviced outside the coverage area
- Product where the original factory serial numbers have been removed, defaced, or changed in any way
- Product sold and labeled as "as is, where is" or similar disclaimer

The costs of repair or replacement under these excluded circumstances shall be borne by the consumer.

CUSTOMER INTER-ACTIVE CENTER NUMBERS:

<p>For nearest Authorized Service Center, Where to buy, Product Assistance, or Customer Assistance</p>	<p>Call 1-877-993-6484 (24 hours a day, 365 days per year) and select appropriate option from the menu.</p> <p>Or visit our website at http://www.zenithservice.com</p>
---	---

Marketed and Distributed by LG Electronics U.S.A., Inc.
 1000 Sylvan Avenue, Englewood Cliffs, NJ.

GS# 3834RH0024G
 Printed in China
 Issue O

Free Manuals Download Website

<http://myh66.com>

<http://usermanuals.us>

<http://www.somanuals.com>

<http://www.4manuals.cc>

<http://www.manual-lib.com>

<http://www.404manual.com>

<http://www.luxmanual.com>

<http://aubethermostatmanual.com>

Golf course search by state

<http://golfingnear.com>

Email search by domain

<http://emailbydomain.com>

Auto manuals search

<http://auto.somanuals.com>

TV manuals search

<http://tv.somanuals.com>