

Koldfront

Built-in Ice Maker

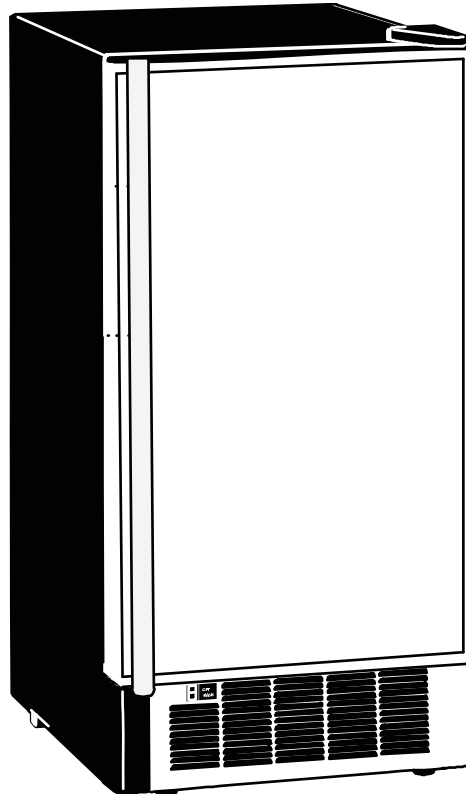

KIM450S

Owner's Manual

For more information on other great KoldFront products on the web, go to <http://www.edgestar.com>

Important Safety Information

Improper handling can cause serious damage to the KoldFront ice maker and/or injury to the user. This ice maker is designed for domestic indoor use only. Do not use the unit for industrial or commercial use. Any other use may invalidate the warranty. Please review the ratings label located on the rear panel of the unit for electrical and other technical data related to this unit. The unit must be used in a properly grounded wall outlet. Please read and follow the safety information listed below to reduce the risk of fire, electric shock or injury. **Installation should only be done by a licensed plumber.**



Electrical Safety

- Do not exceed the power outlet ratings.
- It is recommended the ice maker be connected on its own circuit.
- The unit must be installed in accordance with state and local electrical, water and drain codes.
- A standard electrical supply (115 V, 60Hz), that is properly grounded in accordance with the National Electrical Code and local codes and ordinances is required.
- Use outlets that cannot be turned off by a switch or pull chain.
- Always turn the unit off and unplug it from the outlet when cleaning.
- Unplug the unit if it is not going to be used for an extended period of time.
- Do not operate the unit with a power plug missing the ground plug, a damaged cord or a loose socket.
- Be sure the ice maker is properly grounded.
- Never plug or unplug the unit with wet hands.
- Do not bypass, cut or remove the grounding plug.
- Do not use extension cords or power strips with this unit. You may need to contact your electrician if it is necessary to use a longer cord or if you do not have a grounded outlet. Do not modify the power cord's length or share the outlet with other appliances.
- Do not start or stop the unit by switching the circuit's power on and off.
- If the power cord is damaged, it must be replaced by the manufacturer or a qualified technician.
- Never open the unit while it is plugged in.
- Immediately unplug the unit if it makes strange sounds, emits smells or smoke comes out of it, and contact customer service.
- Do not remove any part of the casing unless instructed by an authorized technician.
- You should never attempt to repair the unit yourself.
- Contact a customer service for service options if the unit needs service.



General Safety

- To prevent back and other types of injuries, use at least two people to move and install the ice maker.
- Install the ice maker in a well ventilated area where the ambient temperature is above 50°F and below 100°F.
- This unit is designed to be installed indoors, and protected from rain, sleet, snow, etc.
- This unit is not intended to be used by children.
- Children should be supervised to ensure that they do not play with this product.
- Never allow children to crawl inside the ice maker.
- Do not use this appliance near flammable gas or combustibles, such as gasoline, benzene, thinner, etc.
- Do not place the unit near heat sources such as ovens, and grills.
- Only use in an upright position on a flat, level surface and provide proper ventilation.
- Do not pinch or kink the water or power supply lines between the unit and cabinet.
- Unit installation must be in accordance with local plumbing code requirements.
- Make sure that the water supply lines and pipes are not pinched or kinked.
- Check for leaks after installation.
- Discard the first batch of cubes produced by the ice maker.
- Never turn the water supply tap off while the ice maker is running.
- If the unit has not been used for an extended period, thoroughly clean it before using it.
- Do not leave any cleaning solutions in the unit
- Do not use solvent-based cleaning agents or abrasive solutions on the interior as they may transmit taste to the ice cubes and damage the interior.
- Only connect a potable water supply.
- This appliance is not intended for use by persons, including children, with reduced physical, sensory or mental capabilities, unless they have been given supervision or instruction concerning the use of the appliance by the person(s) responsible for their safety.

Table of Contents

IMPORTANT SAFETY INFORMATION	I
INTRODUCTION	1
PARTS IDENTIFICATION	2
BACK VIEW.....	2
FRONT VIEW.....	2
INSTALLING THE ICE MAKER	3
TYPES OF INSTALLATION.....	3
<i>Free-standing installation:</i>	3
<i>Recessed installation:</i>	3
<i>Built-in installation:</i>	3
INSTALLATION CLEARANCE REQUIREMENTS	4
ELECTRICAL REQUIREMENTS.....	5
<i>Recommended grounding method</i>	5
LEVELING THE ICE MAKER	6
REVERSING THE DOOR SWING.....	6
WATER SUPPLY CONNECTIONS	7
DRAIN	7
OPERATION	8
FINAL CHECK LIST BEFORE OPERATION	8
OPERATING METHOD	8
HOW THE MACHINE MAKES ICE	9
HOW THE MACHINE USES THE WATER	9
NORMAL SOUNDS	10
PREPARING THE ICEMAKER FOR LONG STORAGE	10
CLEANING AND MAINTENANCE	11
EXTERIOR CLEANING	11
INTERIOR CLEANING.....	12
CONDENSER CLEANING.....	12
WATER DISTRIBUTION TUBE CLEANING	13
ICE-MAKING SYSTEM CLEANING	13
TROUBLESHOOTING	15
SPECIFICATIONS	16
LIMITED WARRANTY	17

This owner's manual is provided for reference use only. Specifications may change without prior notice. Refer to the product label on the back of your ice maker for the latest technical information.

Introduction

Thank you for purchasing this KoldFront ice maker. We are glad you chose us. We believe that your purchase of this product opens a relationship between you and KoldFront. We will provide the customer support needed to nurture that relationship.

This manual contains important information regarding the proper installation, use and maintenance of your ice maker. Following this manual will ensure that your product will work at its peak performance and efficiency.

Please save the original product packaging in case you need to safely transport your ice maker.

For Your Records:

Please write down the model number and serial number below for future reference. Both numbers are located on the ratings label on the back of your unit and are needed to obtain warranty service. You may also want to staple your receipt to this manual as it is the proof of your purchase, and is also needed for service under your warranty.

Model Number: _____

Serial Number: _____

Date of Purchase: _____

To better serve you, please do the following before contacting customer service:

- If you received a damaged product, immediately contact the dealer that sold you the product.
- Read and follow this instruction manual carefully to help you install, use and maintain your ice maker.
- Read the troubleshooting section of this manual as it will help you diagnose and solve common issues.
- Visit us on the web at <http://www.edgestar.com> to register your product, download product guides, additional troubleshooting resources and up-to-date information.
- If you need warranty service, our friendly customer service representatives are available via email at service@edgestar.com or by telephone at **1 (866) 319-5473**.

Parts Identification

Front View

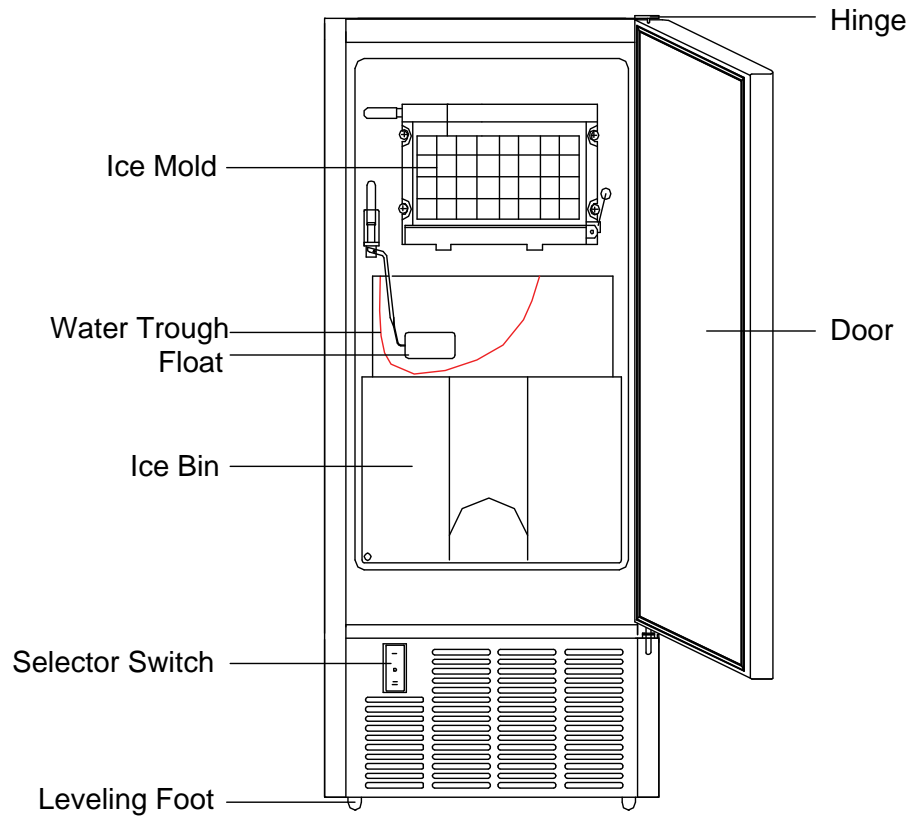

Back View

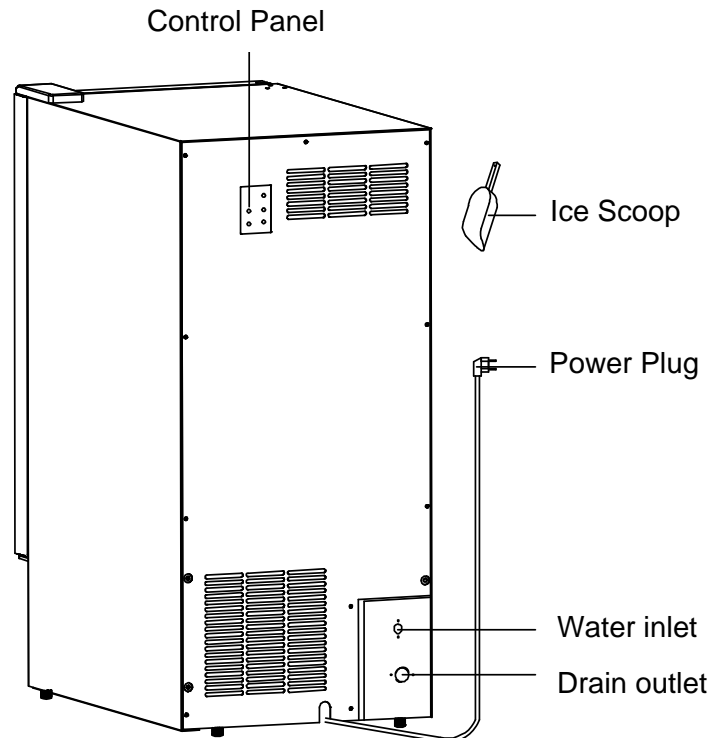

Installing the Ice Maker

The ice maker should be installed by a licensed plumber to be in accordance with local electrical and plumbing code requirements.

Before you plug the ice maker in to a power supply, be sure to let it stand upright for at least 24 hours to allow the compressor's oils to settle.

Unpacking the Ice Maker



WARNING: Use two more people to move and install the ice maker. Failure to do so can result in back or other injury.

Carefully remove the packaging materials. Remove any shipping tape and glue from your ice maker before using. Do not use sharp instruments, rubbing alcohol, flammable fluids, or abrasive cleaners to remove tape or glue. These products can damage the surface of your icemaker. **IMPORTANT:** Do not remove any safety, warning, or product information labels from your ice maker.

Types of Installation

This ice maker has been designed for free-standing, recessed, or built-in installation. In every case, there must be adequate ventilation and access for service.

Free-standing installation:

A free-standing installation will allow you to install the icemaker in any place you desire provided you have access to a water supply and a drain. You must follow the stated instructions for electrical requirements, water supply and drain, and leveling the icemaker.

Recessed installation:

A recessed installation will allow you to install the ice maker under a counter or in a kitchen cabinet provided the required clearance space around the ice maker is followed. This installation has the same requirements as a built-in installation.

Built-in installation:

It is necessary to allow adequate ventilation space around the unit (make sure there is at least some ventilation room for the back of the unit). The following additional items must be observed.

1. Place the ice maker in front of the installation location. Remove the feet and place the unit flat on the floor or on a platform depending on your installation requirements.
2. The water supply pipe must be plumbed before connecting to the ice maker. Install the drain line into your drain.
3. Turn on main water supply and tap. Check for water supply connection leaks. Tighten any connections (including connections at the tie-in).
4. If the electrical outlet for the ice maker is behind the cabinet, plug in the ice maker.
5. Push the ice maker into position.
6. Seal all around the cabinet to the floor with an approved caulking compound.

Installation Clearance Requirements

*** This icemaker should be installed by a licensed plumber only.**

* To ensure proper service access and ventilation, allow more 2/5" clearance at rear, and 1" at top and 1/5" at sides. The installation should allow the icemaker to be pulled forward for servicing if necessary.

* When installing the ice maker under a counter, follow the recommended spacing dimensions shown. Place electrical and water supplies and drain fixtures in the recommended locations as shown.

* Choose a well ventilated area with temperatures above 50°F and below 100°F. This unit **MUST** be installed in an area protected from the elements, e.g., wind, rain, water spray or drips.

* The icemaker should not be located next to ovens, grills or other high heat resources.

* The ice maker requires a continuous water supply with a minimum pressure of 0.05Mpa and a static pressure not to exceed 0.8Mpa. The temperature of the water feeding into the ice maker should be between 41°F and 90°F for proper operation. The ambient operational temperature should be between 50°F and 100°F. Operation outside these temperatures may result in lowered production or other adverse effects.

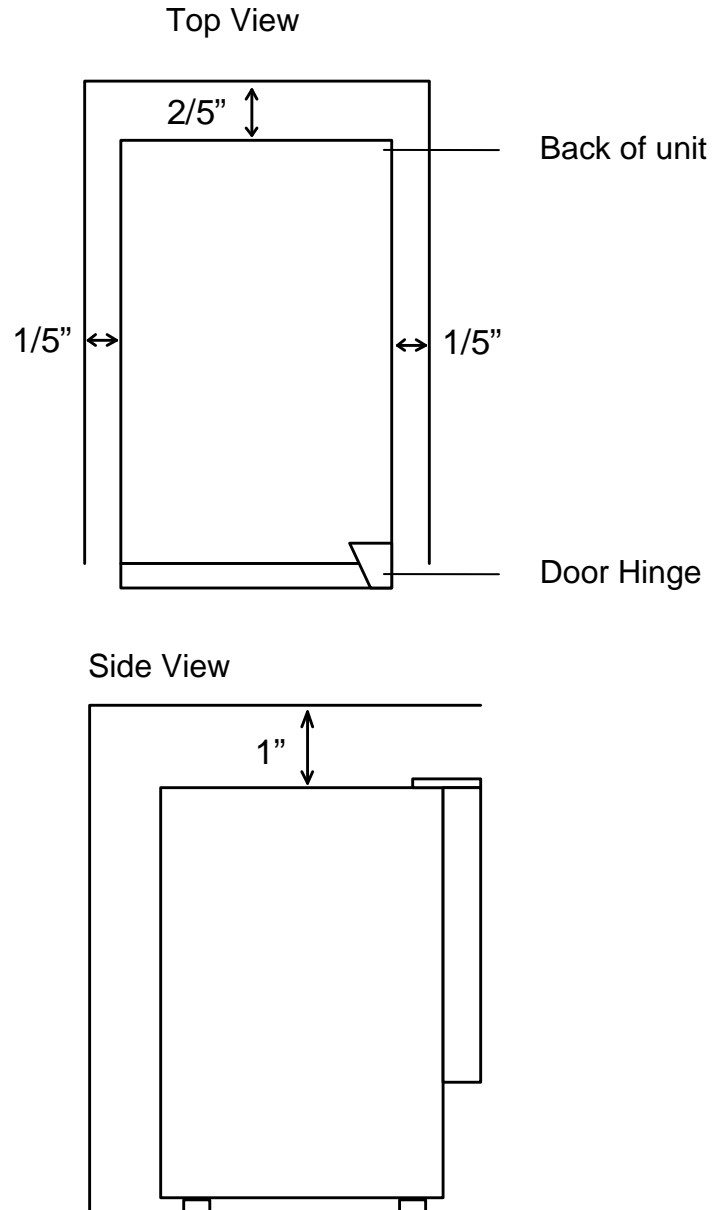

- The unit should be located on a firm and level surface. It is important for the ice maker to be level in order to work properly. If needed, you can adjust the height of the ice maker by rotating the feet. See the "Leveling the Ice Maker" section.
- A standard electrical supply (115 VAC only, 60 Hz, 15 A), properly grounded in accordance with National Electrical Code and local codes and ordinances is required.
- **IMPORTANT:** Do not kink or pinch the power supply cord between the ice maker and wall or cabinet.

Electrical Requirements

 **DANGER** 

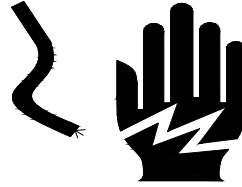

Electrical Shock Hazard

Plug into a grounded 3-prong outlet.

Never remove the grounding prong from the plug.

Never use an adapter.

Never use an extension cord.

Failure to follow these instructions can result in fire, electrical shock, or death

Before you move your icemaker into its final location, it is important to make sure you have the proper electrical connection:

A standard electrical supply (115 V, 60Hz.), properly grounded in accordance with the National Electrical Code and local codes and ordinances, is required.

It is recommended that a separate circuit, serving only your icemaker, be provided. Use receptacles that cannot be turned off by a switch or pull chain.

The fuse (or circuit breaker) size should be 3 amps.

Recommended grounding method

For your personal safety, this appliance must be grounded. It is equipped with a power supply cord having a 3-prong grounding plug. To minimize possible shock hazard, the cord must be plugged into a mating 3-pronged and grounding-type wall receptacle, grounded in accordance with the National Electrical Code and local codes and ordinances. If a mating wall receptacle is not available, it is the personal responsibility of the customer to have a properly grounded, 3-prong wall receptacle installed by a qualified electrician.

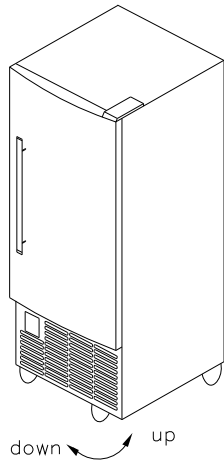

Leveling the Ice Maker

It is important for the icemaker to be leveled in order to work properly. It can be raised or lowered by rotating the plastic sheaths around each of the four feet on the bottom of the machine. If you find that the surface is not level, rotate the feet until the ice maker becomes level. You may need to make several adjustments to level it. We recommend using a carpenter's level to check the machine.

1. Place a carpenter's level on top of the product to see if the ice maker is level from front to back and side to side.
2. Adjust the height of the feet as follows:
Turn the leveling feet to the right to lower that side of the ice maker
Turn the leveling feet to the left to raise that side of the ice maker.

IMPORTANT: Once you are ready to install it in a cabinet or directly on the floor, you must adjust the feet to level the ice maker. If the floor is level, just revolve the two front feet to touch the floor.

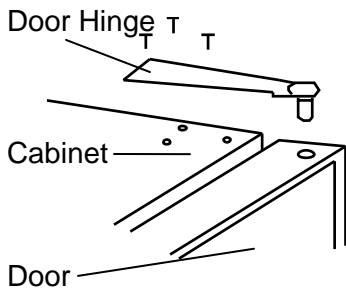

Reversing the Door Swing

Tools needed: flathead screwdriver, Phillips screwdriver
IMPORTANT: Before you begin, unplug the ice maker or disconnect power.

To remove door from hinges:

1. Using a Phillips screwdriver, remove the screws and take off top hinge. Keep the parts together and set them aside.
3. Lift door off bottom hinge and turn it upside down so that the handle is on the right. Set door aside.

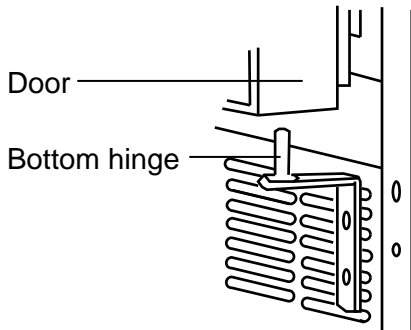

To replace door on hinges:

1. Using a flathead screwdriver, remove the plug buttons from the screw holes opposite the door hinges, top and bottom. Set aside.
2. Remove the bottom hinge, place on the opposite side at the bottom of the door.
3. Position the door on the bottom hinge.
4. Align the door on the bottom hinge and replace the top hinge.
5. Push the plug buttons into the original screw holes.

Water Supply Connections

The water supply should be ready at the point of installation. The water supply pressure should be a minimum of 15 psig with a static pressure not more than 80 psig. (A wall outlet directly behind the ice maker will make installation easier.)

IMPORTANT:

1. *All installations must be in accordance with local plumbing code requirements.*
2. *Make certain that the pipes are not pinched or kinked or damaged during installation.*
3. *Check for leaks after connection.*

Tools required: ½ in. open-end wrench, Phillips screwdriver

Connecting the water line:

1. Turn off main water supply. Turn on nearest faucet long enough to clear line of water.
2. Find a ½ in. to ¾ in. vertical cold water pipe near the installation location. The distance should be less than 9 feet. The water supply hose provided with the ice maker is about 9 feet long.
3. A shut-off valve must be installed to the main water supply. If the water pipe has a plain piece of copper tubing, attach a ¼" O.D. compression union to the tubing and remove the nut.
4. Connect nuts of the water supply hose to tap and water inlet valve. Tighten firmly by hand, then one-half turn with wrench.
5. Turn on main water supply and tap. Check for water supply connection leaks. Tighten every connection (including connections at the water inlet).

IMPORTANT: When you connect the water supply hose, pay attention to the indications of "Water inlet" on the machine.

- In general, it is always a good idea to filter the water. A water filter can remove taste and odors as well as particles. Where water is very hard, softened water may result in white, mushy cubes that stick together. Deionized water is not recommended.

Drain

NOTE: There is a drain line on the ice maker. Please drain water to your drain through the drain line provided with ice maker.

1. Locate the floor drain near the ice maker. The distance should be less than 4.5 feet since the length of the long drain hose provided with the ice maker is about 4.5 feet.
2. Find the drain hose on the back of ice maker, then insert the other side of the hose into the drain line.

All horizontal runs of drain lines must have a fall of 1/4" per foot. An air gap will likely be required between the ice maker drain hose and the drain/waste receptacle. A stand pipe with a trap below it would be acceptable for the drain/waste receptacle. A floor drain is also acceptable.

4. Pour 1 gallon of water into the ice storage bin to check for proper drainage.

Note: a condensate pump can allow for installation further from your drain. Consult your plumber for advice.

OPERATION

Final Check List before Operation

1. Have all packing materials and tape been removed from the interior and exterior of the ice maker?
2. Did you clean the ice storage bin?
3. Have the installation instructions been followed, including connecting the machine to water and electricity? Does the unit have proper drainage?
4. Has the machine been leveled?
5. Is the ice maker in a site where the ambient temperature is between 50° F and 100°F and the water temperature between 41° F and 90° F all year round?
6. Has the water supply pressure been checked to ensure a minimum of 15 psig with a static pressure not to exceed 80 psig?
7. Is there a clearance of at least 2/5" at the rear, 1" at the top and 1/5" at the sides for proper air circulation?
8. Has the power supply voltage been checked or tested against the nameplate rating? And has proper grounding been installed for the ice maker?
9. Is the ice maker plugged in?
10. Have you turned on the main water supply and the tap?
11. Have you checked for leaks at all water supply connections- and at the drain?

Operating Method

1. Turn on the water tap, let the water trough fill, then switch the ICE/OFF/WASH switch on the front panel to the ICE position. The ice maker will start working automatically.

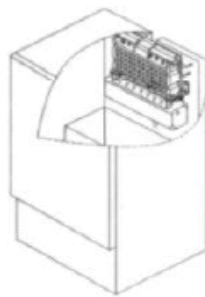

Ice making stage

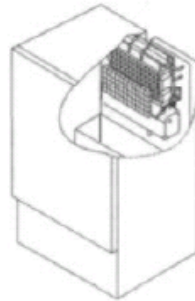

Ice harvest stage

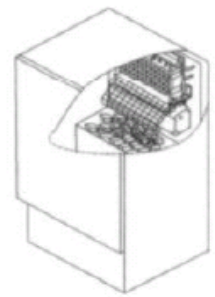

Ice full stage

2. After three minutes, the machine will automatically go to the ice making stage, and the sound of flowing water will be heard.
3. When the batch of ice has been fully formed, ice will automatically be harvested to the ice storage bin.
4. When the ice storage bin is full, the sheet of cubes will not fall completely and will hold the ice-full probe open. The machine stops making ice and automatically progresses to the cold preservation stage. During this stage, the compressor works regularly to keep the temperature lower to reduce ice melting.
5. The unit will start making ice again after the ice cubes are removed. At that time, the ice-full probe swings back to operating position.

IMPORTANT:

- Although the unit has been tested and cleaned at the factory, due to long-term transit and storage, the first batch of cubes must be discarded.
- Never turn the water supply tap off when the ice maker is working.
- Never touch the evaporator when the machine is running.
- Except to take ice from the unit, keep the door closed to reduce melting and insure proper ice formation.

How the machine Makes Ice

Turn the ICE/OFF/WASH switch to the ICE position. The machine will automatically start the ice making stage. There are two distinct cycles: freeze and harvest. During the freeze cycle, water flows to the evaporator surface. In the harvest cycle, the ice is released and water enters the machine. A complete cycle can take 15 to 40 minutes, depending on temperature and operating conditions.

Freeze: During the freeze cycle the compressor is pumping refrigerant, the fan motor is blowing air, and the water pump is circulating water. When the batch of ice has been fully formed, the ice maker stops the freeze cycle and begins the harvest cycle.

Harvest: During the harvest cycle the compressor is still operating, but the water pump has stopped. The hot gas valve opens, diverting hot refrigerant gas into the evaporator. The gas warms the evaporator, causing the cubes to slide, as a unit, off the evaporator and into the storage bin. The freeze cycle will restart when all the cubes have been harvested.

How the machine uses the water

The ice maker begins with a fixed charge of water that is contained in the water trough. As the water flows to the freezing evaporator surface, the portion of water that does not contain mineral impurities will freeze and stick to the ice cube molds. The water containing impurities falls back into the trough. During the ice-making process, fresh water enters the water trough continuously as the water from the trough freezes continuously on the evaporator.

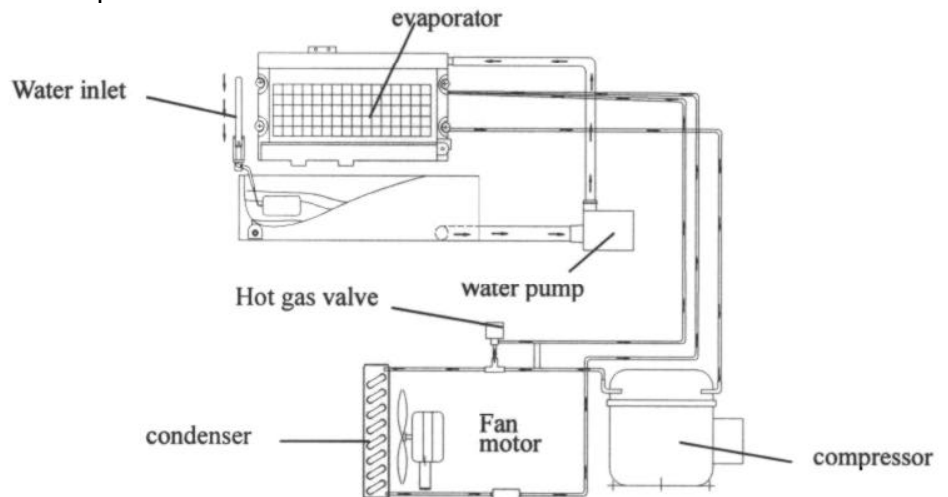

Normal Sounds

Your new icemaker may make sounds that are not familiar to you. Most of the new sounds are normal. Hard surfaces like the floor, walls can make the sounds seem louder than they actually are. The following describes the kinds of sounds that might be new to you and what may be making them.

- Rattling noises may come from the flow of the refrigerant or the water line, Items stored on top of the icemaker can also make noises.
- The high efficiency compressor may make a pulsating or high-pitched sound.
- Water running from the evaporator to the water bin may make a splashing sound.
- As each cycle ends, you may hear a gurgling sound due to the refrigerant flowing in your icemaker.
- You may hear air being forced over the condenser by the condenser fan.
- During the harvest cycle, you may hear the of ice cubes falling into the ice storing bin.

Preparing the Icemaker for Long Storage

If the ice maker will not be used for a long time, or is to be moved to another place, it will be necessary to drain the system of water.

1. Shut off the water supply at the main water source.
2. Disconnect the water supply line from the water inlet.
3. Shut off the electric supply at the main electrical power source.
4. Take out the ice storage bin to remove ice and water. Dry it.
6. Pull off the drainage tube of the water trough to drain off all water.
7. Leave the door open to allow for circulation and to prevent mold and mildew.
8. Leave the water supply line and power cord disconnected until ready to reuse.

IMPORTANT:

- *Do not touch the power plug when your hands are wet.*
- *Never unplug the unit by pulling on the plug.*

CLEANING AND MAINTENANCE

CAUTION

The icemaker must be thoroughly cleaned if it has been left unused for a long time. Follow carefully any instructions provided for cleaning or use of sanitizing solution. Do not leave any solution inside the icemaker after cleaning.

Periodic cleaning and proper maintenance will ensure efficiency, top performance, and long life. The maintenance intervals listed are based on normal conditions. You may want to shorten the intervals if you have pets, or there are other special considerations.

Note: Never keep anything in the ice storage bin that is not ice: objects like wine or beer bottles are not only unsanitary, but the labels may slip off and plug up the drain.

What should be kept clean

There are 5 things to keep clean:

1. The exterior.
2. The interior.
3. The condenser
4. Water distribution tube
5. The ice-making system

⚠ WARNING

Before proceeding with cleaning and maintenance operations, make sure the power line of the unit is disconnected and the water line is shut off. (EXCEPTION: Cleaning of ice-making system)

Exterior Cleaning

The door and cabinet may be cleaned with a mild detergent and warm water solution such as 1 oz of dishwashing liquid mixed with 2 gallons of warm water. Do not use solvent based or abrasive cleaners. Use a soft sponge and rinse with clean water. Wipe with a soft clean towel to prevent water spotting. If the door panel is stainless finish, it can discolor when exposed to chlorine gas and moisture. Clean stainless finish with a cloth dampened with a mild detergent and warm water solution. Never use an abrasive cleaning agent.

Interior Cleaning

The ice storage bin should be sanitized occasionally. Clean the water trough before the ice maker is used for the first time and reused after stopping for an extended period of time. It is usually convenient to sanitize the trough after the ice making system has been cleaned and the ice storage bin is empty.

1. Disconnect power to the unit.
2. Open the door and take out the removable storage bin. With a clean cloth, wipe down the interior of the unit with a sanitizing solution made of 1 ounce of household bleach and 2 gallons of hot water (95° to 115°F).
3. Rinse thoroughly with clean water.
4. Put the cleaned and empty ice storage bin back inside the unit.
5. Reconnect power to the unit.

The ice scoop should be washed regularly. Wash it just like any other utensil.

WARNING

DO NOT use solvent-based cleaning agents or abrasives on the interior. These cleaners may transmit taste to the ice cubes, or damage or discolor the interior.

Condenser Cleaning

A dirty or clogged condenser prevents proper airflow, reduces ice making capacity, and causes higher than recommended operating temperatures that may lead to component failure. Have the condenser cleaned at least once every six months.

1. Unplug the ice maker or disconnect power.
2. Remove the 2 screws at the bottom of the front cover and gently pull it off.
3. Locate the condenser filter. This can be lifted out and cleaned with a brush or flowing water.

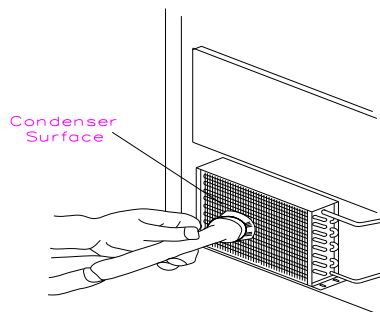

4. Remove dirt and lint condenser fins and the unit compartment with a brush attachment on a vacuum cleaner.
5. Put back the filter and reassemble the front cover.
6. Plug in the icemaker or reconnect power.

WARNING

DO NOT touch the condenser fins. They are sharp and can be damaged easily.

Water Distribution Tube cleaning

When you find that the ice cubes are incompletely formed or the output of ice cubes is low, the water distribution tube may be blocked. Set the ICE/OFF/WASH switch to OFF, rotate the water distribution tube, and locate the holes in the distribution tube. Using a toothpick or similar tool, dredge the holes, then rotate the water distribution tube back to its original position. If the tube is badly blocked, clean it as follows:

1. Shut off the water supply.
2. Disconnect the water hose from the distribution tube.
3. Lift the right side, then remove the distribution tube.
4. With a brush, clean the tube with a dilute solution of warm water and a mild detergent such as dishwashing liquid. After removing the dirt and lint from the surface, rinse the tube with clean water.
5. Replace the distribution tube.
6. Reconnect the water supply

Ice-making system Cleaning

Minerals that are removed from water during the freezing cycle will eventually form a hard scaly deposit in the water system. Cleaning the system regularly helps remove the mineral scale buildup. How often you need to clean the system depends upon how hard your water is or how effective your filtration may be . With hard water of 15 to 20 grains/gal. (4 to 5 grains/liter), you may need to clean the system as often as every 6 months.

1. Make sure that all the ice is off of the evaporator. If ice is being made, wait for cycle completion, then turn the machine "OFF" at the ICE/OFF/WASH selector switch.
2. Remove all ice from the storage bin .
3. Keep the ice maker connected to the water supply , Pour 200g. of Nickel-Safe Ice Maker Cleaner Solution into the water trough. After about 5 minutes, initiate the wash cycle at the ICE/OFF/WASH selector switch by the switch in the "WASH "position. The machine will run the Automatic Clean Mode.
4. Allow 30 minutes for proper cleaning. After cleaning, turn the machine "OFF" at the ICE/OFF/WASH selector switch, Drain off the waste water to some container by drain pipe in the left of the water trough.
5. Repeat steps 3 and 4 (without Ice Maker Cleaning Solution) to rinse the ice making system 3 times.
 - *Note: The use of the Ice Maker Cleaner Solution in the water bin during the rinse is not needed.*
6. Prepare a sanitizing solution made of 1 ounce of household bleach and 2 gallons of hot water (95° to 115° F). Wipe the entire bin inside and out, covering every wall surface.
7. Fill a spray bottle with the sanitizing solution and spray all corners and edges making sure to cover all surfaces with the solution.
8. Allow the solution to be in contact for at least 3 minutes, then dry.
9. Repeat step 5 to rinse the ice making system one more time.
10. Place the ICE/OFF/WASH selector switch to the "ICE " position. The machine will return to the regular ice making mode. Discard the first batch of ice.



- Many ice machine cleaners contain acids.
- DO NOT use or mix with any other solvent-based cleaner products.
- Use rubber gloves to protect your hands.
- Carefully read all safety instructions printed on the container of the ice machine cleaner.
- Discard the first batch of ice produced after cleaning.

Control Panel (rear of unit)

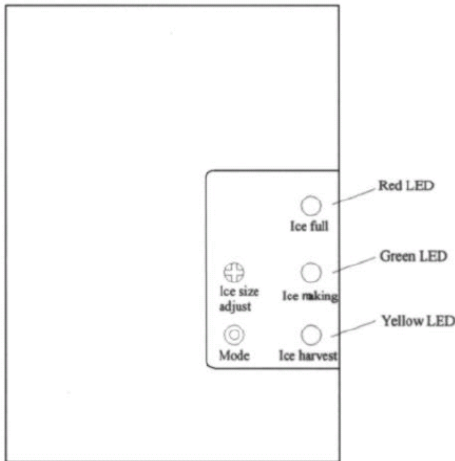

Descriptions of LEDs and buttons:

1. **Ice Full (Red) LED:** Ice Full indicator light.

When this LED is lit, the ice storage bin is full of ice or there is something obstructing the ice-full probe. The unit will stop working. When ice cubes are taken out of the ice storage bin, clearing the ice-full probe, the red LED will keep flashing for 3 minutes. Then the unit will restart and return to the ice making mode.

2. **Ice Making (Green) LED:** Ice Making indicator light.

When this LED is lit, the unit is working in the Ice Making mode controlled by a temperature probe on the evaporator. When the green LED is flashing, the unit is working in the Ice Making mode controlled by a fixed timer.

3. **Ice Harvest (Yellow) LED:** Ice Harvest indicator light.

When this LED is lit, the unit is working in the Ice Harvest mode controlled by the ice-full probe. When the green and yellow LEDs are lit, the unit is working in the cold preservation stage.

4. **Mode button:** Mainly for service. When this button is pressed, unit can change from Ice Making mode to Ice Harvest mode, or from Ice Harvest mode to Ice Making mode. You can judge the mode from the status of the green and yellow LEDs.

5. **Ice size adjust:** Turn the screw clockwise, and the size of individual ice cubes will be larger in the next cycle; the cycle time will be longer. Turn the knob counterclockwise, and the ice size will be smaller in the next cycle.

IMPORTANT:

- *It is not recommended that the ice size be adjusted unnecessarily since this could damage the machine's controls.*
- *Do not let water contact the control box.*

Major Functions

1. Completely automatic operation.
2. When the ice storage bin is full, the machine stops making ice and proceeds to the cold preservation stage automatically. It starts making ice again once the cubes are removed.
3. The different colors of the LED display indicate various operating modes.
4. The fan motor responds to the ambient temperature. If it is cold, the motor will stop working to keep the cooling system in good working condition.
5. Ice cube size is adjustable.
6. A sensitive probe and accurate timer enhance the performance of the ice maker.
7. Built-in compressor protection system.

TROUBLESHOOTING

Before Calling for Service

If the unit appears to be malfunctioning, read through the OPERATION section of this manual first. If the issue persists, check the troubleshooting section below. The issue could be solved by following the suggestions in the "Solution" column.

Issue	Possible Cause	Solution
The machine won't operate.	The icemaker is unplugged.	Plug the ice maker in.
	The fuse is blown.	Replace fuse.
	The icemaker power switch is OFF.	Turn the ice maker power switch to ICE (ON)
	The ice storage bin is full of ice.	Take away some ice cubes; make the ice-full probe is free of ice.
The water doesn't feed in after the ice maker starts.	The water supply tap is turn off.	Turn on the water supply tap.
	The water supply pipe is not proper connected.	Reconnect the water supply pipe.
Machine makes ice, but bin does not fill up with ice	The condenser may be dirty.	Clean the condenser.
	The air flow to the ice maker may be obstructed.	Check the installation.
	The ambient temperature and water temperature are high, or it is near with some heat source.	Check the installation.
Water is leaking out the unit.	A few water droplets are on the door.	Under some conditions, humidity may condense on the door. Consider moving the unit or just be more careful when you open the door.
	The water supply connection is leaking.	Tighten fitting. See "Connecting the water line".
Cubes are partially formed--are white at the bottom.	Not enough water in the water bin.	Check if the water supply pressure is below 0.05Mpa.
		Check water supply--filter may be restricted.
		Check for a water leak at the water trough.
Noise during operation	The feet are not leveled and locked	Level and lock the feet. See Leveling the Ice Maker.
	Certain sounds are normal.	See "Normal Sounds."
The icemaker stops suddenly while making ice.	The electricity is off.	Reconnect the power supply line.
	The room temperature is out of the stated range.	Cut off the electricity and let the ice maker stop working until the temperature returns within the stated range.
The body of the ice maker is electrified	The ground line isn't in the socket.	Use the correct plug and outlet.
Scale builds up quickly inside the machine.	The calcium level in the water is too high.	Use a water-softening apparatus installed in front of the water inlet valve.

Specifications

Description of product	Built-in Ice Maker
Model	KIM450S
Voltage/Frequency	AC 115V~60Hz
Ice-Making / Ice-Harvest rated current	3.7A / 4.8A
Estimated Power Consumption	13.2 kWh/100 lbs of ice
Color	Black Cabinet; Stainless Finish Door
Ice Storage capacity	25 lbs maximum
Ice-making capability	45 lbs / day **
Refrigerant	R134a, 6.35 oz.
High / Low side pressure	350psig / 120psig
Dimensions (Width x Depth x Height)	14.6" x 23.6" x 32.8"
Weight	91.5 lbs

Note: Technical data and performance information provided for reference only.

Specifications are subject to change. Check the rating label on the ice maker for the most accurate information.

* The actual quantity of ice produced per day will vary with room and water conditions.

Notes on ice storage

The ice maker will automatically shut off when the ice bin is full. The ice bin compartment is insulated, but not refrigerated and the ice in the bin will slowly melt and go out the drain. Once enough of the ice has melted, the ice maker will automatically start making more ice.

Limited Warranty

One (1) Year Parts & Ninety (90) Days Labor

This product is warranted by EdgeStar to be free from defective workmanship and materials, subject to any conditions set forth as follows:

WHAT IS COVERED:

LABOR: For a period of NINETY (90) DAYS from the date of original purchase, labor will be performed free of charge at an authorized EdgeStar repair facility. At its option, EdgeStar will repair the product with new or remanufactured parts, or exchange the defective product with a new, refurbished, or remanufactured product. If a product is replaced, it will carry the remaining warranty of the original product. After the ninety (90) day period, EdgeStar will no longer be responsible for labor charges incurred. All defective products and parts covered by this warranty will be repaired or replaced on a mail-in basis to an EdgeStar authorized repair facility.

PARTS: For a period of ONE (1) YEAR from the date of original purchase, EdgeStar will supply new, rebuilt, or refurbished parts free of charge. EdgeStar may request a defective part be returned in exchange for the replacement part. All replacement parts or products will be new, remanufactured, or refurbished. All products and parts replaced by EdgeStar under warranty service become the property of EdgeStar.

This warranty applies to the original purchaser only, and only covers defects in workmanship experienced during operation of the product under normal service, maintenance, and usage conditions. This warranty applies to the purchase and use of this product in residential settings within the United States of America.

WHAT IS NOT COVERED:

The following limitations apply to the coverage of this warranty. This warranty does not cover:

- Labor charges for installation, setup or training to use the product.
- Shipping damage, and any damage caused by improper packaging for shipment to an authorized service center, and any damaged caused by improper voltage or any other misuse, including abnormal service, handling, or usage.
- Cosmetic damage such as scratches and dents.
- Normal wear and tear on parts or replacement of parts designed to be replaced, e.g. filters, cartridges, batteries.
- Service trips to deliver, pick-up, or repair, install the product, or to instruct in proper usage of the product.
- Damages or operating problems resulting from misuse, abuse, operation outside environmental specifications, uses contrary to instructions provided in the owner's manual, accidents, acts of God, vermin, fire, flood, improper installation, unauthorized service, maintenance negligence, unauthorized installation or modification, or commercial use.
- Labor charges incurred 91 days or more after the date of original purchase.
- The use of EdgeStar products in commercial settings.
- Optional accessories, attachments, and appearance items.
- Products that have been modified to perform outside of specifications without the prior written permission of EdgeStar.
- Products lost in shipment, or theft.
- Products sold AS IS or from an unauthorized reseller.
- Products that have had their serial numbers removed or defaced. Products with serial numbers that have been invalidated.

OBTAINING WARRANTY SERVICE:

If you believe your product is defective, contact EdgeStar Customer Support for troubleshooting assistance and warranty service at 1-866-319-5473. Please have your serial number and proof of purchase available. Once an EdgeStar authorized representative has confirmed that your product is defective and eligible for warranty service, the product must be returned to an EdgeStar repair facility. The purchaser is solely responsible for prepaying all shipping related costs to and from the repair facility. EdgeStar is not responsible for damage resulting from shipper mishandling or improper packaging. Do not return a defective product to the place of purchase. Products received without a return authorization number will be refused.

THIS WARRANTY IS IN LIEU OF ANY OTHER WARRANTY, EXPRESS OR IMPLIED, INCLUDING WITHOUT LIMITATION, ANY WARRANTY OF MERCHANTABILITY OR FITNESS FOR A PARTICULAR PURPOSE. TO THE EXTENT ANY IMPLIED WARRANTY IS REQUIRED BY LAW, IT IS LIMITED IN DURATION TO THE EXPRESS WARRANTY PERIOD ABOVE. NEITHER THE MANUFACTURER NOR ITS DISTRIBUTORS SHALL BE LIABLE FOR ANY INCIDENTAL, CONSEQUENTIAL, INDIRECT, SPECIAL, OR PUNITIVE DAMAGES OF ANY NATURE, INCLUDING WITHOUT LIMITATION, LOST REVENUES OR PROFITS, OR ANY OTHER DAMAGE WHETHER BASED IN CONTRACT, TORT, OR OTHERWISE. SOME STATES DO NOT ALLOW THE EXCLUSION OF INCIDENTAL OR CONSEQUENTIAL DAMAGES, SO THE ABOVE EXCLUSION MAY NOT APPLY TO YOU. THIS WARRANTY GIVES YOU SPECIFIC LEGAL RIGHTS. YOU MAY HAVE OTHER RIGHTS THAT VARY FROM STATE TO STATE.

Koldfront

By

EdgeStar Products
Box 81336
Austin, TX 78708-1336

Toll Free: 1-866-319-5473
Web: <http://www.edgestar.com>
E-mail: service@edgestar.com

Register your product, download owner's manuals, access additional troubleshooting resources, and obtain more information on other great EdgeStar & KoldFront products on the web at: [**http://www.edgestar.com**](http://www.edgestar.com)

Product contents and specifications may change without notice.

Copyright © 2009-2010 Living Direct, Inc.

Free Manuals Download Website

<http://myh66.com>

<http://usermanuals.us>

<http://www.somanuals.com>

<http://www.4manuals.cc>

<http://www.manual-lib.com>

<http://www.404manual.com>

<http://www.luxmanual.com>

<http://aubethermostatmanual.com>

Golf course search by state

<http://golfingnear.com>

Email search by domain

<http://emailbydomain.com>

Auto manuals search

<http://auto.somanuals.com>

TV manuals search

<http://tv.somanuals.com>