



KONICA MINOLTA

LIGHT METERS

ILLUMINANCE METER

LUMINANCE METER

CHROMA METER



T-10A /T-10MA/ T-10WsA/T-10WLA

CL-200A

CL-500A

LS-100/LS-110

CS-100A

CS-200

Giving Shape to Ideas

Illuminance Meter T-10A series

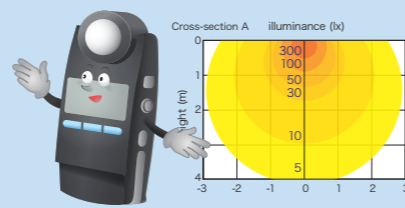

Compatible with new, next-generation light sources including PWM-controlled sources. For simple but accurate illuminance measurements. Makes creating illuminance measurement systems such as multi-point measurement systems easy!

<Standard receptor>

T-10A



Receptor diffuser window: Ø 25 mm

<Mini receptor>

T-10MA/T-10W_SA/T-10W_LA



Receptor diffuser window: Ø 14 mm

T-10A

Conforms to JIS AA Class and DIN class B

Can be used for general measurements of illuminance.

T-10MA (Cord length: 1 m)

Conforms to JIS AA Class and DIN class B

Enables illuminance measurements of small areas.

Can be used for illuminance measurements in narrow spaces where the standard receptor won't fit. It can also be easily installed on various kinds of equipment or jigs for measuring light levels such as illumination.

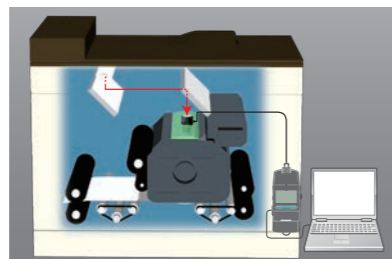

T-10W_SA (Cord length: 5 m)

T-10W_LA (Cord length: 10 m)

Conforms to JIS requirements for special illuminance meters

Waterproof

Custom order

The mini receptor and cord are both waterproof, so they can be used for measurements in water. They can be used for illuminance control for fishery-related applications (such as fish farming, etc.) or for measuring outdoor illuminance on rainy days.

Main Features

Reliable, worry-free illuminance meters that conform to JIS AA Class and DIN Class B

Illuminance Meters T-10A and T-10MA conform to Class AA of JIS C 1609-1: 2006 "Illuminance meters Part 1: General measuring instruments" and DIN 5032 Part 7 Class-B "Photometry; classification of illuminance meters and luminance meters" requirements to provide high-accuracy, high-reliability, worry-free measurements. Illuminance meters conforming to these standards are required for measurements of general illumination light sources, white LED lamps for illumination, etc. in a variety of industrial fields.

Removable receptor

The receptor and main body can be detached from each other and then connected using a LAN cable, making it easy to install as part of an inspection system.

Compatible with PWM-controlled lighting. Enables measurements of next-generation light sources.

Conventional illuminance meters often cannot accurately measure PWM-controlled light sources, but the T-10A series of illuminance meters can be used to accurately measure even such light sources.

Easy, inexpensive multi-point measurement (2 to 30 points).

Illuminance distribution of a projector etc. can be easily measured with a single instrument and several receptors.



Multi-point illuminance measuring system

● 5-point example: Architectural lighting, etc.

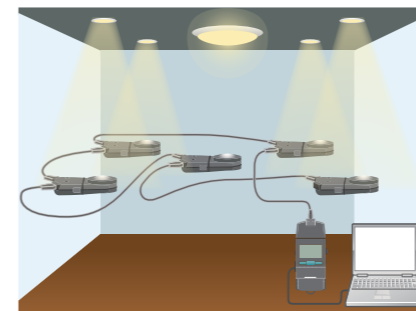

● 9-point example: Projectors, etc.

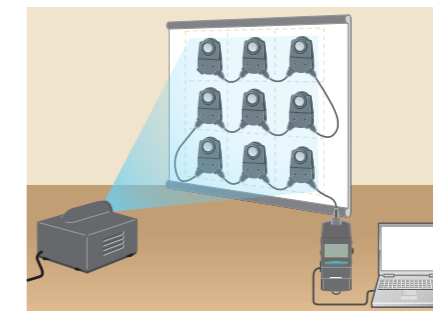

● 25-point example: Street lighting, etc.

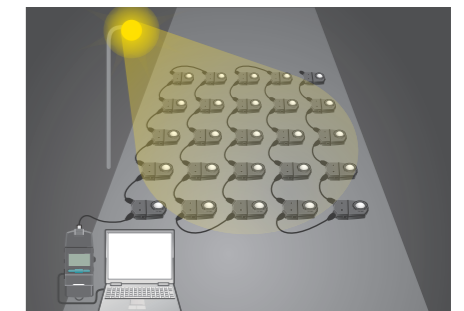

[T-10A 9-point measuring system composition]

Illuminant Meter T-10A	1 unit
T-10A Receptor Head	8 units
Adapter units for Main Body T-A20	1 unit
Adapter units for Receptor Head T-A21	9 units
AC Adapter	1 unit
Data Management Software T-S10w	1 set

Main applications

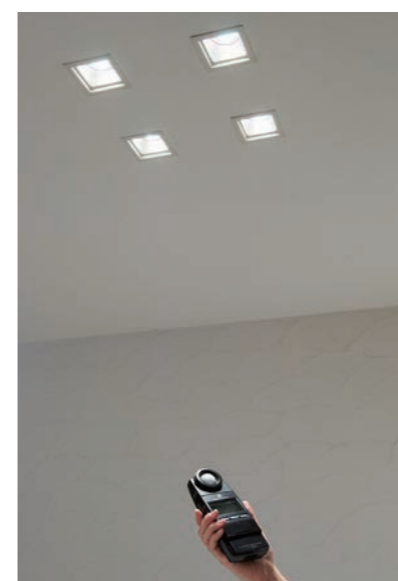

- Government testing organizations
- Research/inspection at illumination equipment makers
- Maintenance at factories, offices, hospitals, etc.



- Illuminance control of security lighting, street lighting, etc.
- As sensor for equipment measuring light-distribution characteristics, etc.

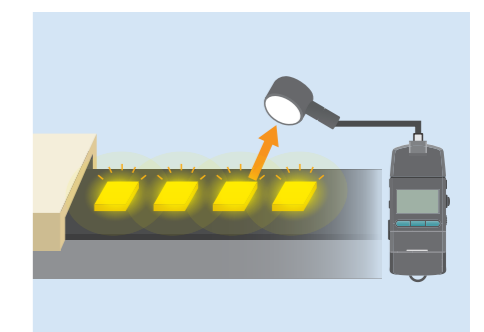

Data Management Software T-S10w (Optional accessory)

Convenient, easy-to-use Excel® add-in software

Reads measurement data from T-10A series Illuminance Meters directly into Excel®. Further processing of data can then be performed easily using the various functions of Excel®.

Main specifications of Data Management Software T-S10w

Type	Add-in for Excel® (Excel® is required to use this add-in.)
Operating environment	One of the following environments with Excel® installed: * Languages in parenthesis () are the OS language. Windows® XP + Excel® 2003 (English, Japanese, or Simplified Chinese) Windows® 7 + Excel® 2010 (English, Japanese, or Simplified Chinese) * For details on system requirements for above versions of Windows® and/or Excel®, refer to their respective specifications. * Not compatible with 64-bit versions of office 2010.
Compatible instruments	T-10A, T-10MA, T-10WsA, T-10WLA, T-10, T-10M, T-10Ws, T-10W.

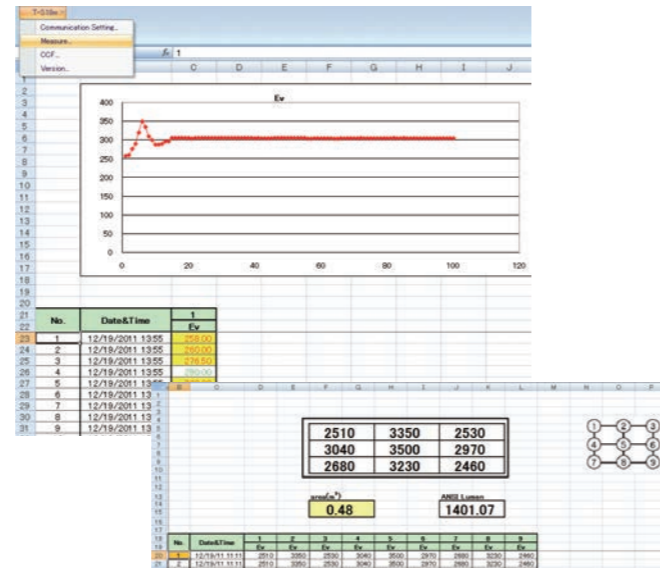

System diagram

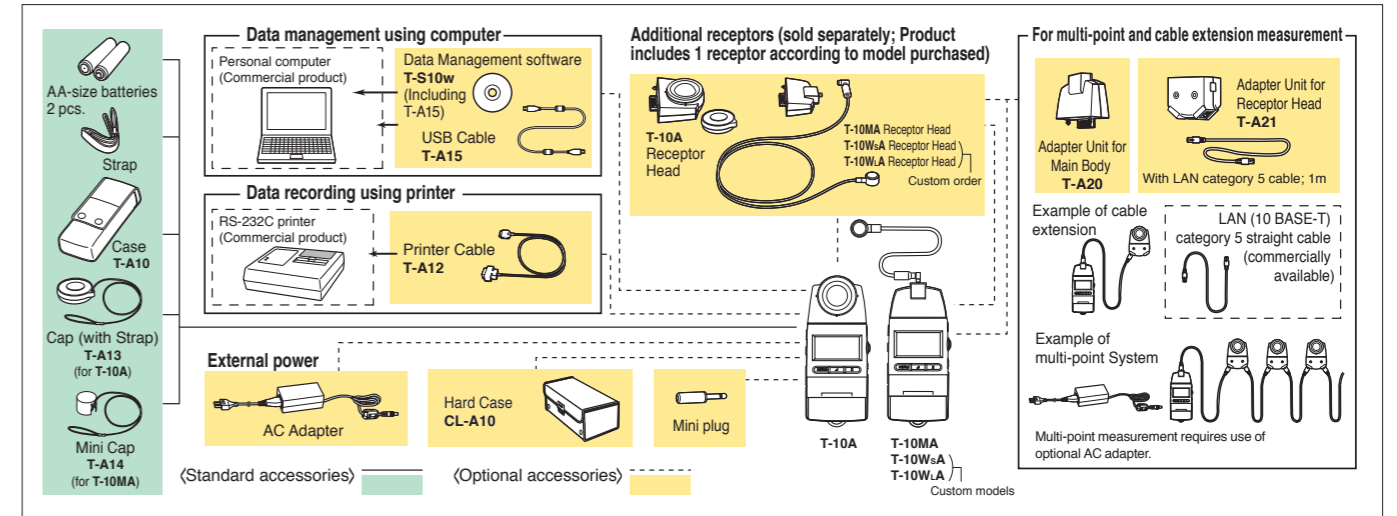

Main Specifications of T-10A

Model	Illuminance Meter T-10A (Standard receptor head)	Illuminance Meter T-10MA (Mini receptor head)	Illuminance Meter T-10WsA (Waterproof mini receptor head)	Illuminance Meter T-10WLA (Waterproof mini receptor head)
Type	Multi-function digital illuminance meter with detachable receptor head (Multi-point measurements of 2 to 30 points is possible)			
Illuminance meter class	Conforms to requirements for Class AA of JIS C 1609-1: 2006 "Illuminance meters Part 1: General measuring instruments" Conforms to DIN 5032 Part 7 Class B		Conforms to requirements for special illuminance meters of JIS C 1609-1: 2006 *1	
Receptor	Silicon photocell			
Relative spectral response	Within 6% (f1') of the CIE spectral luminous efficiency V (λ)			
Cosine response (f2)	Within 3%		Within 10%	
Measuring range	Auto range (5 manual ranges at the time of analog output)			
Measuring function	Illuminance (lx), illuminance difference (lx), illuminance ratio (%), integrated illuminance (lx·h), integration time (h), average illuminance (lx).			
Measuring range	Illuminance	0.01 to 299,900 lx; 0.001 to 29,990 fcd	1.00 to 299,900 lx; 0.1 to 29,990 fcd *2	
	Integrated illuminance	0.01 to 999,900 x 10 ³ lx·h / 0.001 to 99,990 x 10 ³ fcd·h / 0.001 to 9999 h		
User calibration function	CCF (Color Correction Factor) setting function: Measurement value x 0.500 to 2.000			
Linearity	±2% ±1 digit of displayed value			
Temperature/humidity drift	Within ±3%			
Computer interface	USB			
Printer output	RS-232C			
Analog output	1 mV/digit, 3 V at maximum reading; Output impedance: 10 KΩ; 90% response time: 28 ms			
Display	3 or 4 Significant-digit LCD with backlight illumination (Automatic illumination)			
Power source	2 AA-size batteries / AC adapter AC-A308 (optional; for 1 to 10 receptors) or AC adapter AC-A311 (optional; for 1 to 30 receptors)			
Battery life	72 hours or longer (when alkaline batteries are used) in continuous measurement			
Operating temperature/humidity range	-10 to 40°C, relative humidity 85% or less (at 35°C) with no condensation		5 to 40°C, relative humidity of 85% or less (at 35°C) with no condensation	
Storage temperature/humidity range	-20 to 55°C, relative humidity 85% or less (at 35°C) with no condensation		0 to 55°C, relative humidity of 85% or less (at 35°C) with no condensation	
Dimensions	69 x 174 x 35 mm	Main body: 69 x 161.5 x 30 mm Receptor: Ø16.5 x 13.8 mm		
Cord length	-	1 m	5 m	10 m
Weight (without battery)	200 g (7.0 oz.)	205 g	260 g (Receptor head only: 120 g)	340 g (Receptor head only: 200 g)

*1 Conforms to requirements for Class AA of JIS C 1609-1: 2006 for all items except cosine response (f2).
*2 Although measurements below 1.00 lx are possible, they may not be stable due to the effects of electrical noise.
<Notes regarding mini receptors and waterproof mini receptors>
*Do not touch the cable during measurements. Doing so may result in unstable measurement values.
*Secure the cable during measurements. Failure to do so may result in unstable measurement values.

Dimensions (Units: mm)

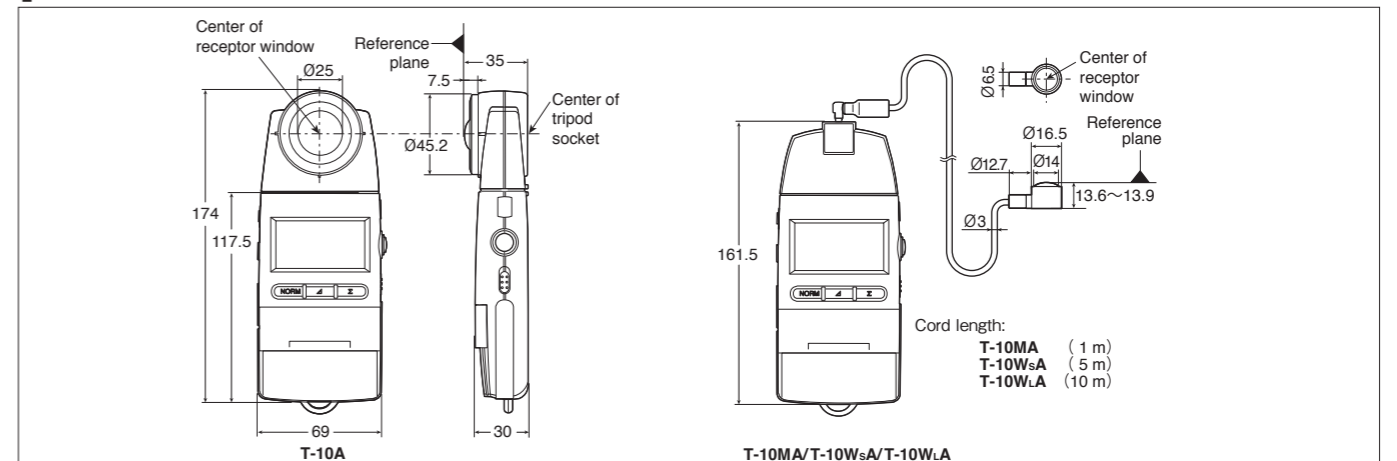

Relative Spectral Response

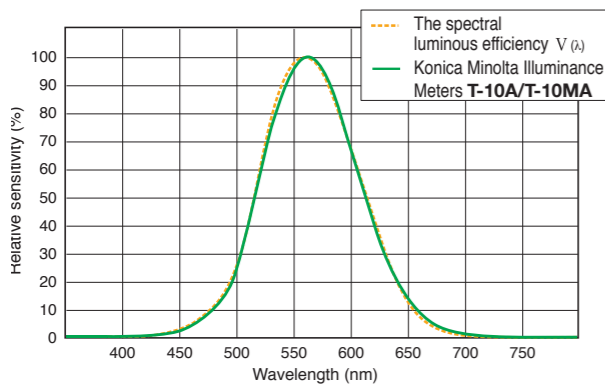

Ideally, the relative spectral responsivity of the illuminance meter should match $V(\lambda)$ of the human eye for photopic vision. As shown in the graph above, the relative spectral responsivity of Konica Minolta Illuminance Meters T-10A/10MA is within 6% (f1') of the CIE spectral luminous efficiency $V(\lambda)$.

CIE ; Commission Internationale de l'Éclairage

f1' (CIE symbol) ; The degree to which the relative spectral responsivity matches $V(\lambda)$ is characterized by means of the error f1'.

Cosine Correction Characteristics

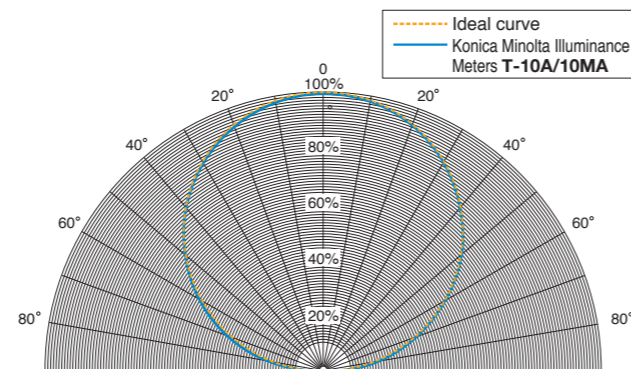

Since the brightness at the measurement plane is proportional to the cosine of the angle at which the light is incident, the response of the receptor must also be proportional to the cosine of the incidence angle.

For Konica Minolta Illuminance Meters T-10A/10MA, the cosine response f2 is within 3%.

The graph above shows the cosine correction characteristics of Konica Minolta Illuminance Meters T-10A/10MA.

About PWM-controlled lighting

PWM is the abbreviation of Pulse Width Modulation, and refers to the method of controlling signal intensity by controlling the ratio between the ON period and OFF period of a pulse signal. A pulse signal is a signal which repeatedly alternates between ON and OFF, and the percentage of ON period during a single cycle is referred to as the "duty cycle".

PWM-controlled lighting is a method for controlling the brightness of a lamp by controlling the duty cycle (lit time) of light from a pulse-emission source. As the lit time becomes longer, the light becomes brighter, and conversely, as the lit time becomes shorter the light becomes darker.

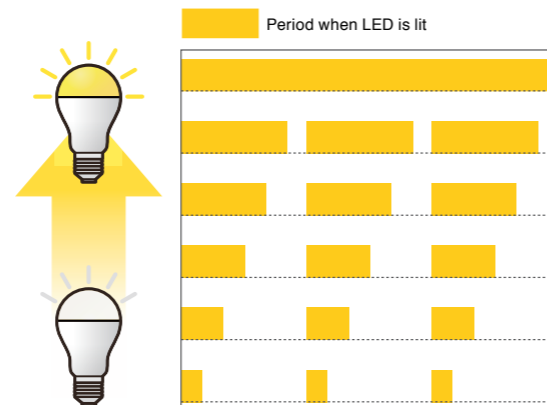

Chroma Meter CL-200A

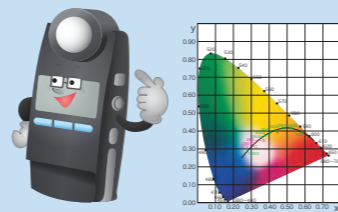

De facto industry standard for measuring color temperature!
Can also measure illuminance (JIS AA class)

Main Features

Compact and easy to carry

The CL-200A's compact body fits in your palm. Battery-powered so it can be taken along and used anywhere.



Data transfer using main body buttons

When using the CL-200A with Data Management Software CL-S10w (included), measurements can be taken and data transferred to Excel® using the main body buttons as well as computer keys.

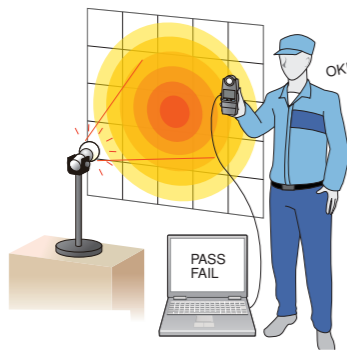

Detachable receptor head

The receptor head can be detached and then connected to the main body using a normal LAN cable*, making it easy to install the sensor in an inspection system.

* Optional Adapter Units required for receptor head and main body

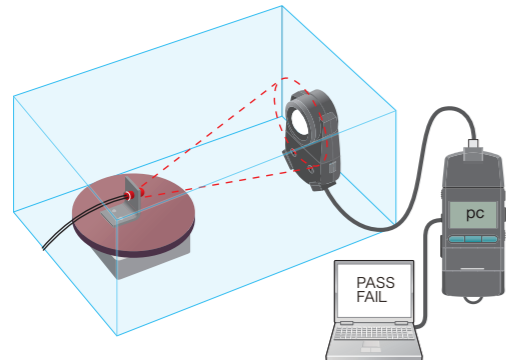

Excel® add-in software included

Data Management Software CL-S10w
 (Standard accessory)

Easy, convenient Excel® add-in

Measurement data from the CL-200A can be transferred directly into Excel®. The transferred data can then be managed freely within Excel®.

Includes LED ranking function

Color variations, the top topic in the LED industry, can be quantified and a ranking function is also provided.

JIS correlated color temperature

Correlated color temperature is determined using the equations defined by JIS (Japanese Industrial Standards).

Multi-point measurement and user calibration also possible

Multi-point measurement management using up to 30 receptor heads is possible.

User calibration function enables compensation of measurement values to match a desired standard. Calibration can be performed by two methods: Single-point calibration or RGB calibration.

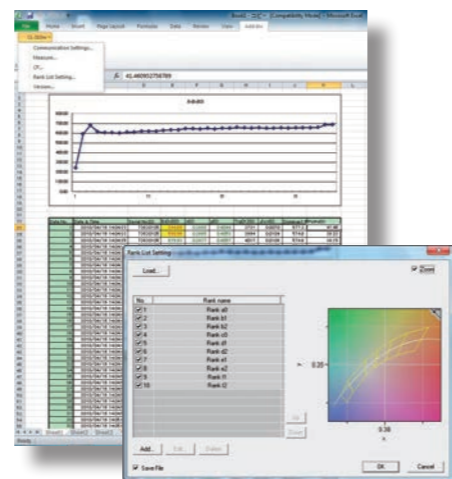

Measures color temperature and Chromaticity!

Measures dominant wavelength!

Even measures excitation purity!



Application examples

For lighting production and adjustment

When using various types of light sources in a room or open space, it is sometimes necessary to check the color of the lighting. By using the CL-200A, it is possible to adjust the lighting color so that the food in a restaurant looks delicious.



For evaluating light source characteristics

Evaluation of the light distribution of LED illumination modules or the illuminance distribution of lighting fixtures can be evaluated.

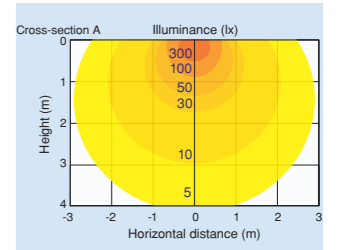

For color-viewing cabinet maintenance

A color-viewing cabinet like that shown at left is used in industries such as the printing industry to visually evaluate finished work under controlled conditions. This color-viewing cabinet provides illumination at a specific illuminance and color temperature by using fluorescent lamps, halogen lamps, etc. The CL-200A can be used for the daily maintenance and control of these lamps as well as to indicate when replacement is needed.



For projector light-source research and color inspection

The CL-200A can be used to measure the white balance and uniformity of microprojectors, etc. with internal LED light sources. The ability to connect multiple receptors using LAN cables enables measurement of not only a single point in the center, but up to a maximum of 30 points over the entire projected area.



For LED billboard development and maintenance

The CL-200A enables quality control of the LED modules for digital signage to be performed easily. If modules with different color tones are used together, the billboard will look mottled, but by measuring the chromaticity and color temperature of modules using the CL-200A and selecting modules based on measured values, billboard uniformity can be achieved.



Multi-point illuminance measuring system

- 5-point example: Architectural lighting, etc.
- 9-point example: Projectors, etc.
- 25-point example: Street lighting, etc.

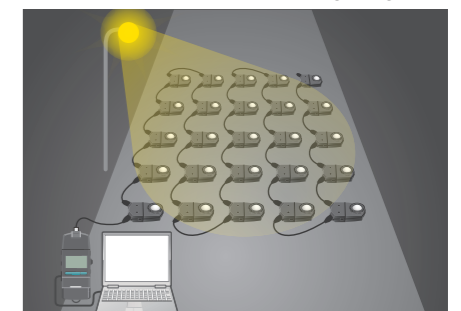
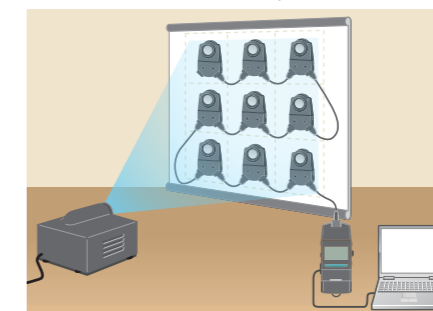
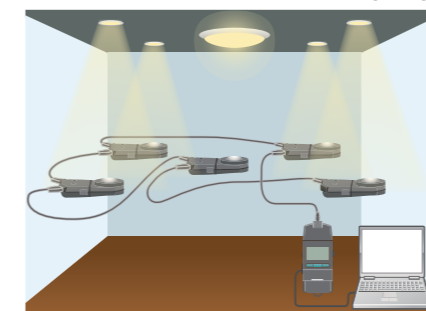

[CL-200A 9 point measuring system composition]

Chroma Meter CL-200A	1 unit
CL-200A Receptor Head	8 units
Adapter Unit for Main Body T-A20	1 unit
Adapter Unit for Receptor Head T-A21	9 units
AC Adapter	1 unit
Data Management Software CL-S10w	1 set

For accurate measurements of color temperature, use the CL-200A!

CL-200A

The CL-200A has sensors that closely match the CIE*-defined color-matching functions which are intended to correspond to the response of the human eye to enable precise color measurement. The measurement results can be displayed in various color notations such as "Correlated color temperature and Δuv " according to the application.

*CIE: International Commission on illumination

Photographic color meter

In order to take more beautiful pictures, it is sometimes necessary to attach filters in front of the camera lens to compensate for the color of the light illuminating the subject. A photographic color meter is a meter used to select the appropriate filters, with the sensitivity of its sensors adjusted to match that of the film or digital camera sensor. In addition, because it uses photographic color temperature, which is calculated based mostly on the blue/red balance of the illumination, large errors may occur if it is used to measure light sources with non-continuous spectrums.

[Actual measurement data for daylight-color LED bulb]

	Measured color temperature	Color-temperature difference from standard-instrument measured value
Our company's standard instrument	5045	0
CL-200A	5011	-34
Photographic color meter	5600	555

Color temperature and correlated color temperature

Color temperature

When an ideal blackbody* is heated, it begins to emit light, and as the temperature increases the color of the emitted light changes from red to yellow to white. Since the color of the emitted light is determined by the temperature of the blackbody, the color of the light emitted by the blackbody can be expressed as the absolute temperature of the blackbody (in Kelvin). This color notation scale is called "color temperature". For example, a 7000 K color would be the color of the light emitted by a blackbody heated to 7000 K. Figure 1 shows the color of light emitted by a blackbody at various temperatures plotted on an xy chromaticity diagram. This curve is called the "blackbody locus"; "color temperature" expresses a color on this blackbody locus.

Correlated color temperature

Since the color of white light emitted by illumination equipment and displays is generally close to the blackbody locus, the color of such light sources is normally expressed using "color temperature".

However, the color of such light sources is not directly on the blackbody locus. Because of this, a way to enable similar color expression for colors within a larger region close to the blackbody locus was devised. This is called "correlated color temperature", and the larger region is shown by the isotherms on the xy chromaticity diagram in Figure 2.

To accurately express the correlated color temperature of a light-source color, it is necessary to state not only the correlated color temperature but the difference from the blackbody locus, normally in terms of Δuv .

*Blackbody

An ideal radiator. A body which completely absorbs all incident electromagnetic radiation. Although a perfect blackbody does not actually exist, coal is a familiar object that acts similarly.

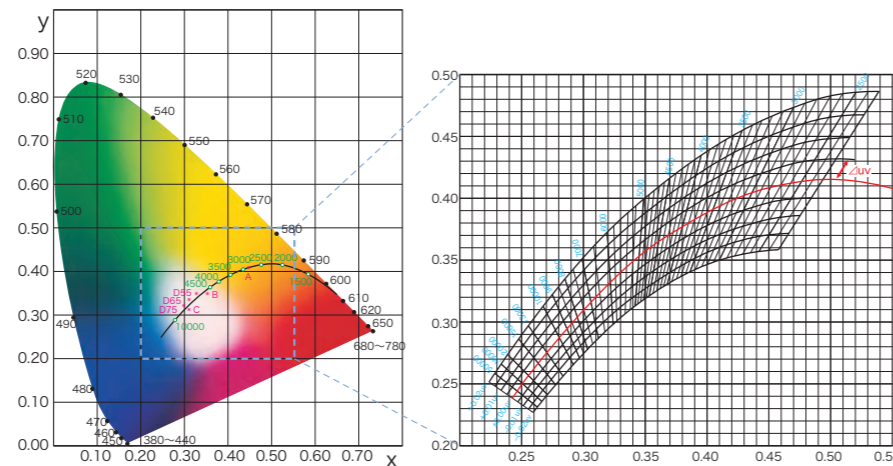
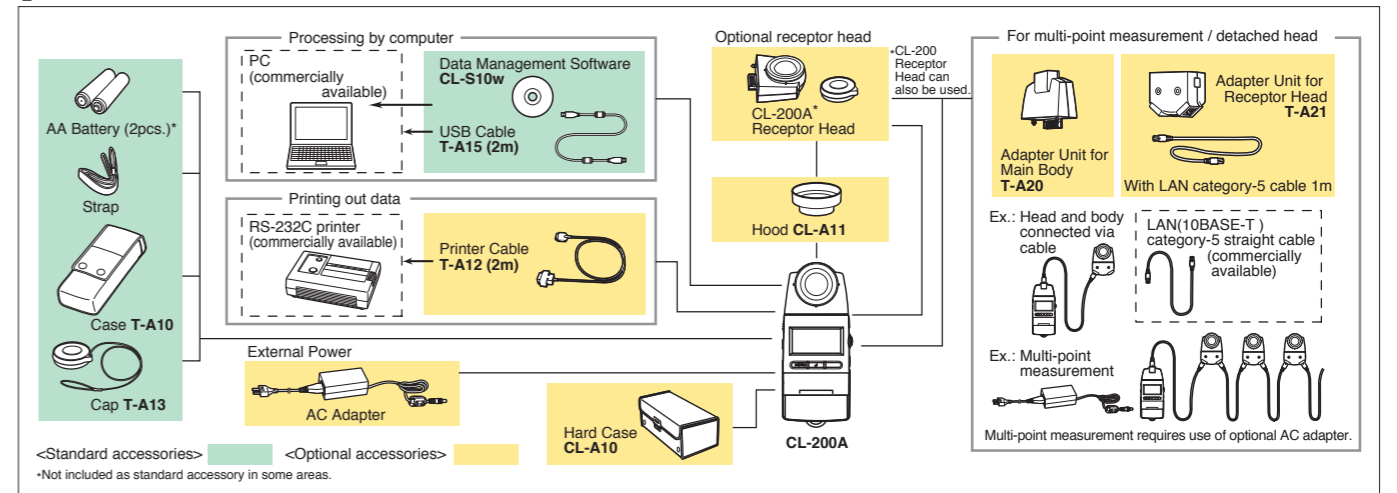

Figure 1: Blackbody locus on xy chromaticity diagram

Figure 2: Closeup of blackbody locus on xy chromaticity diagram showing correlated color temperature region

System diagram



Main specifications of Chroma Meter CL-200A

Model	Chroma Meter CL-200A
Luminance meter class	Conforms to requirements for Class AA of JIS C 1609-1: 2006 "Illuminance meters Part 1: General measuring instruments"
Relative spectral response	Closely matches CIE Standard Observer curves $\bar{x}(\lambda)$, $\bar{y}(\lambda)$, and $\bar{z}(\lambda)$ Within 6% (f ₁) of the CIE spectral luminous efficiency V(λ)
Cosine response (f ₂)	E _y : Within 3%
Receptor	Silicon photocell
Measuring function	Tristimulus values: XYZ Chromaticity: E _x y _y ; E _y u'v'; E _y , Dominant wavelength, Excitation purity Correlated color temperature: E _y T _{cp} Δuv; T _{cp} (JIS method; available only with CL-S10w) Color difference: Δ(XYZ), Δ(E _x y _y), Δ(E _y u'v'), ΔE _y Δu'v'(Target: 1)
Other function	User calibration function, Data hold function, Multi-point measurement (2 to 30 points)
Measuring range	0.1 to 99,990 lx, 0.01 to 9,999 fcd (Chromaticity: 5 lx, 0.5 fcd or above) in four automatically selected ranges (lx or fcd is switchable)
Accuracy*	E _y (Linearity): ±2%±1digit of displayed value xy: ±0.002
Repeatability*	E _y : 0.5%±1digit (2σ), xy: ±0.0005
Temperature drift	E _y : ±3% ±1digit of displayed value, xy: ±0.003
Humidity drift	E _y : ±3% ±1digit of displayed value, xy: ±0.003
Response time	0.5 sec. (continuous measurement)
Computer interface	USB
Printer output	RS-232C
Display	4-significant-digit LCD with back-light illumination
Operating temperature/humidity range	-10 to 40°C, relative humidity 85% or less (at 35°C) with no condensation
Storage temperature/humidity range	-20 to 55°C, relative humidity 85% or less (at 35°C) with no condensation
Power source	2 AA-size batteries / AC adapter AC-308 (optional; for 1 to 10 receptors) or AC adapter AC-311 (optional; for 1 to 30 receptors)
Battery life	72 hours or longer (When alkaline batteries are used) in continuous measurement
Dimensions	69×174×35 mm (2-6/16×6-14/16×1-7/13in.)
Weight	215 g (7.6 oz.) not including batteries

* 800 lx, Standard Illuminant A measured

Dimensions (Units: mm)

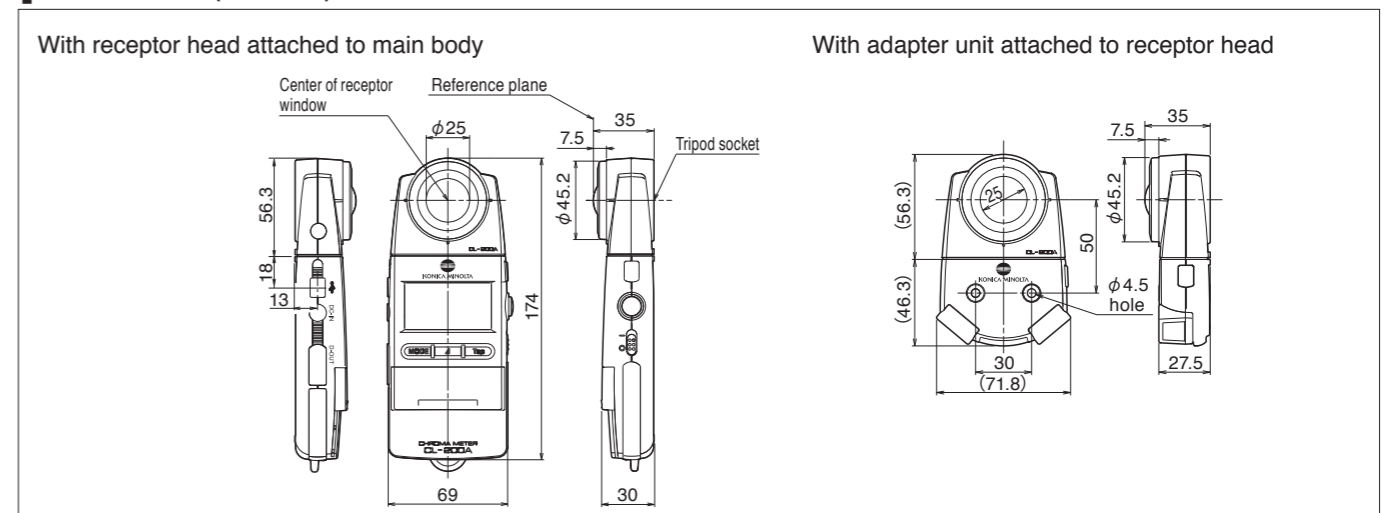

Main specifications of Data Management Software CL-S10w

Type	Add-in for Excel® * Excel is required to use this add-in.
Operating environment	One of the following environments with Excel® installed: Windows® XP Professional 32-bit SP3, 64-bit SP2 + Excel® 2003 (English, Japanese, or Simplified Chinese) Windows® 7 Professional 32-bit, 64-bit + Excel® 2010 (English, Japanese, or Simplified Chinese) * For details on system requirements for above versions of Windows® and/or Excel®, refer to their respective specifications. * Languages in parenthesis () are the OS language. * Not compatible with 64-bit versions of Excel®.
Compatible instruments	CL-200A, CL-200* * Some functions not usable with CL-200.

Illuminance Spectrophotometer CL-500A

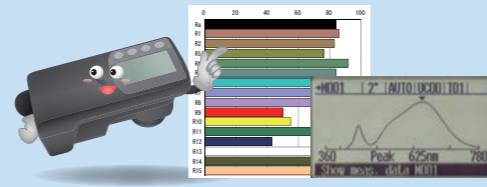

For evaluation of high-class next-generation lamps such as LED illumination and EL illumination

Main Features

Handheld illuminance spectrophotometer conforms to both DIN and JIS standards.

The CL-500A conforms to DIN 5032 Part 7 Class B and JIS C 1609-1:2006 General Class AA, making it the first compact, lightweight, handheld illuminance spectrophotometer to conform to both DIN and JIS standards.

Can be easily mounted on inspection jigs, etc.

The CL-500A is equipped with standard tripod sockets on both the top and bottom surface, so it can be easily mounted on a jig facing either downwards or upwards. In addition, the SDK for the CL-500A can be downloaded free of charge from the Konica Minolta website, making it easy for customers to create their own software.

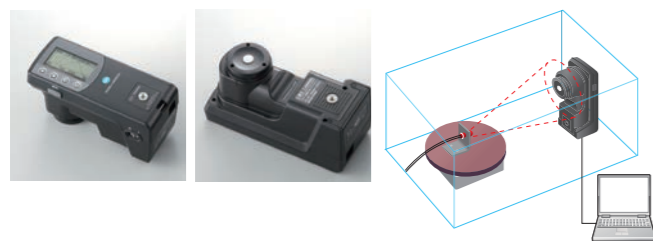

The CL-500A can be a sensor for systems that use an integrating sphere for total flux measurements of light sources and lamps.



Compact, lightweight, handheld

The CL-500A weighs only 350 g, making it easy to take along or to hold in your hand for measurements.



All-in-one type. No PC needed.

The CL-500A can be used by itself for measuring CRI or color temperature of lamps. In addition, the spectral irradiance waveform and peak wavelength can also be checked.

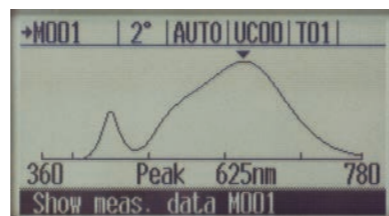

High-speed measurement possible

Using the SDK, high-speed measurements at 5 times/sec. can be taken.

Ø10.5 mm receptor size



Can be operated with USB bus power.

Data Management Software CL-S10w (Standard accessory)

Convenient, easy-to-use Excel® add-in software

Reads measurement data from the CL-500A directly into Excel®. Further processing of data can then be performed easily using the various functions of Excel®.

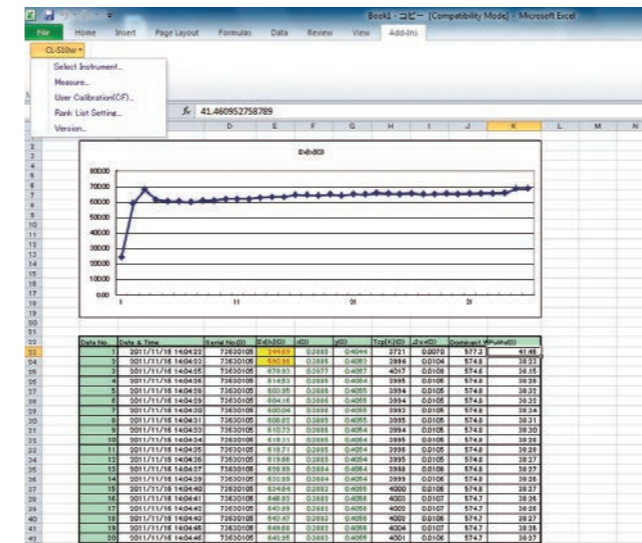

Spectral irradiance waveform display

Since peak wavelengths can be seen easily, classification and grading of light sources can be performed easily at high accuracy. In addition, numerical data at 1 nm can also be viewed in list form.

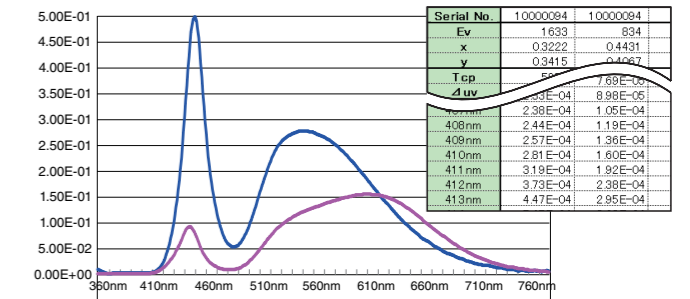

Multi-point measurement possible using multiple CL-500A units

Data Management Software CL-S10w can be used to control up to 10 CL-500A units for multi-point measurements. Using the SDK, this can be further expanded. Please contact our sales person for further information.

Informative color-rendering index display

Color-rendering indexes are shown visually for easy understanding. The shifts between a test light source and a standard light source can be seen at a glance, with bar graphs showing the general color-rendering index Ra (the average of special color-rendering indexes R1 to R8) and the special color-rendering indexes for a total of 15 colors (R1 to R15).

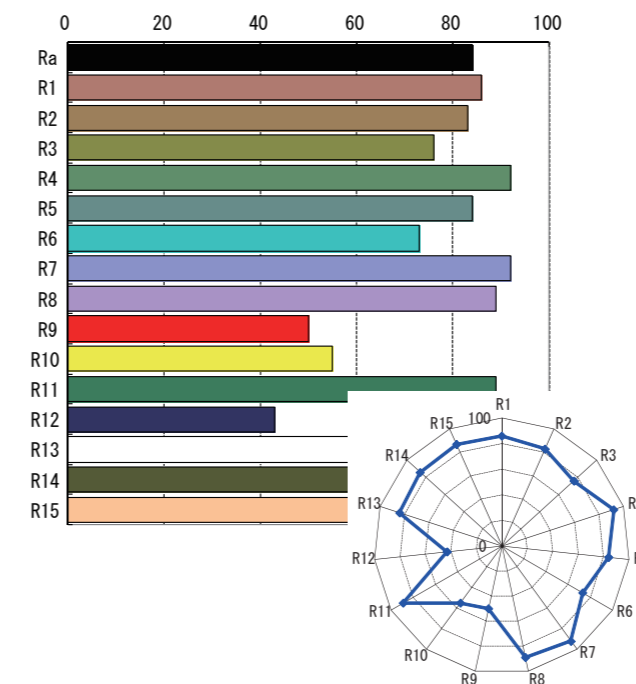

Equipped with LED binning function

In addition to quantifying the color variations which are a major problem in the LED industry, the software is also equipped with function to enable easy binning.

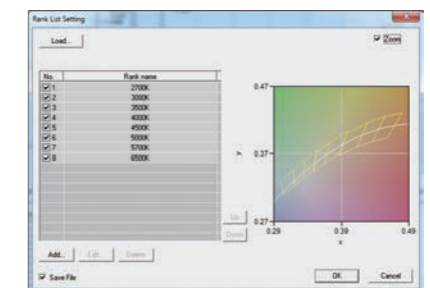
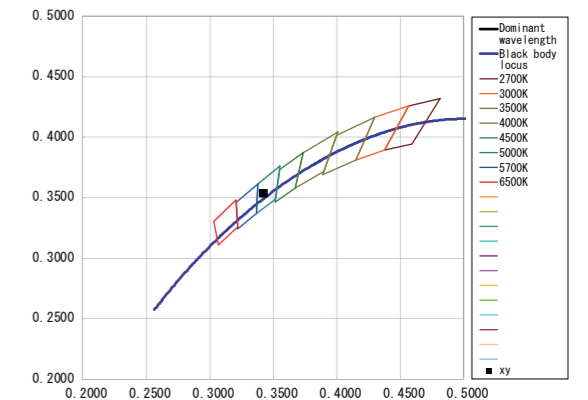

What is color-rendering property?

Since long ago, man has compared colors by arranging objects side-by-side and looking at them under natural light (sunlight). Although torches, candles, incandescent lamps and other light sources are also used for illumination, it has always been the standard practice to compare colors under natural light. In addition to fluorescent lamps, LEDs (light emitting diodes) have recently been adopted as illuminating lamps. When comparing how these new types of lamps make objects look against how natural light makes them look, how closely the appearances match is called the "color-rendering property" of the lamp. A lamp that produces a hue similar to that of natural light is said to have a good (high) color-rendering property. The color-rendering index is a quantification of the color-rendering properties of a lamp or other light source, and was defined to provide objective criteria. The color-rendering index expresses the comparison between the light source being tested and a standard illuminant*. The maximum value is 100, with the value decreasing as the color-rendering difference increases, indicating how far the appearance under the test light source is from the natural color under sunlight.

* Standard illuminant with the same color temperature as the light source being tested. (Light along the blackbody locus corresponds to sunlight.)

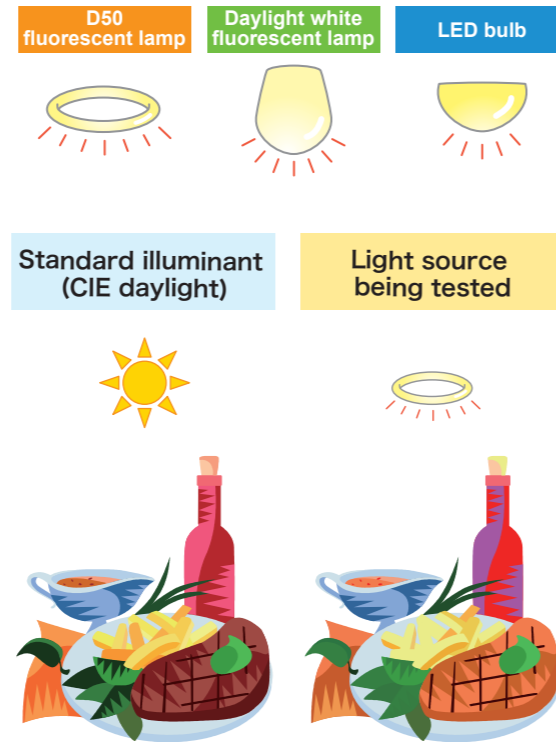

Color-rendering indexes include the general color rendering index (Ra) and special color-rendering indexes (R1 to R15)

Test - color samples

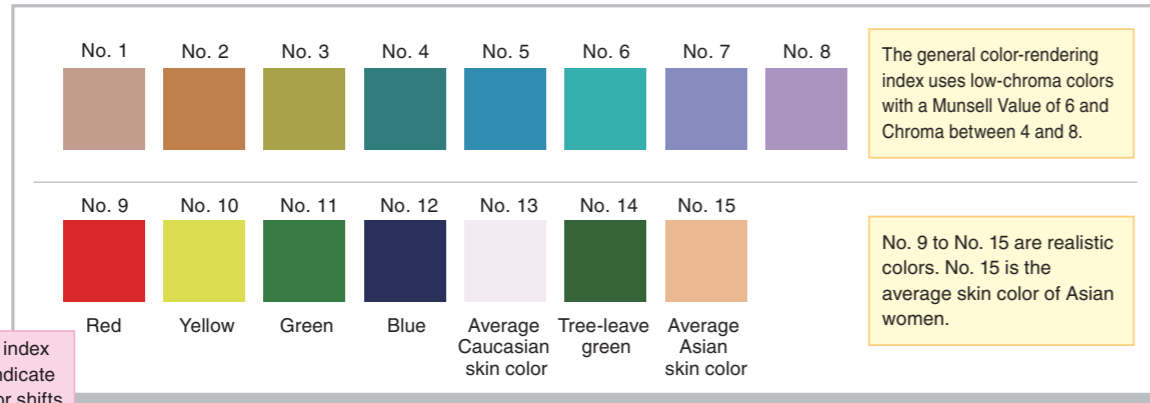

General color-rendering index (Ra)	The average of the color-rendering indexes for test colors No. 1 to 8.
Special color-rendering indexes (Ri)	The individual color-rendering index for test colors No. 1 to 15 (The index for each individual color is evaluated.)

To learn more about the theory and practice of light and color measurement, please visit <http://www.konicaminolta.com/instruments/knowledge/index.html>

Konica Minolta Measurement Fundamentals



System diagram

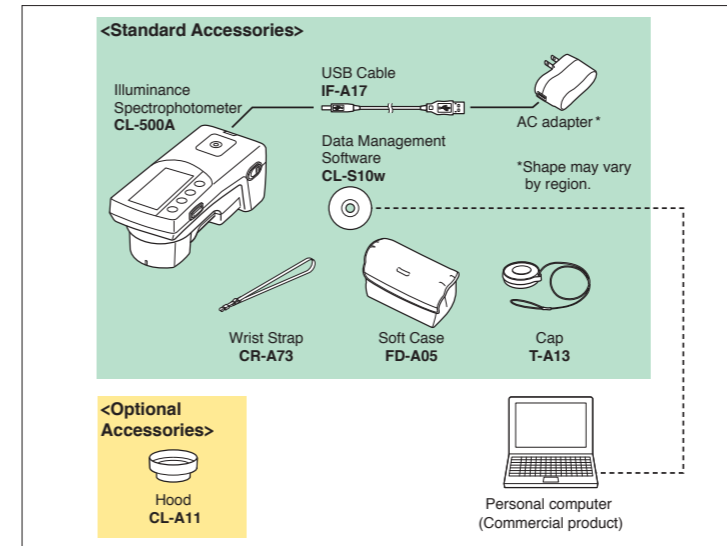

Main Specifications of CL-500A

Model	Illuminance Spectrophotometer CL-500A
Illuminance meter class	Conforms to requirements for Class AA of JIS C 1609-1: 2006 "Illuminance meters Part 1: General measuring instruments" ¹ Conforms to DIN 5032 Part 7 Class B
Spectral wavelength range	360 to 780 nm
Output wavelength pitch	1 nm
Spectral bandwidth	Approx. 10 nm (half bandwidth)
Wavelength precision	±0.3 nm (Median wavelengths of 435.8 nm, 546.1 nm, and 585.3 nm ² as specified in JIS Z 8724) ³
Measuring range	0.1 to 100,000 lx (chromaticity display requires 5 lx or more)
Accuracy ^{4,5} (Standard Illuminant A)	E_v (Illuminance) : ±2%±1 digit of displayed value xy: ±0.0015 (10 to 100,000 lx) xy: ±0.002 (5 to 10 lx)
Repeatability (2σ) ⁴ (Standard Illuminant A)	E_v : 0.5%±1 digit xy: 0.0005 (500 to 100,000 lx) xy: 0.001 (100 to 500 lx) xy: 0.002 (30 to 100 lx) xy: 0.004 (5 to 30 lx)
Visible-region relative spectral response characteristics (f_v)	Within 1.5% of spectral luminous efficiency $V(\lambda)$
Cosine response (f_c)	E_v : Within 3%
Temperature drift (f_T)	E_v : ±3% of displayed value; xy: ±0.003
Humidity drift (f_H)	E_v : ±3% of displayed value; xy: ±0.003
Measurement time	Super Fast mode: Approx. 0.2 sec. (when connected to computer); Fast mode: Approx. 0.5 sec.; Slow mode: Approx. 2.5 sec.; Automatic exposure time setting (high accuracy) mode: Approx. 0.5 to 27 sec.
Display modes	XYZ; $X_{10}Y_{10}Z_{10}$; E_v, xy ; E_v, u^*v^* ; E_v ; Dominant wavelength, Excitation purity; Correlated color temperature, Δuv ; General color-rendering index (Ra); Special color-rendering indexes (Ri (i=1~15)); Spectral graph; Peak wavelength; Δ (XYZ); Δ ($X_{10}Y_{10}Z_{10}$); Δ (E_v, xy); Δ (E_v, u^*v^*); Rank display
Other functions	Data memory: 100 data; User calibration function (when connected to computer); Continuous measurement (when connected to computer); Auto power off function
Display languages	English, Japanese, Chinese (Simplified)
Interface	USB 2.0
Power	Rechargeable internal lithium-ion battery (Operating time per charge: Approx. 6 hours when new); AC adapter; USB power bus
Operating temperature/humidity range	-10 to 40°C, relative humidity of 85% or less (at 35°C) with no condensation
Storage temperature/humidity range	-10 to 45°C, relative humidity of 85% or less (at 35°C) with no condensation
Dimensions (W × D × H)	70 × 165 × 83 mm
Weight	350 g

¹ For Section 7.6.3 Response Time, when measurement speed mode is set to FAST mode.

² For 585.3 nm, evaluation performed using substitute wavelength of 587.5 nm.

³ Based on Konica Minolta test standards (change in temperature of 2°C or less after zero calibration.)

⁴ Automatic exposure time setting (high accuracy) mode

⁵ Linear for E_v (Illuminance)

Dimensions (Units: mm)

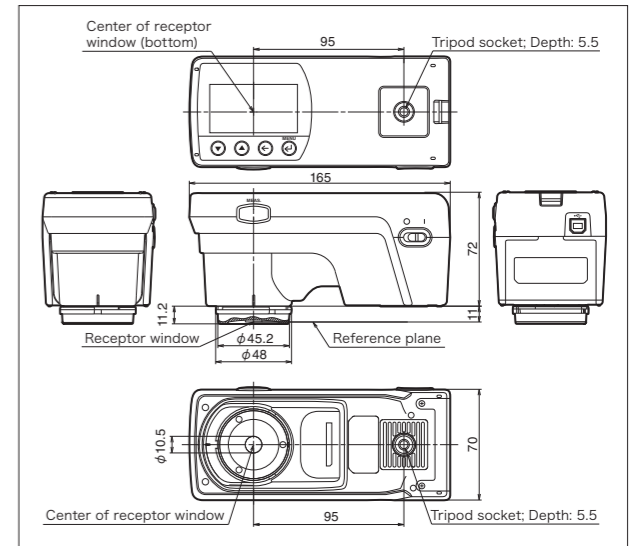

Main specifications of Data Management Software CL-S10w

Type	Add-in for Excel® (Excel® is required to use this add-in.)
Operating environment	One of the following environments with Excel® installed: * Languages in parenthesis () are the OS language. Windows® XP Professional 32-bit SP3, 64-bit SP2 + Excel® 2003 (English, Japanese, or Simplified Chinese) Windows® 7 Professional 32-bit, 64-bit + Excel® 2010 (English, Japanese, or Simplified Chinese) * For details on system requirements for above versions of Windows® and/or Excel®, refer to their respective specifications. * Not compatible with 64-bit versions of Excel®.
Compatible instruments	CL-500A, CL-200A, CL-200
Display items	Spectral irradiance (W/m ² /nm); general color-rendering index Ra, correlated color temperature, etc.

Luminance Meters

LS-100/LS-110

Compact, lightweight, easy-to-use SLR luminance meters with a wide measuring range

Luminance Meter LS-100

1° acceptance angle,
Measuring range: 0.001 to 299,900 cd/m²
(0.001 to 87,530 fL)

Luminance Meter LS-110

1/3° acceptance angle,
Measuring range: 0.01 to 999,900 cd/m²
(0.01 to 291,800 fL)

Main Features

Flareless SLR optical system for accurate measurements

The SLR (single-lens-reflex) optical system allows precise aiming and ensures that the viewfinder shows the exact area to be measured. The optical system is also virtually flareless, eliminating the influence of light from outside the measurement area.

Narrow acceptance angle for measurements of small specimens

Acceptance angles of only 1° for **LS-100** and 1/3° for **LS-110** allow accurate measurements of small specimen areas. In addition, optional close-up lenses can be used to measure areas as small as ø1.3 mm when using **LS-100** and ø0.4 mm when using **LS-110**.

User calibration and color-correction functions

To increase the versatility of the **LS-100** and **LS-110**, both models are equipped with user calibration and color correction functions. The user calibration function allows the meter to be calibrated to a user-selected standard instead of the preset Konica Minolta standard; this function can also be used to standardize the response of several meters. The color correction function allows the response of the meter to be adjusted when measuring colored specimens.

Luminance ratio and peak luminance measurements

In addition to measurements of the present luminance, the **LS-100** and **LS-110** can also determine the percent ratio of the measured luminance to a luminance value stored in memory as well as the peak luminance or luminance ratio measured.

RS-232C data communication

Use of the built-in RS-232C interface allows the meter to be connected to a personal computer.

Lightweight, compact design powered by a single 9V battery for portability



LS-100

Relative Spectral Response

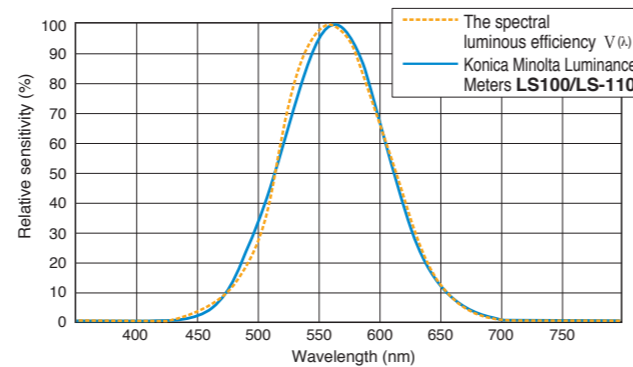

Ideally, the relative spectral responsivity of the luminance meter should match $V(\lambda)$ of the human eye for photopic vision. As shown in the graph above, the relative spectral responsivity of Konica Minolta Luminance Meters **LS-100/LS-110** is close to the CIE spectral luminous efficiency $V(\lambda)$.
CIE: Commission Internationale de l'Éclairage
 f_1 : (CIE «s» symbol); The degree to which the relative spectral responsivity matches $V(\lambda)$ is characterized by means of the error f_1 .

Reduction of Flare

The degree to which the influence of light from outside the defined measuring area is eliminated is an important factor in the performance of luminance meters. In Konica Minolta Luminance Meters, the flare factor is kept to below 1.5%, even if an object with extremely high luminance is just outside the meter's measuring area.

The graph at right shows the effect when a bright point is moved from A inside the measuring area to B just outside the measuring area. If the measured value at A is defined at 100%, the measured value at B would be less than 0.1%.

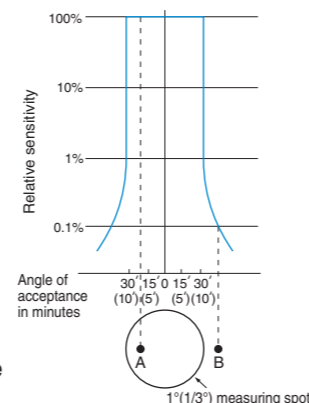

Specifications

Model	Luminance Meter LS-100	Luminance Meter LS-110
Type	SLR spot luminance meter for measuring light-source and surface brightness	
Measuring angle	1°	1/3°
Optical system	85 mm f/2.8 lens; SLR viewing system; flare factor less than 1.5%	
Angle of view	9°	
Focusing distance	1014 mm (40 in.) to infinity	
Minimum measuring area	ø14.4 mm	ø4.8 mm
Receptor	Silicon photocell	
Response time	FAST: Sampling time: 0.1s, time to display: 0.8 to 1.0s; SLOW: Sampling time: 0.4s, time to display: 1.4 to 1.6s	
Luminance units	cd/m ² or fL (switchable)	
Measuring range	FAST : 0.001 to 299,900 cd/m ² (0.001 to 87,530fL) SLOW : 0.001 to 49,990 cd/m ² (0.001 to 14,590fL)	FAST : 0.01 to 999,900 cd/m ² (0.01 to 291,800 fL) SLOW : 0.01 to 499,900 cd/m ² (0.01 to 145,900 fL)
Accuracy ^{*1}	0.001 to 0.999 cd/m ² (or fL): ±2% ±2 digits of displayed value 1.000 cd/m ² (or fL) or greater: ±2% ±1 digit of displayed value	0.01 to 9.99 cd/m ² (or fL): ±2% ±2 digits of displayed value 10.00 cd/m ² (or fL) or greater: ±2% ±1 digit of displayed value
Repeatability ^{*2}	0.001 to 0.999 cd/m ² (or fL): ±0.2% ±2 digits of displayed value 1.000 cd/m ² (or fL) or greater: ±0.2% ±1 digit of displayed value	0.01 to 9.99 cd/m ² (or fL): ±0.2% ±2 digits of displayed value 10.00 cd/m ² (or fL) or greater: ±0.2% ±1 digit of displayed value
Temperature/humidity drift	Within ±3% ±1 digit (of value displayed at 20°C/68°F) within operating temperature/humidity range	
Calibration mode	Minolta standard/user-selected standard (switchable)	
Color correction factor	Set by numerical input; range: 0.001 to 9.999	
Reference luminance	1; set by measurement or numerical input	
Measurement modes	Luminance; luminance ratio; peak luminance or luminance ratio	
Display	External: 4-digit LCD with additional indications Viewfinder: 4-digit LCD with LED backlight	
Data communication	RS-232C; baud rate: 4800 bps	
External control	Measurement process can be started by external device connected to data output terminal	
Power source	One 9 V battery; power can also be supplied by optional Data Printer DP-10	
Power consumption	While measuring button is pressed and viewfinder display is lit: 16 mA average While power is on and viewfinder display is not lit: 6 mA average	
Operating temperature/humidity range	0 to 40°C, relative humidity 85% or less (at 35°C) with no condensation	
Storage temperature /humidity range	-20 to 55°C, relative humidity 85% or less (at 35°C) with no condensation	
Dimensions	79x208x150 mm (3-1/8x8-3/16x5-7/8 in.)	
Weight	850 g (30 oz.) without battery	
Standard accessories	Lens cap; Eyepiece cap; ND eyepiece filter; 9 V battery; Case	

*1 Standard Illuminant A measured at ambient temperature of 20 to 30°C
*2 Standard Illuminant A

Optional Accessories

System diagram (Optional Accessories)

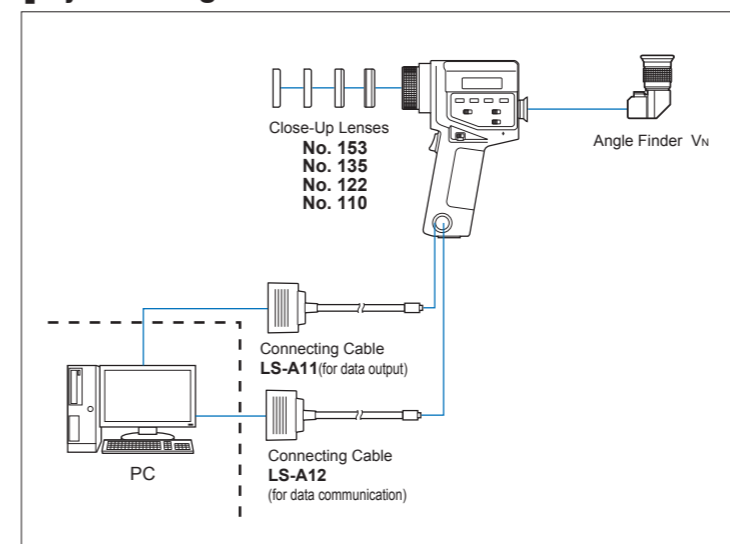

Close-Up Lenses



	Minimum measuring area	
Close-Up Lenses	With LS-100	With LS-110
No.153	ø8.0 mm	ø2.7 mm
No.135	ø5.2 mm	ø1.8 mm
No.122	ø3.2 mm	ø1.1 mm
No.110	ø1.3 mm	ø0.4 mm

(Theoretical values)

Angle Finder Vn



Angle Finder V_N allows the measuring area and measurement display inside the viewfinder to be seen at an angle of 90° to the normal viewfinder optical axis. Angle Finder V_N can also be focused and the magnification can be set to 1x or 2x.

Chroma Meter CS-100A

A compact, lightweight, battery-powered instrument with a 1° measurement angle for high-accuracy non-contact measurements of luminance and chromaticity



Easy-To-Read Display

Viewfinder Image

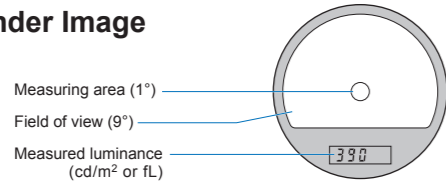

External display

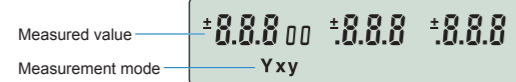

Main Features

Compact and lightweight

Measurements of subjects at a distance

SLR (single-lens-reflex) viewing system and flare-free optical system provide accurate measurements of subjects at a distance with virtually no influence from light outside the measurement area.

Measurements of small subjects

1° measurement angle allows measurements of subjects as small as ø14.4 mm (at a subject distance of 1014 mm); by using optional Close-Up Lenses, subjects as small as ø1.3 mm can be measured.

Luminance units of cd/m² or fL can be selected

Main Applications

Light-Source Measurements

- Luminance and chromaticity of small light sources such as LEDs, miniature neon lamps, etc.
- Luminance and chromaticity of general light sources such as tungsten lamps, fluorescent lamps, etc.
- Luminance and chromaticity of traffic signals, airport guidance lights, emergency exit signs, etc.

Reflective-Subject Measurements

- Color measurements of subjects which cannot be measured by contact methods, such as distant building walls, just-painted surfaces.

Display Measurements

- Luminance and chromaticity of projectors.



Specification

Model	Chroma Meter CS-100A
Type	SLR spot colorimeter for measuring light-source and surface luminance and chromaticity
Measuring angle	1°
Optical system	85 mm f/2.8 lens; SLR viewing system; flare factor less than 1.5%
Angle of view	9° with 1° measurement area indication
Focusing distance	1014 mm (40 in.) to infinity
Receptors	3 silicon photocells filtered to detect primary stimulus values for red, green and blue light
Spectral response	Closely matches CIE 1931 Standard Observer curves ($\bar{x}_c, \bar{y}_c, \bar{z}_c$)
Response time	Switchable; FAST: Sampling time: 0.1s, Time to display: 0.8 to 1.0s SLOW: Sampling time: 0.4s, Time to display: 1.4 to 1.6s
Luminance units	cd/m ² or fL (switchable)
Measuring range*1	FAST: 0.01 to 299,000 cd/m ² (0.01 to 87,530 fL) SLOW: 0.01 to 49,900 cd/m ² (0.01 to 14,500 fL)
Accuracy*2	Luminance (Y): ±2% of reading ±1 digit Chromaticity (x,y): FAST: 48.1 cd/m ² or above: ±0.004; below 48.1 cd/m ² : below measurement range SLOW: 12.0 cd/m ² or above: ±0.004; below 12.0 cd/m ² : below measurement range
Repeatability*1	Luminance (Y): ±0.2% of reading ±1 digit Chromaticity (x,y): FAST: 100 cd/m ² or above: ±0.001; 48.1 to 99.9 cd/m ² : ±0.002; below 48.1 cd/m ² : below measurement range SLOW: 25.0 cd/m ² or above: ±0.001; 12.0 to 24.9 cd/m ² : ±0.002; below 12.0 cd/m ² : below measurement range
Target value	1; set by measurement or numerical input
Measurement modes	Absolute color: Yxy; color difference: Δ (Yxy)
Display	External: LCD; 3 values (Y, x, and y) of 3 digits each with additional indications Viewfinder: 3-digit LCD (showing luminance value Y) with LED backlight
Data communication	RS-232C; baud rate: 4800 bps
External control	Measurement process can be started by external device connected to data output terminal
Power source	One 9 V battery; power can also be supplied via data output terminal
Operating temperature/humidity range	0 to 40°C, relative humidity 85% or less (at 35°C) with no condensation
Storage temperature /humidity range	-20 to 55°C, relative humidity 85% or less (at 35°C) with no condensation
Dimensions	79x208x154 mm (3-1/8x8-3/16x6-1/16 in.)
Weight	890 g (2 lb.) without battery
Standard accessories	Lens cap; Eyepiece cap; Protective filter, ND eyepiece filter; 9V battery; Chromaticity chart; Case

*1 Standard Illuminant A

*2 Standard Illuminant A measured at ambient temperature of 20 to 30°C

Optional Accessories

System diagram (Optional Accessories)

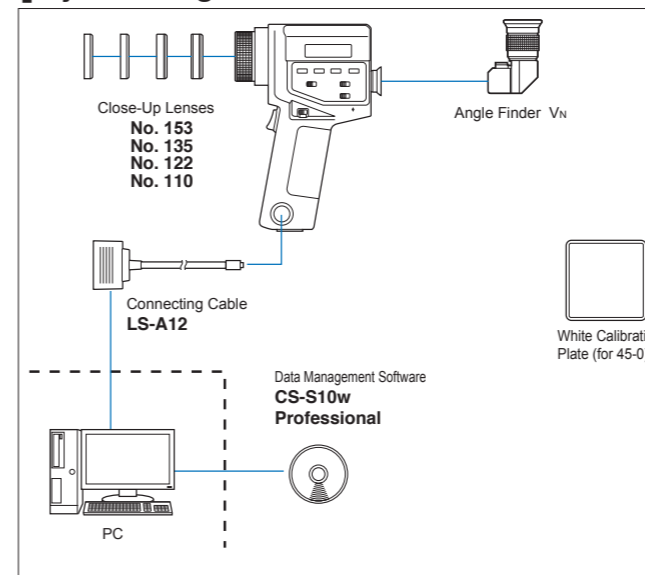

Dimensions (Units: mm)

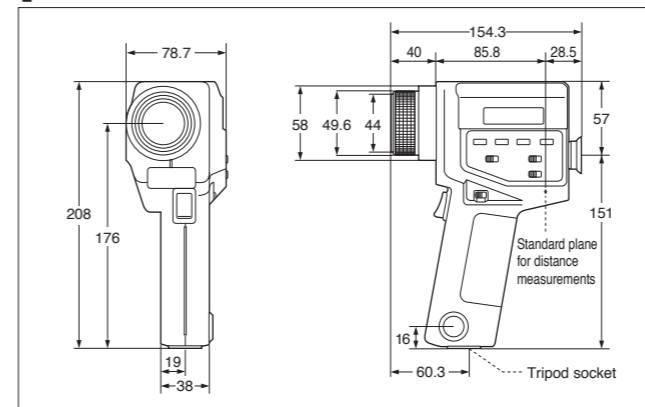

Close-Up Lenses



Close-Up Lenses	Minimum measuring area
No.153	ø8.0 mm
No.135	ø5.2 mm
No.122	ø3.2 mm
No.110	ø1.3 mm

(Theoretical values)

Angle Finder Vn



Angle Finder Vn allows the measuring area and measurement display inside the viewfinder to be seen at an angle of 90° to the normal viewfinder optical axis. Angle Finder Vn can also be focused and the magnification can be set to 1x or 2x.

Data Management Software CS-S10w Professional (Optional accessory)

- Color space**: L_v x y, L_v u' v', L_vT Δuv, XYZ, dominant wavelength
- Mode selection**: Normal mode, Object color mode, Contrast mode, RGB mode, RGB & contrast mode
- Instrument control**: Average measurement, Interval measurement
- Data management**: Reading and saving files, Data management with folders, Creating, saving and loading templates (customizable design/layouts for various graphs), Various graph displays
- Data evaluation**: Statistics display for each folder, Box tolerance setting, Multiple-point measurement, uniformity display, contrast display and polygon tolerance setting for display evaluation
- Other**: Creating reports in customizable screen layouts

System requirements

- OS**: Windows® XP Professional 32-bit SP3, 64-bit SP2, Windows® Vista Business 32-bit, 64-bit, Windows® 7 Professional 32-bit, 64-bit
- CPU**: Pentium® III 600 MHz equivalent or higher
- Memory**: 128 MB min. (256 MB or more recommended)
- Hard disk**: 60 MB or more space required for installation
- Display**: 1024 X 768, 256 colors or more
- Other**: CD-ROM drive, USB port

Chroma Meter CS-200

Accurate measurement Comparable to Spectroradiometers

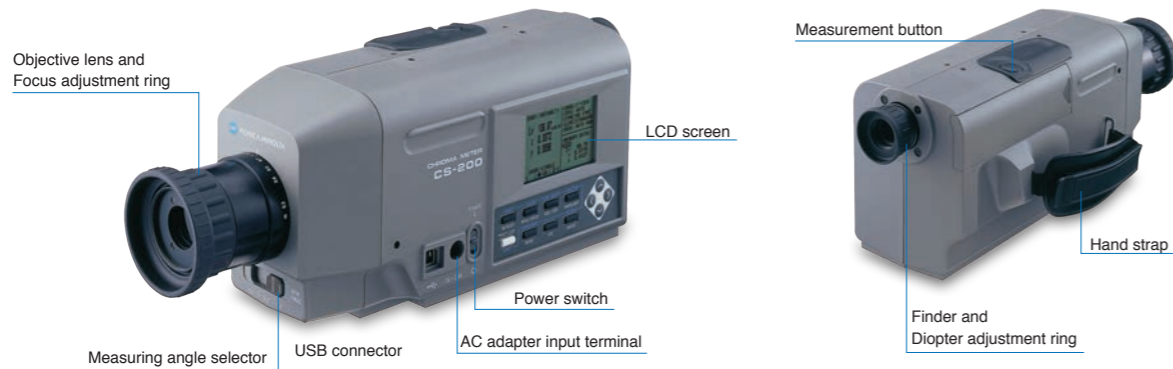

Main Features

Perfect match of the spectral response to the CIE color-matching functions

Konica Minolta's newly-developed spectral fitting method provides tristimulus values (XYZ = red, green, blue) with significantly higher accuracy than that of conventional tristimulus colorimeters. This is achieved by using the output from 40 sensors to calculate the spectral response corresponding to human eye sensitivity (CIE 1931 color-matching functions). The CS-200 uses 40 sensors for sensitivity covering the entire visible region and multiplies each sensor output by appropriate coefficients. This adjusts the spectral response of the instrument to close to the CIE 1931 color-matching functions. In addition to the 2° Standard Observer, the 10° Standard Observer (for object-color measurements) can also be selected, which is impossible with conventional tristimulus colorimeters.

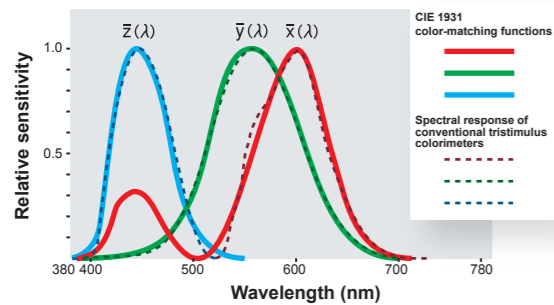

CIE 1931 color-matching functions and spectral response of a conventional tristimulus colorimeter

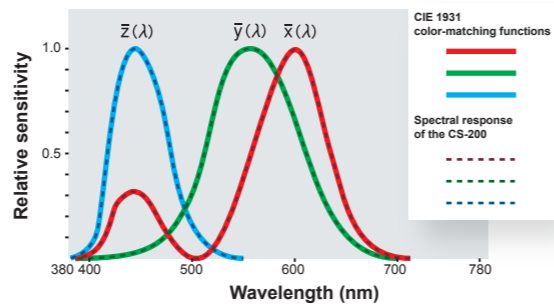

CIE 1931 color-matching functions and spectral response of the CS-200

Compact and lightweight. Battery power is also possible.

The compact, lightweight and stylish body allows hand-held operation. The CS-200 can be operated with either four AA batteries (battery indicator function provided) or a special AC adapter.

Selectable measuring angle

While checking the actual subject, you can select the measuring angle easily according to the application (1°, 0.2° and 0.1°). The aperture mirror eliminates misalignment between the finder target and the actual measuring spot, ensuring accurate aiming.

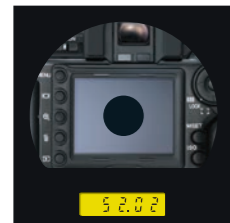

1° aperture
For measurement of general-size areas such as medium and large displays

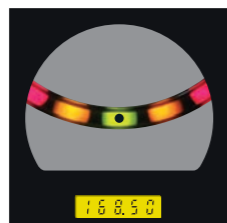

0.2° aperture
For measurement of small areas such as product LEDs

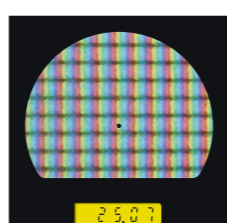

0.1° aperture
For measurement of very small areas or of a distant light source

Measuring distance and measuring area

(Unit: mm)

(Measuring angle)	Minimum measuring area			Maximum measuring area			Minimum measuring distance			Maximum measuring distance			Measuring area at 500 mm			Measuring area at 1000 mm		
	1°	0.2°	0.1°	1°	0.2°	0.1°	1°	0.2°	0.1°	1°	0.2°	0.1°	1°	0.2°	0.1°	1°	0.2°	0.1°
Without a Close-Up Lens	4.7	1.0	0.5	∞	∞	∞	∞	∞	∞	∞	∞	∞	∞	∞	∞	∞	∞	∞
Close-up lens No. 122	2.2	0.5	0.3	4.6	1.0	0.5	128	∞	240	∞	∞	∞	∞	∞	∞	∞	∞	∞
Close-up lens No. 107	0.8	0.2	0.1	1.1	0.3	0.2	43	∞	52	∞	∞	∞	∞	∞	∞	∞	∞	∞

* Measuring distance is the distance from the front edge of the metal lens barrel or close-up lens ring.

Data Management Software CS-S10w Standard (Standard accessory)

CS-S10w Standard Edition allows users to control the CS-200 with a PC to display the list of measured data or to transfer the data to spreadsheet software.

<Functions common to Standard and Professional Editions>

Color space : L_vxy , $L_vu'v'$, $L_vT\Delta uv$, XYZ, dominant wavelength
Mode selection : Normal mode
 Object color mode
Instrument control : Average measurement
 Interval measurement
 User calibration

Data management : Reading and saving files
 Data management with folders
Data evaluation : Observer/Illuminant settings
 Statistics display for each folder
 Box tolerance setting

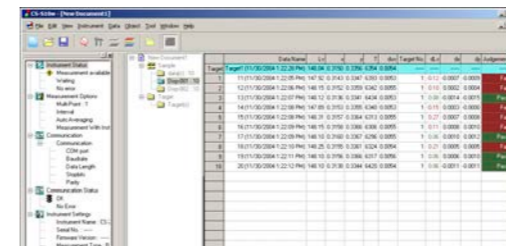

List display (Standard Edition)

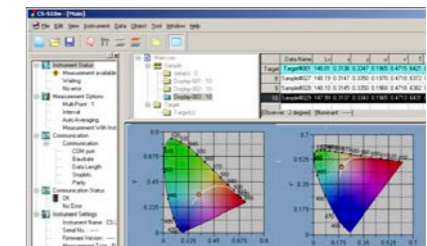

xy and UV chromaticity diagrams (Professional Edition)

Specification

Model	Chroma Meter CS-200		
Measurement range	0.01 - 200,000cd/m ² (Measuring angle 1°)		
	0.01 - 5,000,000cd/m ² (Measuring angle 0.2°)		
	0.01 - 20,000,000cd/m ² (Measuring angle 0.1°)		
	Accuracy	150 cd/m ² $L_v \pm 2\% \pm 1$ digit	$xy \pm 0.002$
(Measuring angle 1°)*1	0.01-0.5 cd/m ²	$L_v \pm 0.02$ cd/m ² ± 1 digit	---
	(Standard Illuminant A; 0.5-1 cd/m ²)	$L_v \pm 0.02$ cd/m ² ± 1 digit	$xy \pm 0.007$
	Temperature: 23°C±2°C, Relative humidity: 65% max.)	1-10 cd/m ² $L_v \pm 2\% \pm 1$ digit	$xy \pm 0.004$
	10-200,000 cd/m ²	$L_v \pm 2\% \pm 1$ digit	$xy \pm 0.003$
Repeatability (Measuring angle 1°)*2 (Standard Illuminant A)	0.01-1 cd/m ²	L_v 0.01 cd/m ² ± 1 digit	---
	1-2 cd/m ²	L_v 0.5% ± 1 digit	xy 0.002 (2 σ /AUTO)
	2-4 cd/m ²	L_v 0.5% ± 1 digit	xy 0.001 (2 σ /AUTO)
	4-8 cd/m ²	L_v 0.5% ± 1 digit	xy 0.0005 (2 σ /AUTO)
Measurement time	8-200,000 cd/m ²	L_v 0.1% ± 1 digit	xy 0.0004 (2 σ /AUTO)
	AUTO (Automatically set between approx. 1s and 60s)		
Measurement method	LTD.AUTO (Automatically set to approx. 1s or 3s)		
	Super-FAST (approx. 0.5 sec/meas.)	FAST (approx. 1 sec/meas.)	
	SLOW (approx. 3 sec/meas.)	Super-SLOW (approx. 12 sec/meas.)	
	Spectral method, Grating + linear photo diode array		
Measuring angle	1°, 0.2°, 0.1° (switchable)		
Minimum measuring area	0.5 mm		
Minimum measuring distance	0.1 mm (close up lens)		
Observer	2/10 degrees		
Color space	L_vxy , $L_vu'v'$, $L_vT\Delta uv$, XYZ, dominant wavelength		
Measurement synchronization setting range	Vertical synchronization frequency : 40.00 to 200.00 Hz		
Interface	USB 1.1		
Power source	AC adapter or 4 AA-Size Batteries		
Battery life	Approx. 3 hours (continuous measurement / Fast mode / AA-size alkaline cells)		
Size	95 mm (W) x 127 mm (H) x 334 mm (L)		
Weight	1.8 kg (without battery)		
Operating temperature/humidity range	0°C to 40°C, relative humidity 85% or less (at 35°C) with no condensation		
Storage temperature/humidity range	0°C to 45°C, relative humidity 85% or less (at 35°C) with no condensation		

*1 23°C ±2°C $L_v = 0.01-10$ cd/m² SLOW, average of 30 measurements $L_v = 10$ cd/m² and higher, SLOW, average of 10 measurements
 *2 At 0.2° measuring angle, the amount of received light is approx. 1/25 of that for 1°. Therefore, the repeatability becomes the same as that for 1° with 25 times lower luminance.
 At 0.1° measuring angle, the amount of received light is approx. 1/100 of that for 1°. Therefore, the repeatability becomes the same as that for 1° with 100 times lower luminance.

System diagram

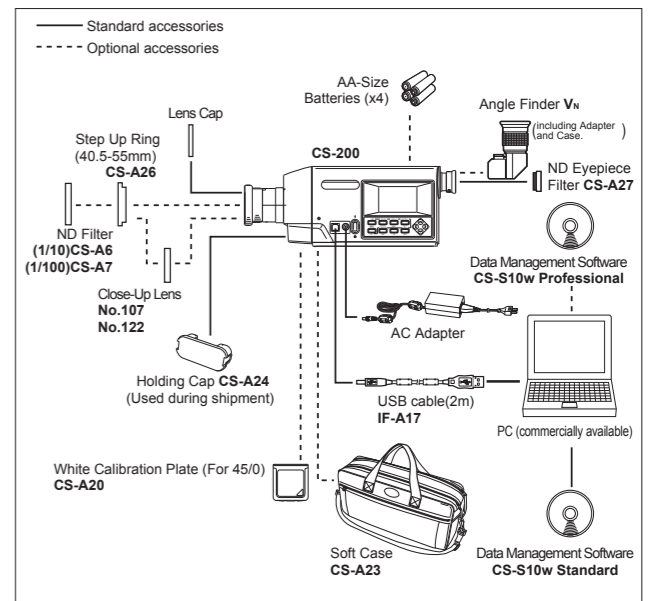

Dimensions (Units: mm)

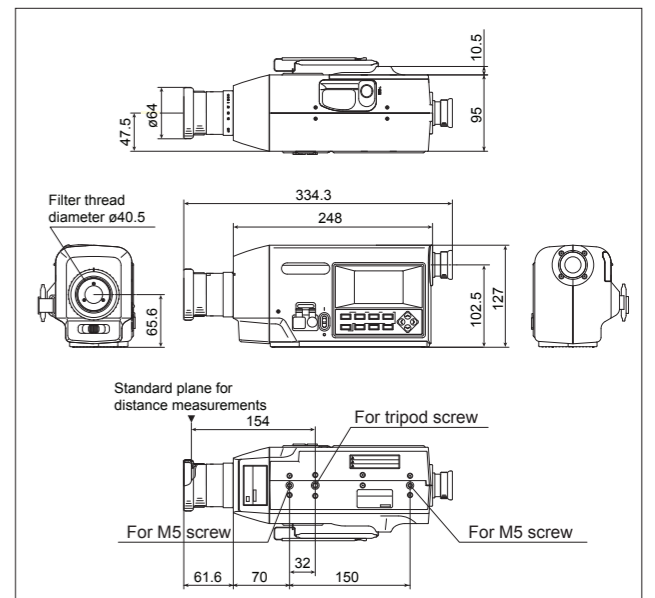



KONICA MINOLTA

SAFETY PRECAUTIONS

For correct use and for your safety, be sure to read the instruction manual before using the instrument.



- Always connect the instrument to the specified power supply voltage. Improper connection may cause a fire or electric shock.
- Be sure to use the specified batteries. Using improper batteries may cause a fire or electric shock.

- KONICA MINOLTA and the Konica Minolta logo and the symbol mark, and "Giving Shape to Ideas" are registered trademarks or trademarks of KONICA MINOLTA, INC.
- Windows® and Excel® are trademarks of Microsoft Corporation in the USA and other countries.
- Pentium® is a trademarks of Intel Corporation in the USA and other countries.
- The specifications and drawings given here are subject to change without prior notice.
- Some lamp control methods may make accurate measurements difficult. For details, please contact your nearest Konica Minolta sales office or dealer.



Certificate No : LRQ 0960094/A
Registration Date : March 3, 1995



Certificate No : JQA-E-80027
Registration Date : March 12, 1997

KONICA MINOLTA, INC.
Konica Minolta Sensing Americas, Inc.
Konica Minolta Sensing Europe B.V.

Osaka, Japan
New Jersey, U.S.A.
European Headquarter /BENELUX
German Office
French Office
UK Office
Italian Office
Swiss Office
Nordic Office
Polish Office
SE Sales Division
Beijing Office
Guangzhou Office
Chongqing Office
Qingdao Office
Wuhan Office

Phone : 888-473-2656 (in USA), 201-236-4300 (outside USA)
Nieuwegein, Netherlands **Phone** : +31 (0)30 248-1193
München, Germany **Phone** : +49(0)89 4357 156 0
Roissy CDG, France **Phone** : +33(0)1 80 11 10 70
Warrington, United Kingdom **Phone** : +44(0)1925 467300
Cinisello Balsamo, Italy **Phone** : +39 02849488.00
Dietikon, Switzerland **Phone** : +41 (0)43 322-9800
Västra Frölunda, Sweden **Phone** : +46(0)31 7099464
Wroclaw, Poland **Phone** : +48(0)71 33050-01
Shanghai, China **Phone** : +86- (0)21-5489 0202
Beijing, China **Phone** : +86- (0)10-8522 1551
Guangdong, China **Phone** : +86- (0)20-3826 4220
Chongqing, China **Phone** : +86- (0)23-6773 4988
Shandong, China **Phone** : +86- (0)532-8079 1871
Hubei, China **Phone** : +86- (0)27-8544 9942
Singapore **Phone** : +65 6563-5533
Seoul, Korea **Phone** : +82(0)2-523-9726
Bangkok, Thailand **Phone** : +66-2361-3730

Fax : 201-785-2482
Fax : +31 (0) 30 248-1280
Fax : +49(0)89 4357 156 99
Fax : +33(0)1 80 11 10 82
Fax : +86- (0)20-3826 4223
Fax : +39 02849488.30
Fax : +41 (0)43 322-9809
Fax : +48 (0)71 734 52 10
Fax : +86- (0)21-5489 0005
Fax : +86- (0)10-8522 1241
Fax : +86- (0)20-3826 4223
Fax : +86- (0)23-6773 4799
Fax : +86- (0)532-8079 1873
Fax : +86- (0)27-8544 9991
Fax : +65 6560-9721
Fax : +82(0)2-523-9729
Fax : +66-2361-3771

Konica Minolta (CHINA) Investment Ltd.

Konica Minolta Sensing Singapore Pte Ltd.
Konica Minolta, Inc.
Konica Minolta, Inc.

Optics Company, Korea
Optics Company, Sensing Business
Thailand Representative Office

Addresses and telephone/fax numbers are subject to change without notice. For the latest contact information, please refer to the KONICA MINOLTA Worldwide Offices web page :

<http://konicaminolta.com/instruments/network>

Free Manuals Download Website

<http://myh66.com>

<http://usermanuals.us>

<http://www.somanuals.com>

<http://www.4manuals.cc>

<http://www.manual-lib.com>

<http://www.404manual.com>

<http://www.luxmanual.com>

<http://aubethermostatmanual.com>

Golf course search by state

<http://golfingnear.com>

Email search by domain

<http://emailbydomain.com>

Auto manuals search

<http://auto.somanuals.com>

TV manuals search

<http://tv.somanuals.com>