

KROME

MUSIC WORKSTATION

Operation Guide

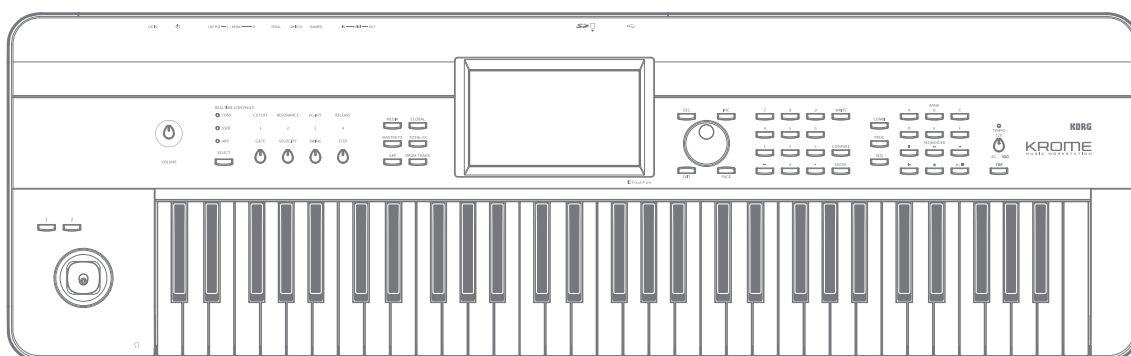

EDS-X Enhanced Definition
Synthesis - eXpanded

GENERAL
MIDI

REMS

KORG

Ⓔ ④

Thank you for purchasing the Korg KROME Music Workstation. To help you get the most out of your new instrument, please read this manual carefully.

About this manual

The manuals and how to use them

The KROME comes with the following manuals.

- Video Manual (approximately 60 minutes)
- Quick Start Guide (printed and PDF)
- Operation Guide (PDF)
- Parameter Guide (PDF)
- Voice Name List (PDF)

All of these manuals are on the included accessory disc.

A printed copy is included only for the Quick Start Guide.

Video Manual

This video illustrates the main functionality of the KROME.

Quick Start Guide

This provides a simple explanation of the KROME's functions. To begin, please watch the Video Manual and read the Quick Start Guide.

Operation Guide

Put simply, the Operation Guide is designed to answer the question, "How do I do this?"

It explains the names and functions of each part of the KROME, basic operation, an overview of each mode, how to edit sounds, record on the sequencer, and so on. This guide also explains the basics of effects, the Arpeggiator, Drum Track, and Drum Kits.

Finally, it also contains a troubleshooting guide as well as supplemental information such as a list of specifications.

Parameter Guide

The Parameter Guide is designed to answer the question, "What does this do?"

Organized by mode and page, the Parameter Guide includes information on each and every parameter in the KROME.

Voice Name List

The Voice Name List lists all of the sounds and setups that are in the KROME when it is shipped from the factory, including Programs, Combinations, Multisamples, Drumsamples, Drum Kits, Arpeggio Patterns, Drum Track Patterns, Template Songs, and Effect Presets.

PDF versions

The KROME PDF manuals are designed for easy navigation and searching. They include extensive PDF contents information, which generally appears on the side of the window in your PDF reader and lets you jump quickly to a specific section. All cross-references are hyper-links, so that clicking on them automatically takes you to the source of the reference.

Conventions in this manual

References to the KROME

The KROME is available in 88-key, 73-key, and 61-key models. The manuals refer to all models without distinction as "the KROME." The front panel and rear panel illustrations in the manual show the 61-key model, but they apply identically to the other models.

Abbreviations for the manuals: QS, OG, PG, VNL

In the documentation, references to the manuals are abbreviated as follows.

QS: Quick Start Guide

OG: Operation Guide

PG: Parameter Guide

VNL: The Voice Name List

Symbols , , Note, Tips

These symbols respectively indicate a caution, a MIDI-related explanation, a supplementary note, or a tip.

Example screen displays

The parameter values shown in the example screens of this manual are only for explanatory purposes, and may not necessarily match the values that appear in the Display of your instrument.

MIDI-related explanations

CC# is an abbreviation for Control Change Number.

In explanations of MIDI messages, numbers in square brackets [] always indicate hexadecimal numbers.

What is REMS * ?

REMS (Resonant structure and Electronic circuit Modeling System) is Korg's proprietary technology for digitally recreating the numerous factors that produce and influence a sound, ranging from the sound-production mechanisms of acoustic instruments and electric/electronic musical instruments, to the resonances of an instrument body or speaker cabinet, the sound field in which the instrument is played, the propagation route of the sound, the electrical and acoustic response of mics and speakers, and the changes produced by vacuum tubes and transistors.

* All product names and company names are the trademarks or registered trademarks of their respective owners.

Table of Contents

About this manual	ii	Effects	42
Introduction to the KROME	1	Automatically importing a Program into Sequence mode	42
Front and rear panels	1	Playing and editing Combinations . . .	43
Front panel	1	Playing combinations	43
Rear panel	3	Selecting Combinations	43
Objects in the display	4	Using controllers to modify the sound	45
Basic Information	7	Performing with the arpeggiator or drum track . . .	45
About the KROME's modes	7	Easy Combination editing	46
Basic operations	9	Changing the program of each timbre	46
Setup	15	Adjusting the mix	46
Turning the power on/off	15	Simple editing using the knobs	47
Connecting the AC adapter	15	Saving a Combination you've edited	47
Turning the power on	15	Detailed Editing with Combinations	47
Turning the power off	15	A suggested approach for editing	48
Connections	17	Restoring edited settings	48
Audio connections	18	Layers, Splits, and Velocity Switches	48
Connecting a damper pedal, foot switch, or foot pedal	18	MIDI settings	50
Connecting the KROME to a computer	20	Altering Programs to fit within a Combination . . .	51
Connecting MIDI devices	20	Arpeggiator settings	52
Playing and editing Programs	21	Drum Track settings	52
Playing Programs	21	Effects	52
Selecting Programs	21	Automatically importing a Combination into Sequencer mode	52
Program information	24	Creating songs (Sequencer mode) . . .	53
Using Controllers	24	Overview	53
Performing with the arpeggiator or drum track . . .	26	About the KROME's Sequencer	53
Easy Program editing	27	Sequencer mode structure	53
Adjusting the EQ	27	Transport control	54
Adjusting the volume balance	27	Playing Songs	55
Using realtime controls to edit the sound or effects	28	Playback	55
Using Tone Adjust	29	Recording	57
Comparing the unedited sound	30	Preparations for recording	57
Saving your edits	30	Recording MIDI in real time	60
Detailed Editing with Programs	31	Step recording	61
Before you start editing	31	Recording multiple tracks from an external sequencer	63
An overview of the edit pages	32	Recording System Exclusive events	64
Basic oscillator settings	32	Recording patterns	65
Creating time-varying changes (LFO and EG)	35	Other way to record	66
Diverse modulation settings (AMS and AMS mixer)	36	Song editing	67
Controlling Pitch	37	Song	67
Using Filters	38	MIDI tracks	67
Using the Amp section	40	Track view edit	68
Making controller assignments	41	Piano Roll Editing	70
Arpeggiator settings	42		
Drum Track settings	42		

Creating an RPPR pattern..... 71
 Creating RPPR data.....71
 RPPR playback.....72
 Realtime-recording an RPPR performance.....72

Creating and playing a Cue List 74
 Creating a cue list.....74
 Converting a cue list to a song.....75

Saving your song 75

Using Effects..... 77

An overview of the KROME’s effects..... 77
 Effect I/O.....77
 Effects in each mode.....78

Routing effect settings 79
 Program Effects settings.....79
 Using effects in Combinations and Songs.....81

Dynamic modulation, Common FX LFO..... 82
 Dynamic modulation (Dmod).....82
 Common FX LFO.....83

Arpeggiator function 85

Using the arpeggiator while you play 85
 Using the arpeggiator in Program mode.....85
 Using the arpeggiator in Combination mode.....88
 Arpeggiator settings in Combination and
 Sequencer modes.....89
 Linking the arpeggiator to programs or
 combinations.....91
 Creating a user arpeggio pattern.....91
 Regarding arpeggiator synchronization.....96

Drum Track function 97

Performing with the Drum Track function 97
 Using the Drum Track function in Program
 mode.....97
 Using the Drum Track function in Combination
 mode.....98

Drum Track function settings 100
 Drum Track function settings in Program
 mode.....100
 Drum Track function settings in Combination
 mode.....101
 Drum Track function settings in Sequencer
 mode.....101
 Synchronizing the Drum Track function.....102
 Creating a Drum Track pattern.....103

Using Drum Kits..... 105
 Drum Kit Overview.....105
 Before you start editing.....105
 Editing a Drum Kit.....106

Adjusting Global KROME settings 109

How Global mode is structured..... 109

Global settings..... 109
 Basic setup.....109
 MIDI Settings.....111
 Pedal and other controller settings.....111
 Creating user scales.....112
 Setting Category Names.....112

Loading & saving data 113

Saving data..... 113
 Saving data on the KROME.....113
 Writing to internal memory.....115
 Editing names.....117
 Saving to SD card (Media-Save).....118
 Using the KROME as a data filer.....119

Loading data 120
 Data that can be loaded.....120
 Loading data from SD card (Media-Load).....120

Media utility 123
 Formatting media.....123
 Setting the current time.....123

Appendices 125

Restoring the factory settings..... 125
 Loading the preloaded data.....125
 Initialization.....125

Troubleshooting 126
 Power supply.....126
 Display.....126
 Audio output.....126
 Programs and Combinations.....127
 Songs.....128
 Arpeggiator.....128
 Drum Track function.....128
 Drum Kits.....128
 Effects.....129
 MIDI.....129
 Damper pedal.....129
 Media.....129
 Connections with a computer.....129

Error messages..... 130
 Error and confirmation messages.....130

Specifications..... 134
 Operating requirements.....135

MIDI Implementation Chart..... 136

Introduction to the KROME

Front and rear panels

Front panel

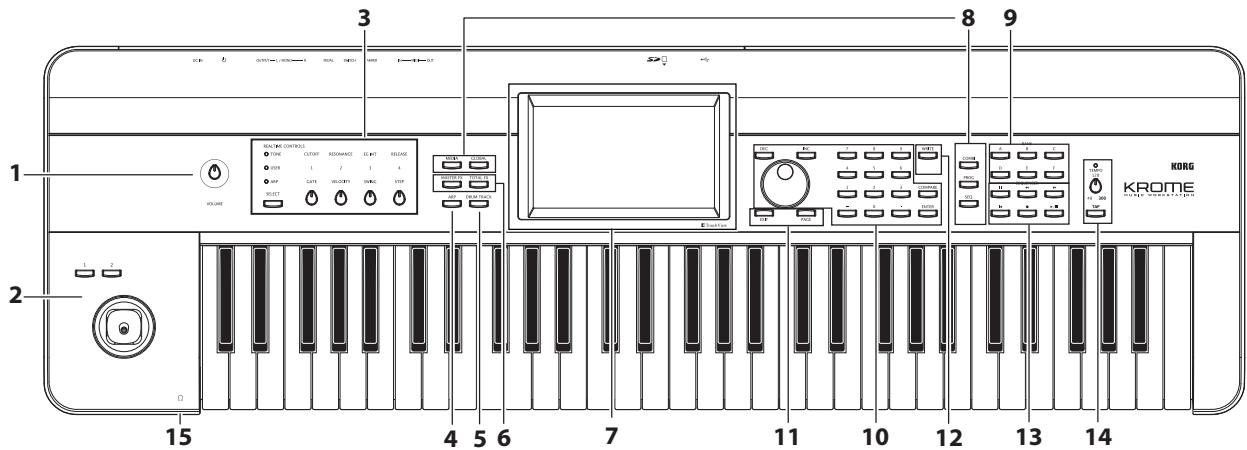

* The diagram shown is for KROME-61

1. Volume

VOLUME knob

This knob adjusts the volume of the AUDIO OUTPUT L/MONO, R outputs, as well as the volume of the headphone jack. (See page 15)

2. SW1, 2 and Joystick

SW1 and SW2

These buttons are used to control the programs or effect parameters, or to turn the joystick lock function on/off. (See page 24)

Joystick

You can control synthesis parameters or effect parameters by moving the joystick up/down/left/right. (See page 24)

3. REALTIME CONTROLS

These realtime controllers consist of four knobs and one button. You can use them to do the following things.

- Control the sound and effects of programs and combinations
- Control the arpeggiator

SELECT button, knobs 1–4

Use the SELECT button to select the functions controlled by knobs 1–4. By using knobs 1–4 you can control the sound, effects, and arpeggiator.

(For details, please see “Realtime control knobs” on page 25.)

(For details, please see “Using realtime controls to edit the sound or effects” on page 28.)

4. Arpeggiator

ARP button

This button turns the arpeggiator on/off. The button will be lit if the arpeggiator is on. (See page 85)

5. DRUM TRACK

DRUM TRACK button

This button turns the Drum Track function on or off.

This button also indicates the operating state of the drum track. (Unlit: off, Blinking: waiting for trigger, Lit: on. See page 97.)

6. Effect buttons

MASTER FX button

TOTAL FX button

These buttons turn the master effect and total effect on/off. When the button is on (LED lit), the effect settings of the program, combination, or song will be enabled. When the button is off (LED unlit), the corresponding effect will be off.

The on/off status of these buttons is remembered even when you switch programs, combinations, or songs. (See page 110)

7. Display

Display

The TouchView display features simple touch control and selection of numerous features and parameters. (See page 4)

8. Mode

COMBI, PROG, SEQ, GLOBAL, MEDIA buttons

KROME has five different modes, each one is optimized for a specific set of functions.

Press one of these buttons to enter the corresponding mode.

For more details, please see "Selecting modes" on page 9.

9. PROG/COMBI BANK

A, B, C, D, E, F buttons

These buttons select program banks A–F and combination banks A–D (see page 21, and page 44). You can also use these buttons to select the bank of timbre programs in a combination, or the bank of track programs in a song (see page 46, and page 57).

If you want to select a GM bank, use the numeric keys (see page 22) or the Bank/Program Select menu (see page 22).

10. VALUE controllers

Use these controllers to edit the parameter that's selected in the display.

INC and DEC buttons

VALUE dial

0–9, -, ., and ENTER buttons

Together, these controls specify and confirm the value of the selected parameter. (See page 10)

COMPARE button

Compares your current edited sound to the sound before it was edited.

For more details, please see "Compare function" on page 11.

11. PAGE SELECT, EXIT

PAGE button

When you press this button, a list of the pages within the selected mode will appear in the display. Press the button of the desired page. (See page 9)

EXIT button

Press this button to return to the main page of the current mode. (See page 9)

12. Save (Write)

WRITE button

Use this button to save programs, combinations, global settings, drum kits, or arpeggio patterns to internal memory (see page 9).

You'll also use this button to save songs to media (see page 75).

When you press this button in the appropriate mode or page, a Write dialog box will appear. Press the button once again to save the data.

13. Sequencer

The buttons in this section are used for operations in Sequencer mode, such as recording and playback (see page 54). The REC (●) button is also used to save a program or combination, or when using the Auto Song Setup function (see page 59).

PAUSE (||) button

REW (◀◀) button

FF (▶▶) button

LOCATE (|◀) button

REC (●) button

START/STOP (▶ / ■) button

14. TEMPO controls

TEMPO knob

This knob adjusts the tempo of the arpeggiator, drum track, or internal sequencer.

TEMPO LED

This LED will blink at quarter-note intervals of the current tempo.

TAP button

By pressing (or tapping) this button on the beat, you can enter the tempo used by the arpeggiator, drum track, or internal sequencer (see page 25).

15. Headphone

Headphone jack

Connect your headphones here.

This jack will output the same signal as the AUDIO OUTPUT L/MONO and R jacks.

The headphone volume is controlled by the VOLUME knob.

Rear panel

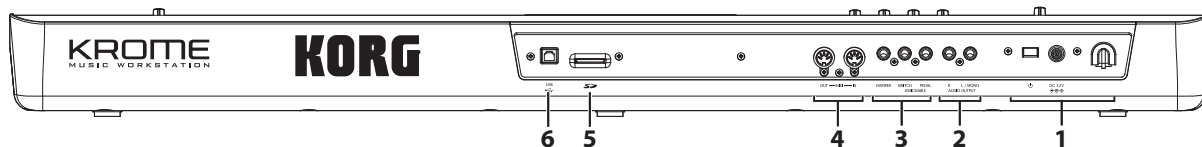

1. Power supply

Be sure to see “Turning the power on” on page 15 and follow the correct procedure described there.

Note: The KROME has an auto power-off function that automatically turns off the power when the keyboard or front panel buttons have not been used for a certain length of time. With the factory settings, this is set to 4 hours (see “Auto power-off function” on page 16).

Power switch

This switch turns the power on/off. (See page 15)

AC adapter connector

The included AC adapter is connected here. (See page 15)

 Connections must be made with the power turned off. Please be aware that careless operation may damage your speaker system or cause malfunctions.

Cable hook

Use this to secure the cable of the included AC adapter. After connecting the AC adapter, loop the cable around the hook located on the KROME’s rear panel so that the cable won’t get pulled out inadvertently. Leave enough slack on the plug end so that you can disconnect it if you want to. (See page 15)

 Be careful not to bend the base of the plug any more than necessary.

2. AUDIO OUTPUTS

AUDIO OUTPUT L/MONO & R jack

These are the stereo audio outputs. Use the VOLUME knob to adjust the volume. (See page 17)

3. PEDALS

You can connect a damper pedal, foot switch, and foot pedal to these jacks. This gives you a broader range of functions and effects to control. (See page 18)

ASSIGNABLE PEDAL jack
ASSIGNABLE SWITCH jack
DAMPER jack

4. MIDI

MIDI lets you connect the KROME to a computer or other MIDI devices, for sending and receiving notes, controller gestures, sound settings, and so on. (See page 20)

MIDI IN connector
MIDI OUT connector

5. SD

SD card slot

You can insert an SD card here, and use it to save/load KROME programs, combinations, or song data. (See page 118)

6. USB

USB connector (for connecting to computer)

You can connect your computer to this connector. Using a single USB cable, your KROME can send and receive MIDI information directly to and from a computer, without requiring a MIDI interface. (See page 20)

Note: The USB connector of the KROME is only able to transmit and receive MIDI data.

Objects in the display

The KROME uses Korg's TouchView graphical user interface.

By pressing or dragging objects shown in the display, you can select programs or combinations, or edit parameter values. Here we'll explain the names and functions of these objects.

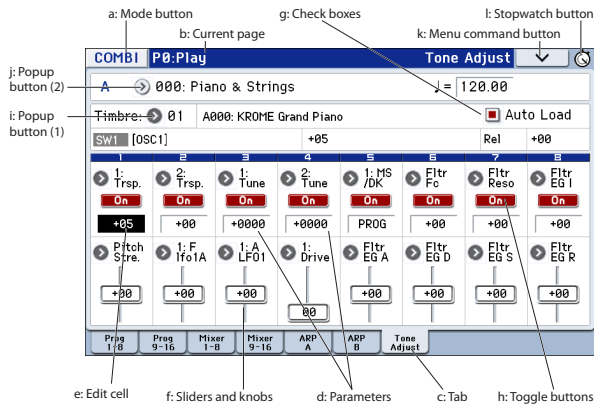

a: Mode button

This indicates the mode that's currently selected.

When you press this button, the Mode menu will appear. In the mode menu, press the name of the mode that you want to move. If you select the currently selected mode, the Page Select menu for that mode will appear. Even in another mode, pressing the right side of the name will display the Page Select menu for each mode.

To close the menu, press the Close button or the EXIT button.

If you access this menu from Global or Media mode, it will include an item named Return. If you press Return, you will return to the mode where you were before selecting Global or Media mode.

Mode menu

When selected in Program, Combination, or Sequencer mode

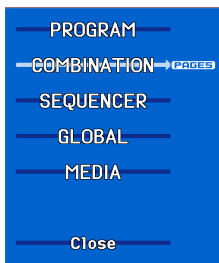

When selected in Global or Media mode

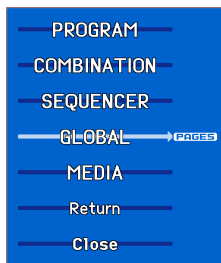

b: Current page

This indicates the current page within the selected mode.

Beginning on the left, this area shows the mode button, page number: name, and tab name.

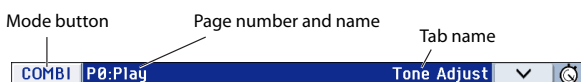

c: Tab

Most pages are divided into two or more tabs.

d: Parameters

The parameters for various settings are shown in the display.

e: Edit cell

When you touch a parameter in the display, the parameter or parameter value will usually be highlighted (displayed in reverse highlighting). This is called the **edit cell**, and the highlighted item will be available for editing.

Use a value controller such as the VALUE dial (see page 2) to edit the value.

Alternatively, you can edit the value by pressing the edit cell and using your finger to drag in the direction of the triangles that appear. (The shading of the triangles will change in three levels; this function will become available when the darkest shading is reached.)

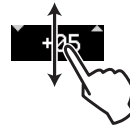

In addition, you can display the edit pad by pressing twice in succession on the edit cell, or by holding it down for a time and then releasing it (see page 6).

f: Sliders and knobs

To edit the value of an object shaped like a slider or knob, press it to move the edit cell. For details on how to edit the value, please see "e: Edit cell," above.

The parameter will be active if it is checked, and inactive if it is unchecked.



g: Check boxes

The presence or absence of a check mark in these boxes will enable/disable parameters or functions. Putting a check mark in the box will enable the item, and clearing the check mark will disable it.

h: Toggle buttons

This type of button will change its function or switch on/off each time it is pressed.

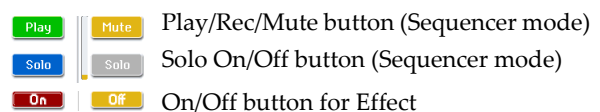

i: Popup button (1)

When this button is pressed, a popup menu will appear, showing the parameter values that are available for selection.

To enter the parameter value, press the desired value in the popup menu.

*** Popup menu**

Pin

This switches the popup menu display between locked and unlocked.

When locked, the pin will be shown closed, and the popup menu will remain displayed even after you press a parameter value. When unlocked, the pin will be shown opened, and the popup menu will close immediately when you press a parameter value.

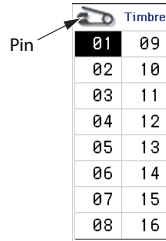

*** Dialog box**

When you select a menu command, you'll see a screen containing the settings needed to execute the command. This is called a dialog box. The dialog box that appears will depend on the menu command that you select. Some commands, such as **Exclusive Solo**, do not display a dialog box.

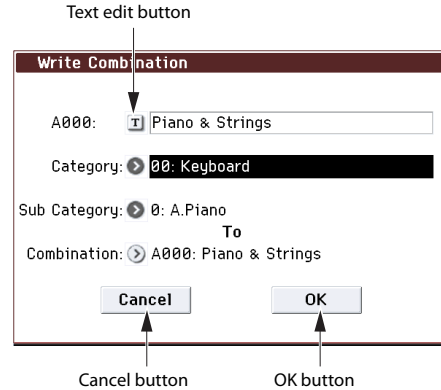

j: Popup button (2)

When you press this button, a tabbed menu will appear. To close a tabbed menu, press the OK button or Cancel button.

Scroll bar

Use this when you need to see parameter values that extend beyond what can be shown in the display at one time.

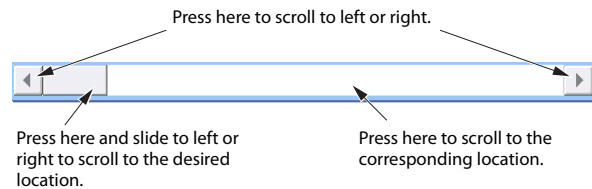

k: Menu command button

*** Menu**

When this button is pressed, a list of menu commands will appear.

The menu commands that appear will differ depending on the selected page.

You can also select up to ten menu commands by holding down the ENTER button and pressing a numeric key 0-9. The menu will close when you press the display in a location other than the menu, or when you press the EXIT button.

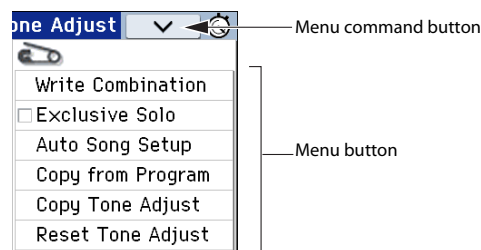

*** Text edit button**

When you press this button, the text edit dialog box appears for changing the names of Programs, Combinations, Songs, etc. For details, please see "Editing names" on page 117.

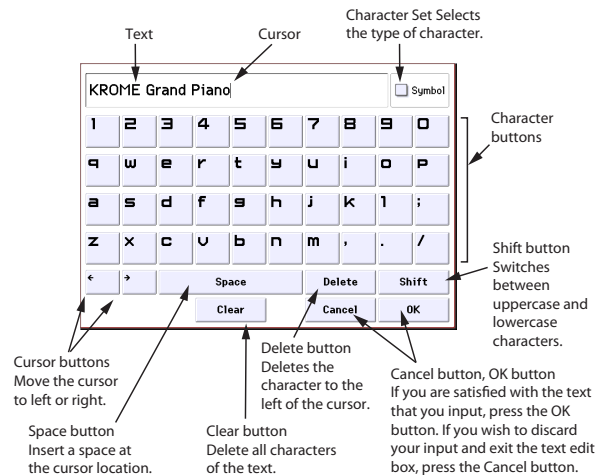

*** OK and Cancel buttons**

After performing other operations in the dialog box, you can execute the command by pressing the OK button. To cancel without executing, press the Cancel button. (The operation will occur when you press and release the button.) The dialog box will close.

The EXIT button corresponds to the Cancel button, Done button, and Exit button.

*** Done, Copy, and Insert buttons**

There are buttons which perform function when they are pressed and released, such as Done, Copy, and Insert (similar to the OK and Cancel buttons explained under "Dialog box," above).

l: Stopwatch button

When you press the button on the upper right of the display, the time elapsed since power-on will be displayed. You can use the START/STOP button and RESET button to measure elapsed time. This is

convenient when you want to check the time during a live performance or rehearsal, or to determine the approximate playback time of a song.

- START/STOP: Starts or stops the stopwatch
- RESET: Returns the time to 000:00:00



m: Radio buttons

Press a radio button to select one value from two or more choices.



*** Edit pad**

Numerical input pad / calculator

If you press an edit cell, slider, or knob twice in quick succession, a pad for inputting numbers or using a calculator will appear. The various buttons have the following functions.

- OPERATION DIRECT/CALCULATE: Switches between numerical input pad and calculator.
- CE (clear entry): Clears the currently-input number.
- Ent: Enters the number from the pad into the parameter, and closes the pad.
- RECALL: Copies the parameter value into the pad.
- Close: Closes the pad.

Numerical input pad

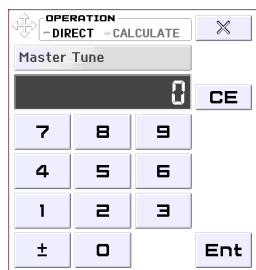

Calculator

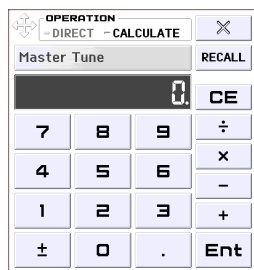

Note: Some parameters cannot use the calculator function.

Bank and number select pad

If you press twice in succession on Program Select, Combination Select, or Timbre Select, the bank and number select pad will appear.

Bank and number select pad

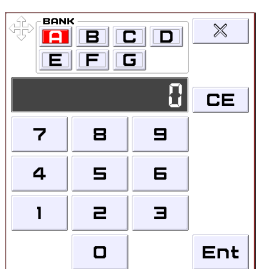

- BANK: Selects the program or combination bank.
- For other functions, see "Numerical input pad."

Value slider / Wheel pad

When you hold down an edit cell, slider, or knob for a while and then release it, the wheel/value slider will appear.

To change the value, drag the wheel/slider pad.

SLIDER

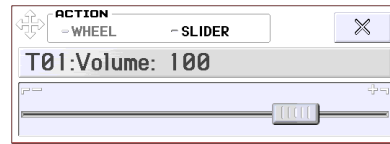

WHEEL

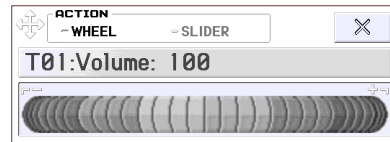

Note: If you don't want the edit pad to appear, clear the "Enable Edit Pad" check box in the menu found in Global P0: Basic Setup– System Preferences (see page 111).

*** EG, Velocity Split**

You can change the values of a EG or velocity split object by dragging in the display.

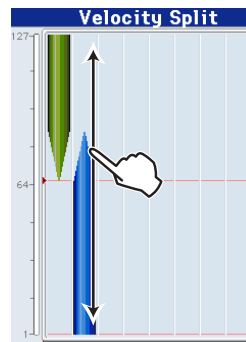
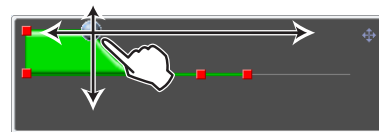

*** Realtime control popup**

When you use a REALTIME CONTROLS knob, a popup will indicate the function that's being controlled and its value. A certain length of time after you stop using the knob, this popup will close automatically. If you press the popup while it's displayed, it will stay visible, allowing you to enter the value using a value controller such as the numeric keys.

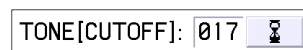

Note: If you don't want the realtime control popup to appear, clear the "REALTIME CONTROL Pop-Up" check box in the menu located in Global P0: Basic Setup– System Preferences.

Basic Information

About the KROME's modes

The KROME has numerous functions that let you play and edit programs or combinations, record and play back sequence data, and manage media. These functions are grouped into "modes." The KROME has five modes.

Program mode

Programs are the basic sounds of KROME.

In Program mode, you can:

- Select and play Programs.
- Use one arpeggiator in your performance.
- Play back Drum Track patterns while you perform using a Program.
- Edit Programs

You can use the realtime controls and the Tone Adjust function to easily edit the program.

You can adjust the parameters and settings of the oscillators, filters, amps, EGs, LFOs, effects, arpeggiator, drum track, etc.

You can use up to five insert effects, two master effects, and one total effect.

Plus, you can create drum programs using drum kits (as created in Global mode).

Combination mode

Combinations are sets of up to 16 programs that can be played simultaneously, letting you create sounds that are more complex than a single Program. In Combination mode, you can:

- Select and play Combinations.
- Use multiple timbres to play arpeggio patterns generated by two arpeggiators.
- Use one or more timbres to play back the patterns in the drum track.
- Use the KROME as a 16-track multitimbral tone generator.
- Edit Combinations

You can use the tone adjust function to easily edit the program of each timbre.

You can assign Programs to each of the 16 Timbres, each with separate volume, pan, EQ, and keyboard and velocity zones; make settings for effects, arpeggiator, drum track.

Plus, you can use up to five insert effects, two master effects, and one total effect.

Sequencer mode

Sequencer mode lets you record, playback, and edit MIDI tracks. You can:

- Use the sixteen-track MIDI sequencer to record and play back songs.
 - Record a single MIDI track at a time, or record as many as all sixteen tracks simultaneously. You can also record exclusive messages.
- Use multiple tracks to record and play back performances generated by two arpeggiators.
- Use one or more tracks to play back the patterns in the drum track.
- Edit songs.
- Use the KROME as a 16-part multi-timbral sound module.
- GM/GM2 playback is also supported.
- Use the Tone Adjust function to easily edit the program of each track.
- Use up to five insert effects, two master effects, and one total effect.
- Record patterns and assign them to individual keys, using RPPR (Realtime Pattern Play/Recording).
- Create a Cue List that will play back multiple songs in the order that you specify.
- Create user Drum Track patterns.

Global mode

Global mode lets you adjust overall settings for the entire KROME, and edit drum kits, arpeggio patterns. In Global mode, you can:

- Adjust settings that affect the entire KROME, such as master tune and global MIDI channel.
- Create user scales.
- Create drum kits using drumsamples.
- Create user arpeggio patterns.
- Rename program, and combination categories.
- Set the function of the assignable pedals and assignable buttons.
- Transmit MIDI System Exclusive data dumps.

Media mode

You can save or load data using an SD card. In Media mode, you can:

- Save and load Programs, Combinations, Songs, and Global setup data.
- Format SD card, copy and rename files, etc.
- Perform file operations such as copying data to or from media.
- Export and import sequences to and from SMF (Standard MIDI Files).
- Use the Data Filer function to save or load MIDI System Exclusive data.

Relational diagram of the KROME's modes

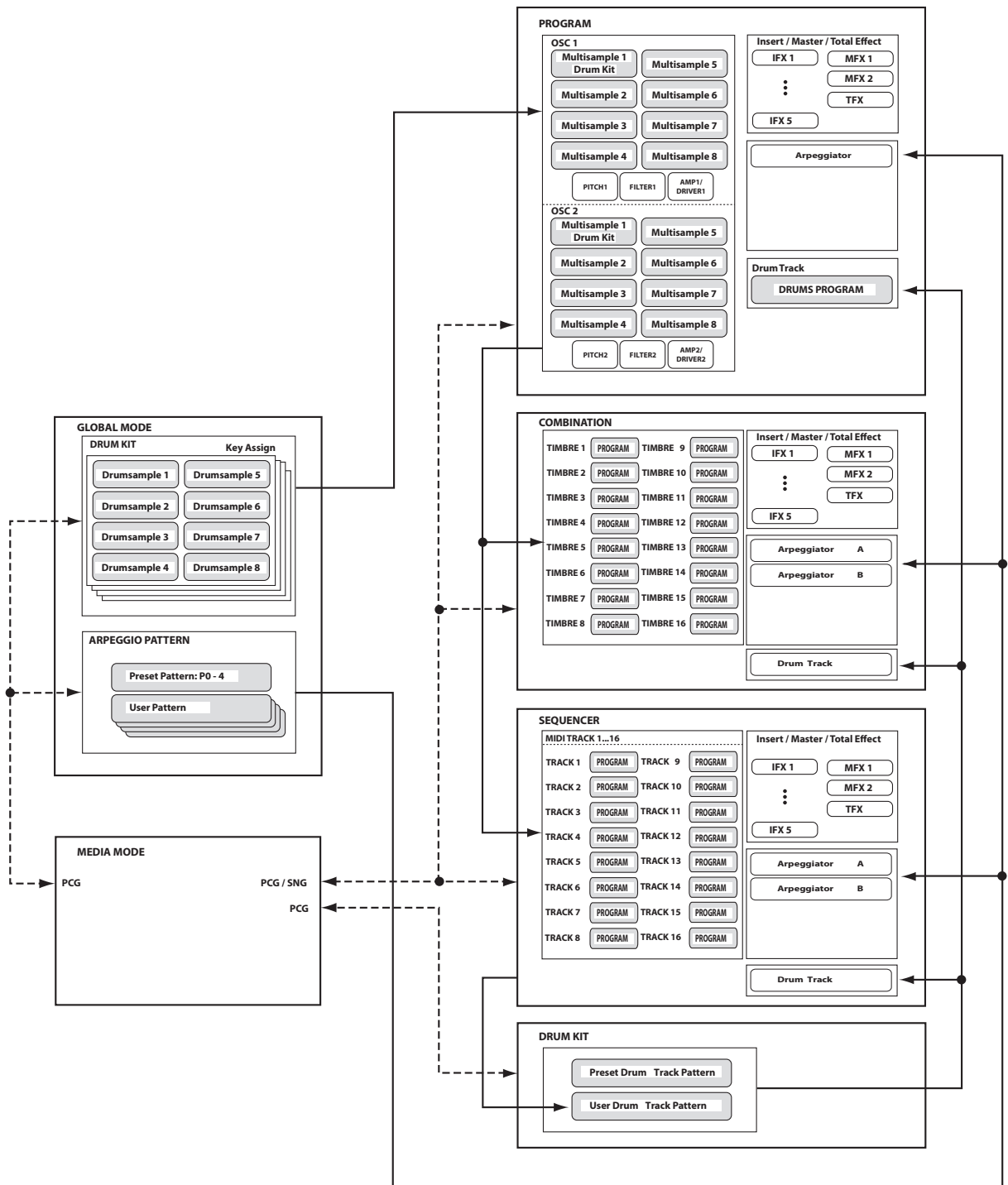

Basic operations

After you've turned on the KROME, here's how to perform basic operations, such as selecting modes and pages.

Selecting modes

In order to use a particular function on the KROME, you must first select the appropriate mode.

- Press one of the front panel mode buttons to enter the corresponding mode.

COMBI button:	Combination mode
PROG button:	Program mode
SEQ button:	Sequencer mode
GLOBAL button:	Global mode
MEDIA button:	Media mode

- Alternatively, you can press the Mode button located in the upper left of the display, and select the desired mode from a menu (see page 4).

For a summary of each mode, please see "About the KROME's modes" on page 7.

Note: The selected mode is shown in the upper left of the display, and also indicated by the lit status of one of the above mode buttons.

Note: By pressing the GLOBAL or MEDIA button twice, you can select the previously-selected mode (Combination, Program, or Sequencer).

Selecting page group and tabs

Each mode has a large number of parameters, which are grouped into pages. These pages are further subdivided by tabs; with up to twelve tabs per page.

- Make sure that the desired mode is selected.
 - For this explanation we'll use Combination mode as an example.

Selecting a page group

Moving by selecting a page group

The Page Select screen shows a list of the page groups within each mode. Select the desired page group from this list.

1. Press the PAGE button.

Alternatively, you can access the mode menu and press the mode button, and then press the right side of the menu (see page 4).

The page select menu will appear.

The page where you were immediately before pressing the PAGE button is shown in a darker color for your reference.

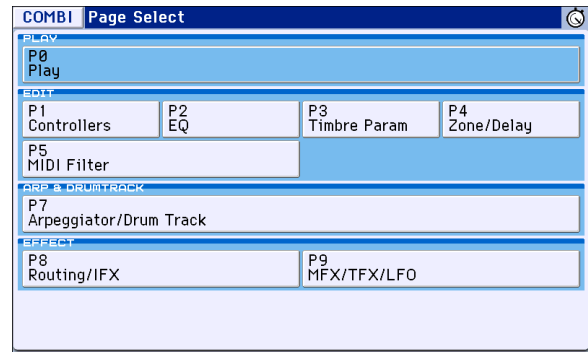

2. Press the button for the page that you want to view.

P0: Play is the page you'll normally use when performing on the KROME. (The same is true in Program mode.) Editing is done in other pages.

As an example here, try selecting "P4 Zone/Delay." The P4: Zone/Delay– Key Z T01–08 will appear.

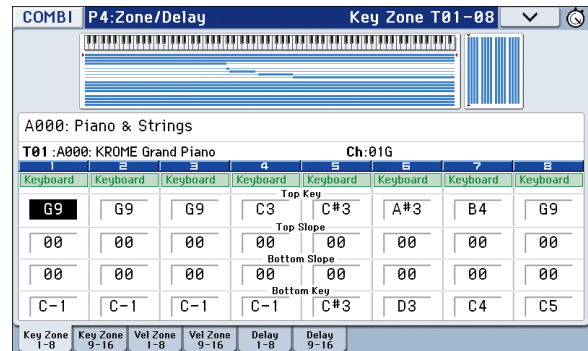

Note: The page that appears will be showing the tab that you most recently selected.

Using the PAGE button plus the numeric keys 0–9 to access different pages

- Hold down the PAGE button and use the numeric keys 0–9 to specify the page number that you want to view.

The specified page number will appear. The page that appears will be showing the tab that you most recently selected.

Note: In pages consisting of multiple pages such as P5–1, P5–2, P8–1, and P8–2, the first page (P5–1, or P8–1) will be selected.

Using the EXIT button to move between pages

If you're in a page other than page 0 (e.g., Prog P0: Play) of each mode, pressing this button will take you to page 0.

This button makes it easy to return to the main page of the current mode:

- Press it once to go to the previously-selected tab on the main P0: Play page (Play/REC page in Sequencer mode).
- Press it again to go to the first tab on the main P0: Play page (such as the main Program Play page). If you had previously selected a parameter on this page, that parameter will be selected.
- Press it a third time to select the main parameter on the P0: Play page, such as the Program name in Program mode.

When a dialog box is open, this button cancels the settings made in the dialog box and closes the dialog box, just like pressing the Cancel button.

If a popup menu or menu is open, pressing EXIT closes the menu.

Selecting pages

- You can access tabbed pages by pressing the tabs shown in the bottom line of the display.

This example shows the Program T01-08 page through Mixer T01-08 page of Combi P0: Play.

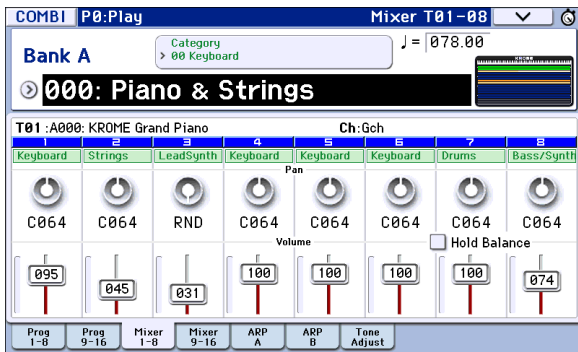

Selecting a parameter and editing the value

- Press the parameter that you want to edit.
- If you select an edit cell, the display will be highlighted. Edit the value.
 - The way that the value will change depends on the type of parameter or object. (See "Objects in the display" on page 4.)

The value in the edit cell can be edited by using the value controllers (VALUE dial, INC/DEC buttons, numeric keys 0-9, - button, (.) button, ENTER button, etc.).
- You can use knobs 1-4 to edit parameters that are assigned to the control surface.

Note: You can use the COMPARE button to compare the sound you're editing with the original unedited sound.

INC/DEC buttons

Use these when you wish to make small changes in the value.

VALUE dial

Use this dial to edit the selected parameter's value. This control is convenient when you want to scroll through a very long list of selections.

Numeric keys 0-9, ENTER button, - button, (.) button

These buttons are convenient when you know the exact value that you want to enter. Use the 0-9, -, and decimal (.) buttons to enter the value, and then press the ENTER button to confirm the entry.

The - button inverts the sign (+/-) of the parameter value; the decimal (.) button inserts a decimal, for entering fractional values.

Note: When selecting "Program Select" (see page 21), you can select a GM bank by holding down the 0 button and pressing the (.), 1-9, or - buttons.

Functions that use the ENTER button in conjunction with another button

ENTER has a few special functions when it is pressed in combination with other buttons.

By holding down the ENTER button while you press a numeric key (0-9), you can select up to ten menu commands from within the current page.

While a dialog box is displayed, the ENTER button corresponds to the OK button. (The EXIT button corresponds to the Cancel button.)

In Sequencer mode, you can hold down the ENTER button and press the LOCATE (⏮) button to use the menu command **Set Location**.

Other

Specifying a program bank or combination bank

PROG BANK A, B, C, D, E, F/ COMBI BANK A, B, C, D buttons

Use these buttons to change banks when selecting Programs or Combinations. The LEDs in the buttons light up to show the current bank.

In Program mode, these buttons select the Program bank.

In Combination mode, these buttons have two functions:

- When you're selecting Combinations, they choose the Combination bank.
- When you're assigning a Program to a timbre within the Combination, they select the Program bank.

In Sequencer mode, when a track's Program name is selected, these buttons change the Program bank.

Using the keyboard to enter a note number or velocity value

By playing a key while pressing a parameter that specifies a note number (such as G4 or C#2) or a velocity value, you can directly enter that note number or velocity value. (This is not available in menu command dialog boxes.)

Tempo input

TEMPO knob, TAP button

You can set the tempo by turning the TEMPO knob or by repeatedly pressing the TAP button.

COMPARE button

You can use this button to return the settings of an edited program, combination, or song to their original state. Refer to the following section.

Compare function

Program, Combination mode

Use this when you wish to compare the edits you have made to a program or combination's sound with the un-edited original (i.e., the sound that is written into memory).

When editing a program or combination, press this button. The LED will light up, and the last-written settings for that program or combination number will be recalled. When you press the COMPARE button once again, the LED will go dark and you will return to the settings that you were editing.

1. When editing a program or combination, press this button.

The LED will light up, and the last-written settings for that program number or combination number will be recalled.

2. Press the COMPARE button once again.

Note: The LED will go dark and you will return to the settings that you were editing.

If you edit the settings that are recalled by pressing the COMPARE button (i.e., the settings that are written into memory), the LED will go dark, and it will not be possible to return to the previous edits by pressing the COMPARE button again.

Sequencer mode

In Sequencer mode, you can use the COMPARE button to make "before and after" comparisons immediately after using realtime recording or step recording to record a song, or after performing an edit on a track.

For example, this can be used effectively when realtime-recording a MIDI track for a song.

1. Realtime-record a MIDI track. (Take 1)

2. Once again, realtime-record on the same track. (Take 2)

3. Press the COMPARE button. The LED will light up, and take 1 will be recalled.

4. Press the COMPARE button once again. The LED will go dark, and take 2 will be recalled.

5. If at step 3 you once again realtime-record on the same track (take 3), the Compare function will now be referencing take 1.

6. If at step 4 you once again realtime-record on the same track (take 3), the Compare function will be referencing take 2.

In this way, the Compare function lets you recall the previous recording or the previous state of event editing.

Note: If you continue editing when the COMPARE button is lit, the button will go dark. This now becomes the musical data that will be selected when the COMPARE button is dark.

Global mode

The Compare function that brings back the settings prior to editing is not available in Global mode.

Selecting and executing menu commands

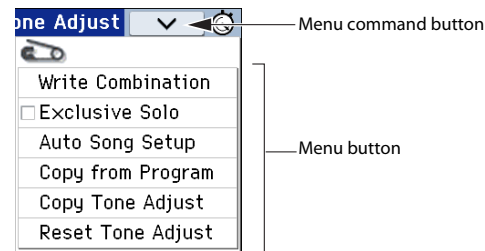

The utility functions provide commands that are specific to each page, such as Write (save) or Copy. The available utility functions will depend on the selected page.

For example, the utility functions in Program mode let you write (save) the settings, or let you perform convenient editing operations such as copying settings between oscillators or effects, or a Sync function that lets you edit two EGs together.

1. On the upper right side of the display, press the \vee button.

The menu command will appear.

2. Select a menu command by touching it with your finger.

A dialog box for the selected menu command will appear.

Check-type commands will not display a dialog box; their status will be switched, and the list will close.

By holding down the ENTER button and pressing a numeric key 0–9 you can access the dialog box for the first ten utility functions without going through the menu.

- If you want to close the list without selecting a command, press the display somewhere other than the list, or press the EXIT button.
- #### 3. For a parameter in a dialog box, select it by pressing it with your finger, and use the VALUE controllers (e.g., VALUE dial or INC/DEC buttons) to enter its value.

When selecting a program or combination number in a dialog box, you can also use the BANK button to enter the bank as an alternative to using the VALUE controllers.

4. To execute, press the OK button or the ENTER button.

If you decide not to execute, press the Cancel or the EXIT button.

The dialog box will close.

Writing/saving

After editing, you should write or save your changes as necessary.

For example if you've edited a program, your changes will be lost if you select another program or turn off the power. The same applies to a combination.

Settings you edit in Global mode and songs will be remembered as long as the power is on, but your changes will be lost when you turn off the power, unless you write these changes into memory.

- You can write or save by pressing the WRITE button twice.

For more details on the Write operations, see the following pages.

- Programs → p.30
- Combinations → p.47
- Effect presets → PG p.67
- Global settings (pages 0–4) → p.116
- Drum kits → p.116
- User arpeggio pattern → p.116
- User Drum Track patterns → p.103
Preset/user Drum Track patterns are saved in internal memory even when the power is turned off. Patterns that you create in Sequencer mode can be converted into user Drum Track patterns and saved in internal memory.
- User template songs → PG p.164
Preset/user template songs are saved in internal memory even when the power is turned off. Track settings and effect settings of a song you create can be saved in internal memory by using the menu command **Save Template Song**.
- For details on writing to internal memory → p.115

Refer to the following pages for more information about saving.

- Saving a song → p.75
- Saving to media (Media-Save) → p.118

Note: On the KROME, the action of writing to internal memory is called "Write," and the action of saving to an SD card device is called "Save."

Assigning a name (renaming)

You can edit the name of an edited program, combination, song, drum kit, or arpeggio pattern.

You can also change the names of the program and combination categories.

For details, please see "Editing names" on page 117.

Shortcuts

Selecting a GM bank program

- Bank GM: Hold down the 0 numeric key and press -.
- Banks g(1)–g(9): Hold down the 0 numeric key and press 1–9.
- Bank g(d): Hold down the numeric key 0 and press (.).

Moving between pages within a mode

- By holding down the PAGE button and pressing a numeric key 0–9 you can jump to the corresponding page.

Access the menu commands in each page (up to ten items)

- By holding down the ENTER button and pressing a numeric key 0–9.

Input note number values or velocity values

- While holding down the edit cell in the display, press a note on the keyboard.
Alternatively, select the edit cell in the display, and then hold down the ENTER button and press a note on the keyboard.

Note: You can also use a MIDI note-on message instead of the keyboard.

Note: While a dialog box is displayed, the ENTER button will perform the same function as the OK button. This means that you can't use this method to enter a note number or velocity value in a dialog box that contains an OK button.

Specifying the location in a song

In Sequencer mode, sets the current location as the **Location** (equivalent to the **Set Location** menu command)

- Hold down the ENTER button and press the LOCATE (⏮) button.

ENTER button

- While a dialog box is displayed, this button performs the same function as the OK button.

EXIT button

This button makes it easy to return to the main page of the current mode:

1. Press it once to go to the previously selected tab on the main P0 page.
2. Press the EXIT button. You will move to the previously selected parameter of the P0 top page (Prog: Main, Combi/Seq: Program T01–08).
3. Press the EXIT button. You will move to the following parameter of the P0 top page.

Prog: Program Select

Combi: Combination Select

Seq: Song Select

In any page of Program or Combination mode, pressing EXIT a maximum of two times will immediately allow you to use the numeric keys or INC/DEC buttons to select programs or combinations. In Sequencer mode, pressing EXIT a maximum of three times will allow you to select a song.

EXIT button (in dialog boxes)

When a dialog box is displayed, this has the same function as the Cancel, Done, or Exit button.

Initialize the KROME

- With the power off, press the power switch while holding down the ENTER button and numeric key [0].
(While data is being loaded, the display will indicate "Now writing into internal Memory.")
The result will be the same as when you've executed **Load Preload/Demo Data All**.
(See page 125)

Setup

Turning the power on/off

Connecting the AC adapter

1. Make sure that the KROME is powered-off.
2. Connect the DC plug of the included AC adapter to the power supply jack on the KROME's rear panel.
- ⚠ You must use only the included AC adapter. Using any other AC adapter might cause malfunctions.
3. Connect the power cord to the AC adapter.
4. Plug the power cord into an AC outlet.
- ⚠ Be sure to use an AC outlet of the correct voltage for your adapter.
5. Use the KROME's cable hook to fasten the cable so that the DC plug does not become accidentally disconnected.

AC adapter connections

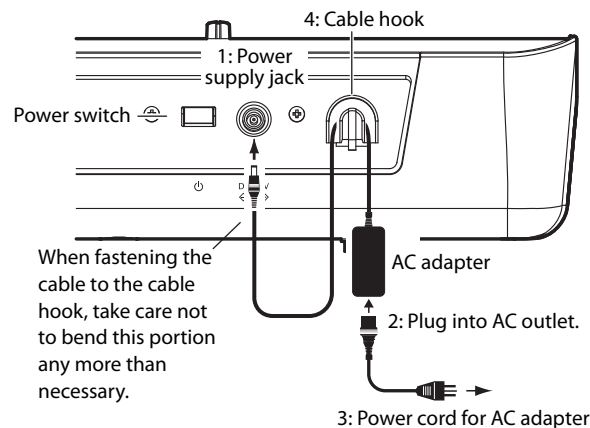

Turning the power on

1. Turn the KROME's VOLUME knob all the way to the left so that the volume is down.

If external equipment such as powered monitor speakers are connected, lower their volume as well, and then turn off their power.

2. Press the power switch on the KROME's rear panel to turn the power on.

The display will show the model name and software version. (The illustration shows the screen that will appear with the factory settings. This may change without notice.)



- ⚠ If the auto power-off function is enabled, the time until auto power-off turns off the power will be shown when the system starts up. If this dialog box does not appear, the auto power-off function is disabled; the power will not turn off automatically (see "Auto power-off function" on page 16).

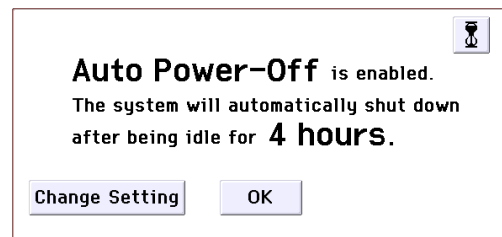

3. Turn on the power of the external equipment that's connected to the KROME's AUDIO OUTPUT L/ MONO and R jacks, such as powered monitor speakers.
4. Use the KROME's VOLUME knob and the volume controls of your external equipment to adjust the volume to a suitable level.

Note: The page that appears when you turn on the power will depend on the Power-On Mode setting (see page 110).

Turning the power off

- ⚠ When you turn off the power, unsaved data will be lost. Be sure to save any important data such as edited sounds or global settings (see page 12).

- ⚠ If the KROME's auto power-off function is enabled, its power will automatically turn off if there has been no user input for a certain length of time. Unsaved data will be lost even if the power is turned off by the auto power-off function.

1. Turn the KROME's VOLUME knob all the way to the left so that the volume is lowered.
2. If external equipment such as powered monitor speakers are connected, lower their volume and then turn off their power.

3. Press the power switch on the KROME's rear panel to turn the power off.

 The KROME's internal data may be damaged if the power is turned off while data is being written into internal memory, such as during a Save operation. Never turn off the power while processing is being performed.

The following message is displayed while data is being written into internal memory.
 "Now writing into internal memory"
 If writing to internal memory could not be completed successfully, the KROME will automatically repair the internal memory by initializing it the next time you turn on the power. This is not a malfunction. If this occurs, the following message will appear in the display; press the OK button.

The internal memory has been corrupted, likely due to an interruption of power while the system was writing/saving data. This has been repaired and the affected Bank has been initialized.

 A small amount of electrical power is used even when the power is off (STANDBY). If you won't be using the KROME for an extended period, turn off the power and unplug the power cord from the AC outlet.

Auto power-off function

The KROME supports an auto power-off function that automatically turns off the power when the keyboard or front panel buttons(*) have not been used for a certain length of time.

* Usage of the VOLUME knob is not included.

Note: With the factory settings, the time until automatic power-off will be approximately four hours.

 When the power turns off, the settings you had been editing will be lost. Make sure that you save important settings before this occurs.

Changing the auto power-off setting

If you want to change the setting so that the power does not turn off automatically, proceed as follows to disable the auto power-off function.

Making the change in the dialog box immediately after start-up

If the auto power-off function is enabled so that the power will turn off automatically, the dialog box will appear immediately after start-up, indicating the time until automatic power-off will occur.

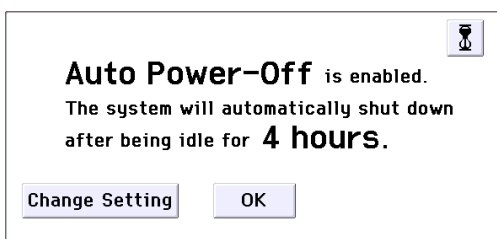

1. While this message is displayed, press the Change Setting button in the dialog box.

The following dialog box will appear.

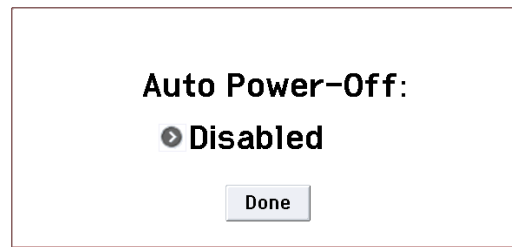

2. Press the popup button to select the length of time after which the power will turn off. If you don't want the power to turn off automatically, choose the Disabled setting.

Changing the setting during operation

1. Press the GLOBAL button. (Alternatively, press the mode button and choose GLOBAL.)
2. Press the EXIT button to access P0: Basic Setup.
3. Press the System Pref. tab to access the System Preferences page.
4. In "Auto Power-Off," specify the amount of time when you want the power to turn off. If you don't want the auto power-off function to automatically turn off the power, choose the Disabled setting.

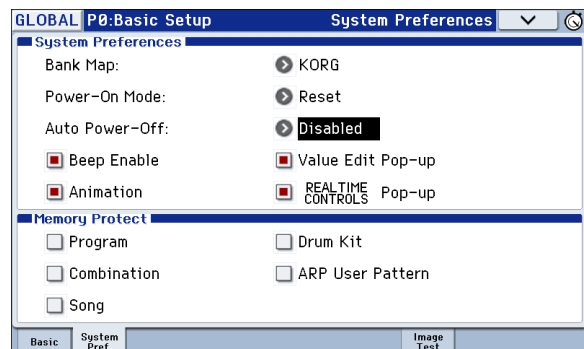

Auto power-off warning message

When the specified length of time has elapsed without any user input on the KROME, a message will appear, warning you that the auto power-off function is about to turn off the power.

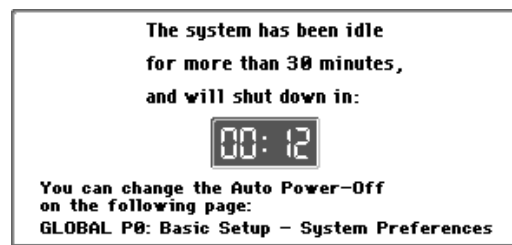

If you want to continue using the system, press the keyboard, a button, or the display. The Auto power-off function will be reset. If the same specified length of time elapses with no user input, the same message will appear again.

Connections

 Connections must be made with the power turned off. Please be aware that careless usage may damage your speaker system or cause malfunctions.

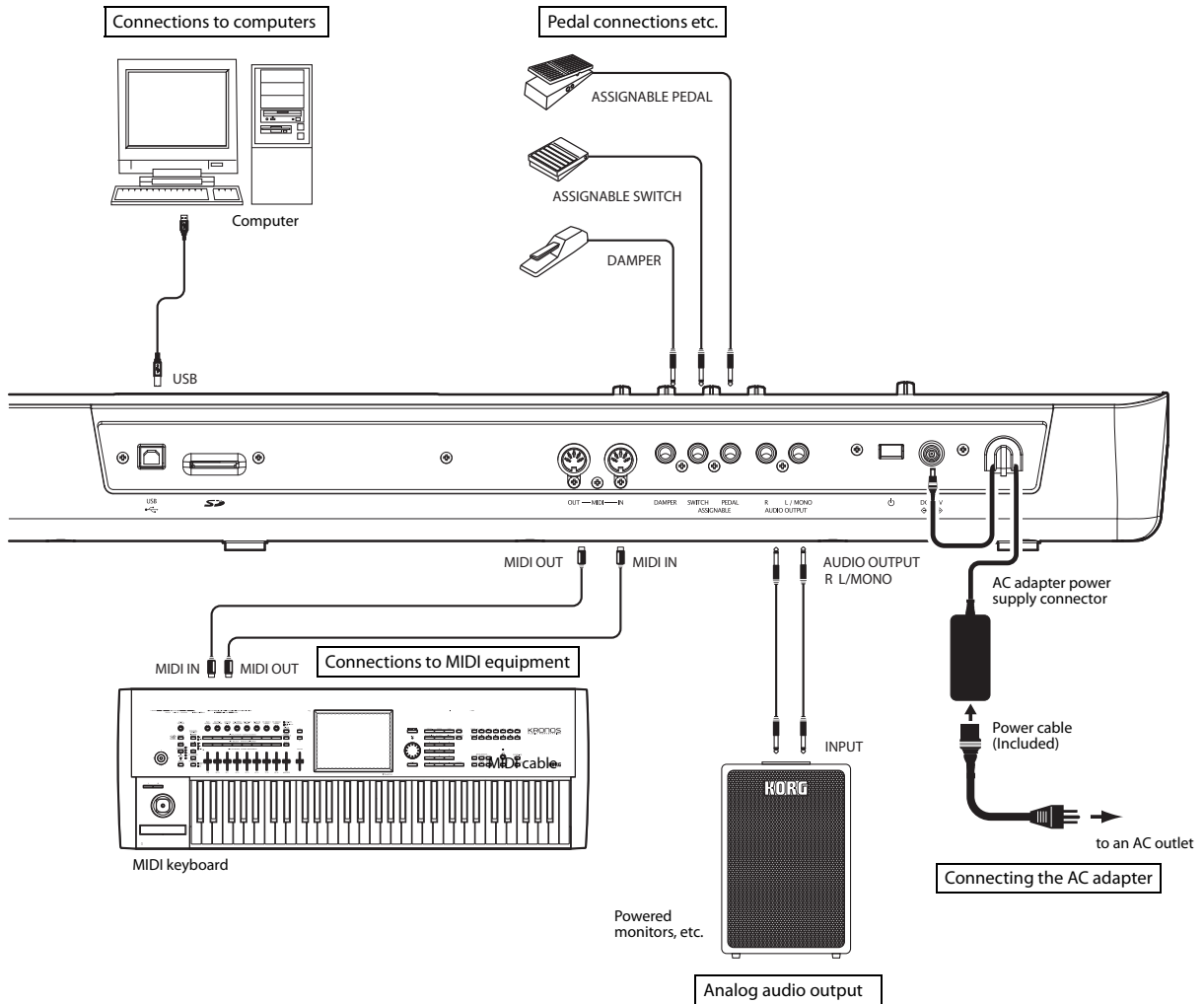

Audio connections

The KROME does not contain built-in speakers. In order to hear the sound of your performance, you'll need to connect audio equipment such as powered monitors, a mixer, a stereo set or headphones.

Connecting audio equipment

⚠ The KROME's audio output is designed to produce a signal level that is higher than consumer audio equipment such as CD players. For this reason, performing at high a volume may damage your speakers or equipment. Please use caution when adjusting the volume.

1. **Minimize the volume of all connected equipment, and turn off the power.**
2. **Connect the KROME's OUTPUT L/MONO and R jacks to the input jacks of your powered monitor speakers or mixer.**

Note: If you connect only the L/MONO jack, the L and R sound will be mixed for monaural output. In order to take full advantage of the KROME's capabilities, we recommend that you listen in stereo.

If you're playing back through your stereo audio system or a cassette-radio that has external input connectors, connect the KROME to the jacks that are marked LINE IN, AUX IN, or external input. (You might need to obtain the appropriate adapter plug or conversion cable.)

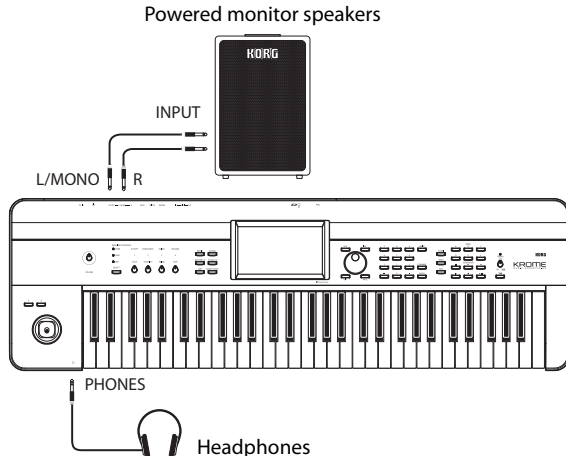

Connecting headphones

⚠ Using headphones at high volume for an extended time may cause hearing damage. Please avoid excessively high volume levels.

1. **Connect the stereo mini-plug of your headphones to the KROME's Headphone jack.**
2. **Use the VOLUME knob to adjust the headphone volume.**

The KROME's Headphone jack will output the same signal as the OUTPUT L/MONO and R jacks.

The output from the OUTPUT jack is not turned off even if headphones are connected to the Headphone jack.

Connecting a damper pedal, foot switch, or foot pedal

If you connect an optional damper pedal, foot switch, or foot pedal to the KROME, you'll be able to control the KROME using your feet.

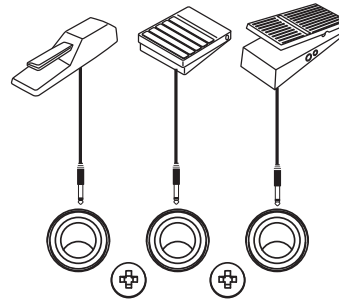

DAMPER SWITCH PEDAL
ASSIGNABLE

Connecting a damper pedal

When you press the damper pedal, the notes you've pressed will be sustained so that they will continue even after you take your hands off the keyboard. This is also called a sustain pedal; it has the same function as the damper pedal of an acoustic piano.

If the optional Korg DS-1H damper is connected, you'll be able to take advantage of the "half-damper" effect, where the depth that you press the pedal will vary the damper amount. If any other type of pedal is connected, it will function as a damper switch.

In Combination or Sequencer mode, you can also select settings so that the damper will apply to some sounds but not to other sounds.

1. **Connect a Korg DS-1H damper pedal to the ASSIGNABLE PEDAL/SWI/DAMPER jack.**
2. **Depending on which assignable jack you have connected the pedal to, set the controller type (Type) to Damper, and set the Polarity as appropriate (see page 202 of the Parameter Guide).**

Note: The half-damper sensitivity is adjusted to a standard value when the KROME is shipped from the factory. If the half-damper pedal you're using does not respond appropriately, please adjust the sensitivity (see page 217 of the Parameter Guide).

Connecting a foot switch

This lets you use a simple foot switch, such as the Korg PS-1 or PS-3, as an assignable controller. The foot switch can perform a wide variety of functions, such as:

- An assignable source for modulating sounds and effects
- Portamento on/off
- Program select up or down
- Sequencer start/stop or punch in/out
- Tap Tempo

- Arpeggiator on/off
- Switch the Drum Track on/off
- Use various KROME controls (realtime control knobs, joystick, SW1/SW2, etc.)

This button will always function in the same way regardless of the Program, Combination, or Song you've selected. You can assign the function in the Global mode.

Using a foot switch to select Programs

You can select programs by using a foot switch connected to the ASSIGNABLE SWITCH jack. By assigning the appropriate function, you can increment or decrement the program number in steps of one.

This lets you change Programs without using your hands—great for quick Program changes in live performance situations.

There are two ways of doing this: by assigning the foot switch to Program Up/Down, or to Value Inc/Dec. Each of these is suited to a particular application, as described below.

- Prog Up/Down: When performing in the normal P0 screen
- VALUE Inc/Dec: When performing while a list such as the Category/Program Select menu is open

Assigning the foot switch to Program Up/Down

Assigning the foot switch to Program Up or Program Down lets you directly control Program changes from the foot switch. For most situations, this is the more straightforward method.

To set this up:

1. **Connect a foot switch to the rear-panel ASSIGNABLE SWITCH input.**

Use an optional PS-1 pedal switch.

2. **Access the Global P2: Controllers– Foot Controllers page.**

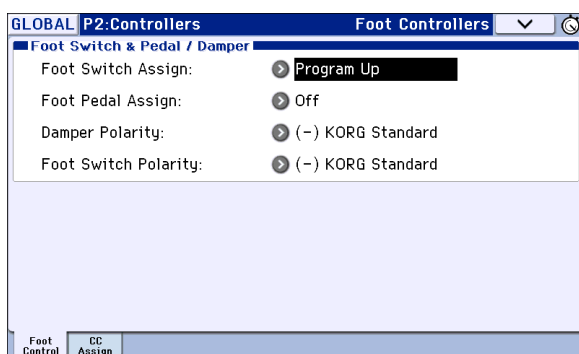

Proceed as follows.

Press the GLOBAL button to enter Global mode.

Press the PAGE button to access the GLOBAL Page Select. Press P2 Controllers, then press the Foot Control tab in the display.

3. **Set “Foot Switch Assign” to either Program Up or Program Down.**

If you choose Program Up, the next program number up will be selected each time you press the foot switch.

If you choose Program Down, the next program number down will be selected each time you press the foot switch.

4. **Set the “Foot Switch Polarity” to match the polarity of the pedal you’ve connected.**

If you’ve connected the optional PS-1 or PS-3 pedal, choose (–) KORG Standard.

Now, the foot switch will step through the Programs, one by one.

5. **If you want to preserve this setting even when the power is turned off, be sure to Write the data. (See page 116)**
6. **Press the PROG button to enter Prog P0: Play, and press the foot switch to change the Program.**

Note: This setting applies to selecting Combinations, as well.

Note: With the Program Up/Down method, you won't be able to select programs while the Bank/Program Select or Category/Program Select menus are open. Use the “Assigning the foot switch to Value Inc/Dec” method described below.

Assigning the foot switch to Value Inc/Dec

This lets you use the Assignable Foot Switch to duplicate the functions of the front-panel INC or DEC buttons.

This method is convenient if you want to open the Bank/Program Select menu or the Category/Program Select menu and switch programs while viewing the program or combination menu.

1. **Follow steps 1–2 under “Assigning the foot switch to Program Up/Down,” above.**
2. **At the top of the page, set the Foot Switch Assign parameter to Value Inc (or Value Dec).**
3. **Now, the foot switch will act just like you’re pressing the front-panel INC or DEC buttons.**

Note: The foot switch will work like this for the entire KROME—not just when the Bank/Program select menu or Category/Program Select menu is open.

Connecting a foot pedal

If you connect an optional EXP-2 foot controller or XVP-10 expression/volume pedal to the ASSIGNABLE PEDAL jack, you can use it to apply modulation to sounds or effects, or to adjust the overall volume.

This pedal will always function in the same way regardless of the Program, Combination, or Song you've selected. You can assign the function in the Global mode.

Like the Assignable Foot Switch, described above, the Foot Pedal can be used for many different functions, including:

- Master Volume
- Channel Volume, Pan, or Expression
- Assignable sound modulation, as several different AMS or Dmod sources
- Effects Send level control
- Use various KROME controls (realtime control knobs, Joystick, SW1/SW2, etc.)

1. **Connect an optional XVP-10 or EXP-2 to the ASSIGNABLE PEDAL jacks.**
2. **After turning the power on, use Global P2: Controllers– Foot Controllers page “Foot Pedal Assign” to assign the function controlled by the foot pedal. (See page 111, and pages 202, 350 of the Parameter Guide)**

Connecting the KROME to a computer

USB connection

The KROME provides both MIDI and USB connectors as standard equipment. By connecting the KROME to your computer via USB, you can use it as a controller and MIDI sound module for your DAW software with single cable convenience; and with out the need for a MIDI interface.

By using the dedicated editor, you can edit some of the parameters of the KROME from your computer as though it were a software plug-in.

Note: The USB connector of the KROME is only able to transmit and receive MIDI data.

⚠ Before you connect the KROME to your computer via USB, you must install the KORG USB-MIDI driver on your computer.

Connecting via the MIDI connectors

You can connect the KROME to your computer via MIDI by using a commercially available MIDI interface.

Note: For more about MIDI interfaces, refer to the owner's manual of the MIDI interface you're using.

⚠ Some USB-MIDI interfaces may be unable to transmit or receive the KROME's MIDI exclusive messages.

Connecting MIDI devices

By connecting the KROME's MIDI connectors to an external MIDI device you can transfer sound settings and performance data such as note messages between your external MIDI device and the KROME.

About MIDI

MIDI stands for Musical Instrument Digital Interface, and is a world-wide standard for exchanging various types of musical data between electronic musical instruments and computers. When MIDI cables are used to connect two or more MIDI devices, performance data can be exchanged between the devices, even if they were made by different manufacturers.

Controlling an external MIDI tone generator from KROME

If you want to use the KROME's keyboard, chord trigger switches and other controllers, sequencer, and arpeggiator to play or control an external MIDI sound module, use a MIDI cable to connect the KROME's MIDI OUT connector to the MIDI IN connector of your external MIDI sound module.

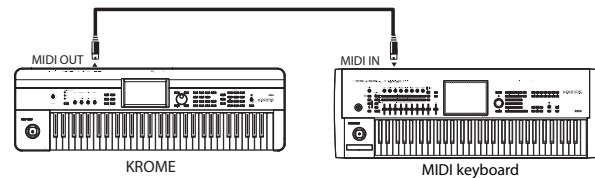

Controlling KROME's tone generator from an external MIDI device

When you wish to play or control the KROME's tone generator from an external MIDI keyboard or sequencer etc., use a MIDI cable to connect the MIDI OUT connector of the external MIDI device to the MIDI IN connector of KROME.

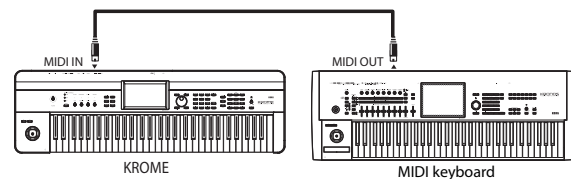

Controlling two or more external MIDI tone generators from KROME

You can also use a MIDI patch bay to control multiple MIDI devices.

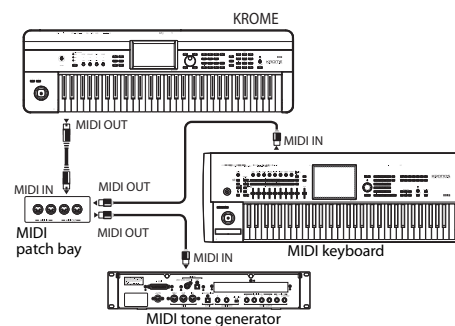

Playing and editing Programs

About the KROME's Programs

Programs are the basic sounds of the KROME.

You can play them by themselves, layer them together in Combinations, or play a different Program on each of the 16 MIDI tracks, either from the internal sequencer or from external computer-based sequencers.

This section of the manual takes a quick look at playing Programs, including tours of the front-panel controllers and basic editing techniques.

Playing Programs

Selecting Programs

There are several different ways to select Programs. Each one is convenient in a different way:

- Using "Program Select" and the VALUE controllers:
- Using the Bank/Program Select menu:
- Using the Category/Program Select menu:
- Find
- Using a foot switch: page 19
- MIDI program change messages let you select Programs remotely, from either a MIDI sequencer or an external MIDI controller

For details, please see below.

Selecting a program using "Program Select" and the VALUE controllers

1. Press the PROG button. (The LED will light up.) (Refer to the illustration below for the buttons.)

Alternatively, you can use the mode button (see "Selecting modes" on page 9).

The KROME will enter Program mode.

2. Access the Prog P0: Play– Main page.

This is shown in the top line of the display.

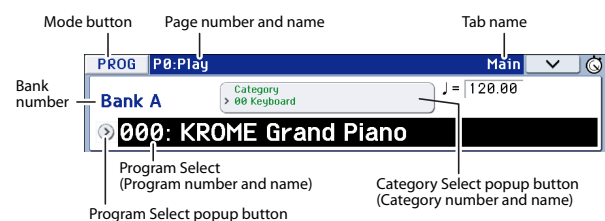

If a different page is shown, press the EXIT button a few times to return to the Prog P0: Play– Main page.

3. Make sure that "Program Select" is selected.

If it's not selected, press "Program Select" in the display or press the EXIT button to highlight the indication.

4. Select the program you want to play.

You can use the following methods to select a program.

- Use the INC or DEC buttons.
- Turn the VALUE dial.
- Use numeric keys 0–9 to enter the program number, and press the ENTER button.

5. Press one of the PROG BANK A–F buttons to select a bank.

When you select a different Bank, the button's LED will light up, and the selected bank will appear on the left side of the display.

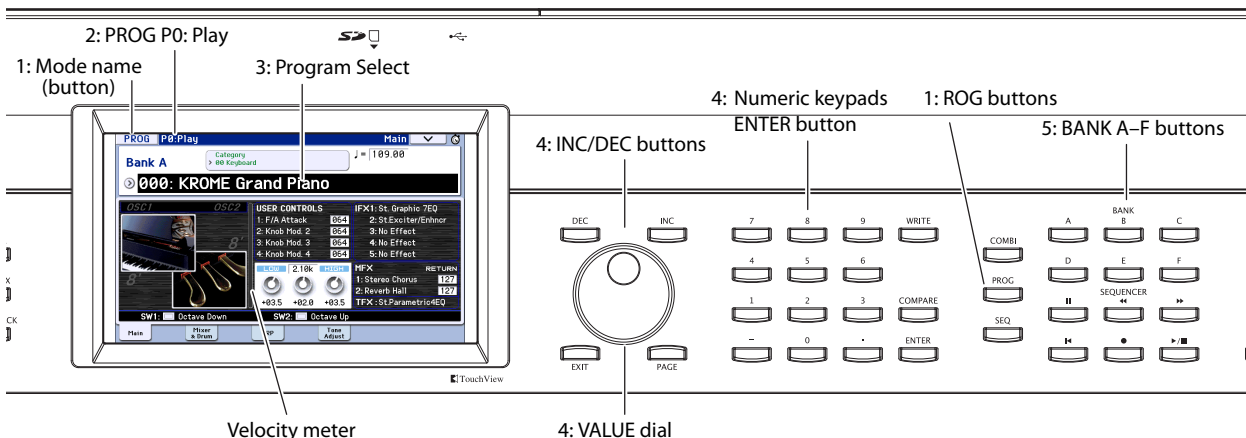

For example, to select bank B, press the PROG BANK B button. The B button will light up, and the name Bank B will appear on the left side of the display.

- **To select a GM bank**, you'll use the numeric keys.
 GM: Hold down 0 and press -.
 g(1)–g(9): Hold down 0 and press the desired number 1–9. For banks that do not have variation sounds, the basic GM sounds will be recalled. (An "*" will be appended to the beginning of the program name.)
 g(d): Hold down 0 and press (.

Auditioning the sound

Play the keyboard to audition the program you've selected.

The velocity meter shows the note-on velocity.

- This shows the velocity value of note-on events for the global MIDI channel, such as the keyboard, MIDI IN, and arpeggiator. (If multiple note-on events are received simultaneously, the highest velocity value is shown.)
- Since this shows the note-on velocity values, it will not be affected by the settings of the volume knob or by changes in the audio signal level.

Overview: Program Banks

As program banks, the KROME provides the six banks A–F and the GM banks (GM–g(d)). With the factory settings, the KROME has 640 preload programs in banks A–E. Bank F contains only initialized programs. Programs you've created should be stored in this bank.

With the exception of the GM–g(d) banks, you are free to save by overwriting these program memory areas. You can also save these programs on an SD card.

Programs are organized into six banks as shown in the following table.

Program bank contents

Bank	Prog. No.	Explanation	
A...E	000...127	Factory Programs.	With the factory settings, these banks contain a wide variety of preloaded programs that use the internal multisamples, effects, and arpeggiator.
F	000...127	Initialized Programs.	Use these to create a program from scratch.
GM	001...128	GM2 main programs.	These banks contain 256 GM programs and nine GM drum programs that are compatible with the GM2 sound map. The programs of these banks are read-only.
g(1)...g(9)	001...128	GM2 variation programs.	Bank GM contains the GM programs. GM lets you select 128 programs numbered from 001–128, and g(1)–g(d) lets you select nine drum programs. You can't write (save) data to these banks.
g(d)	001...128	GM2 drum programs.	

Selecting by Bank/Program Select menu

You can select Programs from a menu organized by Program bank.

1. Press the Program Select popup button.

The Bank/Program Select menu appears.

Bank/Program Select menu

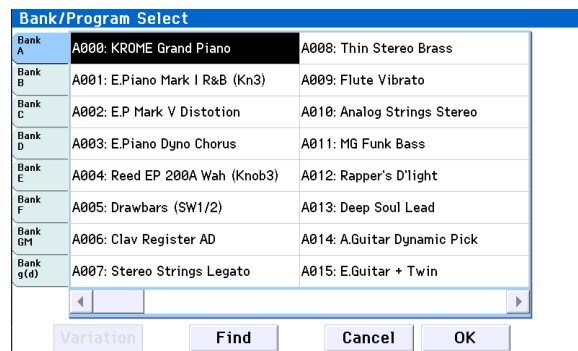

In this illustration, Bank A is selected. The menu displays the Programs contained in that bank.

2. Press the tabs on the left side of the display to select banks.

3. Press one of the program names in the center area to select a program.

The selected program will be highlighted, and the program will change.

Alternatively, you can use the INC/DEC buttons to switch programs.

Play the keyboard or press the chord trigger buttons to hear the program you selected.

4. If you selected Bank GM, the Variation button is shown.

By repeatedly pressing this Variation button, you can successively step through the banks, allowing you to recall a GM2 sound set (see "To select a GM bank" on page 22).

5. When you are satisfied with the selected Program, press the OK button to close the menu.

If instead you press the Cancel button, the selection you made here will be discarded, and you will return to the program that had been selected before you opened the menu.

Find

Here's how to search for a program by a portion of its name.

1. Access the Bank/Program Select menu or the Category/Program Select menu, etc.
2. Press a tab to select the bank or category that you want to search.

Note: The programs included in the selected tab will be the subject of the search.

3. On the lower left side, press the Find button to access the dialog box.

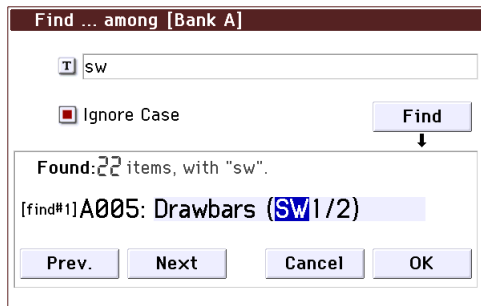

4. Press the "T" button to access the text dialog box.

Enter the alphanumeric characters that you want to find, and press the OK button. For example if you want to find programs that take effective advantage of SW1 or SW2, enter "sw".

5. If you select the "Ignore Case" check box, uppercase and lowercase characters will not be distinguished in the search.

6. Press the Find button to begin searching.

Search results are shown in "Found."

If one or more items are found, the number of items and the first found program will be displayed.

Press the Prev. button or Next button to find the previous or next program. This will cycle through the found items within the tab.

You can play the keyboard to audition the program that was found.

If no items are found, the display will indicate "nothing."

7. If you are satisfied with the selected program, press the OK button to close the menu.

The selected program will be selected in the menu you selected in step 1. If you are satisfied with the selected program, press the OK button to close the menu.

If you want to search for a different program, or if no items were found, press the Cancel button.

8. Press the tab that you want to select next, and search as described in steps 3–7.

If you press the Cancel button, this selection will be discarded, and you will return to the program that had been selected prior to opening the menu.

Selecting by Category/Program Select menu

You can select Programs from within a category, such as keyboard, organ, bass, and drums.

When shipped from the factory, the preloaded Programs are organized into 16 categories, each with several sub-categories.

1. Press the Category Select popup button.

The Category/Program Select menu appears.

Category/Program Select menu

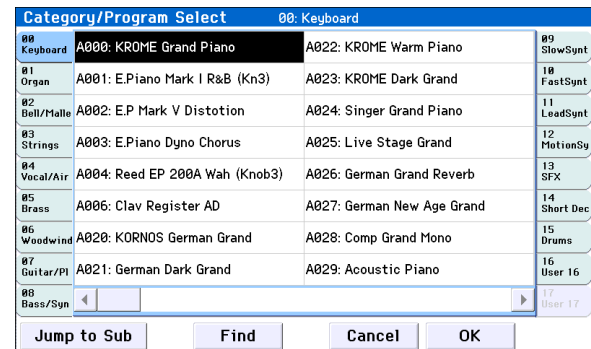

In the illustration above, the Keyboard category is selected. The menu in the center column area shows the Programs which belong to that category.

2. Press the tabs to the left and right of the display to select a different category.

The name of the selected category will be displayed in full in the top right-hand corner.

3. Press one of the program names in the center area to select a program.

The selected program will be highlighted, and the program will change.

Alternatively, you can use the INC/DEC buttons to switch programs. Touch the scroll ribbon at the bottom of the screen to see all of the Programs in that category.

Play the keyboard or press a chord trigger button to hear the program you selected.

4. If you want to select from a sub-category, press the Jump to Sub button to access the Sub Category/Program Select menu.

Press the left tabs to select a sub-category.

Note: You can't select tabs for a sub-category that has no associated programs.

Select a program as described in step 3 above.

Press the OK button to confirm your selection, or press the Cancel button to discard it. You will return to the main category.

5. When you are satisfied with the selected program, press the OK button to close the menu.

If instead you press the Cancel button, your selection will be discarded, and you will return to the program that had been selected when you opened the popup menu.

Program information

In the Prog P0: Play- Main page you can view the following information about the selected program.

OSC Picture: This is a graphic that represents the program's oscillator.

OSC Oct: For a double oscillator or double drums, this indicates "Oct" (the basic pitch of the oscillator).

SW1, SW2: This indicates the function that's assigned to the SW1/SW2 buttons, and the on/off state of the buttons.

Realtime Controls – TONE CONTROLS/USER CONTROLS/ARP CONTROLS:

This shows information about the functions of the REALTIME CONTROLS knob that's currently selected. Use the SELECT button to choose the functions that will be controlled by the knobs. For more information about these functions, please see page 28.

EQ (Low, Mid[Hz], Mid, High): This shows the 3-band EQ settings. You can use the value controllers to edit the values.

Effect Controls– IFX, MFX, TFX:

This shows the effects that are assigned. The KROME provides insert effects 1–5, master effects 1 and 2, and a total effect. For the master effects, you can edit the return levels.

Velocity Meter:

This meter shows the note-on velocity value.

The meter shows the note-on velocity of the keyboard, MIDI IN, and arpeggiator etc. (If multiple note-on messages are received simultaneously, the highest velocity value is shown.)

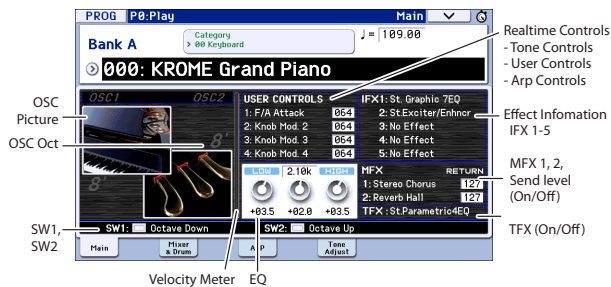

Using Controllers

In addition to using the keyboard, the KROME lets you control the sound by using the joystick, SW1 and SW2 buttons, knobs 1–4, damper pedal, and foot switch or foot pedal.

These controls let you modify the tone, pitch, volume, effects, etc. in realtime as you play.

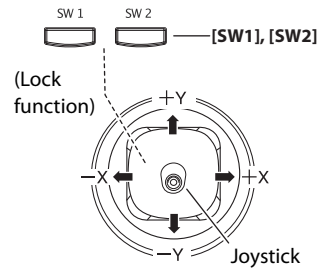

Joystick

The joystick moves in four directions: left, right, up (away from yourself), and down (towards yourself). Each of the four directions can be used to control a different function, such as modulating Program or effects parameters. These assignments can be different for every Program, but generally, they do the following:

Standard Joystick functions

Move the joystick...	Controller Name	Normally controls...
Left	JS-X	Pitch bend down
Right	JS+X	Pitch bend up
Up (away from yourself)	JS+Y	Vibrato
Down (towards yourself)	JS-Y	Filter LFO (wah)

For details, please see page 82.

Joystick Lock

This function lets you maintain the effect that had been applied prior to releasing your hand from the joystick.

You can use the SW1/SW2 buttons or a foot switch connected to the KROME to lock the current position so that the effect will continue even after the joystick returns to the center position. For details, please see "Locking the Joystick" on page 25.

SW1, SW2

You can use these buttons to control program parameters via AMS (Alternate Modulation), or effect parameters via Dmod (Dynamic Modulation).

They can also transpose the keyboard by octaves, turn portamento on/off, or to lock the position joystick.

Each button can work as either a **Toggle** or **Momentary** button. In **Toggle** mode, the assigned function is switched between on and off each time the button is pressed. In **Momentary** mode, the assigned function is active on only as long as you hold down the button.

In Program mode, you can check the assignments of SW1 and SW2 on the Prog P0: Play- Main page.

For details, please see "Program information" on page 24.

When you write a Program or Combination, the on/off status of the SW1 and SW2 buttons is saved.

For details, please see page 82.

Locking the Joystick

1. Using the standard factory sounds, select Program C027: Semi Distortion Guitar.

To select a program, make sure that you are in Program mode, and press the PROG BANK C button, numeric key 2, 7, and then the ENTER button.

2. While holding down a key, move the joystick in the -Y direction (toward yourself).

The tremolo effect will deepen.

3. While keeping the joystick in the -Y direction (toward yourself), press the SW2 button. (The SW2 button LED will light up.)

When you press the button, its LED will light up, and the modulation effect at this point will be maintained.

4. Release the joystick, and play the keyboard.

The modulation will stay the same as it was when SW2 was pressed. Even if you move the joystick toward yourself, the sound will not change.

5. Press the SW2 button once again to release the Lock function.

Keyboard

The KROME's keyboard provides the following two types of control.

Velocity

Velocity is a measure of how hard you play a note on the keyboard. This can be used to modulate many different aspects of the sound, such as volume, brightness, or the character of the attack.

Note Number

Sounds can be programmed to change in character based on the note being played.





As you play higher or lower on the keyboard, the note number can modulate the timbre - such as becoming brighter as you play higher notes. Envelopes may also become faster or slower; the volume may change; and so on.

Realtime control knobs

The realtime controls consist of four knobs and the SELECT button. These controls function as follows.

- You can apply modulation to sounds or edit them.
- You can control the arpeggiator.

REALTIME CONTROLS

<input type="radio"/> TONE	CUTOFF	RESONANCE	EG INT	RELEASE
<input type="radio"/> USER	1	2	3	4
<input type="radio"/> ARP	GATE	VELOCITY	SWING	STEP
				

1. Press the SELECT button to select the realtime control function between TONE, USER, or ARP.

TONE, USER: Use the knobs to modify the sound or effects (see page 28).

ARP: Use the knobs to control the arpeggiator (see page 86).

You can freely switch between these functions without losing your current edits.

2. Use knobs 1-4 to control the selected functions.

When you turn one of these knobs, that knob's function and value will appear in a popup.

(You can prevent this popup from appearing. See page 111.)

 There will be a slight amount of play when turning the knob near its minimum or maximum positions.

TEMPO knob and TAP button

This adjusts the tempo for the KROME as a whole, including:

- Arpeggiator
- Drum Track
- Songs in Sequencer mode
- Tempo-synced LFOs
- Tempo-synced ("BPM") delay effects

TEMPO LED

The LED will blink at quarter-note intervals of the current tempo.

TEMPO knob

This knob adjusts the tempo. It's a convenient way to make continuous adjustments.

Note: If the Global P1: MIDI-MIDI Basic page **MIDI Clock** parameter is set to External MIDI, External USB, or if it is set to **Auto** and a clock is currently being received via MIDI, then neither the TEMPO knob nor the TAP button will have any effect.

TAP button

You can set the tempo of the Arpeggiator or Drum Track function in Program, Combination, and Sequencer modes by lightly pressing or tapping the TAP button several times on the beat. In Sequencer mode, you can control the song tempo in this way.

To enter the tempo, use your finger to gently tap the TAP button. The tempo will be entered when you press the button twice, but you should tap several times in order to increase the precision. The average of the last sixteen taps will be specified as the tempo.

During playback, lightly press the TAP button several times at the desired tempo. The tempo will follow your tapping in realtime. This is a convenient way to match the tempo in realtime to the beat of a different source.

 You can use tap tempo control whenever the TEMPO knob can be used. For example in Sequencer mode, tap tempo control will not be available if you are playing a song where the **Tempo Mode** setting is set to Auto. (See page 110 of the Parameter Guide)

Note: You can also use a foot switch connected to the ASSIGNABLE FOOT SWITCH jack to control the tap

tempo function (see page 18, and pages 202, 349 of the Parameter Guide).

Damper pedal / Foot switch / Foot pedal

For details on using the damper pedal, foot switch, or pedal to control the sound, please see "Connecting a damper pedal, foot switch, or foot pedal" on page 18.

Performing with the arpeggiator or drum track

Based on note data that it receives from the keyboard or from the MIDI IN connector, the arpeggiator can generate a wide range of phrases and patterns including arpeggios, guitar or keyboard backing riffs, bass phrases, or drum patterns. By setting SELECT to ARP and using the knobs, you can vary the duration and strength of the arpeggiated notes.

For more about the arpeggiator, please see page 85.

The drum track uses a rich variety of drum patterns to play the KROME's high-quality drum programs. You can select any program and play along with the drum patterns.

Of course you can also synchronize the arpeggiator and the drum track patterns and use them together.

For more about the drum track, please see page 97.

Easy Program editing

The fastest way to create the sound you need is to start from a preload program that's close to what you have in mind, and edit that program.

Simple editing can be done within the various pages of P0: Play where you perform. You can adjust the EQ and volume level, and in the Tone Adjust page you can use the sliders and buttons to perform various useful edits. You can also use the front panel realtime controls to intuitively adjust the cutoff, resonance, and release time.

If you want to do detailed editing, use the editing pages P1 and following.

Adjusting the EQ

You can adjust a mid-sweepable three-band EQ in the Prog P0: Play- Main page.

Note: This EQ will affect both oscillator 1 and oscillator 2.

1. Access the Prog P0: Play- Main page.
2. On the display, select the EQ gain knob or the center frequency of the Mid sweep EQ that you want to edit.
3. Use the VALUE controllers (e.g., VALUE dial) to edit the value.

You can also edit the value by dragging left or right on a knob or edit cell in the display.

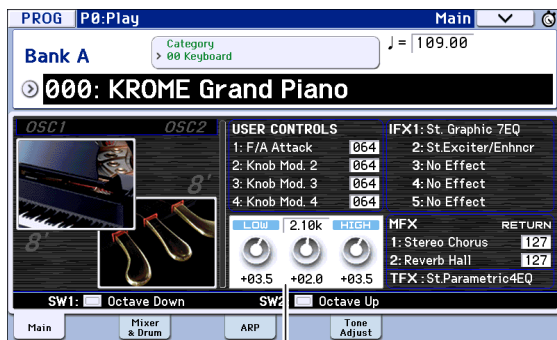

EQ

Adjusting the volume balance

A program's sound consists of up to two "oscillators" which are played mainly from the keyboard, and one "drum track" which automatically plays the rhythm section.

The volumes of the oscillators and the drum track can be adjusted in the Prog P0: Play- Mixer & Drum Track page.

Note: There's also a "mute function" which individually silences these, and a "solo function" which mutes all sounds other than the specified one.

1. Access the Prog P0: Play- Mixer & Drum Track page.

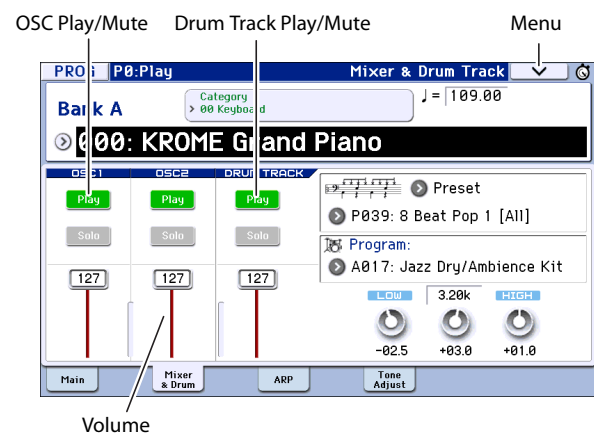

Volume

2. Select a slider in the display, and use the VALUE dial etc. to adjust the volume of oscillators 1 and 2 and the drum track.

For oscillators that use two drum kits, you can use the OSC1 and OSC2 sliders to adjust the direct sound of the close-miced drum kit and the ambient sound of the drum kit captured with more space.

Note: With single-oscillator programs, you won't be able to control oscillator 2.

3. You can press the Play/Mute button in the display to toggle the Play/Mute status of oscillators 1 and 2 and the drum track.
4. You can press the Solo button in the display to toggle the Solo On/Off status of oscillators 1 and 2 and the drum track.

The function of the Solo button will switch each time you select "Exclusive Solo" in the menu (see page 64 of the Parameter Guide).

Using realtime controls to edit the sound or effects

You can use the realtime controls (the SELECT button and knobs 1-4) to modify the sound and control the arpeggiator.

1. Press the REALTIME CONTROLS SELECT button to switch the realtime control function between TONE, USER, or ARP.

Each time you press the button, you'll cycle through A, B, and C modes, and the corresponding LED will light up.

Note: If CC#70-79 are assigned to REALTIME CONTROLS A mode and B mode, the sound that you edit using knobs 1-4 will be saved when you write the program. Arpeggiator settings you adjust in C mode will also be saved.

2. Modify the sound by turning the knob that you want to control. See below for details.

TONE controls

In TONE section you can turn knobs 1-4 to control or edit the following items.

Note: When a knob is in the center position (12 o'clock), the parameter will have the value specified by the program.

Knob 1: CUTOFF

This adjusts the filter's cutoff frequency. Adjusting the cutoff frequency will modify the brightness of the sound.

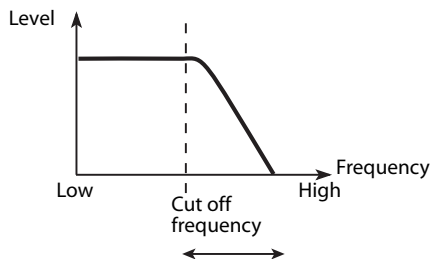

Knob 2: RESONANCE

This adjusts the filter's resonance level.

Adjusting the filter resonance level will boost the sound in the region of the frequency, giving a distinctive character to the sound.

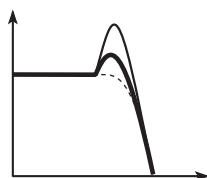

Knob 3: EG INT

This adjusts the filter EG intensity (the depth of how the EG affects the filter).

Using the knob will change the amount of how the filter is affected by the EG. Normally, turning the knob toward the left will make the filter EG shallower, and turning the knob toward the right will make it deeper. Since the filter EG operates relative to the filter cutoff frequency, both knobs 1 and 3 will control the tonal change produced by the filter.

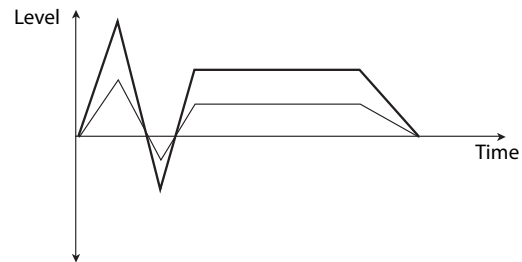

Knob 4: RELEASE

This adjusts the filter and amp EG release time, changing the time from note-off until the sound is no longer heard.

Turning the knob will change the release time of the filter EG and the amp EG. Normally, turning the knob toward the left will shorten the release time, and turning the knob toward the right will lengthen it.

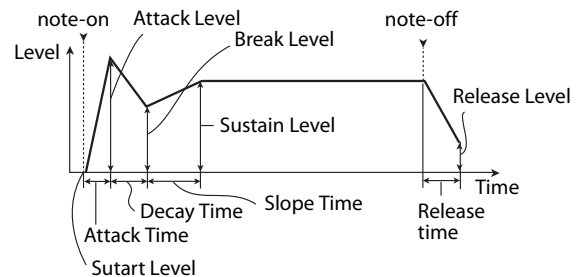

Example:

1. Select program "Category: KEYBOARD A066: Dark R&B Piano.

This is an electric piano sound. Let's try modifying the sound a little.

2. Press the REALTIME CONTROLS SELECT button to select TONE (the LED will light-up).
3. While you play, slowly turn knob 1 (filter frequency) about 3/4 toward the right.

The piano sound will become more like a synth sweep.

4. Next, turn knob 2 (filter resonance) about 3/4 toward the right as well.
5. Leave knob 2 in its position, and try turning knob 1 to the left and right.

Raising the resonance will change the sound as though you were playing through a wah pedal.

USER controls

In the USER section you can turn knobs 1–4 to control various aspects of the sound such as volume, portamento time, pan, filter and amp EG, pitch LFO, and master effect send level.

In USER, the most useful functions are assigned individually for each preload program.

The table below shows the standard assignments of the Realtime Controls knobs:

Knob	MIDI CC	Normally controls...
TONE1	74	Filter Cutoff Frequency
TONE2	71	Filter Resonance
TONE3	79	Filter EG Intensity
TONE4	72	EG Release Time
USER1, 2	Varies for each Program	
USER3	Often Chorus Depth - but can vary per Program	
USER4	Often Reverb Depth - but can vary per Program	

For details, please see page 16 of the Parameter Guide.

ARP controls

In the ARP section you can control the arpeggiator in realtime.

For details on functionality, please see page 86.

Saving the edits you made by moving the knobs

The realtime control knobs are an ideal way to modify the sound while you perform. As needed, press the front panel WRITE button to Write the Program into memory and save the sound you've edited. (See "Saving your edits" on page 30.)

 However for Realtime Controls USER knobs 1–4, the edited settings can be saved only if you've assigned CC#70–79.

Internally, a single knob usually affects several different parameters. When you write a Program, the edits are saved into the individual program parameters, and not to the knob itself.

After writing the Program, you'll notice that the knobs have returned to their center positions—since the old "edited" values are now the new "saved" values.

Assigning Realtime Controls USER functions to knobs 1–4

You can assign the functions that knobs 1–4 will perform when Realtime Controls USER is selected. (See page 41)

Using Tone Adjust

The Tone Adjust function lets you edit the parameters of the program. The program parameters that are most effective for editing will be assigned to the controllers in the display.

1. Access the Prog P0: Play– Tone Adjust page.

This page shows and reflects data generated by the tone adjust function, letting you view the parameter assignments and their precise values.

2. To edit the sound, select a slider (1–8) or button (1–8) in the display, and use the VALUE dial etc. to use it. (You can edit the value of a slider by dragging it in the display.)

Note: You can assign the principal program parameters to the various controllers in the display. For details, please see page 7 of the Parameter Guide.

For example:

1. Select Program A069, "Deluxe E.Piano."

2. Access the P0: Play– Tone Adjust page.

3. Look at the assignments for sliders 5, 6, and 8 in the display.

Slider 5 is assigned to F/A EG Attack Time; slider 6 is assigned to F/A EG Decay Time; and slider 8 is assigned to F/A EG Release Time.

4. Raise each of the three sliders so that they are about 4/5 of the way to the top.

The display should show their values as between +60 and +70. This means that you have edited the filter EG and amp EG attack, delay, and release to longer values.

5. Play a few notes.

Notice that the sound has changed from an electric piano into a soft pad. Next, let's add just a bit of filter modulation, to make the sound more rich.

6. Notice the assignment of slider 2 in the display.

Slider 2 is assigned to "[OSC1] Filter LFO1 Int A" (OSC1 filter LFO1 intensity). It will adjust the amount of filter modulation produced by LFO1.

7. Lower slider 2 slightly so that the display indicates about –6.

8. Play a few more notes.

The filter modulation has added some shimmer to the sound. Now, maybe it could use a bit more edge...

9. Look at the assignments for switches 6 and 7 in the display.

These are programmed to raise the **Filter Cutoff** and **Filter Resonance**, respectively. Switches are just on/off, but you can set a specific value for the **On** position; notice the +10 and +40 in the switch's value boxes.

10. Press each of the two switch buttons.

The sound now has a more interesting character, due to the filters. Since it's brighter, we've also restored some of the electric piano character.

Pretty easy, huh? Note: depending on the parameter, you may occasionally hear glitches in the sound as you move the control.

Changing parameter assignments

The factory Programs include default assignments of Tone Adjust parameters to the sliders, and buttons in the display. If you like, you can change any of the assignments. To do so:

1. Access the Prog P0: Play– Tone Adjust page.
2. Press the popup button located to the left of the assigned parameter.

A popup window will appear, with a long menu of parameters. You can tell various things about the selections, just from the way they appear in the menu:

Parameters which affect only OSC1 or OSC2 are prefixed with [OSC1] and [OSC2], respectively.

Parameters which affect both Oscillators, but which are specific to Programs, are prefixed with [OSC1&2].

The other group of parameters at the beginning of the list, are “Common.” That is, you can use them with most Programs.

Parameters can only be assigned to one Tone Adjust control at a time. If a parameter is already assigned, it’s grayed out.

3. Select a parameter from the menu.

The parameter is now assigned to the control. To close the list without making any changes, press a location in the display outside the popup window, or press the EXIT button.

Comparing the unedited sound

Using COMPARE

When you’re in the process of editing a sound, pressing the COMPARE button will recall the last saved version of the sound, as it was before you started editing.

For details, please see “Compare function” on page 11.

Saving your edits

After you’ve edited a program, you must save it if you want to keep the changes you’ve made. If you re-select the program or turn off the power after editing, your edits will be lost.

1. Press the WRITE button.

The Write Program dialog box will appear. If you want to modify the writing-destination or name, you can do so (see page 117).

2. Press the WRITE button once again to save (write) the program.

For details, please see “Writing a Program or Combination” on page 115.

You can also save programs on an SD card as PCG files. For details, please see “Saving to SD card (Media-Save)” on page 118.

Detailed Editing with Programs

You can create original sounds by editing a preloaded program or by editing an initialized program. The programs you create can be saved in banks A–F. For details, please see “Saving your edits” on page 30.

Before you start editing

The three elements of sound: pitch, tone, and volume

Sound is made up of three basic elements: pitch, tone, and volume.

The KROME provides “pitch,” “filter,” and “amp (amplifier)” sections that allow you to control these elements.

The “pitch” section modifies the pitch, the “filter” section modifies the tone, and the “amp” section modifies the volume.

You’ll edit “pitch” settings in P2: OSC/Pitch (P2-3) and OSC2 Pitch, “filter” settings in P3: Filter (P3-1–3), and “amp” settings in P4: Amp/EQ (P4-1–2).

EG, LFO, AMS, and controllers

In addition to the three elements listed above, a sound can vary according to the passage of time, the pitch range in which it’s played, or by performance expressions.

Such aspects can be controlled by modulators and controllers such as the EG (envelope generator), LFO (low frequency oscillator), and joystick. These modulators and controllers apply change to the basic program.

Take a look at the illustration “Program structure” Notice that the signal flow is in the order of Oscillator/ Pitch, Filter, Amp. You can see how the EGs and LFOs affect each section.

As shown in the illustration, each program consists of sections such as OSC 1/2, effects, and the arpeggiator.

OSC (oscillator) 1/2

The OSC (oscillator) generates the waveform that is the basis of the sound. On the KROME, the oscillator consists of multiple sampled sounds such as a multisample or a drum kit (drumsamples).

The KROME provides two oscillators; OSC1 and OSC2. You can create more complex programs by combining these.

The OSC, which is the basis of the sound, can be controlled by modulating its pitch, filter, amp, EG, and LFO to change the sound in a wide range of ways.

Note: Pitch EG is shared by OSC1 and OSC2.

Effects

As effects, you can use five insert effects, two master effects, and one total effect.

The output of OSC 1/2 is sent to these effect processors. By choosing the desired effect for each processor and editing its parameters, you can apply a wide range of effects such as modulation, distortion, and reverberation.

Arpeggiator

A program can use one arpeggiator. You can select an arpeggio pattern, specify the range that the pattern will be developed within, and specify the range of notes or velocities that will trigger the arpeggiator.

Program structure

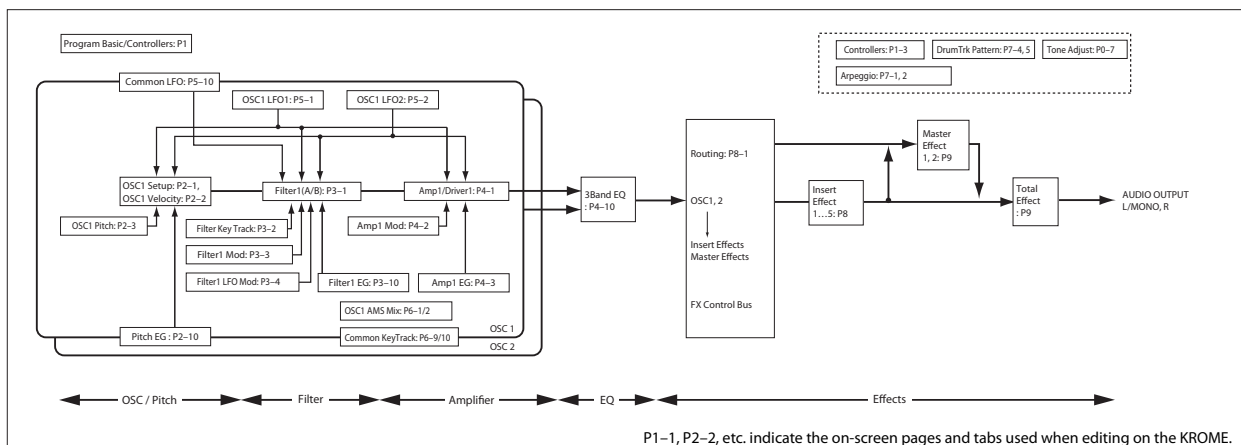

An overview of the edit pages

In order to do detailed editing, you'll need to access the edit pages in the display.

The preceding section "Easy Program editing" on page 27 explained how to use the Prog P0: Play page to do simple editing. For more detailed editing, you'll use the P1 and following edit pages.

	Page	Main content
PLAY	P0: Play	Select and play programs. (see page 21) Oscillator and Drum track level settings. (see page 27) Simple drum track editing. (see page 98) Simple arpeggiator editing. (see page 86) Tone Adjust settings. (see page 29)
EDIT	P1: Basic/Controllers	Basic program settings, such as Oscillator mode. (see page 32) SW1, 2, and knob settings. (see page 41)
	P2: OSC/Pitch	Oscillator selection and pitch settings. (see page 33)
	P3: Filter	Filter 1, 2 (tone) settings. (see page 38)
	P4: Amp/EQ	Amp 1, 2 (volume) settings. (see page 40) Amp 1, 2 driver and pan settings. 3-band parametric EQ settings.
	P5: LFO	LFO settings. (see page 35)
	P6: AMS/Common KeyTrack	AMS Mixer settings. (see page 36) Common keyboard tracking settings.
ARP/DT	P7: Arpeggiator/Drum Track	Arpeggiator settings. (see page 88) Drum track settings. (see page 100)
EFFECT	P8: Routing/IFX	Oscillator output bus and master effect send level settings. (see page 79) Insert effect routing, selection, and settings. (see page 79)
	P9: MFX/TFX/LFO	Master effect routing, selection, and settings. (see page 80) Total effect selection and settings. (see page 80)

For details on how to access each mode and page, please see "Basic operations" on page 9.

Basic oscillator settings

Here you can specify the type of program, select the basic waveform (multisample or drum kit), and specify whether it will play polyphonically or monophonically (poly/mono).

Program type setting (single, double, drum kit)

Here you can specify the program type.

Broadly speaking the program type will be either "a program that uses a multisample" or "a program that uses a drum kit" (see "Multisamples and Drum Kits" on page 33).

This choice is made by the Prog P1: Basic/Controllers-Program Basic "Oscillator Mode" setting, which specifies which type the oscillators will use. Up to two can be used simultaneously for each type.

- Multisample: Single, Double
- Drum kit: Drums, Double Drums

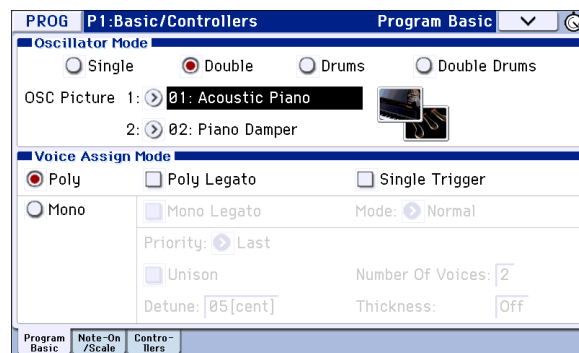

Single (single program) uses one oscillator, and **Double** (double program) uses two oscillators.

Drums (drum program) is similar to a single program, but uses a drum kit (created in Global mode) instead of a multisample. **Double Drums** (double drum program) uses two drum kits. By using an ambience-type kit as the second drum kit, you can give a wider sense of space to the sound.

Polyphony

Polyphony is the number of notes that can be played simultaneously, such as in a chord. The polyphony depends on the program type.

Program type	Polyphony
Single	120
Double	60
Drums	120
Double Drums	60

Note:

- Double Programs and Double Drums use twice as many voices as Single Programs.
- Stereo Multisamples use twice as many voices as Mono Multisamples.
- If using velocity crossfade switching, the multisample will use twice as many voices as usual.

Oscillator image setting

You can specify the program oscillator image that's shown in the P0: Play- Main page. Adjust this setting in Prog P1: Basic/Controllers- Program Basic Oscillator Mode "OSC Picture 1" and "2."

1. Press the "OSC Picture 1" or "2" popup button (>) or the image icon shown at right; the dialog box will appear.

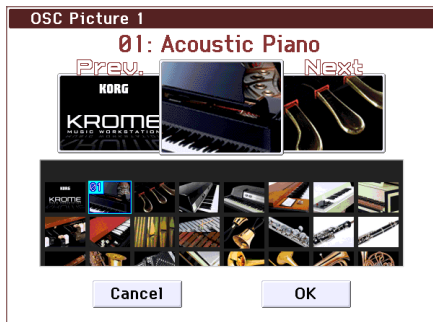

2. To select an image, press an image in the list in the lower part of the screen, or at the left or right in the upper part.
3. Press the OK button to confirm your choice.

Polyphonic/monophonic playing

The Voice Assign Mode selects whether the Program will play polyphonically (**Poly**) or monophonically (**Mono**).

When this is set to **Poly**, you can play both chords and melody lines. When this is set to **Mono**, only one note will sound even if you play a chord.

Normally you'll set this to **Poly**, but **Mono** is useful when playing sounds such as synth basses, synth leads, and other solo instruments.

Try switching between Poly and Mono, and listen to the results.

Working with Multisamples

What is a multisample?

A sample is a digital recording of a particular instrument or waveform (or other natural or artificially processed sound) recorded at a specific pitch. A multisample is a collection of similarly voiced samples, used to create the same type of sound - piano, bass, guitar, strings, organ - across the entire keyboard, as the basis of a program. The oscillators of single and double programs use multisamples. There are 583 multisamples available in this instrument.

You can assign up to four multisamples to each oscillator and switch between them by velocity.

Multisamples and Drum Kits

Multisamples and Drum Kits allow you to play samples in different ways.

- Multisamples lay out one or more samples across the keyboard. If we use the example of a simple guitar multisample, one sample could be assigned

for each string, so that the multisample would consist of six samples.

- As the name suggests, Drum Kits are optimized for playing drumsamples.

Velocity splits, crossfades, and layers

Each oscillator provides eight velocity zones. This lets you switch between multisamples or drumsamples according to the velocity (speed) at which you play a key.

By specifying the threshold (boundary value) where each zone will respond, and the amount of crossfading (the overlap between zones), you can specify how your keyboard playing dynamics will switch or layer the multisamples or drumsamples. You can use this to make the following types of setups.

- Velocity splits, where multisamples (or drumsamples) are cleanly switched at the threshold
- Velocity crossfades, where multisamples (or drumsamples) are smoothly crossfaded over a specified range outside the threshold
- Velocity layers, where two multisamples (or drumsamples) are layered when you play a specified range outside the threshold

Note: If "Oscillator Mode" is set to Drums or Double Drums, the velocity settings pre-specified for the drum kit will be used, and therefore will not be shown in the screen. The velocity zone settings of a drum kit can be edited in Global P5: Drum Kit (see page 105). You can jump automatically to Global P5 by pressing the Jump to DrumKit Edit button shown on the screen.

Selecting Multisamples

Let's create a simple velocity crossfade between two Multisamples, using just OSC1.

1. Access the Prog P2: OSC/Pitch- OSC1 Setup page.
2. Set the Multisample On/Off for multisample1 and multisample2 to On.

Set the **Multisample On/Off** for multisample3 and multisample4 to Off.



By dragging the slider to the left, you can select each multisample and view its settings.

3. Select Stereo as the Multisample Bank for multisample1 and multisample2.

There are two main types of Multisample Banks: **Mono**, and **Stereo**. Note that stereo Multisamples will require twice as many voices as mono Multisamples. Multisamples are organized by category such as piano, guitar, bell, etc.

- Press the Multisample popup button for multisample1.



Multisample popup button

This brings up a list of Multisamples, organized by category. Use the tabs on the left of the display to browse through the different categories.

- Select a Multisample by touching its name in the list. You can also use Find to search for a Multisample.
- Press the OK button to confirm your selection.
- Perform the same steps for multisample2, selecting a different Multisample than for multisample1.

Now that you've assigned Multisamples to multisample1 and multisample2, let's set up the velocity ranges and crossfades.

Multisamples have now been assigned to multisample 1 and 2.

- Specify the velocity range and crossfade range.

Press the Velocity tab to access the OSC1 Velocity page. Set the multisample 2 "Threshold Velocity" to 001, and turn "Crossfade" Off.

- Set the multisample 1 "Threshold Velocity" to 80.

You can also set "Threshold Velocity" by dragging the bottom edge of the line graph.

With these settings, Multisample2 will sound for notes played with a velocity of 79 or less, and Multisample1 will sound for notes played with a velocity of 80 or greater.

The Velocity Split meter shows the oscillator's eight multisamples and the velocity zones of each oscillator.

The meter on the left shows the note-on velocity. This lets you see which multisample and oscillator will sound for that specific velocity.

- Set the multisample 1 "Crossfade" to 20, and its "Curve" to Linear.

The state of this split is shown visually in the screen.

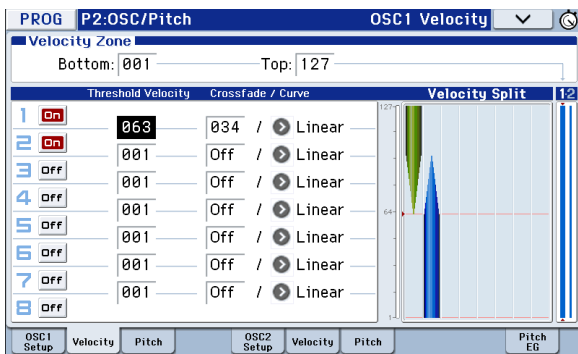

The two multisamples will fade across the range from 80 to 100, with multisample 2 fading-out while multisample 1 fades-in. This produces a smooth change without any sudden switch.

- As necessary, use the Prog P2: OSC/Pitch- OSC1 Setup page to adjust the "Level" of the two multisamples.

Assigning a drum kit

What is a drum kit?

Drum kits are created or edited in Global mode. For each note of the keyboard, you can assign up to eight drum instrument samples, and use layering, crossfading, or velocity switching to switch between them. Then, in Program mode, you can adjust filter and amp settings, and specify effects and routing to the audio output jacks. (See page 105)

To use a drum kit in a Program, set **Oscillator Mode** to Drums or Double Drums, and choose one of the 48 user drum kits or the nine GM2 drum kits.

Selecting a drum kit

- Access the Prog P1: Basic/Controllers- Program Basic page.
- Set "Oscillator Mode" to Drums or Double Drums.



- Select a drum kit in the Prog P2: OSC/Pitch- OSC1 Setup page.



- Specify the basic pitch of the oscillator. For a drum kit, set "Octave" to +0 [8].

Creating time-varying changes (LFO and EG)

Using LFOs

You can use the cyclic change produced by the LFO (Low Frequency Oscillator) to modulate numerous aspects of the sound.

Each Program has two LFOs: LFO1 and LFO2. There is also a single Common LFO, shared by both Oscillators. While LFO1 and LFO2 are separate for each voice, the Common LFO is shared by all voices in the Program. This makes it useful when you want all of the voices to have an identical LFO effect.

You can use these LFOs to modulate many different Program parameters, including:

- Pitch (for vibrato)
- Filters (for wah effects)
- Volume (for tremolo)
- Pan (for auto-panning)

The LFOs can modulate many other parameters, in addition to those listed above.

Using the basic LFO

1. Access the Prog P5: LFO- OSC1 LFO1 page.

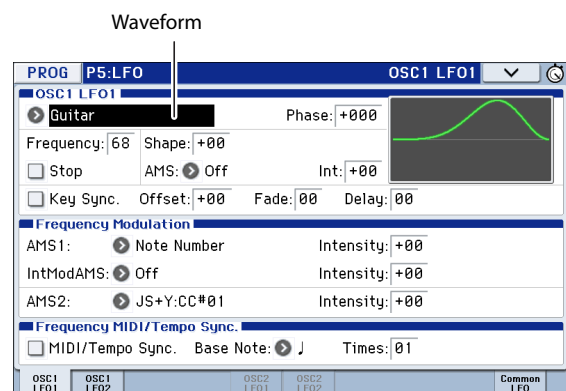

2. Select the Waveform parameter.

Use the INC and DEC buttons to scroll through the different waveforms, and look at their shapes in the graphic display.

There are a number of waveforms to choose from. Each are suited to different applications:

Triangle and **Sine** are the classic LFO shapes for vibrato, tremolo, panning, and filter wah effects.

Square is useful for gated on and off filter and amp effects, and can create trills when modulating pitch.

The **Guitar** waveform is designed especially for guitar vibrato; it bends only upwards from the base value.

Saw and **Exponential Saw Down** are good for rhythmic filter and amp effects.

Random 1 (S/H) creates the classic sample-and-hold effect, which is great for modulating a resonant filter.

3. After looking at the different waveforms, select **Triangle**.

4. Select the **Shape** parameter, and use the **VALUE** dial to move through its different settings, from **-99** to **+99**.

Notice how the shape of the waveform becomes more curved, and how **-99** emphasizes the lower part of the shape, and **+99** emphasizes the upper part.

5. Select the **Phase** parameter, and use the **VALUE** dial to sweep through its range of values.

Notice how the waveform shifts from side to side. Among other things, this lets you offset the LFOs from one another in time, which can create interesting organic effects.

6. Use the **Freq (Frequency)** parameter to set the speed of the LFO.

7. Use the **Fade and Delay** settings to control the way the LFO sounds at the beginning of the note.

For more information on LFOs, please see page 42 of the Parameter Guide.

All of these parameters control the way that the LFO works. In order for the LFO to actually affect the sound, you can use the dedicated LFO routings on the Filter, Pitch, and Amp pages, or use the LFOs as AMS sources for a wide variety of parameters.

Using EGs (Envelope Generators)

An envelope creates a modulation signal by moving from one level to another over a specified time, and then moving to another level over another period of time, and so on.

The Program includes three EGs, for Pitch, Filter, and Amp. These produce time-varying changes in pitch, tone, and volume respectively. They can also be used to modulate a number of other program parameters via AMS.

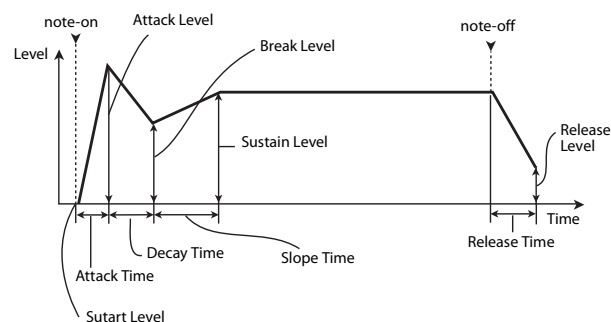

Note: The parameters that can be modulated by an EG and the range of values will differ depending on the EGs provided for each section.

Diverse modulation settings (AMS and AMS mixer)

Using AMS

AMS (Alternate Modulation Source) lets you modulate program parameters using controllers, EG, or LFO as the modulation source. Extremely creative types of modulation are possible; for example, you can use a single controller to simultaneously modulate multiple parameters, or you can use an EG to modulate an LFO's frequency and then use that LFO to modulate a filter.

AMS (Alternate Modulation Source) refers to any of the assignable modulation sources in KROME, including:

- Controllers of the KROME itself, such as the joystick, SW 1/2, and the realtime knobs
- Incoming MIDI controllers
- Modulators such as the Filter, Pitch, and Amp EGs, the LFOs, or the AMS Mixers

Intensity is a parameter that sets the degree (speed, depth, amount etc.) of how AMS will control the modulation.

A number of frequently-used modulation routings, such as using the joystick to vary the pitch, are provided as additional, dedicated routings, separate from AMS.

Note that not all AMS sources may be available for some modulation destinations.

For details on alternate modulation and AMS, please see below.

- "Alternate Modulation Sources (AMS)" on page 339 of the Parameter Guide
- "Creating Vibrato" on page 37
- "Pitch EG" on page 37
- "Filter EG" on page 39
- "LFO modulation" on page 39
- "AMS (Pan)" on page 36 of the Parameter Guide
- "LFO1/2" on page 40

Using the AMS Mixers

The AMS Mixers combine two AMS sources into one, or process an AMS source to make it into something new.

For example, this lets you use an LFO to modulate a filter's resonance while also modulating it by an EG. Although resonance has only one AMS input, using the AMS mixer makes this possible. You could also do things such as using the filter EG to control the amount of LFO1. The wide variety of other possibilities include using the joystick to control the amount of pitch EG, allowing the joystick to apply bend only to notes played while you hold down the foot switch, or changing the response of a realtime controller.

The AMS Mixer outputs appear in the list of AMS sources, just like the LFOs and EGs. An AMS mixer's

output signal can be used to modulate a variety of parameters.

This also means that the original, unmodified inputs to the AMS Mixers are still available as well. For instance, if you use LFO 1 as an input to an AMS Mixer, you can use the processed version of the LFO to control one AMS destination, and the original version to control another.

Finally, you can cascade the two AMS Mixers together, by using AMS Mixer 1 as an input to AMS Mixer 2.

For details, please see "6-1: OSC1 AMS Mix1" on page 46 of the Parameter Guide.

Tips for using AMS

When making settings for alternate modulation, think of the effect that you wish to produce, what type of modulation will be necessary to produce that effect, and what parameter of the oscillator, filter, or amplifier needs to be controlled.

Next, select a source (AMS) and set the **Intensity**. If you proceed logically in this way, you will achieve the desired effect.

For example in a guitar sound program where you want to use the joystick to control the feedback, you would make assignments so that the joystick controls the filter frequency and resonance.

Controller Setup page

For each program, the function of Realtime Control knobs 1-B-4-B and the SW1 and SW2 buttons can be assigned in the Prog P1: Basic/Controllers- Controllers Setup page.

For details, please see "Setting the functions of SW1 and SW2" on page 41, and "Setting the functions of Realtime Controls USER knobs 1-4" on page 42.

Controlling Pitch

Pitch bend

Pitch bend smoothly changes the pitch upward or downward, similar to how a guitarist can “bend” strings. On the KROME, you will normally use the joystick to control pitch bend in realtime.

The **JS (+X)** and **JS(-X)** settings specify the amount of pitch change (in semitones) that will occur when MIDI pitch bend messages are received or when the joystick is moved to left or right. A setting of **+12** allows the pitch to be controlled a maximum of one octave upward; a setting of **-12** allows the pitch to be controlled a maximum of one octave downward.

Note: You can also control pitch bend using a controller other than the joystick, or via MIDI.

Ribbon (#16) specifies the amount of pitch change (in semitone units) that will occur when MIDI control change message #16 is received. With a setting of **+12**, a value of **127** will raise the pitch one octave, and a value of **0** will lower the pitch one octave.

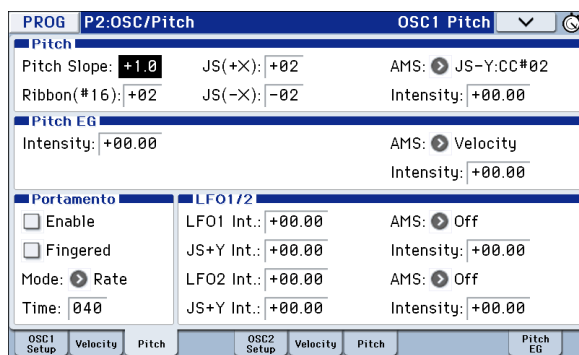

Creating Vibrato

You can use an LFO to create vibrato.

LFO1 Int. or **LFO2 Int.** sets the depth of how the selected LFO will affect the pitch. With a setting of **+12.00**, vibrato will produce a maximum of ± 1 octave of pitch change.

JS+Y Int specifies the amount of vibrato that the LFO will produce when the joystick is pushed away from you.

Intensity (AMS Intensity) specifies the depth of vibrato that will be applied by the LFO when modulated by the selected AMS (Alternate Modulation Source). For example, if the panel switch assignment for **SW1** is set to SW1 Mod. (CC#80) (Prog 1–7a), and you set **LFO1 AMS** to SW1: CC#80 and specify an appropriate value for **Intensity**, vibrato will be applied when you turn SW1 on or when MIDI control change #80 is received.

Pitch EG

When the **Intensity** value is set to **+12.00**, the pitch EG specified in the Pitch EG page will produce a maximum of ± 1 octave of pitch change.

To realistically simulate the slight change in pitch that occurs when a string is plucked or at the attack of a brass or vocal sound, you can use the EG to create a subtle change in pitch at the attack.

Portamento

Portamento makes the pitch change smoothly when you play the next note before releasing the previous note.

The **Time** parameter controls how long it will take the pitch to change. As this value is increased, the pitch will change over a longer time. With a value of **000**, there will be no portamento.

You can turn Portamento on and off via SW1 or SW2, by assigning them to **Porta.SW CC#65**.

Using Filters

The filters allow you to diminish or emphasize specified frequency areas of the sound.

The tone of the sound will depend significantly on the filter settings.

The basic filter settings, including the routing, type, cutoff frequency, and resonance, are set on the P3-1: Filter page.

Filter Routing

Each oscillator has two filters, Filter A and Filter B. The **Filter Routing** parameter controls whether one or both of the filters are used, and if both are used, it controls how they are connected to each other.

The **Single** routing uses only Filter A as a single 2-pole, 12dB/octave filter (6dB for Band Pass and Band Reject).

The **Serial** routing uses both Filter A and Filter B. The oscillator first goes through Filter A, and then the output of Filter A is processed through Filter B.

Parallel also uses both Filter A and Filter B. The oscillator feeds both filters directly (and allow independent settings for each), and the outputs of the two filters are then summed together.

The **24dB(4Pole)** routing merges both filters to create a single 4-pole, 24dB/octave filter (12dB for Band Pass and Band Reject). In comparison to Single, this option produces a sharper roll-off of frequencies beyond the cutoff frequency, as well as a slightly more delicate resonance. Many classic analog synths used this type of filter.

Serial and Parallel Routing

Serial



Parallel

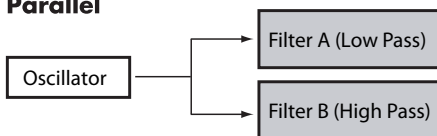

Filter Types

This selects the parts of the sound that will be affected by the filter, as described below. With the Serial and Parallel routings, you can independently set the types for Filter A and Filter B.

The filters will produce very different results depending on the selected filter type.

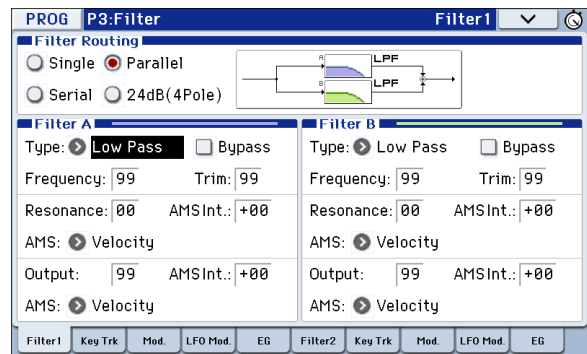

Low Pass: This cuts out the parts of the sound that are **higher** than the cutoff frequency. Low Pass is the most common type of filter, and is used to make bright timbres sound darker.

High Pass: This cuts out the parts of the sound that are **lower** than the cutoff frequency. You can use this to make timbres sound thinner or more buzzy.

Band Pass: This cuts out all parts of the sound, both highs and lows, except for the region around the cutoff frequency. Since this filter cuts out both high and low frequencies, its effect can change dramatically depending on the cutoff setting and the oscillator's multisample.

With low resonance settings, you can use the Band Pass filter to create telephone or vintage phonograph sounds. With higher resonance settings, it can create buzzy or nasal timbres.

Band Reject: This filter type—also called a notch filter—cuts only the parts of the sound directly around the cutoff frequency. Try modulating the cutoff with an LFO to create phaser-like effects.

Filter Types and Cutoff Frequency

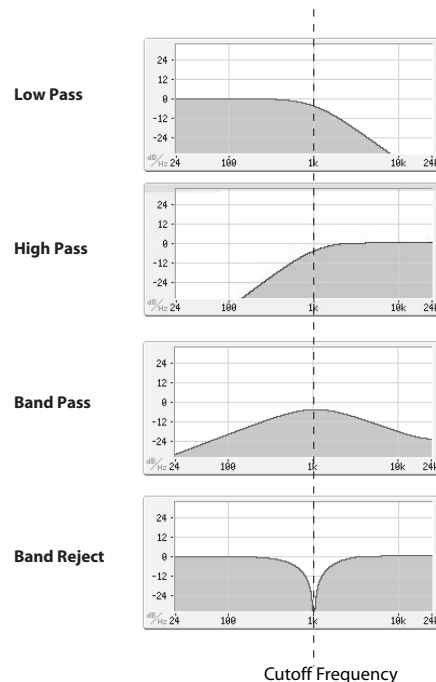

Resonance

Resonance emphasizes the frequencies around the cutoff frequency, as shown in the diagram below.

When this is set to 0, there is no emphasis, and frequencies beyond the cutoff will simply diminish smoothly.

At medium settings, the resonance will alter the timbre of the filter, making it sound more nasal, or more extreme. At very high settings, the resonance can be heard as a separate, whistling pitch.

To make the resonance track the keyboard pitch, please see “Key Follow” on page 29 of the Parameter Guide.

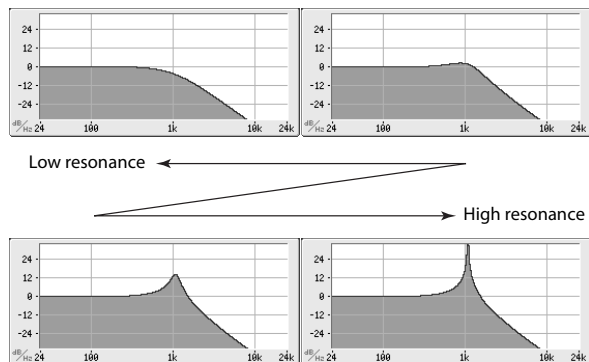

Modulating the filters

You can modulate the filter cutoff frequency using the Filter EG, the LFOs, keyboard tracking, and other built-in and MIDI controllers. This is a great way to add a rich variety of tonal change to the sound.

Filter EG

The Filter EG is a multi-stage envelope, which you can use to modulate the filter as well as other Program parameters. The EG itself is set up on the EG tab; the way that it affects the filters is controlled by the parameters described below, on the Filter1/2–Modulation page:

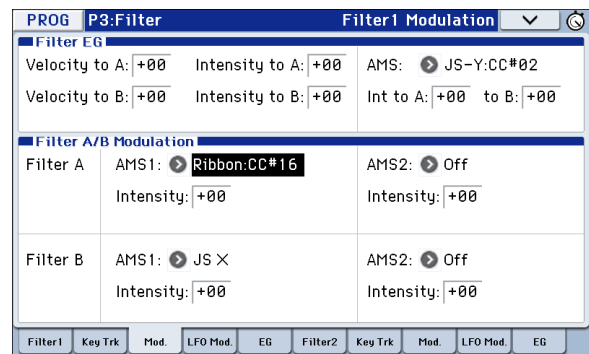

The **Intensity to A** and **Intensity to B** settings control the basic amount of EG modulation for filter frequencies A and B, respectively, before other modulation.

The **Velocity to A** and **Velocity to B** settings let you use velocity to control the amount of EG modulation.

The **AMS** setting selects an AMS modulation source to scale the amount of the Filter EG applied to Filters A and B. The two filters share a single AMS source, with separate intensity **Into A** or **to B** settings.

LFO modulation

You can modulate the filter via LFO1, LFO2, and the Common LFO. Among other applications, LFO modulation of the filter can produce the classic “auto-wah” effect.

The Filter1/2–LFO Mod. page lets you set up the following parameters separately for each LFO:

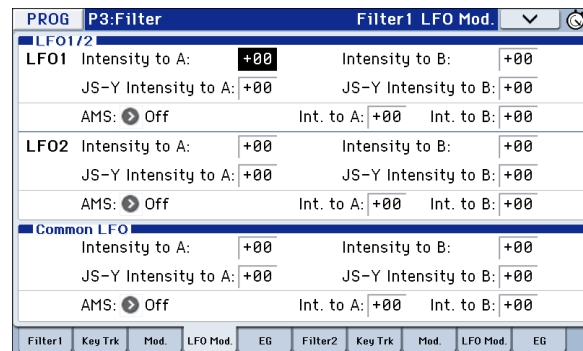

Intensity to A and **Intensity to B** specify how much the LFO changes the tone.

JS-Y Intensity to A and **JS-Y Intensity to B** specify the depth of the wah effect produced by the LFO when the joystick is moved toward yourself, or when CC#2 is received.

The **AMS** setting selects an AMS modulation source to scale the amount of the LFO applied to Filters A and B. The two filters share a single AMS source, with separate intensity settings.

For example if **AMS** is set to SW1: CC#80, turning SW1 on will apply an auto-wah effect (see page 37).

Keyboard Track

Most acoustic instruments get brighter as you play higher pitches. At its most basic application, keyboard tracking re-creates this effect by increasing the cutoff frequency of a lowpass filter as you play higher on the keyboard. Usually, some amount of key tracking is necessary in order to make the timbre consistent across the entire range.

The KROME keyboard tracking can also be much more complex, since it allows you to create different rates of change over up to four different parts of the keyboard. For instance, you can:

- Make the filter cutoff frequency increase very quickly over the middle of the keyboard, and then open more slowly—or not at all—in the higher octaves.
- Make the cutoff frequency increase as you play lower on the keyboard.
- Create abrupt changes at certain keys, for split-like effects.

How Key Track works: Keys and Ramps

The keyboard tracking works by creating four ramps, or slopes, between five keys on the keyboard.

For details, please see “How it works: Keys and Ramps” on page 28 of the Parameter Guide.

Using the Amp section

The Amp section includes controls for volume, pan, and the driver circuit.

You can control the volume using the Amp EG, LFO 1/2, Key Track, and velocity, along with other AMS sources.

Each Oscillator has its own Amp section: Amp1 for OSC1, and Amp2 for OSC2.

Background - what does "Amp" mean?

Different sounds have characteristic shapes to their volume levels.

For example, the volume of a piano note begins at a high volume the instant you play the note, and then decreases gradually.

The volume of an organ note, on the other hand, remains constant as long as you continue pressing the key.

The volume of a note on a violin or wind instrument can be varied during the note by the musician (i.e., by regulating the amount of pressure on the bow or the force of the breath).

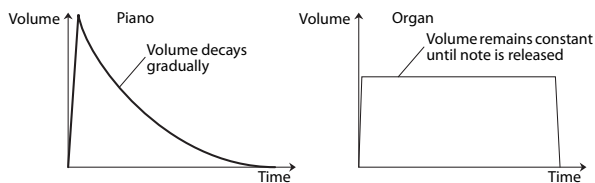

Pan

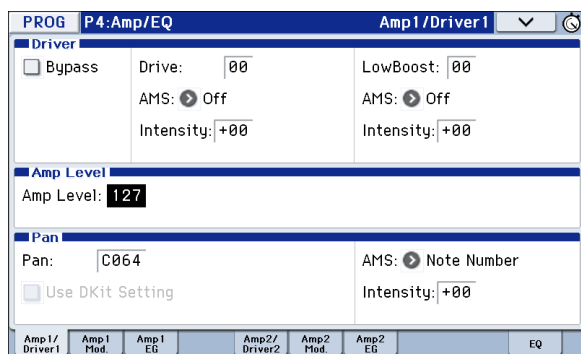

Pan

The main **Pan** parameter controls the stereo position after the signal has passed through the oscillator, filter, and amp.

Normally you'll set this to **C064**, so that the sound is centered equally between the left and right speakers.

To create a stereo effect when **Oscillator Mode** is set to **Double**, set the Amp1/Driver 1 page **Pan** to L001, and the Amp2/Driver2 page **Pan** R127. This will make OSC1 go to the left speaker, and OSC2 go to the right speaker.

With a setting of **Random**, the pan will change randomly each time you play a note on KROME, producing an interesting effect.

Pan - Use DKit Setting

Use **DKit Setting** applies when **Oscillator Mode** is set to **Drums** or **Double Drums**.

If this is **checked**, the Program can use a different pan position for each drum sound, as specified by the Drum Kit. If this is **unchecked**, all drum sounds will use the Program's pan position.

The factory presets and GM drum kits use individual pan positions for the different drums, so normally it's best to leave this checked.

Amp modulation

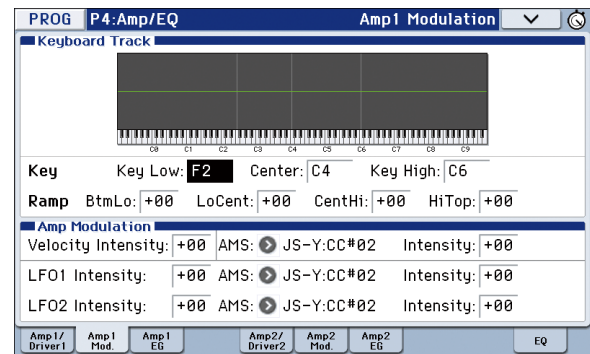

The basic volume level is set by the **Amp Level** parameter. You can then alter this using the modulation sources below:

Keyboard Track

This lets you vary the volume relative to the note you play.

For details, please see "Keyboard Track" on page 39.

Amp Modulation

Velocity Intensity is used by most programs to decrease the volume of softly played notes and increase the volume of strongly played notes, and the Amp Modulation parameter adjusts the depth of this control.

Normally you will set Amp Modulation to positive (+) values. As this setting is increased, there will be greater volume difference between softly played and strongly played notes.

LFO1/2

Specifies how the LFO's will produce cyclic changes in volume (tremolo effect).

The volume will be affected by the LFO(s) where you set an **LFO1 Intensity**, **LFO2 Intensity** value.

Intensity (AMS Intensity) adjusts the depth of how the tremolo effect produced by the LFO will be affected when you assign an **AMS** (LFO1 AMS, LFO2 AMS).

For example, if you set **AMS** to **JS-Y: CC #02**, tremolo will be applied when you push the KROME's joystick down (toward yourself), or when CC#02 is received.

Amp EG

The Amp EG lets you control how the volume changes over the course of a note.

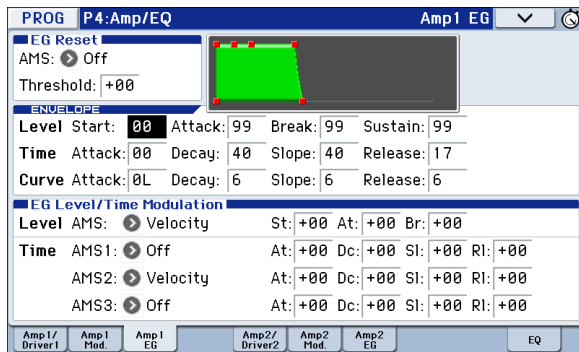

Every instrument has its own characteristic volume envelope. This is part of what gives each instrument its identifiable character.

Conversely, by changing the volume contour—for instance, applying a string-like Amp EG curve to an organ multisample—you can produce interesting and unusual sounds.

Piano

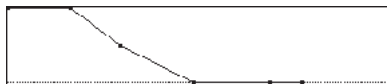

Organ



Strings



Drive

The Drive circuit adds saturation and overdrive to the sound, for everything from subtle fattening to drastic distortion. Unlike an overdrive effect, Drive processes each voice individually, so the timbre stays the same regardless of how many voices are being played.

The two main parameters, **Drive** and **Low Boost**, work together to create the overall effect.

Drive controls the amount of edge and bite in the timbre. Low settings will produce mild saturation, and higher settings create more obvious distortion.

Often, it's useful to increase the **Low Boost** along with the **Drive**.

Note: even when the **Drive** amount is set to 0, the **Drive** circuit still affects the timbre. If your goal is a completely pristine sound, use the **Bypass** control instead.

Low Boost is a special low-frequency EQ which controls the body character of the sound. The specific EQ frequencies affected will change with the **Drive** setting.

Higher amounts increase the bass boost, and will also intensify the effect of the **Drive** parameter.

Making controller assignments

Setting the functions of SW1 and SW2

SW1 and SW2 are the two buttons above the joystick.

These on/off buttons can perform a number of different functions, such as modulating sounds or effects, or locking the modulation values of the joystick.

Also, each one may work either as a toggle, or as a momentary switch. In **Toggle** mode, each press alternates between on and off; in **Momentary** mode, the switch only changes for as long as you hold it down.

Each Program, Combination, and Song stores its own settings for what the buttons will do, and whether each button is on or off (based on their current states when the data is saved).

You can set up Panel Switch Assign on the Controllers Setup page.

Mode	Page
Programs	Prog P1: Basic/Controllers
Combinations	Combi P1: Controllers
Songs	Seq P1: Controllers

Note: The on/off status of the SW1 and SW2 buttons will be preserved when you write the program or combination.

Note: You can use SW1/2 as alternate modulation or effect dynamic modulation sources to control program parameters or effect parameters.

To do so, you will normally assign SW1 Mod.(CC#80) and SW2 Mod.(CC#81).

For an example of assigning the SW1 button as an effect dynamic modulation source for a program, and using it to control an effect, see page 82.

For a complete list of the possible assignments, see page 348 of the Parameter Guide.

Note: If you want to keep these settings after the power is turned off, you must save them (see page 116).

Setting the functions of Realtime Controls USER knobs 1–4

When the Realtime controls is set to USER, the four knobs on the right function as Realtime knobs 1–4.

These can perform a number of different functions, such as modulating sounds or effects, adjusting effects send levels, and so on.

Each Program, Combination, and Song stores its own settings for what the knobs will do.

When using the sliders for AMS or Dmod, it's important to understand that creating an assignment is a two-step process. First, you assign the knob to send a MIDI controller, such as Knob Mod.1 (CC#17). Second, you assign that MIDI controller to modulate one or more Program or effects parameters.

For the first part of the above, use the mode's Controllers Setup page (See "Setting the functions of SW1 and SW2," above).

The default assignments for knobs 1–4 are Knob Mod.1 (CC#17), Knob Mod.2 (CC#19), Knob Mod.3 (CC#20), and Knob Mod.4 (CC#21), respectively.

Here's an example of how to set up knob 1 to control a Program's filter and amp EG attack time:

1. Press the **MODE PROG** button to enter Program mode.
2. Access the **P1: Basic/Controllers– Controllers Setup** page.
Press the **PAGE** button to access Page Select, and choose "P1 Basic/Controllers." Press the **Controllers** tab.
3. Press the **Realtime Controls Knob Assign "Knob 1–B"** popup button, and choose **F/A Attack (CC#73)**.
4. Press the **CONTROL ASSIGN REALTIME CONTROL** button to select **USER**. (The **LED USER** will light up.)
5. Use knob 1 to control the EG attack for the filter and amp.

For details, please see page 348 of the Parameter Guide.

Note: If you wish to keep these settings after the power is turned off, you must save the Program, Combination, or Song (see page 116).

Arpeggiator settings

According to the note data received from the keyboard or from the MIDI IN connector, the arpeggiator will automatically generate a wide range of phrases or patterns including arpeggios, guitar or keyboard backing riffs, bass phrases, or drum patterns. When the realtime controls ARP is selected, you can use the knobs to vary the duration and dynamics of the arpeggiated notes.

For more about the arpeggiator, please see page 85.

Drum Track settings

You can use the KROME's rich variety of drum patterns to accompany you with high-quality drum programs while you perform using a program.

Playing along with Drum Track patterns is often a useful way to come up with new phrases.

For more about the Drum Track function, please see page 97.

Effects

For details, please see "Using Effects" on page 77.

Automatically importing a Program into Sequence mode

You can use the Auto Song Setup feature, which automatically copies the settings of the program or combination and puts the KROME in record-standby mode when you simply press the **REC (●)** button. Then you can press the **SEQUENCER START/STOP (▶/■)** button to begin recording.

For details, please see "Auto Song Setup function" on page 59.

Playing and editing Combinations

About the KROME's combinations

Combinations let you split and layer up to 16 Programs at once.

A Combination is made up of 16 Timbres (Note that you don't have to use all 16 Timbres). Each Timbre is assigned a Program, along with parameters for key range and velocity zones, mixer settings, MIDI channel and controller filtering, and so on.

As with Programs, each Combination has five insert effects, two master effects, and one total effect for shaping and transforming the sounds of the individual Timbres.

This section of the manual takes a quick look at playing Combinations, including a tour of the front-panel controllers and basic editing techniques.

Playing combinations

Selecting Combinations

There are several different ways to select Combinations. Each one is convenient in a different way:

- Using "Combination Select" and the VALUE controllers:
- Using the Bank/Combination Select menu:
- Using the Category/Program Select menu:
- Find
- Using a foot switch: page 19
- Sending MIDI program change messages to select Programs remotely:

For details, please see below.

Selecting a program using "Combination Select" and the VALUE controllers

1. Press the COMBI button. (The LED will light up.) (Refer to the illustration below for the buttons.)

Alternatively, you can use the mode button (see "Selecting modes" on page 9).

The KROME will enter Combination mode.

2. Access the Combi P0: Play- Program T01-08 page.

This is shown in the top line of the display.

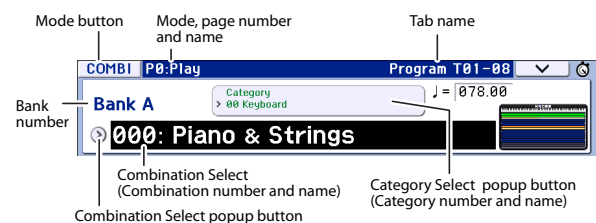

If a different page is shown, press the EXIT button several times to move to the Combi P0: Play- Program T01-08 page.

3. Make sure that "Combination Select" is selected.

If it is not, press "Combination Select" in the display to highlight it.

4. Select the combination you want to play.

You can use the following methods to select a combination.

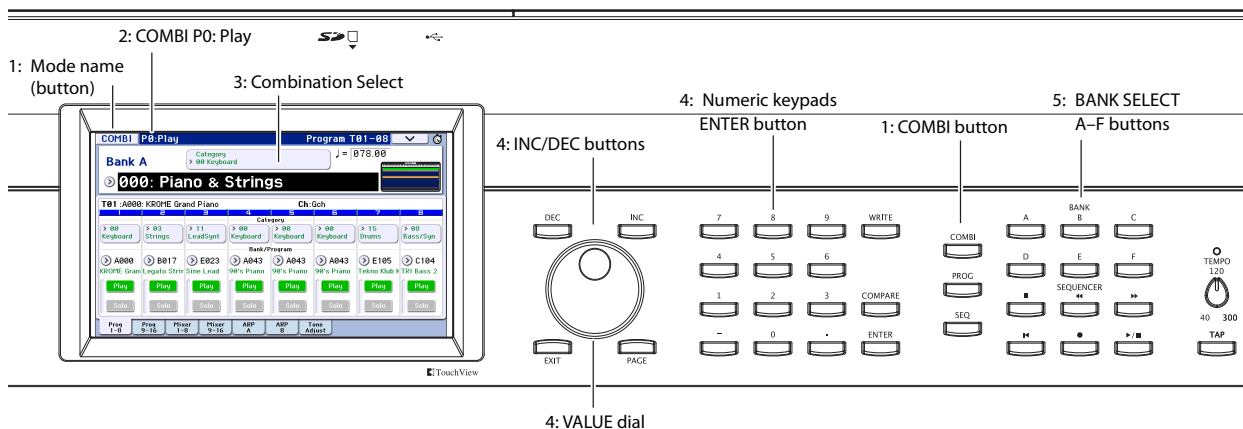

- Use the INC or DEC buttons.
- Turn the VALUE dial.
- Use numeric keys 0–9 to enter the combination number, and press the ENTER button.

5. Press a COMBI BANK A–D button to switch banks.

When you select a different Bank, the button’s LED will light up, and the selected bank will appear on the left side of the display.

For example, to select bank B, press the COMBI BANK B button. The B button will light up, and the name Bank B will appear in the left side of the display.

Auditioning the sound

Play the KROME’s keyboard to hear the combination you’ve selected.

Key zone preview allows you to check the timbre’s layer and split settings, as well as how the arpeggiator is used.

- The keyboard area indicates the last (single) note-on that was received on the global MIDI channel.
- The key zone area shows the timbres that will sound at the key position, differentiated by several colors according to the settings of each timbre.



Green: Timbres that are sounded on the global MIDI channel, such as by the keyboard.

Yellow: Timbres that will sound only when the arpeggiator is on (see page 90).

Orange: Timbres that will sound only when the drum track is on.

Blue: Timbres whose timbre channel is set to something other than the global channel. These will not be sounded by the KROME’s keyboard, arpeggiator, or drum track, but will sound in response to MIDI note-on messages from an external device.

Purple: These timbres are used to play an external sound module. They do not sound on the KROME.

None: Timbres whose timbre status is off. These will not sound.

The velocity meter shows the note-on velocity value.

- Note-on velocities from the keyboard, MIDI IN, arpeggiator, and drum track are shown for each timbre/channel. (If multiple note-on events occur simultaneously, the highest velocity value will be shown.)
- Since this shows the note-on velocity values, it is not affected by the setting of the Volume slider nor by changes in the audio signal level. Also, the meter will respond even if key zone settings or velocity zone settings are such that the note is not sounded.

Timbres whose Play/Mute and Solo settings allows them to play are shown in a dark color, and timbres that are muted are shown in a light color.

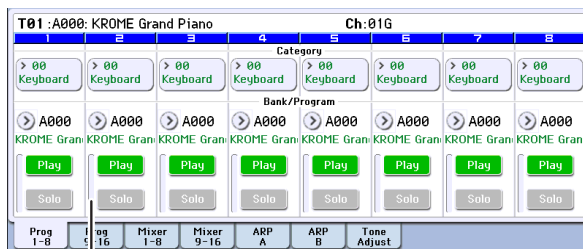

Velocity meter

Overview: Combination Banks

With the factory settings, the KROME contains 384 preloaded combinations that are GM2 compatible. In addition to these, there are 128 combinations to store sounds that you create, or store optional sound libraries.

Combinations are organized into four banks as shown in the following table.

Combination bank contents

Bank	Combi. No.	Explanation
A, B, C	000...127	Factory Combinations
D	000...127	Initialized Combinations

Selecting by Bank/Combination Select menu

You can select Combinations from a list organized by Combination bank.

- Press the Combination Select popup button to access the menu and make your selection.

The selection method is the same as in “Selecting by Bank/Program Select menu” on page 22; Refer to that page for details.

Bank/Combination Select menu

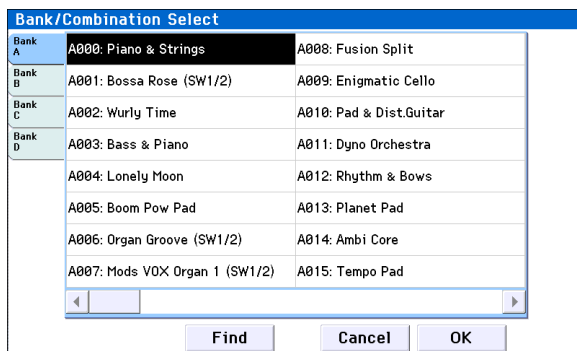

Selecting by Category/Combination Select menu

You can select Combinations arranged by category, such as keyboard, organ, bass, and drums.

When shipped from the factory, the preloaded Combinations are organized into 16 categories, each with several sub-categories.

- Press the Category Select popup button to access the menu and make your selection.

The selection method is the same as in “Selecting by Category/Program Select menu” on page 23; refer to that page for details.

Category/Combination Select menu

Category/Combination Select		00: Keyboard	
00 Keyboard	A000: Piano & Strings	A021: Rock Piano/Strings	09 Motion Sy
01 Organ	A001: Bossa Rose (SW1/2)	A022: Piano/Strings	10 Synth
02 Bell/Malle	A002: Wurlly Time	A023: CompPiano & Tron Str/Vox	11 LeadSplit
03 Strings	A016: Piano Session (SW2)	A024: SG-1D Piano/Ana Strings	12 BassSplit
04 Brass/Re	A017: Piano Trio	A025: Runnin' Wild (SW1)	13 Complex
05 Orchestra	A018: Comp Piano Rock	A026: HonkyTonk Session (SW2)	14 BPP1 Sync
06 World	A019: The First Time...	A027: Western Bar (Knob1)	15 Drums/Ht
07 Guitar/Pl	A020: JazzyHop Piano (SW1)	A028: Piano Pad	16 User 16
08 Pads/Voc			17 User 17

Jump to Sub Find Cancel OK

Find

You can search for a combination by a portion of its name.

The procedure is the same as explained in “Find” on page 23. Please see that explanation for details.

Using controllers to modify the sound

The KROME provides a variety of controllers that you can use to vary the sound, such as the joystick, the SW1, SW2 buttons, and the control surface knobs. It also provides chord trigger buttons.

For details, please see the corresponding explanation for Programs: “Using Controllers” on page 24.

Performing with the arpeggiator or drum track

Based on note data it receives from the keyboard or from the MIDI IN connector, the arpeggiator can generate a wide range of phrases and patterns including arpeggios, guitar or keyboard backing riffs, bass phrases, or drum patterns. When the realtime controls ARP is selected, you can use the knobs to vary the duration and dynamics of the arpeggiated notes.

For more about the arpeggiator, please see page 85.

The Drum Track function uses a rich variety of drum patterns to play the KROME’s high-quality drum programs. You can perform along with the drum patterns, or synchronize Drum Track patterns with the phrases generated by arpeggiator.

For more about the Drum Track function, please see page 97.

Easy Combination editing

You can edit any of the Combinations shipped with KROME. You can create your own combinations by editing a preloaded combination, or by starting from an initialized combination.

A combination has sixteen timbres; you can assign a program to each timbre and specify its volume and pan, the key range in which the program will sound, and how its sound will be routed to the effects. You can create simple setups such as detuned sounds, split, or layers, or highly complex orchestra-like setups.

Even without moving to the various pages for detailed editing, you can make dramatic changes just from within the Combi P0: Play page. You can also edit using the control surface's knobs on the front panel.

Changing the program of each timbre

Changing the Programs assigned to timbres (1–16) is a quick way to dramatically alter the sound of the Combination.

1. Access the Combi P0: Play– Program T01–08/T09–16 page.

In this page you can view the program assigned to each timbre 1–16, and the play/mute and solo status of each.

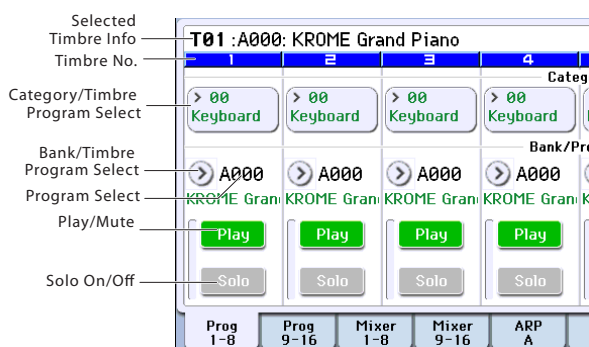

2. Use any of the following methods to select a Program for each timbre.

- Choose **Program Select**, use numeric keys 0–9 to input the program number, and press the ENTER button.
- Choose **Program Select** and turn the VALUE dial or use the INC/DEC buttons.
- If the **Program Select** parameter is selected, the PROG BANK A–F buttons will switch program banks. (If Timbre Program Select is selected, the BANK button LED of the program bank selected for that timbre will light up.)
- From the Bank/Program Select menu you can view and select programs by bank.
- From the Category/Program Select menu you can view and select programs by category.
- You can transmit MIDI program changes from a connected external MIDI device. (See page 359 of the Parameter Guide)

Note: To select the timbre program via MIDI program change the timbre's status must be set to "INT."

Adjusting the mix

Adjusting the volume of each timbre

1. Access the Combi P0: Play– Mixer T01–08 page.

This page shows the volume, pan, and Program assignments for all 8 Timbres.

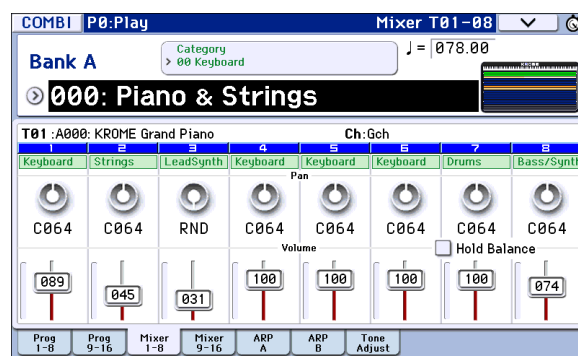

2. In the display, press the timbre 1 volume slider and slide it up or down to adjust the volume.

You can also highlight the numerical area of the slider and use the VALUE dial or the numeric keys to adjust the value.

If you check **Hold Balance**, moving any one of the volume sliders (volume values) will cause the volume of the other timbres to change as well, maintaining the relative volume balance between timbres 1–16. This is a convenient way to adjust the overall volume.

Adjusting the panning of each timbre

1. Access the Combi P0: Play– Mixer T01–08 page.
2. Press the timbre 1 pan knob, and slide it left/right to adjust the panning.

You can also highlight the numerical area of the knob and use the VALUE dial or the numeric keys to adjust the value.

Timbre pan interacts with the pan stored in the Program. A setting of C064 reproduces the Program's oscillator pan settings. Adjusting the Timbre Pan will move the sound to left or right while preserving the pan relationship between the oscillators. A setting of L001 is far left, and R127 is far right.

Simple editing using the knobs

You can use the Control Surface to perform a variety of edits.

For example, you can use the control surface to adjust the Filter cutoff or resonance. You can also use it to vary the depth of an effect, or to change the way in which the arpeggiator generates a phrase.

For details, please see “Realtime control knobs” on page 25.

Saving a Combination you’ve edited

After you’ve edited a combination, you must save it if you want to keep the changes you’ve made. If you re-select the combination or turn off the power before saving, your edits will be lost.

1. Press the WRITE button.

The Write Combination dialog box will appear. If you want to change the writing destination or the name, make the appropriate changes (see page 117).

2. Press the WRITE button once again to save (write) the data.

For details, please see “Writing a Program or Combination” on page 115.

You can also save combinations on an SD card as PCG files.

For details, please see “Saving to SD card (Media-Save)” on page 118.

Detailed Editing with Combinations

You can edit the preloaded combinations (Banks A–C) that the KROME is shipped with, or start with an initialized Combination to create your own original sounds.

You can use the factory Programs to create new Combinations, or use your own custom Programs.

Note: If you’re in the process of editing a Program in Program mode, and you use that Program in a Combination, you’ll hear the edited version in Combination mode as well.

About the edit pages

In the Combi P0: Play page you can select and play combinations. Here you can also use the control surface’s knobs and the tone-adjust function for quick editing, or to edit the settings of the arpeggiator or drum track. In the other pages you can edit the sound in greater detail.

For details on each mode and how to access each page, please see “Basic operations” on page 9.

Combination structure and corresponding pages

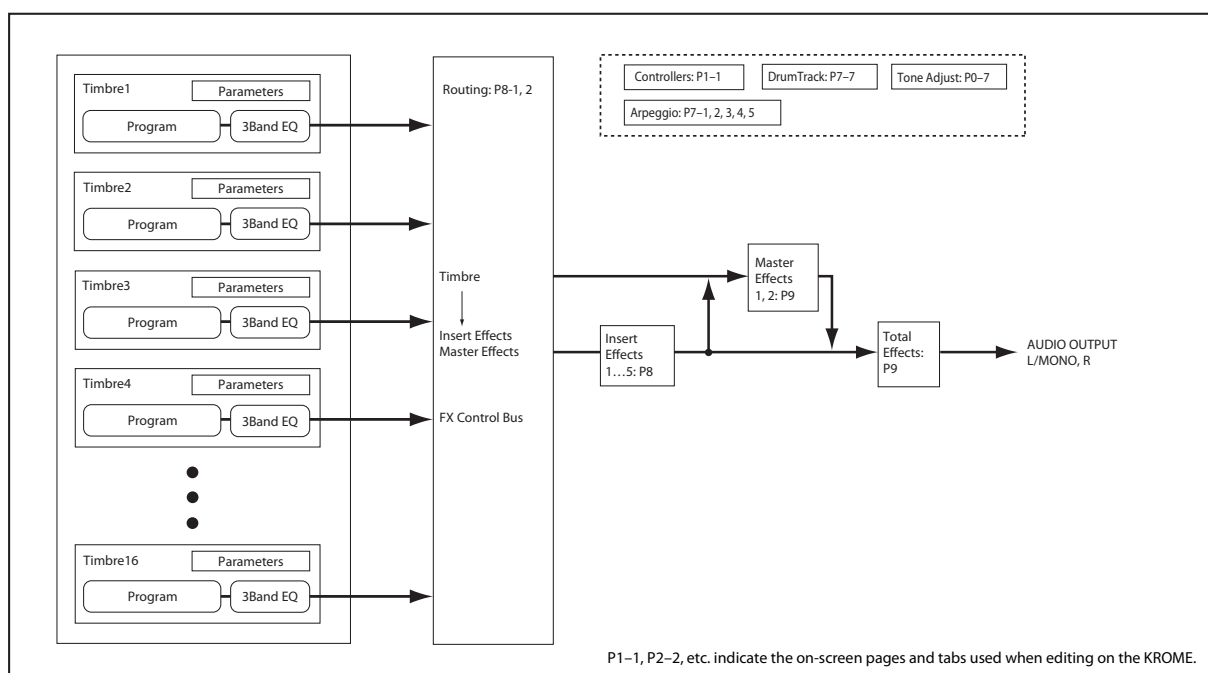

A suggested approach for editing

First, select a Program for each Timbre, on the P0: Play– Program T01–08 or T09–16 page. (Note that you don't have to use all 16 Timbres)

Next, create any desired keyboard or velocity splits, layers, or crossfades between the different Timbres. You can do this on the P4: Zone/Delay– Keyboard Zones page.

After this, adjust the volumes of the Timbres (back on the Program Select/Mixer tab), and set up any other Timbre parameters as desired.

To add finishing touches to the sound, set up the Insert, Master, and Total Effect as desired (on the P8: Routing/IFX and P9: MFX/TFX/LFO pages, respectively.) These effects can be different from those associated with the individual Programs in Program mode, if desired.

In addition, you can make arpeggiator and drum track settings (on the P7: ART/DT page) and controller settings (on the P1: Controllers page) to create the finished Combination.

Soloing timbres

You can use the Control Surface's Solo function to hear the sound of each timbre by itself.

For details, please see "Solo On/Off" on page 72 of the Parameter Guide.

Restoring edited settings

Using COMPARE

When you're in the process of editing a sound, pressing the COMPARE button will recall the saved version of the sound, as it was before you started editing.

For details, please see "Compare function" on page 11.

Layers, Splits, and Velocity Switches

Within a Combination, you can use note range and velocity level to define the "zone" in which a specific timbre will play.

The Programs assigned to each Timbre can be played in three ways: as part of a **layer**, a **split**, or a **velocity switch**. A Combination can be set to use any one of these methods or to use two or more of these methods simultaneously.

Layer

Layers cause two or more Programs to play simultaneously when a note is played.

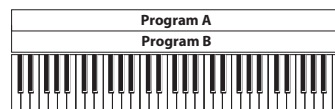

Layer:
Two or more programs sound simultaneously.

Split

Splits cause different Programs to respond on different areas of the keyboard.

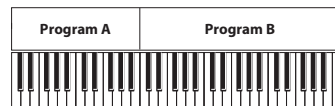

Split:
Different programs will sound in different areas of the keyboard.

Velocity Switch

Velocity Switches cause different Programs to respond depending on the velocity (how hard you play the notes).

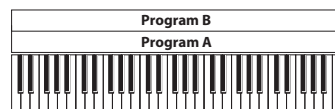

Strong ↑ Keyboard playing dynamics
Soft

Velocity Switch:
Keyboard playing dynamics (velocity) switches between different programs.

On the KROME, you can use a different Program for each of up to sixteen Timbres, and combine two or more of the above methods to create even more complex setups.

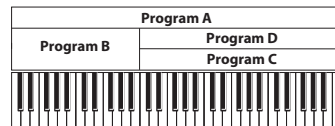

Strong ↑ Keyboard playing dynamics
Soft

Example:
B and C/D are split. In the lower keyboard range, A and B are layered. In the higher keyboard range, C and D are switched by velocity and layered with A.

As an additional possibility, you can set the slope for a key zone or velocity zone so that the volume diminishes gradually. This lets you change a split into a keyboard crossfade, or a velocity switch into a velocity crossfade.

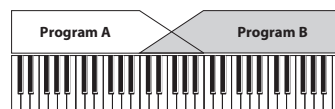

Keyboard X-Fade (keyboard crossfade):
As you play from low notes to high notes, the volume of A will fade out, and the volume of B will fade in.

Creating Key Splits and Layers

Splits and Layers

Let's create a Combination that combines both splits and layers, like the diagram below:

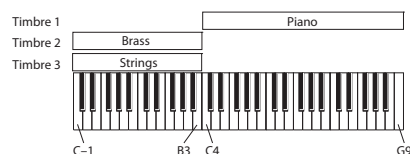

1. Access the Combi P0: Play– Program T01–08 page.
2. Select a piano sound for Timbre 1, a brass sound for Timbre 2, and a strings sound for Timbre 3.
3. Access the P3: Timbre Parameters– MIDI T01–08 page.
4. For Timbres 1–3, set Status to INT and MIDI Channel to Gch (the Global Channel).

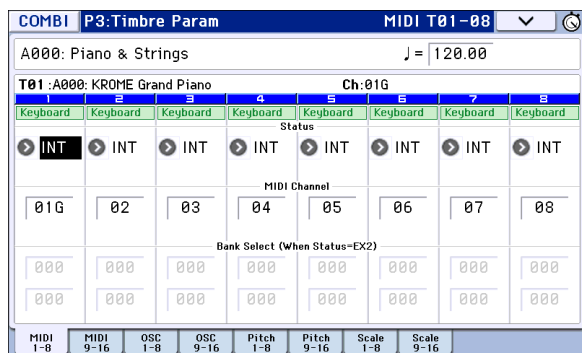

5. Access the P4: Zone/Delay– Key Z T01–08 page.
6. Set Timbre 1's Top Key to G9, and its Bottom Key to C4.

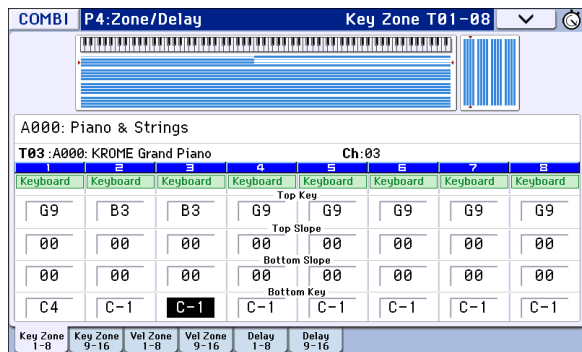

You can also enter a note value by selecting the parameter and then playing the desired note on the keyboard while holding down the ENTER button.

7. Set Timbres 2 and 3 to a Top Key of B3, and a Bottom Key of C–1.

Key Zone Slope

In addition to “hard” splits, where the sound changes abruptly, you can use the Slope parameters to gradually fade a sound in or out over a range of keys. In the example above, you could set the Bottom Key of timbre 1 to G3, and set the Top Key of timbre 2 to G4, so that these two timbres overlap.

Next, if you set the **Bottom Slope** of timbre 1 to 12, and set the **Top Slope** of timbre 2 to 12, the sound will change gradually instead of changing suddenly.

Creating Velocity Switches

Next, let's create a simple velocity switched Combination, like the diagram below:

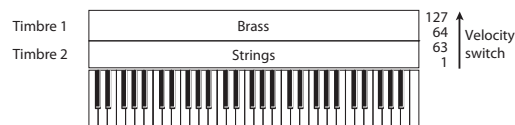

1. Access the Combi P0: Play– Program T01–08 page.
2. Select a brass sound for Timbre 1, and a strings sound for Timbre 2.
3. Access the P3: Timbre Parameters– MIDI T01–08 page.
4. For Timbres 1 and 2, set Status to INT and MIDI Channel to Gch (the Global Channel).
5. Access the P4: Zone/Delay– Vel Z T01–08 page.
6. Set Timbre 1's Top Velocity to 127, and its Bottom Velocity to 64.

You can also enter a velocity value by selecting the parameter and then playing a note with the desired velocity on the keyboard while holding down the ENTER button.

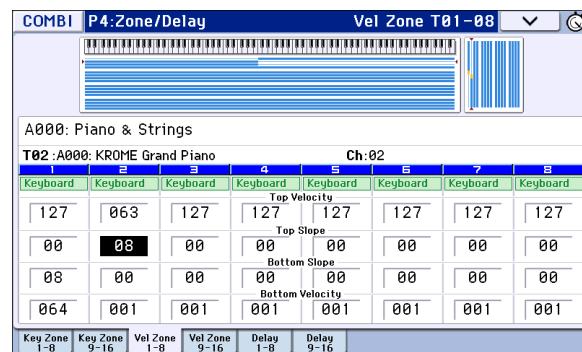

7. Set Timbre 2 to a Top Velocity of 63, and a Bottom Velocity of 1.

Velocity Zone Slope

Similar to Key Zone Slopes, as described above, these let you fade in and fade out sounds gradually over a velocity range, instead of a simple hard switch.

In the case of the example above, you could set the velocity zones of the two Timbres so that they partially overlap. Then, set the Top Slope and Bottom Slope so that the sound changes gradually, instead of changing suddenly between velocity values of 63 and 64.

MIDI settings

Timbre Parameters MIDI page

Status

This controls the status of MIDI and the internal tone generator for each Timbre. Normally, if you're playing an internal Program, this should be set to **INT**.

If the status is set to **Off**, **EXT**, or **EX2**, that Timbre's internal sounds will not be played. **Off** simply disables the Timbre entirely. The **EXT** and **EX2** settings allow the Timbre to control an external MIDI device.

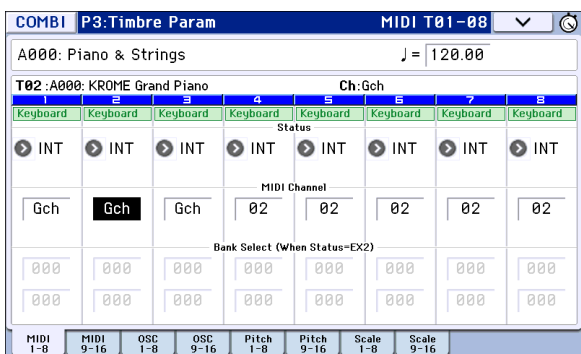

For details, please see "Status" on page 81 of the Parameter Guide.

Bank Select (when status=EX2)

When the **Status** is set to **EX2**, these parameters allow you to transmit MIDI Bank Select messages to external MIDI devices.

MIDI Channel

Timbres that you wish to play from the KROME's keyboard must be set to the global MIDI channel. Your playing on the keyboard is transmitted on the global MIDI channel, and will trigger any timbre that matches this channel. Normally you will set this to **Gch**. When this is set to **Gch**, the MIDI channel of the timbre will always match the global MIDI channel, even if you change the global MIDI channel.

⚠ On some preloaded Combinations, Timbres used by the arpeggiator may have their MIDI Channels set to something other than **Gch**. These will be timbres that play only when the arpeggiator is on, which is a very useful technique for creating "Arpeggiator based" Combinations.

For details, please see "Arpeggiator settings in Combination and Sequencer modes" on page 89. In particular, note the relationships between arpeggiator A/B assignments and MIDI Channel.

MIDI filter settings

For each MIDI Filter item, you can specify whether or not the corresponding MIDI message will be transmitted and received. The **checked** items will be transmitted and received.

The MIDI filters don't turn the functions themselves on or off. Instead, the filter just controls whether or not that MIDI message will be transmitted and received.

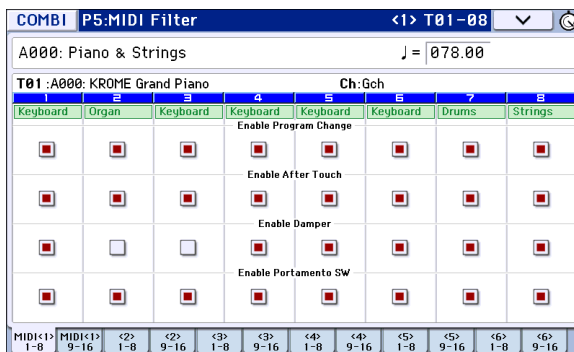

For example, if portamento is on, portamento will be applied to the internal KROME sound even if Enable Portamento SW is unchecked.

As another example, let's say that you've selected a bass Program for Timbre 1, and a piano Program for Timbre 2, with the goal of creating a bass/piano split. You could choose the following settings so that pressing the damper pedal affects only Timbre 2's piano sound:

1. Access the **P5-1: MIDI Filter <1> T01-08** page.
2. **Un-check the Enable Damper box for Timbre 1.**
3. **Check the Enable Damper box for Timbre 2.**

Altering Programs to fit within a Combination

You can make various changes to Programs within the context of a particular Combination to make them fit better with other Programs, or to create particular sonic effects. These changes do not affect the original Programs, or how those Programs sound in other Combinations (see page 81 of the Parameter Guide).

Timbre Parameters: OSC



Force OSC Mode

If you wish to force a polyphonic program to sound monophonically, set this either to **MN** (Mono) or **LGT** (Legato). Conversely, set this to **Poly** if you wish to force a monophonic program to play polyphonically.

Normally this should be set to **PRG**, so that the sound will play as set by the original Program.

For details, please see "Force OSC Mode" on page 82 of the Parameter Guide.

OSC Select

If the timbre is using a Program where the **Oscillator Mode** is **Double** or **Double Drums**, and you want only OSC1 or OSC2 (not both) to sound, set this to **OSC1** (only OSC1 will sound) or **OSC2** (only OSC2 will sound).

Normally, this should be set to **BTH** (Both).

Portamento

If the Program uses portamento, but you'd like to disable this for the current Combination, set this parameter to **Off**.

Conversely, if you want to force the portamento to be on, or just to change the portamento time, set this to a value of **001–127**. The portamento will change to use the newly specified time.

Normally, this should be set to **PRG**.

Timbre Parameters: Pitch

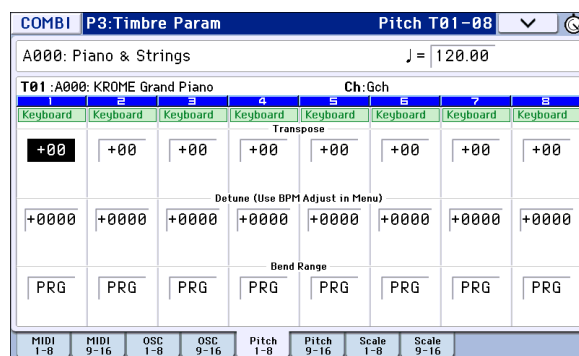

Transpose, Detune (BPM Adjust)

These parameters adjust the pitch of the timbre.

- In a layer-type combination, you can set two or more timbres to the same program, and create a richer sound by using **Transpose** to shift their pitch apart by an octave or by using **Detune** to create a slight difference in pitch between the two.
- In split-type combinations, you can use **Transpose** to shift the pitch (in semitone units) of the programs specified for each key zone.

Note: If you wish to change the playback pitch of a drum program, use **Detune**. If you change the **Transpose** setting, the relationship between the notes and drum sounds will change.

Use Program's Scale, Scale

This specifies the scale for each timbre.

If you **check Use Program's Scale**, the scale specified by the program will be used. Timbres where this parameter is **not checked** will use the **Scale** setting.

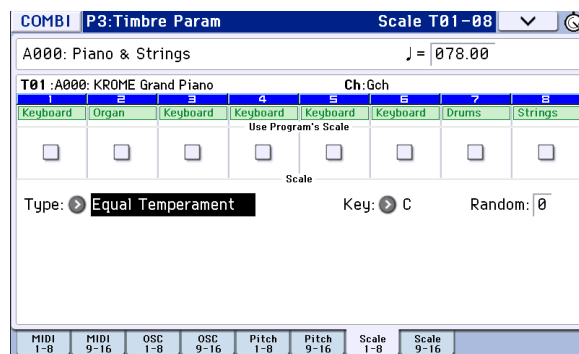

Delay

You can set some Timbres so that they don't sound immediately at note-on. This can create cool effects, and more dramatic layers.

You can specify the delay for each Timbre either in milliseconds (ms), or in rhythmic values which sync to the system tempo.

If you set the Delay to **Key Off**, the Timbre will sound when the note is released.

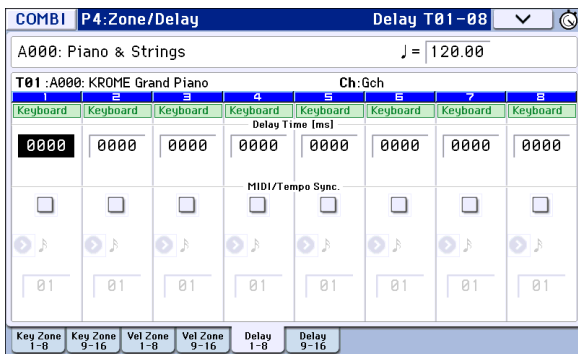

Editing Programs with Tone Adjust

Using Tone Adjust, you can create detailed edits to Programs within the context of the Combination. These edits will not affect the original Program, or any other Combinations which use the Program. To edit a Program with Tone Adjust:

Select a timbre in the **Timbre** field of the P0: Play– Tone Adjust page. Then select the parameter that you want to adjust, and use the VALUE controllers to edit the sound.

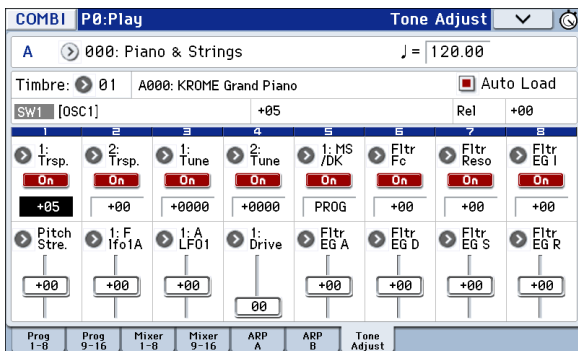

Arpeggiator settings

According to the note data received from the keyboard or from the MIDI IN connector, the arpeggiator will automatically generate a wide range of phrases or patterns including arpeggios, guitar or keyboard backing riffs, bass phrases, or drum patterns. If the SELECT button is set to ARP, you can use the knobs to vary the duration and dynamics of the arpeggiated notes.

For more about the arpeggiator, please see page 85.

Drum Track settings

While you perform using a combination, you can use the KROME's rich variety of drum patterns to play high-quality drum programs.

Playing along with Drum Track patterns is often a useful way to come up with new phrases.

For more about the Drum Track function, please see page 97.

Effects

For details, please see "Using Effects" on page 77.

Automatically importing a Combination into Sequencer mode

The Auto Song Setup feature automatically applies the settings of the current Combination to a song.

For details, please see "Auto Song Setup function" on page 59.

Creating songs (Sequencer mode)

Overview

About the KROME's Sequencer

The sequencer brings together the KROME's numerous functions such as its arpeggiator, RPPR, high-performance effects, and controllers, allowing you to take advantage of these in a wide range of situations.

This sequencer is a 16-track MIDI sequencer that can store up to 128 songs and 210,000 MIDI events. You can use it to record and play back notes for the internal sound generator as well as for external MIDI sound modules.

 When you turn off the power, the settings created in Sequencer mode, the song data, any user pattern data, and Cue List that you recorded will not be backed up. If you wish to keep this data, you must save it on an SD card before turning off the power, or perform a MIDI data dump to save the data on an external data filer etc.

If you wish to write the programs, track parameters, effects, and arpeggiator settings etc. selected for a song as a template song, use the menu command **Save Template Song**.

Immediately after the power is turned on, KROME will not contain any song data, so if you wish to play a song on the sequencer, you must first load data from SD card, or receive a MIDI data dump from a MIDI filer. For details, please see page 118, and page 219 of the Parameter Guide.

Sequencer mode structure

Sequencer mode is structured as follows.

Songs

A song consists of tracks 1–16, a master track, song parameters such as the song name, arpeggiator, Drum Track function, effect and RPPR parameters, and 100 user patterns.

A maximum of 128 such songs can be created on KROME.

Tracks 1–16 consist of setup parameters (such as each track's program, pan, and volume) located at the start of the song, and the musical data itself. The master track consists of tempo and time signature data (see "Setup parameters & Musical data" on page 106 of the Parameter Guide).

Song recording and editing

Song recording is performed on tracks.

You can record tracks in either of two ways; realtime recording or step recording. For realtime recording you can choose one of six recording modes.

You can edit tracks by using Event Edit operations to modify the recorded data or insert new data, and by using Track Edit functions such as Create Control Data, which generates and inserts pitch bend, aftertouch, or control change data.

Patterns

There are two types of patterns: preset patterns and user patterns.

Preset patterns: Patterns suitable for drum tracks are preset in internal memory, and can be selected for any song.

User patterns: Each song can have up to 100 patterns. When using a pattern in a different song, use the Utility menu commands **Copy Pattern** or **Copy From Song** etc. to copy the pattern. The pattern length can be specified in units of a measure.

Each pattern consists of musical data for one track. It is not possible to create patterns that contain multiple tracks.

You can use these patterns by placing them in a track (**Put to Track** menu command) or by copying them (**Copy to Track** menu command). You can also use patterns with the RPPR function of a song (see page 71).

Recording and editing a pattern

You can record a pattern in either of two ways: realtime recording or step recording. However, unlike realtime-recording to a track, you can select only one recording type (loop recording) when realtime-recording to a pattern.

You can edit the pattern to correct mistakes in the recorded data, or use event editing to insert new data.

You can use the **Get From Track** menu command to obtain a desired region of performance data from a track and use it as pattern data. Conversely, you can use the **Put to Track** or **Copy to Track** menu commands to place or copy a pattern's performance data into a track.

How Sequencer patterns are related to Drum Track patterns

The patterns of the Drum Track function you use with a Program or Combination are related to Sequencer mode patterns as follows.

Preset patterns are a common library that can also be used by the Drum Track function.

User patterns cannot be directly used by the Drum Track function, but they can be converted to user Drum Track patterns and used with a Program or Combination. If you convert a user pattern, it will be stored in internal memory, and this data will not disappear even when you turn off the power.

Cue List

The cue list allows you to playback multiple songs in succession. The KROME lets you create twenty cue lists. Each cue list lets you connect up to 99 songs and specify the number of times that each song will repeat.

The menu command **Convert to Song** lets you convert the songs in a cue list into a single song.

For example you can use a cue list to create the backing, convert the cue list to a song, and then add solo phrases on unused tracks.

Transport control

These controls let you play back, record, fast-forward, or rewind the sequencer.

Front panel buttons

You can use the front panel SEQUENCER buttons to control recording and playback on the sequencer.

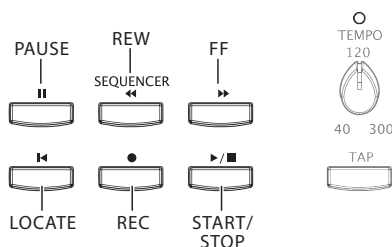

PAUSE (II) button

This button pauses the playback of the song. When paused, the button's LED will light up. Press PAUSE (II) once again to resume playback, and the LED will turn off.

REW (◀◀) button

When the Song is playing or paused, this button will rewind the song. When you press and hold this button, its LED will light up, and the playback will rewind. (Rewind is disabled during recording, and while the Song is stopped.)

Note: You can use the **FF/REW Speed** menu command to specify the fast-forward and rewind speed.

FF (▶▶) button

When the Song is playing or paused, this button will fast-forward the song. When you press and hold this button, the button will light up, and the playback will fast-forward. (Fast-forward is disabled during recording, and while the Song is stopped.)

LOCATE (◀) button

By pressing the LOCATE (◀) button you can move to a specified locate point. By default, you'll move to 001:01.000.

To change the locate point that's assigned to the LOCATE (◀) button, use the menu command **Set Location**. Alternatively, you can set the locate point during playback by holding down the ENTER button and pressing the LOCATE (◀) button.

START/STOP (▶ / ■) button

This starts or stops recording and playback in Sequencer mode.

REC (●) button

Pressing this button will enter record-ready mode. Once you're in record-ready mode (shown by the button's lit LED), you can begin recording by pressing the SEQUENCER START/STOP (▶ / ■) button. For details, please see "Recording MIDI in real time" on page 60.

Buttons in the display (the transport bar)

The transport buttons in the bottom line of the display can also be used to control sequencer recording and playback in the same way as the front panel SEQUENCER buttons.

The transport buttons will appear when you press the "<" button on the lower right side of the display and drag it toward the left. To close them, press the ">" button and drag it toward the right.

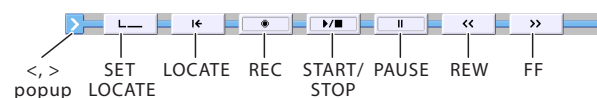

Playing Songs

Playback

In order to play back song data in the sequencer, you must first record, load or dump song data into the KROME.

Let's start by loading and playing the demo song data. For details, please see "Listening to the demo songs" on page 21 of the Quick Start Guide.

1. Press the SEQ button or MODE button to enter Sequencer mode.

The P0: Play/REC- Program T01-08 or T09-16 page will appear. If this is not displayed, press the EXIT button about three times.

2. Use "Song Select" to select the song you want to play back.

You can press the Song Select popup button and choose from a list. If you select an empty list, a new song will be created.

You can also select a song by using the INC/DEC button or VALUE dial. However if there is no song, you can't make a selection using the VALUE controllers.

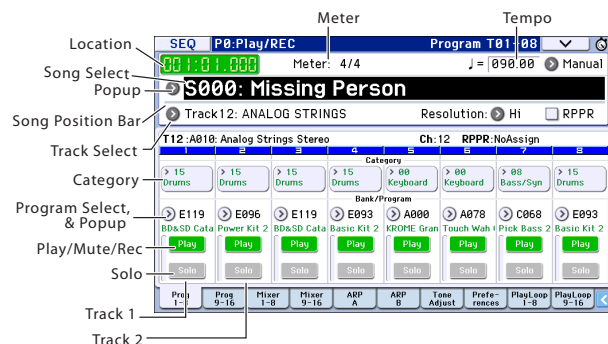

3. Press the SEQUENCER START/STOP (▶ / ■) button.

Alternatively, pull out the transport bar and press the START/STOP (▶ / ■) button. The transport control functionality in the procedure below is described as button operations, but you can also perform the same operations using the on-screen transport buttons.

The song you selected in step 2 will begin playing.

Note: The song will begin playing if you press the START/STOP (▶ / ■) button in a page other than P10: Pattern/RPPR. If you press this button while you're in P10: Pattern/RPPR, the currently-selected pattern will begin playing. (In P11: Cue List, the songs of the cue list will be played.)

4. During playback, you can press the START/STOP (▶ / ■) button to stop playback.

If you press the START/STOP (▶ / ■) button once again, playback will resume from where you stopped.

For details on the functions of the LOCATE (⏪), PAUSE (⏸), REW (⏮), and FF (⏭) buttons, please see page 54.

You can use the FF/REW Speed menu command to specify the fast-forward and rewind speed.

Changing the volume, mute, and solo settings of each track

In the SEQ P0: Play/REC- Prog T01-08, T09-16, Mixer T01-08, and T09-16 pages you can change the volume, mute, and solo settings of each track.

Muting a specific track/Monitoring a specific track (Mute/Solo functions)

The KROME provides a Mute function that lets you silence specified tracks 1-16, and a Solo function that lets you hear the specified track or channel by itself. These functions can be used in various ways. For example you can intentionally mute or solo specific tracks, or listen only to the rhythm section of the previously-recorded tracks while you record new tracks. Let's try out the Mute and Solo functions.

1. Use "Song Select" to select the song that you want to play back.
2. Press the SEQUENCER START/STOP (▶ / ■) button.
3. Press track 1 Play/Rec/Mute.

The display will change from Play to Mute, and the playback of track 1 will no longer be heard. In this way, the "mute" function allows you to silence a specified track until the track is un-muted.

Press track 2 Play/Rec/Mute. The display will change, and the playback of track 2 will also be muted. To cancel muting, press Play/Rec/Mute once again.



4. Press track 1 "Solo On/Off."

"Solo" will be highlighted, and this time, only the performance of track 1 will be heard. To play back only a specified track by itself in this way is known as "soloing" the track (turning Solo on).

If both Mute and Solo are used, the Solo function will be given priority.

Press track 2 "Solo On/Off."

The display will change, and you will hear the playback of tracks 1 and 2. You won't hear the sound of tracks 3-16.



5. To switch Solo off, press Solo On/Off once again. Press Solo On/Off for both tracks 1 and 2.

The display will change, and the playback of tracks 1 and 2 will be muted. If the Solo function is turned off for all tracks, playback will be according to the Play/Rec/Mute settings.

⚠ The SOLO setting is not stored when you save the song.

Exclusive Solo

Exclusive Solo is a function that limits the Solo function (described above) to a single track at a time. If Exclusive Solo is on, only the track for which Solo was last turned on will be played; other tracks will always be silent.

Use the **Exclusive Solo** menu command to specify how the Solo function will function.

Exclusive Solo off: You will be able to solo more than one track at a time. The status of a track will change each time you press its Solo On/Off button.

Exclusive Solo on: When you press a Solo On/Off button, only that track will be soloed.

Tip: You can turn Exclusive Solo on/off by holding down the ENTER button and pressing numeric key 1.

Loop playback

When recording or playing back a song, you can loop individual tracks that are playing.

In the P0-1: Play Loop T01-08 or T09-16 page, check **Track Play Loop** for the tracks you want to loop, and use **Loop Start Measure** and **Loop End Measure** to specify the starting and ending measure of the region that will play back as a loop.

If you check **Play Intro**, the measures preceding the loop will be played back as an introduction before the loop begins.



If you play back from the first measure with the settings shown in the screenshot above, the specified region of measures will repeat as follows.

Measures	1	2	3	4	5	6	7	8	9	10	11	12	13
Track 1	1	2	3	4	5	6	7	8	5	6	7	8	5
Track 2	9	10	9	10	9	10	9	10	9	10	9	10	9

If **Play Intro** is unchecked, the specified region of measures will repeat as follows.

Measures	1	2	3	4	5	6	7	8	9	10	11	12	13
Track 1	5	6	7	8	5	6	7	8	5	6	7	8	5
Track 2	9	10	9	10	9	10	9	10	9	10	9	10	9

Recording

Preparations for recording

-  Before you begin recording, make sure that the memory protect setting in Global mode is turned off. For details, please see “Protecting the memory” on page 110.

Creating a Song

Before we can begin this example, we need to select an empty song where we can record.

1. Press the **SEQ** button or **MODE** button to enter Sequencer mode.
2. Choose “Song Select” (e.g., in the P0: Play/REC–Program T01–08 page).

You can press the Song Select popup button, and choose from a list.



3. Use the numeric keys to input the number of the new song that you want to create, and press the **ENTER** button. (For example, press the 1 switch and then the **ENTER** button.) A dialog box will appear.

If you pressed the Song Select popup to access the Song No. dialog box, press the desired song number to open the dialog box.

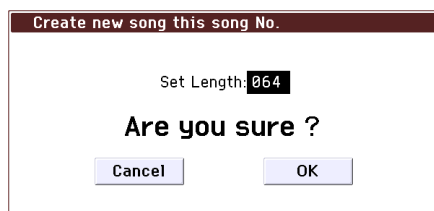

4. Use “Set Length” to input the desired number of measures and press the **OK** button.

You can change the number of measures later if desired. For details, please see “Set Song Length” on page 176 of the Parameter Guide.

5. Press the **OK** button to create the song.

Tip: You can use the **ENTER** button instead of the **OK** button.

Track settings

Since we’re going to record a new song in this example, we will start by explaining how to assign a program to each track, and adjust basic settings such as volume.

1. Assign a program to each track.

Use “Program Select” to assign a program to each track. The method is the same as when assigning a program to a timbre in a combination (see page 46).

You can copy various settings from Programs or Combinations. (See pages 166, 167 of the Parameter Guide.)

2. When assigning a program, you can use **Track Select** to choose the track to which you wish to assign a program, and audition the sound.

3. Set the pan and volume of each track.

Press the Mixer 1–8 tab (or the Mixer 9–16 tab) to access the Mixer T01–08 page (Mixer T09–16 page).

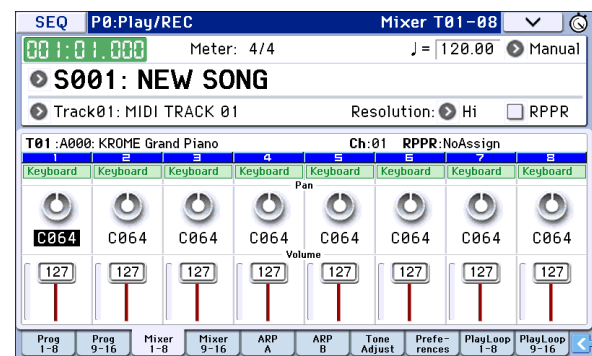

- **Pan** sets the pan position of each track, and **Volume** sets the volume level of each track.

4. Specify the tone generator and MIDI channel that will be played by each track.

Press the **PAGE** button to access SEQ Page Select, and press “P3 Track Parameters” The P3: Track Parameters page will appear. Press the MIDI 1–8 tab (or the MIDI 9–16 tab) to access the MIDI T01–08 page (MIDI T09–16 page).

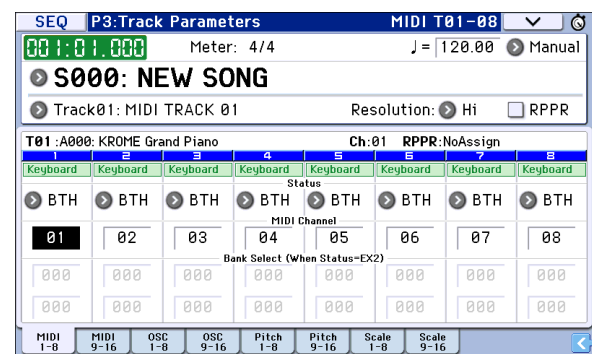

- Use **Status** to specify whether each track will play the internal and/or external sound generator.

Normally when using the KROME, you will select **INT** or **BTH**.

INT: During playback, the KROME’s internal tone generator will play the MIDI data recorded on that track. When you use the KROME’s keyboard or

controllers, you will be playing and controlling the track selected by **Track Select**.

EXT, EX2, BTH: During playback, the MIDI data recorded on that track will be transmitted from MIDI OUT to play an external sound module. When you use the KROME's keyboard or controllers, MIDI data will be transmitted to play and control the external sound module selected by **Track Select**. (The MIDI channel of the external tone generator must be set to match the **MIDI Channel** of KROME tracks that are set to EXT, EX2 or BTH.)

If **Status** is set to BTH, both the external tone generator and internal tone generator will be played and controlled.

- Use **MIDI Channel** to specify the MIDI channel for each track.
Normally you will set the **MIDI Channel** to a different channel: 1–16 for each track. Tracks that are set to the same MIDI channel will sound simultaneously when you record or play back either of the tracks.

5. Adjust the effect settings.

Adjust settings for each effect in P8: Routing/IFX and P9: MFX/TFX/LFO.

For details, please see “Using effects in Combinations and Songs” on page 81.

6. Set the tempo and time signature.

- To set the tempo, you can turn the TEMPO knob or press the TAP button at the desired interval.
Alternatively, you can select **♩ (Tempo)** in the P0: Play/REC– Program T01–08 page (or similar page), and use the VALUE controllers to set the tempo. Set **Tempo Mode** to Manual.
- Next you will set the time signature. In this example, we'll explain how to set the time signature using the “Meter” field. Normally, you specify the time signature before recording the first track, and then begin recording.

- Press the SEQUENCER REC (●) button, and set “Meter” to **/**.
- Press **/** to highlight it, and use the VALUE controllers to set the time signature.
- Press the START/STOP (▶ / ■) button to begin recording. When the pre-count has ended and Locate reaches 001:01:000, press the START/STOP (▶ / ■) button to stop recording. The time signature you specified has now been recorded on the Master track.
If you press the START/STOP (▶ / ■) button during the pre-count, the time signature won't be recorded.

7. Set the “REC Resolution” if necessary.

When you record in real time on a track, this parameter specifies how the timing of the recorded MIDI data will be corrected. The timing will also be corrected when you record automation data in real time on an audio track. (Data that was already recorded will not be corrected.)

For example, let's suppose that you recorded some eighth notes in real time, but your timing was not quite perfect, as shown in part 1 of the illustration below. If **REC Resolution** were set to ♩ when you recorded, the timing would automatically be corrected as shown in part 2 of the illustration. If **REC Resolution** is set to Hi,

the notes will be recorded with the timing at which you play them.



8. Make other settings as necessary.

You can adjust the settings for the arpeggiator (P7: ARP/DT), MIDI filtering (P5: MIDI Filter), etc. (See page 89)

You may also wish to use Tone Adjust to tweak the sound. When you are finished making these settings, the basic setup is complete.

Saving your song parameter settings

The song parameter settings you create here can be saved as a template. If you use these settings frequently, you can simply load one of the templates you've saved.

For details, please see “Save Template Song (Save as User Template Song)” on page 164 of the Parameter Guide.

Using template songs

Loading a template song is an easy way to create settings appropriate for a particular musical style. You can also assign a drum pattern to a track at the same time.

- In the P0: Play/REC page, press the menu button and choose “Load Template Song.”**

A dialog box will appear.

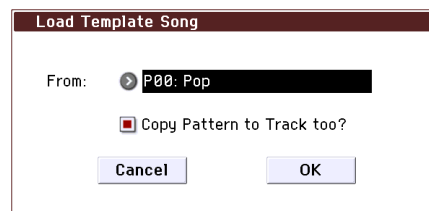

- In the “From” field, choose the template song you want to load.**
- If you check “Copy Pattern to Track too?”, a dialog box for copying a pattern will automatically appear after you execute the “Load Template Song” operation.**

If you execute the command without checking this, only the template song you selected in step 2 will be loaded.

- Press the OK button to load the template song, or press the Cancel button if you decide to cancel.**

When you perform this operation, song settings other than track Loop and RPPR will be copied.

If you executed this operation with **Copy Pattern to Track too?** checked in step 3, the **Copy Pattern To Track** dialog box will appear.

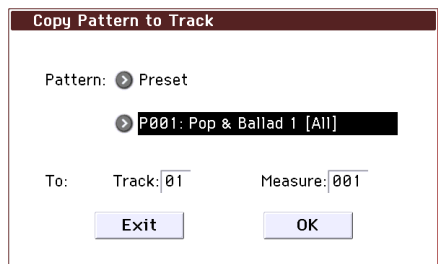

This dialog box is the same as the one that appears for the **Copy To Track** (P10: Pattern/RPPR– Pattern Edit) menu command.

5. In the “Pattern” field, select the pattern that you want to copy.

In the **To Track** field, select the copy-destination track.

In the **Measure** field, specify the starting measure of the copy-destination.

Following the pattern name for each of the 605 preset patterns, the musical style and the name of the most suitable Drums category program are partially displayed.

By loading a drums track and the corresponding preset pattern, you can instantly set up a drum track appropriate for each preset template song.

6. To execute this operation, press the OK button.

When you execute this procedure, the **Measure** field will count up automatically, showing how many measures of the selected pattern have been placed in the selected song. You can then copy another pattern if desired, or add more measures of the same pattern. When you’re finished, press the Exit button.

Copying the settings of a combination or program

You can copy the settings of a combination or program into the sequencer.

This can be done in the following ways.

- **Auto Song Setup**
Auto Song Setup is a function that copies the settings of the selected combination (in Combination mode) or program (in Program mode) to the song in Sequencer mode.
- Menu commands **Copy From Combi** or **Copy From Program**. (See pages 166, 167 of the Parameter Guide)
In Sequencer mode, you can use these page menu commands to copy the desired settings.

Auto Song Setup function

1. Enter Combination mode.
2. In P0: Play page, select the desired combination and edit the Arpeggiator etc. as desired.

Note: If you want to save the edited state of the combination, use the **Write Combination** menu commands.

3. Press the REC (●) button. Alternatively, select the page menu command “Auto Song Setup.”

The **Setup to Record** dialog box will appear.

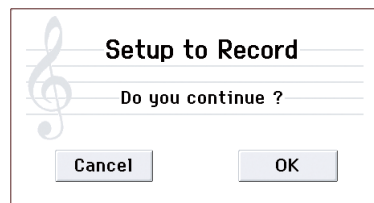

4. To execute the Auto Song Setup function, press the REC (●) button or the OK button. If you decide not to execute, press the Cancel button.

You will automatically move to Sequencer mode, and the settings of the combination will be copied to the song.

The first unused song will be the copy-destination song.

Contents automatically copied from a combination

The copied contents will be the same as when you execute the menu command **Copy From Combi** with the following settings in the dialog box. (See page 166 of the Parameter Guide)

- IFXs, MFXs, TFX checked
- **Auto Adjust Arp** setting for Multi REC checked

Contents automatically copied from a program

The copied contents will be the same as when you execute the menu command **Copy From Program** with the following settings in the dialog box. (See page 167 of the Parameter Guide)

- IFXs, MFXs, TFX checked
 - **Arp** checked
 - **To** set to Track 01
 - **Arp** set to A
 - **with Drum Track** checked
 - **To: Drum Track** set to Track 10
 - Check Recording Setup **Multi REC**
 - Set the **Play/Rec/Mute** setting to REC for tracks 01 and 10 (see page 101 of the Parameter Guide).
5. The KROME will automatically enter record-ready mode, and the metronome will sound according to the Metronome setting (See page 119 of the Parameter Guide).
 6. Press the START/STOP (▶ / ■) button to begin realtime recording. To stop recording, press the START/STOP (▶ / ■) button once again.

Recording MIDI in real time

When you've finished with "Preparations for recording," you can start recording.

This is a method of recording what you're playing on the keyboard and your controller usage, in real time. This method of recording is normally used one track at a time, and is called single track recording.

As an alternative, multitrack recording allows you to simultaneously record multiple channels of data onto multiple tracks. This is the method you will use when using the Drum Track function, the RPPR function, and the arpeggiator to record multiple tracks of musical data at once, or when you play back existing sequence data on an external sequencer and record it onto KROME's sequencer in real time.

Recording setup

In P0: Play/REC– Preferences page **Recording Setup**, select the realtime recording method you want to use.

Overwrite

By default, this recording method is selected.

This will record your performance by overwriting any previously recorded data. All data following the measure where you start recording will be erased.

Normally you will use this method to record, and then modify the results by using other types of real-time recording or MIDI event editing.

1. Use Track Select to choose the track that you want to record.
2. Set the Recording Setup to Overwrite.

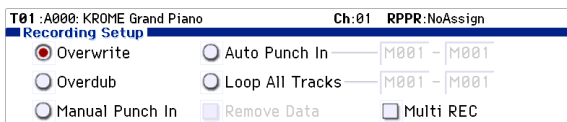

3. In "Location," specify the location where you wish to begin recording.



4. Press the SEQUENCER REC (●) button, and then press the START/STOP (▶ / ■) button.

If the **Metronome Setup** is still set to the default settings, the metronome will sound for a two-measure pre-count, and then recording will begin. Play the keyboard and move controllers such as the joystick to record your performance.

5. When you finish playing, press the START/STOP (▶ / ■) button.

Recording will end, and the location will return to the point where you begin recording.

If you press the PAUSE (||) button instead of the START/STOP (▶ / ■) button, recording will pause. When you press the PAUSE (||) button once again, recording will resume where you left off before pausing. When you are finished, press the START/STOP (▶ / ■) button to stop recording.

The following recording setup parameters are also available.

Overdub

Select this method if you wish to record additional performance data by overdubbing it without erasing the previously-recorded data.

Manual punch-in

Select this method when you wish to use the SEQUENCER REC (●) button or a foot switch to re-record selected portions of a previously-recorded track.

Auto punch-in

Select this method when you wish to automatically re-record selected portions of a previously-recorded track.

Then, recording will occur only over the specified area (**Auto Punch In Start Measure–Auto Punch In End Measure**), rewriting it with the newly recorded data.

Loop All Tracks

Select this method when you wish to repeatedly record over a specified area of a track, while continuing to add data. This is suitable for creating drum patterns, etc.

For details, please see "An example of realtime recording" on page 61.

Multi (multitrack recording)

Use MIDI multi-track recording if you want to simultaneously record multiple tracks of different channels, such as when recording the output of the drum track, arpeggiator or RPPR functions, or when recording from an external multi-track sequencer.

An example of realtime recording

In this example, we'll assign a drum program to track 01 and create the following one-measure drum phrase.

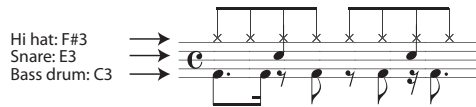

1. Create a new song, and specify a drum program for track 01.

Use **Track Select** to select track 01, and verify that you hear a drum program. (See page 57)

2. Access the P0: Play/REC– Preferences page. In Recording Setup, specify “Loop All Tracks” and set it to M001-M001 (see page 117 of the Parameter Guide).

With this setting, measure 1 will be recorded repeatedly. The newly recorded data will be added at each pass.

3. Set “REC Resolution” to ♩. (See page 58)

4. Press the SEQUENCER REC (●) button, and then the START/STOP (▶ / ■) button.

The metronome will sound a two-measure count-down, and then recording will begin.

5. As shown in the musical example printed above, start by playing the C3 note of the keyboard to record the bass drum for one measure.

6. Next, play the E3 note of the keyboard to record the snare for one measure, and then the F#3 note to record the hi-hat.

7. Press the START/STOP (▶ / ■) button to stop recording.

8. Play back the result, and listen to the drum performance that you recorded.

Press the START/STOP (▶ / ■) button. When you've finished listening, press the START/STOP (▶ / ■) button once again to stop playback.

9. If you're not satisfied with the result, press the COMPARE button to return to the state prior to recording, and then re-record from step 4.

Note: When you're finished recording, change the Recording Setup back to the normally-used **Overwrite** (P0: Play/REC– Preferences page).

In addition, access the P0: Play/REC– Play Loop T01–08 page, check **Track Play Loop** for track 01, and set the **Loop Start Measure** and **Loop End Measure** to 001. When you play back, track 01 will repeatedly play the first measure.

Step recording

Step recording is the recording method where you specify the duration and strength of each note, and use the keyboard to specify the pitch of each MIDI note.

You can use the Rest button and Tie button of the dialog box to input rests and ties.

Step recording is useful when you want to create mechanically precise beats, or when you need to record a phrase that would be difficult to play by hand “in real time,” or when you find it difficult to play extremely complicated or rapid passages.

An example of step recording

In this example, we'll assign a bass program to track 02 and step-record the following two-measure bass phrase.



Note	Step Time: Select	Step Time: . 3 -	Key, Button	Measure/ Beat Tick
C3	♪	.	C3 key	001 / 01.000
G3	♪	-	G3 key	001 / 01.360
♩	♪	-	Rest button	001 / 02.000
C4	♪	-	C4 key	001 / 02.240
♩	♪	-	Rest button	001 / 02.360
C4	♪	-	C4 key	001 / 03.120
D3	♪	-	D3 key	001 / 03.240
Eb3	♪	-	Eb3 key	001 / 04.000
E3	♪	-	E3 key	001 / 04.240
F3	♪	-	F3 key	002 / 01.000
♩	♪	-	Rest button	002 / 01.120
C3	♪	-	C3 key	002 / 01.360
♩	♪	-	Rest button	002 / 02.000
F2	♪	-	F2 key	002 / 02.240
Tie	♪	-	Tie button	002 / 03.000
F2	♪	-	F2 key	002 / 03.240
♩	♪	-	Rest button	002 / 03.360
A2	♪	-	A2 key	002 / 04.000
A3	♪	-	A3 key	002 / 04.240
♩	♪	-	Rest button	002 / 04.360

1. Specify a bass program for track 02. Use Track Select to select track 02, and verify that you hear a bass program.

2. Access the P6: Track Edit– Track Edit page.

3. Set "From Measure" to 001.

With this setting, step recording will begin from measure 1.



4. Press the menu button, and press menu command "Step Recording."

A dialog box will appear.

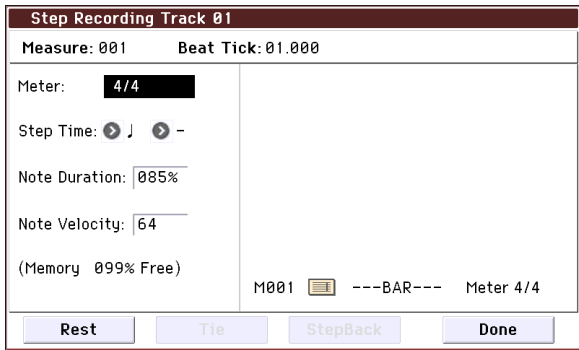

5. In "Step Time," use "Select" to specify the basic timing value.

Input the first C3 note as ♩. (dotted eighth note).

Use the popup button to the left to select ♩.

You can choose a note value ranging from a whole note (♩) to a 32nd note (♩).

Input a dotted note by selecting "." with the popup buttons at right.

You can specify "3" to input a triplet. If you want to use the unmodified length of the note that's selected at the left, choose "-".

"Note Duration" indicates the length that the note itself will sound. Smaller values will produce a staccato note, and larger values will produce a legato note. For this example, leave this setting unchanged.

"Note Velocity" is the velocity (playing strength), and larger values will produce a louder volume. Set this to Key.

If you select Key for this parameter, the velocity of how you actually play the keyboard will be input.

6. On the keyboard, press and then release the first C3 note that you want to input.

The data you input will appear in the display as numerical values. On the upper right side, Measure 001 Beat Tick 01.000 will change to Measure 001 Beat Tick 01.360. The next note you input will be placed at this location.

7. As described in steps 5 and 6, input the notes and rests that follow the first C3 note.

In addition to the methods described in steps 5 and 6, you can also use the following input methods.

- To input a rest, press the Rest button. This will input a rest of the selected Step Time value.
- To enter a tie, so that two or more notes of the same pitch will be played as a single unbroken note, press the Tie button. When you press the Tie button, the previously-input note will be extended by the Step Time length.
- To delete a note or rest that you input, press the Step Back button. The previously-input note will be deleted.
- To input a chord, simultaneously press the notes of the desired chord. Even if you do not press them simultaneously, notes that are pressed before you fully remove your hand from all keys on the keyboard will be input at the same location.
- To audition a note without actually inputting it, press the PAUSE (||) button. Now when you play a note on the keyboard, it will sound, but the note will not be actually input. In this state, playing a key will produce a sound, but will not input a note. Press the PAUSE (||) button once again to cancel the record-pause state, and resume inputting notes.

8. When you are finished recording, press the Done button.

Press the SEQUENCER START/STOP (▶/■) button to play back.

Access the P0: Play/REC- Play Loop T01-08 page, check Track Play Loop for track 02, set Loop Start Measure to 001, and Loop End Measure to 002. track 02 will play measures 1-2 repeatedly.

9. If you're not satisfied with the result, press the COMPARE button to return to the state prior to recording, and then re-record from step 4.

⚠ When you begin step recording, all data in the track that follows the measure where you began recording will be erased. You need to be aware of this if you begin step recording from a measure mid-way through the song.

If you want to copy data into a measure that already contains data, perform step recording in an empty track, and use the Move Measure or Copy Measure menu commands. (See page 179 of the Parameter Guide)

If you want to edit or add to the recorded data, you can use the Event Edit or Piano Roll function. (See pages 169, 171 of the Parameter Guide)

Recording multiple tracks from an external sequencer

The playback from an external MIDI sequencer connected to the KROME can be recorded simultaneously using multi-recording.

1. Make sure that the MIDI OUT of your external sequencer is connected to the MIDI IN of the KROME.

If it is not connected, turn off the power, make the connection, and then turn the power on.

2. In the Global P1: MIDI– MIDI Basic page, set MIDI Clock to External MIDI. With this setting, the KROME will synchronize to MIDI clock messages from your external sequencer.

Make sure that Receive Ext. Realtime Commands is checked.

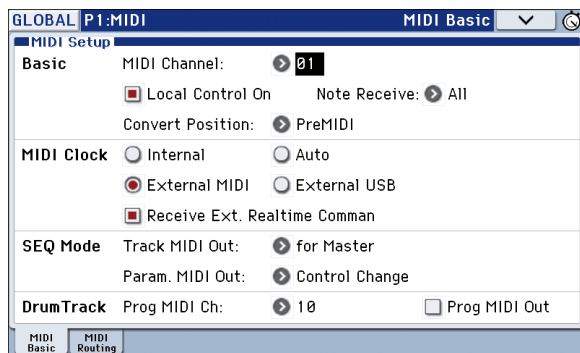

3. Create a new song in Sequencer mode, and in the P0: Play/REC– Preferences page, check the Multi REC check box. Set Recording Setup to Overwrite.



4. Press Play/Rec/Mute to select “REC” for the tracks you want to record.

For the tracks you don't want to record, select Play or Mute.



5. In the P3: Track Parameters– MIDI T01–08 and T09–16 page, use MIDI Channel to specify the MIDI channel of each track.

Set the MIDI channel of each KROME track to match the MIDI channel of each external sequencer track. Data from each channel will be recorded on the corresponding KROME track.

Make sure that Status is set to INT or BTH.

6. Press the LOCATE (⏮) button to set the location to 001:01.000.

7. Press the SEQUENCER REC (●) button to enter record-standby mode.

8. Start your external sequencer.

The KROME's sequencer will automatically begin recording when it receives the MIDI Start message transmitted by your external sequencer.

9. When playback has ended, stop your external sequencer.

The KROME's sequencer will automatically stop recording when it receives the MIDI Stop message transmitted by the external sequencer. You can also stop recording by pressing the START/STOP (▶/■) button on the KROME.

After this, you can play back the newly recorded sequence:

10. In the Global P1: MIDI– MIDI Basic page, set MIDI Clock to Internal.

Set Tempo Mode to Auto in the Seq P0: Play/REC– Program T01–08 page.

Press the START/STOP (▶/■) button to play back.

Note: If the correct sounds are not selected when you start playing back, you may be able to solve the problem by using the menu command Event Edit (P6: Track Edit) to re-specify the Program Change data.

Recording System Exclusive events

Exclusive messages received from an external MIDI device or the parameter changes produced when you edit a track parameter or effect parameter can be recorded in real time on any track.

During playback, the exclusive messages you recorded will control the track parameters and effect parameters of the song, and can be sent to external MIDI devices.

Note: You can use the menu command **Put Effect Setting to Track** to insert an exclusive event containing the parameter settings for an insert effect, master effect or total effect into the desired location of a track, so that these settings will automatically switch during playback.

MIDI GM, XG, and GS exclusive messages can be recorded on a track, but the KROME's tone generator will not respond to these messages.

Recording internal parameter changes

You can use SysEx for automation of internal KROME effects and Program parameters.

Here we'll explain how to record internal parameter changes. As an example, we'll explain how parameter changes recorded on a different track can be used to modify the parameters of the insert effect (IFX1) applied to the program of track 1.

Note: In order to record system exclusive messages, make sure that the Global P1: MIDI- MIDI Routing setting **Enable Exclusive** is checked. Go to Global mode and verify that this is checked.

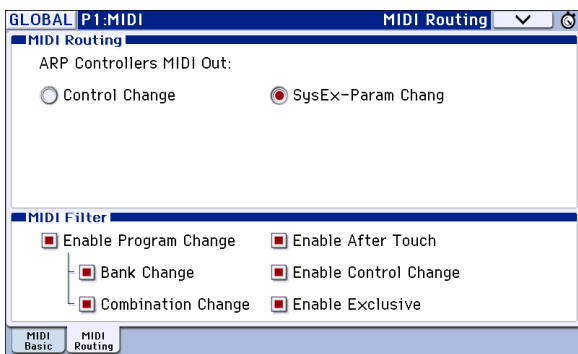

1. Select the desired program for MIDI track 1, and route it to IFX1. Then record a phrase of about sixteen measures.
 - In the P0: Play/REC- Program T01-08 page, use "Program Select" to select the desired program for MIDI Track 01.
 - In the P8: Routing/IFX- Routing T01-08 page, route the MIDI Track 01 **Bus (IFX/Output) Select** to IFX1. Then in the P8: Routing/IFX- Insert FX Setup page, select the desired effect for IFX1.
 - Select MIDI Track 01 in **Track Select**. Then press the SEQUENCER REC (●) button and then the START/STOP (▶/■) button, and record a phrase of about sixteen measures.

2. Select Track 09 in "Track Select," and record parameter changes as desired.

Note: For this example, select an empty track. If you want to record onto a MIDI track that already contains data, set the P0: Play/REC- Preferences page **Recording Setup** to "Overdub," as described on page 60.



- Select Track 09 in **Track Select**. Then press the SEQUENCER REC (●) button and then the START/STOP (▶/■) button, and begin recording.
- At the appropriate time while recording, adjust the parameter(s) that you want to realtime-record.

In the P8: Routing/IFX- Insert FX Setup page, select another effect for IFX1, and modify the effect parameter values.

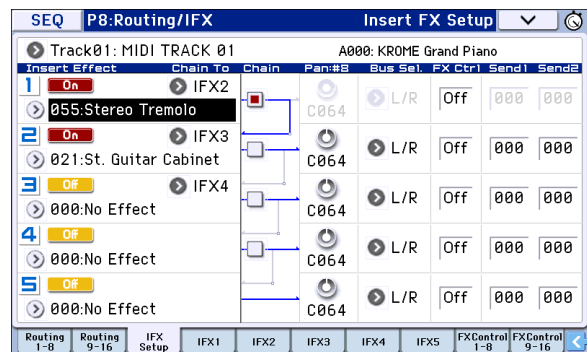

Note: In addition to effect parameter changes, you can also record parameters such as sound parameters. For details on the parameters that can be recorded, please see page 191 of the Parameter Guide.

3. Stop recording.

Note: Exclusive messages are always recorded on the current track selected by **Track Select**. In this example, they are recorded on MIDI track 9.

Note: In the MIDI event edit page you can view the recorded exclusive events and their location. Exclusive events are displayed as "EXCL".

To view these events, go to the P6: Track Edit- Track Edit page, and select the menu command **MIDI Event Edit**. Then in the Set Event Filters dialog box, check **Exclusive** and press the OK button.

⚠ Exclusive events cannot be changed to a different type of event. Nor can other events be changed into exclusive events.

4. If you go to the page (e.g., P8: Routing/IFX) that shows the parameters you adjusted in realtime, you can watch the recorded changes be reproduced while the song plays back.

Exclusive messages that will be recorded during realtime recording

The following exclusive messages will be recorded. (See page 191 of the Parameter Guide)

- Exclusive messages received from an external MIDI device.
- Parameter changes in Sequencer mode.
- Master Volume universal system exclusive messages assigned to a foot pedal or knob.

Using realtime controls to record changes in a MIDI track's pan, EQ, volume, and tone adjust

By controlling the pan, EQ, volume, and tone adjust parameters during realtime recording, you can record these changes so that they will be reflected during playback.

Use multi-track recording if you want to modify the settings of multiple tracks simultaneously.

Note: Controlling these parameters will transmit control change or system exclusive messages. In order for this data to be recorded, the Global P1: MIDI- MIDI Routing **Enable Control Change** and **Enable Exclusive** settings must be checked. Go to Global mode and verify that these items are checked.

Note: Use **Param. MIDI Out** in Global P1: MIDI Basic page to specify whether control change messages or system exclusive messages will be transmitted when you edit the Pan (CC#10), Volume (CC#7), or Send 1/2 level (CC#93 and CC#91) parameters.

In this case, the Global P1: MIDI- MIDI Routing settings **Enable Control Change** and **Enable Exclusive** must be checked respectively.

Recording patterns

Recording and editing patterns

You can record patterns in either of two ways; realtime recording or step recording. However, pattern realtime recording differs from song realtime recording in that you can use only Loop type recording.

You can edit patterns by using Event Edit operations to modify the recorded data or insert new data. You can also use the **Get From Track** menu command to convert a desired region of performance data from a MIDI track into a pattern. Conversely, you can use the **Put to Track** or **Copy to Track** menu commands to place or copy the performance data from a pattern into a MIDI track.

In addition, you can use the "Convert to Drum Track Pattern" page menu command to convert a user pattern to a drum track pattern. (See "Converting to a Drum Track pattern" on page 103)

Recording patterns in real time

When realtime-recording a pattern, a pattern of the specified number of measures will play back repeatedly, allowing you to continue adding musical data to it.

1. Create a new song, and as described in "Preparations for recording" on page 57, set the track to the program that will be used by the pattern.
2. Access the P10: Pattern/RPPR- Pattern Edit page.

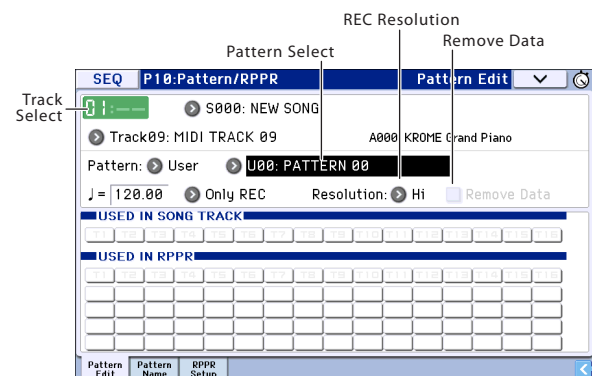

3. Use **Track Select** to choose the track that you will use to record the pattern.

The pattern will play back with the program and other settings of the selected track.

4. Set "Pattern (Pattern Bank)" to **User**, and set "Pattern Select" to **U00**.

User patterns U00-U99 can be created for each song.

5. Select the menu command "Pattern Parameter".

A dialog box will appear.

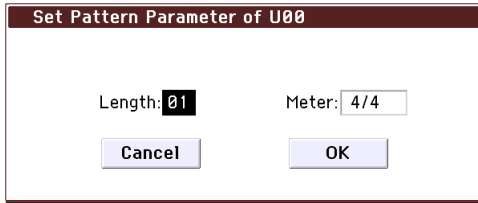

6. Set the number of measures in the pattern to a "Length" of 04 (four measures), and set "Meter" to a time signature of 4/4. Press the OK button.
7. As necessary, set "REC Resolution" to apply realtime quantization.
8. Begin realtime recording.

You can record in the same way as you did when recording tracks with Loop All Tracks. (See "Loop All Tracks" on page 60)

Press the SEQUENCER REC (●) button, and then press the START/STOP (▶ / ■) button.

After the pre-count, pattern recording will begin. Play the keyboard and use the joystick and other controllers to record your performance.

When you reach the end of the pattern, the sequencer will return to the beginning of the pattern and continue recording. If you continue recording, the newly recorded data will be added to the previously-recorded data.

9. If you want to delete specific data while you continue pattern recording, you can press the REC (●) button or check the "Remove Data" check box.

For details refer to step 6 of "Loop All Tracks" on page 60.

10. Press the START/STOP (▶ / ■) button to stop recording.

If you made a mistake or decide to re-record, press the START/STOP (▶ / ■) button to stop recording, and press the COMPARE button. Then begin the pattern recording procedure again as in step 8.

Other way to record

Using the Drum Track function and the arpeggiator to record on multiple tracks simultaneously

You can use multi-recording to simultaneously record a multi-track performance using the Drum Track function and arpeggiator.

For details, please see "Recording MIDI in real time" on page 60.

Using the RPPR function to record on multiple tracks simultaneously

You can use multi-recording to simultaneously record a multi-track performance using the RPPR function.

For details, please see "Creating an RPPR pattern" on page 71.

Song editing

You can apply a variety of editing procedures to a song. The available types of editing procedures are listed below.

Song

Load (Save) Template Song: Loads a song template into the song (or saves a song as a template) (see page 58).

Copy From Combination/Copy From Program: Copies the settings of the specified combination/program to the settings of the song that's currently selected.

Copy From Song: This command copies all of the setting data and musical data from the specified song to the song that's currently selected.

Rename song: Renames the selected song. You can enter up to 24 characters.

Delete Song: This command deletes the currently selected song.

FF/REW Speed: This allows you to set the speed at which fast-forward or rewind will occur when you press the FF (▶▶) button or REW (◀◀) button.

GM Initialize: This command transmits a GM System On message to the Sequencer mode, resetting all MIDI tracks to the GM settings.

Set Song Length: This command changes the length of the specified song. When it is executed, the length of the master track will change, and the number of measures played will change.

MIDI tracks

Tracks

Step Recording: This allows you to specify the length and velocity of each note numerically, and to input MIDI data, the pitches, from the keyboard. You can use the Rest button and Tie button to enter a rest or tie.

Event Edit: Here you can edit individual events of MIDI data.

Piano Roll: Allows you to edit notes, velocities, and control changes in the piano roll screen. By selecting and dragging events in the screen, you can edit their pitch or timing, or delete or add events.

Erase Track: This command erases the data from the specified track. It is not possible to erase the master track by itself.

Copy Track: This command copies musical data from the copy source track to the specified track.

Bounce Track: This command combines the musical data of the bounce source and bounce destination tracks, and places the combined data in the bounce destination. All musical data in the bounce source will be erased.

Erase Measure: This command erases the specified type(s) of musical data from the specified range of

measures. The Erase Measure command can also be used to remove only a specific type of data. Unlike the Delete Measure command, executing the Erase Measure command does not cause the subsequent measures of musical data to be moved forward.

Delete Measure: This command deletes the specified measures. When the Delete Measure command is executed, the musical data following the deleted measures will be moved towards the beginning of the sequence.

Insert Measure: This command inserts the specified number of measures into the specified track. When you execute the Insert Measure command, the musical data following the insert location will be moved backward.

Repeat Measure: This command repeatedly inserts the specified measures for the specified number of times. When you execute the Repeat Measure command, the measures will be inserted following the measure specified by **To End of Measure**, and musical data following the inserted data will be moved backward.

Copy Measure: This command copies the measures of musical data specified as the "From" source to the beginning of the measure specified as the "To" location. When you execute the Copy Measure command, the existing track data at the copy destination will be rewritten.

Move Measure: This command moves the specified measures of performance data to another measure. When you execute the Move Measure command, the performance data following the move-source measures will move forward by the corresponding number of measures, and the performance data following the move-destination will move backward (i.e., later in the song) by the same number of measures.

Create Control Data: This command creates control change, aftertouch, pitch bend, or tempo data in the specified region of a MIDI track or the master track.

Erase Control Data: This command erases data such as control changes, aftertouch, pitch bend, or tempo in the specified range.

Quantize: This command corrects the timing of MIDI data of the type you specify (note data, control change, aftertouch, pitch bend, program change, etc.) in the track. You can also adjust for swing.

Shift/Erase Note: This command shifts (moves) or erases the specified note numbers in a specified MIDI track and range of measures.

Modify Velocity: This command modifies the velocity values of notes in the specified area so that they will change over time according to a selected curve.

Create Exclusive Data: This command creates universal system exclusive messages or KROME parameter change messages in the specified region of a MIDI track.

Erase Exclusive Data: This command erases (deletes) universal system exclusive messages or KROME parameter change messages from the specified region. To delete all types of system exclusive message other than those listed above, set the Erase Measure command's "Kind" field to Exclusive, and execute the command.

Pattern

Step Recording (Loop Type): Here you can perform step recording into a pattern.

Event Edit: Here you can edit individual events of the musical data in a pattern.

Piano Roll: You can edit notes, velocities, and control changes in the piano roll screen.

Pattern Parameter: This command specifies the number of measures and the time signature of the selected pattern.

Erase Pattern: This command erases the data from the selected pattern.

Copy Pattern: This command copies the settings and musical data of the selected pattern to another pattern.

Bounce Pattern: This command combines the musical data of the bounce source pattern and bounce destination pattern, and places the combined musical data in the bounce destination.

Get From Track: This command takes musical data from a MIDI track and loads it into the specified pattern.

Put To Track: This command places a pattern into a MIDI track.

Copy To Track: This command copies the specified area of musical data from the specified pattern to a MIDI track as musical data.

Convert to Drum Track Pattern: This command converts a user pattern into a user drum track pattern, which can then be used with the Drum Track in any mode.

Load Drum Track Pattern: This command loads a user Drum Track pattern into a user pattern.

Erase Drum Track Pattern: This erases the specified Drum Track pattern.

Track view edit

Here we'll explain track view editing.

You can visually specify regions of measures in the display, and then move, copy, or erase them.

For each track, event data such as notes, velocities, and control changes are displayed (see the illustration below).

Your editing will apply to the highlighted measures. The range is shown in FROM MEASURE and To END OF MEASURE in the upper line.

You can move, copy, or erase data in units of measures.

Note: You can't specify a region of measures unless a tool is selected in the toolbox.

Examples of using the tools

Example)

Moving the events of measures 1–2 to measures 5–6

1. Press the  tool.
2. Drag over measures 1–2 to specify the edit region.

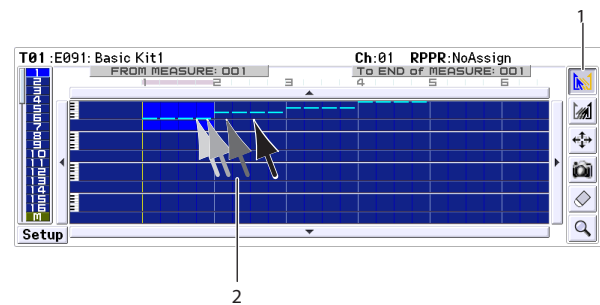

3. Press the  tool.
4. Press measure 5 (the move-destination measure).
Alternatively, drag the edit region to measure 5.

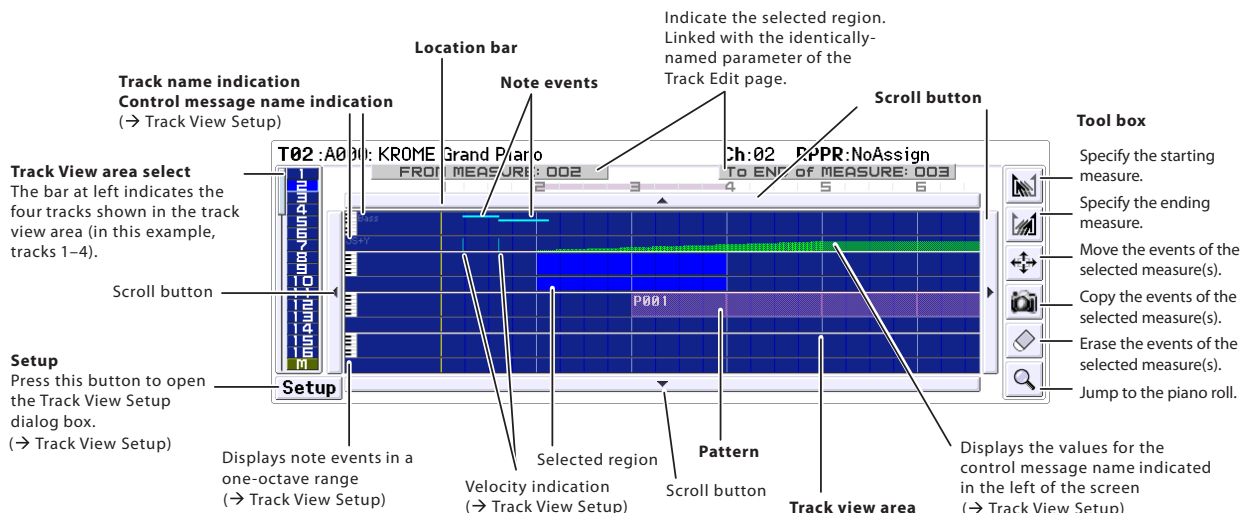
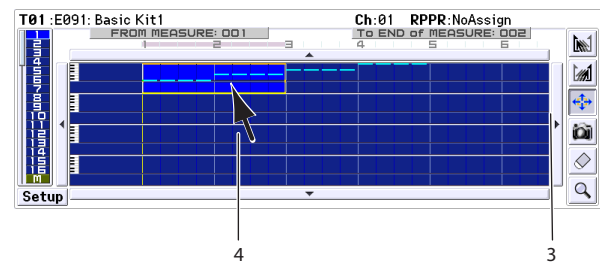

- In this example, an event exists in the move-destination measure, so the Drag Move dialog box will appear.

Overwrite will overwrite the source data over the destination data (replacing the destination data with the source data). Merge will combine the source and destination data.

Press the OK button to execute the move.

If there are no events in the move-destination measures, this dialog box will not appear; the move will occur immediately.

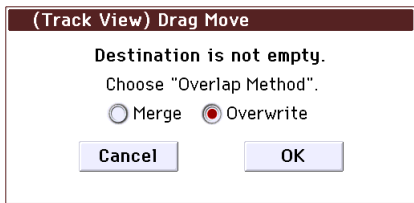

If you choose Overwrite

The destination is overwritten by the source data

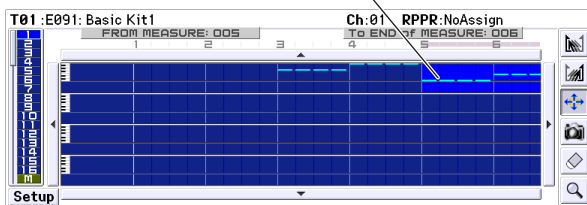

If you choose Merge

The two sets of data are combined

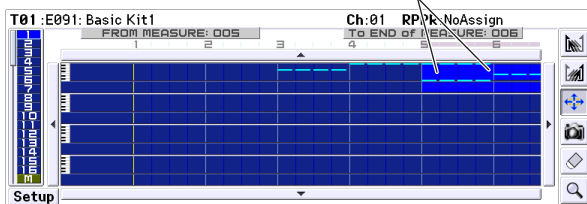

Example) Moving the data of an entire track

- Return the location to the beginning.
- Press the tool.
- Press the left side of measure 1 in the track you want to move.

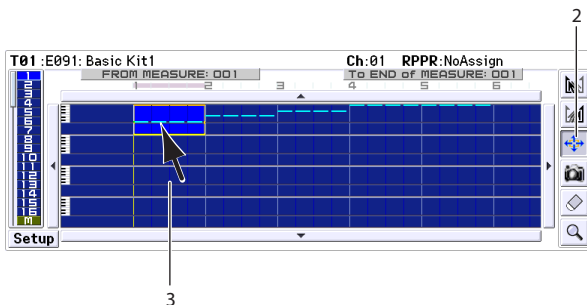

- While continuing to press, drag to the move-destination track, and release.

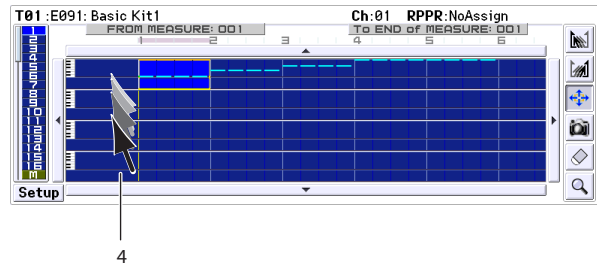

If the move-destination measures contain events, the Drag Move dialog box will appear.

Overwrite will overwrite the source data over the destination data (replacing the destination data with the source data). Merge will combine the source and destination data. Press the OK button to execute the move.

If there are no events in the move-destination measures, this dialog box will not appear; the move will occur immediately.

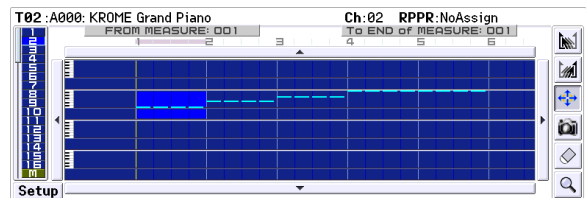

Example) Copying the events of measures 1–2 to measures 3–4

- Press the tool.
- Drag over measures 1–2 to specify the edit region.

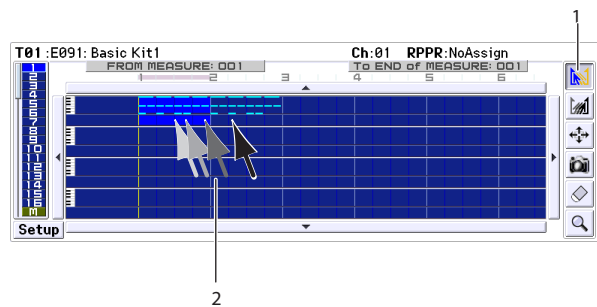

- Press the tool.
- Press measure 3 (the copy-destination measure). Alternatively, drag the edit region to measure 3.

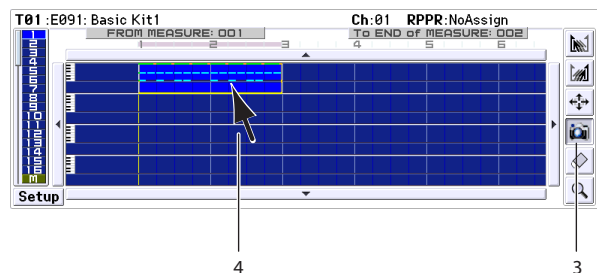

The copy will be executed.

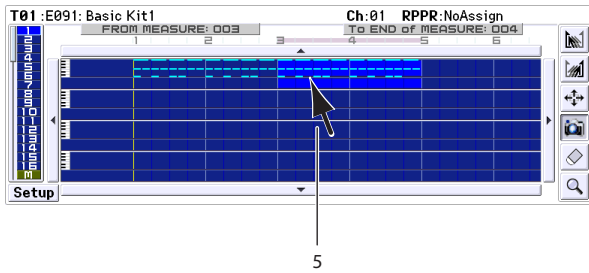

5. If desired, you can press another copy-destination to copy the data repeatedly.

Example) Copying the data of an entire track

You can copy the data of an entire track to another track.

Refer to "Example) Moving the data of an entire track."

In step 2, choose the tool.

Piano Roll Editing

Piano Roll editing lets you enter, edit, or delete event data such as notes, velocities, and control changes.

1. In the Seq P6: Track Edit- Track View page, specify the track and measure that you want to edit.
2. Select the tool in the Track View page or select "Piano Roll" from the menu commands to access the Piano Roll window. (See illustration below)
3. Make sure that the events you want to edit are displayed in the note view area at the upper part of the window or in the control view area at the lower part of the window.
 - Press the note view area selector, and use the value controllers.
 - Select the tool, and drag.
 - Enter "Meas" or "#" in the event list.
 - Use the view control zoom buttons to zoom-in/out.
 - Switch the view area height selector.
4. Use the tool box to select a tool, and edit the data.

Note: If you want to undo an edit, press the Undo button.
5. To play back the events, press the Play button. A dialog box will open, and the song will start playing. This allows you to check the results of your editing.
6. You can change settings such as the note resolution. Press the Setup button, and adjust the settings in the Piano Roll Setup dialog box.
7. When you're finished editing, press the Done button.

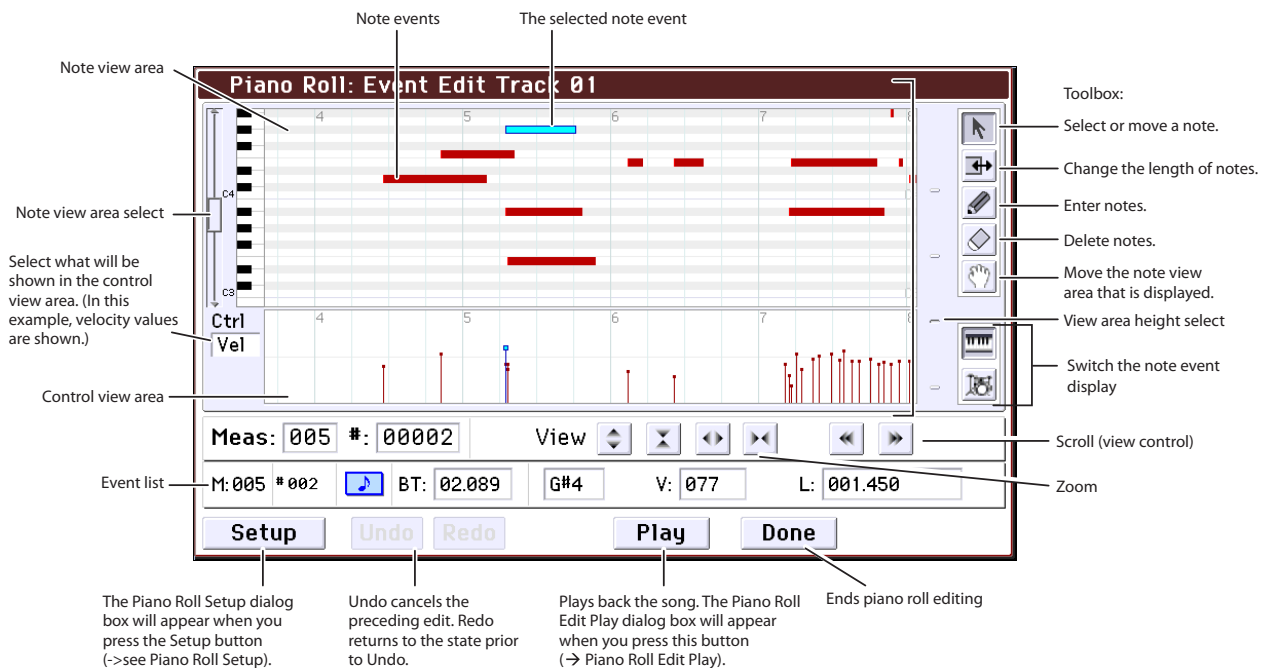

Creating an RPPR pattern

RPPR stands for Realtime Pattern Play/Recording, and is a function that lets you assign pattern data to each key, and then play back that pattern simply by pressing the key where it is assigned. You can realtime-record this performance.

Creating RPPR data

1. Create a new song, and choose a drum program for track 1.
 2. Access the P10: Pattern/RPPR– RPPR Setup page. In this page, the RPPR function is automatically turned on.
 3. Select the key where the pattern will be assigned.
 4. Select C#2.
- You can also change this setting by holding down the KEY edit cell and playing a note on the keyboard.
- Note:* C2 and lower keys are used to stop playback, and cannot be assigned patterns.
5. Check “Assign” for C#2.
 6. Set “Pattern Bank” to Preset, and set “Pattern Select” to P001.
 7. Set “Track” to Track01.

The selected pattern will be played according to the settings (program, etc.) of the track you select here.

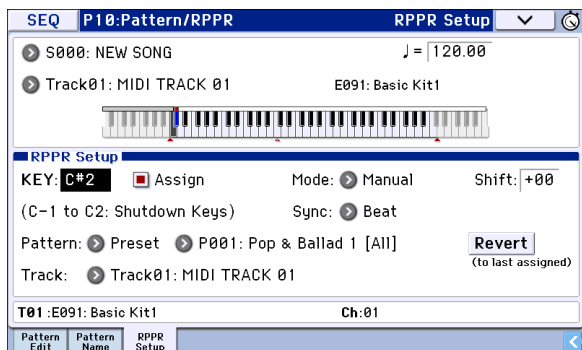

8. Assign patterns to other keys.
- For “KEY,” press the INC button to select D2.
9. Press the Revert button.
- The Assign, Pattern Bank, Pattern Select, and Track settings will be given the previously (steps 5–7) specified values.
10. Choose “Pattern Select,” and press the INC button to select P002.

By using Revert in this way, you can work efficiently when assigning contiguous (or nearby) pattern numbers or tracks.

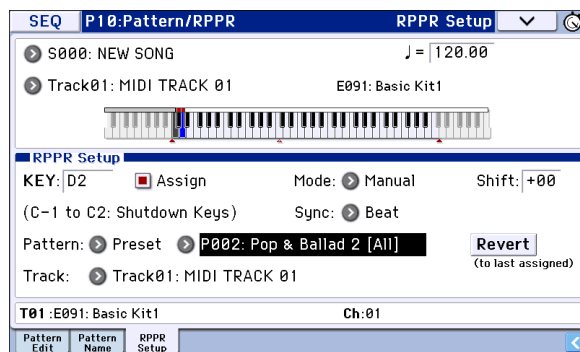

- As described above, assign several other patterns such as P003 and higher.
11. Press the C#2 key.
- The assigned pattern will play.
12. Take your finger off the C#2 key, and press the D2 key.

The pattern will change, and playback will begin. At this time, the pattern operation will depend on the Sync and Mode setting.

13. Set KEY to C#2, and set Sync to Measure. Make the same setting for D2.
- Now press the notes consecutively. Notice that the patterns function in a different way.

With the Measure setting, patterns will be handled in one-measure units. The second and subsequent patterns will start in sync with the end of pattern that was previously played.

- To stop playback, either press the same key once again, or press the C2 or lower key.
- For details on Sync, Mode, and Shift, please see page 158 of the Parameter Guide.

- The assigned keys are also shown in the keyboard graphic in the display.
- Keys where no patterns are assigned can be played normally. Use Track Select to select the track you want to play. For example you could assign backing patterns for drums or bass to keys C#2–B2 and use these keys to control the pattern playback, while using the keys C3 and above to play a solo performance in realtime. It’s a good idea to keep your RPPR assignments within a specific range of keys.

RPPR playback

Let's use the RPPR pattern that you created to perform in the P0: Play/REC– Program T01–08 page.

1. Access the P0: Play/REC– Program T01–08 page.

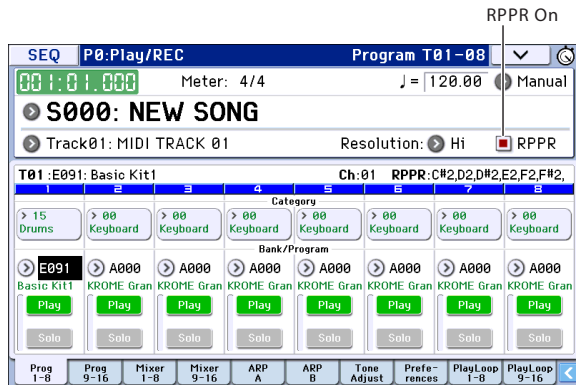

2. Check the “RPPR” check box.

The RPPR function will be turned on. Set the RPPR on/off for each song.

3. Play the keyboard, and patterns will begin playing according to the RPPR settings.

If you want to play RPPR phrases from an external MIDI device, you can control them on the MIDI channel of the track that's selected in **Track Select**.

- Pattern playback for keys where the **Sync** setting is Beat or Measure will synchronize to the pattern playback of the very first key played.
- If you are playing the pattern in synchronization (when **Sync** is Beat, Measure, or SEQ), the pattern will start accurately if you play the note slightly earlier than the timing of the beat or measure. Even if you play the note slightly later than the beat or measure (but no later than a 32nd note), it will be considered to have started at the beat or measure, and the beginning of the pattern will be compressed so that the remainder of the playback will be correct.

4. To turn off the RPPR function, uncheck the RPPR check box.

Play RPPR while a song plays back

RPPR can be played in synchronization with the playback of a song.

Pattern playback for a key with a **Sync** setting of SEQ will synchronize to the playback of the song. Start the song playback, and then press the key. The pattern playback will start in synchronization with the measures of the song.

Synchronization will be lost if you use the REW (⏮) or FF (⏭) buttons while a song is playing.

Note: If you want RPPR pattern playback to begin at the moment that song playback begins, it is a good idea to insert an empty measure containing no musical data before the song playback begins.

Note: If the song is stopped, the pattern will synchronize to the timing of the arpeggiator.

Realtime-recording an RPPR performance

You can record the realtime performance generated by RPPR.

Recording an RPPR performance

The RPPR playback can be recorded as performance data on the track(s) assigned to each pattern. This means that you'll use either single track recording or multi-track recording, as appropriate for the track settings or performance style of the RPPR you're playing.

On the other hand, even if RPPR uses only one track, use multi-track recording if you will be recording another track at the same time.

You should also select multi-track recording if you specified the RPPR data using multiple tracks rather than just a single track, and want to simultaneously record the performance of multiple tracks.

Here's how you can record an RPPR performance and a keyboard performance at the same time. Before you continue, use the P0: Play/REC– Program T01–08 page to assign a drum program to MIDI track 1, and a bass program to MIDI track 2.

1. Assign several keys starting with C#2 to preset patterns.

Check the C#2 **Assign** setting, and set **Pattern Bank** to Preset and **Pattern Select** to the desired preset pattern. For **Track**, select MIDI track 1 (Track 01) to which you assigned a drum program.

2. For each RPPR pattern, set **Sync** to SEQ.

With a setting of SEQ, RPPR patterns triggered while the sequencer is playing or recording will start in synchronization with the measures of the sequencer. (See page 158 of the Parameter Guide.)

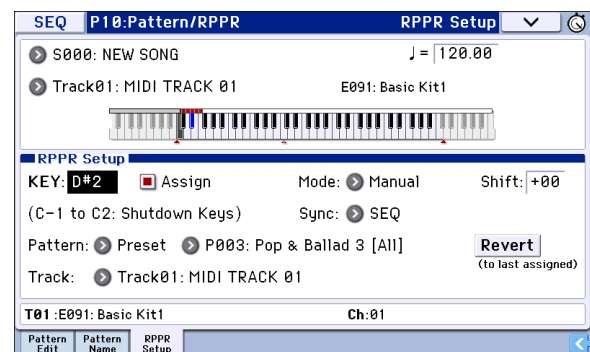

3. Access the P0: Play/REC– Program T01–08 page.
4. Check the “RPPR” check box, and set Track Select to MIDI Track 02.

If the RPPR check box is selected, the RPPR function will be turned on even in pages and tabs other than RPPR Setup, allowing you to perform with the RPPR function by pressing a key to which an RPPR is assigned.

Note: In the note range C#2 and above, keys to which no pattern has been assigned can be played to sound the program of the MIDI track selected by **Track Select**.

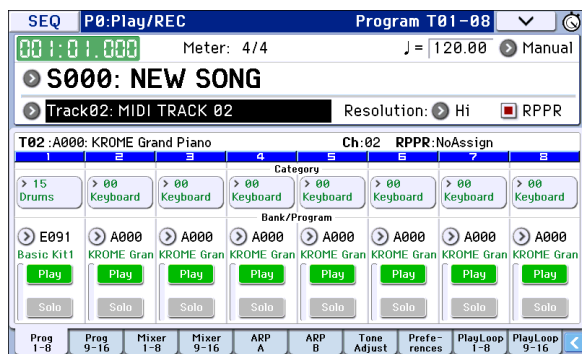

5. Since you want the tracks you play via RPPR and the track you play from the keyboard to be recorded at the same time, check the Multi REC check box.

Note: If Recording Setup is set to Loop All Tracks, it will not be possible to select Multi REC. Set the Recording Setup to Overwrite (see page 60).

6. Press the SEQUENCER REC (●) button to enter record-ready mode.
7. For the tracks you will be recording (MIDI Track 1, 2), press Play/Rec/Mute to make them indicate REC.

Make sure that the tracks you're not recording are indicated as Play or Mute.

8. Press the LOCATE (⏮) button to set the location to 001:01.000.
9. Press the START/STOP (▶ / ■) button, and then press a key that plays an RPPR pattern.

Then press the key where the RPPR pattern playback is assigned.

If the key where the RPPR is assigned is pressed during the pre-count before recording, RPPR pattern playback will start the moment that recording begins after the pre-count.

Record the RPPR pattern playback and keyboard performance.

- ⚠ When recording the playback of patterns triggered by RPPR, the timing of the recorded events may be slightly skewed. If this occurs, try setting REC Resolution to a setting other than Hi.

10. When you are finished performing, press the START/STOP (▶ / ■) button.

Recording will end, and the sequencer will return to the location where recording began.

If you made a mistake during your performance or would like to re-record, you can use the Compare function (press the COMPARE button) to re-record as many times as you wish.

11. If you want to record other tracks, un-check the Multi REC (See step 5) or "RPPR" (See step 4) check boxes as necessary.

Creating and playing a Cue List

A cue list allows you to play multiple songs in succession. You can create the individual sections of a song, such as the intro, melody A, melody B, chorus, and ending, and then use a Cue List to assemble these sections into a song by specifying the desired order and the number of repetitions for each section. You can then edit the cue list to efficiently try out different structures for your song.

You can also use this as a jukebox function that will play back completed songs in the order you specify.

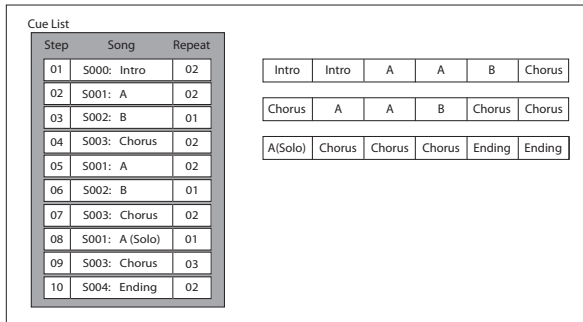

Creating a cue list

Each unit in a cue list is called a “step,” and each step contains a song number and the number of repeats.

For example, suppose you’ve created the songs S000: INTRO, S001: VERSE, and S002: CHORUS. Let’s use a cue list to connect these songs together.

1. Access the Seq P11: Cue List page.

With the default settings, song S000 will be selected for “Step” 01, and End will be selected for “Step” 02.

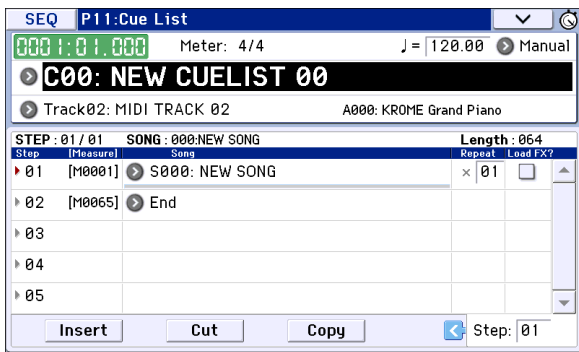

2. Add a song to the Step area.

Select the “Song” for Step 02, and press the Insert button. A song will be added to step 02. Press the popup button, and then choose S001: VERSE from the list.

In the same way, select the Step 03 “Song,” and press the Insert button to add a song to Step 03. Set this to S002: CHORUS.

When you press the Cut button, the selected step will be deleted and temporarily saved. When you press the Insert button, the song that was cut will be insert at the selected step.

If you press the Copy button, the selected step will be copied. If you press the Insert button, the copied step will be inserted.

3. Set the last step to End.

If you set this to Continue to Step01, the cue list will play back repeatedly.

4. In “Repeat,” specify the number of times that the song for that step will be repeated. For this example, set Step 02 S001: VERSE to 02.

5. Specify whether effect settings will also be switched when the song at each step is played back. If you want effect settings to change, check the “Load FX?” check box.

For this example, check the “Load FX?” check box for Step 01, which loads the effects.

6. To play back at the tempo that was specified for each song, set “Tempo Mode” to Auto.

If this is set to Manu (Manual), playback will use the tempo specified by “J=“.

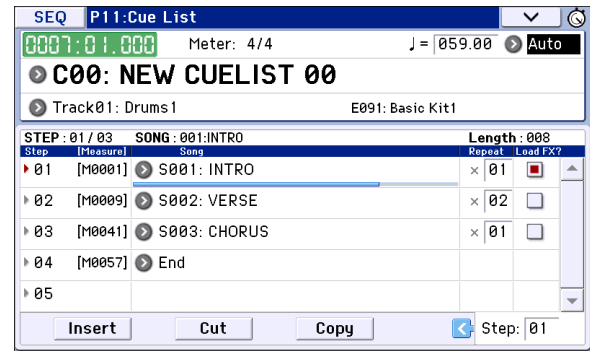

7. When you press the SEQUENCER START/STOP (▶/■) button, playback will begin from the step that is specified as the “Current Step.”

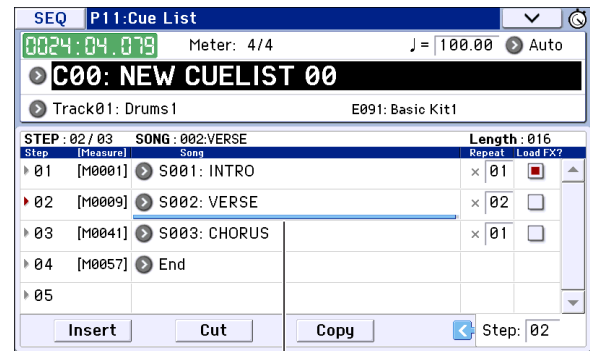

Song Position Bar

- **Step:** The arrow will indicate the step that’s currently playing. ▶ indicates the currently selected “Step.” The Song Position Bar located below the song name shows the progression of the song within the step. While stopped, you can specify the **Current Step** and the display will change accordingly.
- **M****:** Indicates the starting measure of that step.
- **Meter:** Indicates the currently-playing time signature. This cannot be changed.
- The name of a cue list can be specified by the **Rename Cue List** menu command.
- When you play the keyboard, the program of the track selected by **Track Select** will sound. If a different program is selected for each song, the

program that's specified for the song that's currently playing will play.

Converting a cue list to a song

The **Convert to Song** menu command lets you convert a cue list to a single song.

For details, please see "Convert to Song (Convert Cue List to Song)" on page 189 of the Parameter Guide.

Saving your song

In order to ensure that the data you create is reproduced faithfully, we recommend that you save your data by using **Save All** so that the programs will also be saved. However if you have not changed the program numbers or sounds used in your song, saving only the song-related data (.SNG) will minimize the size of the data.

 When you turn off the power, the Sequencer mode settings, the recorded songs, and the user pattern data will be lost.

1. Insert an SD card in the SD card slot.

With the card label facing upward, insert the connector end of the card into the SD card slot and press it in until you hear a click.

 Make sure that the card is oriented correctly when you insert it. Forcing it in the wrong direction may damage the slot or the card, and the data may be lost.

2. Press the WRITE button.

The Save Songs and Cue Lists Data dialog box will appear. If you want to change the name, adjust the appropriate settings (see page 117).

3. Press the WRITE button once again to save (write) the data.

If data of the same name already exists, a message will ask whether you want to overwrite the existing data. If you want to overwrite the existing data, press the OK button.

 If the save-destination directory is something other than a DOS directory (e.g., if you're in a directory shown by opening a .PCG or .SNG file), a message such as "File/path not found" will appear, and you won't be able to save the data. If this occurs, move to Media mode, select the appropriate save-destination (i.e., a DOS directory), and then execute "Save All" or "Save SEQ."

Saving a template song

If you want the programs, track parameters, effect settings, and arpeggiator settings etc. used by a song to be saved as a Template song, use the **Save Template Song** menu command to save these settings.

Using Effects

An overview of the KROME's effects

You can choose from 193 different types of high-quality digital effects. The KROME provides five insert effects, two master effects, and one total effect, together with a mixer section that controls the routing of these effects. All of these are stereo in/out.

Specific parameters of these effects can also be controlled in real time from the KROME's controllers or via MIDI messages using Dynamic Modulation (Dmod), by MIDI/Tempo Sync, or by using a common LFO to apply synchronized changes to multiple modulation effects.

Total Effect

The total effect (TFX) is stereo-in/stereo-out. The Dry (unprocessed) side of the **Wet/Dry** parameter sends the stereo input sound directly to the stereo output. The way that the Wet (processed) side is output depends on the type of effect, as follows.

Wet	Mono In - Mono Out	
	Mono In - Stereo Out	
	Stereo In - Stereo Out	

Note: The Parameter Guide includes block diagrams for each individual effect, which include the effect's input/output structure. (See page 251 of the Parameter Guide)

Effect I/O

Insert Effects

Insert Effects (IFX 1–5) are stereo-in/stereo-out. If you select Dry (unprocessed) for the **Wet/Dry** parameter, the stereo input signal will be output in stereo without being processed by the effect. If you select Wet (effect applied), the processed signal will be output in one of the following ways:

Wet	Mono In - Mono Out	
	Mono In - Stereo Out	
	Stereo In - Stereo Out	

Master Effects

Master Effects MFX1 and MFX2 are stereo-in/stereo-out. **Send1** and **Send2** determine the send level to the Master Effects.

With Master effects, only the Wet (processed) signal will be output. The output signals from the Master Effects are routed to the L/R bus with the output level specified by **Return1** and **Return2**. These output signals are mixed with the output signals from the bus specified by **Bus (IFX/Output) Select** (P8– Routing page in each mode) L/R, or with the output signals from the bus specified by **Bus (IFX/Output) Select** (P8– Insert FX Setup page in each mode) L/R, then routed to the total effect.

Selecting “000: No Effect” will mute the output. The processed signal will be output in one of the following ways, according to the type of effects.

Wet	Mono In - Mono Out	
	Mono In - Stereo Out	
	Stereo In - Stereo Out	

Effects in each mode

Program mode

For programs, you can use insert effects to process the final sound in the same way that you use the Filter, Driver, Amplifier, and EQ (equalizer) to process the sound from the oscillators (OSC 1 & 2). Next, the master effects are used to create overall ambience such as reverb, and you use the total effect to make final adjustments. You can apply an effect in the same way to the output of a drum track program. All of these settings can be made independently for each program.

Combination and Sequencer modes

In Combination and Sequencer modes, you can use the track EQ and insert effects to process the sound of each timbre/track program. Then you can use the master effects to create overall ambience, and use the total effect to make final adjustments.

In Combination mode, you can adjust these settings for each combination, and in Sequencer mode you can adjust them for each song.

In Sequencer mode, you can switch between effects or modify the effect parameters and record these changes, so that effects will switch automatically or effect parameters will be modified automatically as the song plays back.

Program mode

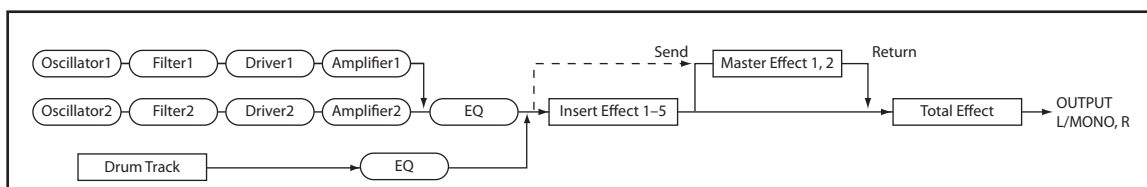

Combination and Sequencer modes

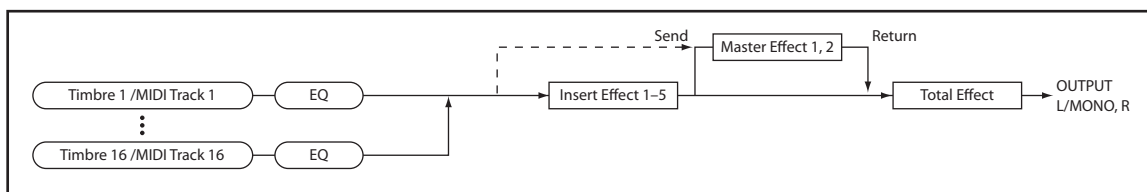

Routing effect settings

The insert effects, master effects, and total effect have the same structure in all modes, but the routing settings will determine how the oscillators of a program or the timbres of a combination or track of a song will be sent to each insert effect, master effect or total effect. In the pages that follow, we will explain how you can adjust routing settings and effect settings in each mode.

Program Effects settings

Routing

1. Access the Prog P8: Routing/IFX– Routing page.

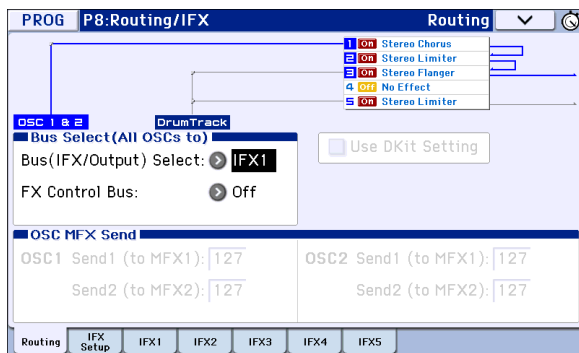

2. Use Bus (IFX/Output) Select to specify the bus where the oscillator output will be sent. If you want the oscillator output to be input to insert effect 1, choose IFX1.

L/R: The output will not be sent to the total effect. After bypassing the total effect, the sound will be sent to AUDIO OUTPUT L/MONO and R.

IFX1–5: The output will be sent to insert effect IFX 1–5.

Off: Choose this if you want the signal to be connected in series to the master effects at the send levels specified by Send 1 (to MFX1) and Send 2 (to MFX2).

3. OSC MFX Send specifies the send level from each oscillator to the master effects.

This can be set only when Bus (IFX/Output) Select is either L/R or Off.

If Bus (IFX/Output) Select is set to IFX1–5, the send level to the master effects is set by Send1 and Send2 (Insert FX Setup page) after the signal passes through the insert effects.

4. FX Control Bus sends the output of oscillator 1 and 2 to the FX Control bus. Use this if you want the audio input to the effect to be controlled by a different sound.

You can use the two FX Control buses to control effects freely. For details, please see “FX Control Buses” on page 238 of the Parameter Guide.

Insert effects

5. Access the Prog P8: Routing/IFX– Insert FX Setup page.

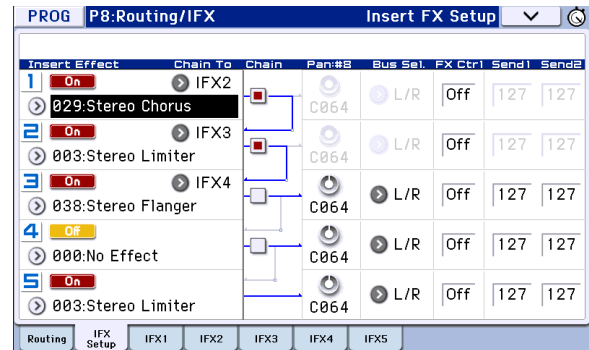

6. Choose the effect type that you want to use for each insert effect IFX1–5.

When you press the popup button, all effects will be displayed, organized into ten categories. Use the pages located to the left and right to select a category, and choose an effect from the desired category on the display.

You can use the **Copy Insert Effect** menu command to copy effect settings from another program etc. Also, you can use **Swap Insert Effect** to exchange (for example) IFX1 and IFX5.

7. Press the On/Off button to turn on the insert effect.

Each time you press this button, the insert effect will toggle on/off. When Off, the result will be the same as when 000: No Effect is selected; the sound will be output without being processed by the insert effect.

8. Make Chain settings.

If the **Chain** check box is checked, the insert effect will be connected in series. Since the output of the oscillator is being sent to IFX1 in step 2, adjusting settings as shown in the diagram above step 6, would connect all five insertion effects IFX1 → IFX2 → IFX3 in series, so that these effects would be inserted into the output of the oscillator.

9. Adjust settings for Pan: #8, Bus (Bus Select), Send 1, Send 2 and FX Ctrl for the sound after it has passed through the insert effects.

If you’ve specified a chain, the settings that follow the last IFX in the chain will be valid (except for FX Ctrl).

Pan: #8: Sets the pan of the IFX output.

Bus (Bus Select): Specifies the output destination. Normally you will set this to L/R.

Send 1, Send 2: Sets the send levels to the master effects. For this example, set this to 127.

FX Control Bus: The FX Control Buses lets you create effects “sidechains.” Sidechains let you control an effect with one audio signal (the sidechain), while the effect processes a completely different audio signal. This is convenient for use with vocoders, compressors and limiters, gates, etc. For details, please see “FX Control Buses” on page 238 of the Parameter Guide.

10. Access the P8: Routing/IFX– Insert FX Setup page, and edit the parameters of the insert effect you selected.

Press the IFX 1–5 tabs and edit the parameters.

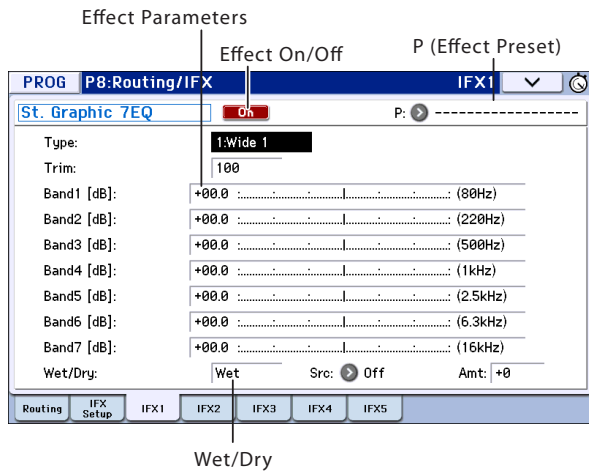

Effect 1 On/Off: Turns the insert effect on/off. This is linked with the on/off setting on the Insert FX Setup page.

P (Effect Preset): Selects an effect preset. The KROME's internal memory contains "effect presets" which are parameter settings for each effect from 001: Stereo Compressor through 193: Early Reflections.

Effect parameters you edit are saved as part of each program, but effect presets allow you to save and recall your favorite parameter settings for each effect. If you've come up with an effect setting you like, use the menu command **Write FX Preset** to save it as a preset so that you can easily recall it in a different program or mode.

For details on the parameters of each effect, see page 251 and following in the Parameter Guide.

Double-size effects

Double-size effects (172: St.Mltband Limiter – 193: Early Reflections) use twice as much space as other effects.

You can use double-size effects for insert effects IFX1–IFX4 and master effect MFX1. However, because it takes up two units of effects power, the next-numbered effect will be unavailable. For example, if you've selected a double-size effect for IFX1, you won't be able to use IFX2. If you've selected a double-size effect for MFX1, you won't be able to use MFX2.

An example of when a double-size effect is selected for IFX1 and IFX4

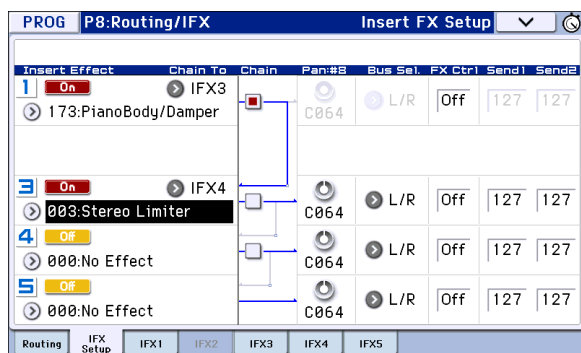

Master effects

11. The input levels to the master effects are set by the Send 1, 2 levels (step 3 or 9). If Send 1, 2 are zero, the master effects will not apply. Send 1 corresponds to MFX1, and Send 2 corresponds to MFX2.

12. Access the Prog P9: MFX/TFX/LFO– Routing page.

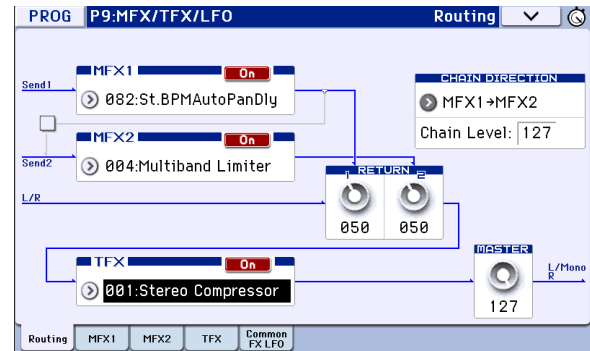

13. In MFX1 and MFX2, select the type of each master effect.

The procedure is the same as when selecting an insert effect (see step 6).

Note: You can only select a double-size effect for MFX1. For details, please see "Double-size effects," above.

14. Press the On/Off button to turn on the master effect.

Each time you press this button, the master effect will toggle on/off. When Off, the output of the master effect will be muted.

15. Use Return 1 and Return 2 to adjust the output levels of the master effects.

Note: For each effect, the Wet value of the Wet/Dry parameter is the output level of the effect. The return value is multiplied with this ("Return" = 127 will be x1.0) to determine the actual output level of the master effect.

16. Select the MFX1 and MFX2 pages, and set the parameters for each selected effect.

For details on the "Program Effects settings" step 10.

Total Effect

17. If you use Bus (IFX/Output) Select to choose L/R as the oscillator output, or if you set the post-IFX Bus to L/R, the signal will be input to the total effect.

The output from the master effect is input to the total effect via the Return 1 and Return 2 settings of the Prog P9: MFX/TFX/LFO– Routing page.

After being processed through the total effect, the signal is output from the AUDIO OUTPUT L/MONO and R outputs.

18. Access the Prog P9: MFX/TFX/LFO– Routing page.
19. Choose the desired total effect for TFX. The procedure is the same as when selecting an insert effect. (See step 6)

You can't use a double-size effect as the total effect. For details, please see "Double-size effects," above.

20. Press the On/Off button to turn the total effect on.

The total effect will toggle on/off each time you press the button. If this is Off, the result will be the same as if 000: No Effect is selected. The input sound will be output without being processed by the total effect.

21. Access the TFX page, and edit the parameters of each effect to adjust the final sound as desired.

For details on the “Program Effects settings”, see step 10.

Using effects in Combinations and Songs

In Combination, and Sequencer modes, you can specify the routing of each timbre/track to the insert effects, master effects and total effect. These settings are adjusted in the same way in each of these modes. We will be using the example of Combination mode in our explanation here.

Routing

1. Access the Combi P8: Routing/IFX– Routing T01–08 page.

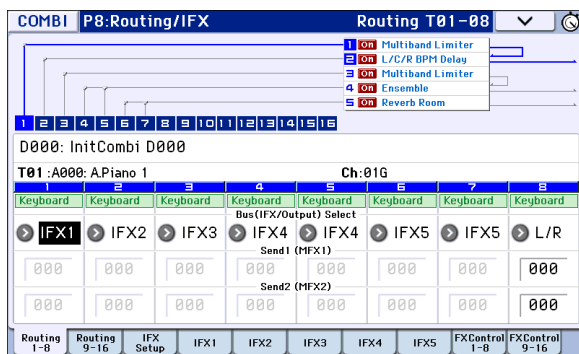

2. Use “Bus (IFX/Output) Select” to specify the bus where each timbre will be output. Choose IFX1 if you want to send the output of a timbre to insert effect 1.

The routing, insert effects, and chain settings are shown graphically on the upper part of the page. In this example, T01 (timbre 1) uses IFX1 and 2. T02 uses IFX2, T03 uses IFX3 and 4, T02 and T05 use IFX4, and T06 and T07 use IFX5.

3. Use Send1 and Send2 to specify the send level of each timbre to the master effects.

This can be set only if **Bus (IFX/Output) Select** is set to L/R or Off.

Note: The actual send level is determined by multiplying this by the **Send 1** or **Send 2** settings for oscillators 1 and 2 within the program selected by the timbre. If the program parameter **Send 1** or **Send 2** is set to 0, the resulting level will still be 0 even if you raise this send level.

If **Bus (IFX/Output) Select** is set to IFX1–5, the send levels to the master effects are set by **Send1** and **Send2** (Insert FX Setup page) following the insert effects.

4. Press the FX Control 1–8 tabs to access the FX Control T01–08 pages.

Bus (IFX/Output) Select is the same as in the Routing T01–08 page. You can set it from either page.

FX Control Bus sends the output of the timbre to an FX Control bus. Use this when you want the audio input to an effect to be controlled by another sound. There are two FX Control buses, which gives you a great deal of freedom for controlling effects freely. For details, please see “FX Control Buses” on page 238 of the Parameter Guide.

Insert effects

5. Access the Combi P8: Routing/IFX– Insert FX Setup page.

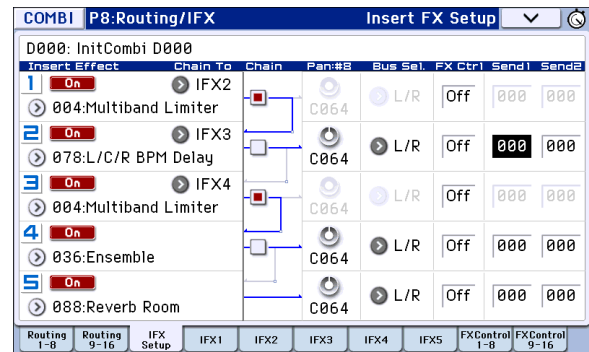

6. Select an insert effect in IFX1–5 and edit the settings.

7. Access the IFX1–5 pages to edit the individual effect parameters.

These settings can be adjusted in the same way. (See page 79.)

MIDI You can use MIDI to control dynamic modulation (Dmod) for each effect, the post-IFX pan (CC#8), and Send 1 and Send 2 levels.

An asterisk “*” is shown at the right of Ch01–Ch16 for the channel number of tracks routed to IFX. If you’ve routed multiple tracks that have different MIDI channel settings, this specifies the channel on which they will be controlled.

Master effects and Total effect

These settings can be adjusted in the same way as on page 80.

MIDI You can control these effects via MIDI on the “Ctrl Ch.” The specified MIDI channel will control dynamic modulation (Dmod) for the Master and Total Effect.

Dynamic modulation, Common FX LFO

Dynamic modulation (Dmod)

Dynamic modulation (Dmod) lets you use MIDI messages or the KROME's controllers to modulate specific effect parameters in real-time.

Dynamic modulation to control an effect parameter in realtime

As an example, let's set up dynamic modulation to control an effect parameter in realtime.

- As described in the procedure for "Program Effects settings" on page 79, set IFX1 to 078: L/C/R BPM Delay. Verify that you're hearing a delay effect.
- Access the Prog P8: Routing/IFX– IFX1 page.

Now, we can set the Dmod to change the delay level via the Joystick

- Set Input Level D-mod to +100.
- Set Source to JS+Y: #01.

The delay sound will disappear.

The input level to the effect can be controlled by the joystick. As you move the joystick away from yourself, the delay sound will gradually increase.

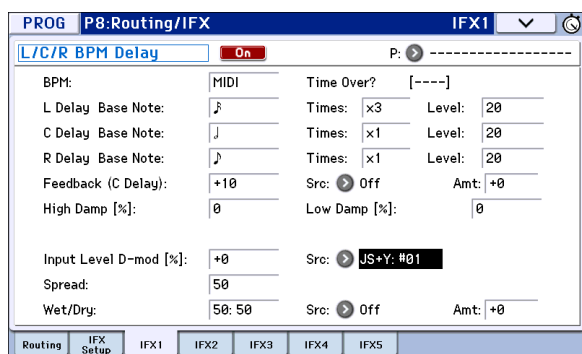

In addition, we can use Dmod to change the feedback level via SW1

- In the P1: Basic/Controllers– Controllers Setup page, set the SW1 function to SW1 Mod.CC#80, and the Mode to Toggle.

Choose P8: Routing/IFX– IFX1 page. Set the Feedback Src to SW1: #80, and set Amt to +30.

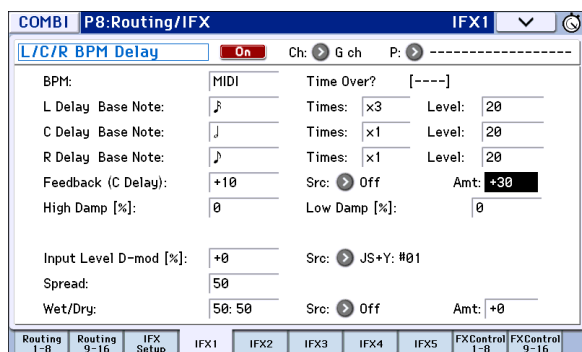

When you move the joystick away from yourself and press the SW1 button, the feedback level will increase, and the delay sound will continue for a longer time.

The **Amt** setting specifies the feedback level that will be in effect when the SW1 button is pressed. If **Amt** is set to -10, pressing the SW1 button will reduce the feedback level to 0.

Finally, we can use the MIDI/Tempo Sync function to synchronize the delay time to the arpeggiator tempo.

- Set BPM to MIDI.
- For L, C, and R, set the Delay Base Note and Times as desired.

For this example, set **Delay Base Note** to ♩ and **Times** to x1 so that the effect will be easily understandable.

The delay time will repeat at an interval of a 8th note.

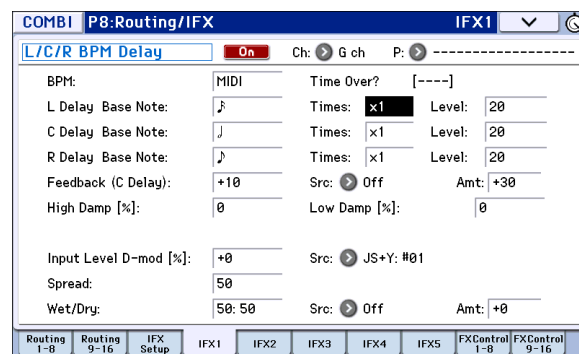

- Rotate the TEMPO knob, and the delay time will change.

When you (push the joystick away from yourself and) press the SW1 button, the feedback level will rise, and the delays will become longer.

- When you turn on the ARP button, arpeggiator will begin playing.

Select any desired arpeggiator. When you rotate the TEMPO knob, the delay time will change in synchronization with the changing tempo of the arpeggiator.

Depending on the specific delay effect, you may hear some unexpected noise if you change the tempo while the delay is sounding. This is because the delay sound becomes discontinuous, and is not a malfunction.

MIDI For some effects, you can synchronize the LFO frequency to the tempo. Set the effect parameters **MIDI Sync** to On, and **BPM** to MIDI. For details, please see page 236 of the Parameter Guide.

Common FX LFO

Two Common FX LFOs are available for modulation effects, such as choruses, filters, phasers, etc. Normally, the phase of the LFOs of multiple modulation-type effects will not be synchronized even if you set them to the identical Frequency, since the LFOs are being generated independently.

However, if you select Common 1 or Common 2 for the **LFO Type** parameter of a modulation-type effect, the effect will use the one of the common LFOs instead of its own individual LFO. This allows you to use a single Common FX LFO to control two or more modulation-type effects such as flanger, phaser, or auto-pan with the same phase. Since you can make independent settings for LFO waveform and phase offset for each effect, you are free to create complex combinations of effects.

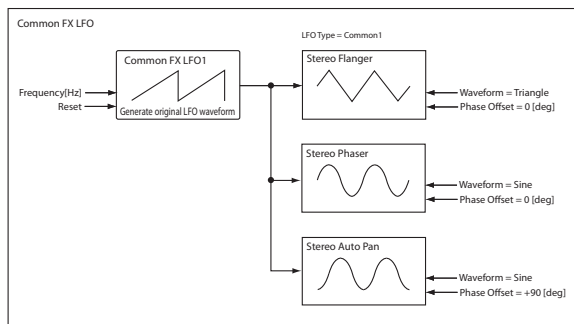

Arpeggiator function

Using the arpeggiator while you play

The arpeggiator is a function that automatically generates arpeggios (patterns of individual notes derived from a chord). Most arpeggiators produce an arpeggio when you play a chord on the keyboard.



The chord you played on the keyboard is sounded as an arpeggio (broken chord)

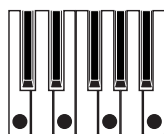

The KROME's arpeggiator is also polyphonic, and can produce a variety of chordal transformations or phrases based on the pitch or timing of the notes you play on the keyboard. These functions let you use the arpeggiator to play a wide range of patterns including drum or bass phrases, and guitar or keyboard backing riffs. It is also effective to use the arpeggiator as part of the sound-design process when creating subtly-moving pads, synth-sounds, or sound effects.

The KROME's Dual Arpeggiator feature lets you use two simultaneous arpeggio patterns in Combination mode, and Sequencer mode. You can take advantage of this in many ways, including a separate arpeggio pattern for a drum program, and another applied to a bass program, or using a keyboard split or velocity to switch between two arpeggio patterns.

The KROME provides five preset arpeggio patterns: the standard **UP**, **DOWN**, **ALT1**, **ALT2**, and **RANDOM**. You can also create and store 1,028 of your own user patterns. The factory settings contain a wide variety of arpeggio patterns stored in these user locations (see page 211 of the Parameter Guide).

Using the arpeggiator in Program mode

1. Press the **PROG** button to enter Program mode, and select a program. For details, please see "Selecting Programs" on page 21.
2. Press **ARP** button (the LED will light) to turn on the arpeggiator. Arpeggios will begin sounding when you play the keyboard.
3. As described in the following sections "Using knobs 1-4 to control the arpeggiator" and "Selecting an arpeggio pattern and specifying its function," move the controllers or modify the parameters to change the way that the arpeggios are played.

Arpeggiator on/off

- Each time you press the **ARP** button, the arpeggiator will be switched on/off.

When the arpeggiator is turned on (the LED will light up) and the selected arpeggio pattern will begin when you play the keyboard.



Note: The on/off status is saved when you write each program.

- In Combination and Song modes, the arpeggios may not start when you press the **ARP** button - depending on the saved settings. You may need to play a keyboard (see page 90).

Adjusting the arpeggiator tempo

- Rotate the **TEMPO** knob or **TAP** button to adjust the tempo.

The "♩=" display in the upper right of the LCD will change. The tempo can be adjusted over a range of 40.00-300.00 bpm. The LED will blink in time with the specified tempo.

As an alternative to using the **TEMPO** knob or **TAP** button, you can also set the tempo by selecting "♩=" in the display, using the numeric keys 0-9 to enter the tempo, and pressing the **ENTER** button. You can also set the tempo by using the **VALUE** controllers. The LED will blink in synchronization with the tempo you specify.

Note: The tempo setting is also saved when you write a program.

Note: The arpeggio playback speed is affected by the **Reso** setting (Prog P0: Play- Arpeggiator page), or **Resolution** (P7: ARP/DT- ARP Setup page).

- If the Global P1: MIDI- MIDI Basic page **MIDI Clock** parameter is set to External MIDI, External USB, or set to Auto and MIDI Clock messages are being received, the display will indicate "♩=" EXT, meaning that the KROME is synchronized to an external MIDI device. In this case, you won't be able to change the tempo by using the KROME.

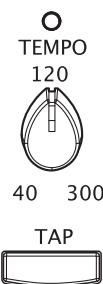

Using knobs 1–4 to control the arpeggiator

- You can control the arpeggiator by pressing the SELECT button to select ARP and then turning knobs 1–4.

REALTIME CONTROLS

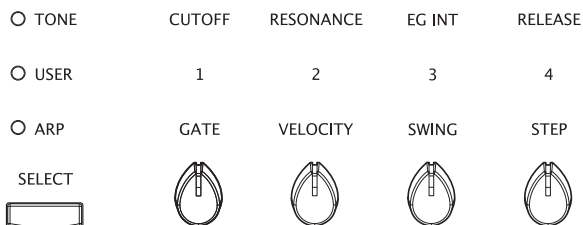

Adjusting the duration of the arpeggiated notes

- Turn knob 1 to adjust the duration of the arpeggiated notes. Rotating the knob toward the left will shorten the duration of the notes, and rotating it toward the right will lengthen the duration of the notes. At the center position (12 o'clock), the note length will be as specified by the program parameter: **Gate** (Prog P7: ARP/DT– ARP Setup page).

Note: The knob setting is saved when you write each program.

Note: It is effective to use the SELECT button to select TONE, and then adjust knob 4 (RELEASE).

Changing the dynamics of the arpeggiated notes

- Turn knob 2 to adjust the dynamics of the arpeggiated notes. Turning the knob toward the left will make the notes softer, and turning it toward the right will make the notes stronger. When the knob is in the center position (12 o'clock), the value of the program parameter **Velocity** (Prog P7: ARP/DT– Arp Setup page) will be used.

Note: The state of the knob is saved when you write the program.

Note: It is effective to use the SELECT button to select TONE, and then adjust knobs 1 (CUTOFF), 2 (RESONANCE), and 3 (EG INT).

Adding a shuffle feel to the arpeggiator pattern

- If you turn knob 3, the timing of the arpeggiated notes on even-numbered beats will be shifted forward or backward. Turning the knob toward the left will speed up the timing of the even-numbered beats. When the knob is in the center position (12 o'clock), the timing will be as specified by the program parameter **Swing** (Global P6: Arpeggio Pattern– Setup page).

Changing the number of steps in the arpeggio pattern

- By turning knob 4 (STEP), you can change the number of steps in the arpeggio pattern.

Turning the knob toward the left will shorten the pattern length (“Length”) by half. Turning the knob toward the right will shorten the interval of the arpeggiated notes (“Resolution”) by half. When the knob is in the center position (12 o'clock), the pattern will be as specified by the parameters **Length** and **Resolution** (Global P6: Arpeggio Pattern– Setup page).

- If the arpeggio pattern selected by “Pat (Pattern Select)” is one of the preset arpeggio patterns P0–P4, turning the knobs will not produce any change. These adjustments are available only if a user arpeggio pattern U0000 (INT)–U1027 (USER) is selected.

Note: The state of the knobs is saved when you write the program.

Note: Depending on the program that’s selected, using knob 4 may not produce any effect.

Selecting an arpeggio pattern and specifying its function

In the Prog P0: Play– Arpeggiator page you can select an arpeggio pattern and specify how the arpeggiator will function.

- In Prog P0: Play, press the ARP tab to access the Prog P0: Play– Arpeggiator page.



Selecting an arpeggio pattern

An arpeggio pattern can be selected from preset arpeggio patterns P0–P4 and user arpeggio patterns U0000 (INT)–U1027 (USER). The factory settings U0000 (INT)–U0899 (INT), U0900 (USER)–U1027 (USER) contain a wide variety of preloaded user arpeggio patterns.

- Choose **Pattern**, and use the VALUE dial, INC/DEC buttons, and popup menu to select an arpeggio pattern.

User arpeggio patterns can also be selected by using the numeric keys 0–9 to input the pattern number and then pressing the ENTER button.

P0: UP

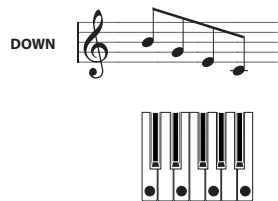
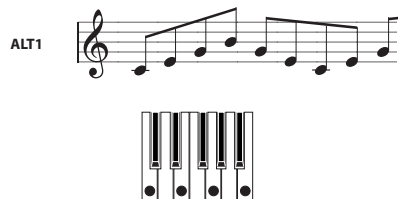
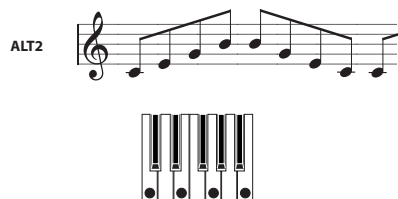
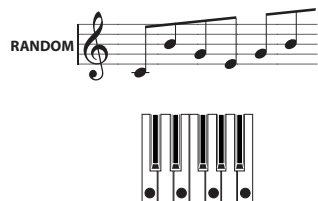

P1: DOWN**P2: ALT1****P3: ALT2****P4: RANDOM****Changing the note value of the arpeggiated notes**

The **Resolution** parameter lets you set the note value of the arpeggiated notes, over a range from $\frac{1}{8}$ to $\frac{1}{2}$.

- Press **Resolution**, and use the VALUE dial, INC/DEC buttons, or popup menu to select the desired arpeggio note value.

Selecting the octave range where the arpeggio is sounded

Use the "Octave" radio buttons to specify the range of octaves where the arpeggio will play.

- Press an "Octave" radio button to make your selection.

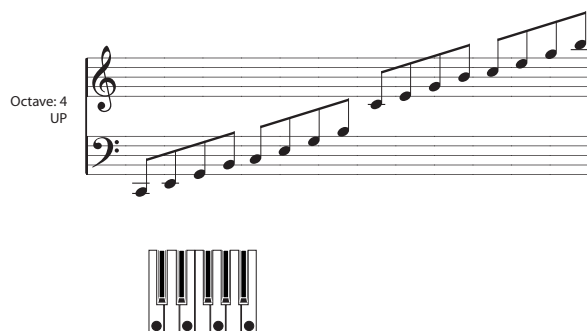
**Sounding an arpeggio in the order of the pitches in the chord you played**

You can select whether the notes of the arpeggio will be sounded in the order of the pitches in the chord you played (regardless of the order in which you actually played the notes), or in the order in which you played the notes.

- Press the "Sort" check box in the display to make this setting.

Checked: the arpeggio will play each note in the order of its pitch, regardless of the order in which you actually played the notes.

Unchecked: the arpeggio will trigger each note in the order in which you actually played the notes.

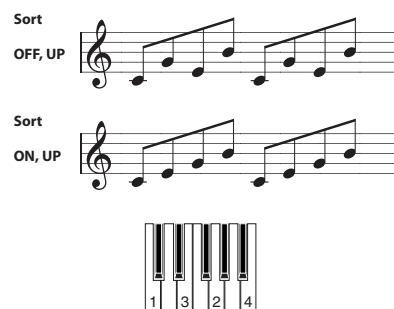
**Setting the arpeggio to continue playing even after you have taken your hand off the keyboard**

You can select whether the arpeggio will continue playing when you take your hand off the keyboard, or whether the arpeggio will stop.

- Press the "Latch" check box to make this setting.
 - Checked:** The arpeggio will continue playing even after you remove your hand from the keyboard.
 - Unchecked:** The arpeggio will stop playing when you remove your hand from the keyboard.

Synchronizing the arpeggiator to your keyboard timing

You can specify whether the arpeggio will begin at the moment you play the keyboard, or whether it will always play in synchronization to the MIDI clock tempo.

- Press the "Key Sync." check box to make this setting.
 - Checked:** The arpeggio pattern will start from the beginning when you press a key. This setting is suitable when you want the arpeggio to start from the beginning of the measure as you are playing in real-time.
 - Unchecked:** The arpeggiator will synchronize to the MIDI clock timing.

Sounding both the arpeggio notes and the notes you play

- Press the "Keyboard" check box to adjust this setting.
 - Checked:** The notes you play on the keyboard and the notes played by the arpeggiator will both be heard.

Unchecked: Only the arpeggiated notes will sound.

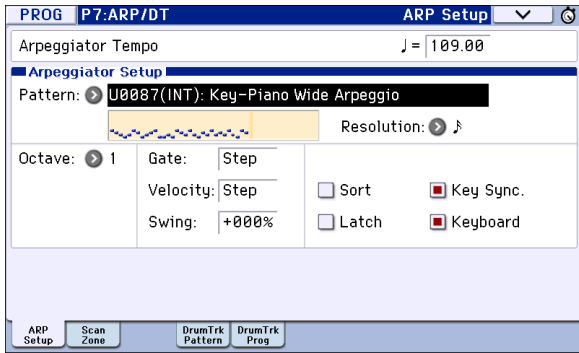

Changing the duration of the arpeggiated notes

The P7: ARP/DT– ARP Setup **Gate** parameter specifies the duration of the arpeggiated notes. With a setting of 000–100(%), the duration will always be the specified gate time. Step is available if you’ve selected U0000(INT)–U1027(USER) as the **Pattern**; the gate value specified for each step will be used.

You can also control this by using the arpeggio control (ARP) GATE knob (see page 86).

Specifying the arpeggio pattern’s velocity and other settings

In P7: ARP/DT– ARP Setup, the **Velocity** parameter specifies the velocity of the arpeggiated notes. If you choose a value in the range of 001–127, that velocity value will always be used. If you choose Key, the velocity value of how you played the key will be used. Step is available if “Pattern” is set to U0000(INT)–U1027(USER); this causes the velocity value specified for each step to be used.

“Swing” offsets the timing of arpeggiated notes that are even-numbered (counting from the beginning).

“Velocity” and “Swing” can be controlled by knobs 2 and 3 respectively when SELECT is set to ARP.

Specifying the zone where the arpeggiator will function

In P7: ARP/DT– ARP Scan Zone you can specify the range of notes (keys) and velocities where the arpeggiator will function.

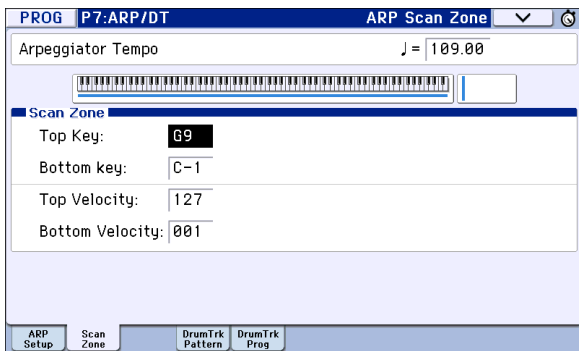

Using the arpeggiator in Combination mode

In Combination mode the KROME provides dual arpeggiators, allowing you to run two arpeggio patterns simultaneously.

1. In Combination mode, select a combination (see “Selecting Combinations” on page 43).

As you select various combinations, you’ll notice that the ARP button LED will light up for some combinations (see “Linking the arpeggiator to programs or combinations” on page 91).

When you play the keyboard, the arpeggiator will start. Even for other combinations, you can turn the arpeggiator on by pressing the ARP button (the LED will light up).

2. Listen to how the arpeggio can be modified as described in the “Using knobs 1–4 to control the arpeggiator” (above) and “Selecting an arpeggio pattern and specifying its function” sections (below).

⚠ The ARP button, TEMPO knob, TAP button, and control surface ARP will apply to both arpeggiators A and B. Their state is saved when the combination is written.

Selecting an arpeggio pattern and adjusting settings

In the Combi P0: Play– Arpeggiator page you can select an arpeggio pattern and specify how the arpeggiator will function.

- In Combi P0: Play, press the ARP A tab or the ARP B tab to select the Combi P0: Play– Arpeggiator A or B page.

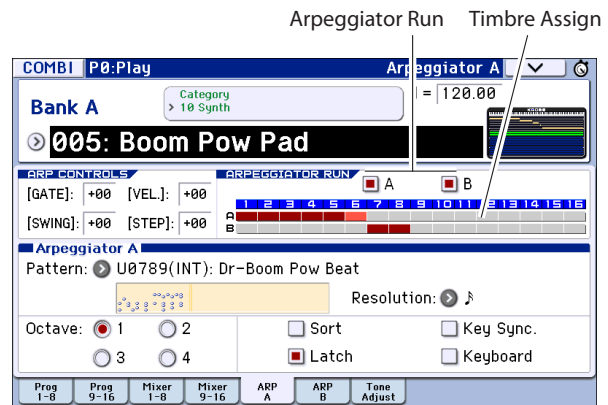

Select the arpeggiator(s) that will run

Use the **Arpeggiator Run** check boxes to specify the arpeggiator(s) that you want to have running. The arpeggiator(s) that are checked here will run when the ARP button is on. However, the arpeggiator will only play a timbre if the table next to the check boxes assigns arpeggiator A or B to a timbre: T 1–16. You change these settings in Combi P7: ARP/DT– ARP Setup T01–08, T09–16 page **Arpeggiator Assign** (see page 90).

Arpeggiator-A, Arpeggiator-B

For each arpeggiator A and B, you can adjust settings for **Pattern (Select)**, **Resolution**, **Octave**, **Sort**, **Latch**, **Key Sync**, and **Keyboard** (see page 86).

Checking the structure of a user arpeggio pattern

Let's see how the combination "A005: Boom Pow Pad" (category: LeadSplits) is constructed.

- Select combination "A005: Boom Pow Pad" (category: LeadSplits), and look at the Arpeggio Play A page and Arpeggio Play B page.

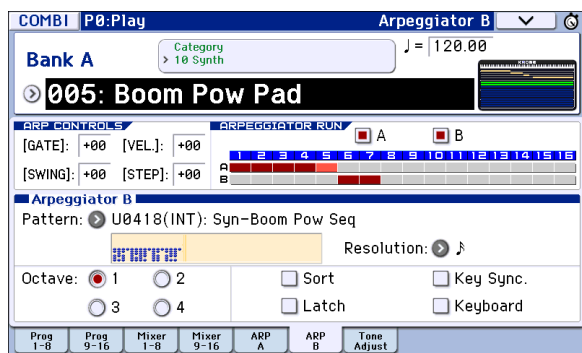
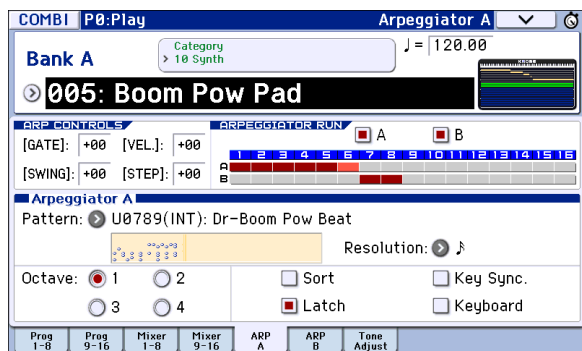

- In "Timbre Assign" you'll see that arpeggiator A is assigned to timbres 1–5, and arpeggiator B is assigned to timbres 6 and 7.

When you play the keyboard, the drum programs of timbres 1–4 will be sounded by the arpeggio pattern of arpeggiator A. (Timbre 5 is a dummy program used to play timbres 1–4. See page 91.)

Arpeggiator B will sound the programs of timbres 6 and 7.

- If you uncheck **Arpeggiator Run A** or **Arpeggiator Run B**, it will stop.

If you check it once again and play the keyboard, that arpeggiator will begin running.

- When you access the Combi P7: ARP/DT- ARP Scan Zone page, you'll see that the B "Top Key" and "Bottom Key" parameters are set so that arpeggiator B will run only for the notes B3 and below. Arpeggiator A is set to run for any key.

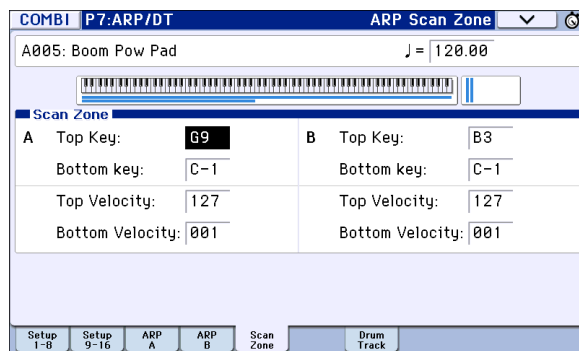

- The drum programs of timbres 1–4 use the same arpeggiator A pattern, but since the notes sounded by each timbre are divided by key zone, each will play only a portion of the arpeggiator pattern. Go to the P0: Play-Program T01–08 page and try muting each timbre 1–4 to hear the result. You can add variety by using different combinations of timbres.

Arpeggiator settings in Combination and Sequencer modes

In Combination and Sequencer modes, you can use two arpeggio patterns simultaneously, thanks to the KROME's dual arpeggiator functionality. The settings in each of these modes are adjusted in a similar way.

The following example shows how to adjust settings in Combination mode.

The dual arpeggiator functionality lets you do the following things.

- Assign an arpeggiator for each timbre. Choose from **Off**, (arpeggiator) **A**, or (arpeggiator) **B**. step 5
- Independently specify whether **A** and **B** will function. step 6
- Select an arpeggio pattern and set parameters independently for **A** and **B**. step 7
- Make Scan Zone page settings so that you can use keyboard range or playing velocity to switch between normal playing and arpeggiated playing, or to switch between arpeggiators **A** and **B**. step 8
- Make settings for timbres that will be silent when the arpeggiator is Off, and will sound only when the arpeggiator is On. step 10

Arpeggiator settings

1. Select Combi P0: Play– Program T01–08 page.

Select programs for the timbres that you wish to use. For this example, select any desired program for timbres 1–4.

2. Select Combi P3: Timbre Parameters, MIDI T01–08 page.

For the timbres that you will be using, set **Status** to **INT**, and set **MIDI Channel** to **Gch** or to the global MIDI channel (set in Global P1: MIDI Basic **MIDI Channel**).

For this example, set timbres 1–4 to a **Status** of **INT**, and timbres 5–8 to a **Status** of **Off**. Set the **MIDI Channel** of timbres 1–4 to **Gch**.

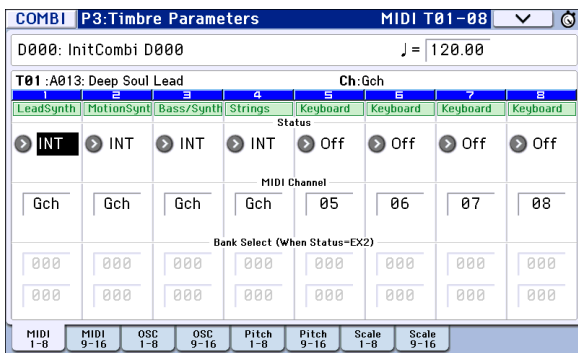

3. Select Combi P7: ARP/DT– ARP Setup T01–08 page.

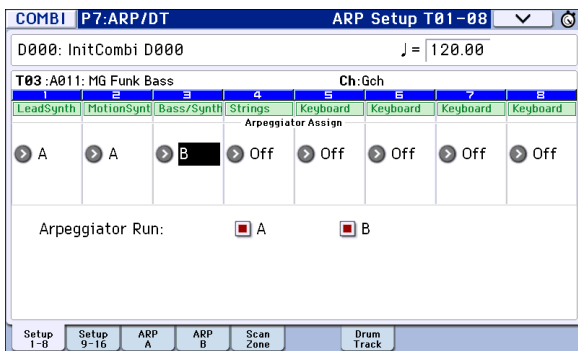

4. Set “J (Temp)” to specify the tempo.

This is the same as for a program. However, the tempo is shared by both arpeggiators A and B.

5. Make “Arpeggiator Assign” settings.

Assign arpeggiator A or B to the desired timbres. Each timbre will be played by the arpeggiator that has been assigned to it.

6. Make “Arpeggiator Run” settings.

Check the arpeggiator(s) that you want to run. The arpeggiator(s) checked here will run when the ARP button is turned on.

With the settings shown in the display for steps 2 and 3, turning the ARP button on will cause arpeggiator A to run for timbres 1 and 2, and arpeggiator B to run for timbre 3. When the ARP button is turned off, timbres 1–4 will sound as a layer.

If all timbres **Assign** status are set to **Off**, or if **Arpeggiator Run A** or **B** is **unchecked**, the arpeggiator will not function.

7. On the Arpeggiator A and Arpeggiator B pages, set the parameters for arpeggiators A and B.

The parameters for A and B are the same as for a program (see page 86).

8. In the Scan Zone A/B page, specify the range in which arpeggiators A and B will function.

The parameters for A and B are the same as for a program.

You can use keyboard ranges or velocity ranges to use one or both of the arpeggiators, or to switch between arpeggiators A and B. By using the Combi P4: Zone/Delay– Key Zone T01–08 – T09–16 page, and Vel Zone T01–08 – T09–16 page to set keyboard and velocity ranges in conjunction with each other, you can create even more variations.

9. If you wish to save the edited combination settings in internal memory, turn off memory protect in Global mode, and write the combination (see page 115 and page 117).

10. The “Status,” “MIDI Channel” and “Assign” settings shown in the display of steps 2 and 3 can be made so that certain timbres will sound only when the arpeggiator is On, and will be silent when the arpeggiator is Off.

Combination A001: Bossa Rose (SW1/2) (Category: Keyboard)

Although this is a somewhat sophisticated editing technique, we will describe the settings of one of the preset combinations as an example.

When you play a specific region of the keyboard, this combines settings that cause the arpeggiator to play an arpeggio using different sounds than what’s being played by the keyboard, with other settings that cause the arpeggiator sounds to remain completely unplayed when the arpeggiator is off.

Before you play, make sure that the global MIDI channel (Global P1: MIDI Basic **MIDI Channel**) is set to **01**.

Select combination A001: Bossa Rose (SW1/2), turn the ARP button on, and play.

- Arpeggiator A is assigned to timbre 2 and 16. When you play the keyboard, the bass riff arpeggio pattern will sound the timbre 2 program.
- The A **Bottom Key** and **Top Key** (Combi P7: ARP/DT– ARP Scan Zone page) are set so that arpeggiator A will function only for notes B3 and lower.
- Arpeggiator A is also assigned to timbre 16, but this is so that the timbre 2 program will sound only when the arpeggiator is on.

Notice the timbre settings for timbre 2 and 16.

Timbre	Status	MIDI Channel	Assign
2	INT	02	A
16	Off	Gch	A

- If the arpeggiator is off, playing the keyboard will sound the timbre(s) that are set to Gch or to the global MIDI channel (in this case, 01). Since the **MIDI Channel** of timbre 2 is set to 02, it will not sound. Timbre 16 is set to Gch, but since “Status” is Off it will not sound.

- Notes from any MIDI channel that is assigned to a timbre will trigger the arpeggiator. In this case, these will be **MIDI Channel 02** and **Gch** (global MIDI channel). When the arpeggiator is on, playing the keyboard will trigger arpeggiator A, which is assigned to timbre 16 (Gch). Timbre 2 will be sounded by arpeggiator A. Since the **Status** of timbre 16 is **Off**, it will not sound.
- Since the **Status** of timbre 16 is **Off**, it will not sound, regardless of whether the arpeggiator is on or off. It is a dummy timbre that causes timbre 2 to sound only when the arpeggiator is on.

Combination A005: Boom Pow Pad (Category: Synth)

Before you play, make sure that the global MIDI channel (Global P1: MIDI Basic **MIDI Channel**) is set to **01**.

Select combination A005: Boom Pow Pad, turn the ARP button on, and play.

- Arpeggiator A is assigned to timbres 1–5, and arpeggiator B is assigned to timbres 6 and 7. When you press any note of the entire keyboard, the drum programs of timbres 1–4 will be sounded by the arpeggio pattern of arpeggiator A. When you play the B3 or a lower note on the keyboard, the synth programs of timbres 6 and 7 will be sounded by the backing arpeggio pattern.
- The arpeggiator A parameters “Bottom Key” and “Top Key” (Combi P7: ARP/DT– ARP Scan Zone page) are set so that arpeggiator A will run for the entire keyboard.
- The B **Bottom Key** and **Top Key** (Combi P7: ARP/DT– ARP Scan Zone page) are set so that arpeggiators B will function only for the note B3 and below.
- Arpeggiator A is assigned to timbre 5 as well, but this setting is so that the timbre 1 to 4 program will sound only when the arpeggiator is on. Refer to the preceding section “Combination Bossa Rose (SW1/2).”

Linking the arpeggiator to programs or combinations

You can specify whether the arpeggiator settings written to a program or combination will be recalled when you switch programs or combinations, or whether the current arpeggiator settings will be maintained.

With the factory settings, the former is selected. Use the latter when you want to keep the same arpeggio pattern running, and change only the program sound. This setting is made in “Load ARP when changing” (Global P0: Basic Setup, Basic page). (See page 110)

Creating a user arpeggio pattern

About user arpeggio patterns

The patterns that can be selected on the KROME’s arpeggiator are called “arpeggio patterns.” There are two types of arpeggio patterns: preset arpeggio patterns and user arpeggio patterns.

Preset arpeggio patterns:

There are five patterns; UP, DOWN, ALT1, ALT2, and RANDOM.

The functionality of these patterns is fixed, and cannot be edited.

User arpeggio patterns:

There are 1028 patterns - U0000(INT)–U1027(USER) - which can develop chords or phrases in a wide variety of ways, based on the pitches that you play on the keyboard or the timing with which you play them.

In Global P6: Arpeggio Pattern, Setup you can modify these user arpeggio patterns, or create a new user arpeggio pattern from an initialized condition. Edited user arpeggio patterns can be written to internal memory areas U0000(INT)–U1027(USER) (see page 221 of the Parameter Guide).

In Media mode, you can also save user arpeggio patterns to media.

Editing a user arpeggio pattern

 If you want to edit a user arpeggio pattern, you must first make sure that memory protect is unchecked. (See page 197 of the Parameter Guide)

If you enter this mode from the Program mode, your editing will apply to the arpeggio pattern specified for the selected program.

1. In Program mode, select a program which uses the arpeggio pattern you wish to edit, or a program that you wish to use as a basis for editing the arpeggio pattern.

2. Press the ARP button to turn the arpeggiator on (the button will light up).

Even if you entered Global mode from a program in which the arpeggiator was turned off, you can use the ARP button to turn it on.

3. Select the Global P6: Arpeggio Pattern– Setup page (see page 211 of the Parameter Guide).

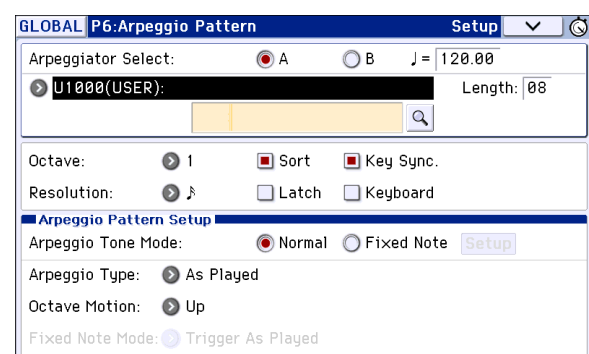

4. "Arpeggiator Select" will automatically be set to A when you navigate to this page from Program mode.

5. In "Pattern," select the arpeggio pattern that you wish to edit.

For this example, select an empty user arpeggio pattern.

⚠ If a blank pattern is selected, playing the keyboard will not start an arpeggio. Although preset arpeggio patterns P0–P4 can be selected, they cannot be edited.

⚠ When you edit a user arpeggio pattern, the changes will have an effect anytime that this pattern is used in Program, Combination, or Song.

6. In "Length," specify the length of the pattern.

After the pattern has played for the length specified, it will return to the beginning. This setting can also be changed during or after editing. For this example, set it to 08.

⚠ Set knob 4 (STEP) to the center position (12 o'clock) so that the values of the "Length" and "Resolution" parameters (Global P6: Arpeggio Pattern- Setup page) will be used.

Note: For the preload arpeggio patterns U0000(INT)–U0899(INT), simply changing the "Length" can significantly change the character of the pattern. Try changing the length and listening to the result. (See "Length (Pattern Length)" on page 211 of the Parameter Guide.)

7. Make settings for the "♩ (Tempo)," "Resolution," "Octave," "Sort," "Latch," "Key Sync," and "Keyboard" parameters.

These are program parameters, but they can be set from here as well.

⚠ If after accessing this page from Program mode, you modify these parameters and wish to keep your changes, return to Program mode and write the program. These parameters are not saved by "Write Arpeggio Pattern."

For this example, make the settings shown display step 3.

8. In Arpeggio Pattern Setup, specify how the arpeggio will be developed.

9. Press the  button to select Edit dialog.

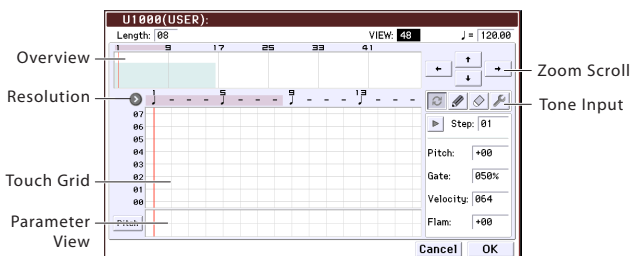

A pattern consists of Steps and Tones.

• **Step:** Each user arpeggio pattern has up to 48 steps. Starting with the first step, the arpeggiator will play notes at intervals of the note value specified by **Resolution**. The vertical lines of the grid indicate the steps.

Use **Step** to select the step; then specify **Pitch Offset**, **Gate**, **Velocity** and **Flam** for each step.

You can also select the step by pressing the Step line in the parameter view at the bottom. You can also edit by dragging in the parameter view.

Press the button to the left of the parameter view to switch between Pitch (**Pitch Offset**) → Gate (**Gate**) → Vel. (**Velocity**) → Flam (**Flam**).

• **Tone:** Each step can sound a chord of up to 12 tones (**Tone No.** 00–11). By touching and dragging the overview on the right part of the screen or by using the zoom scroll buttons above it, select the location for entering tones in the zoom view below. Press the touch grid to enter tones.

When **Step** is selected, you can also enter tones by using the numeric keys 0–9 and the "–" and "." buttons.

Note: The **Tone No.** corresponds to the numeric keys 0–9 and the "–" and "." buttons as shown below. Each time you press a numeric key 0–9 or a "–" or "." button, the corresponding tone will turn on or off. The horizontal lines of the grid in the center of the display correspond to tones.



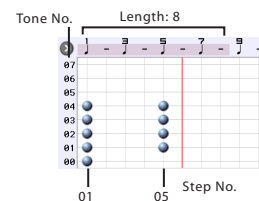

Tone00–09: 0–9 buttons

Tone10: – button

Tone11: . button



Entering tones

-  Alternate: Set or reset the tone.
-  Pen (set only): Set the tone.
-  Erase (reset only): Reset the tone.
-  Tool: Opens the tool tablet. The tool tablet lets you use various commands in a region you've specified in the overview, or to copy and paste (see "Tool Tablet" on page 214 of the Parameter Guide).

Creating an example pattern

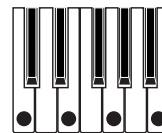

1. Press the alternate button.
2. Enter tones in the touch grid as shown in the illustration below.

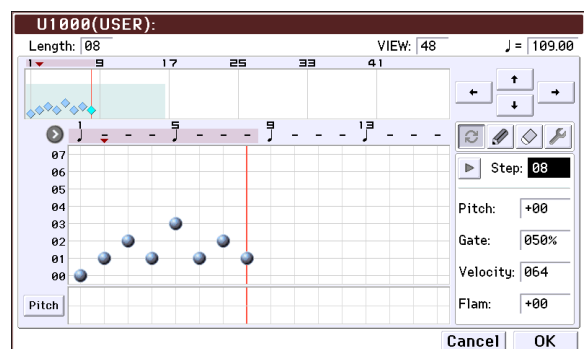

3. When you play the keyboard as shown in the illustration, the arpeggiator will begin playing.

Tone 0 corresponds to the pitch of the lowest key of chord you play on the keyboard. (If **Sort** is unchecked, it will correspond to the pitch of the first note you play.)

4. For steps 01–08, make settings for “Pitch Offset,” “Gate,” “Velocity,” and “Flam.”

Pitch Offset: This offsets the pitch of the arpeggio note in semitones up or down. You can input the same tone for each step, and change the **Pitch Offset** value for each to create a melody using a single tone. (See “Melody pattern”)

Gate: Specifies the length of the arpeggio note for each step. With a setting of Legato, the note will continue sounding either until the next note of the same tone or until the end of the pattern. With a setting of Off, the note will not sound.

Velocity: This specifies the strength of the note. With a setting of Key, the note will sound at the strength of how it was actually played.

⚠ The **Gate** and **Velocity** settings you select here will be valid if the **Gate** and **Velocity** parameters (Program P7: ARP/DT– ARP Setup page) of the program selected in Program mode are set to Step. If these parameters have a setting other than Step, the **Gate** and **Velocity** that were specified for each individual step will be ignored, and all notes of the arpeggio will sound according to the settings in Program P7: ARP/DT– ARP Setup page. Be sure to verify the settings of the program.

⚠ When editing **Gate**, **Velocity**, and **Swing**, use the **SELECT** button to select ARP, and set knob 1 (GATE) and knob 2 (VELOCITY) to the center position (12 o’clock).

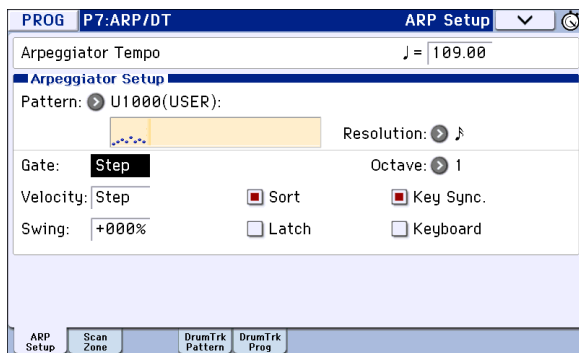

5. To change the user arpeggio pattern name, use the “Rename Arpeggio Pattern” menu command. (See page 221 of the Parameter Guide)
6. If you wish to save the edited user arpeggio pattern to internal memory, be sure to Write the user arpeggio pattern. (See page 221 of the Parameter Guide)

If you turn off the power without writing, the edited contents will be lost.

7. If you wish to save the state of the program at the same time, return to Program mode and write the program. (See page 115)

Other examples of creating a user arpeggio pattern

Melody pattern

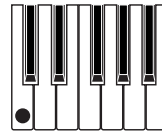

1. Press the alternate button.
2. In the touch grid, set tone 0 for “Step” 01, 02, 03, 04, 05, 07, and 08 (i.e., all but 06).
3. Specify the pitch. Set the “Step” 02 “Pitch” to +10, “Step” 05 “Pitch” to +12, and the “Step” 08 “Pitch” to –2.

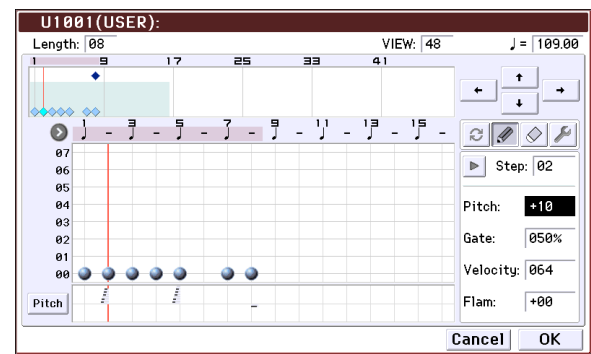

4. Play a single key; the arpeggio will begin playing.

Chordal pattern



1. Press the alternate button.
2. In the touch grid, set tone 00 of “Step” 01.
3. In “Step” 03, 04, 06, and 07, set tones 00–04.
4. Select “Step” 01, and set “Gate” to Legato.
5. Select “Step” 06, and set “Gate” to Legato.

Note: To simulate the timing nuances of a strummed guitar chord, select **Flam**. In Program mode, select an acoustic guitar program, and choose the user arpeggio pattern that you created here. In the Arpeg. Program P7: ARP/DT– ARP Setup page, set **Gate** to Step.

Then return to the Global P6: Arpeggio Pattern– Setup page. For odd-numbered steps, set **Flam** to a positive (+) value. For even-numbered steps, set **Flam** to a negative (-) value.

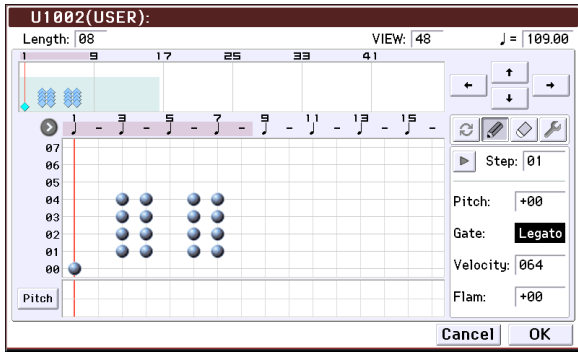

Drum pattern

You can use the arpeggiator to play a rhythm pattern by using “Fixed Note” with a drum program.

- In Program mode, select a drum kit program.**
For this example, select the preset program A017: Jazz Dry/Amb1 Kit (Category: Drums).
- In Global P6: Arpeggio Pattern, select the Setup page, and parameter settings.**

Arpeggio Tone Mode: Set this to Fixed Note. This will cause the tone to always sound at the specified pitch.

Fixed Note Mode: If you set this to Trigger All Tones, playing a single note on the keyboard will sound all tones.

If you set this to **Trigger As Played**, the tones will be sounded according to the notes you play on the keyboard (see page 212 of the Parameter Guide).

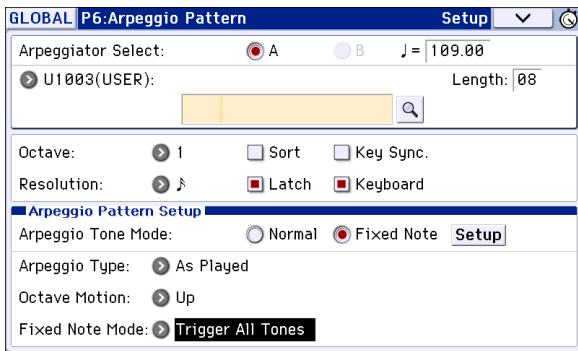

3. Select the Edit page.

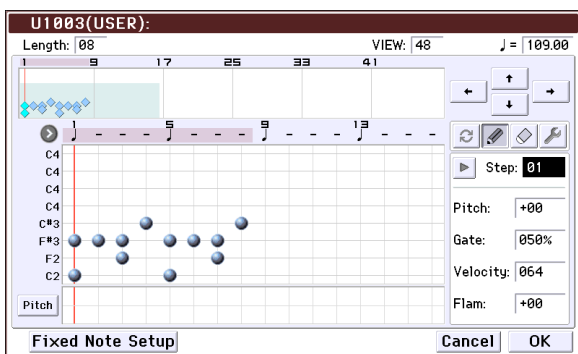

Let’s input the following rhythm pattern.

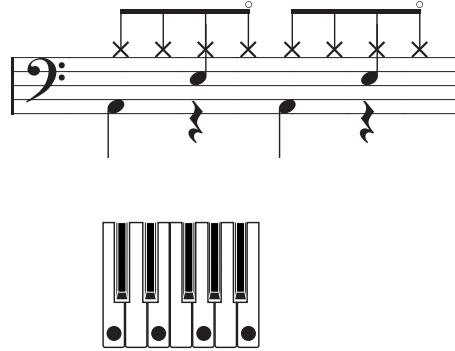

4. For each “Tone,” specify “Fixed Note No.”

Use the Fixed Note Setup button to open the dialog box. Here you can assign a different drumsample (note number) of the drum kit to each fixed note.

For this example, set **Tone No.** and **Fixed Note No.** as follows.

Tone No.	Fixed Note No.
00	C2 (kick)
01	F2 (snare)
02	F#3 (closed hi-hat)
03	A#3 (open hi-hat)

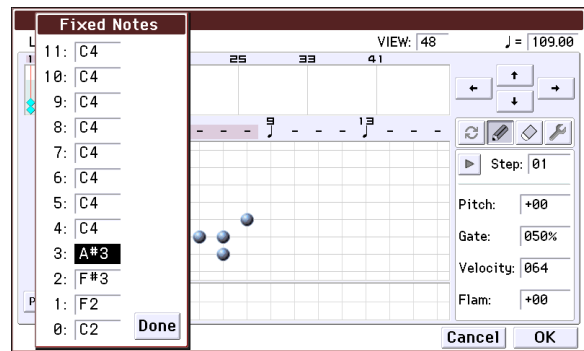

The drumsample corresponding to each note number will differ depending on the drum kit. It’s best to play the keyboard to find the drum sound you want; then hold down **Fixed Note No.** and play that note to enter the desired note number.

5. Press the alternate button.

6. Enter the kick (Tone00).

In the touch grid, set tone 00 (C2) of **Step 01** and 05.

7. Enter the snare (Tone01).

In the touch grid, set tone 01 (F2) of **Step 03** and 07.

8. Enter the closed hi-hat (Tone02).

In the touch grid, set tone 02 (F#3) of **Step 01, 02, 03, 05, 06, and 07.**

9. Enter the open hi-hat (Tone03).

In the touch grid, set tone 03 (A#3) for **Step 04.**

10. If Fixed Note Mode is set to Trigger As Played, playing a single note on the keyboard will cause only the kick (Tone00) to play.

Playing two notes on the keyboard will cause only the kick (Tone00) and snare (Tone01) to play. In this way, the number of keys that you play will be played by the same number of tones.

11. Set the parameters for each step.

Use **Velocity** etc. to add accents to the rhythm pattern.

 The **Gate** and **Velocity** settings you select here will be valid if the **Gate** and **Velocity** parameters (Program P7: ARP/DT– ARP Setup page) of the program selected in Program mode are set to Step. If these parameters have a setting other than Step, the **Gate** and **Velocity** that were specified for each individual step will be ignored, and the notes of the arpeggio will be sounded according to the settings of the Program P7: ARP/DT– ARP Setup page. Check the settings of the program.

 When specifying **Gate** and **Velocity**, press the control surface ARP button, and set knob 1 (GATE) and knob 2 (VELOCITY) to the center position (12 o'clock).

7. If you wish to save the edited user arpeggio pattern in internal memory, you must write the user arpeggio pattern.

In this case, both user arpeggio patterns will be written simultaneously. If you turn off the power without writing, the edited contents will be lost (see page 221 of the Parameter Guide).

8. If you wish to save the state of the combination at the same time, return to Combination mode and write the combination. (See page 115)

Note: When editing a user arpeggio pattern, pay attention to the global MIDI channel, the channel of each track, and the arpeggiator assignments, and make sure that the arpeggiator you are hearing is the pattern that you wish to edit.

Dual arpeggiator editing

Here we will use a combination as an example in our explanation.

The same procedure applies when editing an arpeggio pattern in Sequencer mode.

If you have entered this mode from the Combination mode, the arpeggio pattern selected by the combination will be affected by your editing.

1. In Combination mode, select a combination that uses the arpeggio pattern you wish to edit.

For this example, select a combination where both arpeggiators A and B are assigned.

2. Press the ARP button to turn on the arpeggiator (the button will light up).

Even if the arpeggiator had been turned off when you moved here, you can use the ARP button to turn it on. However, if **Arpeggiator Run A** or **B** are not checked, and if **Arpeggiator Assign**, is set to off, then the arpeggiator will not function.

3. Select the Global P6: Arpeggio Pattern– Setup page.**4. If you accessed this page from Combination mode, use the “Arpeggio Select” A and B to select the arpeggiator that you wish to edit.**

If this is A, your editing will apply to the parameters and user arpeggio pattern of arpeggiator A.

If this is B, your editing will apply to the parameters and user arpeggio pattern of arpeggiator B.

5. Switch between arpeggiators A and B, and edit their respective user arpeggio patterns.

If you wish to stop one of the arpeggiators, return to Combination mode, and in Combination P0: Play– Arpeggio A or the Arpeggio B page and uncheck the **Arpeggiator Run** check box.

6. To modify the name of a user arpeggio pattern, use the Utility “Rename Arpeggio Pattern.” (See page 221 of the Parameter Guide)

Regarding arpeggiator synchronization

“Key Sync.” parameter

The timing of the arpeggiator notes depends on the state of the arpeggiator **Key Sync.** check box.

If this box is checked, the arpeggiator will start running at the first note-on that occurs after you’ve taken your hands completely off the keyboard.

If this box is unchecked, the arpeggiator will run in synchronization with the internal/external MIDI clock.

Below, we will explain how synchronization occurs when the **Key Sync.** check box is not checked (Synchronization with Song Start and with MIDI realtime Start messages are excluded).

Synchronization between arpeggiators A and B

In Combination and Sequencer modes, the two arpeggiators can run simultaneously. In this case, if one arpeggiator is already running, and you then run the other arpeggiator (with “Key Sync.” unchecked), the second arpeggiator will synchronize to the “♪(Tempo)” based on the first arpeggiator.

If **Key Sync.** is checked, arpeggiators A and B will run independently, each at their own tempo.

Synchronization with the drum track

If you want the arpeggiator to synchronize to the drum track pattern that’s currently playing, uncheck the **Key Sync.** setting. In this case, the arpeggiator will synchronize to the beat of the drum track pattern that’s currently playing.

If you want the drum track pattern to synchronize to the arpeggiator that’s currently running, turn on the “Sync” setting (the Trigger parameter of the Drum Track page of each mode).

Synchronization between the arpeggiator and sequencer in Sequencer mode

If song playback is stopped

- The arpeggiator will synchronize to the “♪(Tempo)” based on the internal MIDI clock timing.
- If an RPPR pattern is playing in Sequencer mode, the arpeggiator will synchronize to the beat based on that pattern.

If you want the RPPR pattern playback to synchronize to the arpeggiator that’s currently running, set “Sync” to SEQ (SEQ P10: Pattern/RPPR– RPPR Setup page).

Pattern playback will synchronize to the “♪(Tempo)” timing of the arpeggiator.

While playing back or recording a song

- The arpeggiator will synchronize to the beat based on the timing of the song.

Synchronization with Song Start

- If the arpeggiator is turned on (ARP button is on) and is running, it will reset to the beginning of its arpeggio pattern when a Song Start is received. (This is unaffected by the **Key Sync.** setting.)
- In Sequencer mode when **Key Sync.** is unchecked and the ARP button is on, if you start the arpeggiator by pressing a key during the pre-count before recording begins, the arpeggiator will start its pattern as soon as recording begins, and will be recorded.

Synchronization with external sequencer playback

If “♪(Tempo)” is EXT (i.e., if Global P1: MIDI MIDI Clock is External MIDI or External USB) in Program, Combination, or Sequencer modes, the arpeggiator will synchronize to the MIDI timing Clock and Start messages received from a connected MIDI device.

Note: Synchronization will occur in the same way if **MIDI timing Clock** is Auto and MIDI realtime clock messages are being received from a connected MIDI device.

Synchronization with external MIDI timing clock

The arpeggiator will synchronize to the “♪(Tempo)” timing of the external MIDI timing clock.

Synchronization with MIDI realtime Start messages

If the arpeggiator is turned on and running, an incoming MIDI realtime Start message will reset the arpeggiator to the beginning of its pattern (This is unaffected by the **Key Sync.** setting).

Drum Track function

Performing with the Drum Track function

The Drum Track function makes it easy to play the KROME's high-quality drum programs using a wide variety of Drum Track patterns.

It provides a convenient way for you to hear Drum Track patterns while you try out various phrases on a program or combination, or work out the outline of your song. Then, when you've come up with some ideas, you can use the Auto Song Setup function to immediately start recording in Sequencer mode.

You can use preset drum patterns that cover a wide range of musical styles, as well as user patterns that you yourself created.

Preset	P001...P605	Preset Drum Track patterns
User	U000...U999	User Drum Track patterns

You can write your own patterns into U000–U999. User patterns you've created in Sequencer mode can be converted into user Drum Track patterns.

The Drum Track pattern will start immediately when you press the DRUM TRACK button, or when you play the keyboard after pressing the ON/OFF button. If you're starting the pattern by playing the keyboard, you have the option of starting it by using a specific range of notes or velocities.

In Program mode, the drum track has a dedicated mixer channel (including EQ) and effect routing, allowing you to control the drum track independently from the sound of the program itself. In Combination and Sequencer modes, the drum track is handled as a conventional timbre or track, allowing you to select programs, edit EQ settings, and specify the effect routing in the same way as for conventional timbres or tracks.

Using the Drum Track function in Program mode

Turning the Drum Track function on/off

1. In Program mode, select a program (see "Selecting Programs" on page 21).

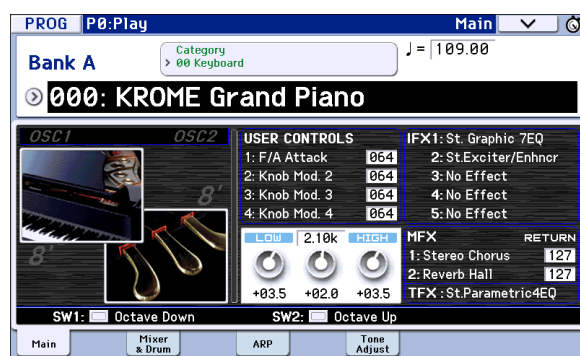

2. Press the DRUM TRACK button.

The ON/OFF button will light up or blink, depending on the setting (**Trigger Mode**) of the program.

If lit: The Drum Track pattern will start according to the **Sync** setting. When you turn it off, the pattern will stop. (This will occur if the **Trigger Mode** parameter is set to Start Immediately.)

If blinking: The Drum Track pattern will be ready to start. It will start when you play the keyboard or when a MIDI note-on is received. (This will occur if the **Trigger Mode** parameter is set to Wait KBD Trigger.)

Adjusting the performance tempo

- You can use the TEMPO knob or the TAP button to adjust the performance tempo.

This will change the "♩=" value located on the upper right side of the display. You can adjust the tempo with a range of 40.00–300.00 bpm. The LED located above the TAP button will blink at intervals of a quarter note (♩).

You can also adjust the tempo by choosing "♩=" in the display. Use numeric keys 0–9 to enter the tempo, and then press the ENTER button. You can also use the VALUE controller to set the tempo. The LED will blink at the tempo you specify.

Note: The tempo setting is also saved when you write a program.

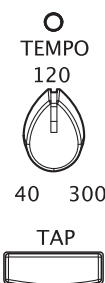

⚡ If the Global P1: MIDI- MIDI Basic page MIDI Clock parameter is set to External MIDI, External USB, or set to Auto and MIDI Clock messages are being received, the display will indicate “J=“ EXT, and the KROME will be synchronized to an external MIDI device. In this case, you won't be able to change the tempo by using the KROME.

Selecting a Drum Track pattern and Drum Track program

1. Access the Prog P0: Play- Main page.

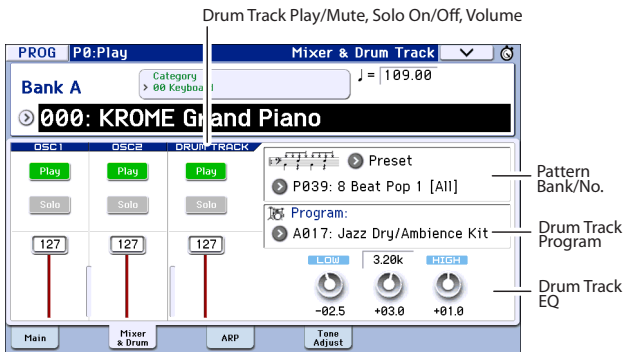

2. Select a Drum Track pattern. Use “Pattern Bank/No.” to select the preset or the user bank, and use “Pattern No.” to select the pattern number.
3. Use “Drum Track Program” to select the program that will play the Drum Track pattern.

Note: You can only select programs of category number 15 (Drums). If you want to use an original program you created as the Drum Track program, save it with “Category” set to 15 (see page 30).

Note: If you've selected an empty pattern, the DRUM TRACK button will not function.

These parameters can also be set from P7: ARP/DT page.

Setting the EQ, volume, mute, and solo for the drum track pattern

In the Prog P0: Play- Mixer & Drum Track page you can use a 3-band EQ to adjust the sound of the drum track program. You can also edit the volume, mute, and solo settings.

Using the Drum Track function in Combination mode

Selecting a combination and turning the Drum Track function on/off

1. Press the COMBI button to enter Combination mode, and select the desired combination. For details, please see “Selecting Combinations” on page 43.

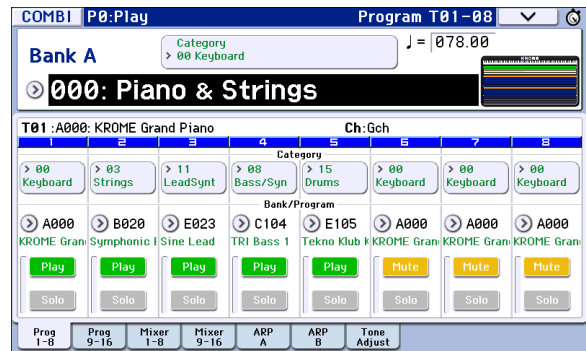

2. Press the DRUM TRACK button.

The ON/OFF button will light up or blink, depending on the setting (Trigger Mode) of the combination.

If lit: The Drum Track pattern will start according to the Sync setting. When you turn it off, the pattern will stop. (This will occur if the Trigger Mode parameter is set to Start Immediately.)

If blinking: The Drum Track pattern will be ready to start. It will start when you play the keyboard or when a MIDI note-on is received. (This will occur if the Trigger Mode is set to Wait KBD Trigger.)

Adjusting the performance tempo

You can use the TEMPO knob or the TAP button to adjust the performance tempo.

Selecting a Drum Track pattern and Drum Track program

Unlike its functionality in Program mode, the Drum Track function in Combination mode does not have its own dedicated track (timbre). The program that plays the Drum Track pattern will use the timbre that you specify.

1. In the Combi P0: Play- Program T01-08 page or T09-16 page, select the timbre that you want to use for the drum track, and then select the Drum Track program.

In the following illustration, we've selected timbre 5 for use by the drum track.

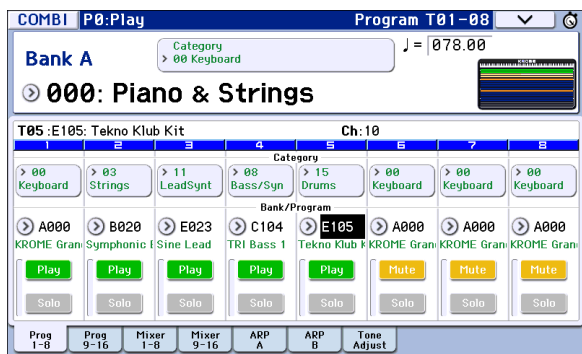

2. Specify the MIDI channel of the drum track timbre.

Be aware that if another timbre uses the same MIDI channel, that timbre will also be played.

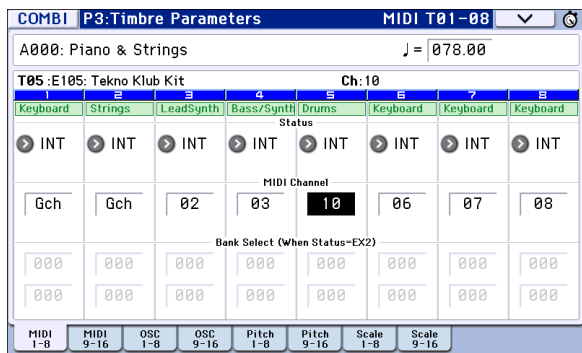

3. Access the Combi P7: ARP/DT- Drum Track page.

Specify the drum track's MIDI channel **Output**. Set this to match the **MIDI Channel** of the timbre you specified in step 2.

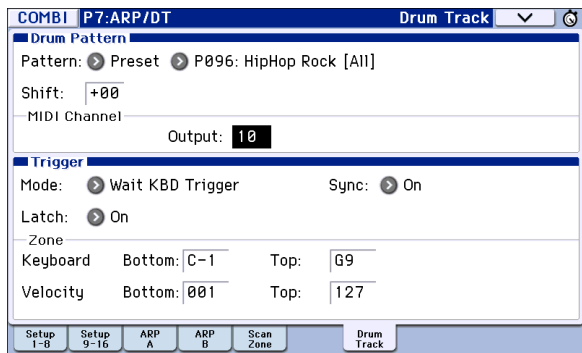

4. Select a Drum Track pattern. Use "Pattern (Pattern Bank)" to select the preset or user bank, and use "Pattern No." to select the pattern number.

Note: If you select an empty pattern, the DRUM TRACK button will not function.

5. Press the DRUM TRACK button to verify that the pattern plays correctly.

The method of triggering will depend on the Trigger settings. If the **Trigger Mode** parameter is set to Start Immediately, the Drum Track pattern will start when you press the DRUM TRACK button. For details on the Trigger settings, please see "7-4b: Trigger" on page 56 of the Parameter Guide.

Drum Track function settings

Drum Track function settings in Program mode

Starting/stopping the drum track

1. Access the Prog P7: ARP/DT- Drum Track Pattern page.

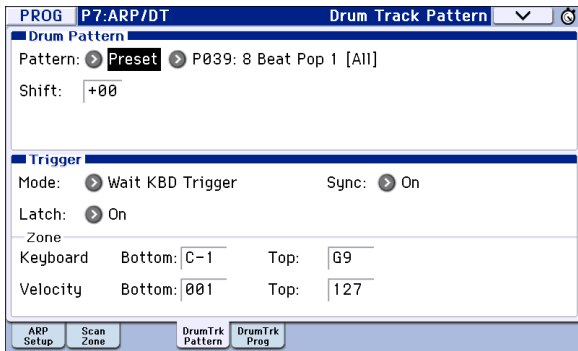

2. "Trigger Mode" specifies how the Drum Track pattern will be triggered.

Start Immediately: When you press the DRUM TRACK button to turn it on, the LED will light up and the Drum Track pattern will start according to the Sync setting. It will stop when you press the DRUM TRACK button to turn it off.

Wait KBD Trigger: When you press the DRUM TRACK button to turn it on, the LED will blink and the Drum Track pattern will wait to start. When you play the keyboard or receive a MIDI note-on, the Drum Track pattern will start according to the Sync setting.

3. Specify the Sync setting.

Off: The Drum Track pattern will not synchronize to the arpeggiator that's currently running, but will start immediately.

On: The Drum Track pattern will synchronize to the arpeggiator that's currently running.

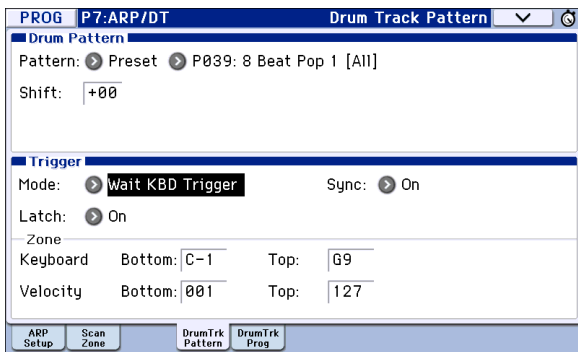

4. If "Trigger Mode" is set to Wait KBD Trigger, specify the "Latch" setting. "Latch" specifies whether the Drum Track pattern will continue playing even after you take your hand off the keyboard.

Off: If the DRUM TRACK button is on (the LED will blink), the pattern will start when you play the keyboard (note-on). The pattern will stop when you release the keyboard (note-off).

On: If the DRUM TRACK button is on (the LED will blink), the pattern will start when you play the keyboard (note-on). The pattern will continue when you release the keyboard (note-off). The pattern will stop when you turn the DRUM TRACK button off (the LED will go dark).

5. If "Trigger Mode" is set to Wait KBD Trigger, specify the Keyboard Zone and Velocity Zone.

These settings specify the range of keys and velocities that will trigger the Drum Track pattern when you play the keyboard (or receive a note-on).

Saving the on/off status

If "Trigger Mode" is set to Wait KBD Trigger, the drum track's on/off status can be saved in the program.

If "Trigger Mode" is set to Start Immediately, the drum track's on/off status will always be saved as "off," regardless of the state of the DRUM TRACK button.

EQ adjustments for the Drum Track program

You can adjust a three-band EQ for the Drum Track program.

If you turn "Auto Load Program EQ" on (selected), the three-band EQ settings specified for the program will be automatically loaded when you switch Drum Track programs. Normally you will leave this selected.

You are free to adjust the three-band EQ settings that are loaded automatically. These adjustments are applied relative to the original settings of the program.



MIDI transmission and reception for the drum track

In Program mode, the Drum Track function transmits and receives on the following MIDI channels.

Receive: If you're controlling the triggering by playing the keyboard, the drum track will receive on the global MIDI channel.

Transmit: The drum track will transmit on the MIDI channel specified by Drum Track **Prog MIDI Ch** (default: channel 10). (Note data etc. of the Drum Track program will be transmitted.)

Note: MIDI transmission of the pattern data is enabled if Drum Track **Prog MIDI Out** is selected. The default setting is off (unselected).

The Drum Track program does not transmit or receive program changes.

Drum Track function settings in Combination mode

Unlike Program mode, Combination mode does not have a dedicated track for the Drum Track function. You'll need to specify a timbre 1–16 as the one for use by the Drum Track program.

Then set the drum track's output MIDI channel **Output** to match the timbre's MIDI channel **MIDI Channel** so that the Drum Track program can be played.

For details, please see "Selecting a Drum Track pattern and Drum Track program" on page 98.

MIDI transmission and reception for the drum track

In Combination mode, the Drum Track function transmits and receives on the following MIDI channels.

Receive: If you're controlling the triggering by playing the keyboard, the drum track will receive on the global MIDI channel.

Transmit: The drum track will transmit on the MIDI channel specified by the Drum Pattern **Output** setting of each combination.

Set this to match the MIDI channel of the timbre you've specified for the drum program.

If the timbre's **Status** is EXT or EX2, the note data etc. of the Drum Track pattern will be transmitted.

Drum Track function settings in Sequencer mode

The parameters for the Drum Track function are structured in the same way as in Combination mode. Assign the Drum Track program to the desired track 1–16.

However, while a combination triggers the Drum Track pattern on the global MIDI channel, a song triggers the Drum Track pattern on the MIDI channel specified by the Drum Pattern **Input**. Normally you'll set this to Tch. With the Tch setting, the MIDI channel of the track selected by **Track Select** will automatically be used as the trigger channel.

For details, please see "Selecting a Drum Track pattern and Drum Track program" on page 98.

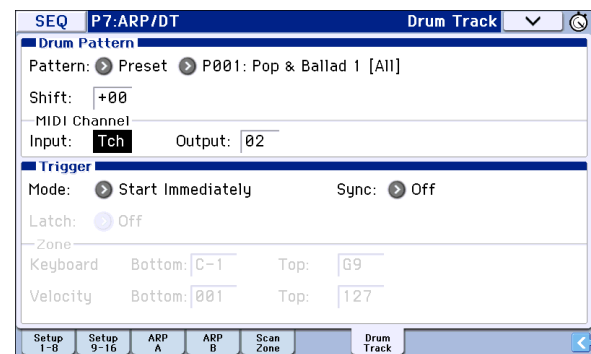

In Sequencer mode you can use the Drum Track function while realtime-recording a song track or pattern.

The note-on/off data transmitted by the Drum Track pattern can be recorded as events in a track or pattern.

 You can't use note data from the internal sequencer as a trigger to start patterns for the Drum Track function.

When you've used the Drum Track function with a program or combination to come up with an idea for a song, you can then use the Auto Song Setup function to immediately start realtime-recording (see page 59).

MIDI transmission and reception for the drum track

In Sequencer mode, the Drum Track function transmits and receives on the following MIDI channels.

Receive: The drum track will receive on the MIDI channel specified by the Drum Pattern **Input** setting of each song. Normally you'll set this to Tch and use the KROME's keyboard to control the triggering.

Transmit: The drum track will transmit on the MIDI channel specified by the Drum Pattern **Output** setting of each song. Set this to match the MIDI channel of the MIDI track where you've assigned the drum program.

If the track's **Status** is BTH, EXT, or EX2, note data etc. of the Drum Track pattern will be transmitted.

Synchronizing the Drum Track function

The Trigger “Sync” parameter

The trigger timing of a drum track will depend on the setting of its Trigger Sync parameter.

On (checked): The trigger timing will be quantized to the nearest beat relative to the base tempo.

Off (unchecked): If **Trigger Mode** is set to Start Immediately, triggering will occur at the moment you press the DRUM TRACK button. If this is set to Wait KBD Trigger, triggering will occur at the moment you play the keyboard.

Synchronizing the drum track with the KARMA function, Sequencer mode songs, patterns, and RPPR performance

If you want the Drum Track pattern to play or be recorded in synchronization with the arpeggiator that’s currently running, a currently-playing song, pattern, or RPPR performance, turn **Trigger Sync** on.

Trigger Sync Off: If the **Trigger Mode** setting is Start Immediately, the Drum Track pattern will be triggered the moment you press the DRUM TRACK button. If this is set to Wait KBD Trigger, the Drum Track pattern will be triggered the moment you play the keyboard. It will not synchronize to the arpeggiator that’s currently running or to the song, pattern, or RPPR that’s currently active.

Trigger Sync On: Triggering will synchronize to the song that’s currently playing, pattern or RPPR performance in units of a measure. Triggering will synchronize to the arpeggiator that’s currently running (in Sequencer mode if the song or pattern is stopped) in units of a beat.

Note: If you want to synchronize arpeggiator to the Drum Track function that’s currently running, set the **Sync** parameter (Prog/Combi/Seq P7: ARP/DT-DrumTrk Pattern).

Note: If you want to synchronize the RPPR pattern performance to the Drum Track function that’s currently running, set the **Sync** parameter (Seq P10: Pattern/RPPR– RPPR Setup page) to Beat or Measure.

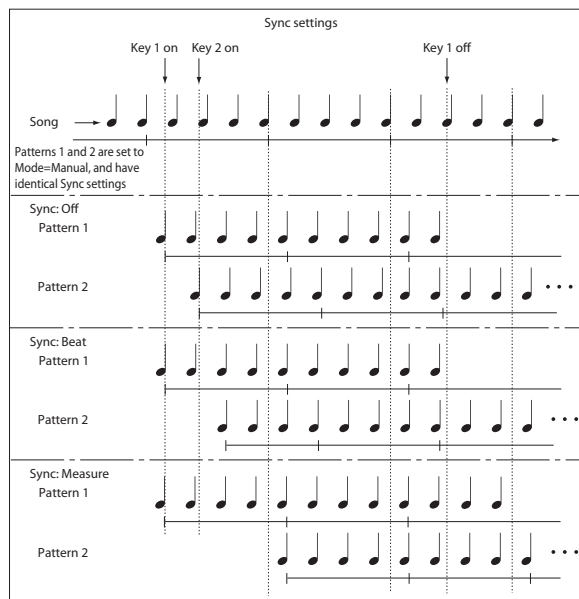

Synchronization with song stop

Synchronization with a song in Sequencer mode

- When you press the SEQUENCER START/STOP (▶/■) button, the Drum Track function will stop as well as the sequencer.
- If you want the Drum Track function to start simultaneously with the start of recording, press the DRUM TRACK button during the pre-count before recording (if **Trigger Mode** is set to Start Immediately) or play the keyboard (if **Trigger Mode** is Wait KBD Trigger). The Drum Tracks will not be triggered immediately, but will be triggered in synchronization with the sequencer the moment recording starts.

Slave operation

Connect the KROME’s MIDI IN to your external MIDI device’s MIDI OUT, or connect the KROME’s USB B connector to your computer’s USB port.

Set **MIDI Clock** (see page 111) to External MIDI or External USB.

Note: If the KROME is set to **MIDI Clock= Auto**, it will also synchronize to the external MIDI device in the same way if MIDI timing clock messages are being received from the external device.

Synchronization to MIDI clock

The arpeggiator function will synchronize to a tempo based on the external MIDI clock timing.

Synchronization with MIDI realtime commands

In Sequencer mode, Song Start, Continue, and Stop messages that the KROME receives will control song playback and recording just as when you use the front panel START/STOP (▶/■) button. The KARMA function also will be controlled in the same way as when you use the front panel START/STOP (▶/■) button. (See “Synchronization with song stop”)

Master operation

If you want an external MIDI device or computer to synchronize to the KROME's MIDI timing clock and realtime commands, connect the KROME's MIDI OUT to your external MIDI device's MIDI IN, or connect the KROME's USB port to your computer's USB port.

Set **MIDI Clock** to Internal.

Note: The same applies if **MIDI Clock**=Auto and MIDI realtime clock messages are being transmitted (see page 111).

Synchronization via MIDI clock

The connected external MIDI device will synchronize to the MIDI clock of the KROME.

Creating a Drum Track pattern

Once you've converted the pattern in this way, you'll be able to use it with the drum track in each mode. These converted Drum Track patterns are held in internal memory even after you turn off the power. This means you can manage them together with the programs and combinations.

Preparing a user pattern

You'll first need to prepare the user pattern that you want to convert to a Drum Track pattern.

To create a user pattern, you can realtime-record it (see page 65) in the Seq P10: Pattern/RPPR- Pattern Edit page, or step-record it (see page 167 of the Parameter Guide).

Alternatively, performance data from a track can be imported into a pattern, meaning that performance data you've created in a track or SMF data you've loaded in Media mode can be used as a user pattern. To do this, execute the **Get From Track** menu command in the Seq P10: Pattern/RPPR- Pattern Edit page (see page 187 of the Parameter Guide).

Converting to a Drum Track pattern

1. Press the **SEQ** button to enter Sequencer mode.
2. Access the Seq P10: Patern/RPPR- Pattern Edit page.
3. Select the user pattern that you want to convert to a Drum Track pattern.

Set **Pattern** to User, and use **Pattern Select** to select the desired pattern.

4. Choose the menu command **Convert to Drum Trk Pattern** to access the dialog box.

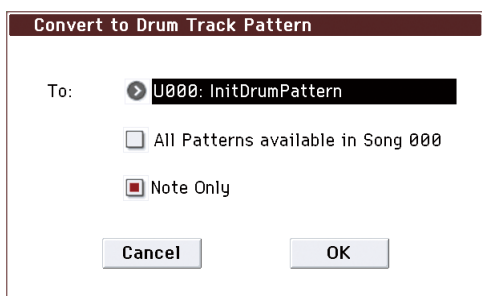

5. Use the **To "Drum Track Pattern Select"** field to specify the user Drum Track pattern number that will hold the converted data. When you execute the command, the data will be overwritten onto this number.
6. If you select the **"All Patterns available in Song ***"** option, all patterns in the song that contain note data will be converted, starting with the number you specified in step 3.
7. If you execute this command with **"Note Only"** selected, only the note events will be converted.
8. Press the **OK** button or the **ENTER** button to execute. If you decide not to execute, press the **Cancel** button or the **EXIT** button.
9. As described in **"Using the Drum Track function in Program mode"** on page 97, set the Drum Track **"Pattern Bank"** to User, and set **"Pattern No."** to the user Drum Track pattern you converted. Then play the Drum Track pattern.

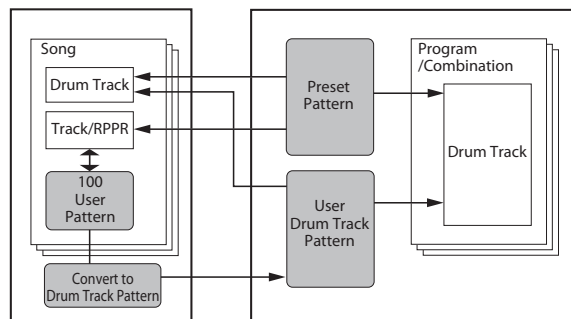

Sequencer memory
(Not saved internally;
save on external USB
media.)

Internal memory (saved inside the KROME)

⚠ If the drum pattern memory is insufficient, or if there are not enough pattern slots, the error message **"Not enough Drum Track pattern memory"** or **"Not enough Drum Track pattern locations available"** will appear, and the command cannot be executed.

Tip: It's a good idea to convert drum patterns that you use frequently. Use **"Load Drum Track Pattern"** to load them.

Using Drum Kits

Drum Kit Overview

What's a Drum Kit?

A drum kit is a collection of drumsamples (drum set sounds such as bass drum, snare, or cymbals, as well as a wide variety of other percussion sounds), with each sample assigned to a note of the keyboard.

- Each key can play a different sound
- On each key, you can use up to eight Drumsamples, with velocity crossfades
- Each key has separate settings for the most important sound parameters, including volume, filter cutoff and resonance, envelope attack and decay, pitch, drive and low boost, and gain for each band of the Program EQ.
For instance, you could combine high drive and low cutoff frequency to create a lo-fi effect on only a few sounds, while the rest of the sounds remained clear and pristine.
- Each note can be routed to different Insert Effects, or have separate FX Send amounts. For instance, you can send a snare sound through a dedicated compressor.

You can use Drum Kits only in Programs whose **Oscillator Mode** is set to **Single** or **Double Drums**.

Drum Kit memory structure

The KROME has over 161 Drum Kits, divided into Internal, User, and GM (General MIDI) groups as shown below. You can edit or write into any of the locations except for the GM bank, which cannot be erased.

Drum Kit contents

Bank	No.	Contents
INT	00...31	Preload Drum Kits
User	32...47	User Drum Kits
GM 0	48...56	GM2 Drum Kits

The 9 Drum Kits in the GM bank are compatible with the GM2 sound map. The other Drum Kits may use different mappings, where appropriate.

Using a drum kit in a program (Oscillator Mode)

In the Program P1: Basic Ctrl's–Program Basic page, set the **Oscillator Mode** parameter to **Drums** or **Double Drums**. Then for the oscillator, select the drum kit that you want to use.

Before you start editing...

Selecting a drum program

Drum Kits are edited in Global Mode. While you're in Global Mode, you'll play the kit that you're editing as if you were playing it from within the Program, Combi, or Song which was selected before you entered Global mode.

So, before you enter Global mode, it's best to select a Program which is already set up for drums, with the appropriate EG settings, effects, and so on. Just use the Program Category select popup, and choose a drum Program such as "Studio Standard Kit."

🚩 Even if the program's oscillator is set to **Double Drums**, this page will show only the single drum kit that is selected by **Drum Kit Select**.

Matching the key of the keyboard with the drum kit

In order for the note mappings to match the keyboard, the Oscillator's **Octave** setting needs to be **+0 [8']**. All Drum Kit Programs should have this setting already. If you're unsure, you can check this yourself:

1. Go to the **OSC1 Setup** tab of the **OSC/Pitch** page. With a setting other than **+0 [8']**, the relationship between the keys and the Drum Kit sound map will be incorrect.
2. Set the **Global P0: Basic Setup–Basic parameter "Key Transpose"** to **+00**.

Make sure that Memory Protect is disabled

Before you start editing, go to the **Global P0: Basic Setup–System Preferences** page, and look in the **Memory Protect** section. Make sure that **Drum Kit** is not checked—if so, you won't be able to make any edits.

Drum Kits may be used by more than one Program

When you edit a Drum Kit, all Programs that use that Drum Kit will be affected. To avoid changing the factory voicing, you may wish to copy Drum Kits to empty locations in the **USER** banks before editing.

Editing a Drum Kit

Basic Editing

1. Select the Program that you wish to use while editing the Drum Kit.
2. Access the P2: OSC/Pitch– OSC1 Setup page or the OSC2 Setup page (Double Drums only), and press the Jump to Drum Kit Edit button.

If you want to edit the OSC2 drum kit of a double drums program, press the Jump to Drum Kit Edit button from the P2: OSC/Pitch– OSC2 Setup page.



You'll jump to the Global mode P5: Drum Kit– Sample Setup page.

Note: If you enter Global mode by pressing the GLOBAL button or the mode button, and then access the P5: Drum Kit– Sample Setup page, the OSC1 sound settings will be used.

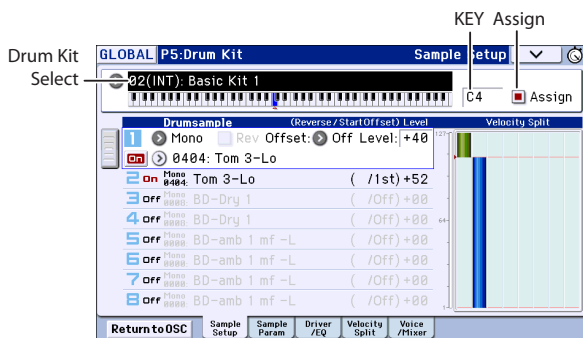

3. In the top line of the display, use "Drum Kit Select" to select the drum kit that you want to edit.

⚠ GM drum kits 48 (GM)–56 (GM) cannot be selected here. (It is not possible to edit or write a GM drum kit.) If you wish to modify the settings of one of the drum kits 48 (GM)–56 (GM), you can use **Copy Drum Kit** to copy it to 00 (INT)–47 (USER), and then edit the copy.

4. Use the Key parameter to select the note that you wish to edit.

To select a key, you can use any of the standard VALUE controllers (the dial, numeric keypad etc.). As a shortcut, you can also hold down the **Key** and play a note on the keyboard.

This Key selection applies to all five Drum Kit editing pages.

5. Use the Assign check box to specify whether the key will have its own settings, or use the same settings as the next higher note.

If **Assign** is checked, the key will have its own settings. This is the default.

If **Assign** is not checked, the key won't have its own settings. Instead, it will use the same settings as the next higher note—except that the drumsamples will be played at a lower pitch. The amount of pitch change depends on the **Pitch Slope** parameter, on the Prog P2: OSC/Pitch– OSC1 Pitch or OSC2 Pitch page.

Use this setting when you want only to change the pitch, such as with tom or cymbal sounds.

Velocity crossfade settings

For this key, let's create a simple velocity crossfade between two stereo drumsamples.

1. On the left side of the page, make sure that **Drumsample1** and **2** are turned On.

Just press the On/Off buttons to toggle them, if necessary.

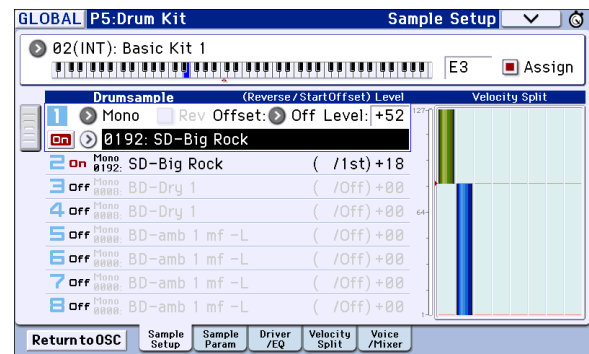

2. In the same way, make sure that **Drumsamples 3–8** are Off.

When they are turned off, most of their parameters will be grayed out.

3. Select **Stereo** as the Bank for **Drumsample1** and **Drumsample2**.

Drumsamples come in several types: **Mono**, **Stereo**, **VM.M**, or **VM.S**. Mono are mono drumsamples, and Stereo are stereo drumsamples. Stereo drumsamples use twice as many voices as mono drumsamples. VM.M and VM.S are respectively mono and stereo versions of large-capacity drumsamples.

Drumsamples are organized into categories such as bass drum or snare.

4. Press the **Drumsample** popup for **Drumsample1**.

This brings up a list of Drumsamples, organized by category. Use the tabs at the left of the display to browse through the different categories.

For a list of the Drumsample names, please see the Voice Name List.

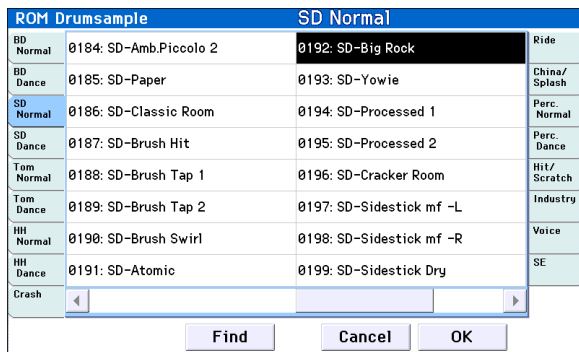

5. Select a Drumsample by touching its name in the list.
6. Press the OK button to confirm your selection.
7. Switch the slot to 2, and make settings for Drumsample 2 in the same way.

Now that you've assigned Drumsamples to Drumsample1 and Drumsample2, let's set up the velocity ranges and crossfades.

8. Access the P5: Drum Kit– Velocity Split page.
9. Set Drumsample2's Threshold Velocity to 1, and its Crossfade to Off.
10. Set Drumsample1's Threshold Velocity to 80.

You can edit the **Threshold Velocity** setting by touching and dragging the graphic on the right (see "EG, Velocity Split" on page 6).

Now, Drumsample2 will sound when you play softly, at velocities of 79 or less—and Drumsample1 will sound when you play harder, with velocities of 80 or more.

The meter at the left side of the Velocity Split graphic indicates the note-on velocity value. This lets you verify the drumsample that will be sounded by a given velocity.

11. Next, set Drumsample1's Crossfade to 20, and its Curve to Linear.

Notice that the graphic now shows the two ranges tapering into one another. Between 80 and 100, Drumsample2 will fade out, and Drumsample1 will fade in, creating a gradual velocity transition instead of a hard split.

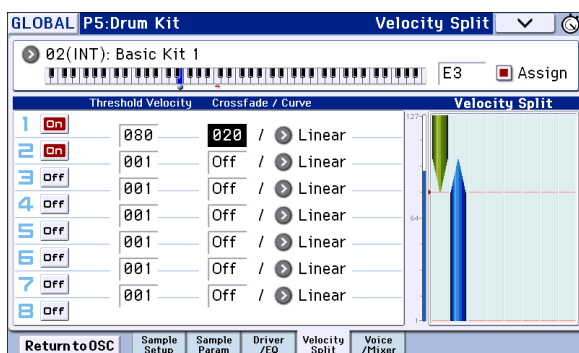

Fine-tuning the sound of each sample

1. If you like, adjust the Levels for the two Drumsamples.

This can be very useful in creating a smooth velocity split or crossfade.

2. As necessary, specify the tuning, EG parameters, and filter.

Access the P5: Drum Kit– Sample Parameter page.

Adjust **Tune**, **Attack (Amp EG Attack)**, **Decay (Amp EG Decay)**, **Cutoff** and **Resonance** for each drumsample.

3. You can also edit the drive, boost, and EQ for each drumsample.

Access the P5: Drum Kit– Drive/EQ page.

Adjust **Drive**, **Low Boost**, and **3 Band EQ Gain [dB]** for each drumsample.

4. Repeat "Basic Editing," on page 106 to set up each key of the Drum Kit.
5. You can also copy settings from one key to another, using the Copy Key Setup menu command.

Using Exclusive Groups

1. Access the P5: Drum Kit– Voice/Mixer page.
2. Use the Exclusive Groups to make one drum sound cut off another drum sound - such as closed and open hi-hats.

For example, let's say that you've assigned an open hi-hat and a closed hi-hat to the same exclusive group:

- Play the open hi-hat sound.
- While it's still ringing, play the closed hi-hat.
- The open hi-hat sound will be cut off—simulating the action of a physical hi-hat.

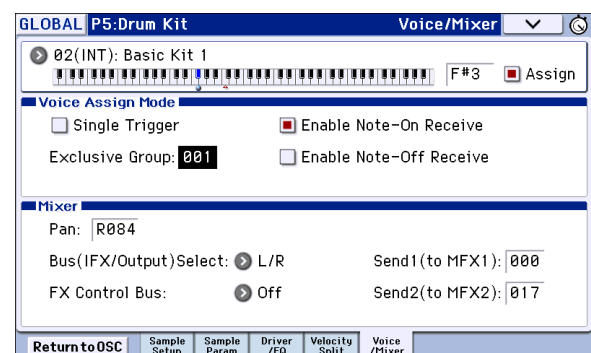

Sustaining the sound even after the key is released (Hold)

Use the **Hold** function for instruments that should continue sustaining even after the key is released, such as a crash cymbal. The way this works will depend on the settings of the program and drum kit.

Set the **Hold** function as follows.

1. Access the **Prog P1: Basic/Controllers– Note-On/ Scale page**.

If you jumped to the **Global P5: Drum Kit** page by pressing the **Jump to Drum kit Edit** button from Program mode, you can return to Program mode by pressing the **Return to OSC** button.

2. Under **Key Zone**, make sure that the **Hold check-box** is checked.

Once you've turned on **Hold** for the Program, the function is controlled on a note-by-note basis according to settings within the Drum Kit.

3. Access the **Global P5: Drum Kit– Voice/Mixer page**.

4. For each key, set the **Enable Note-Off Receive parameter** as desired.

If this check box is not selected, notes will be held, and the sound will continue even after the key is released.

If it is checked, the key will not be held.

If you turn off **Hold** in the Program, no keys will be held - regardless of their **Enable Note-Off Receive** setting.

Controlling effects for each key

Drum Kits have their own, built-in mixers. For each key, you can control the Insert Effects bussing, Master Effects sends, and pan.

To use separate bus settings for each key:

1. Access the **Prog P8: Routing/IFX– Routing page**.
2. Make sure that the **Use DKit Setting check-box** is checked.

When **Use DKit Setting** is on, the Program will use the **Bus Select** and **Effects Send** settings for each key of the Drum Kit.

When **Use DKit Setting** is off, the Program will ignore the Drum Kit's **Bus Select** and **Effects Send** settings.

3. Access the **Global P5: Drum Kit– Voice/Mixer page**.
4. Use the **Bus (IFX/Output) Select parameter** to send drum sounds through their own Insert effects, or to the L/R outputs.

If you like, you can send each note to its own Insert effect, or to the individual audio outputs, in addition to the L/R outputs.

For example, you might send all snare sounds to **IFX1**, all kick sounds to **IFX2**, and the remaining sounds to **L/R**.

Tip: In most preloaded drum kits, the drum instruments have the same **Bus (IFX/Output) Select** settings according to their type, as follows.

Snares → IFX1

Kicks → IFX2

Other → IFX3

5. Use **Send1** (to **MFX1**) and **Send2** (to **MFX2**) to set the send levels to the master effects.

Controlling pan for each key

To use separate pan settings for each key:

1. Access the **Prog P4: Amp/EQ– Amp1/Driver1 or Amp2/Drive2 page**.
2. Under **Pan**, make sure that the **Use DKit Setting check-box** is checked.

When **Use DKit Setting** is on, the Program will use the pan settings for each key of the Drum Kit.

3. Access the **Global P5: Drum Kit– Voice/Mixer page**.
4. Use **“Pan”** to specify the panning for each key.

Saving Drum Kits

Once you've spent some time editing, you'll want to save your work.

 The contents of your editing in Global mode are preserved as long as the power is on, but will be lost when you turn off the power. If you want to keep your edits, you must execute the **Write Drum Kits** function.

This will save all drum kits.

Adjusting Global KROME settings

How Global mode is structured

In Global mode you can adjust overall settings for the entire KROME. These consist mainly of the following settings.

- Master tune
- Key transpose
- Effect global button
- Global MIDI channel
- Creating scales
- Damper pedal, assignable foot switch/pedal
- Category names for programs and combinations
- Creating user drum kits
- Creating user arpeggio patterns

For details on how to access each page, please see “Basic operations” on page 9.

Three types of data are handled in Global mode: user drum kit settings (Global P5), user arpeggio patterns (Global P6), and other global settings (Global P0–4). Each of these has a respective memory area to store its data. This data can also be saved to various types of SD card in Media mode.

For details, please see “Writing Global settings, User Drum Kits and User Arpeggio Patterns” on page 116, and “Saving to SD card (Media-Save)” on page 118.

The Compare function that lets you return to the state prior to your editing (or undo edits) is not available in Global mode.

Global settings

Basic setup

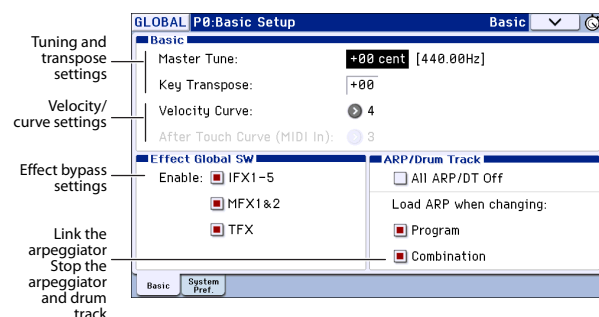

Tuning and Transposing

Tuning to another instrument

To adjust the tuning in fine increments, in order to match other instruments or recorded music:

1. In Global mode, go to P0: Basic Setup– Basic page.
2. Adjust the Master Tune to the desired pitch.

The Master Tune is adjustable over a range of ± 50 cents (one semitone = 100 cents). When Master Tune is at 0, middle A is tuned to 440 Hz.

Transposing the keyboard

You can also transpose the keyboard in semitones, for quick key-changes (for instance, if the band decides to play a song in F rather than E). To do so:

1. In Global mode, go to P0: Basic Setup– Basic page.
2. Adjust the Key Transpose as desired.

You can adjust the transposition over a range of ± 1 octave.

3. Use the Global mode P1: MIDI– MIDI Basic page Convert Position parameter to specify the position at which the transpose and velocity curve settings will be applied.

PreMIDI is the normal setting. With this setting, the Transpose setting described above and the Velocity Curve described below will be applied to the KROME’s keyboard performance data, and will affect both the MIDI OUT and the internal sound generator. This is also required in order to record the output of the curves into the internal sequencer.

PostMIDI applies the transposition and curves to incoming MIDI, for adjusting the KROME response to an external MIDI controller.

When simply playing the internal sounds from the KROME keyboard, both settings work the same.

Adjusting the keyboard response

Velocity curve let you adjust the way the KROME responds to how you play on the keyboard. The default setting should work for most players, but there are many other choices to let you customize the response to match your own style.

To set the velocity and after touch curves:

1. In Global mode, go to P0: Basic Setup– Basic page.
2. Set the Velocity Curve to suit your playing style.

Velocity Curve 4 is the default, and should work for most players.

Curve 9 is designed specifically for playing piano sounds from the weighted NH keyboards in the 73-note and 88-note models.

For details on the other curves, see the graphic below, as well as the “Velocity Curve” section on page 194 of the Parameter Guide.

3. Specify the position where the velocity curve will be applied. For more about “Convert Position,” please see “Transposing the keyboard,” above.

Velocity curves

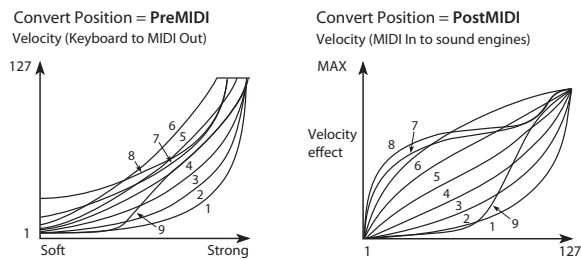

Bypassing the effects

You can bypass the KROME’s insert effects, master effects, and total effects. These settings will bypass the effects in all modes. If you’re using effects such as reverb or chorus provided by an external effect processor, mixer, or DAW, you can bypass the KROME’s own effects so that they will not be used.

1. Access the Global mode P0: Basic Setup– Basic page.
2. Use the various Effect Global SW buttons to select the effects that you want to bypass. The effect will be bypassed if the check box is cleared.

Clearing the “IFX 1-5” box: Bypasses the insert effects
 Clearing the “MFX 1&2” box: Bypasses the master effects

Clearing the “TFX 1&2” box: Bypasses the total effects
 “MFX1&2” and “TFX” can also be controlled by the front panel MASTER FX button and TOTAL FX button. This is convenient when you want to temporarily turn off these effects during a performance.

Note: These parameters will always be turned on when the KROME starts up.

Arpeggiator recall settings (Linking the arpeggiator with programs or combinations)

You can specify whether the arpeggiator settings written into each program or combination will also be selected when you select that program or combination, or whether the arpeggiator will stay in its current state without changing settings.

With the factory settings, the former will occur. You can choose the latter behavior if you want to play phrases and patterns with certain arpeggiator settings while you switch only the sound between different programs or combinations.

1. Access the Global mode P0: Basic Setup– Basic page.

2. In the “Load ARP when changing” area, if the “Program” or “Combination” box is selected, switching programs or combinations respectively will recall the arpeggiator settings written in that program or combination.

Disabling the arpeggiator and drum track

1. Access the Global mode P0: Basic Setup– Basic page.
2. If the “All ARP/DT Off” box is selected, all arpeggiator and drum track functionality will be turned off.

Even if the ARP or DRUM TRACK buttons are on, the arpeggiator and drum track will not function.

Recalling the last-selected mode and page at power-on

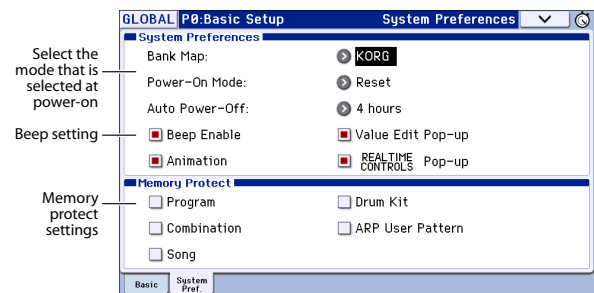

1. Access the Global mode P0: Basic Setup– System Preferences page.
2. If the Power-On Mode is set to Reset (factory setting), KROME will automatically select the Program mode P0: Play.

If the Power On Mode is set to Memorize, the location (mode and page) and the program or combination number that had been selected when you turned off the power will be recalled.

Enabling a beep tone when the display is pressed

1. Access the Global mode P0: Basic Setup– System Preferences page.
2. If the “Beep Enable” check box is selected, a beep tone will sound when you press an object in the display. Clear the check box if you don’t want a beep to sound.

Protecting the memory

1. Access the Global mode P0: Basic Setup– System Preferences page.
2. If a Memory Protect check box is selected, the corresponding write, data load, or song recording operation will be disabled, thus protecting the contents of memory.

Other screen display settings (Edit pad function and animation)

You can keep the edit pad (see page 4) or realtime control popup (see page 6) from appearing, and disable the animation that appears when a popup is displayed.

1. Access the Global mode P0: Basic Setup– System Preferences page.
2. If the “Value Edit Pop-up,” “Realtime Controls Pop-up,” and “Animation” check box are cleared, the respective function will be disabled.

Note: If the KROME is processing large amounts of musical data such as from the drum track or sequencer, the realtime control popups or animation effects might be disabled automatically in some cases.

MIDI Settings

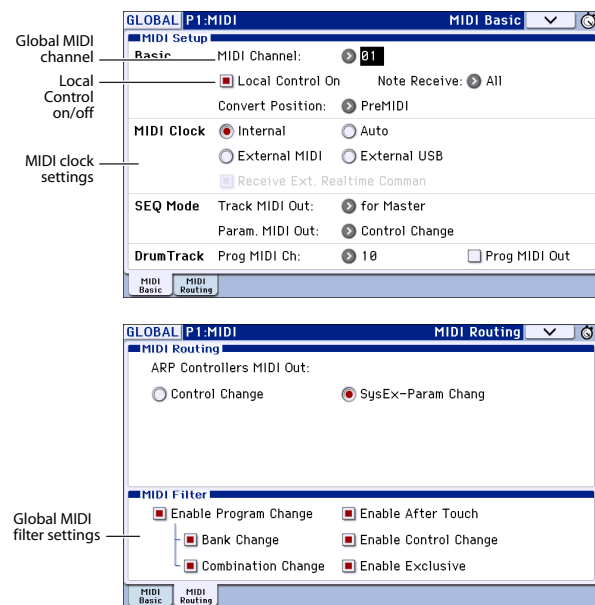

Global MIDI Channel

The Global MIDI Channel is the most important MIDI-related setting in the KROME. It determines the main MIDI channel used for both Program and Combination modes, for instance. To set the Global MIDI Channel:

1. Go to the Global P1: MIDI– MIDI Basic page.
2. In the MIDI Setup section, set the MIDI Channel as desired.

MIDI Clock synchronization

The KROME can use its own internal tempo, or synchronize to external clocks from either MIDI or USB.

The best general-purpose setting is **Auto**. This combine the functionality of **Internal** and **External MIDI/USB**, so that you don't have to manually switch between the two:

- If external clocks are being received, they control the KROME tempo.
- If external clocks are not being received, the KROME uses its internal tempo instead.

Synchronizing to a USB-connected computer

If you want to synchronize the KROME's tempo to a computer connected via USB:

1. Go to the Global P1: MIDI– MIDI Basic page.
2. In the MIDI Setup section, set the MIDI Clock to **Auto**.

Pedal and other controller settings

In the Global mode P2: Controllers– Foot Controllers page you can assign the functions of the assignable buttons and assignable pedals. (See “Connecting a damper pedal, foot switch, or foot pedal” on page 18.)

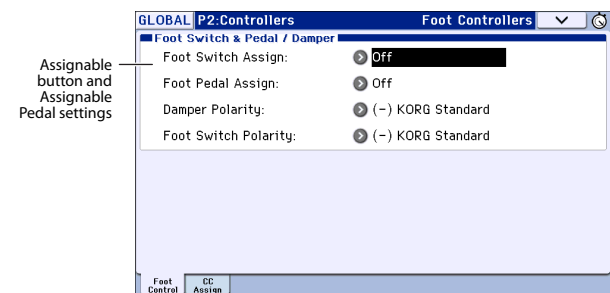

Creating user scales

The Global P3: Scales page lets you create your own original scales. You can create sixteen User Octave Scales which allow you to specify the pitch of each note in an octave (which will then be applied across all octaves), and you can create one User All Note Scale which allows you to individually specify the pitch for every one of the 128 notes.

By adjusting the pitch of each key in the range of ± 99 cents, you can raise or lower it by approximately one semitone relative to the normal pitch.

The user scales you create here can be used by specifying the scale for a program, for each timbre of a combination, or for each track of a song.

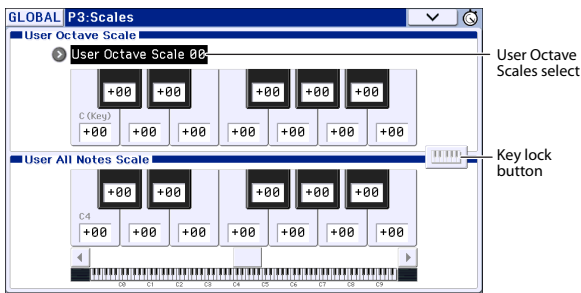

You can choose these scales from the following pages.

Mode	Page
Program	P1: Basic/Controllers– Note-On/Scale: Scale
Combination	P3: Timbre Parameters– Scale T01–08/ T09–16: Scale, Use Program’s Scale
Sequencer	P3: Track Parameters– Scale T01–08/T09–16: Scale, Use Program’s Scale

Here is how to set the scale type for each timbre in Sequencer mode.

1. Create a user octave scale or a user all notes scale.

Select a key, and use the VALUE controllers to adjust the pitch. The range of ± 99 raises or lowers the pitch approximately one semitone above or below the standard pitch.

Note: You can also select the key by holding down the ENTER button and playing a note on the keyboard. Alternatively, you can turn on the key lock button and then play a note on the keyboard.

Note: You can copy one of the preset scales and edit it to create an original scale. To do so, use the page menu command **Copy Scale**.

2. Access the Sequencer mode P3: Track Parameters– Other T01–08 or T09–16 page.

3. If you want the Track to use the scale saved with its individual Program, check the track’s “Use Program’s Scale” check box.

Tracks that are not checked will use the scale specified by Scale “Type (Song’s Scale).”

4. Set “Type (Song’s Scale)” to select the scale for the currently selected song.

Setting Category Names

In the Global P4: Category pages you can assign names to the categories and sub-categories of programs and combinations.

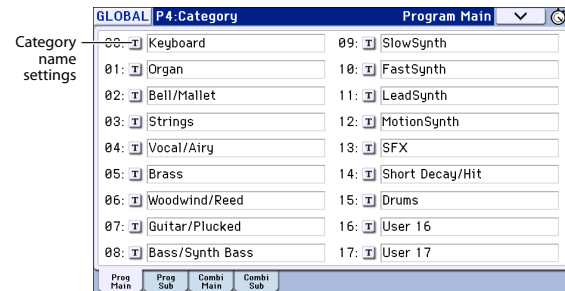

Editing the Category/sub category names is very simple:

1. Press the T (Text) button next to the name you’d like to edit.

The text editing dialog will appear.

2. Enter the new name, and press OK.

To edit a Sub Category name:

1. Choose the Main Category from the popup menu.

2. Edit the Sub-Category names as described above.

Loading & saving data

Saving data

Saving data on the KROME

You can save the KROME's various types of data in the following ways.

- Writing to internal memory
- Saving to an SD card (commercially available)
- MIDI data dump

Writing to internal memory

The following types of data can be written into the internal memory.

- **Program**
Programs 000–127 in banks A–F
 - **Combination**
Combinations 000–127 in banks A–D
 - **Global settings**
(Global P0: Basic Setup– P4: Category)
 - **User drum kits**
00(INT)–47(USER)
 - **User arpeggio patterns**
U0000(INT)–U1027(USER)
 - **User Drum Track patterns**
U000–U999
(See page 97)
 - **User template songs U00–U15**
Song settings such as the song name and tempo, track settings (see page 106 of the Parameter Guide), arpeggiator, and effect settings can be saved (written) to internal memory. However, the musical data for song tracks and patterns are not saved to internal memory. Furthermore, settings that govern how the musical data is played back such as **Meter**, **Metronome**, **PLAY/MUTE**, **Track Play Loop** (including Start/End measure), and RPPR settings will not be saved either. Use the Sequencer mode menu command **Save Template Song** to write this data; for details, please see page 164 of the Parameter Guide.
 - **Effect presets**
For each effect, you can write parameter settings into internal memory by using the menu command **Write FX Preset**.
-  The musical data and setup data of a song you create in Sequencer mode cannot be saved in the KROME's internal memory. You'll need to save this data to a commercially available SD card or by using MIDI data dump.

About preloaded data and preset data

“Preloaded data” refers to the data that is loaded in the KROME when it is shipped from the factory. You are free to rewrite this data, and with the exception of the demo songs, the data will be written to the location as described in “Writing to internal memory.” This data is stored in the KROME's system area.

You can reload the factory preload data into internal memory by using the Global mode menu command **Load Preload/Demo Data**.

Preset data, on the other hand, is data that cannot be overwritten by the Write operation. This includes the following data.

- GM program banks GM, g(1)–g(9), g(d)
- GM drum kits 48(GM)–56(GM)
- Preset template songs P00–P15
- Preset patterns P000–P605

Saving to SD card

The following data can be saved to an SD card (commercially available) inserted in the KROME's SD card slot.

- **.PCG file:**
Programs, Combinations, Drum kits, Global settings, user Drum Track patterns, and user arpeggio patterns (The data that was checked in the check boxes of the Save dialog box will be saved.)
- **.SNG file:**
Song and cue list.
- **.EXL file:**
System exclusive data from an external device that was saved on the KROME (This allows the KROME to be used as a data filer.)
- **.MID file:**
Saves a Sequencer mode song in Standard MIDI File (SMF) format.
(See the illustration on the following page.)

MIDI data dump

The KROME can transmit the following types of data as a MIDI data dump; you can save this data on an external data filer or other device.

- Programs, combinations, drum kits, and global settings
- Song and cue list
- User drum kit patterns
- User arpeggio pattern

For details, please see “Dump:” on page 218 of the Parameter Guide.

Supported file types

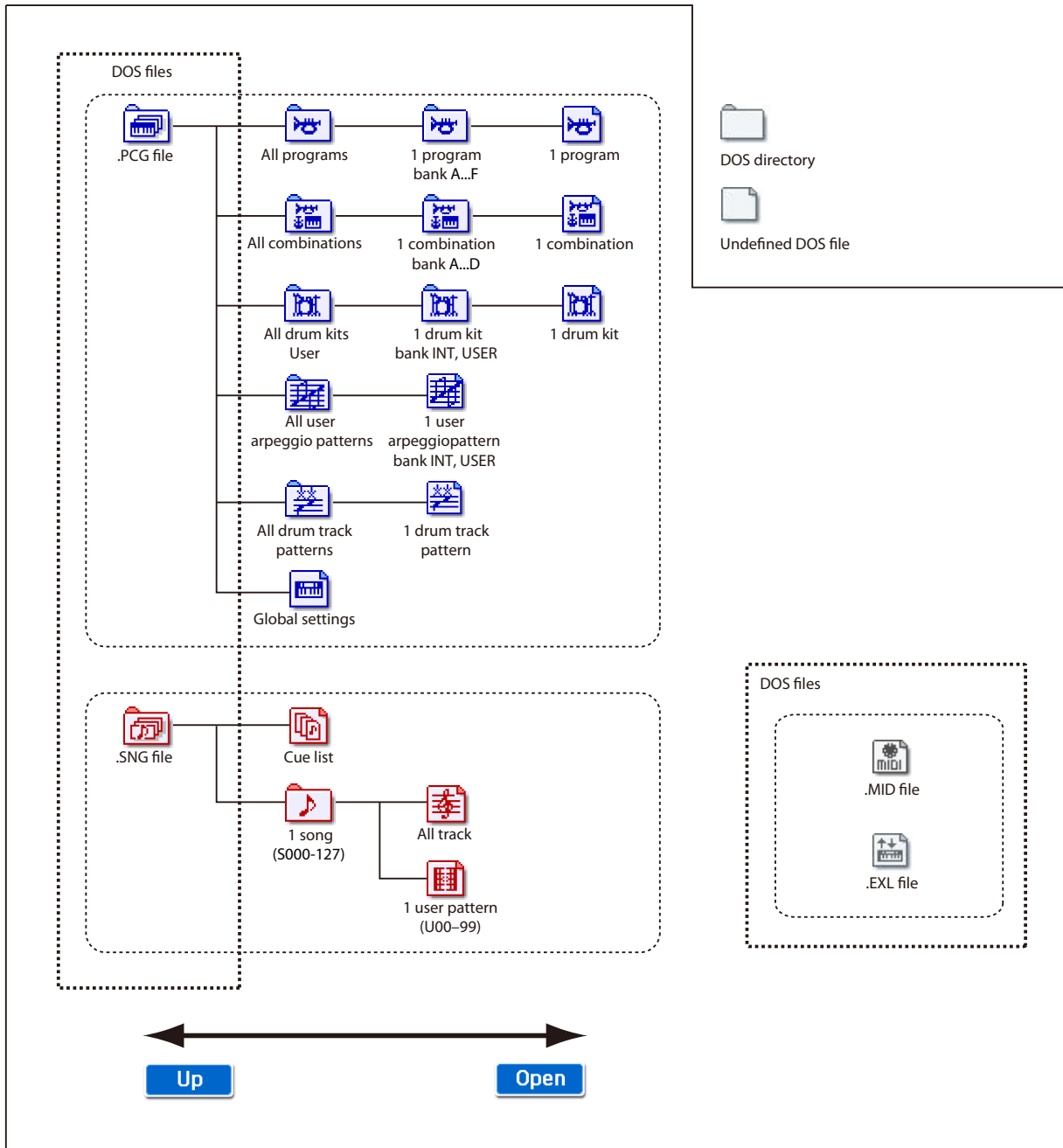

Writing to internal memory

Writing a Program or Combination

About the Program and Combination edit buffer

When you select a program in Prog P0: Play or a combination in Combi P0: Play, the program or combination data is called into the KROME's edit buffer.

When you then use the various Program or Combination pages to edit the parameters, your changes will affect the data in the edit buffer.

If you wish to save this modified data into internal memory, you must perform the Write operation.

When you perform the Write operation, the data in the edit buffer is written to the specified program or combination number of the specified bank.

If you select another program or combination without writing your edits, the data of the newly selected program or combination will overwrite the edited data in the edit buffer, and your changes will be lost.

Note: When you press the COMPARE button in Program mode, or Combination mode, the data from memory (i.e., the contents that were written into memory) will be temporarily called into the edit buffer. This allows you to compare the settings you are editing with the original un-edited settings.

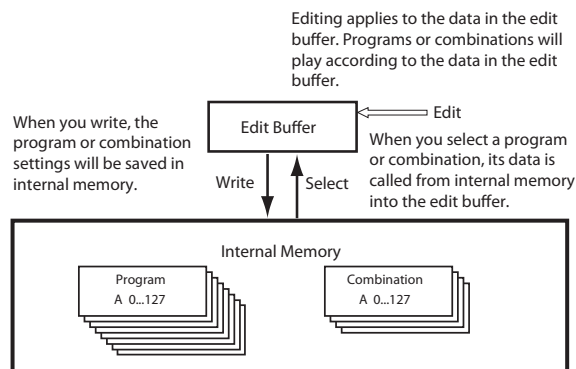

Writing (saving) procedure

The Program and Combination settings you've made in the various editing pages can be saved to internal memory. This action is referred to as "writing a program" or "writing a Combination." If you want your edited data to be preserved after the power is turned off, you must perform a Write operation.

There are two ways to write a Program or Combination.

- Use the WRITE button.
- Use the **Write Program** or **Write Combination** menu commands in the upper right of the display.

Before you can write data into memory, you must turn off the memory protect setting in Global mode.

For details, please see "Memory protect" on page 117.

A combination does not contain the actual program data for each timbre, but simply references the number of the program used by each timbre. If you edit a program that is used by a combination, or exchange it with a different program number, the sound of the combination will also change, reflecting the altered program.

1. Verify that the program or combination you want to save is selected.
2. Press the WRITE button.

Alternatively, press the page menu button in the upper right of the display, and select the menu command "Write Program" or "Write Combination."

The **Write Program** or **Write Combination** dialog box will appear.



This screenshot is for Program mode

3. Check the program/combination name displayed in the upper line (the writing source).
4. If you wish to change the name of the program/combination, press the text edit button.

The text dialog box will appear. Enter the name of the program/combination. For details, please see "Editing names" on page 117.

After you have entered the name, press the OK button to return to the Write Program/Write Combination dialog box.

5. In "Category," specify the category of the Program/Combination.
6. Select a "Sub Category" as well.

For combinations, the category and sub-category you specify here can be selected in the following pages.

Prog P0: Play
"Category"

Combi P0: Play– Program T01–08, 09–16
"Category"

Seq P0: Play/REC– Program T01–08, 09–16
"Category"

For Programs, the category/sub-category you specify here can be selected in the following pages.

Combi P0: Play– Program T01–08, 09–16
"Category"

7. Use "To" to specify the bank and number of the writing destination program/combination.

Use the VALUE controllers or the BANK buttons to make your selection.

8. To execute the Write operation, press the WRITE button.

Alternatively, press the OK button in the Write dialog box.

To cancel without executing press the Cancel button or EXIT button.

About the Tone Adjust settings that are saved

There are three types of Tone Adjust parameters, as listed below. The way in which settings are written will depend on the type.

- **Absolute:** This type of Tone Adjust parameter controls a single program parameter. The Program parameter and the Tone Adjust parameter reflect each other exactly. If you edit one, the other parameter will reflect the identical change. This type of Tone Adjust parameter “absolutely” controls the program parameter itself.
- **Relative:** This type of Tone Adjust parameter controls two or more program parameters simultaneously. For example, “Filter/Amp EG Attack Time” controls a total of six program parameters. The value of a relative parameter indicates the amount of change that is applied to the value of each program parameter it’s affecting. When a relative parameter is at zero (i.e., when its slider is in the center position), the program parameters it controls will function according to their original settings. Raising or lowering the value of a relative parameter will indirectly raise or lower the value of these program parameters.
- **Meta:** This type of Tone Adjust parameter affects other Tone Adjust parameters. It does not affect program parameters directly.

If you’ve adjusted an absolute or a relative Tone Adjust parameter, the result of your adjustment will be written as follows.

Program mode:

- The settings of relative-type Tone Adjust parameters are automatically applied directly to the program parameters when you write the program. The Tone Adjust values will be reset to zero.
- The settings of absolute-type Tone Adjust parameters are written “as themselves” (i.e., as the new settings of those Tone Adjust parameters).

Combination mode:

- The settings of both relative-type and absolute-type Tone Adjust parameters are written and preserved as the Tone Adjust settings for each timbre.

For details, please see pages 7, 75 of the Parameter Guide.

Writing Global settings, User Drum Kits and User Arpeggio Patterns

Memory in Global mode

When the power is turned on, the Global mode data is called from internal memory into the Global mode memory area. Then when you modify the parameters in Global mode, the data in the memory area will be modified. If you wish to save this modified data in internal memory, you must Write it.

When you write this data, the data in the memory area is written into internal memory.

If you turn off the power without writing, the modified data in the memory area will be lost.

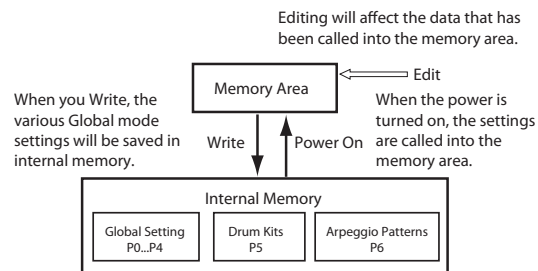

Writing (saving) procedure

The following three types of Global mode data can be saved by writing it into the KROME’s memory.

- Global settings (the settings in Global P0–P4)
- Drum kits (the settings in Global P5)
- Arpeggio patterns (the settings in Global P6)

Changes you make to this data will be remembered as long as the power remains on, but will be lost when you turn off the power. If you want to keep your changes even after turning the power off, you must write them into memory.

The following are exceptions.

Parameters that are not saved even if you Write

- Effect Global SW

Parameters that are saved even if you don’t Write

- Auto Power-Off

1. Access the page that contains the parameters or settings that you want to save.

Choose one of the P0–P4 pages if you want to write global settings, choose P5 if you want to write drum kits, or choose P6 if you want to write arpeggio patterns.

2. Press the WRITE button.

Alternatively, press the page menu button in the upper right of the display, and choose “Write Global Setting,” “Write Drum Kits,” or “Write Arpeggio Patterns.” The corresponding one of the following dialog boxes will appear.

Write Global Setting dialog box (P0–P4)



Write Drum Kits dialog box (P5)



Write Arpeggio Patterns dialog box (P6)



3. To execute the Write command, press the WRITE button.

Alternatively, press the OK button in the Write dialog box.

If you decide not to execute, press the EXIT button or the Cancel button.

Memory protect

To prevent Programs, Combinations, Songs, Drum Kits, and User Arpeggio Patterns from being overwritten accidentally, the KROME provides a Memory Protect setting that prohibits writing to memory.

Before you save edited data or load data from media, use the following procedure to turn the memory protect off (uncheck the appropriate check box).

You must also turn memory protect off before loading the above data from media or via a MIDI data dump, or before recording in Sequencer mode.

1. Press the GLOBAL button to enter Global mode.
2. Access the Global P0: Basic Setup– System Preferences page.

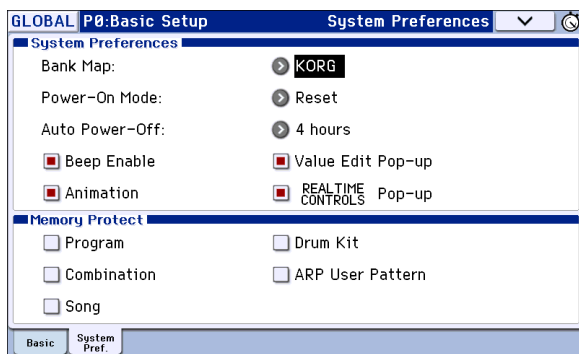

3. Press the “Memory Protect” check box for the type of data you wish to write to internal memory, so that the box is unchecked.

Editing names

You can modify the name of an edited program, combination, song, drum kit, or user arpeggio patterns etc.

You can also modify the category names for programs and combinations.

These renaming procedures can be performed in the following pages.

Item	Page
Program	Prog P0...9 menu command: Write Program
Combination	Combi P0...9 menu command: Write Combination
Song	Seq P0...5 menu command: Rename Song
Track	Seq P6: Track Name
Pattern	Seq P10: Pattern Name
Cue list	Seq P11: menu command: Rename Cue List
Program category/ sub category	Global P4: Program Category
Combination category/ sub category	Global P4: Combination Category
Drum Kit	Global P5 menu command: Rename Drum Kit
Arpeggio Pattern	Global P6 menu command: Rename Arpeggio Pattern
File	Media Save: Save All... Save Exclusive, Media Utility menu command: Rename, Create Directory, Format Seq P0–P11: Save Songs and Cue Lists Data
Effect preset	Prog, Combi, Seq P8, 9 menu command: Write FX Preset

1. In the pages listed above, or after selecting a menu command in these pages, press the text edit button **T** to access the text edit dialog box.

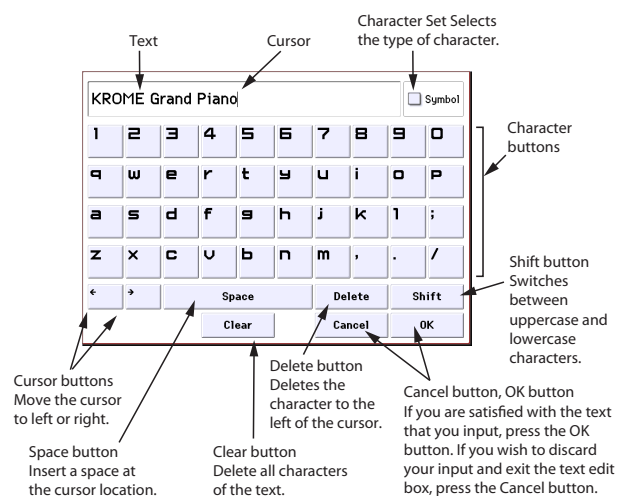

Saving to SD card (Media-Save)

For details on the data that can be saved on storage media. For details, please see “Saving data” on page 113.

- ⚠ The musical data of a song you create in Sequencer mode cannot be saved in the KROME’s internal memory. You must save this data on a commercially available SD card, or save it using MIDI data dump. When you’ve come up with settings you like, it’s a good idea to save them, so that even if you subsequently edit those settings, you’ll always be able to reload the previous settings if desired.

Types of SD card you can use

SD card specifications

SD memory cards up to 2GB and SDHC memory cards up to 32GB are supported.

SDXC memory cards are not supported.

MS-DOS format FAT16 or FAT32 are supported.

- ⚠ Media is not included. You will need to purchase it separately.

Inserting/removing a card in the SD card slot

If you’ve placed an SD card in the SD card slot, you can use it to save or load various types of Program, Combination, and Song data.

About the write protect setting of an SD card

SD cards have a write protect switch that prevents the data from being overwritten accidentally and lost. If you set the card’s Lock (write protect) switch to the “protected” setting, it will be impossible to write or erase data on the card, or to format it. If you need to save edited data on the card, move the switch back to its original “unprotected” setting.

Inserting a card

- Insert an SD card in the SD card slot.

With the card label facing upward, insert the connector end of the card into the SD card slot and press it in until you hear a click.

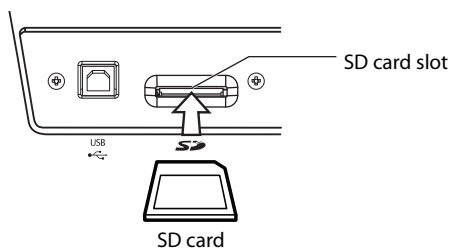

- ⚠ Make sure that the card is oriented correctly when you insert it. Forcing it in the wrong direction may damage the slot or the card, and the data may be lost.

Removing a card

- ⚠ Never remove an SD card from the slot while loading, saving, or formatting is in progress.

- Remove the card from the SD card slot.

Press the card inward; you will hear a click, and the card will pop out part-way, allowing you to pull it completely out.

Refer to the owner’s manual included with your card, and observe the guidelines for handling and use.

Formatting media

Some consumer electronics products that use SD cards utilize their own proprietary format. Before using an SD card with the KROME, you must format it on the KROME (see page 123).

How to save data

As an example here, we’ll execute **Save All** to save the .PCG and .SNG files.

“Save All” saves all internal memory Programs, Combinations, Global settings, Drum Kits, User Arpeggio Patterns, and Drum Track User Patterns to media as a .PCG file. It also saves songs and cue lists as a .SNG file.

This method is available only if the current directory is a DOS directory.

- ⚠ If you save this data to low-capacity media, you may need more than one media.

1. **Prepare the media on which you want to save the data.**
2. **Press the MEDIA button to enter Media mode.**
3. **Access the Media-Save page. Press the Save tab.**
4. **If the media contains directories, select the directory in which you want to save the data.**

Press the Open button to move to a lower level, or press the Up button to move to an upper level.

Note: If you are saving data on high-capacity media, we recommend that you create directories to organize the media into sections.

To create a new directory, move to the level at which you want to create the directory, and execute the Utility menu command **Create Directory**.

5. **Press the menu button to access the menu, and press Save All.**

A dialog box will appear. The contents, settings, and operations for the dialog box will depend on the type of data that you are saving.

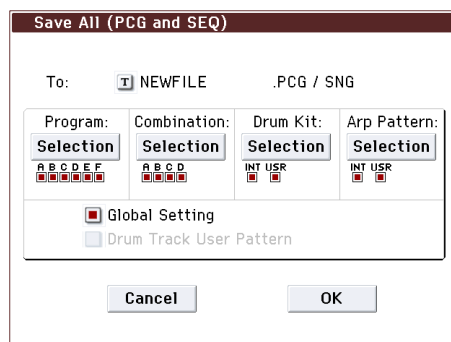

6. Press the text edit button and input a filename for the file you want to save. (See page 117.)
7. Press each Selection button to access the dialog box, and use the check boxes to uncheck any items that you do not need to save.

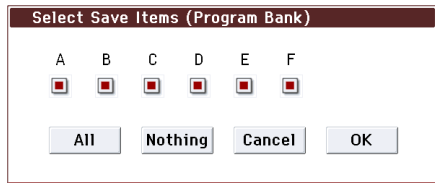

In order to accurately reproduce the data you created, we recommend that you check all of the boxes.

When you've finished making settings, press the OK button to close the dialog box.

8. Press the OK button to execute the Save operation.

- If the data fits on one volume of media
The data will be saved on the specified media, and you will return to the Save page.
- If the data does not fit on one volume of media
The "No space available on media" dialog box will appear.



Press the OK button and the file will be divided and saved to multiple volumes of media. If you don't want to divide the file, press the Cancel button, and re-save it to larger-capacity media.

For details, please see "If the data being saved does not fit on one volume of media" on page 231 of the Parameter Guide.

9. When saving ends and you return to the Save page, the display will show the file that was saved.

The various types of data are saved as the following files.

- .PCG file
- .SNG file

Cautions when saving

If an identically named file exists on the media

If a file with the same name already exists on the media, you will be asked whether you want to overwrite. If you wish to overwrite, press the OK button. If you want to save without overwriting, press the Cancel button and rename the file before you save it. For details, please see "Editing names" on page 117.

Please note when saving

- When using **Save All (PCG & SNG)**, and **Save PCG** to save combinations, you should also remember to save the programs used by each timbre (or the drum kits, and user arpeggio patterns used by the programs) at the same time. Similarly when saving programs, you should also remember to save the drum kits, user drum track patterns and user arpeggio patterns used by the programs.

Time required when saving data

- The length of time required will depend on the amount of data being saved.

Using the KROME as a data filer

The KROME can receive MIDI System Exclusive data sent by an external device, and save this data to media. (This is sometimes referred to as the "Data Filer" function.) For details, please see "Save Exclusive" on page 232 of the Parameter Guide.

Loading data

Data that can be loaded

Loading from media

You can load the following data from media.

- **.PCG file:**
Programs, Combinations, Drum Kits, Global settings, User Arpeggio Patterns, and User Drum Track patterns
- **.SNG file:**
Song and cue list.
- **.MID file:**
Standard MIDI file (SMF) format
- **.EXL file:**
MIDI exclusive data

Loading the preloaded data and demo songs to restore the factory settings

You can load the factory settings and demo songs back into the KROME's internal memory. For the procedure, please see "Loading the preloaded data" on page 125.

- **Preload data:**
Programs, Combinations, Drum Kits, Global settings, User Arpeggio Patterns
- **Demo song data**

Loading data from SD card (Media-Load)

Loading all Programs, Combinations, Drum Kits and Arpeggio patterns

Here we'll explain how to load all data from a .PCG file containing Programs, Combinations, Drum kits, Global settings, User Arpeggio patterns, and Drum Track patterns in a single operation.

- ⚠ When loading Programs, Combinations, Songs, or Drum Kits, you must make sure that the Global mode memory protect setting is unchecked. For details, please see "Memory protect" on page 117.

Note: Please see page 117 for details on the SD card from which you can load data.

1. **Make sure that the media is ready for you to load data. For details, please see "Inserting/removing a card in the SD card slot" on page 118.**
2. **Access the Media- Load page. Press the Load tab.**
3. **Press the .PCG file containing the program and combination data you want to load, so that the file is highlighted.**
 - If there are directories, press the Open button to move to a lower level, or press the Up button to move back to the higher level.



4. **Press the Load button. Alternatively, choose the menu command "Load Selected."**

A dialog box will appear.

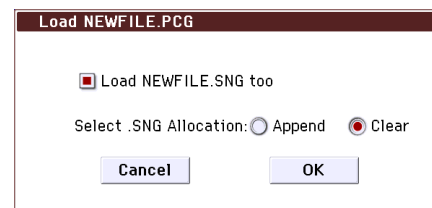

5. **If you want to load song data at the same time, select the "Load *****.SNG too" box. When you execute the load operation, the .SNG file will be loaded together with the .PCG file.**

Use "Select .SNG Allocation" to specify the destination to which the song data will be loaded.

“Append” will load the song into the song number that follows the song(s) currently existing in internal memory, without leaving a vacant number.

“Clear” will erase all songs from internal memory, and load the songs into the numbers from which they were saved.

6. Press the OK button. All data from the .PCG file will be loaded into the KROME.

 Never remove the media while data is being loaded.

Note: You can load individual banks of programs or combinations. For details, please see page 228 and following of the Parameter Guide.

Loading individual data from a .PCG file

The KROME lets you load Programs, Combinations, Drum kits, user Drum Kit patterns, User Arpeggio patterns individually or by individual banks. This is a convenient way to rearrange Combinations in the order in which you will use them during a live performance.

 Be aware that if you change the order of Programs, the sounds played by Combinations may also be affected.

As an example here, we will explain how a combination saved in bank A can be loaded into D000.

1. Move to the “Bank A” directory, and select the Combination that you want to load. (.PCG file/Combinations/Bank A/)

The procedure is as follows:

- Perform steps 1–3 under “Loading all Programs, Combinations, Drum Kits and Arpeggio patterns” on page 120. Select the .PCG file containing the data you want to load (it will be highlighted), and press the Open button.
- Press “Combinations” to highlight it, and press the Open button.
- Press “Bank A” to highlight it, and press the Open button.
- Press the scroll bar to find the Combination you want to load, and highlight it.

Alternatively, you could select any file, since the desired file can be selected later from the dialog box.

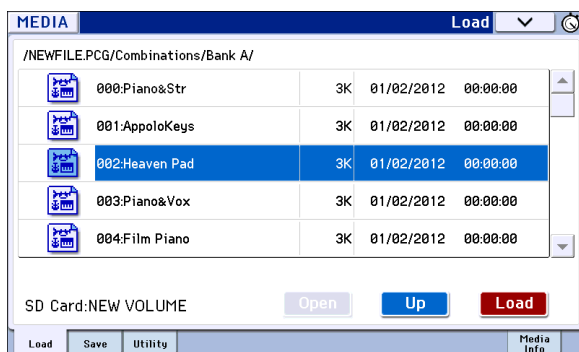

Note: When you press the keyboard of the KROME, you will hear the combination you have selected. However, the internal programs will be used as the program of each timbre.

2. Press the Load button. Alternatively, choose the menu command “Load Selected.”

A dialog box will appear.

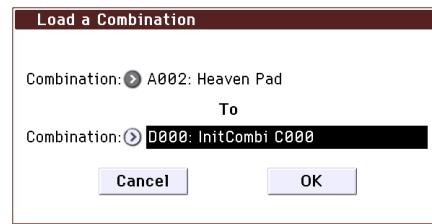

3. Use the “Combination” (upper line) to select the load-source combination, and use “(To) Combination” (lower line) to specify the destination combination. For this example, select D000.

You can press the popup button and select from a menu, or use the BANK buttons and numeric keys to make a selection.

4. Press the OK button to execute loading; the loaded combination will be assigned to D000.

Loading songs for use in Sequencer mode (.SNG)

As an example here, we will explain how to load a song. We’ll assume that this song uses edited programs, multisamples you sampled and programs that use drumkit and user arpeggio patterns etc. In such cases, it is best to load “all data.”

1. Perform steps 1–3 under “Loading all Programs, Combinations, Drum Kits and Arpeggio patterns” on page 120. Select the .SNG file containing the data you want to load (it will be highlighted).
2. Press the Load button. Alternatively, choose the menu command Load Selected.

A dialog box will appear.

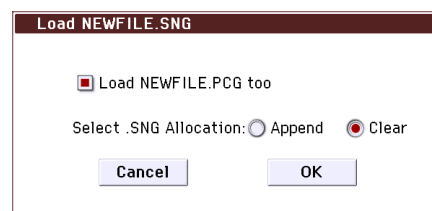

Note: The contents and settings of the dialog box will differ depending on the type of file that you are loading.

3. Check the “Load ***.PCG too” check box.**

When you execute loading, the .PCG file will be loaded along with the .SNG file.

Use “Select .SNG Allocation” to specify the destination to which the song data will be loaded.

“Append” will load the song into the song number that follows the song(s) currently existing in internal memory, without leaving a vacant number.

“Clear” will erase all songs from internal memory, and load the songs into the numbers from which they were saved.

4. Press the OK button to execute loading.

-  Never remove the media while data is being loaded.

Loading KROME system update data

You can update the KROME's system by downloading the most recent version of the system file from the Korg website (<http://www.korg.com>) to your computer, and loading it into the KROME. For details on the procedure, please see the Korg website and to "Update System Software" on page 218 of the Parameter Guide.

Use the Global mode menu command **Update System Software** to load the system update data.

Media utility

Formatting media

Newly purchased media or media that has been used by another device cannot be used “as is;” you must format the media before you can use it with the KROME.

- ⚠ When you format media, all data that had been saved on that media will be erased. Be sure to double-check media for data before you format.
- ⚠ After formatting, it is not possible to press the COMPARE button to return to the previous state.

1. Make sure that the media you want to format is inserted. For details, please see “Inserting/removing a card in the SD card slot” on page 118.
2. Access the Media– Utility page. Press the Utility tab.
3. Press the menu button to access the menu, and press “Format” to open the dialog box.

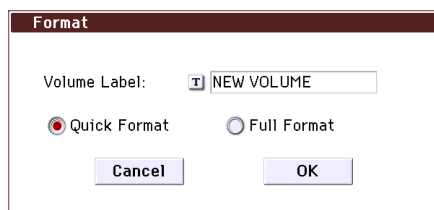

4. In “Volume Label,” use the text edit button to access the text edit dialog box, and specify the volume label.

The previously-specified volume label will be displayed. If no volume label had been specified for the media, or if a non-DOS media was inserted, this will indicate “NEW VOLUME.”

5. Specify the initialization format.

Quick Format: This erases the file information on the SD card, allowing the card to be formatted quickly. Normally you’ll use this method of formatting.

Full Format: All blocks on the media will be erased. Normally, there is no need to apply a Full Format; you should simply execute Quick Format.

6. Press the OK button to format, or press the Cancel button if you decide to cancel.

When you press the OK button, a message will ask you for confirmation. Press the OK button once again to execute the Format operation.

- ⚠ You must use the KROME to format the media. The KROME will not correctly recognize media that has been formatted by another device.

Setting the current time

Specify the date and time; this is used to record the correct date and time when you save data. You can set the date and time by using the Media Utility page’s Set Date/Time menu command.

- ⚠ The KROME does not contain an internal calendar or clock, you must use the Utility menu command Set Date/Time to set the date and time before saving the file.

1. Press the MEDIA button to enter Media mode.
2. Access the Media– Utility page. Press the Utility tab.
3. Open the menu, and select the Set Date/Time command.

The following dialog box will appear.

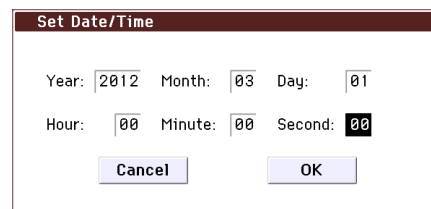

4. Use the VALUE controllers to set the correct year, month, day, hour, minute, and second.
5. Press the OK button.

Appendices

Restoring the factory settings

Loading the preloaded data

The original preload data is backed up in the KROME, so you can restore any or all of the Programs, Combinations, Drum Kits, User Arpeggio Patterns, and Global settings to their original factory settings.

Note: The original demo songs can be re-loaded at any time. For details, please see “About the data loaded by All (Preload PCG and Demo Songs)”.

User banks and user patterns into which preload data has not been loaded will remain unchanged. If you want to erase user banks or user patterns, initialize the KROME and then load the preload data. For more details, please see “Initialization” on page 125.

- ⚠ Never turn off the power while the data is being loaded.
- ⚠ Before you load the preload data, go to the Global mode P0: Basic Setup– System Preferences page, and uncheck the “Memory Protect” settings for the data that you want to load. If you execute this procedure with these settings checked, the data will not be loaded.
- ⚠ Loading the preloaded data will overwrite the contents of the internal memory. If you want to keep the existing data that is stored in internal memory, use “Save All (PCG&SNG)” or “Save PCG” to save your data to external media before you continue.

1. Access the Global mode P0: Basic Setup– Basic page.

Enter Global mode by pressing the GLOBAL button or by using the mode button.

If the Global P0: Basic Setup– Basic page is not shown, press the EXIT button.

2. Press the menu button, and choose “Load Preload/ Demo Data.”

A dialog box will appear.

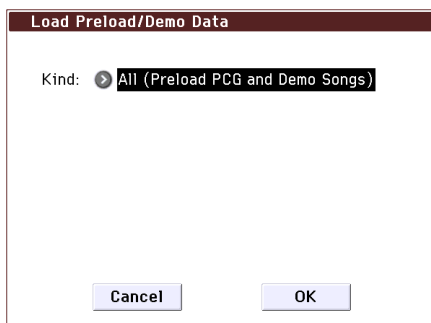

3. In the “Kind” field, select All (Preload PCG and Demo Songs).
4. Press the OK button to load the preload data. If you decide not to load the preload data, press the Cancel button.

When you press the OK button, a dialog box will ask you for confirmation. Press the OK button to execute loading.

Note: When the dialog box is displayed, the ENTER button performs the same function as the OK button.

About the data loaded by All (Preload PCG and Demo Songs)

When you execute All Preload PCG, the following data will be loaded:

- Program: Bank A, B, C, D, E
- Combination: Bank A, B, C
- Drum Kit: 00(INT)–31(INT)
- User Arpeggio Pattern: U0000(INT)–U899(INT)
- Global Setting

If you execute All (Preload PCG and Demo Songs), the demo songs will be loaded as well as the above data.

- Demo Song: S000–003
Only when executing All (Preload PCG and Demo Song)

Note: As with the other user songs, the Demo Song data will not remain in Sequencer mode when you turn off the power. You’ll need to load it again if necessary.

Initialization

If your KROME should become unstable, you can initialize it.

- Turn off the power, and then, while holding down the EXIT button and PAGE button, turn the power on.

The KROME will be initialized. While the data is being loaded, the display will indicate “Now writing into internal memory.”

The resulting state will be the same as when **Load Preload/Demo Data All** is executed (see page 125).

Troubleshooting

If you experience problems, please see the relevant item and take the appropriate measures.

Power supply

Power does not turn on

Is the AC adapter connected to an outlet? → p.15

Power turns off

Could the Auto Power-Off function be enabled? → p.16

Display

The power is turned on, but nothing is shown on the display. The KROME functions normally when you play the keyboard or perform other procedures.

Access the Global mode menu “Display Setup” (Global P0: Basic Setup), and use “Brightness” to adjust the contrast of the display. → PG p.216

The power is turned on, but the display does not work normally, or an error message is displayed. There is no sound when you play the keyboard, and the KROME does not function normally.

This type of problem may occur if a data writing operation to internal memory was not completed correctly, for example, if the power of the KROME was turned off while a program or other data was being written. If this occurs, use the following procedure to initialize the KROME’s internal memory.

1. Turn off the power.
2. Initialize the KROME. While holding down the EXIT button and the PAGE button located beside it, turn on the power of the KROME.

The KROME will be initialized, and data will be written into internal memory. While the data is being written, the display will indicate “Now writing into internal memory.”

After initialization, all user data will be empty, and you will need to re-load the preload data. Execute the Global mode menu command **Load Preload/ Demo Data** to load the data. → p.125

Operations in the display don’t work, the position has drifted, the response is poor

On the Global P0: Basic Setup page, use the **Touch Panel Calibration** menu command to adjust the touch panel response. → PG p.217

In order to perform the calibration optimally, use a stylus pen to accurately press the center of the symbol (calibration target) that appears in the corner of the display.

Note: If you are unable to select commands from the menu, do the following:

1. Press the GLOBAL button (lit).
2. Press the EXIT button several times.
3. Hold down the ENTER button and press 4 on the numeric keypad.

The Touch Panel Calibration page will appear. Follow the on-screen instructions to re-calibrate the touch panel.

Can’t switch modes or pages

If you’re doing any of the following, you may not be able to change modes or switch to a different page:

- Recording or playing back a song or pattern. Alternatively, could the KROME be in the paused PAUSE (||) or record-ready condition?

Could something be pressing the TouchView display?

Could a realtime control popup or similar message be displayed?

- Disabling “Animation,” “Value Edit Pop-up,” “REALTIME CONTROLS Pop-up” (Global P0: Basic Setup– System Preferences) will improve the response time and performance.

In Combination, or Sequencer modes, you can’t edit the value of Timbre/Track parameters such as MIDI Channel or Status

Some parameters can’t be edited while notes are playing, either locally or from MIDI. If the damper pedal is held down, or if its calibration is incorrect, notes may be sustaining even if they aren’t audible.

- Are you using a damper pedal with a polarity that does not match the **Damper Polarity** setting (Global P2: Controllers– Foot Controllers)? → p.18
- In some cases, this problem can be solved by executing the menu command **Half Damper Calibration** (Global P0: Basic Setup). → PG p.217

No beep sounds when you touch the display

Check the **Beep Enable** check box (Global P0: Basic Setup– System Preferences). → p.110

Audio output

No sound

Are connections made correctly to your amp, mixer, or headphones? → p.17

Is the connected amp or mixer powered-on, and is its volume raised?

Is Local Control turned on?

- In Global P1: MIDI, check the **Local Control On** check box. → PG p.198

Could the VOLUME knob be turned all the way to the left? → p.1

Is the Master Volume assigned to **Foot Pedal Assign**, and is that pedal volume lowered? → p.19

Could the program be muted? → p.27

If a specific timbre doesn’t sound in Combination mode, is its Play/Mute button set to Play?

Alternatively, are all Solo button settings turned off?
→ p.46

If a specific track doesn't sound in Sequencer mode, is its Play/Rec/Mute button set to Play? Alternatively, are all Solo button settings turned off? → p.55

Make sure that the **Status** is INT or BTH. → p.50, p.57

Are the Key Zone and Velocity Zone set so that sound will be produced when you play? → PG p.14, p.84, p.129

Is the Oscillator, Drum Track, Timbre, or Track level lowered in the control surface mixer? → p.27, p.46, p.55

Could the level of the **Master Volume** following the total effect have been lowered? → PG p.62, p.99, p.152

Could the total polyphony be exceeding the maximum polyphony of 120 voices? → p.32

Notes do not stop

In Prog P1: Basic/Controllers– Note-On/Scale, select the Program Basic page, make sure that the **Hold** check box is unchecked. → PG p.14

Did you use Tone Adjust to turn **Hold** on? → PG p.10

In Global P2: Controller, make sure that **Damper Polarity** or **Foot Switch Polarity** is set correctly. → PG p.202

If the DRUM TRACK or ARP buttons are turned on, try turning them off.

Notes are sounded in duplicate

Is Local Control turned Off?

- Clear the **Local Control On** checkbox (Global P1: MIDI). → PG p.198

Noise or oscillation is heard

When using the MIDI/Tempo Sync function to control the delay time of an effect, noise may occur in the delay sound. This noise is due to discontinuities in the delay sound, and is not a malfunction.

Some effects, such as 019: Stereo Analog Record, generate noise intentionally. It is also possible to create oscillation using a filter with resonance. These are not malfunctions.

Note that if you use the following effects with the routing described below, a feedback loop will be created, possibly producing a loud noise. Please use caution.

If the signal from an oscillator or timbre/track output, or the signal after an insert effect, is sent to the FX Control bus and that signal is output directly, with this output sent to the FX Control bus, a loud noise may be output. (It is also possible that a DC component will be output at the maximum level, producing silence.)

- When using the 003: Stereo Limiter or 006: Stereo Gate, and the **Envelope Source** of these effects is set as either FX Control 1 or FX Control 2, and **Trigger Monitor** is On.
- When using 174: Vocoder, with the **Modulator Source** set to FX Control 1 or FX Control 2, and the **Modulator High Mix** set to other than 0.

Can't play chords

Could the program's **Voice Assign Mode** be set to Mono? → p.33

Pitch is incorrect

- In the Global P0: Basic Setup page, are the **Master Tune** and **Transpose** settings correct? → p.109
- In the Prog P2: OSC/Pitch page, is the **Pitch Slope** set to +1.0? → PG p.20
- In the combination or song, are the **Transpose** and **Detune** settings of each timbre/track set appropriately? → PG p.82, p.127
- In the timbre/track settings of each program, combination, or song, could you have selected a non-standard scale type other than Equal Temperament? → PG p.15, p.83, p.128

Programs and Combinations

Settings for oscillator 2 are not displayed

Make sure that the **Oscillator Mode** (Prog P1: Basic/Controllers) parameter is set to Double or Double Drums. → p.32

Program does not sound

Could the oscillator or amp level be lowered?
→ PG p.5, p.6, p.35

Could the program be muted?

- Use the Play/Mute button in the Prog P0: Play–Mixer & Drum Track page to mute/unmute a program, or in the Combi P0: Play– Program T01–08 and T09–16 pages to mute/unmute a combination.

A combination does not play correctly after you load data

In the dialog box when you saved the data, did you check the items that you wanted to save? → PG p.231

Are the bank/numbers of the programs used by the combination the same as when the combination was created?

- If you have switched program banks, you can use the Global mode **Change all bank references** menu command to change the program bank for each timbre of a combination. → PG p.216

Can't write a Program

Is the Memory Protect **Program** or **Combination** checkbox (Global P0) cleared? → p.110, and PG p.197

Songs

Song does not play correctly after being loaded

In the dialog box when you saved the data, did you check all of the items that you wanted to save?

→ PG p.231

Are the programs used by the song the same as when the song was created?

- If you have switched program banks, you can use the Global mode **Change all bank references** menu command to change the program bank for each track of a song. → PG p.216
- When saving the song, it is best to use **Save All (PCG&SNG)** so that the programs are saved together with the song. Then when loading, load both the .PCG and the .SEQ data. → PG p.231

Playback does not start when you press the SEQUENCER START/STOP (▶ / ■) button in Sequencer mode

Is the **MIDI Clock** (Global P1: MIDI) set to Internal or Auto? → PG p.199

Can't record in Sequencer mode

Did you use **Track Select** to select the MIDI track that you want to record? → p.60

Is the Memory Protect **Song** check box (Global P0) unchecked? → p.110, and PG p.197

Is the **MIDI Clock** (Global P1: MIDI) set to Internal or Auto? → PG p.199

A combination copied using "Copy From Combi" doesn't record via arpeggiator as it did when you were playing it in Combination mode

Is **Multi REC** (Seq P0: Play/REC) checked? → p.60, and PG p.118

Are the settings in the Copy from Combination dialog box correct? → PG p.166

- In the Copy from Combination dialog box, check the **Auto adjust Arp setting for Multi REC** option before you execute the copy. This will cause the settings to be adjusted automatically.

Can't record Tone Adjust data

Changes you make using Tone Adjust are recorded as system exclusive data. Did you check the Global mode MIDI Filter **Enable Exclusive** check box? → PG p.201

RPPR does not start

Is the Seq P0: Play/REC **RPPR** setting checked? → p.72

Are **Assign**, **Pattern Select**, and **Track** set correctly? → p.71

Is the **MIDI Clock** (Global P1: MIDI) parameter set to Internal or Auto? → PG p.199

SMF you loaded in Media mode won't play correctly

Execute the menu command **GM Initialize** to restore the settings. → PG p.165

Set **Bank Map** to GM(2) and load the data again. → PG p.196

Arpeggiator

The Arpeggiator does not start

Is the ARP button turned on (lit)? → p.85

If the arpeggiator does not start for a combination or song, make sure that **Arpeggiator Run** is checked, and that an arpeggiator is selected for **Assign**. → p.88, and PG p.74, p.92, p.114

If the arpeggiator does not run in the Global P6: Arpeggio Pattern page, could you have navigated there from Combination or Sequencer mode with settings that do not start the arpeggiator?

Is the **MIDI Clock** (Global P1: MIDI) parameter set to Internal? → PG p.199

In the Global P0: Basic Setup page, is **All ARP/DT Off** checked? → PG p.195

Drum Track function

The Drum Track does not start

Is the DRUM TRACK button turned on (lit)? → p.97

You pressed the DRUM TRACK button but the drum track pattern did not start.

- Is the DRUM TRACK button blinking? **Trigger Mode** is set to Wait KBD Trigger. The drum track pattern will start when you play the keyboard or receive a note-on. → PG p.56
- Did you select a pattern that does not contain data?
- Could P000: Off be selected as the pattern? → PG p.55

If the drum track pattern fails to start in Combination mode, is the **Output** setting appropriate?

If the drum track pattern fails to start in Sequencer mode, are the **Input** and **Output** settings appropriate? → p.99, and PG p.146

Is **MIDI Clock** (Global P1: MIDI) set to Internal or Auto? → PG p.199

In the Global P0: Basic Setup page, is **All ARP/DT Off** checked? → PG p.195

Drum Kits

The drumsample's pitch does not change

You have left the **Assign** check box unchecked, and want to play the drumsample at the adjacent right a semitone lower, but the pitch does not change.

- If you have selected a drum program in Program mode, and then want to edit the drum kit in Global mode, go to the Prog P2: OSC/Pitch- OSC1 Pitch page and set **Pitch Slope** to +1.0 before you enter Global mode. → PG p.20

Can't edit the drum kit for Double Drums OSC2

- Access the P2: OSC/Pitch- OSC2 Setup page, and move to Global mode by pressing the Jump to Drum Kit Edit button.

Effects

Effects are not audible

Have you selected effect program 000 (No Effect)?

- Select an effect other than 000: No Effect for “IFX1–5,” “MFX 1, 2” or “TFX.”

Are the Effect Global SW **IFX 1–5**, **MFX1&2**, or **TFX** (Global P0: Basic Setup page) settings checked?
→ PG p.195

If you are in Combination and Sequencer mode, and master effects are not audible when you raise the **Send1** or **Send2** of the timbre/track, does **Return 1** or **Return 2** from the master effect need to be raised?
→ PG p.61, p.99, p.152

Alternatively, has **Send 1** or **Send 2** for each oscillator of the program used by the timbre/track been lowered?
→ PG p.96, p.148

Note: The actual send level is determined by multiplying the send setting of each oscillator in the program with the send setting of the timbre/track.

Have you routed the output to an insert effect?
→ PG p.57, p.58, p.96, p.98, p.148, p.149

MIDI

The KROME does not respond to incoming MIDI data

Are all MIDI cables or USB cables connected correctly?
→ p.20

Are the KROME’s receive settings (such as the global MIDI channel and the timbre/track’s receive channel) set to match the channels of the transmitting device?
→ PG p.360

The KROME does not respond correctly to incoming MIDI data

Are the Global P1: MIDI settings **MIDI Filter Enable**, **Program Change**, **Enable Bank Change**, **Enable Control Change**, **Enable AfterTouch**, and **Enable Exclusive** each checked? → PG p.200

Does the KROME support the types of messages that are being sent to it? → PG p.360

Can’t recall programs of the desired bank

Is the **Bank Map** setting correct? → PG p.196

Damper pedal

Damper response is wrong

Execute the menu command **Half Damper Calibration** (Global P0: Basic Setup) to correctly calibrate the half-damper pedal sensitivity. → PG p.217

Media

Can’t format the SD card

Does the media meet the requirements for use on the KROME? → p.118

Is the media inserted correctly? → p.118

Could the media’s Lock (write protect) switch be on?

Can’t save/load data on the SD card

Is the media inserted correctly? → p.118

Has the media been formatted? → p.123

Could the media’s Lock (write protect) switch be on?

The date of the data is wrong

The files you saved have the incorrect date.

- The KROME does not contain an internal calendar. Use the menu command **Set Date/Time** (Media–Utility page) to specify the current time and date before you save the data. → p.123

Connections with a computer

The KROME does not respond to MIDI data sent from outside

Is the USB cable connected correctly? → p.20

The computer does not detect the KROME

Are the USB cables connected correctly?

An error occurs when you disconnect from the computer

Never disconnect the KROME from the computer while your host application is in use.

While connected, you are asked to install software or a device driver

Does the operating system or version of your computer support the KROME?

When using USB, sound processing is slow, or the tempo is unstable

Is the KORG USB-MIDI driver installed correctly?

- You must install the dedicated Korg driver in order to use the KROME via USB MIDI.

If your computer’s operating system is Windows, you’ll need to install the driver for each USB port where you connect the KROME.

If you connect the KROME to a different USB port than the one you used when installing the KORG USB-MIDI Driver for Windows, you’ll need to reinstall the KORG USB MIDI driver.

Error messages

Error and confirmation messages

A

Are you sure ?

Meaning: This message asks you to confirm execution. To execute press the OK button. To cancel, press the Cancel button.

C

Can't calibrate

Meaning: Calibration could not be performed correctly.

- Try again.

Can't copy/swap double size effect

Meaning: When copying or swapping an insertion effect or master effect, you attempted to place a double-size effect in IFX5 and MFX2.

- Modify your settings so that a double-size effect is not moved to IFX5 or MFX2, and execute again.

Can't open pattern

Continue?

Meaning: When you finished recording, there was not enough memory to open the pattern that was put into the track (When it must be opened automatically). If you press the OK button, the pattern data will be deleted, and the recorded or edited content will be saved. If you press the Cancel button, the recorded content will be discarded.

Completed

Meaning: The processing executed by the command has been completed.

Completed. Please turn the power off, and then on again

Meaning: Execution of Update System Software has been completed successfully. Turn the power switch off, and then on again to complete the update.

D

Destination and source are identical

Meaning: When copying or bouncing, the same song, track or pattern was selected for both the source and destination. To solve this problem:

- Select a different song, track, or pattern for the source and destination.

Destination from-measure within the limits of source

Meaning: When executing the Move Measure command for all tracks or within the same track, the specified destination measure is within the source range. To solve this problem:

- Set a destination measure that is outside of the source range.

Destination is empty

Meaning: When editing, the track or pattern that was specified as the destination contains no musical data. To solve this problem:

- Select a track or pattern that contains musical data.

Destination measure is empty

Meaning: The measure that was specified as the destination contains no data.

- Specify a destination measure that contains data.

Destination song is empty

Meaning: The song that was specified as the copy destination or bounce destination does not exist.

- Execute the Create New Song command in the dialog box that appears when a new song is selected before copying or bouncing. (See page 57)

Directory is not empty

Cleanup directory Are you sure?

Meaning: When deleting a directory, files or directories exist within that directory.

- Press the OK button to delete all files and/or directories within that directory.

E

Error in formatting media

Meaning: An error occurred while performing a physical format (full format) or high-level format (quick format) of the media. To solve this problem:

- Use other media.

Error in reading from media

Meaning: An error occurred while reading data from media. This error may also appear when data is being written to media by a Save or Copy operation. To solve this problem:

- Execute the reading procedure once again. If the same error occurs, it is possible that the data on the media has been damaged.

Error in writing to media

Meaning: A verification error occurred while writing data to a media. To solve this problem:

- It is possible that the media has been physically damaged. Try another media. Avoid using the media that produced the error.

F

File already exists

Meaning: When executing a **Create Directory** or **File Rename** procedure, a directory or file of the same name already exists on the media.

Meaning: When executing the Media mode Utility **Copy** command without using wild cards, the copy destination contained a file of the same name as the copy source.

- Either delete the existing directory or file, or specify a different name.

File unavailable

Meaning: You attempted to load or open a file whose format was incorrect.

File/path not found

Meaning: When executing the **Delete** command in the Media mode Utility page, the specified file did not exist.

Meaning: When executing the **Copy** command in the Media mode Utility page, and you used a wild card to specify the copy file name, the specified file was not found. Alternatively, the length of the copy source path name exceeded 76 characters.

Meaning: In Media mode when you used the Open button to open a directory, the path length including the selected directory name exceeded 76 characters.

- Check the file or directory.

Meaning: When you pressed the WRITE button to save your data in Sequencer mode, the media was not in a state that allowed saving, or the previously-opened directory was not a location where SNG files could be saved.

- If the save-destination directory is something other than the DOS directory from which you opened a .PCG or .SNG file, a message such as "File/path not found" will appear, and the data cannot be saved. In this case, move to Media mode, select an appropriate save-destination, and then execute **Save All** or **Save SEQ**.

I**Illegal file description**

Meaning: The filename that you specified when saving a file or creating a directory contained invalid characters. To solve this problem:

- Change the filename you are specifying. Filenames not permitted by MS-DOS cannot be used as a filename.

Illegal SMF data

Meaning: You attempted to load a file that was not a Standard MIDI File.

Illegal SMF division

Meaning: You attempted to load a Standard MIDI File that was timecode-based.

Illegal SMF format

Meaning: You attempted to load a Standard MIDI File of a format other than 0 or 1.

M**Master Track can't be recorded alone**

Meaning: When realtime-recording a single track, you attempted to begin recording with the master track as the current track.

- Select a MIDI track for recording, instead of the Master Track.

Measure number over limit

Meaning: The attempted edit procedure would cause the track length to exceed 999 measures.

- Delete unnecessary measures.

Measure size over limit

Meaning: When loading a Standard MIDI File, the number of events in a measure exceeded the maximum (approximately 65,535 events).

Meaning: The attempted edit procedure would cause the maximum number of events in a measure (approximately 65,535) to be exceeded.

To solve either of these problems:

- Use event editing etc. to delete unwanted data.

Media changed

Meaning: When executing the **Copy** command in the Media mode Utility page, the media was exchanged or ejected, and it was not possible to copy between separate media on the same drive.

Media unavailable

Meaning: You selected a media source that does not allow writing.

Media write protected

Meaning: The other writing-destination media is write-protected.

- Turn off write protect on the other media, and execute the command once again.

Memory full

Meaning: When editing a song, track or pattern in Sequencer mode, the total data of all songs has used up all of the sequence data memory, and further editing is not possible. To solve this problem:

- Delete other song data etc. to regain free memory.

Meaning: While realtime recording in Sequencer mode, there is no more free memory to accommodate the recorded data, so recording has been forcibly halted. To solve this problem:

- Delete other song data etc. to regain the amount of free memory.

Memory overflow

Meaning: While receiving exclusive data in Media mode **Save Exclusive**, all remaining internal memory was used up. To solve this problem:

- If you are receiving two or more sets of exclusive data, transmit them separately to the KROME.

Memory Protected

Meaning: The internal program, combination, song, drum kit, user arpeggio pattern is protected.

- In Global mode, turn off write-protect, and execute the write or load procedure once again.

MIDI data receiving error

Meaning: While receiving MIDI System Exclusive data, the format of the received data was invalid, for example, because the size of the data was incorrect.

N

No data

Meaning: When loading a Standard MIDI File, the file contained no events.

No media

Meaning: When executing a command in Media mode, no media was inserted in the drive. To solve this problem:

- Insert media, and navigate to an appropriate directory that the KROME will recognize. → p.118

No recording track specified

Meaning: When performing realtime multi-track recording, you attempted to begin recording with no tracks set to REC. To solve this problem:

- Set the desired tracks for recording to REC.

No space available on media

Meaning: When you attempted to save or copy a file, or to create a directory, there was not enough free space on the other media. To solve this problem:

- Either delete an existing file, or replace the media with another that contains sufficient free space.

Not enough Drum Track pattern locations available

Meaning: When converting a song's user pattern to a user drum track pattern, you have exceeded the number of user drum track patterns available for use.

- As necessary, execute the Media mode **Save PCG** command to save your user drum track patterns. In Sequencer mode, execute the menu command **Erase Drum Track Pattern** to increase the number of available drum track user patterns. Then try the conversion procedure again.

Not enough Drum Track pattern memory

Meaning: When converting a song's user pattern to a user drum track pattern, there was not enough free memory.

- As necessary, execute the Media mode **Save PCG** command to save your user drum track patterns. In Sequencer mode, execute the menu command **Erase Drum Track Pattern** to erase other user drum track patterns and increase the amount of free memory. Then try the conversion procedure again.

Not enough memory

Meaning: When starting realtime recording in Sequencer mode, the minimum amount of free memory (such as memory for the BAR events up to the recording start location) could not be allocated. To solve this problem:

- Delete other song data etc. to regain free memory.

Not enough memory to load

Meaning: When you attempted to load a .SNG file or a standard MIDI file in Media mode, there was insufficient free memory in the sequence memory. To solve this problem:

- Delete other song data etc. to regain free memory.

Not enough memory to open pattern

Meaning: There was insufficient sequencer memory to open the pattern, so editing is not possible.

- Either delete unwanted data such as a song, track, or pattern, or do not open the pattern.

Not enough pattern locations available

Meaning: When executing **Load Drum Track Pattern**, the attempted load procedure would exceed the remaining number of user patterns in the selected song.

- Create a new song, and reload the data into the user patterns of that song. You can load up to 100 user patterns into each song. If you have more drum track patterns than this to load, you can divide them between two or more songs.

Not enough song locations available

Meaning: When loading a .SNG file with **Append** specified, you attempted to load more songs than can be loaded.

- In Sequencer mode, execute **Delete Song** to increase the number of songs that can be used, and then load the song again.

P

Pattern conflicts with events

Meaning: It was not possible to execute the Bounce procedure because one of the tracks contained a pattern, and the same measure of the other track contained events or a pattern.

- Open the pattern.

Pattern exists across destination to-end-of-measure or source from-measure

Meaning: When moving a measure, the edit procedure could not be executed because a pattern had been put in the destination-end measure, or the source-start measure, and had not been opened.

- Open the pattern.

Pattern exists in destination or source track

Open pattern?

Meaning: A pattern has been placed in the track that you specified as a destination or source for editing. If you wish to open the pattern and execute (the events of the pattern will be copied), press the OK button. If you wish to execute without opening the pattern, press the Cancel button.

Pattern used in song

Continue ?

Meaning: When editing, the specified pattern has been placed in a track. If you wish to execute, press the OK button. If you decide not to execute, press the Cancel button.

R**Root directory is full**

Meaning: When attempting to create a file or directory at the root level of the media, you exceeded the maximum number of files or folder that could be created in the root directory of that media.

- Either delete an existing file or directory, or Open a directory to move down one level before creating a file or directory.

S**Selected file/path is not correct**

Meaning: When loading a divided .PCG file, you attempted to load a .PCG file of the same name that was not divided or had differing contents.

- Load the correct .PCG file.

Source is empty

Meaning: No data exists in the track or pattern that you specified as the source.

- Specify a track or pattern that contains musical data.

Meaning: This message will appear when you execute Swap Insert Effect if one of the effects to be swapped ("Source1" or "Source2") is a double-size effect, and is therefore an unusable IFX number.

- If you want to execute the Swap procedure on a double-size effect, specify an IFX number to which a double-size effect is assigned.

T**The internal memory has been corrupted, likely due to an interruption of power while the system was writing/saving data. This has been repaired and the affected Bank has been initialized. [OK]**

Meaning: A memory write procedure did not end normally, perhaps because the power was turned off while processing was still underway after you wrote a program or other data into internal memory.

- The KROME will automatically initialize itself in order to repair the internal memory. This message will appear at this time; press OK to close the dialog box. In some cases, the preload bank data may be temporarily initialized. As necessary, use the Global mode Load Preload/Demo Data command to load the preload data into internal memory, or if you have your own backup PCG, load it using Media mode.

There is not readable data

Meaning: Either the file size is 0 or the file does not contain data that can be accessed by the load or open procedure. Alternatively, the data is damaged etc., and cannot be loaded or accessed.

This file is already loaded

Meaning: When loading a divided .PCG file, you attempted to load a file that had already been loaded.

- Load the .PCG files that have not yet been loaded.

U**Unable to create directory**

Meaning: You attempted to create a directory that would exceed the maximum path name length (76 characters for the full path name).

Unable to save file

Meaning: When executing the Media mode Utility menu command **Copy**, the copy destination path length exceeded 76 characters.

Meaning: When saving a file in Media mode, the save destination path exceeded 76 characters.

Meaning: When you executed the Media mode Utility menu command **Copy**, the file management data exceeded the size of the management area.

Y**You can't undo this operation Are you sure?**

Meaning: Once you enter event editing (even if you leave event editing without actually editing an event), it will no longer be possible to execute Compare to listen to the previous edit. If you wish to enter event editing, press the OK button. To cancel, press the Cancel button.

You can't undo last operation Are you sure?

Meaning: When you exit recording or event editing in Sequencer mode, the memory area for Undo (Compare function) is not allocated. If you wish to keep the data that was just recorded or edited, press the OK button. If you wish to return to the previous data (i.e., to delete the data that was just recorded or edited), press the Cancel button.

Meaning: When editing in Sequencer mode, memory area for Undo (Compare function) cannot be allocated. If you wish to execute the edit, press the OK button (It will not be possible to undo your edit). If you decide not to execute the edit, press the Cancel button.

- In order to allocate memory area for Undo (Compare function), delete unneeded data such as songs, tracks, or patterns. We recommend that you data to media before you execute the edit procedure.

Specifications

Operating temperature		0 – +40 °C	
Keyboard	61-note	Semi-Weighted Keyboard (velocity sensitive, no aftertouch) Normally C2–C7 (adjustable in the range [C1...C6]–[C3...C8])	
	73-note	Semi-Weighted Keyboard (velocity sensitive, no aftertouch) Normally C1–C7 (adjustable in the range [C0...C6]–[C2...C8])	
	88-note	NH (Natural weighted hammer action) Keyboard (no aftertouch) * The NH Keyboard delivers a playing feel similar to that of an acoustic piano, with low notes being heavier and high notes being lighter.	
System		EDS-X (Enhanced Definition Synthesis-eXpanded)	
Sound Engine	Maximum Polyphony		120 voices max, single mode 60 voices max, double mode * The actual maximum polyphony will vary depending on oscillator settings such as stereo multisamples and velocity crossfading.
	Preset PCM		3.8 Gbytes (when calculated as 48kHz 16-bit linear data) 583 multisamples (including twelve stereo), 2,080 drumsamples (including 474 stereo)
	Programs	Oscillator	OSC1 (Single), OSC1+2 (Double): Stereo multisamples are supported 8 velocity zones per oscillator, with switching, crossfades and layers.
		Filters	Four types of filter routing (single, serial, parallel, 24 dB) Two multi-mode filters per voice (low pass, high pass, band pass, band reject)
		Driver	Per-voice nonlinear driver and low boost.
		EQ	Three bands, with sweepable mid.
	Combinations	Modulation	For each voice, two envelope generators (Filter & Amp), two LFOs, two key tracking generators (Filter & Amp), and two AMS mixers In addition, pitch EG, common LFO, and two common key tracking generators
		16 Timbres	Up to sixteen timbres, keyboard and velocity split/layer/crossfade, and modifications to the program setting via the Tone Adjust function
	Master Keyboard functionality		These allow you to control external MIDI devices
	Drum Kits		Stereo and mono drumsamples. 8-way velocity switches with crossfades and adjustable crossfade shapes (Linear, Power, Layer).
	The number of ... -Combinations -Programs -Drum Kits	User Combinations	512 Combinations/384 Preload
		User Programs	768 Programs/640 Preload
		User Drum Kits	48 Drum Kits/32 Preload
		Preset Programs	256 GM2 Programs + 9 GM2 Drum Programs
Effects	5 Insert Effects		In-line processing; stereo in - stereo out.
	2 Master Effects		Two effects sends; stereo in - stereo out.
	1 Total Effect		For overall processing on the main outputs, such as compression, limiting, and EQ; stereo in - stereo out.
	3-band Track EQ		High, low, and sweepable mid band. Per Program in Program Mode, per Timbre in Combination mode (16 total), and per Track in Sequencer mode (16 total).
	Effects types		193 types (Usable for insert, master, or total effects. However, double-size effects cannot be used as the total effect.)
	Modulation		Dynamic Modulation, two common LFOs
	Effects Control Bus		Stereo side-chaining for limiter, gates, vocoders, etc.
Effects Presets		Up to 32 per Effect	
Dual polyphonic arpeggiators		Program mode: one arpeggiator available. Combination and Sequencer modes: two arpeggiators available. 5 preset arpeggio patterns 1028 user arpeggio patterns (900 preload)	
Drum Track	Preset patterns	605 patterns (Held in common with sequencer preset patterns.)	
	User patterns	1,000 patterns. Patterns created in Sequencer mode can be converted to drum track user patterns.	
	Trigger Mode / Sync / Zone settings can be specified		
Sequencer	16 MIDI Tracks & 1 Master Track		
	128 Songs		
	Resolution: 480 ppq (parts per quarter-note)		
	Tempo: 40.00–300.00 bpm (1/100 bpm resolution)		
	Up to 210,000 MIDI events		
	16 preset/16 user template songs		
	Cue List function	20 cue lists. Songs can be arranged consecutively or repeatedly in up to 99 steps. A cue list can be converted back into a song.	
	Patterns/RPPR	605 Presets /100 User Patterns (per Song) RPPR (Realtime Pattern Play/Recording): 1 set per Song.	
Format	Korg (KROME) format, SMF (formats 0 and 1) supported		
Media	Load, Save, Utility		
	Data Filer functionality (Save and Load MIDI System Exclusive Data)		

Controllers		Joystick, SW1, 2		
		Realtime controls	SELECT buttons	REALTIME CONTROLS (TONE, USER), ARP
			4 knobs	REALTIME CONTROL: Realtime modulation Arpeggio control
		Drum Track	Buttons = DRUMTRACK	
		Arpeggiator	Buttons = ARP	
Effect On/Off	Buttons = MASTER FX, TOTAL FX			
User Interface		Display	TouchView graphical user interface, 7 inch TFT, WVGA (800x480 dots), adjustable brightness.	
		MODE	Buttons = COMBI, PROG SEQ, GLOBAL, MEDIA	
		Value Controllers	VALUE Dial, INC/DEC buttons, 10-key numeric keypad, (-) button, (.) button, ENTER button, COMPARE button	
		BANK	Buttons = A...F (used for Combination A, B, C, D)	
		SEQUENCER	Buttons = PAUSE (), REW (◀), FF (▶), LOCATE (◀), REC (●), START/STOP (▶/■)	
		TEMPO	TEMPO Knob, TAP button	
		Other	WRITE button, PAGE button, EXIT button, VOLUME knob	
Audio Outputs	Analog	AUDIO OUTPUT L/MONO, R	1/4" TS (Mono), unbalanced, Volume knob controls	
			Output Impedance	1.1kΩ stereo; 550Ω mono (L/Mono only)
			Maximum Level	+16.0 dBu
		Headphone output	1/8" TRS (Stereo), Volume knob	
			Output Impedance	33Ω
			Maximum Level	60+ 60 mW @33Ω
Control Inputs		DAMPER (Supports piano-style half-damper pedals as well as standard foot switches) ASSIGNABLE SWITCH, ASSIGNABLE PEDAL		
MIDI		IN, OUT		
USB		1 USB (TYPE B), MIDI interface		
SD-Card slot		Capacity recognized: SD memory cards up to 2 Gigabytes (GB). SDHC memory cards up to 32 Gigabytes (GB). SDXC memory cards are not supported.		
Power		AC adapter power supply connector (DC 12V, ⚡), Power On/Off switch		
Dimensions (W × D × H)	KROME-61	1,027 x 313 x 93 (mm)/40.43" x 12.32" x 3.66"		
	KROME-73	1,191 x 313 x 93 (mm)/46.89" x 12.32" x 3.66"		
	KROME-88	1,448 x 383 x 131 (mm)/57.01" x 15.08" x 5.16"		
Weight	KROME-61	61-note 7.2 kg/15.87 lbs		
	KROME-73	73-note 8.2 kg/18.08 lbs		
	KROME-88	88-note 14.7 kg/32.41 lbs		
Power Consumption	KROME-61	13W		
	KROME-73			
	KROME-88			
Accessories		AC adapter, Quick Start guide Accessory Disc (KROME Parameter Guide (PDF), Operation guide (PDF), Video manual etc.)		

Options	XVP-10	Expression/Volume Pedal
	EXP-2	Foot Controller
	DS-1H	Damper Pedal
	PS-1, PS-3	Pedal Switch

Operating requirements

KORG USB-MIDI Driver

Windows

Operating system: Microsoft Windows XP Home/Professional SP3,
Windows Vista SP2 (including 64-bit),
Windows 7 SP1 (including 64-bit)

Computer: USB port required (a USB host controller made by Intel is recommended)

Macintosh

Operating system: Mac OS X 10.5 or later.

Computer: Apple Macintosh computer with an Intel processor that has a USB port and satisfies the requirements for running Mac OS X.

* Appearance and specifications are subject to change without notice.

KROME

MIDI Implementation Chart

Function		Transmitted	Recognized	Remarks
Basic Channel	Default	1 – 16	1 – 16	Memorized
	Changed	1 – 16	1 – 16	
Mode	Memorized Messages Altered	× *****	3 ×	
Note Number:	True Voice	0 – 127 *****	0 – 127 0 – 127	All note numbers 0–127 can be transmitted by the Arpeggiator or as sequence data
Velocity	Note On Note Off	○ 9n, V=1 – 127 ×	○ 9n, V=1 – 127 ×	
Aftertouch	Polyphonic (Key) Monophonic (Channel)	○ ○	○ ○	Polyphonic aftertouch and Channel aftertouch transmitted only as sequence data *A (receive) *A (receive)
Pitch Bend		○	○	*C
Control Change	0, 32	○	○	Bank Select (MSB, LSB) *P
	1, 2, 17, 19, 20, 21	○	○	Joystick (+Y, -Y), Knob1-4 *C
	4, 5, 7, 8, 10	○	○	Pedal, Portamento Time, Volume, IFX pan, Pan *C
	11, 12, 13	○	○	Expression, Effect Control 1, 2 *C
	64, 65, 66, 67	○	○	Damper, Portamento Sw., Sostenuato, Soft *C
	70–79	○	○	Sound (Realtime Control TONE 1–4: 74, 71, 79, 72) *C
	80–83	○	○	Switch 1, 2, Foot Switch, Controller *C
	91–95	○	○	Send 1, 2, Effect ON/OFF (IFXs, MFXs, TFX) *C
	14, 22–25	○	○	Arpeggiator Controllers *C, *2
	6, 38	×	○	Data Entry (MSB, LSB) *C
	96, 97	×	○	Data Increment, Decrement *C
	100, 101	×	○	RPN (LSB, MSB) *C, *3
	0–119	○	○	Realtime Control USER 1–4, Seq. Data *C (Seq when received)
	120, 121	×	○	All Sound Off, Reset All Controllers *C
Program Change	Variable Range	○ 0 – 127 *****	○ 0 – 127 0 – 127	*P
System Exclusive		○	○	*E, *4
System Common	Song Position	○	○	When cue list is selected, corresponds to cue list. *1
	Song Select Tune	○ 0 – 127 ×	○ 0 – 127 ×	When cue list is selected, corresponds to cue list 0-19. *1
System Real Time	Clock	○	○	*1
	Command	○	○	*1
Aux Messages	Local On/Off	×	○	
	All Notes Off	×	○ 123 – 127	
	Active Sense	○	○	
	Reset	×	×	

Notes *P, *A, *C, *E: Transmitted/received when Global P1: MIDI Filter (Program Change, Aftertouch, Control Change, Exclusive) is Enable, respectively.
 *1: When Global P1: MIDI Clock is Internal, transmitted but not received. The opposite for External MIDI.
 *2: Valid if assigned as a MIDI control change in Global P2: Controllers. The number shown here is the CC default assignment.
 *3: RPN (LSB,MSB)=00,00: Pitch bend range, 01,00: Fine tune, 02,00: Coarse tune
 *4: In addition to Korg exclusive messages, Inquiry, GM System On, Master Volume, Master Balance, Master Fine Tune, and Master Coarse Tune are supported.

Mode 1: OMNI ON, POLY Mode 2: OMNI ON, MONO ○ : Yes
 Mode 3: OMNI OFF, POLY Mode 4: OMNI OFF, MONO × : No

IMPORTANT NOTICE TO CONSUMERS

This product has been manufactured according to strict specifications and voltage requirements that are applicable in the country in which it is intended that this product should be used. If you have purchased this product via the internet, through mail order, and/or via a telephone sale, you must verify that this product is intended to be used in the country in which you reside.

WARNING: Use of this product in any country other than that for which it is intended could be dangerous and could invalidate the manufacturer's or distributor's warranty.

Please also retain your receipt as proof of purchase otherwise your product may be disqualified from the manufacturer's or distributor's warranty.

KORG KORG INC.

4015-2 Yanokuchi, Inagi-city, Tokyo 206-0812 Japan

Free Manuals Download Website

<http://myh66.com>

<http://usermanuals.us>

<http://www.somanuals.com>

<http://www.4manuals.cc>

<http://www.manual-lib.com>

<http://www.404manual.com>

<http://www.luxmanual.com>

<http://aubethermostatmanual.com>

Golf course search by state

<http://golfingnear.com>

Email search by domain

<http://emailbydomain.com>

Auto manuals search

<http://auto.somanuals.com>

TV manuals search

<http://tv.somanuals.com>