

# TRITON STUDIO

MUSIC WORKSTATION/SAMPLER

## Parameter Guide



HYPER INTEGRATED  
SYNTHESIS SYSTEM



TouchView  
Graphical User Interface



# KORG

Ⓔ

①

## About this manual

This “**Parameter Guide**” contains explanations and other information regarding the operations of the parameters and settings on the TRITON STUDIO. The explanations are organized by mode, and page. Explanations and other information on the effects and their parameters are also provided for each effect.

Refer to this guide when an unfamiliar parameter appears in the display, or when you need to know more about a particular function.

## Conventions in this manual

### References to the TRITON STUDIO

The TRITON STUDIO is available in 88-key, 76-key and 61-key models, but both models are referred to without distinction in this manual as “the TRITON STUDIO.” Illustrations of the front and rear panels in this manual show the 61-key model, but the illustrations apply equally to the 88-key and 76-key models.

### Abbreviations for the manuals BG, PG, VNL

References to the manuals included with the TRITON STUDIO are abbreviated as follows in this document.

**BG:** Basic Guide

**PG:** Parameter Guide

**VNL:** Voice Name List

### Keys and knobs [ ]

References to the switches, dials, and knobs on the TRITON STUDIO’s panel are enclosed in square brackets [ ]. References to **buttons** or **tabs** indicate objects in the LCD display screen.

### Parameters in the LCD display screen “ ”

Parameters displayed in the LCD screen are enclosed in double quotation marks “ ”.

### Boldface type

Parameter values are printed in boldface type.

Content that is of particular importance is also printed in boldface type.

### Procedure steps ① ② ③ ...

Steps in a procedure are listed as ① ② ③ ...

### ☞ p. ■, ☞ ■ - ■

These indicate pages or parameter numbers to which you can refer.

### Symbols , , , , ,

These symbols respectively indicate cautions, advice, MIDI-related explanations, a parameter that can be selected as an alternate modulation source, a parameter that can be selected as a dynamic modulation source, and a parameter that can use the BPM/MIDI Sync function.

### Example screen displays

The values of the parameters shown in the example screens of this manual are only for explanatory purposes, and may not necessary match the values that appear in the LCD screen of your instrument.

### MIDI-related explanations

CC# is an abbreviation for Control Change Number.

In explanations of MIDI messages, **numbers in square brackets [ ]** always indicate hexadecimal numbers.

## How to read the “Parameter Guide”

(example)

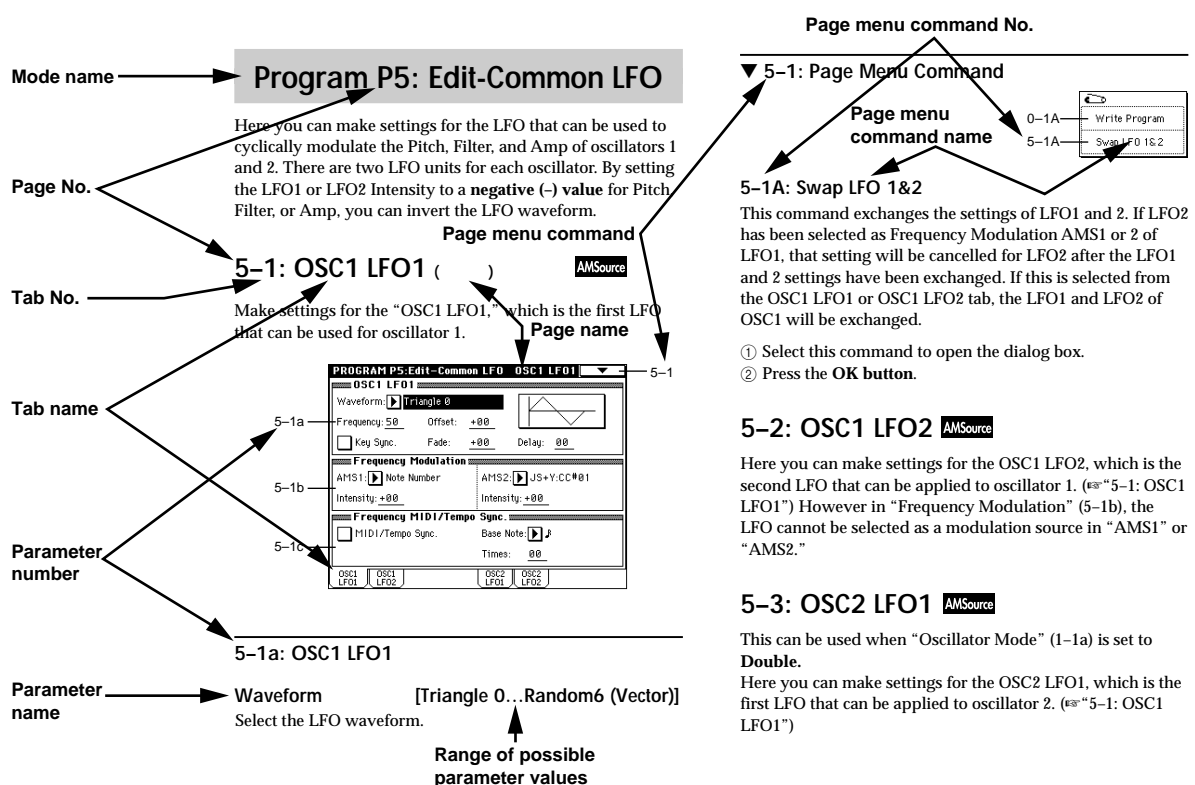

# Table of Contents

## 1. Program mode . . . . . 1

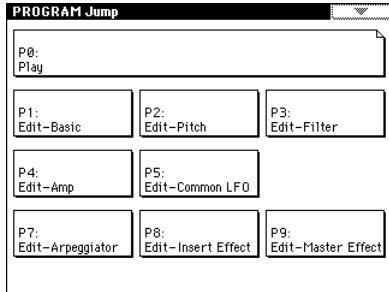

**Program P0: Play** . . . . . 1  
 Select and play programs.

- 0-1: Perf. Edit      Select and play programs; use the Performance Editor for simple editing ... 1
- 0-2: Arpeggio      Arpeggio pattern selection and settings. 3
- 0-3: Sampling      Perform sampling; make settings for audio inputs etc..... 4

**Program P1: Edit-Basic** . . . . . 7  
 Make basic oscillator settings and scale settings etc.

- 1-1: Program Basic    Oscillator settings for Single/Double/Drums, Poly/Mono, scale etc..... 7
- 1-2: OSC Basic      Specify the multisample for oscillators 1 and 2 ..... 9
- 1-3: Velo. Zone      Velocity zone settings ..... 11
- 1-4: Controller      [SW1] and [SW2] key functions; REALTIME CONTROLS [1]-[4] knob B-mode functions ..... 12

**Program P2: Edit-Pitch** . . . . . 12  
 Make pitch-related settings for oscillators 1 and 2.

- 2-1: OSC1 P.Mod      Specify oscillator 1 pitch modulation via key position or controllers..... 12
- 2-2: OSC2 P.Mod      Specify oscillator 2 pitch modulation via key position or controllers..... 14
- 2-3: Pitch EG AMSOURCE    Pitch EG settings ..... 14

**Program P3: Edit-Filter** . . . . . 16  
 Make filter settings for oscillators 1 and 2.

- 3-1: Filter1      Filter 1 (for oscillator 1) type, cutoff frequency, and resonance settings ..... 16
- 3-2: Filter1 Mod.    Keyboard tracking and controller settings to modulate the filter 1 cutoff frequency ..... 17
- 3-3: Filter1 LFO Mod.    Filter 1 LFO settings to modulate the filter 1 cutoff frequency ..... 18
- 3-4: Filter1 EG AMSOURCE    Filter 1 EG settings..... 19
- 3-5: Filter2      Filter 2 (for oscillator 2) type, cutoff frequency, and resonance settings ..... 21

- 3-6: Filter2 Mod.      Keyboard tracking and controller settings to modulate the filter 2 cutoff frequency ..... 21
- 3-7: Filter2 LFO Mod.    Filter 2 LFO settings to modulate the filter 2 cutoff frequency ..... 21
- 3-8: Filter2 EG AMSOURCE    Filter 2 EG settings ..... 21

**Program P4: Edit-Amp** . . . . . 21  
 Make amp settings for oscillators 1 and 2.

- 4-1: Amp1 Level/Pan    Oscillator 1 volume and pan settings .... 21
- 4-2: Amp1 Mod.      Keyboard tracking and controller settings to modulate amp 1 ..... 22
- 4-3: Amp1 EG AMSOURCE    Amp 1 EG settings ..... 23
- 4-4: Amp2 Level/Pan    Oscillator 2 volume and pan settings .... 24
- 4-5: Amp2 Mod.      Keyboard tracking and controller settings to modulate amp 2 ..... 24
- 4-6: Amp2 EG      Amp 2 EG settings ..... 24

**Program P5: Edit-Common LFO** . . . . . 25  
 Make settings for the general purpose LFOs used to cyclically modulate the pitch, filter, and amp of oscillators 1 and 2.

- 5-1: OSC1 LFO1 AMSOURCE    OSC1 LFO1 (for oscillator 1) settings .... 25
- 5-2: OSC1 LFO2 AMSOURCE    OSC1 LFO2 (for oscillator 1) settings .... 26
- 5-3: OSC2 LFO1 AMSOURCE    OSC2 LFO1 (for oscillator 2) settings .... 26
- 5-4: OSC2 LFO2 AMSOURCE    OSC2 LFO2 (for oscillator 2) settings .... 26

**Program P7: Edit-Arpeggiator** . . . . . 26  
 Make settings for the arpeggiator.

- 7-1: Arpeg. Setup      Select an arpeggio pattern and make settings..... 26
- 7-2: Scan Zone      Specify the note and velocity ranges that will operate the arpeggiator ..... 28

**Program P8: Edit-Insert Effect** . . . . . 28  
 Specify the oscillator output bus, and make insert effect settings.

- 8-1: Routing      Specify the oscillator output bus and set the send levels to the master effects ..... 28
- 8-2: Insert FX      Select insert effects and turn them on/off, and make chain settings..... 29
- 8-3: IFX 1      Parameter settings for IFX1 ..... 30
- 8-4: IFX 2      Parameter settings for IFX2 ..... 30
- 8-5: IFX 3      Parameter settings for IFX3 ..... 30
- 8-6: IFX 4      Parameter settings for IFX4 ..... 30
- 8-7: IFX 5      Parameter settings for IFX5 ..... 30

**Program P9: Edit-Master Effect** . . . . . 31  
 Make master effect and master EQ settings.

- 9-1: Master FX      Select master effects and turn them on/off, and make chain settings ..... 31
- 9-2: MFX 1      Parameter settings for MFX1 ..... 32
- 9-3: MFX 2      Parameter settings for MFX2 ..... 32
- 9-4: Master EQ      Parameter settings for master EQ ..... 32

## 2. Combination mode. . . . . 33

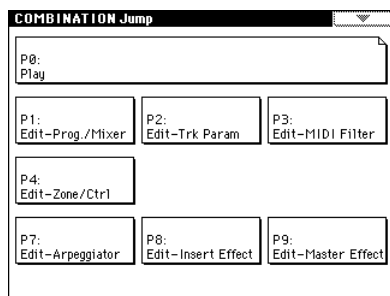

### Combination P0: Play ..... 33

Select and play combinations.

- 0-1: Prog. Select     Select a program for each timbre ..... 33
- 0-2: Mixer           Specify pan and level..... 35
- 0-3: Arpegg. A       Select an arpeggio pattern and make settings for arpeggiator A ..... 36
- 0-4: Arpegg. B       Select an arpeggio pattern and make settings for arpeggiator B..... 36
- 0-5: Sampling        Perform sampling; make audio input settings etc..... 36

### Combination P1: Edit-Program/Mixer ..... 37

Select the program for each timbre, and specify pan and level.

- 1-1: Program/Mixer   Specify program, pan, and level of each timbre ..... 37

### Combination P2: Edit-Trk Param ..... 38

Set various parameters for each timbre.

- 2-1: MIDI Channel    Specify MIDI channel and status for each timbre ..... 38
- 2-2: OSC             Make settings such as mono/poly and portamento for each timbre ..... 38
- 2-3: Pitch            Make pitch-related settings such as transpose and bend range for each timbre ..... 39
- 2-4: Other            Make delay and scale settings for each timbre ..... 40

### Combination P3: Edit-MIDI Filter ..... 40

Specify MIDI message reception filtering for each timbre.

- 3-1: MIDI 1          Program changes, aftertouch etc. .... 40
- 3-2: MIDI 2          Joystick, ribbon controller ..... 41
- 3-3: MIDI 3          Realtime control knobs..... 41
- 3-4: MIDI 4          SW1/2, foot controller etc. .... 41

### Combination P4: Edit-Zone/Ctrl ..... 42

Specify the key range and controllers for each timbre.

- 4-1: Key Z            Specify the key zone sounded by each timbre ..... 42
- 4-2: Vel Z            Specify the range of velocities sounded by each timbre..... 42
- 4-3: MOSS Setup      Displayed if the EXB-MOSS option is installed; set EXB-MOSS parameters..... 43
- 4-4: Controller       Specify the function of the [SW1] and [SW2] keys, and B-mode functions of the REALTIME CONTROLS [1]-[4] knobs. 43

### Combination P7: Edit-Arp..... 44

Make settings for arpeggiators A and B.

- 7-1: Setup            Assign arpeggiators to each timbre ..... 44
- 7-2: Arpegg. A        Select an arpeggio pattern and make settings for arpeggiator A ..... 45
- 7-3: Arpegg. B        Select an arpeggio pattern and make settings for arpeggiator B ..... 45
- 7-4: Scan Zone        Specify the ranges of notes and velocities that will operate the arpeggiator ..... 45

### Combination P8: Edit-Insert FX ..... 46

Specify the output bus for each timbre, and make insert effect settings.

- 8-1: Routing          Specify the output bus and master effect send levels for each timbre..... 46
- 8-2: Insert FX        Select insert effects, turn them on/off, and make chain settings..... 47
- 8-3: IFX 1            Parameter settings for IFX1..... 47
- 8-4: IFX 2            Parameter settings for IFX2..... 47
- 8-5: IFX 3            Parameter settings for IFX3..... 47
- 8-6: IFX 4            Parameter settings for IFX4..... 47
- 8-7: IFX 5            Parameter settings for IFX5..... 47

### Combination P9: Edit-Master FX ..... 48

Make settings for the master effects and master EQ.

- 9-1: Master FX        Select the master effects, turn them on/off, and make chain settings ..... 48
- 9-2: MFX 1            Parameter settings for MFX1 ..... 48
- 9-3: MFX 2            Parameter settings for MFX2 ..... 48
- 9-4: Master EQ        Parameter settings for master EQ ..... 48

**About the Jump pages**

The LCD screens shown here are the Jump pages for each mode.

The Jump page is a page menu that lets you access the various pages within each mode.

Here's how to access the Jump page, and select the desired page.

- Press the [MENU] key to access the Jump page. In the LCD screen, press the page that you want to select, or press the numeric key [0]-[9] corresponding to the number of the desired page. (BG p.16)
- Alternatively, you can hold down the [MENU] key and press the numeric key [0]-[9] corresponding to the number of the desired page.

### 3. Sequencer mode . . . . . 49

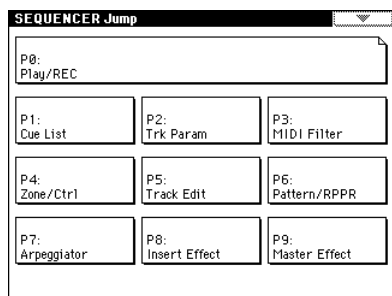

#### Sequencer P0: Play/Rec . . . . . 49

Make settings for playing/recording a song, and select the program etc. used for each track.

- 0-1: Prog. 1-8      Program selection, mute, and solo settings for each track ..... 49
- 0-2: Prog. 9-16      ..... 49
- 0-3: Mixer 1-8      Pan and volume settings for each track 55
- 0-4: Mixer 9-16      ..... 55
- 0-5: PlyLoop 1-8      Loop track settings for each track..... 55
- 0-6: PlyLoop 9-16      ..... 55
- 0-7: Sampling      Settings for sampling and audio input etc. .... 56
- 0-8: Preference      Select the realtime recording method, and you can make metronome settings..... 57

#### Sequencer P1: Cue List . . . . . 59

Create and play a cue list for playing a succession of songs.

- 1-1: Cue List      Create and play back a cue list..... 59

#### Sequencer P2: Trk Param..... 62

Set various parameters for each timbre.

- 2-1: MIDI Ch 1-8      MIDI channel and status settings for each track ..... 62
- 2-2: MIDI Ch 9-16      ..... 62
- 2-3: OSC 1-8      Mono/poly and portamento settings etc. for each track ..... 63
- 2-4: OSC 9-16      ..... 63
- 2-5: Pitch 1-8      Pitch-related settings (transpose, pitch bend range etc.) for each track ..... 63
- 2-6: Pitch 9-16      ..... 63
- 2-7: Other 1-8      Delay and scale settings for each track . 64
- 2-8: Other 9-16      ..... 64

#### Sequencer P3: MIDI Filter . . . . . 65

Specify MIDI message reception filtering for each track.

- 3-1: MIDI 1 1-8      Program changes, aftertouch etc. .... 65
- 3-2: MIDI 1 9-16      ..... 65
- 3-3: MIDI 2 1-8      Joystick, ribbon controller ..... 65
- 3-4: MIDI 2 9-16      ..... 65
- 3-5: MIDI 3 1-8      Realtime control knobs ..... 65
- 3-6: MIDI 3 9-16      ..... 65
- 3-7: MIDI 4 1-8      SW1/2, foot controller etc. .... 66
- 3-8: MIDI 4 9-16      ..... 66

#### Sequencer P4: Zone/Ctrl..... 66

Specify the note range and controllers for each track.

- 4-1: Key Z 1-8      Specify the range of keys sounded by each track ..... 66
- 4-2: Key Z 9-16      ..... 66
- 4-3: Vel Z 1-8      Specify the range of velocities sounded by each track ..... 67
- 4-4: Vel Z 9-16      ..... 67
- 4-5: MOSS 1-8      Displayed if the EXB-MOSS option is installed; set EXB-MOSS parameters..... 67
- 4-6: MOSS 9-16      ..... 67
- 4-7: Controller      Specify the function of the [SW1] and [SW2] keys, and B-mode functions of the REALTIME CONTROLS [1]-[4] knobs .67

#### Sequencer P5: Track Edit . . . . . 68

Perform track editing and step recording.

- 5-1: Track Edit      Track editing operations such as Copy or Delete, and step recording ..... 68
- 5-2: Track Name      Edit the name of each track ..... 75

#### Sequencer P6: Pattern/RPPR . . . . . 76

Record and edit patterns, and make RPPR settings.

- 6-1: Pattern Edit      Record a pattern, and perform pattern editing such as Copy or Delete ..... 76
- 6-2: Pattern Name      Edit the name of a pattern..... 78
- 6-3: RPPR Setup      RPPR settings..... 79

#### Sequencer P7: Arpeggiator..... 81

Make settings for arpeggiators A and B.

- 7-1: Setup 1-8      Assign an arpeggiator to each track ..... 81
- 7-2: Setup 9-16      ..... 81
- 7-3: Arpegg. A      Select an arpeggio pattern and make settings for arpeggiator A ..... 82
- 7-4: Arpegg. B      Select an arpeggio pattern and make settings for arpeggiator B ..... 82
- 7-5: Scan Zone      Specify the range of notes and velocities that will operate the arpeggiator ..... 82

#### Sequencer P8: Insert Effect . . . . . 83

Specify the bus for the output of each track, and make insert effect settings.

- 8-1: Routing 1-8      Specify the bus and master effect send levels for the output of each track ..... 83
- 8-2: Routing 9-16      ..... 83
- 8-3: Insert FX      Select insert effects and turn them on/off, and make chain settings..... 84
- 8-4: IFX 1      Parameter settings for IFX1 ..... 85
- 8-5: IFX 2      Parameter settings for IFX2 ..... 85
- 8-6: IFX 3      Parameter settings for IFX3 ..... 85
- 8-7: IFX 4      Parameter settings for IFX4 ..... 85
- 8-8: IFX 5      Parameter settings for IFX5 ..... 85

#### Sequencer P9: Master Effect . . . . . 85

Make master effect and master EQ settings.

- 9-1: Master FX      Select master effects and turn them on/off, and make chain settings..... 85
- 9-2: MFX 1      Parameter settings for MFX1 ..... 86
- 9-3: MFX 2      Parameter settings for MFX2 ..... 86
- 9-4: Master EQ      Parameter settings for master EQ ..... 86

## 4. Sampling mode . . . . . 87

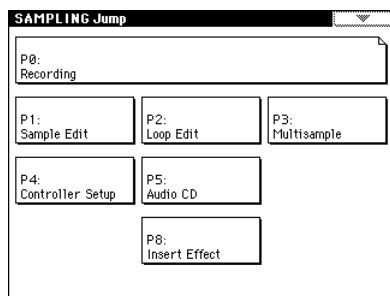

### Sampling P0: Recording . . . . . 88

Make sample recording settings such as input level, and basic settings for multisamples and samples.

- 0-1: Recording Basic settings such as selecting a multisample and sample, and adjusting the final input level..... 88
- 0-2: Input/Setup Audio input settings, and recording setup ..... 96
- 0-3: Preference Settings for creating indexes..... 98
- 0-4: Memory Status View the amount of remaining sample memory (RAM), and the remaining number of multisamples and samples .. 99

### Sampling P1: Sample Edit . . . . . 100

Edit sample data (waveform data), and perform editing operations such as Copy and Rate Convert.

- 1-1: Sample Edit Edit sample data (waveform data) ..... 100

### Sampling P2: Loop Edit..... 107

Specify the region of the sample that will be played, make loop playback settings, and perform editing operations such as Time Slice and Time Stretch.

- 2-1: Loop Edit Loop playback settings and editing..... 107

### Sampling P3: Multisample..... 117

Edit a multisample. Assign samples, and specify zones and original keys.

- 3-1: Multisample Edit multisamples ..... 117
- 3-2: Preference Settings for creating indexes..... 119

### Sampling P4: Controller Setup . . . . . 119

Make controller settings.

- 4-1: Controller Setup Specify the function of the [SW1] and [SW2] keys, and B-mode functions of the REALTIME CONTROLS [1]-[4] knobs... 119

### Sampling P5: Audio CD . . . . . 120

Play back an audio CD, and rip samples from an audio CD.

- 5-1: Audio CD Play back an audio CD and rip ..... 120

### Sampling P8: Insert Effect . . . . . 122

Specify the bus for the sample output, and make insert effect settings.

- 8-1: Routing Specify the bus for the sample output ..... 122
- 8-2: Insert FX Select insert effects, turn them on/off, and make chain settings..... 122
- 8-3: IFX 1 Parameter settings for IFX1 ..... 122
- 8-4: IFX 2 Parameter settings for IFX2 ..... 122

- 8-5: IFX 3 Parameter settings for IFX3..... 122
- 8-6: IFX 4 Parameter settings for IFX4..... 122
- 8-7: IFX 5 Parameter settings for IFX5..... 122

## 5. Song Play mode . . . . . 123

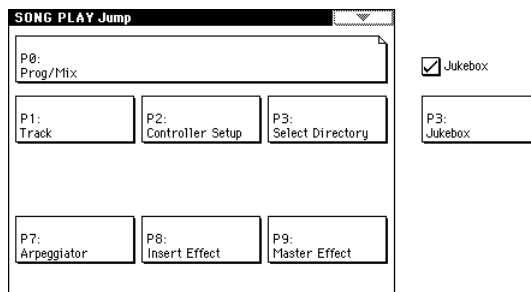

### Song Play P0: Prog/Mix . . . . . 123

Select SMF data and play it back.

- 0-1: Prog. 1-8 Select the program for each track..... 123
- 0-2: Prog. 9-16 ..... 123
- 0-3: Mixer 1-8 Set pan and volume for each track ..... 125
- 0-4: Mixer 9-16 ..... 125
- 0-5: Preference Settings for consecutive playback of SMF data, and metronome settings ..... 125

### Song Play P1: Track . . . . . 126

Specify the status and scale for each track.

- 1-1: Status 1-8 Status and scale settings ..... 126
- 1-2: Status 9-16 ..... 126
- 1-3: MOSS 1-8 Displayed if the EXB-MOSS option is installed; set EXB-MOSS parameters ... 126
- 1-4: MOSS 9-16 ..... 126

### Song Play P2: Controller Setup . . . . . 127

Make controller settings.

- 2-1: Controller Setup Specify the function of the [SW1] and [SW2] keys, and B-mode functions of the REALTIME CONTROLS [1]-[4] knobs ... 127

### Song Play P3: Select Directory/Jukebox . . . . . 128

Select the directory that contains the SMF you want to play. If "Jukebox" is checked, you can create a jukebox list.

- 3-1: Select Directory Select the directory that contains the SMF you want to play..... 128
- 3-1: Jukebox Create a jukebox list..... 128

### Song Play P7: Arpeggiator . . . . . 129

Make settings for arpeggiators A and B.

- 7-1: Setup 1-8 Assign an arpeggiator to each track..... 129
- 7-2: Setup 9-16 ..... 129
- 7-3: Arpegg. A Select an arpeggio pattern and make settings for arpeggiator A ..... 130
- 7-4: Arpegg. B Select an arpeggio pattern and make settings for arpeggiator B ..... 130
- 7-5: Scan Zone Specify the range of notes and velocities that will operate the arpeggiator ..... 130

<b>Song Play P8: Insert Effect</b> .....	<b>131</b>
Specify the bus for the output of each track, and make insert effect settings.	
8-1: Routing 1-8	Specify the bus and the master effect send levels for the output of each track .....
	<b>131</b>
8-2: Routing 9-16	.....
	<b>131</b>
8-3: Insert FX	Select insert effects, turn them on/off, and make chain settings .....
	<b>132</b>
8-4: IFX 1	Parameter settings for IFX1 .....
	<b>132</b>
8-5: IFX 2	Parameter settings for IFX2 .....
	<b>132</b>
8-6: IFX 3	Parameter settings for IFX3 .....
	<b>132</b>
8-7: IFX 4	Parameter settings for IFX4 .....
	<b>132</b>
8-8: IFX 5	Parameter settings for IFX5 .....
	<b>132</b>

<b>Song Play P9: Master Effect</b> .....	<b>133</b>
Make settings for the master effects and master EQ.	
9-1: Master FX	Select the master effects, turn them on/off, and make chain settings.....
	<b>133</b>
9-2: MFX1	Parameter settings for MFX1.....
	<b>133</b>
9-3: MFX2	Parameter settings for MFX2.....
	<b>133</b>
9-4: Master EQ	Parameter settings for master EQ.....
	<b>133</b>

## 6. Global mode ..... 135

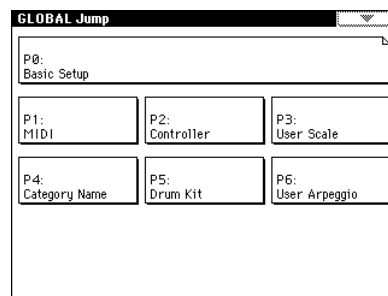

<b>Global P0: Basic Setup</b> .....	<b>135</b>
Make basic settings that affect the entire TRITON STUDIO, and make AUDIO INPUT settings for other than Sampling mode. If the EXB-mLAN option is installed, make settings for mLAN input/output.	
0-1: Basic	Master tune, key transpose, effect global switch, and auto arpeggiator on/off settings.....
	<b>135</b>
0-2: System Preference	Bank map, system lock, and memory protect settings .....
	<b>137</b>
0-3: Input/Sampling	Audio input settings for other than Sampling mode .....
	<b>139</b>
0-4: mLAN Output	Audio and MIDI output settings to an external mLAN device (EXB-mLAN option) .....
	<b>140</b>
0-5: mLAN Input	Audio and MIDI input settings from an external mLAN device (EXB-mLAN option) .....
	<b>141</b>
<b>Global P1: MIDI</b> .....	<b>142</b>
Make MIDI settings for the entire TRITON STUDIO.	
1-1: MIDI	Settings such as global MIDI channel, MIDI clock, and MIDI filter .....
	<b>142</b>
<b>Global P2: Controller</b> .....	<b>146</b>
Make settings for the damper pedal and assignable foot switch/pedal.	
2-1: Controller	Damper pedal and assignable foot switch/pedal settings .....
	<b>146</b>
<b>Global P3: User Scale</b> .....	<b>146</b>
Create user octave scales and user all note scales.	
3-1: User Scale	Create user scales .....
	<b>146</b>
<b>Global P4: Category Name</b> .....	<b>147</b>
Assign names to categories.	
4-1: Program Cat.	Specify program category names.....
	<b>147</b>
4-2: Comb Cat.	Specify combination category names ..
	<b>147</b>
<b>Global P5: Drum Kit</b> .....	<b>148</b>
Edit or create drum kits.	
5-1: Sample Setup	Assign a drum sample to each key .....
	<b>148</b>
5-2: Voice/Mixer	Specify the bus and pan etc. for each key .....
	<b>150</b>
<b>Global P6: User Arpeggio</b> .....	<b>151</b>
Edit or create user arpeggio patterns.	
6-1: Pattern Setup	Specify the operation of the arpeggio pattern .....
	<b>151</b>
6-2: Pattern Edit	Input tones for each step .....
	<b>153</b>

## 7. Disk mode . . . . . 155

Files, directories, and icons .....	155	
0-1: Load	Load the selected file or directory into internal memory..... 156	
0-2: Save	Save data from internal memory to various media..... 165	
0-3: Utility	Rename, copy, delete, or format the selected disk or file .....	169
0-4: Make Audio CD	Create an audio CD .....	172
0-5: Play Audio CD	Play an audio CD .....	174
0-6: Media Info	View information about the selected media .....	175

## 8. Effect Guide. . . . . 177

<b>Overview</b> .....	177
1. Effects in each mode .....	177
2. Dynamic modulation (Dmod) .....	177
3. Effect I/O .....	177
<b>Insert Effects (IFX 1, 2, 3, 4, 5)</b> .....	178
1. In/Out .....	178
2. Routing.....	179
3. Mixer .....	181
4. Controlling the Insert Effects via MIDI.....	182
<b>Master Effects (MFX1, 2)</b> .....	182
1. In/Out .....	182
2. Routing.....	183
3. Mixer .....	184
4. Controlling the Master Effects via MIDI.....	185
<b>Master EQ</b> .....	185
<b>Main Output</b> .....	185
<b>Individual Outputs</b> .....	185
<b>Effect/Mixer Block Diagram</b> .....	186
Program .....	186
Combination.....	186
Sampling .....	186
<b>Filter/Dynamic</b> .....	187
Filter and dynamics control effects	
000: No Effect .....	187
001: St. Amp Simulation (Stereo Amp Simulation) .....	187
002: Stereo Compressor.....	187
003: Stereo Limiter.....	187
004: Multiband Limiter.....	188
005: Stereo Gate.....	189
006: OD/Hi.Gain Wah (Overdrive/Hi.Gain Wah) .....	189
007: St. Parametric 4EQ (Stereo Parametric 4-Band EQ) .....	190
008: St. Graphic 7EQ (Stereo Graphic 7 Band EQ).....	191
009: St. Wah/Auto Wah (Stereo Wah/Auto Wah).....	191
010: St. Random Filter (Stereo Random Filter).....	192
011: St. Exciter/Enhncr (Stereo Exciter/Enhancer).....	193
012: St. Sub Oscillator (Stereo Sub Oscillator).....	193
013: Talking Modulator .....	194
014: Stereo Decimator .....	195
015: St. Analog Record (Stereo Analog Record) .....	195
<b>Pitch/Phase Mod.</b> .....	196
Pitch/phase modulation effects	
016: Stereo Chorus.....	196
017: St. Harmonic Chorus (Stereo Harmonic Chorus) .....	196
018: Multitap Cho/Delay (Multitap Chorus/Delay) .....	197
019: Ensemble .....	197
020: Stereo Flanger .....	198
021: St. Random Flanger (Stereo Random Flanger) .....	198



022: St. Env. Flanger (Stereo Envelope Flanger) .....	199
023: Stereo Phaser .....	199
024: St. Random Phaser (Stereo Random Phaser) .....	200
025: St. Env. Phaser (Stereo Envelope Phaser) .....	200
026: St. Biphase Mod. (Stereo Biphase Modulation) .....	201
027: Stereo Vibrato .....	201
028: St. Auto Fade Mod. (Stereo Auto Fade Modulation) .....	202
029: 2Voice Resonator .....	202
030: Doppler .....	203
031: Scratch .....	204

**Mod./P.Shift ..... 205**

**Other modulation and pitch shift effects**

032: Stereo Tremolo .....	205
033: St. Env. Tremolo (Stereo Envelope Tremolo) .....	205
034: Stereo Auto Pan .....	206
035: St. Phaser + Trml (Stereo Phaser + Tremolo) .....	206
036: St. Ring Modulator (Stereo Ring Modulator) .....	207
037: Detune .....	208
038: Pitch Shifter .....	208
039: Pitch Shift Mod. (Pitch Shift Modulation) .....	209
040: Rotary Speaker .....	209

**ER/Delay ..... 210**

**Early reflection and delay effects**

041: Early Reflections .....	210
042: Auto Reverse .....	211
043: L/C/R Delay .....	211
044: Stereo/Cross Delay .....	212
045: St. Multitap Delay (Stereo Multitap Delay) .....	212
046: St. Modulation Delay (Stereo Modulation Delay) .....	213
047: St. Dynamic Delay (Stereo Dynamic Delay) .....	213
048: St. Auto Panning Dly (Stereo Auto Panning Delay) .....	214
049: L/C/R BPM Delay .....	214
050: St. BPM Delay (Stereo BPM Delay) .....	215
051: Sequence Delay .....	215

**Reverb ..... 216**

**Reverb effects**

052: Reverb Hall .....	216
053: Reverb SmoothHall .....	216
054: Reverb Wet Plate .....	216
055: Reverb Dry Plate .....	216
056: Reverb Room .....	217
057: Reverb BrightRoom .....	217

**Mono – Mono Chain ..... 217**

**Effects that combine two mono effects connected in series**

058: P4EQ – Exciter (Parametric 4-Band EQ – Exciter) .....	217
059: P4EQ – Wah (Parametric 4-Band EQ – Wah/Auto Wah) .....	218
060: P4EQ – Cho/Flng (Parametric 4-Band EQ – Chorus/Flanger) ..	218
061: P4EQ – Phaser (Parametric 4-Band EQ – Phaser) .....	219
062: P4EQ – Mt. Delay (Parametric 4-Band EQ – Multitap Delay) .....	219
063: Comp – Wah (Compressor – Wah/Auto Wah) .....	220
064: Comp – Amp Sim (Compressor – Amp Simulation) .....	220
065: Comp – OD/HiGain (Compressor – Overdrive/Hi.Gain) .....	220
066: Comp – Param4EQ (Compressor – Parametric 4-Band EQ) .....	221

067: Comp – Cho/Flng (Compressor – Chorus/Flanger) .....	221
068: Comp – Phaser (Compressor – Phaser) .....	222
069: Comp – Mt. Delay (Compressor – Multitap Delay) .....	222
070: Limiter – P4EQ (Limiter – Parametric 4-Band EQ) .....	223
071: Limiter – Cho/Flng (Limiter – Chorus/Flanger) .....	223
072: Limiter – Phaser .....	224
073: Limiter – Mt. Delay (Limiter – Multitap Delay) .....	224
074: Exciter – Comp (Exciter – Compressor) .....	225
075: Exciter – Limiter .....	225
076: Exciter – Cho/Flng (Exciter – Chorus/Flanger) .....	225
077: Exciter – Phaser .....	226
078: Exciter – Mt. Delay (Exciter – Multitap Delay) .....	226
079: OD/HG – Amp Sim (Overdrive/Hi.Gain – Amp Simulation) .....	227
080: OD/HG – Cho/Flng (Overdrive/Hi.Gain – Chorus/Flanger) .....	227
081: OD/HG – Phaser (Overdrive/Hi.Gain – Phaser) .....	228
082: OD/HG – Mt. Delay (Overdrive/Hi.Gain – Multitap Delay) .....	228
083: Wah – Amp Sim (Wah/Auto Wah – Amp Simulation) .....	229
084: Decimator – Amp (Decimator – Amp Simulation) .....	229
085: Decimator – Comp (Decimator – Compressor) .....	229
086: Amp Sim – Tremolo (Amp Simulation – Tremolo) .....	230
087: Cho/Flng – Mt. Dly (Chorus/Flanger – Multitap Delay) .....	230
088: Phaser – Cho/Flng (Phaser – Chorus/Flanger) .....	231
089: Reverb – Gate .....	231

**Double Size ..... 232**

**Double-size effects**

090: Piano Body/Damper (Piano Body/Damper Simulation) .....	232
091: St. Mltband Limiter (Stereo Multiband Limiter) .....	232
092: OD/HyperGain Wah (Overdrive/Hyper Gain Wah) .....	232
093: Vocoder .....	233
094: Multitap Cho/Delay (Multitap Chorus/Delay) .....	234
095: St. Pitch Shifter (Stereo Pitch Shifter) .....	234
096: Rotary Speaker OD (Rotary Speaker Overdrive) .....	235
097: Early Reflections .....	236
098: L/C/R Long Delay .....	236
099: St/Cross Long Dly (Stereo/Cross Long Delay) .....	236
100: LCR BPM Long Dly (L/C/R BPM Long Delay) .....	237
101: St. BPM Long Delay (Stereo BPM Long Delay) .....	237
102: Hold Delay .....	238

**Master EQ ..... 239**

Master EQ .....	239
-----------------	-----

## 9. Appendices . . . . . 241

<b>Alternate Modulation Source (AMS)</b> .....	241
About Alternate Modulation .....	241
About Alternate Modulation Sources .....	241
AMS (Alternate Modulation Source) List .....	242
Alternate Modulation settings .....	244
The effect of alternate modulation on various parameters, and example applications .....	244
<b>Dynamic Modulation Source (Dmod)</b> .....	246
Dynamic Modulation Source List .....	247
About the BPM/MIDI SYNC function .....	248
<b>SW1/2 Assign</b> .....	249
SW1, SW2 Assign List .....	249
<b>Knob 1...4 B-Assign</b> .....	250
Realtime Control Knobs B-Assign List .....	250
<b>Foot Switch Assign</b> .....	251
Foot Switch Assign List .....	251
<b>Foot Pedal Assign</b> .....	252
Foot Pedal Assign List .....	252
<b>MIDI transmission when the TRITON STUDIO's controllers are operated</b> .....	253
<b>TRITON STUDIO operations when control changes are transmitted/received</b> .....	255
<b>MIDI applications</b> .....	258
■ About MIDI .....	258
■ Connecting MIDI devices/computers (MIDI connectors) .....	258
■ Messages transmitted and received by the TRITON STUDIO .....	259
<b>TRITON STUDIO MIDI IMPLEMENTATION</b> .....	269
<b>Various messages</b> .....	272
<b>Data compatibility</b> .....	279
<b>Disk mode information</b> .....	283
Chunks that are supported .....	283
About KORG format files .....	284
<b>Option boards/Memory/Calendar battery</b> .....	286
Please note when installing an option board/memory .....	286
Cautions when installing the calendar battery .....	286
About option boards/memory/calendar battery .....	287
Checking after installation .....	287
Installing an EXB-PCM .....	288
Installing a DRAM SIMM .....	290
Installing the EXB-MOSS .....	291
Installing the EXB-DI .....	292
Installing the EXB-mLAN .....	293
Installing the CDRW-1 .....	294

Replacing the calendar battery .....	297
<b>Connecting external SCSI devices</b> .....	298
<b>Packet writing support on the TRITON STUDIO</b> .....	299
<b>EXB-DI option</b> .....	300
<b>Index</b> .....	302

\* Company names, product names, and names of formats etc. are the trademarks or registered trademarks of their respective owners.



# 1. Program mode

## Program P0: Play

In this mode you can select and play programs.

**MIDI** All MIDI data in Program P0: Play is transmitted and received on the Global MIDI Channel "MIDI Channel" (Global P1: 1-1a).

### 0-1: Perf. Edit (Performance Edit)

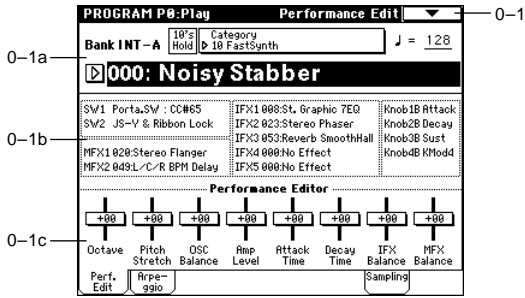

0-1a: Bank, Program Select, Category, 10's Hold, J

#### Bank (Bank Select)

[INT-A...INT-F, G, g(1)...g(9), g(d), EXB-A...EXB-G]

This is the program bank display.

Use the BANK [INT-A]-[EXB-G] keys to select the bank. Bank G will advance to the next G (or g) bank each time you press the [INT-G] key, as shown.  
 G → g(1) → g(2) → g(3) → g(4) → g(5) → g(6) → g(7) → g(8) → g(9) → g(d) → G

**note** Bank INT-F can be selected if you have installed the EXB-MOSS option. When installed, the 128 special EXB-MOSS programs will be available.

The TRITON STUDIO provides rewritable banks INT-A-INT-E and EXB-A-EXB-G, each containing 128 programs (total 1,536). As non-rewritable program areas, it provides banks G (basic programs for GM2), banks g(1)-g(9) (variation programs), and bank g(d) (drums). A list of the factory-set programs is provided in the separate booklet "VNL."

INT-A...INT-D	for preloaded programs
INT-E	User programs, such as programs that use multi-samples created in Sampling mode.
INT-F	for EXB-MOSS programs
G	GM2 basic program
g(1)-g(9)	GM2 variation programs*
g(d)	GM2 drums program
EXB-A...EXB-G	for user programs, and EXB-PCM series programs

\* For banks with no variation sounds, the GM basic sounds will be recalled. (An \* will be added at the beginning of the program name.)

#### Program Select

(INT-A...INT-F, EXB-A...EXB-G) 0...127, (G, g(1)...g(9), g(d)) 1...128

Here you can select a specific program. When this parameter is selected, you can select programs using the [Δ] [▽] keys, numeric keys [0]-[9], or [VALUE] dial.

When you press the **popup button**, the "Bank/Program Select" menu will appear. This displays programs by bank, and allows you to select a program.

**MIDI** You can receive MIDI program changes from a connected external MIDI device, or use a foot switch to select programs. ("Foot SW Assign" Global P2: 2-1a, "Foot Switch Assign List" p.251)

#### Bank/Program Select menu:

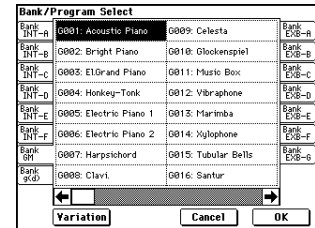

- Press the **popup button** at the left of "Program Select" to access the Bank/Program Select menu.
- Press one of the tabs at left or right to select a specific bank. If you select the GM bank, the **Variation button** will be enabled. Each time you press the **Variation button**, the bank will cycle in the order of G → g(1) → g(2) → ... → g(8) → g(9) → G.
- Select a program from the list. You can press the list to make a selection, or use the [Δ] [▽] keys.
- Press the **OK button** to execute, or press the **Cancel button** to cancel your selection.

#### Category

[00...15]

Selects the program category.

All programs are classified into one of sixteen categories. You can select the desired category, and then choose programs from that category. Press the popup button, and the "Category/Program Select" menu will appear.

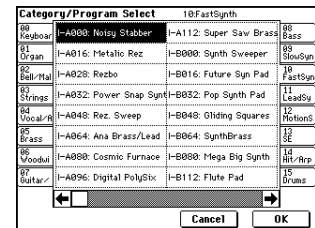

#### Category/Program Select menu:



- Press the **(category) popup button** above "Program Select" to access the Category/Program Select menu.
- Press one of the tabs at left or right to select the desired category.
- Select a program from the list. You can press the list to make a selection, or use the [Δ] [▽] keys.
- Press the **OK button** to execute, or press the **Cancel button** to cancel your selection.

The category setting of each program can be specified in the "Write Program" (0-1A) dialog box.

## 10's Hold

- 1 Press the [./10's HOLD] key to display . The 10's place of the program number will be held (fixed).
- 2 Now you can press any **numeric key [0]–[9]** to input the 1's place of the program number with a single keystroke.
- 3 You can use the [ $\Delta$ ] [ $\nabla$ ] keys to change the value of the 10's place.
- 4 To cancel, press the [./10's HOLD] key to turn off the  display.

## ♪ (Tempo) [040...240, EXT]

This sets the tempo of the arpeggiator. The tempo can also be adjusted by the ARPEGGIATOR [TEMPO] knob.

A display of **EXT** indicates that the "MIDI Clock" (Global P1: 1–1a) setting has been set to **External MIDI** or **External mLAN**, and that the arpeggiator will synchronize to MIDI Clock messages received from an external MIDI device.

---

## 0–1b: Program Information

This displays the functions that are assigned to the [SW1] and [SW2] keys and to the B mode of REALTIME CONTROL knobs [1], [2], [3], [4], and the names of the effects that are selected for the insertion effects and the master effects.

---

## 0–1c: Performance Editor

The Performance Editor lets you edit major program parameters without moving to the Program P1–P9 Edit pages. This allows you to adjust multiple program parameters within the currently selected program simultaneously, so you can make broad adjustments quickly and easily. You can use the **Performance Editor** when you wish to adjust the depth of effects while you are playing, or to make the initial rough settings to begin the process of creating a new sound.

If you wish to keep the results of your editing, you must write (save) the program (ⓂBG p.56).

 Editing done using the Performance Editor will occur within the range of the corresponding parameter. If after using the Performance Editor to modify a value, you move to another page or mode and then return, the sound will remain in its edited state but the value shown in the LCD screen by the Performance Editor will be +00. You may do further editing from this state if you wish.

Since editing done using the Performance Editor is not as detailed as conventional editing, the balance between parameters may be lost. If this occurs, use P1–P9 Edit page to make fine adjustments.

 If the "Enable Exclusive" (Global P1: 1–1b) setting is **checked**, MIDI exclusive parameter changes will be transmitted whenever you operate the Performance Editor. If these messages are received by a TRITON STUDIO whose "Enable Exclusive" setting is **checked**, the Performance Editor corresponding to that message will be modified.

## Octave [–03...+00...+03]

An adjustment of +01 will raise the pitch one octave. An adjustment of –01 will lower the pitch one octave. However, this setting cannot adjust the pitch higher than 4' (feet) or lower than 32' (feet).

## Pitch Stretch [–12...+00...+12]

This simultaneously adjusts the Transpose and Tune of the oscillator. This lets you produce a variety of tonal changes and variations without losing the character of the original sound.

At the +00 setting, the value of the program parameters will be unchanged.

An adjustment of +01 will lower the Transpose value by 1, and simultaneously raise the Tune value by 100.

An adjustment of –01 will raise the Transpose value by 1, and simultaneously lower the Tune value by 100.

However, it is not possible for the Transpose value to exceed the range of  $\pm 12$ , nor the Tune value to exceed the range of  $\pm 1200$ .

 This Performance Editor function cannot be used with **bank INT-F**.

## OSC Balance [–10...0...+10]

This adjusts the level balance between oscillators 1 and 2.

At the +00 setting, the value of the program parameters will be unchanged.

**Positive (+)** settings will lower the oscillator 2 level.

With an adjustment of +10, the oscillator 2 level will be 0. The oscillator 1 level will not change.

**Negative (–)** settings will lower the oscillator 1 level.

With an adjustment of –10, the oscillator 1 level will be 0. The oscillator 2 level will not change.

 For programs whose "Oscillator Mode" (1–1a) setting is **Single**, oscillator 2 will not sound. Only the level of oscillator 1 will change. For a **Drums** program, this performance editor will have no effect.

## Amp Level [–10...0...+10]

This adjusts the amp level.

With an adjustment of +00, the value of the program parameters will be unchanged.

**Positive (+)** settings will increase the amp level above the value that was set.

With an adjustment of +10, the amp level will be 127 (maximum).

**Negative (–)** settings will lower the amp level below the value that was set.

With an adjustment of –10, the amp level will be 0.

## Attack Time [–10...0...+10]

This adjusts the attack times of the filter EG and amp EG.

With an adjustment of +00, the value of the program parameters will be unchanged.

**Positive (+)** settings will lengthen the attack times beyond the values that were set.

With an adjustment of +10, the attack times will be 90.

**Negative (–)** settings will shorten the attack times.

With an adjustment of –10, the attack times will be 0.

 When you modify "Attack Time," the EG Start Level, Attack Level, Start Level Modulation, and Attack Time Modulation of the amp EG will also be adjusted simultaneously, to allow the maximum effect to be obtained.

## Decay Time [–10...0...+10]

This adjusts the Decay Time and Slope Time of the filter EG and amp EG.

With an adjustment of +00, the value of the program parameters will be unchanged.

**Positive (+)** settings will lengthen the Decay Time and Slope Time beyond the values that were set. With an adjustment of +10, the times will be 99.

**Negative (–)** settings will shorten the Decay Time and Slope Time. With an adjustment of –10, the times will be 0.

**IFX Balance** [-10...0...+10]

This adjusts the “Wet/Dry” setting of insert effects 1–5 as a whole.

With an adjustment of +00, the value of the program parameters will be unchanged.

**Positive (+)** settings will raise the Wet levels above the program setting, and lower the Dry levels. With an adjustment of +10, the setting will be “Wet.”

**Negative (-)** settings will lower the Wet levels below the program setting, and raise the Dry levels. With an adjustment of -10, the setting will be “Dry.”

**MFX Balance** [-10...0...+10]

This adjusts the master effect “Return 1” and “Return 2” (9–1b) settings as a whole.

With an adjustment of +00, the value of the program parameters will be unchanged.

**Positive (+)** settings will raise the return levels above the program setting.

With an adjustment of +10, the setting will be 127 (maximum).

**Negative (-)** settings will lower the return levels below the program setting.

With an adjustment of -10, the setting will be 0.

Octave	Octave of OSC 1/2
Pitch Stretch	Transpose and Tune of OSC 1/2
OSC Balance	High Multisample, Low Multisample Level of OSC 1/2
Amp Level	Amp1 Level, Amp2 Level
Attack Time	Amp EG Attack Time, Start Level, Attack Level, Level Modulation St, Time Modulation At of Amp 1/2, and Filter EG Attack Time of Filter 1/2
Decay Time	AmpEG Decay Time, Slope Time of Amp 1/2; Filter EG Decay Time and Slope Time of Filter 1/2
IFX Balance	Wet/Dry balance of the IFX1/2/3/4/5 effects
MFX Balance	Master Effect Return 1, 2

 For the INT-F bank programs that can be used when the EXB-MOSS option is installed, different program parameters will be adjusted. (see EXB-MOSS owner’s manual)

▼ 0–1: Page Menu Command

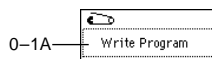

0–1A: Write Program

This command writes the edited program into the internal memory.

If you wish to save a program, be sure to write it into memory. An edited program cannot be recovered if you do not write it before turning off the power or selecting another program.

- ① Select “Write Program” to access the dialog box.

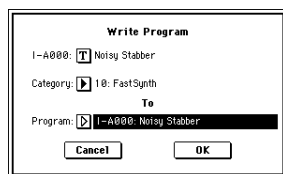

- ② The upper line shows the bank and program name. If you wish to modify the program name, press the **text edit button** to move to the text edit dialog box, and input the desired program name.
- ③ In “Category,” specify the category of the program that you are writing.

With the factory settings, the program categories have been given the names of instruments etc., but you can use “Program Cat.” (Global P4: 4–1) to modify these category names. The category selected here can be used to find this program when selecting a program in Program, Combination, Sequencer, or Song Play modes.

- ④ Press “To Program” to specify the writing destination.

**note** You can also use the BANK [INT-A]–[EXB-G] keys to select a bank.

 It is not possible to write to banks G–g(d). If you have edited a program from banks G–g(d) and wish to write it, you must write to banks INT-A–INT-E or EXB-A–EXB-G.

- ⑤ To execute the Write Program operation, press the **OK button**. To cancel, press the **Cancel button**.

**note** You can also press the SEQUENCER [REC/WRITE] to write a program in the same way as “Write Program.” Press the SEQUENCER [REC/WRITE] key to access the dialog box, and write the program. In this case, the settings will be written to the currently selected program.

0–2: Arpeggio

Arpeggiator parameters are edited in P7: Edit-Arpeggiator, but major parameters can be edited here as well. When you are playing in Program P0: Play, you can edit the arpeggiator in realtime, such as changing the arpeggio pattern etc. To write (save) the results of your editing, use “Write Program” or “Update Program.” You can also use the [TEMPO], [GATE], and [VELOCITY] knobs to edit the arpeggio in realtime (see BG p.29, 30).

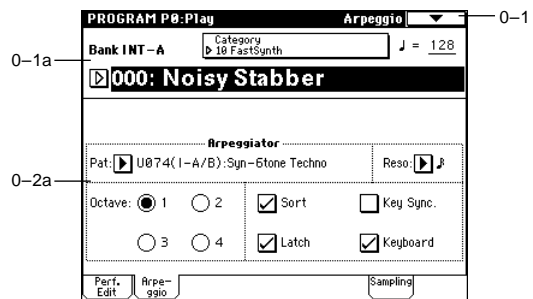

0–2a: Arpeggiator

- Pat (Pattern) [P000...P004, U000(I-A/B)...U506(User)]
- Octave [1, 2, 3, 4]
- Reso (Resolution) [1/3, 1/2, 2/3, 1, 3/2, 2]
- Sort [Off, On]
- Latch [Off, On]
- Key Sync. [Off, On]
- Keyboard [Off, On]

Make settings for the program arpeggiator (see P7: Edit-Arpeggiator).

**note** These parameters can also be set from P7: Edit-Arpeggiator.

## 0-3: Sampling

Here you can adjust the settings for the analog/digital audio signal input (AUDIO INPUT, S/P DIF, EXB-mLAN), and the settings related to sampling in Program mode.

You can sample either an external audio signal, or a performance played on the TRITON STUDIO.

When sampling in Program mode, you can listen to the performance of the TRITON STUDIO's arpeggiator etc. while only sampling the external audio signal via the AUDIO INPUT jacks or S/P DIF jacks; or you can resample while you play a program using the TRITON STUDIO's filters, effects, and arpeggiator. You can also mix a performance on the TRITON STUDIO with an external audio signal, and sample the result. (P.45)

**note** "Resampling" refers to the process of sampling an external audio signal, processing this sampled wave data in the digital domain using effects etc., playing it, and then once again sampling the resulting performance.

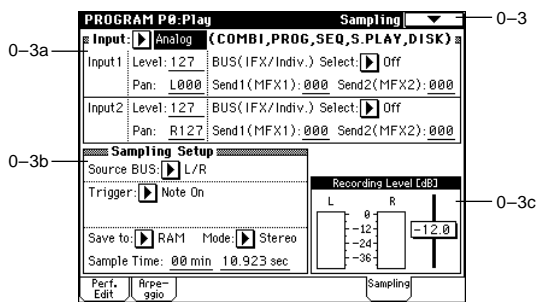

### 0-3a: Input (COMBI, PROG, SEQ, S.PLAY, DISK)

**Input** [Analog, S/P DIF, mLAN]  
**Input1:**  
**Input2:**  
**Level** [0...127]  
**Pan** [L000...C064...R127]  
**BUS(IFX/Indiv.) Select**  
 [L/R, IFX1...5, 1, 2, 3, 4, 1/2, 3/4, Off]  
**Send1(MFX1), Send2(MFX2)** [000...127]

Here you can specify the input source analog/digital audio device, and set the input level, pan, bus, and master effect sends.

**note** These *Input* settings are valid in Combination, Program, Sequencer, Song Play, and Disk modes. (P.45 Global P0: 0-3a)

### 0-3b: Sampling Setup

**Source BUS** [L/R, Indiv.1/2]  
 Selects the source that you want to sample. The sound being sent to the bus selected here will be sampled.  
**L/R:** The sound sent to the L/R bus will be sampled. This lets you sample an external audio signal sent to the L/R bus (specified by "Input" 0-3a), or the sounds sent to the L/R bus from a performance played on the TRITON STUDIO from its keyboard or via MIDI input.  
**Indiv. 1/2:** The sound sent to the INDIVIDUAL 1, 2, 1/2 buses will be sampled.

This lets you sample an external audio signal sent to buses 1, 2, 1/2 (specified by "Input" 0-3a), or the sounds sent to the INDIVIDUAL 1, 2, 1/2 buses from a performance played on the TRITON STUDIO from its keyboard or via MIDI input.

Normally when you want to sample a performance in Program mode, you will select L/R.

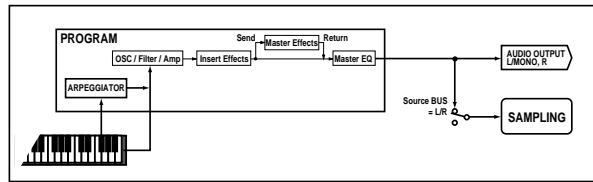

Select L/R if you want to mix a Program mode performance (e.g., drum patterns played by the arpeggiator) with external audio from AUDIO INPUT (or S/P DIF or EXB-mLAN), and sample them together. In this case, set *Input* "BUS (IFX/Indiv.) Select" (0-3a) to L/R so that the external audio signal will be sent to the L/R bus.

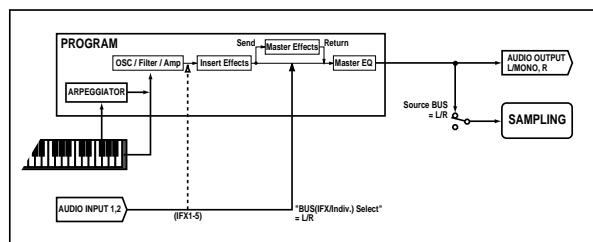

Select **Indiv.1/2** if you want to monitor your playing in Program mode while sampling only an external audio signal from AUDIO INPUT (or S/P DIF or EXB-mLAN). In this case, set *Input* "BUS (IFX/Indiv.) Select" (0-3a) to 1, 2, or 1/2 so that the external audio signal will be sent to the INDIVIDUAL 1, 2, or 1/2 buses.

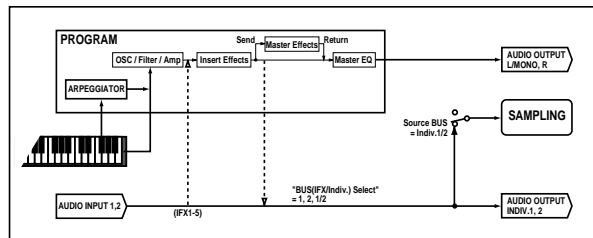

**Trigger** [Sampling START SW, Note On]

This specifies how sampling will begin.

**Sampling START SW:** The TRITON STUDIO will enter sampling-standby mode when you press the SAMPLING [REC] key. Sampling will begin when you press the SAMPLING [START/STOP] key.

**Note On:** The TRITON STUDIO will enter sampling-standby mode when you press the SAMPLING [REC] key and then press the SAMPLING [START/STOP] key. Sampling will begin when you play the keyboard.

**note** Sampling will also begin if a MIDI note-on is received.

To stop sampling in either case, press the SAMPLING [START/STOP] key once again. Alternatively, sampling will stop automatically when the specified "Sample Time" is reached.

For details on the procedure, refer to p.97.

**Metronome Precount** [Off, 4, 8, 3, 6]

This specifies whether the metronome will sound a count-down when you begin sampling with the “Trigger” setting **Sampling START SW**.

This can be set only if “Trigger” is set to **Sampling START SW**.

**Off:** When you press the SAMPLING [START/STOP] key from recording-standby mode, sampling will begin immediately.

**4, 8, 3, 6:** When you press the SAMPLING [START/STOP] key from recording-standby mode, the specified number of beats will be counted at the “♪ (Tempo)” (0-1a) tempo before sampling will begin. If this is set to **4**, sampling will begin on the count of 0 after a count-down of 4-3-2-1-0.

 The output destination and level of the metronome sound are specified by the page menu command “**Metronome Setup**” (0-3A). If “**BUS (Output) Select**” is set to **L/R**, the metronome will stop sounding the instant sampling begins.

**Save to** [RAM, DISK]

Specifies the destination to which the data will be written during sampling.

**RAM:** Sample into sample memory (RAM).

If you sample into sample memory (RAM), you will be able to immediately hear the sample in Program mode or Sampling mode.

Settings for the writing destination RAM Bank and Sample No., and settings for automatically converting the sample to a program, are made by the page menu command “**Select Bank & Smpl No.**” (0-3C).

 If the sample is written into RAM, it will be lost when the power is turned off, so you will need to save the sample if you want to keep it.

**DISK:** Samples to the internal hard drive or to an external hard drive connected to the SCSI connector.

A WAVE file will be created when you sample.

To listen to the sampled result, you can either load the sample into sample memory (RAM) in Disk mode, or use the page menu command “**Select Directory**” (0-3D) etc. to select the file and then press the SAMPLING [START/STOP] key. Use the page menu command “**Select Directory**” to specify the writing-destination drive, directory, and filename.

 A single sample (WAVE file) loaded from hard disk into sample memory (RAM) may not exceed 16 MB for mono or 32 MB for stereo (however, sample memory must be expanded to 32 MB or more).

 It is not possible to sample directly to CD-R/RW. Also, we do not recommend sampling to a removable disk.

**Mode (Sample Mode)** [L-Mono, R-Mono, Stereo]

Selects the channel(s) that will be sampled, to specify whether the sample created will be mono or stereo.

The sound being sent to the internal L and/or R bus or the internal Indiv.1 and/or 2 bus selected by the “**Source BUS**” (0-3b) setting will be sampled.

**L-Mono:** The internal **L** channel or internal **Indiv.1** channel (as specified by “**Source BUS**”) will be sampled in mono.

**R-Mono:** The internal **R** channel or internal **Indiv.2** channel (as specified by “**Source BUS**”) will be sampled in mono.

**Stereo:** The internal **L** and **R** channels or internal **Indiv.1** and **2** channels (as specified by “**Source BUS**”) will be sampled in stereo. This will create a stereo sample. (≡Sampling P0: 0-1c)

**Sample Time** [min sec]

Specifies the length of time that you want to sample. This can be set in units of minutes and 0.001 second.

This parameter indicates amount of remaining memory in the selected memory bank (the available sampling time). If you sample in this state ([REC]→[START]→[STOP]), this display will change automatically to indicate the remaining time.

If you have enough free space in sample memory (RAM), it is a good idea to set “Sample Time” generously, and then after recording the sample, use the page menu command “**Truncate**” (Sampling P1: 1-1A, P2: 2-1A) to delete the unneeded portion, making the sample as compact as possible. You can also stop recording by pressing the SAMPLING [START/STOP] key manually after the desired portion has been sampled. (Sampling methods ≡BG p.45)

If the writing-destination (“**Save to**”) is **RAM**, the maximum value will be calculated from the amount remaining in the selected Bank. (≡Sampling P0: 0-1c “**Bank (RAM Bank)**”) If the writing-destination (“**Save to**”) is **DISK**, the maximum value will be calculated from the remaining capacity of the disk specified by “**Select Directory**.” A maximum of 80 minutes can be sampled in one sample file for either mono or stereo (monaural: approximately 440 MB, stereo: approximately 879 MB).

 If the writing-destination (“**Save to**”) is **RAM**, leaving “**Auto Optimize RAM**” (Global P0: 0-3b) **unchecked** will allow wasted space to increase, decreasing the available sample memory (RAM). In this case, execute the page menu command “**Optimize RAM**” to eliminate the wasted space.

The remaining amount of RAM can be checked in Sampling mode P0: Recording, Memory Status.

 The various *Sampling Setup* settings apply to the entire Program mode, not just to an individual program.

**0-3c: Recording Level [dB]****ADC OVERLOAD !!**

The “ADC OVERLOAD !!” indication will appear if the signal level from AUDIO INPUT 1, 2 is too high. In this case, adjust the [LEVEL] knob or the output level of the external audio source. (≡Sampling P0: 0-1d “**Recording Level [dB]**”)

**Recording Level** [-inf, -72.0...0.0...+18.0 dB]

Adjusts the signal level at the final stage of sampling (≡Sampling P0: 0-1d). Sample at the highest level that does not make the level meter indicate CLIP.

 Adjusting the “**Recording Level**” will not change the sound that is output, but will affect the data that is being sampled. This means that the sampled sound may be distorted even if the sound you hear is not distorted.

This setting defaults to -12 dB when you turn on the power. At a setting of -12 dB, CLIP will not appear even if you play the program at its maximum level.

 The “+12 dB” (Sampling P2: 2-1c) setting is applied to samples that you recorded into sample memory (RAM) when “**Save to**” (0-3b) is set to **RAM**. When “+12 dB” is on, the playback level will increase by approximately +12 dB.

If you check the “Auto +12 dB On” check box in the page menu command “**Select Bank & Smpl No.**” (0-3C), the “+12 dB” setting will automatically be turned on during sampling.



**note** The “Auto +12 dB On” setting will not affect samples that you recorded to the internal hard disk etc. when “Save to” (0-3b) is set to **DISK**. You can use “WAVE File Play Level” (Global P0: 0-2a) to set the playback level.

### ▼ 0-3: Page Menu Command

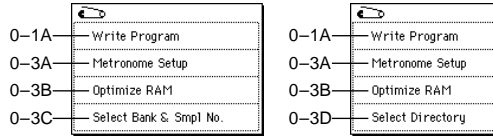

#### 0-3A: Metronome Setup

Specifies the output destination and volume of the metronome that is sounded when you use “Trigger” Sampling START SW to begin sampling.

- 1 Select “Metronome Setup” to access the dialog box.

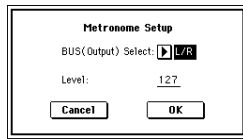

- 2 In “BUS (Output) Select,” specify the output destination of the metronome sound. If you select **L/R**, the metronome will stop as soon as sampling begins.
- 3 Set “Level” to specify the volume of the metronome.
- 4 Press the **OK** button to apply the settings you made, or press the **Cancel** button to return to the state prior to accessing this dialog box.

**▲** The metronome is valid only if “Trigger” is set to **Sampling START SW**.

#### 0-3B: Optimize RAM

This command optimizes the sample memory (RAM). When you execute this command, unused memory areas will be reorganized, allowing the full amount of remaining to be used. If you run out of memory, try executing “Optimize RAM.” The remaining amount of RAM can be checked in Sampling mode P0: Recording, Memory Status.

- 1 Select “Optimize RAM” to access the dialog box.

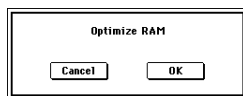

- 2 Press the **OK** button to execute the command, or press the **Cancel** button to cancel without executing.

**note** If “Auto Optimize RAM” (Global P0: 0-3b) is **checked**, RAM will be optimized automatically.

#### 0-3C: Select Bank & Smpl No.

Specifies the RAM bank and sample number into which the sampled data will be written. You can also specify whether the sample will automatically be converted to a program after sampling. “Select Bank & Smpl No.” can be selected if you have selected **RAM** as the “Save to” destination.

- 1 Select the “Select Bank & Smpl No.” to access the dialog box.

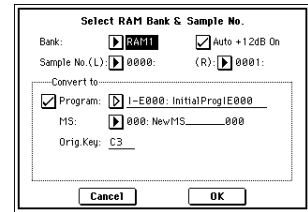

- 2 In “Bank,” specify the sample memory (RAM) bank to which the sampled data will be written.
- 3 In “Sample No.,” specify the writing-destination sample number. By default, this will be the lowest-numbered vacant sample number. If you select “---:---:No Assign---” or a sample number that already contains data, the data will automatically be sampled into the lowest vacant sample number. If you are sampling in stereo, specify “Sample No.(L)” and “Sample No.(R).”
- 4 Set “Auto +12 dB On.”

**On (checked):** “+12 dB” (Sampling P2: 2-1c) will automatically be turned on for samples you record. Samples for which “+12 dB” is on will play back approximately +12 dB louder than if this setting were off.

When you resample a performance in Program, Combination, or Sequencer modes, you should normally set “Recording Level” to about **-12.0 (dB)** so that the recording level will be as high as possible without clipping. When you resample, the sound will be recorded at the optimum level for sampled data, but the playback level at playback will not be as loud as it was during the resampling process (if “+12 dB” (Sampling P2: 2-1c) is off). In such cases, you can check the “Auto +12 dB On” check box when you resample, so that “+12 dB” (Sampling P2: 2-1c) will automatically be **on**, making the sample play back at the same level as when it was resampled. In these modes, the power-on defaults are “Recording Level” set to **-12.0 (dB)** and “Auto +12 dB On” turned on. If you resample a performance in one of these modes with these settings, the sample will play back at the same level at which it was resampled.

**note** If you want to monitor your performance in Program, Combination, or Sequencer mode while sampling only the external audio signal from AUDIO INPUT etc. (the “Source BUS” **Indiv.1/2 setting:** 0-3b), we recommend that you set “Recording Level” to about **+0.0 (dB)** and turn off “Auto +12 dB On” when you resample.

**note** The “Auto +12 dB On” setting is made independently for Program, Combination, Sequencer, and Sampling modes.

- 5 “Convert to” specifies whether the sample will automatically be converted into a program as soon as it has been sampled. This is convenient when you want to hear the sound immediately after sampling. If you **check** the “Program” check box, the sample will automatically be converted into a program. At the right, set “Program” and “MS” to specify the program number and multisample number for the converted program. Set “Orig. Key” (Sampling P0: 0-1b) to specify the location of the original key. The multisample will create an “Index” (Sampling P0: 0-1a) with this key as the “Top Key” (Sampling P0: 0-1b). The “Orig. Key” will increment by one after sampling, and the next higher note will be assigned the next time you sample.
- 6 Press the **OK** button to apply the settings you made, or press the **Cancel** button to return to the state prior to accessing this dialog box.

### 0-3D: Select Directory

This lets you select the disk (internal hard disk, etc.) and directory on which the WAVE file created by sampling will be saved, and specify a filename.

You will also choose this “Select Directory” command when you want to listen to a WAVE file that was saved on disk.

“Select Directory” can be selected when “Save to” is set to **DISK**.

Specifying the save destination for a WAVE file

- 1 Select the “**Select Directory**” to access the dialog box.

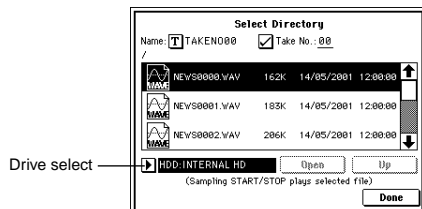

- 2 Use the popup button located at the left of “**Drive select**” to select the writing-destination drive for sampling.
- 3 Use the **Open button** and **Up button** to move to the desired directory.
- 4 In “**Name**,” specify a name for the WAVE file that will be written during sampling.  
If you check “**Take No.**,” the file will be saved with a two-digit “Take No.” added to the end of the filename. This number will automatically increment each time you sample. This is convenient when you are sampling repeatedly, since each sample will be saved with its own filename.  
If “Take No.” is not checked, you can input up to eight characters in “Name.” If “Take No.” is checked, you can input up to six characters.
- 5 Press the **Done button** to complete the settings.

Playing back a WAVE file

- 1 Select the “**Select Directory**” to access the dialog box.
- 2 Use “**Drive Select**” and the **Open** and **Up** buttons to select the drive and directory, and select the WAVE file (44.1 kHz or 48 kHz) that you want to play.
- 3 Press the SAMPLING [START/STOP] key.  
The selected WAVE file will be played.
- 4 Press the SAMPLING [START/STOP] key once again to stop playback.

If the WAVE file is mono, the same sound will be output to L/R.

While the WAVE file is playing back, sound cannot be produced by playing the keyboard or receiving note data at MIDI IN. Also, the arpeggiator will stop.

## Program P1: Edit-Basic

Here you can make basic settings for the program, such as oscillator mode and scale type.

### 1-1: Program Basic

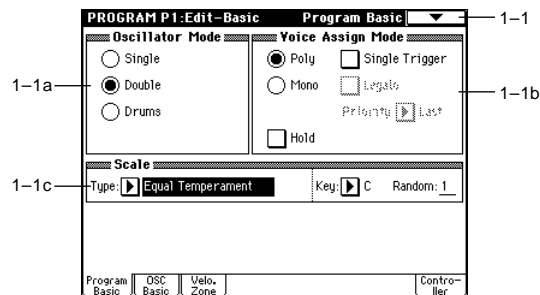

#### 1-1a: Oscillator Mode

**Oscillator Mode** [Single, Double, Drums]

Specifies the Program’s oscillator assignment; whether it will use one or two oscillators, or a drum kit.

**Single:** The program will use **one oscillator** (Oscillator 1, Filter 1, Amplifier 1). In this case the program will normally have a **maximum of 60-note polyphony**.

**Double:** The program will use **two oscillators** (Oscillator 1/2, Filter 1/2, Amplifier 1/2). In this case the program will normally have a **maximum of 30-note polyphony**.

**Drums:** The program will use **one oscillator** (as when Single is selected), but Oscillator 1 will be assigned a drum kit instead of a multisample. In this case the program will normally have a **maximum of 60-note polyphony**.

**note** If a program draws one multisample from the ROM bank, and a second from either the Piano bank or one of the installed EXB boards, then in this case, a **Single** program can have a **maximum of 120-note polyphony**, a **Double** program a **maximum of 60-note polyphony**, and a **Drums** program a **maximum of 120-note polyphony**. (BG p.15)

#### 1-1b: Voice Assign Mode

**Mode (Voice Assign Mode)** [Poly, Mono]

**Poly:** The program will play polyphonically, allowing you play chords.

**Mono:** The program will play monophonically, producing only one note at a time.

**Single Trigger** [Off, On]

This is available when the “**Mode (Voice Assign Mode)**” setting is set to **Poly**.

**On (checked):** When the same note is played repeatedly, the previous note will be silenced before the next note is sounded, so that the notes do not overlap.

**Legato** [Off, On]

This is available when the “**Mode (Voice Assign Mode)**” setting is set to **Mono**.

**On (checked):** Legato is on. When multiple note-on’s occur, the first note-on will retrigger the sound, and the second and subsequent note-on’s will not retrigger.

When legato is on, multiple note-on message will not retrigger the voice. If one note is already on and another note is turned on, the oscillator sound, envelope, and LFO will not be reset, and only the pitch of the oscillator will be updated. This setting is effective for wind instrument sounds and analog synth-type sounds.

**Off (unchecked):** Legato is off. Notes will always be retriggered when note-on occurs.

When legato is off, multiple note-on's will retrigger the voice at each note-on. The oscillator sound, envelope, and LFO will be reset (and retriggered) according to the settings of the program.

⚠ If "Legato" is checked, certain multisamples or keyboard locations may produce an incorrect pitch.

### Priority [Low, High, Last]

This parameter is valid when "Mode (Voice Assign Mode)" is set to **Mono**.

It specifies which note will be given priority to play when two or more notes are played simultaneously.

**Low:** Lowest note will take priority.

**High:** Highest note will take priority.

**Last:** Last note will take priority.

### Hold [On, Off]

**On (checked):** Hold is **On**. Even when you take your finger off of the key, the note will continue sounding as if it continued to be held. Unless the *Amp1 EG*, *Amp2 EG* (4-3a, 4-6) "Sustain (Sustain Level)" is set to **0**, the sound will continue playing.

This is ideal for playing drum programs, and when you set "Oscillator Mode" (1-1a) to **Drums**, you should turn **On**.

**Off (unchecked):** Hold is **Off**. Except for drum programs, you should normally set **Off**.

⚠ If you turn "Hold" **On** for a drum program, keys of the selected drum kit whose "Enable Note Off Receive" parameter (Global P5: 5-2a) is unchecked will be set to **Hold On**. Keys that are checked will be set to **Hold Off**. If you select **Hold Off**, the keys will be set to **Hold Off** regardless of their "Enable Note Off Receive" setting.

## 1-1c: Scale

### Type [Equal Temperament...User Octave Scale15]

Selects the basic scale for the internal tone generator.

**Equal Temperament:** This is the most widely used scale, where each semitone step is spaced at equal pitch intervals.

**Pure Major:** In this temperament, major chords of the selected tonic will be perfectly in tune.

**Pure Minor:** In this temperament, minor chords of the selected tonic will be perfectly in tune.

**Arabic:** This scale includes the quarter-tone scale used in Arabic music.

**Pythagoras:** This scale is based on ancient Greek musical theory, and is especially effective for playing melodies.

**Werkmeister (Werkmeister III):** This is an equal tempered scale that was used since the later Baroque period.

**Kirnberger (Kirnberger III):** This scale was created in the 18th century, and is used mainly to tune harpsichords.

**Slendro:** This is an Indonesian gamelan scale in which an octave consists of five notes.

When "Key" is set to **C**, use the C, D, F, G and A notes. (Other keys will sound equal-tempered pitches.)

**Pelog:** This is an Indonesian gamelan scale in which an

octave consists of seven notes.

When "Key" is set to **C**, use the white keys. (The black keys will sound the equal tempered pitches.)

**Stretch:** This tuning is used for acoustic pianos.

**User All Notes Scale:** This is the full-range scale (C-1 - G9) that was specified in "User All Notes Scale" (Global P3: 3-1b).

**User Octave Scale 00-15:** These are the single-octave scales that were specified in "User Octave Scale" (Global P3: 3-1a).

### Key (Scale Key) [C...B]

Selects the tonic note of the specified scale.

This setting is not valid for **Equal Temperament**, **Stretch**, and **User All Notes Scale**.

### Random [0...7]

As this **value is increased**, a greater variance will be applied to the pitch when each note is sounded. Normally you will set this to **0**. This parameter is used when simulating instruments that have natural instability in pitch, such as tape-mechanism organs or acoustic instruments.

⚠ If a scale other than Equal Temperament is selected, the combination of the selected scale and the "Key" setting may skew the tuning of the base key (for example A=440 Hz). If this occurs, use "Master Tune" (Global P0: 0-1a) to correct the pitch.

## ▼ 1-1: Page Menu Command

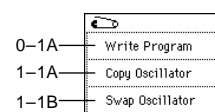

### 1-1A: Copy Oscillator

This command is used to copy the settings from one oscillator to another.

① Select "Copy Oscillator" to access the dialog box.

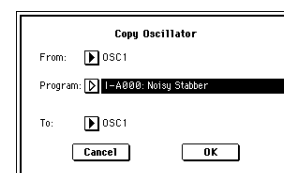

② In "From" specify the oscillator to copy, and in "Program" specify the bank and number of the copy source program. You can use the Bank [INT-A]-[EXB-G] keys to select the bank.

③ In "To," specify the copy destination oscillator.

④ To execute the Copy Oscillator command, press the **OK button**. To cancel, press the **Cancel button**.

### 1-1B: Swap Oscillator

This command exchanges the settings of oscillators 1 and 2.

① Select "Swap Oscillator" to access the dialog box.

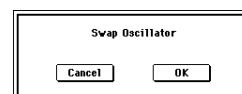

② To execute the Swap Oscillator command, press the **OK button**. To cancel, press the **Cancel button**.

**note** This can be selected only if "Oscillator Mode" (1-1a) is **Double**.

## 1-2: OSC Basic

The multisample(s) (waveform) or drum kit on which the program will be based can be selected here for oscillator 1 and/or oscillator 2.

Internal ROM contains **429 (425: ROM + 4: Piano)** different multisamples (preset multisamples) and **153** drum kits. By selecting a RAM multisample, you can use a multisample that you created in Sampling mode or that you loaded in Disk mode. If any of the EXB-PCM series options have been installed, you will be able to select from among their multisamples as well. The following illustration shows a LCD screen where "Oscillator Mode" (1-1a) has been set to **Double**. If this is set to **Single**, the *OSC2 Multisample* (1-2b) will not appear and cannot be set.

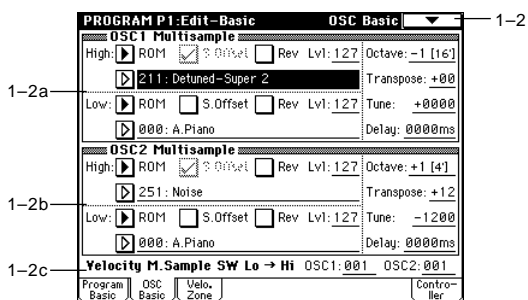

The following illustration shows the display when "Oscillator Mode" (1-1a) has been set to **Drums**.

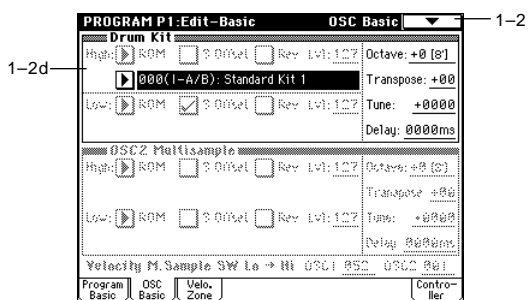

### 1-2a: OSC1 Multisample

Here you can select a multisample. You can select different multisamples for High and Low, and use velocity to switch between the two multisamples. Start Offset, Reverse, and Level can be adjusted independently for the High and Low multisamples.

**High:**

**High MS Bank** [ROM, RAM, Piano, EXB\* ...]  
**High Multisample** [000...424, 000...999, 000...003, 000...]

Specifies the bank and multisample number of the High multisample. The multisample you select here will be sounded by velocities greater than the value of the "Velocity M. Sample SW Lo→Hi" (1-2c) parameter "OSC1." If you do not wish to use velocity switching, set "OSC1" to a value of **001**, and select only the **High** multisample.

**ROM:** Selects a preset multisample. Use "High Multisample" to select from **000-424**.

**RAM:** Selects a multisample that you created in Sampling mode or that you loaded in Disk mode. Use "High Multisample" to select from **000-999**.

**Piano:** You can select preset multisamples such as stereo piano. Choose from **000-003** for the "High Multisample."

**EXB\*:** Multisamples from EXB-PCM series option boards can be selected. "\*" will indicate the type of installed option. The multisample number for "High Multisample" will depend on which EXB-PCM options have been installed.

- ▲ The **EXB\*** display will differ depending on the type of option board.
- ▲ If a program that uses a multisample from an EXB-PCM series board is selected, but the corresponding EXB-PCM (expansion board) is not installed, the "High MS Bank" field will indicate **ROM**. In this case, the program will not sound. By re-selecting the multisample bank, you can make the program sound.
- ▲ Each multisample has an upper limit, and may not produce sound when played above that limit.

When you press the "High Multisample" popup button, a multisample list will appear, allowing you to select a multisample from the list.

If **ROM** is selected as the "High MS Bank," you can select a multisample from a tabbed list organized by type of instrument.

Category/ROM Multisample Select menu:

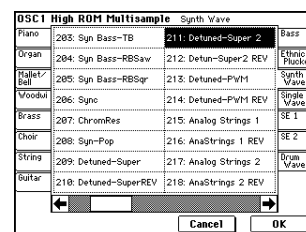

**S.Offset (High Start Offset)** [Off, On]

This specifies the point at which the multisample will begin sounding. For some multisamples this parameter will have no effect.

**On (checked):** The sound will start from the start offset location that is pre-determined for each multisample.

However when a RAM bank is selected, this will depend on the selected multisample. If you select a multisample that includes one of the following types of sample, checking this item will cause playback to start from the Loop Start Address.

- A sample that was recorded (sampled) in Sampling mode
- A sample whose Loop Start Address was edited in Sampling mode after the sample was loaded in Disk mode
- A sample whose Loop Start Address was specified automatically when it was loaded as an AKAI, AIFF, or WAVE file in Disk mode

**Off (unchecked):** The sound will start from the beginning of the multisample waveform.

**Rev (High Reverse)** [Off, On]

The multisample will be played in reverse. In the case of ROM or optional (EXB-PCM series) multisamples that were originally specified to loop, or in the case of multisamples that were set to loop in Sampling mode, the multisample will be played back in "one-shot" reverse mode. If the multisample was originally set to reverse, it will playback without change.

**On (checked):** The multisample will playback in reverse.

**Off (unchecked):** The multisample will playback normally.

Lvl (High Level) [000...127]

Specifies the level of the multisample.

⚠ Depending on the multisample, high settings of this parameter may cause the sound to distort when a chord is played. If this occurs, lower the level.

**note** The playback level for a RAM multisample is also affected by the "+12 dB" (Sampling P2: 2-1c) setting for each sample. If the "+12 dB" setting is on, the playback will be approximately +12 dB louder. (☞0-3C)

#### Low:

Here you can assign the Low multisample for OSC1. The multisample you select here will be sounded by velocities less than the value of the "Velocity M.Sample SW Lo→Hi" (1-2c) parameter "OSC1."

Low MS Bank [ROM, RAM, Piano, EXB\* ...]

Low Multisample [000...424, 000...999, 000...003, 000...]

S.Offset (Low Start Offset) [Off, On]

Rev (Low Reverse) [Off, On]

Lvl (Low Level) [000...127]

☞ For details on the "Low" parameters, refer to the explanations for the corresponding "High" parameters.

Octave [-2[32'], -1[16'], +0[8'], +1[4']]

Adjusts the pitch in octave units. The normal octave of the multisample is pitched at 8' (feet).

Transpose [-12...+12]

Adjusts the pitch in semitone steps over a range of ±1 octave.

Tune [-1200...+1200]

Adjusts the pitch of the sample in one-cent steps (a semitone is 100 cents) over a range of ±1 octave.

Delay [0ms...5000ms, KeyOff]

Specifies a delay time from note-on until the note will sound. With a setting of **KeyOff**, the sound will begin when note-off occurs. This is used to create sounds such as the "click" that is heard when a harpsichord note is released. In this case, set the *Amp1 EG*, *Amp2 EG* (4-3a, 4-6) "**Sustain**" parameter to 0.

### 1-2b: OSC2 Multisample

This will appear when "**Oscillator Mode**" (1-1a) is set to **Double**.

For details on the settings and function of the parameter, refer to "1-2a: OSC1 Multisample."

### 1-2c: Velocity M.Sample SW Lo → Hi (Velocity Multisample Switch Low → High)

OSC1 (OSC1 Velocity Switch) [1...127]

The High and Low multisamples selected for oscillator 1 in "**OSC 1 Multisample**" (1-2a) will be switched at the velocity value that you specify here. Notes played with a velocity stronger than this value will be sounded by the High multisample.

OSC2 (OSC2 Velocity Switch) [1...127]

This will appear when "**Oscillator Mode**" (1-1a) is set to **Double**.

The High and Low multisamples selected for oscillator 2 in "**OSC 2 Multisample**" (1-2b) will be switched at the velocity value that you specify here.

Notes played with a velocity stronger than this value will be sounded by the High multisample.

### 1-2d: Drum Kit

Drum Kit [000(I-A/B)...143(User), 144(GM)...152(GM)]

Selects a drum kit.

000(I-A/B)–015(I-A/B)	Preloaded drum kits
16(E-A)–31(E-A)	User drum kits EXB-PCM series drum kits
32(E-B)–47(E-B)	
48(E-C)–63(E-C)	
64(E-D)–79(E-D)	
80(E-E)–95(E-E)	
96(E-F)–111(E-F)	
112(E-G)–127(E-G)	User drum kits (some preloaded drum kits)
128(User)–143(User)	
144(GM)–152(GM)	ROM preset drum kits compatible with GM2

Octave [-2[32'], -1[16'], +0[8'], +1[4']]

Adjusts the pitch in octave units. When using a drum kit, set the Octave to 8'.

⚠ When editing a drum program, you must set this parameter to 8'. With other settings, the sounds of the drum kit will be assigned to the wrong notes of the keyboard.

Transpose [-12...+12]

This adjusts the location of the instruments in the selected drum kit. Unless you need to change this, leave it at 0.

Tune [-1200...+1200]

This adjusts the pitch in one-cent units. The pitch of each drum kit can be adjusted in Global P5: Drum kit.

Delay (Delay Time) [0ms...5000ms, KeyOff]

This specifies a delay time from note-on until the sound will begin. With a setting of **KeyOff**, the sound will begin when note-off occurs. In this case, set the *Amp EG* (4-3a) parameter "**Sustain**" to 0.

### ▼ 1-2: Page Menu Command

0-1A	Write Program
1-1A	Copy Oscillator
1-1B	Swap Oscillator
1-2A	Sample Parameters

### 1-2A: Sample Parameters

Specifies the sample for each index of a RAM multisample. You can adjust the playback level, cutoff, resonance, pitch, attack, and decay.

**note** This can be selected if "**Oscillator Mode**" (1-1a) is **Single** or **Double**, and RAM is selected as the "**High MS Bank**" or "**Low MS Bank**" for OSC1 Multisample or OSC2 Multisample and "**High Multisample**" or "**Low Multisample**" are selected.

⚠ These settings are made for the selected multisample. If another oscillator or program uses that multisample, that oscillator or program will also be affected by the changes you make here.

- 1 Select "Sample Parameters" to access the dialog box.

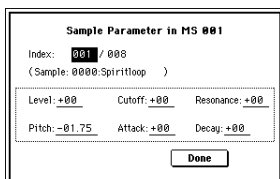

- 2 **Index:** Specify the index for which you wish to make settings. The number following "/" is the total number of indexes in the selected multisample.

**Sample:** indicates the sample number and name for the index.

- 3 For each index, you can make the following settings.
 

**Level:** Adjust the volume. Relative to the settings of "Lvl" (1-2a) and "Amp Level" (4-1a, 4-4), **negative (-) values** will decrease the levels, and **positive (+) values** will increase the levels. A setting of +99 will double the volume. This parameter is linked to the "Level" (Sampling P3: 3-1b). The value that was specified in Sampling mode will be displayed here.

**note** The volume is also affected by the "+12 dB" (Sampling P2: 2-1c) setting. If the "+12 dB" setting is on, the playback will be approximately +12 dB louder.

**Cutoff:** Adjusts the filter cutoff. This adjustment will be added to the value specified for "(Filter A) Frequency" (3-1b, 3-5) of Filter 1 and 2.

**Resonance:** Adjusts the resonance level of the filter. This adjustment will be added to the value specified for "(Filter A) Resonance" (3-1b, 3-5) of Filter 1 and 2.

**Pitch:** Adjusts the playback pitch in one-cent steps. A setting of +12.00 raises the pitch one octave, and a setting of -12.00 will lower the pitch one octave. This parameter is linked with the Sampling P3: Multi Sample parameter "Pitch" (Sampling P3: 3-1b). The value that was specified in Sampling mode will be displayed here.

**Attack:** Adjusts the attack times of the filter EG and amp EG. This adjustment will be added to the "(Time) Attack" of "Filter 1 EG," "Filter 2 EG," "Amp 1 EG," and "Amp 2 EG" (3-4a, 3-8, 4-3a, 4-6).

**Decay:** Adjusts the decay times of the filter EG and amp EG. This adjustment will be added to the "(Time) Decay" of "Filter 1 EG," "Filter 2 EG," "Amp 1 EG," and "Amp 2 EG" (3-4a, 3-8, 4-3a, 4-6).

- 4 Press the **Done** button to execute, and close the dialog box.

⚠ Please be aware that the Compare function is not available for this command.

## 1-3: Velo. Zone (Velocity Zone)

Here you can specify the velocity range at which each oscillator will sound.

The "Velocity M.Sample" SW Lo→Hi" (1-2c) setting in conjunction with these "OSC 1/2 Velocity Zone" settings will determine the velocity ranges in which the High and Low multisample or drum kit will sound.

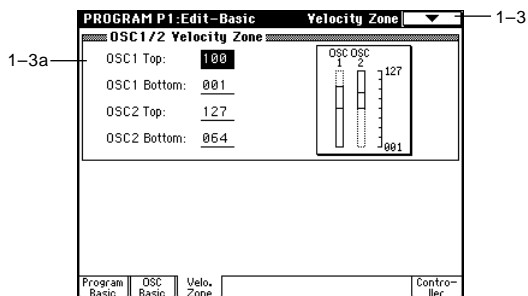

### 1-3a: OSC 1/2 Velocity Zone

**OSC1 Top** [001...127]

Sets the maximum velocity value that will sound oscillator 1.

**OSC1 Bottom** [001...127]

Sets the minimum velocity value that will sound oscillator 1.

**OSC2 Top** [001...127]

Sets the maximum velocity value that will sound oscillator 2.

**OSC2 Bottom** [001...127]

Sets the minimum velocity value that will sound oscillator 2.

⚠ It is not possible to set the Bottom Velocity greater than the Top Velocity, nor the Top Velocity less than the Bottom Velocity.

**note** You can also input a value by playing a note on the keyboard while you hold down the [ENTER] key.

### ▼ 1-3: Page Menu Command

0-1A: Write Program, 1-1A: Copy Oscillator, 1-1B: Swap Oscillator

## 1-4: Controller (Controller Setup)

These settings specify the functions of the [SW1] key, the [SW2] key, and the B-mode functions of REALTIME CONTROL knobs [1]-[4] in Program mode.

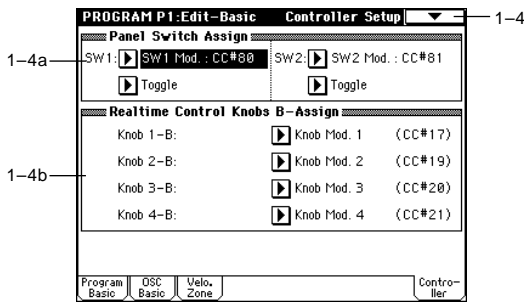

### 1-4a: Panel Switch Assign

These settings assign functions to the [SW1] and [SW2] keys ("SW1, SW2 Assign List" p.249).

**SW1 Assign** **AMSource** [Off, ..., After Touch Lock]

Assigns a function to the [SW1] key.

The on/off status of the switch is saved when the program is written.

When you change the function, it will be reset to the "off" state.

**SW1 Mode** [Toggle, Momentary]

Specifies how the on/off state of the [SW1] key will change when it is pressed.

**Toggle:** On/off will alternate each time the [SW1] key is pressed.

**Momentary:** The function will be on only as long as the [SW1] key remains pressed.

**SW2 Assign** **AMSource** [Off, ..., After Touch Lock]

**SW2 Mode** [Toggle, Momentary]

Assigns a function to the [SW2] key.

The functions that can be assigned to [SW2] key are the same as for [SW1] key, except that **SW2 Mod.:CC#81** is available instead of **SW1 Mod.:CC#80**.

### 1-4b: Realtime Control Knobs B-Assign

Here you can assign functions (mainly various types of control change) to the B-mode of the REALTIME CONTROL knobs [1]-[4] ("Realtime Control Knobs B-Assign List" p.250).

The functions you set here will take effect when you operate the REALTIME CONTROL knobs [1]-[4] in B-mode.

**Knob 1-B (Knob 1-B Assign)** **AMSource** [Off, ..., MIDI CC#95]

**Knob 2-B (Knob 2-B Assign)** **AMSource** [Off, ..., MIDI CC#95]

**Knob 3-B (Knob 3-B Assign)** **AMSource** [Off, ..., MIDI CC#95]

**Knob 4-B (Knob 4-B Assign)** **AMSource** [Off, ..., MIDI CC#95]

### ▼ 1-4: Page Menu Command

0-1A: Write Program, 1-1A: Copy Oscillator, 1-1B: Swap Oscillator

## Program P2: Edit-Pitch

Here you can make pitch modulation settings for oscillators 1 and 2.

### 2-1: OSC1 P.Mod (OSC1 Pitch Mod.)

These settings specify how key position (note number) will affect the pitch of oscillator 1, and select the controllers that will affect the oscillator 1 pitch and specify the depth of control. Here you can also specify the amount of pitch change produced by the Pitch EG and by LFO1 and LFO2. You can also switch portamento on/off and specify how it will apply.

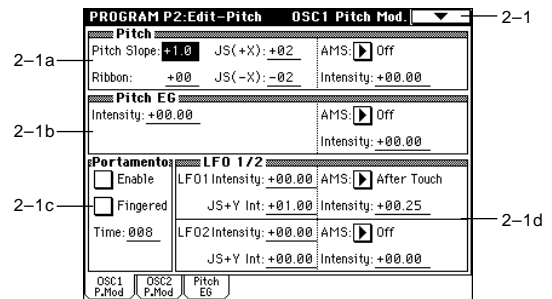

#### 2-1a: Pitch

**Pitch Slope** [-1.0...+2.0]

Normally you will leave this at +1.0.

**Positive (+) values** will cause the pitch to rise as you play higher on the keyboard, and **negative (-) values** will cause the pitch to fall as you play higher on the keyboard.

With a value of 0, there will be no change in pitch, and the C4 pitch will sound regardless of the key you play.

How the Pitch Slope and pitch are related

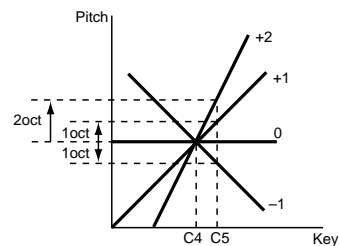

**Ribbon** [-12...+12]

Specifies in semitone units how greatly the pitch will be changed when you press the ribbon controller.

With a value of 12, the pitch can be changed a maximum of one octave.

**Positive (+) values** will cause the pitch to rise when you press the ribbon controller to the right of center, and **negative (-) values** will cause the pitch to fall.

For example with a setting of +12, pressing the far right edge of the ribbon controller will raise the pitch one octave. With a setting of -12, pressing the far right edge of the ribbon controller will lower the pitch one octave.

At the center of the ribbon controller, the original pitch will remain, so you can use this in conjunction with pressing the ribbon at its right edge to simulate the "hammering-on" techniques used by guitarists.

**JS (+X)** [-60...+12]

Specifies in semitone units how the pitch will change when the joystick is moved all the way to the right. A setting of **12** produces 1 octave of change.

For example if you set this to **+12** and move the joystick all the way to the right, the pitch will rise one octave above the original pitch.

**JS (-X)** [-60...+12]

Specifies in semitone units how the pitch will change when the joystick is moved all the way to the left. A setting of **12** produces 1 octave of change.

For example if you set this to **-60** and move the joystick all the way to the left, the pitch will fall five octaves below the original pitch. This can be used to simulate the downward swoops that a guitarist produces using the tremolo arm.

**AMS (Pitch AMS)** [Off, (FEG, AEG, EXT)]

Selects the source that will modulate the pitch of oscillator 1 ("AMS List" [p.242](#)).

**Intensity (AMS Intensity)** [-12.00...+12.00]

Specifies the depth and direction of the effect produced by "AMS (Pitch AMS)."

With a setting of **0**, no modulation will be applied. With a setting of **12.00**, the pitch will change up to one octave.

For example if you set "AMS (Pitch AMS)" to **After Touch** and apply pressure to the keyboard, the pitch will rise if this parameter is set to a **positive (+) value**, or fall if this parameter is set to a **negative (-) value**. The range is a maximum of one octave ([p.244](#)).

**2-1b: Pitch EG****Intensity** [-12.00...+12.00]

Specifies the depth and direction of the modulation that the pitch EG specified in P2: Edit-Pitch, Pitch EG page will apply to the pitch.

With a setting of **12.00**, the pitch will change a maximum of  $\pm 1$  octave.

**AMS (Pitch EG AMS)** [Off, (KT, EXT)]

Selects the source that will control the pitch modulation applied by the pitch EG ("AMS List" [p.242](#)).

**Intensity (AMS Intensity)** [-12.00...+12.00]

Specifies the depth and direction of the effect that "AMS (Pitch EG AMS)" will have.

For example if you set "AMS (Pitch EG AMS)" to **Velocity** and set this value to **12.00**, the velocity will control the range of pitch change produced by the pitch EG in a range of  $\pm 1$  octave ([p.244](#)). As you play more softly, the pitch change will draw closer to the pitch EG levels.

Pitch change (level)

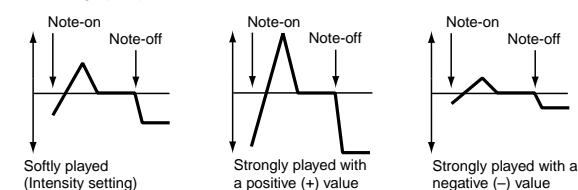

**note** "Intensity" and "AMS (Pitch EG AMS)" will be added to determine the depth and direction of the pitch modulation applied by the pitch EG.

**2-1c: Portamento**

This turns the portamento effect (smooth change in pitch from one note to the next) on/off, and specifies how it will be applied.

If [SW1] key or [SW2] key are set to **Porta.SW:CC#65**, turning [SW1] key or [SW2] key on/off will apply portamento ("AMS List" [p.242](#), "SW1, SW2 Assign List", Porta.SW:#65).

**MIDI** Portamento will also be switched when CC#65 (Portamento SW) is received.

**Enable (Porta. Enable)** [Off, On]

**On (checked):** Portamento will be applied.

**Off (unchecked):** Portamento will not be applied.

**Fingered (Porta. Fingered)** [Off, On]

This parameter is available when "Enable (Porta. Enable)" is checked.

**On (checked):** Portamento will be applied when you continue holding the previous note as you press the next note (legato playing).

**Off (unchecked):** Portamento will always be applied, regardless of how you play.

**Time (Porta. Time)** [000...127]

This parameter is available when "Enable (Porta. Enable)" is checked.

This sets the portamento time. Increasing the value will produce a slower change in pitch.

**2-1d: LFO1/2****LFO1:****LFO1 Intensity** [-12.00...+12.00]

Specifies the depth and direction of the pitch modulation applied by the OSC 1 LFO1 settings you made in "OSC1 LFO1" (5-1).

With a setting of **12.00**, a maximum of  $\pm 1$  octave of pitch modulation will be applied. **Negative (-) values** will invert the LFO waveform.

**JS+Y Int. (LFO1 JS+Y Int.)** [-12.00...+12.00]

Specifies the depth and direction of the effect that joystick movement in the +Y direction (away from yourself) will have on the pitch modulation applied by the OSC1 LFO1. As this **value is increased**, moving the joystick in the +Y direction will cause the OSC1 LFO1 to produce deeper pitch modulation. With a setting of **12.00** a maximum of  $\pm 1$  octave of pitch modulation will be applied. **Negative (-) values** will invert the LFO waveform.

**AMS (LFO1 AMS)** [Off, (PEG, FEG, AEG, KT, EXT)]

Selects the source that will control the depth of pitch modulation produced by the OSC1 LFO1 ("AMS List" [p.242](#)).

**Intensity (AMS Intensity)** [-12.00...+12.00]

Specifies the depth and direction of the effect that "AMS (LFO1 AMS)" will have.

With a setting of **0**, modulation will not be applied. With a setting of **12.00**, the OSC1 LFO1 will apply a maximum of  $\pm 1$  octave of pitch modulation. **Negative (-) settings** will invert the LFO waveform.

For example if "AMS (LFO1 AMS)" is set to **After Touch** and you apply pressure to the keyboard, a **positive (+) setting** of this parameter will cause the pitch modulation created by OSC1 LFO1 to be applied with the normal phase, and a **negative (-) setting** will cause the LFO to be applied with inverted phase.



The “LFO1 Intensity,” “JS+Y (LFO1 JS+Y Int.)” and “AMS (LFO1 AMS)” settings will be added to determine the depth and direction of the pitch modulation applied by OSC1 LFO1 (p.244).

**LFO2:**

LFO2 Intensity [-12.00...+12.00]  
 JS+Y Int. (LFO2 JS+Y Int.) [-12.00...+12.00]  
 AMS (LFO2 AMS) [Off, (PEG, FEG, AEG, KT, EXT)]  
 Intensity (AMS Intensity) [-12.00...+12.00]  
 Refer to the above “LFO1.”

▼ **2-1: Page Menu Command**

0-1A: Write Program, 1-1A: Copy Oscillator, 1-1B: Swap Oscillator

**2-2: OSC2 P.Mod (OSC2 Pitch Mod.)**

These settings specify how key position (note number) will affect the pitch, and select the controllers that will affect the oscillator 2 pitch and specify the depth of control. They also specify the depth at which the pitch EG will affect the pitch of oscillator 2, and the depth of pitch change produced by LFO1 and LFO2. Portamento on/off settings etc. are also found here.

For details on the functions of these parameters, refer to the preceding section “2-1: OSC1 P.Mod (OSC1 Pitch Mod.)”

**2-3: Pitch EG** AMSsource

Here you can make settings for the pitch EG, which creates time-variant changes in the pitch of oscillators 1 and 2. The depth of pitch change produced by these EG settings on oscillator 1 (2) is adjusted by “Pitch EG” (2-1b, 2-2).

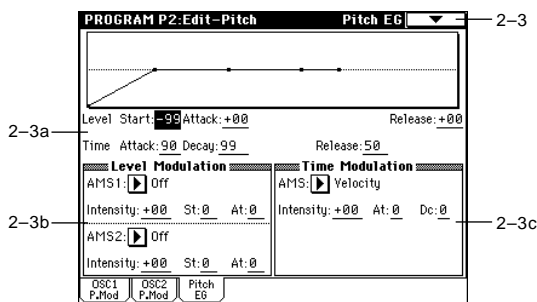

**2-3a: Pitch EG**

These settings specify how the pitch will change over time.

**Level:**

These parameters specify the amount of pitch change. The actual amount of pitch change will depend on the “Pitch EG” (2-1b, 2-2) parameter “Intensity.” For example with an “Intensity” setting of +12.00, a “Level” setting of +99 would raise the pitch one octave, and a “Level” setting of -99 would lower the pitch one octave.

**Start (Start Level)** [-99...+99]

Specifies the amount of pitch change at note-on.

**Attack (Attack Level)** [-99...+99]

Specifies the amount of pitch change when the attack time has elapsed.

**Release (Release Level)** [-99...+99]

Specifies the amount of pitch change when the release time has elapsed.

**Time:**

These parameters specify the amount of time over which the pitch change will occur.

**Attack (Attack Time)** [0...99]

Specifies the time over which the pitch will change from note-on until it reaches the pitch specified as the attack level.

**Decay (Decay Time)** [0...99]

Specifies the time over which the pitch will change after reaching the attack level until it reaches the normal pitch.

**Release (Release Time)** [0...99]

Specifies the time over which the pitch will change from note-off until it reaches the pitch specified as the release level.

Time-varying pitch settings (when Pitch EG Intensity = +12.00)

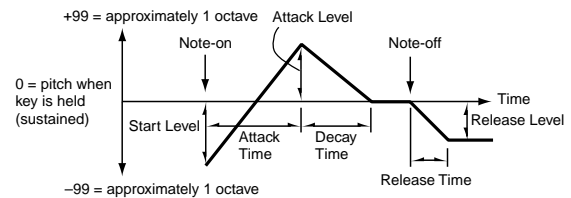

**2-3b: Level Modulation**

These settings allow the pitch EG Level parameters to be controlled by alternate modulation.

**AMS1 (Level Mod. AMS1)** [Off, (KT, EXT)]

Selects the source that will control the pitch EG Level parameters (“AMS List” p.242).

**Intensity (AMS1 Intensity)** [-99...+99]

Specifies the depth and direction of the effect applied by “AMS1 (Level Mod. AMS1).”

With a setting of 0, the levels specified by “Pitch EG” (2-3a) will be used.

For example if “AMS1 (Level Mod. AMS1)” is SW1:CC#80, pressing the [SW1] key to turn it on will change the Level parameters of the Pitch EG. (Set “Panel Switch Assign” (1-4a) to SW1 Mod.CC#80.) As the absolute value of “Intensity (AMS1 Intensity)” is increased, the pitch EG levels will change more greatly when the [SW1] key is turned on. The direction of the change is specified by “St (AMS1 SW Start)” and “At (AMS1 SW Attack).” When the [SW1] key is turned off, the pitch EG levels will return to their own settings. If “AMS1 (Level Mod. AMS1)” is set to Velocity, increasing the absolute value of “Intensity (AMS1 Intensity)” will produce increasingly wider change in pitch EG levels for strongly-played notes. The direction of the change is specified by “St (AMS1 SW Start)” and “At (AMS1 SW Attack).” As you play more softly, the pitch change will draw closer to the pitch EG levels.

Pitch EG change (level) (AMS=SW1/Velocity, Intensity= positive (+) value)

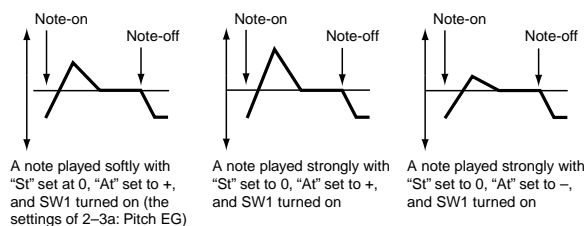

Pitch EG changes (Time) (AMS = Velocity, Intensity = positive (+) value)

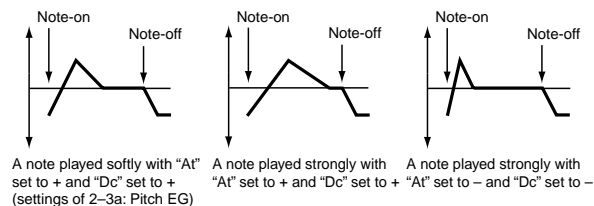
**St (AMS1 SW Start)** [-, 0, +]

Specifies the direction of change in "Start (Start Level)" caused by "AMS1 (Level Mod. AMS1)." If "Intensity (AMS1 Intensity)" is a **positive (+)** value, a setting of + will raise the EG level, and a setting of - will decrease it. With a setting of **0** there will be no change.

**At (AMS1 SW Attack)** [-, 0, +]

Specifies the direction of change in "Attack (Attack Level)" caused by "AMS1 (Level Mod. AMS1)." If "Intensity (AMS1 Intensity)" is a **positive (+)** value, a setting of + will raise the EG level, and a setting of - will decrease it. With a setting of **0** there will be no change.

**AMS2 (Level Mod. AMS2)** [Off, (KT, EXT)]**Intensity (AMS2 Intensity)** [-99...+99]**St (AMS2 SW Start)** [-, 0, +]**At (AMS2 SW Attack)** [-, 0, +]

Refer to the preceding paragraphs "AMS1 (Level Mod. AMS1)" - "At (AMS1 SW Attack)."

**At (AMS SW Attack)** [-, 0, +]

Specifies the direction in which "AMS (Time Mod. AMS)" will affect the "Attack (Attack Time)." With **positive (+)** values of "Intensity (AMS Intensity)," a setting of + will cause the time to be lengthened, and a setting of - will cause the time to be shortened. With a setting of **0** there will be no change.

**Dc (AMS SW Decay)** [-, 0, +]

Specifies the direction in which "AMS (Time Mod. AMS)" will affect the "Decay (Decay Time)." With **positive (+)** values of "Intensity (AMS Intensity)," a setting of + will cause the time to be lengthened, and a setting of - will cause the time to be shortened. With a setting of **0** there will be no change.

## ▼ 2-3: Page Menu Command

0-1A: Write Program, 1-1A: Copy Oscillator, 1-1B: Swap Oscillator

**2-3c: Time Modulation**

These parameters let you use an alternate modulation source to control the *Time* parameters of the pitch EG.

**AMS (Time Mod. AMS)** [Off, (KT, EXT)]

Selects the source that will control the *Time* parameters of the pitch EG ("AMS List" p.242).

**Intensity (AMS Intensity)** [-99...+99]

Specifies the depth and direction of the effect that "AMS (Time Mod. AMS)" will have.

With a setting of **0**, the pitch EG times will be just as specified by the "Pitch EG" (2-3a) settings.

The alternate modulation value at the moment that the EG reaches each point will determine the actual value of the EG time that comes next.

For example, the decay time will be determined by the alternate modulation value at the moment that the attack level is reached.

When this parameter is set to values of **16, 33, 49, 66, 82**, or **99**, the specified EG times will speed up as much as 2, 4, 8, 16, 32, or 64 times respectively (or slowed down to 1/2, 1/4, 1/8, 1/16, 1/32, or 1/64 of the original time).

For example if "AMS (Time Mod. AMS)" is set to **Velocity**, increasing the absolute value of "Intensity (AMS Intensity)" will allow strongly-played notes to increase the changes in pitch EG *Time* values. The direction of the change is specified by "At (AMS SW Attack)" and "Dc (AMS SW Decay)." As you play more softly, the pitch EG times will more closely approach the actual settings of the pitch EG.

## Program P3: Edit-Filter

Here you can make settings for the filters that will be used by oscillators 1 and 2. You can select either a 24 dB/octave low pass filter with resonance, or a series connection of a 12 dB/octave low pass filter and a 12 dB/octave high pass filter.

When “**Oscillator Mode**” (1-1a) is set to **Single**, filter 1 will be used, and when it is set to **Double**, filters 1 and 2 will be used.

When **Single** is selected, pages relating to filter 2 cannot be selected.

### 3-1: Filter1

Here you can specify the basic filter type used by oscillator 1, and set the cutoff frequency and resonance.

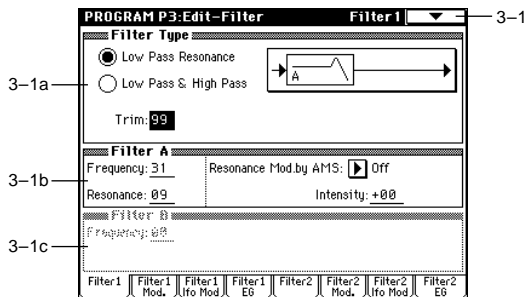

#### 3-1a: Filter Type

##### Filter Type

[Low Pass Resonance, Low Pass & High Pass]

Selects the type for filter 1.

**Low Pass Resonance:** 24 dB/octave low pass filter with resonance.



**Low Pass & High Pass:** 12 dB/octave low pass filter and 12 dB/octave high pass filter in series.

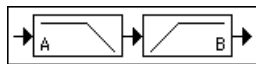

##### Trim

[00...99]

Adjusts the level at which the audio signal output from oscillator 1 is input to filter 1A.

⚠ If the trim value is set too high, the sound may be distorted if Resonance is set to a high value or when you play a chord.

#### 3-1b: Filter A

This is a filter that cuts the high-frequency region above the cutoff frequency.

This is the most common type of filter, and is used to cut part of the overtone components, making an originally bright timbre sound more mellow (darker).

When the “**Filter Type**” is **Low Pass Resonance**, the cutoff will have a steeper slope.

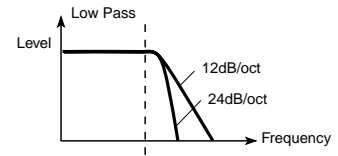

##### Frequency (A Frequency)

[00...99]

Specifies the cutoff frequency of filter 1A.

##### Resonance (A Resonance)

[00...99]

This emphasizes the overtone components that lie in the region of the cutoff frequency specified by “Frequency (A Frequency),” producing a more distinctive sound. Increasing this value will produce a stronger effect.

##### Resonance Mod. by AMS

[Off, (PEG, FEG, AEG, LFO, KT, EXT)]

Selects the source that will control the “Resonance (A Resonance)” level (“AMS List” p.242).

##### Intensity (AMS Intensity)

[-99...+99]

Specifies the depth and direction of the effect that “Resonance Mod. by AMS” will have on the resonance level specified by “Resonance (A Resonance).”

For example if **Velocity** has been selected, changes in keyboard velocity will affect the resonance.

With **positive (+) values**, the resonance will increase as you play more strongly, and as you play more softly the resonance will approach the level specified by the “Resonance (A Resonance)” setting.

With **negative (-) values**, the resonance will decrease as you play more strongly, and as you play more softly the resonance will approach the level specified by the “Resonance (A Resonance)” setting.

The resonance level is determined by adding the “Resonance (A Resonance)” and “Intensity (AMS Intensity)” values.

The effect of resonance

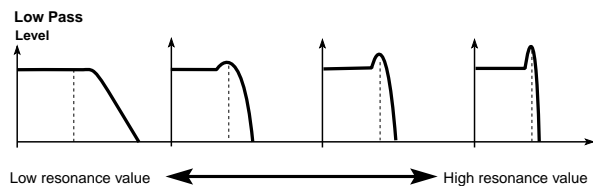

#### 3-1c: Filter B

This parameter will be displayed when “**Filter Type**” (3-1a) is set to **Low Pass & High Pass**.

This filter cuts the low-frequency range that lies below the cutoff frequency. By cutting the lower overtones, it lightens the tone.

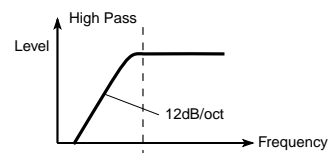

##### Frequency (B Frequency)

[00...99]

Specifies the cutoff frequency of filter 1B.

### ▼ 3-1: Page Menu Command

☞ 0-1A: Write Program, 1-1A: Copy Oscillator, 1-1B: Swap Oscillator

### 3-2: Filter1 Mod.

Here you can make settings to specify how keyboard tracking, controllers, and filter 1 EG intensity will control the Filter 1 cutoff frequency “Frequency” (A/B Frequency) to modify the tone.

When “Filter Type” (3-1a) is Low Pass Resonance, parameters for filter B will not be displayed.

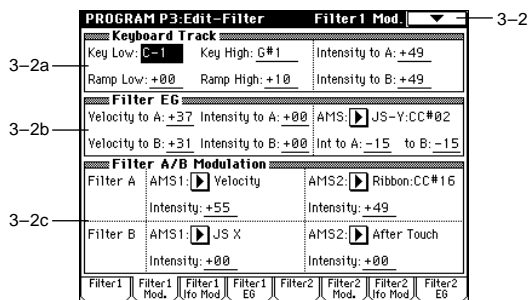

#### 3-2a: Keyboard Track

These settings specify keyboard tracking for the cutoff frequency of filter 1.

The way in which the cutoff frequency is affected by the position of the key you play (note number) can be specified by the “Key Low (KBDTrk Key Low),” “Key High (KBDTrk Key High),” “Ramp Low (KBDTrk Ramp Low)” and “Ramp High (KBDTrk Ramp High)” parameters.

#### Key:

Specifies the note number at which keyboard tracking will begin to be applied, and set the “Intensity to A (KBDTrk Int. to A)” and “Intensity to B (KBDTrk Int. to B)” parameters to specify the depth and direction of the change applied to filter 1 A and B.

For the range of notes between “Key Low (KBDTrk Key Low)” and “Key High (KBDTrk Key High),” the cutoff frequency will change according to the key position (pitch).

**note** Note numbers can also be entered by holding down the [ENTER] key while you press a note on the keyboard.

**Key Low (KBDTrk Key Low)** [C-1...G9]

Keyboard tracking will apply to the range below the specified note number.

**Key High (KBDTrk Key High)** [C-1...G9]

Keyboard tracking will apply to the range above the specified note number.

#### Ramp (Ramp Setting):

Specifies the angle of keyboard tracking.

**Ramp Low (KBDTrk Ramp Low)** [-99...+99]

**Ramp High (KBDTrk Ramp High)** [-99...+99]

If “Intensity to A (KBDTrk Int. to A)” and “Intensity to B (KBDTrk Int. to B)” are set to +50, “Ramp Low (KBDTrk Ramp Low)” is set to -62 and “Ramp High (KBDTrk Ramp High)” is set to +62, the angle of the change in cutoff frequency will correspond to the keyboard location (pitch). This means that the oscillation that occurs when you

increase the “Resonance (A Resonance)” (3-1b) will correspond to the keyboard location.

If you set “Ramp Low (KBDTrk Ramp Low)” to +43 and “Ramp High (KBDTrk Ramp High)” to -43, the cutoff frequency will not be affected by keyboard location. Use this setting when you do not want the cutoff frequency to change for each note.

How cutoff frequency is affected by keyboard location and the Ramp setting (“Intensity to A” and “Intensity to B” = +50)

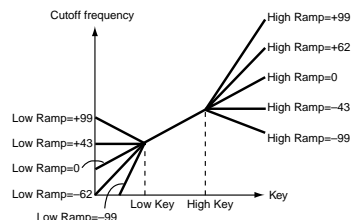

**Intensity to A (KBDTrk Int. to A)** [-99...+99]

Specifies the depth and direction of the effect that the keyboard tracking specified by “Key Low (KBDTrk Key Low),” “Key High (KBDTrk Key High),” “Ramp Low (KBDTrk Ramp Low)” and “Ramp High (KBDTrk Ramp High)” will have on filter 1A.

With **positive (+) values**, the effect will be in the direction specified by keyboard tracking, and with **negative (-) values** the effect will be in the opposite direction.

**Intensity to B (KBDTrk Int. to B)** [-99...+99]

Specifies the depth and direction of the effect that keyboard tracking will have on filter 1B (☞ “Intensity to A (KBDTrk Int. to A)”).

#### 3-2b: Filter EG

**Velocity to A** [-99...+99]

This parameter specifies the depth and direction of the effect that velocity will have on the time-varying changes created by the filter 1 EG (as set by “Filter 1 EG” 3-4) to control the filter 1A cutoff frequency.

With **positive (+) values**, playing more strongly will cause the filter 1 EG to produce greater changes in cutoff frequency. With **negative (-) values**, playing more strongly will also cause the filter 1 EG to produce greater changes in cutoff frequency, but with the polarity of the EG inverted.

**Velocity to B** [-99...+99]

This parameter specifies the depth and direction of the effect that velocity will have on the time-varying changes created by the filter 1 EG to control the filter 1B cutoff frequency (☞ “Velocity to A”).

Changes in cutoff frequency

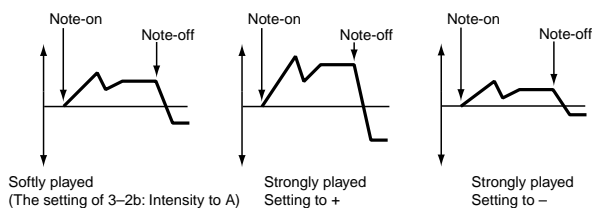

**Intensity to A** [-99...+99]

Specifies the depth and direction of the effect that the time-varying changes created by the filter 1 EG will have on the filter 1A cutoff frequency.

With **positive (+) settings**, the sound will become brighter when the EG levels set by Filter 1 EG *Level* and *Time* param-

ters (3-4a) are in the “+” area, and darker when they are in the “-” area.

With **negative (-)** settings, the sound will become darker when the EG levels set by Filter 1 EG “Level” and “Time” parameters (3-4a) are in the “+” area, and brighter when they are in the “-” area.

**Intensity to B** [-99...+99]

Specifies the depth and direction of the effect that the time-varying changes created by the filter 1 EG will have on the filter 1B cutoff frequency (☞“Intensity to A”).

**AMS (Filter EG AMS)** [Off, (EXT)]

Selects the source that will control the depth and direction of the effect that the time-varying changes produced by the filter 1 EG will have on the cutoff frequency of filters 1A and 1B (“AMS List” ☞p.242).

**Int to A (AMS Int. to A)** [-99...+99]

Specifies the depth and direction of the effect that “AMS (Filter EG AMS)” will have on filter 1A. For details on how this will apply (☞“Intensity to A”).

**Int to B (AMS Int. to B)** [-99...+99]

Specifies the depth and direction of the effect that “AMS (Filter EG AMS)” will have on filter 1B. For details on how this will apply (☞“Intensity to A”).

**note** The sum of the settings for “Velocity to A (B),” “Intensity to A (B),” and “Int to A (B) (AMS Int. to A/B)” will determine the depth and direction of the effect produced by the filter EG.

**3-2c: Filter A/B Modulation**

**Filter A:**

**AMS1 (Filter A AMS1)** [Off, (PEG, AEG, EXT)]

Selects the source that will control modulation of the filter 1A cutoff frequency (“AMS List” ☞p.242).

**Intensity (A AMS1 Intensity)** [-99...+99]

Specifies the depth and direction of the effect that “AMS1 (Filter A AMS1)” will have.

When “AMS1 (Filter A AMS1)” is JS X, a **positive (+) value** for this parameter will cause the cutoff frequency to rise when the joystick is moved toward the right, and fall when the joystick is moved toward the left. With a **negative (-) value** for this parameter, the opposite will occur.

This value is added to the setting of the Filter A “Frequency (A Frequency)” (3-1b).

**AMS2 (Filter A AMS2)** [Off, (PEG, AEG, EXT)]

**Intensity (A AMS2 Intensity)** [-99...+99]

Selects “AMS2 (Filter A AMS2),” and specify the depth and direction of the effect that the selected source will have (☞“AMS1 (Filter A AMS1),” “Intensity (A AMS1 Intensity)”).

**Filter B:**

This will be displayed when “Filter Type” (3-1a) is **Low Pass & High Pass**.

Two alternate modulation sources can be used to modulate the cutoff frequency of filter 1B (☞“Filter A”).

**▼ 3-2: Page Menu Command**

☞0-1A: Write Program, 1-1A: Copy Oscillator, 1-1B: Swap Oscillator

**3-3: Filter1 LFO Mod.**

Here you can use the filter 1 LFO to apply cyclic modulation to the cutoff frequency of filter 1 (for oscillator 1) to create cyclical changes in tone.

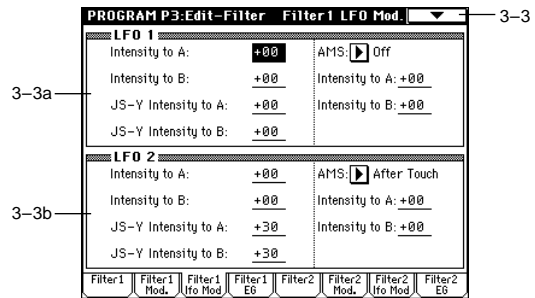

**3-3a: LFO 1**

**Intensity to A (LFO1 Int. to A)** [-99...+99]

Specifies the depth and direction of the modulation that OSC1 LFO1 (set by “OSC1 LFO1” 5-1) will have on the cutoff frequency of filter 1A.

**Negative (-)** settings will invert the phase.

**Intensity to B (LFO1 Int. to B)** [-99...+99]

Specifies the depth and direction of the modulation that OSC1 LFO1 will have on the cutoff frequency of filter 1B (☞“Intensity to A (LFO1 Int. to A)”).

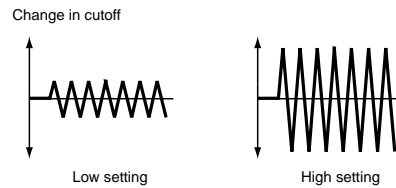

**JS-Y Intensity to A (LFO1 JS-Y Int. to A)** [-99...+99]

The joystick can be moved in the -Y direction (toward yourself) to control OSC1 LFO1, modulating the cutoff frequency of filter 1A.

This parameter specifies the depth and direction of control. **Higher settings** of this parameter will cause OSC1 LFO1 to have a greater effect on filter 1 when you move the joystick in the -Y direction (toward yourself).

**JS-Y Intensity to B (LFO1 JS-Y Int. to B)** [-99...+99]

The joystick can be moved in the -Y direction (toward yourself) to control OSC1 LFO1, modulating the cutoff frequency of filter 1B.

This parameter specifies the depth and direction of control. (☞“JS-Y Intensity to A (LFO1 JS-Y Int. to A)”)

**AMS (LFO1 AMS)** [Off, (PEG, FEG, AEG, KT, EXT)]

Selects a source that will control the depth and direction of cutoff frequency change for both filters 1A and 1B (“AMS List” ☞p.242).

**Intensity to A (LFO1 AMS Int. to A)** [-99...+99]

Specifies the depth and direction of the effect that “AMS (LFO1 AMS)” will have on filter 1A.

For example if “AMS (LFO1 AMS)” is **After Touch**, **higher settings** of this parameter will allow greater change to be applied to OSC1 LFO1 when you apply pressure to the keyboard.

**Intensity to B (LFO1 AMS Int. to B)** [-99...+99]

Specifies the depth and direction of the effect that “AMS (LFO1 AMS)” will have on filter 1B (☞ “Intensity to A (LFO1 AMS Int. to A)”).

**3-3b: LFO 2**

Adjusts the depth of the cyclic modulation applied by OSC1 LFO2 (set by 5-2) to the cutoff frequency of filters 1A and 1B (☞ LFO 1: 3-3a).

**Intensity to A (LFO2 Int. to A)** [-99...+99]**Intensity to B (LFO2 Int. to B)** [-99...+99]**JS-Y Intensity to A (LFO2 JS-Y Int. to A)** [-99...+99]**JS-Y Intensity to B (LFO2 JS-Y Int. to B)** [-99...+99]**AMS (LFO2 AMS)** [Off, (PEG, FEG, AEG, KT, EXT)]**Intensity to A (LFO2 AMS Int. to A)** [-99...+99]**Intensity to B (LFO2 AMS Int. to B)** [-99...+99]**▼ 3-3: Page Menu Command**

☞ 0-1A: Write Program, 1-1A: Copy Oscillator, 1-1B: Swap Oscillator

**3-4: Filter1 EG** AMSSource

Here you can make settings for the EG that will produce time-varying changes in the cutoff frequency of filters 1A and 1B.

The depth of the effect that these settings will have on the filter 1 cutoff frequency is determined by *Filter EG* (3-2b).

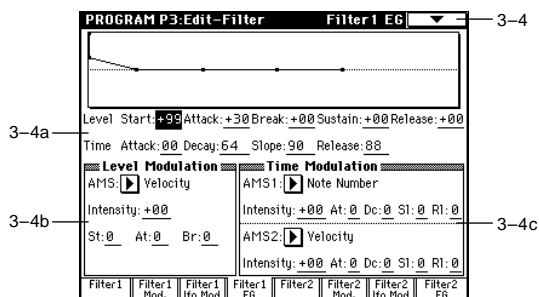

3-4a

3-4b

**3-4a: Filter1 EG**

Specifies the time-varying change produced by the filter 1 EG.

**Level:**

The result will depend on the filter that was selected in “Filter Type” (3-1a). For example with the **Low Pass Resonance** filter, **positive (+)** values of EG Intensity will cause the tone to be brightened by **positive (+) levels**, and darkened by **negative (-) levels**.

**Start (Start Level)** [-99...+99]

Specifies the cutoff frequency at the time of note-on.

**Attack (Attack Level)** [-99...+99]

Specifies the cutoff frequency after the attack time has elapsed.

**Break (Break Point Level)** [-99...+99]

Specifies the cutoff frequency after the decay time has elapsed.

**Sustain (Sustain Level)** [-99...+99]

Specifies the cutoff frequency that will be maintained from after the slope time has elapsed until note-off occurs.

**Release (Release Level)** [-99...+99]

Specifies the cutoff frequency that will occur when the release time has elapsed.

**Time:**

These parameters specify the time over which each change will occur.

**Attack (Attack Time)** [00...99]

Specifies the time over which the level will change from note-on until the attack level is reached.

**Decay (Decay Time)** [00...99]

Specifies the time over which the level will change from the attack level to the break point level.

**Slope (Slope Time)** [00...99]

Specifies the time over which the level will change after the decay time has elapsed until the sustain level is reached.

**Release (Release Time)** [00...99]

Specifies the time over which the level will change after note-on occurs until the release level is reached.

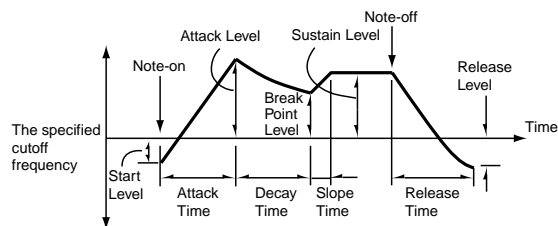
**3-4b: Level Modulation**

These settings let you use alternate modulation to control the *Level* parameters of the filter 1 EG.

**AMS (Level Mod. AMS)** [Off, (KT, EXT)]

Selects the source that will control the *Level* parameters of the filter 1 EG (“AMS List” ☞ p.242).

**Intensity (AMS Intensity)** [-99...+99]

Specifies the depth and direction of the effect that “AMS (Level Mod. AMS)” will have.

For example if “AMS (Level Mod. AMS)” is **Velocity**, and you set “St (AMS SW Start),” “At (AMS SW Attack)” and “Br (AMS SW Break)” to + and set “Intensity (AMS Intensity)” to a **positive (+) value**, the EG levels will rise as you play more strongly. If “Intensity (AMS Intensity)” is set to a **negative (-) values**, the EG levels will fall as you play more strongly.

With a setting of **0**, the levels specified by “Filter 1 EG” (3-4a) will be used.

**St (AMS SW Start)** [-, 0, +]

Specifies the direction in which “AMS (Level Mod. AMS)” will affect “Start (Start Level).” When “Intensity (AMS Intensity)” has a **positive (+) value**, a setting of + for this parameter will allow “AMS (Level Mod. AMS)” to raise the EG level, and a setting of - will allow “AMS (Level Mod. AMS)” to lower the EG level. With a setting of **0** there will be no change.

**At (AMS SW Attack)** [-, 0, +]

Specifies the direction in which “AMS (Level Mod. AMS)” will affect “Attack (Attack Level).” When “**Intensity (AMS Intensity)**” has a **positive (+)** value, a setting of + for this parameter will allow “AMS (Level Mod. AMS)” to raise the EG level, and a setting of - will allow “AMS (Level Mod. AMS)” to lower the EG level. With a setting of **0** there will be no change.

**Br (AMS SW Break)** [-, 0, +]

Specifies the direction in which “AMS (Level Mod. AMS)” will affect “Break (Break Point Level).” When “**Intensity (AMS Intensity)**” has a **positive (+)** value, a setting of + for this parameter will allow “AMS (Level Mod. AMS)” to raise the EG level, and a setting of - will allow “AMS (Level Mod. AMS)” to lower the EG level. With a setting of **0** there will be no change.

Filter 1 EG changes (level) (AMS = Velocity, Intensity = a positive (+) value)

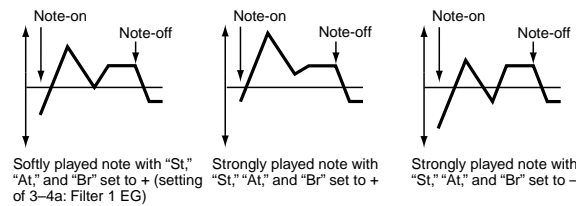

**3-4c: Time Modulation**

These settings let you use alternate modulation to control the *Time* parameters of the filter 1 EG.

**AMS1:**

**AMS1 (Time Mod. AMS1)** [Off, (KT, EXT)]

Selects the source that will control the *Time* parameters of the filter 1 EG (“AMS List” p.242).

**Intensity (AMS1 Intensity)** [-99...+99]

Specifies the depth and direction of the effect that “AMS1 (Time Mod. AMS1)” will have.

For example if “**AMS1 (Time Mod. AMS1)**” is set to **Flt KTr +/+**, the EG *Time* parameters will be controlled by the *Keyboard Track* (3-2a) settings. With **positive (+)** values of this parameter, **positive (+)** values of *Ramp (Ramp Setting)* will lengthen the EG times, and **negative (-)** values of *Ramp (Ramp Setting)* will shorten the EG times. The direction of change is specified by “At (AMS1 SW Attack),” “Dc (AMS1 SW Decay),” “SI (AMS1 SW Slope),” and “RI (AMS1 SW Release).”

With a setting of **0**, the times specified by *Filter 1 EG* (3-4a) will be used.

If “**AMS1 (Time Mod. AMS1)**” is set to **Velocity**, **positive (+)** values of this parameter will cause EG times to lengthen as you play more strongly, and **negative (-)** values will cause EG times to shorten as you play more strongly.

**At (AMS1 SW Attack)** [-, 0, +]

Specifies the direction in which “AMS1 (Time Mod. AMS1)” will affect the attack time. With **positive (+)** values of “**Intensity (AMS1 Intensity)**,” setting this parameter to + will allow AMS1 to lengthen the time, and setting this parameter to - will allow AMS1 to shorten the time. With a setting of **0** there will be no change.

**Dc (AMS1 SW Decay)** [-, 0, +]

Specifies the direction in which “AMS1 (Time Mod. AMS1)” will affect the decay time. With **positive (+)** values of “**Intensity (AMS1 Intensity)**,” setting this parameter to + will allow AMS1 to lengthen the time, and setting this parameter to - will allow AMS1 to shorten the time. With a setting of **0** there will be no change.

**SI (AMS1 SW Slope)** [-, 0, +]

Specifies the direction in which “AMS1 (Time Mod. AMS1)” will affect the slope time. With **positive (+)** values of “**Intensity (AMS1 Intensity)**,” setting this parameter to + will allow AMS1 to lengthen the time, and setting this parameter to - will allow AMS1 to shorten the time. With a setting of **0** there will be no change.

**RI (AMS1 SW Release)** [-, 0, +]

Specifies the direction in which “AMS1 (Time Mod. AMS1)” will affect the release time. With **positive (+)** values of “**Intensity (AMS1 Intensity)**,” setting this parameter to + will allow AMS1 to lengthen the time, and setting this parameter to - will allow AMS1 to shorten the time. With a setting of **0** there will be no change.

Filter 1 EG changes (Time) (AMS = Velocity, Intensity = a positive (+) value)

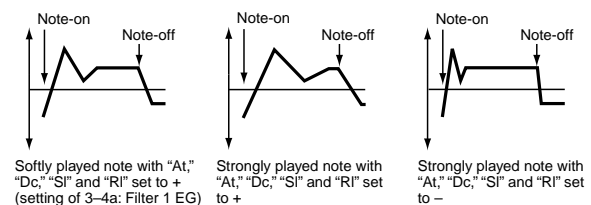

**AMS2:**

**AMS2 (Time Mod. AMS2)** [Off, (KT, EXT)]

**Intensity (AMS2 Intensity)** [-99...+99]

**At (AMS2 SW Attack)** [-, 0, +]

**Dc (AMS2 SW Decay)** [-, 0, +]

**SI (AMS2 SW Slope)** [-, 0, +]

**RI (AMS2 SW Release)** [-, 0, +]

These parameters are the settings for AMS2 to control the *Time* parameters of the filter 1 EG (AMS1).

**▼ 3-4: Page Menu Command**

0-1A	Write Program
1-1A	Copy Oscillator
1-1B	Swap Oscillator
3-4A	Sync Both EGs

**3-4A: Sync Both EGs**

When you select the page menu command “**Sync Both EGs**,” a check mark will be added at the left of “Sync Both EGs.” In this state, you can edit the filter 1 EG and filter 2 EG simultaneously. (Editing either EG will change the settings of both EGs.)

**note** “Sync Both EGs” cannot separately sync the filter EG and amp EG. For example if they are synced in 4-3A, they will also be synced here.

**note** This can be selected only if “**Oscillator Mode**” (1-1a) is **Double**.

### 3-5: Filter2

### 3-6: Filter2 Mod.

### 3-7: Filter2 LFO Mod.

### 3-8: Filter2 EG

Make settings for filter 2 which controls the sound of oscillator 2. You can choose either a 24 dB/octave low pass filter with resonance or a 12 dB/octave low pass filter and 12 dB/octave high pass filter connected in series. Filter 2 can be used if “Oscillator Mode” (1-1a) is **Double**. (see “3-1: Filter1” – “3-4: Filter1 EG”)

## Program P4: Edit-Amp

Make settings for amp 1 which controls the volume of oscillator 1, and amp 2 which controls the volume of oscillator 2. Pan settings are also made here.

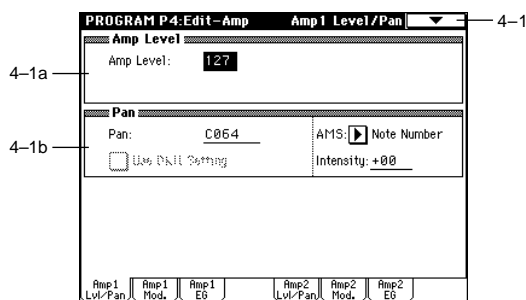

### 4-1: Amp1 Level/Pan

These parameters control the volume and pan of oscillator 1.

#### 4-1a: Amp Level

**Amp Level (Amp1 Level)** [0...127]

Sets the volume of oscillator 1.

 The volume of a program can be controlled by CC#7 (volume) and #11 (expression). The resulting level is determined by multiplying the values of CC#7 and #11. The Global MIDI channel “MIDI Channel” (Global P1: 1-1a) is used for control.

#### 4-1b: Pan

**Pan (Amp1 Pan)** [Random, L001...C064...R127]

Sets the pan (stereo location) of oscillator 1.

A setting of **L001** places the sound at far left, **C064** in the center, and **R127** to far right.

**Random:** The sound will be heard from a different location at each note-on.

 This can be controlled by CC#10 (panpot). A CC#10 value of 0 or 1 will place the sound at the far left, a value of 64 will place the sound at the location specified by the “Pan” setting for each oscillator, and a value of 127 will place the sound at the far right. This is controlled on the global MIDI channel “MIDI Channel” (Global P1: 1-1a).

**Use DKit Setting** [Off, On]

This option is available only when “Oscillator Mode” (1-1a) is set to **Drums**.

**On (checked):** The sound will be output at the “Pan” setting that has been made for each key of the drum kit (Global P5: 5-2b). When “Oscillator Mode” is **Drums**, you will normally use this setting.

**Off (unchecked):** All keys of the Drum Kit will use the “Pan (Amp 1 Pan)” setting.

**AMS (Pan AMS)** [Off, (PEG, FEG, AEG, LFO, KT, EXT)]

Selects the source that will modify pan (“AMS List” see p.242). This change will be relative to the “Pan (Amp 1 Pan)” setting.



**Intensity** [-99...+99]

Specifies the depth of the effect produced by "AMS (Pan AMS)."

For example if "Pan (Amp1 Pan)" is set to C064 and "AMS (Pan AMS)" is Note Number, positive (+) values of this parameter will cause the sound to move toward the right as the note numbers increase beyond the C4 note (i.e., as you play higher), and toward the left as the note numbers decrease (i.e., as you play lower). Negative (-) values of this parameter will have the opposite effect.

▼ 4-1: Page Menu Command

0-1A: Write Program, 1-1A: Copy Oscillator, 1-1B: Swap Oscillator

4-2: Amp1 Mod.

Applies modulation to amp 1 (for oscillator 1), make settings for keyboard tracking to vary the volume, and set the intensity of velocity and LFO 1/2.

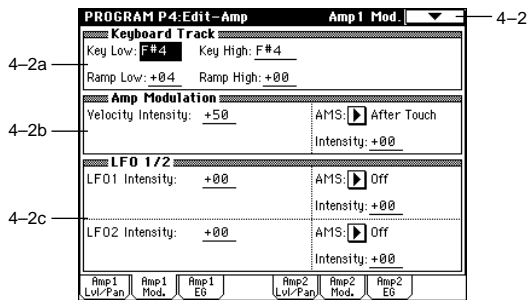

4-2a: Keyboard Track

These parameters let you use keyboard tracking to adjust the volume of oscillator 1. Use the "Key Low," "Key High" and "Ramp Low," "Ramp High" parameters to specify how the volume will be affected by the keyboard location that you play.

**Key:**

Specifies the note number at which keyboard tracking will begin to apply.

The volume will not change between "Key Low (KBDTrk Key Low)" and "Key High (KBDTrk Key High)."

**note** The note number can also be input by holding the [ENTER] key and playing a note on the keyboard.

**Key Low (KBDTrk Key Low)** [C-1...G9]

Keyboard tracking will apply to the range of notes below the note number you specify here.

**Key High (KBDTrk Key High)** [C-1...G9]

Keyboard tracking will apply to the range of notes above the note number you specify here.

**Ramp:**

Specifies the angle of the keyboard tracking.

**Ramp Low (KBDTrk Ramp Low)** [-99...+99]

With positive (+) values of this parameter, the volume will increase as you play notes below the "Key Low (KBDTrk Key Low)" note number. With negative (-) values, the volume will decrease.

**Ramp High (KBDTrk Ramp High)** [-99...+99]

With positive (+) values of this parameter, the volume will increase as you play notes above the "Key High (KBDTrk Key High)" note number. With negative (-) values, the volume will decrease.

Volume change produced by keyboard location and Ramp settings

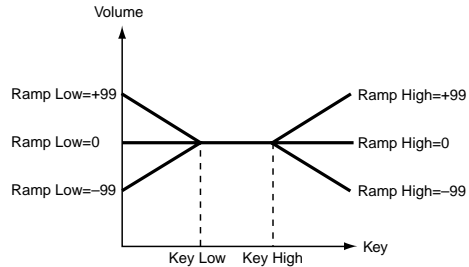

4-2b: Amp Modulation

These parameters specify how the volume of oscillator 1 will be affected by velocity.

**Velocity Intensity** [-99...+99]

With positive (+) values, the volume will increase as you play with more velocity.

With negative (-) values, the volume will decrease as you play with more velocity.

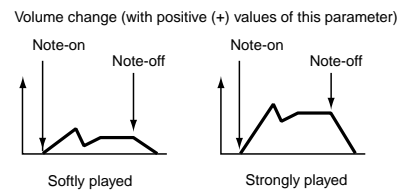

**AMS (LFO1 AMS)** [Off, (PEG, FEG, AEG, KT, EXT)]

Selects a source that will control the depth by which “OSC1 LFO1” will modulate the volume of oscillator 1 (“AMS List” p.242).

**Intensity (AMS Intensity)** [-99...+99]

As the absolute value of this setting is increased, the effect of “AMS (LFO1 AMS)” on “OSC1 LFO1” will increase. **Negative (-) values** will invert the LFO waveform.

**LFO2 Intensity** [-99...+99]**AMS (LFO2 AMS)** [Off, (PEG, FEG, AEG, KT, EXT)]**Intensity (AMS Intensity)** [-99...+99]

Specifies the depth and direction of the effect that “OSC1 LFO 2” (5-2) will have on the volume of oscillator 1. Refer to the preceding sections “LFO1 Intensity”-“Intensity (AMS Intensity).”

### ▼ 4-2: Page Menu Command

0-1A: Write Program, 1-1A: Copy Oscillator, 1-1B: Swap Oscillator

### 4-3: Amp1 EG AMSource

These parameters let you create time-varying changes in the volume of oscillator 1.

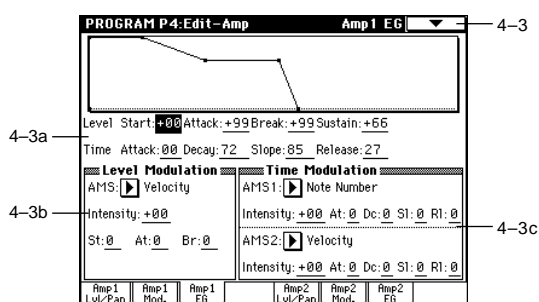

#### 4-3a: Amp1 EG

These parameters specify how the amp 1 EG will change over time.

**Level:****Start (Start Level)** [00...99]

Specifies the volume level at note-on. If you want the note to begin at a loud level, set this to a high value.

**Attack (Attack Level)** [00...99]

Specifies the volume level that will be reached after the attack time has elapsed.

**Break (Break Point Level)** [00...99]

Specifies the volume level that will be reached after the decay time has elapsed.

**Sustain (Sustain Level)** [00...99]

Specifies the volume level that will be maintained from after the slope time has elapsed until note-off occurs.

**Time:****Attack (Attack Time)** [00...99]

Specifies the time over which the volume will change after note-on until it reaches the attack level. If the start level is 0, this will be the rise time of the sound.

**Decay (Decay Time)** [00...99]

Specifies the time over which the volume will change from when it reaches the attack level until it reaches the break point level.

**Slope (Slope Time)** [00...99]

Specifies the time over which the volume will change from when it reaches the break point level until it reaches the sustain level.

**Release (Release Time)** [00...99]

Specifies the time over which the volume will change after note-off until it reaches 0.

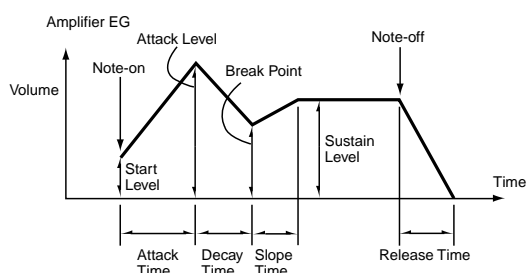

#### 4-3b: Level Modulation

Specifies how AMS will control the amp 1 EG level specified in “Amp1 EG” (4-3a).

**AMS (Level Mod.AMS)** [Off, (KT, EXT)]

Selects the source that will control the *Level* parameters of the amp 1 EG (“AMS List” p.242).

**Intensity (AMS Intensity)** [-99...+99]

Specifies the depth and direction of the effect that “AMS (Level Mod.AMS)” will have.

For example if “AMS (Level Mod.AMS)” is **Velocity**, setting “St (AMS SW Start),” “At (AMS SW Attack),” and “Br (AMS SW Break)” to + and setting “Intensity (AMS Intensity)” to a **positive (+) value** will cause the amp 1 EG volume levels to increase as you play more strongly. Setting “Intensity (AMS Intensity)” to a **negative (-) values** will cause the amp 1 EG volume levels to decrease as you play more strongly. With a setting of 0, the levels will be as specified in “Amp1 EG” (4-3a).

**St (AMS SW Start)** [-, 0, +]

Specifies the direction in which “AMS (Level Mod.AMS)” will change “Start (Start Level).” If “**Intensity (AMS Intensity)**” is set to a **positive (+) value**, setting this parameter to + will allow AMS to increase the EG level, and setting this parameter to - will allow AMS to decrease the EG level. With a setting of 0, no change will occur.

**At (AMS SW Attack)** [-, 0, +]

Specifies the direction in which “AMS (Level Mod.AMS)” will change “Attack (Attack Level).” If “**Intensity (AMS Intensity)**” is set to a **positive (+) value**, setting this parameter to + will allow AMS to increase the EG level, and setting this parameter to - will allow AMS to decrease the EG level. With a setting of 0, no change will occur.

**Br (AMS SW Break)** [-, 0, +]

Specifies the direction in which “AMS (Level Mod.AMS)” will change “Break (Break Point Level).” If “**Intensity (AMS Intensity)**” is set to a **positive (+) value**, setting this parameter to + will allow AMS to increase the EG level, and setting this parameter to - will allow AMS to decrease the EG level. With a setting of **0**, no change will occur.

Amp 1 EG changes (Level) (AMS=Velocity, Intensity = a positive (+) value)

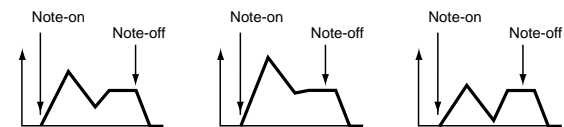

Softly played note when “St”=0 and “At” and “Br” are set to + (settings of 4-3a: Amp 1 EG)  
 Strongly played note when “St”=0 and “At” and “Br” are set to +  
 Strongly played note when “St”=0 and “At” and “Br” are set to -

**4-3c: Time Modulation**

These parameters let you use an alternate modulation source to modify the amp 1 EG times that were specified in *Amp1 EG (4-3a)*.

**AMS1 (Time Mod. AMS1)** [Off, (KT, EXT)]

Selects the source that will control the *Time* parameters of the amp 1 EG (“AMS List” <sup>Ⓔ</sup>p.242).

**Intensity (AMS1 Intensity)** [-99...+99]

Specifies the depth and direction of the effect that “AMS1 (Time Mod. AMS1)” will have. For example if “**AMS1 (Time Mod. AMS1)**” is **Amp KTrk +/-**, the (Amp) *Keyboard Track* settings (4-2a) will control the EG *Time* parameters. With **positive (+) values** of this parameter, **positive (+) values** of *Ramp* will cause EG times to be lengthened, and **negative (-) values** of *Ramp* will cause EG times to be shortened. The direction of the change is specified by “At (AMS1 SW Attack),” “Dc (AMS1 SW Decay),” “SI (AMS1 SW Slope),” and “RI (AMS1 SW Release).” When “**AMS1 (Time Mod. AMS1)**” is **Velocity**, **positive (+) values** will cause EG times to lengthen as you play more strongly, and **negative (-) values** will cause EG times to shorten as you play more strongly. With a setting of **0**, the EG times will be as specified in *Amp1 EG (4-3a)*.

**At (AMS1 SW Attack)** [-, 0, +]

Specifies the direction of the effect that “AMS1 (Time Mod. AMS1)” will have on “Attack (Attack Time).” With **positive (+) values** of “**Intensity (AMS1 Intensity)**,” setting this parameter to + will allow AMS1 to lengthen the time, and setting it to - will allow AMS1 to shorten the time. With a setting of **0** there will be no effect.

**Dc (AMS1 SW Decay)** [-, 0, +]

Specifies the direction of the effect that “AMS1 (Time Mod. AMS1)” will have on “Decay (Decay Time).” With **positive (+) values** of “**Intensity (AMS1 Intensity)**,” setting this parameter to + will allow AMS1 to lengthen the time, and setting it to - will allow AMS1 to shorten the time. With a setting of **0** there will be no effect.

**SI (AMS1 SW Slope)** [-, 0, +]

Specifies the direction of the effect that “AMS1 (Time Mod. AMS1)” will have on “Slope (Slope Time).” With **positive (+) values** of “**Intensity (AMS1 Intensity)**,” setting this parameter to + will allow AMS1 to lengthen the time, and setting it to - will allow AMS1 to shorten the time. With a setting of **0** there will be no effect.

**RI (AMS1 SW Release)** [-, 0, +]

Specifies the direction of the effect that “AMS1 (Time Mod. AMS1)” will have on “Release (Release Time).” With **positive (+) values** of “**Intensity (AMS1 Intensity)**,” setting this parameter to + will allow AMS1 to lengthen the time, and setting it to - will allow AMS1 to shorten the time. With a setting of **0** there will be no effect.

Amp 1 EG changes (Time)

(AMS=Amp KTrk +/-, Intensity = a positive (+) value)  
 (When Amp Keyboard Track (4-2a) Low Ramp= a positive (+) value, and High Ramp = a positive (+) value)

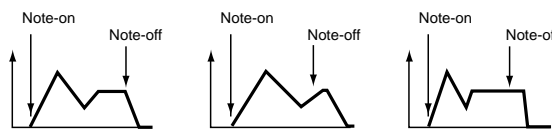

Settings of 4-3a: Amp 1 EG  
 Low-pitched note played with “At,” “Dc,” “SI,” and “RI” at +  
 High-pitched note played with “At,” “Dc,” “SI,” and “RI” at -

Amp 1 EG changes (Time) (AMS=Velocity, Intensity= a positive (+) value)

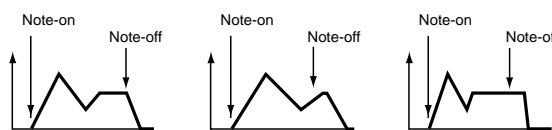

Softly played note with “At,” “Dc,” “SI” and “RI” at + (settings of 4-3a: Amp 1 EG)  
 Strongly played note with “At,” “Dc,” “SI” and “RI” at +  
 Strongly played note with “At,” “Dc,” “SI” and “RI” at -

**AMS2 (Time Mod. AMS2)** [Off, (KT, EXT)]

**Intensity (AMS2 Intensity)** [-99...+99]

**At (AMS2 SW Attack)** [-, 0, +]

**Dc (AMS2 SW Decay)** [-, 0, +]

**SI (AMS2 SW Slope)** [-, 0, +]

**RI (AMS2 SW Release)** [-, 0, +]

These parameters specify how “AMS2 (Time Mod. AMS2)” will control the amp 1 EG *Time* parameters (<sup>Ⓔ</sup>“AMS1 (Time Mod. AMS1)”-“RI (AMS1 SW Release)”).

**▼ 4-3: Page Menu Command**

0-1A	Write Program
1-1A	Copy Oscillator
1-1B	Swap Oscillator
4-3A	Sync Both EGs

**4-3A: Sync Both EGs**

When you select the page menu command “**Sync Both EGs**,” a check mark will appear at the left of “Sync Both EGs.” In this state, you can edit the amp 1 EG and amp 2 EG simultaneously. (Editing either EG will change the settings of both EGs.) (<sup>Ⓔ</sup>3-4A)

**4-4: Amp2 Level/Pan**

**4-5: Amp2 Mod.**

**4-6: Amp2 EG**

These are the parameters for amp 2 (used for oscillator 2). (<sup>Ⓔ</sup>“4-1: Amp1 Level/Pan”-“4-3: Amp 1 EG.”) These will appear when “**Oscillator Mode**” (1-1a) is **Double**.

## Program P5: Edit-Common LFO

Here you can make settings for the LFO that can be used to cyclically modulate the Pitch, Filter, and Amp of oscillators 1 and 2. There are two LFO units for each oscillator. By setting the LFO1 or LFO2 Intensity to a negative (-) value for Pitch, Filter, or Amp, you can invert the LFO waveform.

### 5-1: OSC1 LFO1 AMSource

Make settings for the "OSC1 LFO1," which is the first LFO that can be used for oscillator 1.

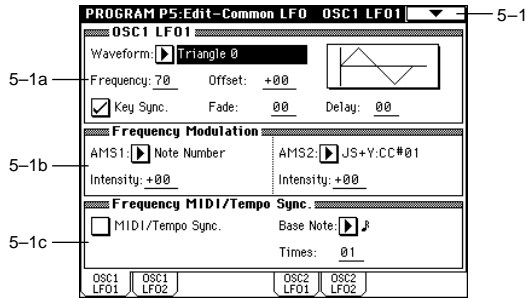

#### 5-1a: OSC1 LFO1

**Waveform** [Triangle 0...Random6 (Vector)]

Selects the LFO waveform.

The numbers that appear at the right of some of the LFO waveforms indicate the phase at which the waveform will begin.

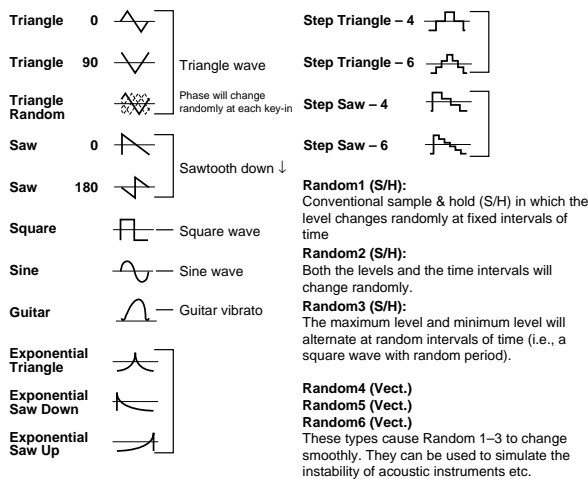

**Frequency** [00...99]

Sets the LFO frequency. A setting of 99 is the fastest.

**Offset** [-99...+99]

Specifies the central value of the LFO waveform.

For example with a setting of 0 as shown in the following diagram, the vibrato that is applied will be centered on the note-on pitch. With a setting of +99, the vibrato will only raise the pitch above the note-on pitch, in the way in which vibrato is applied on a guitar.

When "Waveform" is set to **Guitar**, the modulation will occur only in the positive (+) direction even if you set "Offset" to 0.

Offset settings and pitch change produced by vibrato

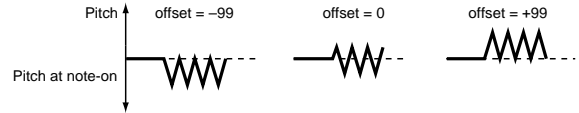

**Key Sync.** [Off, On]

**On (checked):** The LFO will start each time you press a key, and an independent LFO will run for each note.

**Off (unchecked):** The LFO effect that started when the first key was pressed will also apply to subsequently-played notes. (In this case, the delay and fade effects will apply only to the first-started LFO.)

**Fade** [00...99]

Specifies the time from when the LFO begins to apply until it reaches the maximum amplitude. When "Key Sync." is **Off**, the fade will apply only when the LFO is first started.

How "Fade" affects the LFO (when "Key Sync." is On)

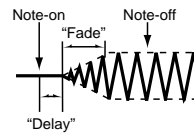

**Delay** [0...99]

Specifies the time from note-on until the LFO effect begins to apply.

When "Key Sync." is **Off**, the delay will apply only when the LFO is first started.

#### 5-1b: Frequency Modulation

You can use two alternate modulation sources to adjust the speed of the OSC1 LFO1.

**AMS1 (Freq. AMS1)** [Off, (PEG, FEG, AEG, LFO2, KT, EXT)]

Selects the source that will adjust the frequency of the oscillator 1 LFO1 ("AMS List" p.242). OSC1 LFO1 can be modulated by OSC1 LFO2.

**Intensity (AMS1 Intensity)** [-99...+99]

Specifies the depth and direction of the effect that "AMS1 (Freq. AMS1)" will have.

When this parameter is set to a value of **16, 33, 49, 66, 82**, or **99**, the LFO frequency being can be increased by a maximum of 2, 4, 8, 16, 32, or 64 times respectively (or decreased by 1/2, 1/4, 1/8, 1/16, 1/32, or 1/64 respectively).

For example if "AMS1 (Freq. AMS1)" is **Note Number**, **positive (+) values** of this parameter will cause the oscillator 1 LFO to speed up as you play higher notes. **Negative (-) values** will cause the oscillator 1 LFO to slow down as you play higher notes. This change will be centered on the C4 note.

If "AMS1 (Freq. AMS1)" is set to **JS +Y: CC#01**, higher settings for this parameter will cause the OSC1 LFO speed to become proportionately faster when you move the joystick. With a setting of +99, the LFO speed will be approximately 64 times faster when the joystick is pushed all the way away from yourself.

**AMS2 (Freq. AMS2)** [Off, (PEG, FEG, AEG, LFO2, KT, EXT)]

**Intensity (AMS2 Intensity)** [-99...+99]

Make settings for a second alternate modulation source that will adjust the frequency of the oscillator 1 LFO1. ("AMS1 (Freq. AMS1)," "Intensity (AMS1 Intensity)")

### 5-1c: Frequency MIDI/Tempo Sync.

MIDI/Tempo Sync. [Off, On]

**On (checked):** The LFO frequency will synchronize to the tempo (MIDI Clock). In this case, the values you specified for “Frequency” (5-1a) and *Frequency Modulation* (5-1b) will be ignored.

Base Note (Sync. Base Note)



Times (Sync. Times) [01...16]

When “MIDI/Tempo Sync.” is **checked**, these parameters set a note length relative to “↓ (Tempo)” and the multiple (“Times”) that will be applied to it. These parameters will determine the frequency of the OSC1 LFO1. For example if “Base Note (Sync. Base Note)” is ↓ (quarter note) and “Times (Sync. Times)” is **04**, the LFO will perform one cycle every four beats.

Even if you change the “↓ (Tempo)” setting of the arpeggiator or sequencer, the LFO will always perform one cycle every four beats.

### ▼ 5-1: Page Menu Command

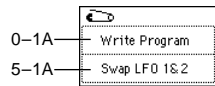

#### 5-1A: Swap LFO 1&2

This command exchanges the settings of LFO1 and 2. If LFO2 has been selected as Frequency Modulation “AMS1 (Freq. AMS1)” or “AMS2 (Freq. AMS2)” (5-1b) of LFO1, that setting will be cancelled for LFO2 after the LFO1 and 2 settings have been exchanged. If this is selected from the OSC1 LFO1 or OSC1 LFO2 page, the LFO1 and LFO2 of OSC1 will be exchanged.

- ① Select “**Swap LFO 1&2**” to access the dialog box.

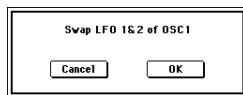

- ② Press the **OK** button to execute, or press the **Cancel** button to cancel without executing.

### 5-2: OSC1 LFO2 AMSource

Here you can make settings for the OSC1 LFO2, which is the second LFO that can be applied to oscillator 1. (☞ “5-1: OSC1 LFO1”) However in “Frequency Modulation” (5-1b), the LFO cannot be selected as a modulation source in “AMS1 (Freq. AMS1)” or “AMS2 (Freq. AMS2).”

### 5-3: OSC2 LFO1 AMSource

This can be used when “Oscillator Mode” (1-1a) is set to **Double**.

Here you can make settings for the OSC2 LFO1, which is the first LFO that can be applied to oscillator 2 (☞ “5-1: OSC1 LFO1”).

### 5-4: OSC2 LFO2 AMSource

This can be used when “Oscillator Mode” (1-1a) is set to **Double**.

Here you can make settings for the OSC2 LFO2, which is the second LFO that can be applied to oscillator 2 (☞ “5-1: OSC1 LFO1” and “5-2: OSC1 LFO2”).

## Program P7: Edit-Arpeggiator

Here you can make settings for the arpeggiator used by the program.

You can make settings so that when you select a program, these arpeggiator settings will automatically switch to the arpeggiator settings that are memorized in the selected program. (Global P0: 0-1c *Auto Arpeggiator* “Program”)

The arpeggiator can be switched on/off by the ARPEGGIATOR [ON/OFF] key. When on, the key LED will light. The settings of the ARPEGGIATOR [TEMPO] knob, [GATE] knob, [VELOCITY] knob, and [ON/OFF] key can be saved for each program.

These settings will be valid when “Auto Arpeggiator” **Program** is checked.

You can control the arpeggiator from an external sequencer, or record note data generated by the arpeggiator onto an external sequencer. (☞ p.266)

“Pattern,” “Resolution,” “Octave,” “Sort,” “Latch,” “Key Sync.,” “Keyboard,” and “↓ (Tempo)” can also be set from the P0: Play, Arpeggio page.

## 7-1: Arpeg. Setup

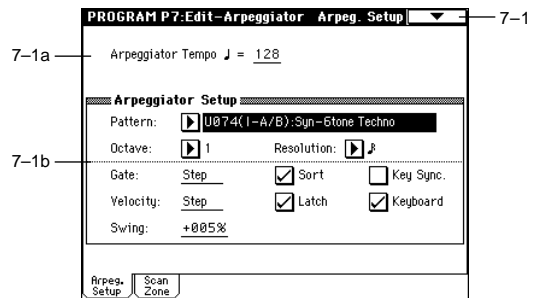

### 7-1a: Arpeggiator Tempo

↓ (Tempo)\* [040...240, EXT]

Sets the tempo.

This can also be set by the [ARPEGGIATOR TEMPO] knob. When “MIDI Clock” (Global P1: 1-1a) is set to either **External MIDI** or **External mLAN**, this parameter will indicate **EXT**, and the arpeggiator will synchronize to the MIDI Clock received from an external MIDI device.

## 7-1b: Arpeggiator Setup

Refer to BG p.130.

**Pattern\*** [P00...P04, U000(I-A/B)...U506(User)]

Selects the arpeggio pattern.

P00...P04	Preset arpeggio patterns
U000(I-A/B)...U199(I-A/B)	Preloaded arpeggio patterns
U200(E-A)...U215(E-A)	EXB-PCM series (user arpeggio patterns)
U216(E-B)...U231(E-B)	
U232(E-C)...U247(E-C)	
U248(E-D)...U263(E-D)	
U264(E-E)...U279(E-E)	
U280(E-F)...U295(E-F)	
U296(E-G)...U311(E-G)	
U312(User)...U506(User)	User arpeggio patterns (some preloaded arpeggio patterns)

**note** U000 (I-A/B)–U506 (User) are rewritable. Use Global P6 to create arpeggio patterns.

**note** Arpeggio patterns U000 (I-A/B)–U506 (User) can be selected using the numeric keys [0]–[9] and the [ENTER] key.

**Octave\*** [1, 2, 3, 4]

Specifies the number of octaves in which the arpeggio will be played.

**▲** If a user arpeggio pattern is selected, the range of the arpeggio will depend on the “Octave Motion” (Global P6: 6–1b) setting.

**Resolution\*** [♪<sub>3</sub>, ♪, ♪<sub>3</sub>, ♪, ♪<sub>3</sub>, ♪]

Specifies the timing resolution of the arpeggio. The notes of the arpeggio will be played at the interval you specify: ♪<sub>3</sub>, ♪, ♪<sub>3</sub>, ♪, ♪<sub>3</sub>, or ♪. The speed of the arpeggio pattern is determined by the “Arpeggiator Tempo” and the “Resolution.”

**Gate** [000...100(%) , Step]

Specifies the length (gate time) of each note in the arpeggio.

**000–100(%)**: Each note will be played with the specified gate time.

**Step**: This is available when an user arpeggio pattern U000 (I-A/B)–U506 (User) is selected for “Pattern.” When this is selected, the gate time specified for each step will be used. The gate time can also be controlled by the ARPEGGIATOR [GATE] knob. Rotating the knob toward the left will shorten the gate time, and rotating it toward the right will lengthen the gate time. When the knob is at the 12 o’clock position, the gate time will be as specified here.

**Velocity** [001...127, Key, Step]

Specifies the velocity of the notes in the arpeggio.

**001–127**: Each note will sound with the specified velocity value.

**Key**: Each note will sound with the velocity value at which it was actually played.

**Step**: This is available when an user arpeggio pattern U000 (I-A/B)–U506 (User) is selected for “Pattern.” When this is selected, the velocity specified for each step will be used. The velocity can also be controlled by the ARPEGGIATOR [VELOCITY] knob. Rotating the knob toward the left will decrease the velocity, and rotating it toward the right will increase the velocity. When the knob is at the 12 o’clock position, the velocity will be as specified here.

**Swing** [-100...+100(%)]

This parameter shifts the timing of the odd-numbered notes of the arpeggio.

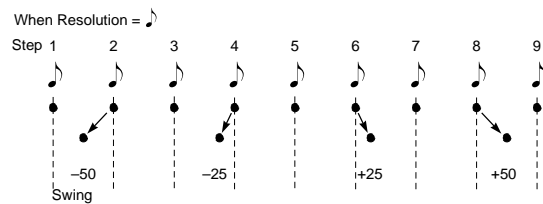

**Sort\*** [Off, On]

This specifies the order in which the notes you press will be arpeggiated.

**On (checked)**: Notes will be arpeggiated in the order of their pitch, regardless of the order in which you pressed them.

**Off (unchecked)**: Notes will be arpeggiated in the order in which you pressed them.

**Latch\*** [Off, On]

Specifies whether or not the arpeggio will continue playing after you take your hand off of the keyboard.

**On (checked)**: The arpeggio will continue playing after you remove your hand from the keyboard.

**Off (unchecked)**: The arpeggio will stop when you remove your hand from the keyboard.

**Key Sync.\*** [Off, On]

Specifies whether the arpeggio pattern will begin when you press a key, or whether it will always follow the “♪ (Tempo)” (0–1a).

**On (checked)**: The arpeggio pattern will start playing from the beginning when a note-on occurs from a condition where no keys are pressed. This setting is suitable when you are playing in realtime and want the arpeggio to play from the beginning of the measure.

**Off (unchecked)**: The arpeggio pattern will always play according to the “♪ (Tempo).”

**Keyboard\*** [Off, On]

This specifies whether the notes you play on the keyboard will be sounded as usual in addition to being sounded as part of the arpeggio (“keyboard” 0–2a).

**On (checked)**: The notes you play will be sounded on their own, in addition to being sounded as part of the arpeggio. For example if you simultaneously press two or more notes, they will be sounded as usual in addition to being played as arpeggiated notes.

**Off (unchecked)**: Only the arpeggiated notes will be heard.

**note** \*: These parameters can also be set from “P0: Play, Arpeggio.”

### ▼ 7-1: Page Menu Command

0-1A	Write Program
7-1A	Copy Arpeggiator

#### 7-1A: Copy Arpeggiator

This command can be used to copy arpeggio settings from another location to the current program.

- 1 Select "Copy Arpeggiator" to access the dialog box.

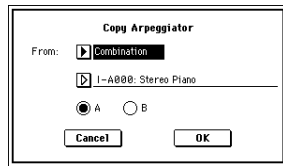

- 2 In "From" specify the source of the arpeggio settings (mode, bank, number) that you wish to copy.
- 3 If you are copying from Combination, Song, or Song Play mode, specify whether you wish to copy from A or B.
- 4 To execute the Copy Arpeggio operation, press the OK button. To cancel, press the Cancel button.

## 7-2: Scan Zone

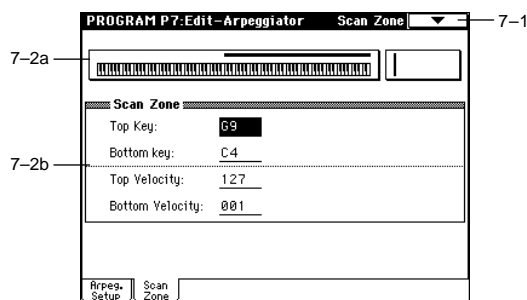

### 7-2a: Zone Map

This shows the *Scan Zone* setting.

### 7-2b: Scan Zone

**Top Key** [C-1...G9]

**Bottom Key** [C-1...G9]

These parameters specify the range of notes (keys) for which the arpeggiator will function. "Top Key" is the upper limit, and "Bottom Key" is the lower limit.

**Top Velocity** [001...127]

**Bottom Velocity** [001...127]

Specifies the range of velocities for which the arpeggiator will function. "Top Velocity" is the upper limit, and "Bottom Velocity" is the lower limit.

**note** Note number and velocity can also be entered by holding down the [ENTER] key and playing a note on the keyboard.

## Program P8: Edit-Insert Effect

For details on insertion effects, refer to p.178 "8. Effect Guide."

### 8-1: Routing

These settings specify the bus on which the output of the oscillator will be sent, and can be used to adjust the send levels to the master effects.

The following diagram shows the LCD screen when "Oscillator Mode" (1-1a) is set to **Double**.

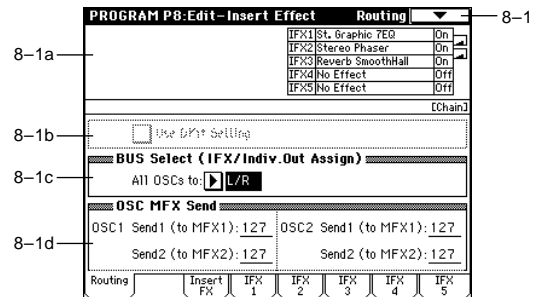

### 8-1a: Routing Map

This shows the status of the insert effects.

The insert effect routing, effect name, on/off status, and chain is shown. The types of insert effect, on/off, and chain settings are made in the P8: Edit-Insert Effect, Insert FX page.

### 8-1b: Use DKit Setting

**Use DKit Setting** [Off, On]

This will be available only when "Oscillator Mode" (1-1a) is set to **Drums**.

**On (checked):** The "BUS Select" (Global P5: 5-2a) setting for each key of the selected drum kit will be used. Check this when you want to apply an insert effect to an individual drum instrument, or to output an individual drum instrument to one of the AUDIO OUTPUT (INDIVIDUAL) jacks. If the "Oscillator Mode" is Single or Double, this setting has no effect.

**Off (unchecked):** The setting of the *BUS Select* (8-1c), *OSC MFX Send* (8-1d) parameter described below will be used. All drum instruments will be sent to the specified bus.

### 8-1c: BUS Select (IFX/Indiv.Out Assign)

**BUS Select (All OSCs to)**

[L/R, IFX1...5, 1...4, 1/2, 3/4, Off]

Specifies the bus to which oscillators 1 and 2 will be sent.

**▲** If this is set to 1/2 or 3/4, the oscillator pan settings (4-1b, 4-4) will be used to output the sound in stereo from AUDIO OUTPUT (INDIVIDUAL) 1/2 or 3/4. When the oscillator pan is controlled by CC#10 (pan) or AMS (Pan AMS), the sound will be output with the pan setting that is in effect at note-on. Unlike the case when this is set to L/R to output the sound from (MAIN) L/MONO and R, the pan of a sounding note will not change in realtime.

If you wish to adjust the pan in realtime during a note and output the sound from AUDIO OUTPUT (INDIVIDUAL) 1/2 or 3/4, set "BUS Select" to **IFX1** (or **IFX2-IFX5**), set "IFX1" (or **IFX2-IFX5**) to **000: No Effect**, and set the "BUS Sel. (BUS Select)" (8-2a) after passing through IFX to 1/2 or 3/4.

### 8-1d: OSC MFX Send

#### OSC1:

**Send1 (to MFX1)** [000...127]

Sets the volume (send level) at which the output of oscillator 1 will be sent to master effect 1. This is valid when "BUS Select" (8-1c) is set to **L/R** or **Off**.

If "BUS Select" is set to **IFX1**, **IFX2**, **IFX3**, **IFX4** or **IFX5**, the send levels to master effect 1 and 2 are set by "Send 1" and "Send 2" (8-2a) after passing through IFX 1/2/3/4/5 of the Insert FX pages.

**Send2 (to MFX2)** [000...127]

Sets the volume (send level) at which the output of oscillator 1 will be sent to master effect 2 (≡ "Send 1 (to MFX1)").

#### OSC2:

**Send1 (to MFX1)** [000...127]

**Send2 (to MFX2)** [000...127]

Sets the volume (send level) at which the output of OSC2 will be sent to master effects 1 and 2. These parameters will be valid when "Oscillator Mode" (1-1a) is set to **Double** and "BUS Select" is set to **L/R** or **Off**.

**MIDI** CC#93 will control the Send 1 level for OSC 1/2, and control change CC#91 will control the Send 2 level for OSC 1/2. These are controlled on the global MIDI channel "MIDI Channel" (Global P1: 1-1a). The actual send level is determined by multiplying these values with the send level setting of each oscillator.

### ▼ 8-1: Page Menu Command

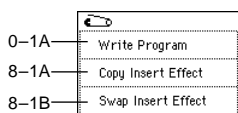

#### 8-1A: Copy Insert Effect

This command copies effect settings from Program, Combination, Song, Sampling mode, or Song Play mode.

- 1 Select "Copy Insert Effect" to access the dialog box.

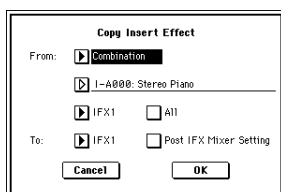

- 2 In "From" select the source mode, bank, and number of the effect to be copied.

**note** You can select a bank by pressing the [INT-A]-[EXB-G] keys.

- 3 Select which of the effects you wish to copy. You can also copy from a master effect. If "All" is checked, all effect settings will be copied (i.e., the contents of the Insert FX page and the effect parameters of IFX 1-5, but not "Ctrl Ch").

**!** If you are copying from a master effect, the result may not be identical, due to differences in the routing and level settings of a master effect.

- 4 Select the insert effect copy destination. If you check "Post IFX Mixer Setting," the "Chain," "Pan (CC#8)," "BUS Sel.," "Send 1" and "Send 2" settings that follow the copy source insert effect will also be copied. If this is unchecked, only the effect type and its parameters will be copied.

- 5 To execute the Copy Insert Effect command, press the **OK** button. To cancel, press the **Cancel** button.

#### 8-1B: Swap Insert Effect

This command swaps (exchanges) insert effect settings.

- 1 Select "Swap Insert Effect" to access the dialog box.

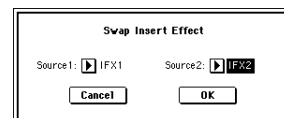

- 2 In "Source 1" and "Source 2," select each of the insert effects that you wish to swap.
- 3 To execute the Swap Insert Effect command, press the **OK** button. To cancel, press the **Cancel** button.

### 8-2: Insert FX

Here you can select the type of each insert effect, turn it on/off, and make chain settings.

The direct sound (**Dry**) of an insert effect is always stereo input and output. The input/output of the effect sound (**Wet**) will depend on the effect type (≡ p.178).

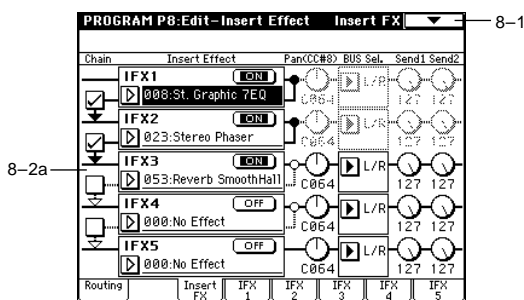

#### 8-2a: IFX1, 2, 3, 4, 5

**IFX1, 5** [000...089]

**IFX2, 3, 4** [000...102]

Selects the type of each insert effect.

For "IFX1" and "IFX5" you can select from 90 types of effect: **000: No Effect** - **089: Reverb-Gate**. Double-size effects cannot be used.

For "IFX2," "IFX3" and "IFX4" you can select from 103 types of effect: **000: No Effect** - **102: Hold Delay**.

If you select a double-size effect, the insert effect that follows will be unavailable. For example if you select a double-size effect for "IFX2," "IFX3" cannot be used. Up to two double-size effects can be used. (You can use a normal size effect for "IFX1," and double-size effects for "IFX2" and "IFX4.")

(≡ p.178)



Category/IFX Select menu:

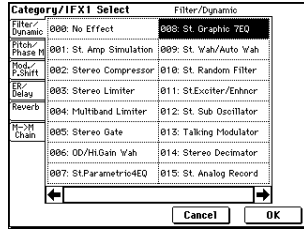

When you press the popup button, a “Category/IFX Select” list will appear. Press a tab to select a category of effects, and select an effect from that category. Press the **OK** button to execute, or press the **Cancel** button to cancel.

**IFX1, 2, 3, 4, 5 On/Off** [Off, ON]

Switches the insert effect on/off.

When this is **OFF**, the input will be output unchanged. (For **000: No Effect**, on/off will produce the same result.)

Each time you press this, the setting will alternate between on/off.

**MIDI** Control change #CC92 can be used to turn off all of the insert effects at once. A value of 0 will be off, and a value of 1–127 will be the original setting. This message is received on the global MIDI channel specified by “MIDI Channel” (Global P1: 1–1a).

**Chain** [Off, On]

Switch “chain” on/off for each insert effect.

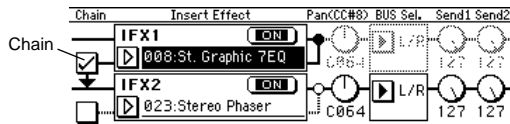

For example if the “Chain” check box between IFX1 and IFX2 is **checked**, IFX1 and IFX2 will be connected in series. If “BUS Select” (8–1c) is set to **IFX1**, IFX1 and IFX2 will be inserted in series.

A maximum of five insert effects (IFX1–IFX5) can be inserted in series. When effects are chained, the “PAN (CC#8),” “BUS Select,” “Send 1” and “Send 2” settings that follow the last IFX in the chain will be used.

**Pan(CC#8) (Post IFX PanCC#8)** [L000...C064...R127]

Sets the pan after the sound has passed through the insert effect. This setting is valid only when the following “BUS Select” is set to L/R (p.181).

**MIDI** CC#8 will control the pan of the sound after it has passed through the insert effect.

**BUS Sel. (BUS Select)** [L/R, 1, 2, 3, 4, 1/2, 3/4, Off]

Specifies the bus to which the sound will be sent after passing through the insert effect. Normally you will set this to **L/R**. If you wish to output to AUDIO OUTPUT (INDIVIDUAL), set this to **1, 2, 3, 4, 1/2, or 3/4**. The **Off** setting is used when you wish to use “Send 1” and “Send 2” and in addition connect to the master effects in series.

**Send1** [000...127]

**Send2** [000...127]

Sets the send levels to the master effects 1 and 2 for the sound that has passed through the insert effect. These settings are valid when “BUS Select” (8–2a) has been set to **L/R** or **Off**.

**MIDI** Control change CC#93 will control the Send 1 level, and control change CC#91 will control the Send 2 level. These messages are received on the global MIDI channel specified by “MIDI Channel” (Global P1: 1–1a).

**8–3: IFX 1**

**8–4: IFX 2**

**8–5: IFX 3**

**8–6: IFX 4**

**8–7: IFX 5**

Here you can set the effect parameters for the IFX 1/2/3/4/5 that were selected in the Insert FX page (p.187–).

**MIDI** Effect dynamic modulation (Dmod) is controlled on the global MIDI channel “MIDI Channel” (Global P1: 1–1a). (“D.mod” p.247)

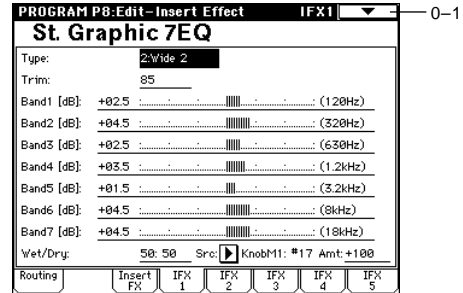

# Program P9: Edit-Master Effect

For details on the master effects, refer to p.182 “8. Effect Guide.”

## 9-1: Master FX

Here you can select the master effect types, switch them on/off, specify chain order, and set the master EQ.

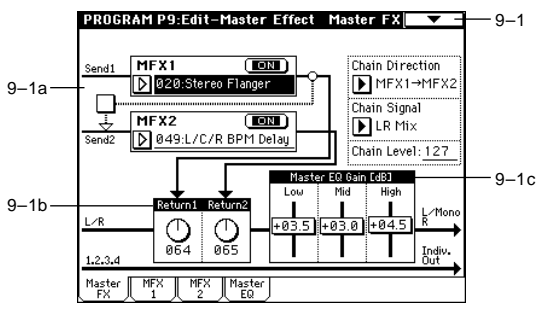

### 9-1a: MFX1, 2

The master effects do not output the direct sound (Dry). The return level (“Return1,” “Return2”) sends the effect sound (Wet) to the L and R bus, and this is mixed with the direct sound (i.e., the output from P8: Routing tab “BUS Select” L/R, or the L/R output from Insert FX page “BUS Select”). The master effects have a mono input. After passing through the oscillator and insert effects, sound that is panned L and R is mixed to a mono signal (as adjusted by the “Send 1” and “Send 2” levels) and input to the master effects.

The master effects are **mono-in stereo-out**. Even when a stereo-input type effect is selected, the input will be monaural.

### MFX1, 2 [000...089]

Selects the effect type for master effect 1 and 2. You can select from 90 types of effect: **000: No Effect-089: Reverb-Gate**. (Double-size effects cannot be selected.) If **000: No Effect** is selected, the output from the master effect will be muted.

**Category/MFX Select menu:**  
When you press the popup button, a “Category/MFX Select” menu will appear. Press a tab to select the desired category of effect, and select an effect from the list. Press the **OK button** to execute, or press the **Cancel button** to cancel.

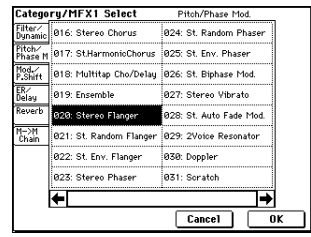

**MFX1, 2 On/Off [Off, ON]**  
Switches the master effects 1, 2 on/off. When off, the output will be muted. This will alternate between on and off each time it is pressed.

**CC#94** can be used to switch the MFX on and off. A value of 0 will be off, and a value of 1-127 will be the original setting. This is controlled on the global MIDI channel “MIDI Channel” (Global P1: 1-1a).

**Chain [Off, On]**  
**On (checked):** Chain (series connection) will be turned on for MFX1 and MFX2.  
**Off (unchecked):** MFX1 and MFX2 will operate in parallel.

**Chain Direction [MFX1→MFX2, MFX2→MFX1]**  
Specifies the direction of the connection when MFX1 and MFX2 are chained.

**MFX1→MFX2:** Connect from MFX1 to MFX2.  
**MFX2→MFX1:** Connect from MFX2 to MFX1.

**Chain Signal [LR Mix, L Only, R Only]**  
When chain is On, this parameter specifies how the stereo output signal of the first master effect will be connected to the input (mono) of the next master effect.

**L/R Mix:** The stereo output L/R of the first master effect will be mixed before being input to the next master effect.  
**L Only, R Only:** Only the left or right channel of the output will be input to the next master effect.

**Chain Level [000...127]**  
When chain is On, this sets the level at which the sound is sent from the first master effect to the next master effect.

### 9-1b: Return Level

**Return 1, 2 [000...127]**  
Adjusts the return levels from the master effects to the L/R bus (main output L/MONO, R).

### 9-1c: Master EQ Gain [dB]

Sets the gain for the three-band EQ located immediately before the sound of the L/R bus is sent from the AUDIO OUTPUT (MAIN OUT) L/MONO and R jacks. This is linked with the various “Gain” parameters of Master EQ (9-4).

**Low [-18.0...+18.0]**  
**Mid [-18.0...+18.0]**  
**High [-18.0...+18.0]**

The cutoff frequency for “Low,” “Mid” and “High” and the “Q” of “Mid” can be adjusted in the Master EQ page. These settings are in “dB” units.

## ▼ 9-1: Page Menu Command

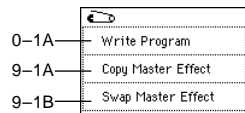

### 9-1A: Copy Master Effect

This command lets you copy any desired effect settings from Program, Combination, Song, Sampling, or Song Play mode.

- 1 Select "Copy Master Effect" to access the dialog box.

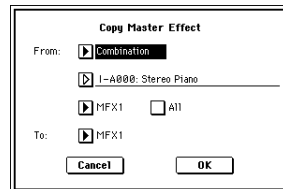

- 2 In "From," select the copy source mode, bank, and number.
- 3 Select the effect that you want to copy.  
If you select **MFX1** or **MFX2**, "Return" (return level) will be copied at the same time.  
If you select **Master EQ**, only the master EQ settings will be copied.  
You can select from an insert effect by selecting **IFX 1-5**.  
If you check "All," all settings for the master effects and master EQ will be copied.

If you are copying from an insert effect, differences in routing and level will mean that the result will not be completely identical.

- 4 In "To," specify the copy destination master effects.
- 5 To execute the Copy Master Effect command, press the **OK** button. To cancel, press the **Cancel** button.

### 9-1B: Swap Master Effect

This command swaps (exchanges) the settings of MFX1 and MFX2.

- 1 Select "Swap Master Effect" to access the dialog box.

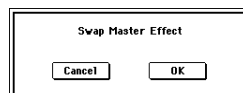

- 2 To execute the Swap Master Effect command, press the **OK** button. To cancel, press the **Cancel** button.

## 9-2: MFX 1

## 9-3: MFX 2

Makes effect parameter settings for the MFX1 and 2 effects that were selected in the Master FX page (9-2). (ref. p.187-)

**MIDI** Effect dynamic modulation (Dmod) is controlled on the global MIDI channel "MIDI Channel" (Global P1: 1-1a). ("D.mod" ref. p.247)

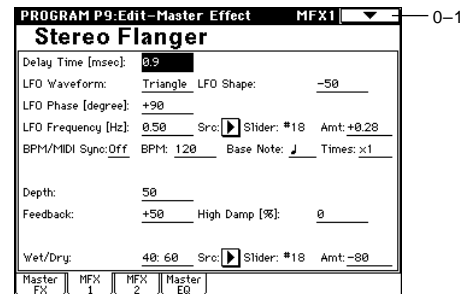

## 9-4: Master EQ

The master EQ is a three-band stereo EQ. It is used to adjust the overall tonality of the sound immediately before the L/R bus is output to the AUDIO OUTPUT (MAIN OUT) L/MONO and R jacks (ref. p.239).

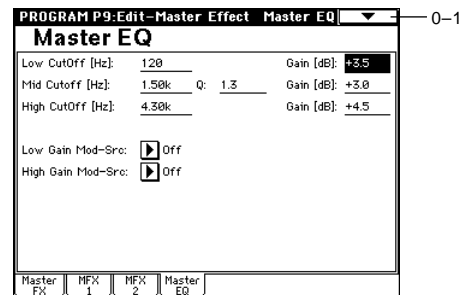

The MEQ High Gain and MEQ Low gain can be controlled by assigning a modulation source to the "Low Gain Mod-Src:" and the "High Gain Mod-Src:" functions on this page.

# 2. Combination mode

## Combination P0: Play

In this display page you can select and play Combinations. A Combi allows you to use up to eight programs at once.

### 0-1: Prog. Select (Program Select)



#### 0-1a: Bank, Combination Select, 10's Hold, Category, J

#### Bank (Bank Select) [Bank INT-A...INT-E, EXB-A...EXB-G]

This is the Combination bank display. Press one of the BANK [INT-A]–[EXB-G] keys to select a bank.

Each of the rewritable banks INT-A–INT-E and EXB-A–EXB-G contain 128 (a total of 1,536) combination program areas.

INT-A...INT-D	Preloaded combinations
INT-E	User combinations, EXB-MOSS combinations
EXB-A...EXB-G	User combinations, EXB-PCM series combinations

**!** If you have selected the “Bank/Program (Program Select)” (0-1d) edit cell for a timbre 1–8 in the Prog. Select page, BANK [INT-A]–[EXB-G] will switch the program banks for timbres 1–8.

#### Combination Select [0...127]

Here you can select the desired combination. When this parameter is selected, you can select combinations using the numeric keys [0]–[9], [VALUE] dial, or [Δ], [▽] keys. When you press the popup button, the Bank/Combination Select menu will appear. Here you can select combinations by bank.

**MIDI** You can select combinations by transmitting MIDI program changes from a connected external MIDI device, or by using a foot switch. (“Foot SW Assign” Global P2: 2-1a, “Foot Switch Assign List” p.251)

Bank/Combination Select menu:

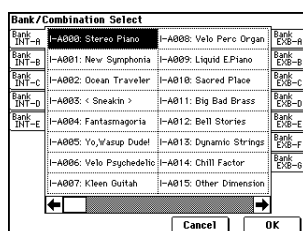

- Press the **popup button** located at the left of “Combination Select” to access the Bank/Combination Select menu.
- Press one of the tabs located at the left or right to select a bank.
- Select a combination from the list. You can directly press your choice within the list, or use the [Δ] [▽] keys.
- Press the **OK button** to execute, or press the **Cancel button** to cancel your selection.

#### Category

[00...15]

Select the combination category.

Each combination is assigned to one of 16 categories. You can choose a category, and select from the combinations included in that category. When you press the popup menu button, the Category/Combination Select menu will appear.

Category/Combination Select menu:

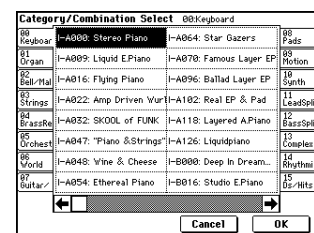

- Press the **(category) popup button** located at the top of “Combination Select” to access the Category/Combination Select menu.
- Press one of the tabs at left or right to select a category.
- Select a combination from the list. You can directly press your choice within the list, or use the [Δ] [▽] keys.
- Press the **OK button** to execute, or press the **Cancel button** to cancel your selection.

The category of each combination can be specified in the “Write Combination” (0-1A) dialog box.

#### 10's Hold

- Press the [./10's HOLD] key to display **10's Hold**. The 10's place of the combination number will be held (fixed).
- Press any **numeric key [0]–[9]** to input the 1's place of the combination number with a single keystroke.
- You can use the [Δ], [▽] keys to change the value of the 10's place.
- To cancel, press the [./10's HOLD] key to turn off the **10's Hold** display.

#### J (Tempo) [040...240, EXT]

This sets the tempo of the arpeggiator. The tempo can also be adjusted by the ARPEGGIATOR [TEMPO] knob. A display of **EXT** indicates that the “MIDI Clock” setting (Global P1: 1-1a) has been set to **External MIDI** or **External mLAN**, and that the arpeggiator will synchronize to MIDI Clock messages received from an external MIDI device.

## 0-1b: Selected Timbre Information

This displays information on the selected timbre (1-8).

**T (Timbre)** [01...08]

Indicates the timbre number and the bank/number/name of the program that is selected for the timbre.

**Ch** [01...16, Gch]

Indicates the MIDI channel number specified for the timbre.

## 0-1c: Timbre Number, Category, Bank/Program, Status

**Timbre Number** (1...8)

Indicates the timbre number.

The parameters below "Timbre Number" let you make settings for that timbre.

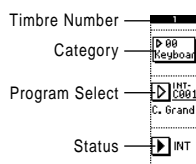

**Category** [00...15]

The program for each timbre can be selected by program category. All programs are classified into one of sixteen categories. After you select a particular category, you can choose a program from that category.

When you press the popup button, the Category/Timbre Program Select menu will appear. ("Category/Program Select menu" Program P0: 0-1a)

**Bank/Program (Program Select)**  
[INT-A...INT-F, G, g(1)...g(9), g(d), EXB-A...EXB-G]

Specifies the program that will be used by the timbre. Part of the program name is displayed in the line below.

When "Bank/Program (Program Select)" is selected, you can use the BANK [INT-A]-[EXB-G] keys or the VALUE controllers to choose.

When you press the popup button, the Bank/Timbre Program Select menu will appear, and you can select a program ("Bank/Program Select menu" Program P0: 0-1a).

**note** When "Bank/Program (Program Select)" is selected, one of the BANK key LEDs will light to indicate the bank of the selected program.

**Bank INT-F** can be selected only if you have installed the EXB-MOSS option. When installed, the 128 special EXB-MOSS programs will be available.

**MIDI** When you select a combination on the TRITON STUDIO, a MIDI program change for the selected combination number will be transmitted on the global MIDI channel "MIDI Channel" (Global P1: 1-1a). At the same time, bank select, program change, and volume (CC#7) messages will be transmitted on the MIDI channel specified for each timbre whose "Status" (0-1c, 2-1b) is set to **EXT** or **EX2**. However, these messages will not be transmitted for timbres that are set to the same MIDI channel as the global MIDI channel. In this case, **EX2** timbres will show the "Bank/Program (Program Select)" Bank as "-", and will transmit the bank number that was specified in "Bank Select" (2-1b). MIDI messages transmitted when you operate the TRITON STUDIO are transmitted on the global MIDI chan-

nel. At the same time, timbres whose "Status" is **EXT** or **EX2** will transmit the same messages on their own MIDI channel.

If bank select and program change messages are received on a MIDI channel that matches the MIDI channel of a timbre whose "Status" is **INT**, the program of that timbre will change. However if the MIDI channel of the incoming message matches the global MIDI channel "MIDI Channel," then the combination will change.

If you do not want the combination to change, you can either change the global MIDI channel so that it does not match the channel on which the program change messages are being received, or you can **uncheck** "Enable Combination Change" (Global P1: 1-1b). You can also **uncheck** "Enable Bank Change" (Global P1: 1-1b) so that only the program number will change and the bank will remain the same.

If you wish to change the program assigned to certain timbres without changing the combination, you can also set "Enable Program Change" (3-1a) so that the program will change on certain timbres but not on others.

**note** "Category" and "Bank/Program (Program Select)" can also be specified from P1: Edit-Program/Mixer.

**Status** [INT, Off, EXT, EX2]

Specifies the status of MIDI and the internal tone generator for each timbre.

**INT:** When you play TRITON STUDIO, the internal tone generator will sound, and will also sound in response to MIDI messages received from an external MIDI device.

**Off:** The timbre will not sound. Nor will MIDI data be transmitted.

**EXT:** Playing TRITON STUDIO will not cause it to sound, but it will transmit data via MIDI to control external MIDI devices.

**EX2:** The "Bank Select" (2-1b) LSB value and MSB value will be valid. Instead of the INT-A-EXB-G bank numbers that can be selected on the TRITON STUDIO, the bank number specified by "Bank Select" (2-1b) will be transmitted via MIDI. Other aspects are the same as for **EXT**.

**note** "Status" can also be set in the P2: Edit-Trk Param, MIDI Ch page.

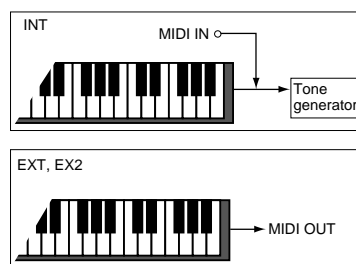

## ▼ 0-1: Page Menu Command

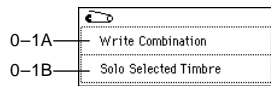

### 0-1A: Write Combination

This command writes an edited combination into the TRITON STUDIO's internal memory. Be sure to write any combination that you wish to save. If the power is turned off or a different combination selected before you write an edited combination, your edits cannot be recovered.

For the procedure, refer to "Write Program" (Program P0: 0-1A).



If you use "Category" to specify a category for the combination you are writing, you will be able to select that combination by its category in Combination P0: Play.

The names of the combination categories can be edited in "Comb Cat." (Global P4: 4-2).

**note** You can also use the SEQUENCER [REC/WRITE] key to write a combination in the same way as "Write Combination." Press the SEQUENCER [REC/WRITE] key to access the dialog box, and write the combination. In this case, the data will be written to the currently selected combination.

### 0-1B: Solo Selected Timbre

The Solo function will toggle between on and off each time you select "Solo Selected Timbre."

- ① Select the page menu command "Solo Selected Timbre." When you select this, a check mark will appear at the left of "Solo Selected Timbre" in the menu, and the Solo function will be on.
- ② In pages that show parameters for an individual timbre, you can select a particular timbre to Solo (in P0: Play, Program Select page "Bank/Program," etc.) so that only this timbre will sound and the other timbres will be muted. The "Selected Timbre Information" (0-1b) in each page will indicate [Solo.] To solo a different timbre, select a parameter of the timbre that you wish to solo.
- ③ To cancel the Solo function, once again select "Solo Selected Timbre" from the page menu.

**note** If a timbre that is muted by the Solo function has been set to a "Status" (0-1c, 2-1b) of EXT or EX2, MIDI note-on/off messages will not be transmitted by that timbre.

## 0-2: Mixer

Here you can set the pan and volume for each timbre 1-8.

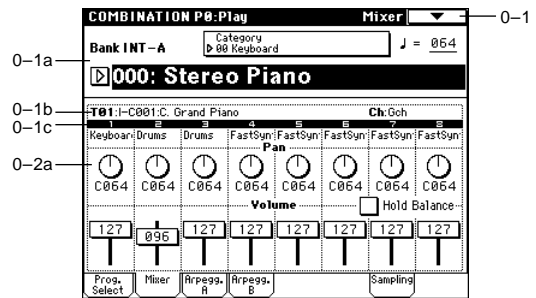

### 0-2a: Program Category, Pan, Volume, Hold Balance

#### Program Category

Part of the program category name for the timbre program is displayed here.

#### Pan

[RND, L001...C064...R127]

Sets the pan for each timbre 1-8.

**L001...C064...R127:** A setting of **L001** is far left and **R127** is far right. A setting of **C064** will reproduce the pan setting of the oscillator in Program mode.

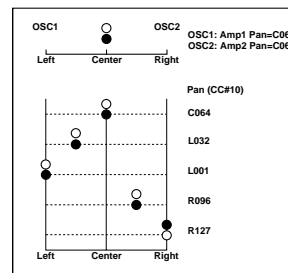
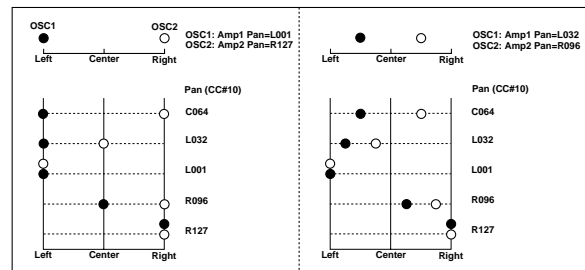

If a mono insert effect is in use, the settings you make here will be ignored. In this case, the "Pan (CC#8)" (P8: 8-2) parameter in Insert FX page will adjust the panning of the sound after the insertion effect ("3. Mixer" p.181).

**RND:** The oscillator pan will change randomly at each note-on.

**MIDI** If "Status" (0-1c, 2-1b) has been set to INT, MIDI control change #10 (panpot) messages can be received to control the setting. CC#10 values of 0 or 1 will place the sound at far left, 64 at center, and 127 at far right. Pan can be controlled by messages received on the "MIDI channel" (2-1b).

**Volume** [000...127]

Adjusts the volume of each timbre 1–8.

**MIDI** The volume of each timbre is determined by multiplying this volume value with the MIDI volume (CC#7) and expression (CC#11). If “Status” (0–1c, 2–1b) has been set to INT, incoming MIDI CC#7 or CC#11 messages will control the volume of a timbre. (However these messages will not affect the setting of this parameter.)

If “Status” is EXT or EX2, the value of this parameter will be transmitted as MIDI CC#7 when the combination is changed. However this will not be transmitted by a timbre that is set to the same MIDI channel as the global MIDI channel. This message is transmitted on the “MIDI channel” (2–1b) specified for each timbre.

**note** “Pan” and “Volume” can also be set from P1: Edit-Program/Mixer.

**Hold Balance** [Off, On]

**On (checked):** When any one of the volume sliders is moved, the volume of the other timbres will change as well. The volume balance of timbres 1–8 will be maintained. This is useful when you wish to adjust the overall volume.

**0–3: Arpegg. A (Arpeggio Play A)**

**0–4: Arpegg. B (Arpeggio Play B)**

Here you can make arpeggiator settings for the combination. A combination can run two arpeggiators simultaneously. Arpeggiator parameters can be edited in P7: Edit-Arp., but certain major parameters can be edited in these pages as well. You can edit these parameters in realtime, for example by changing the arpeggio pattern while playing in Combination P0: Play.

To save the edits you make, use “Write Combination.” The arpeggiator can also be edited in realtime by the ARPEGGIATOR [TEMPO] knob, [GATE] knob, and [VELOCITY] knob.

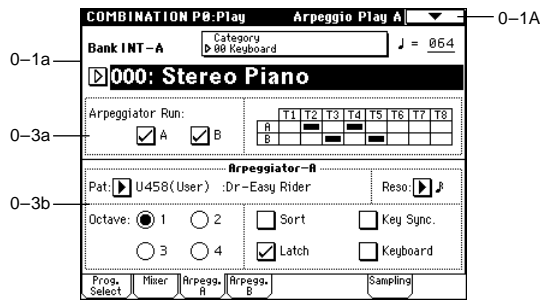

**0–3a: Arpeggiator Run A, B, Timbre assign**

**Arpeggiator Run A, B**

When the ARPEGGIATOR [ON/OFF] key is on, the arpeggiator(s) you checked here will run if they are assigned to a timbre by “Arpeggiator Assign” (7–1b).

When the arpeggiator is on, these check boxes let you turn A and B on/off.

This parameter can also be set from P7: Edit-Arp. Setup page “Arpeggiator Run A, B.”

**Timbre assign**

This indicates the arpeggiator A and B assignment status for each timbre 1–8. These settings are made in “Arpeggiator Assign” (7–1b).

**0–3(4)b: Arpeggiator A (B)**

- Pat (Pattern) [P00...P04, U000(I-A/B)...U506(User)]
- Octave [1, 2, 3, 4]
- Reso (Resolution) [1/2, 3/4, 1, 2, 3, 4]
- Sort [Off, On]
- Latch [Off, On]
- Key Sync. [Off, On]
- Keyboard [Off, On]

Set the various parameters of the combination arpeggiator (“Program P7: Edit-arpeggiator”).

These parameters can also be set from 7–2(3): Arpegg. A(B).

**0–5: Sampling**

Here you can adjust the settings for the analog/digital audio signal input (AUDIO INPUT, S/P DIF, EXB-mLAN), and the sampling-related settings for Combination mode.

As in Program mode, sampling in Combination mode allows you to sample an incoming audio signal or to resample a TRITON STUDIO performance. (≡Program P0: 0–3)

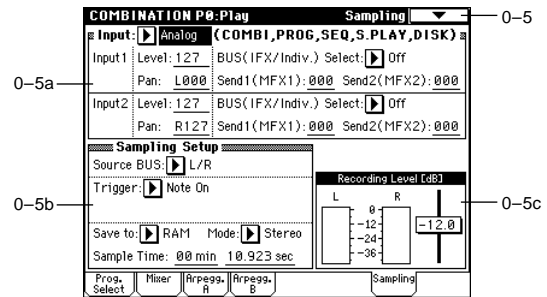

**0–5a: Input**

**Input** [Analog, S/P DIF, mLAN]

**Input1:**

**Input2:**

**Level** [0...127]

**Pan** [L000...C064...R127]

**BUS(IFX/Indiv.) Select** [L/R, IFX1...5, 1, 2, 3, 4, 1/2, 3/4, Off]

**Send1(MFX1), Send2(MFX2)** [000...127]

Specify the input source analog/digital audio device, and set the input level, pan, bus, and master effect sends.

**note** Input settings are valid in Combination, Program, Sequencer, Song Play, and Disk modes. (≡Global P0: 0–3a)

## 0-5b: Sampling Setup

Source BUS [L/R, Indiv.1/2]  
 Trigger [Sampling START SW, Note On]  
 Metronome Precount [Off, 4, 8, 3, 6]  
 Save to [RAM, DISK]  
 Mode (Sample Mode) [L-Mono, R-Mono, Stereo]  
 Sample Time [min sec]

Make settings for sampling in Combination mode. (☞ Program P0: 0-3)

**note** Sampling Setup settings apply to the entire Combination mode; not to an individual combination.

## 0-5c: Recording Level [dB]

### ADC OVERLOAD !!

Recording Level [-inf, -72.0... 0.0...+18.0dB]

Adjusts the signal level at the final stage of sampling in Combination mode. (☞ Sampling P0: 0-1d)

This setting defaults to -12 dB when you turn on the power. At a setting of -12 dB, CLIP will not appear even if you play the Combination at its maximum level. (☞ Program P0: 0-3c "Recording Level")

## ▼ 0-5: Page Menu Command

☞ 0-1A: Write Combination, 0-1B: Solo Selected Timbre,  
 Program P0: 0-3A: Metronome Setup,  
 Program P0: 0-3B: Optimize RAM,  
 Program P0: 0-3C: Select Bank & Smpl No.,  
 Program P0: 0-3D: Select Directory

## Combination P1: Edit-Program/Mixer

### 1-1: Program/Mixer

For each timbre 1-8, set the bank, program, pan and volume.

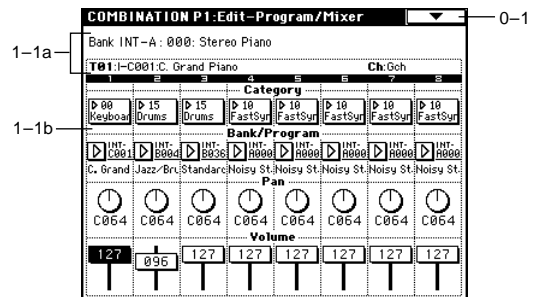

#### 1-1a: Combination Name, Selected Timbre Information

##### Combination Name

This shows the combination bank, number, and name selected in Combination P0: Play.

##### Selected Timbre Information

Displays information about the selected timbre (1-8). (☞ P0: 0-1b)

#### 1-1b: Timbre Number, Category, Program Select, Pan, Volume

Timbre Number (1...8)

Category [00...15]

Bank/Program (Program Select) [INT-A...INT-F, G, g(1)...g(9), g(d), EXB-A...EXB-G]

Selects the program for each timbre.

These parameters can also be set from the P0: Play, Program Select page. (☞ P0: 0-1c)

Pan [RND, L001...C064...R127]

Volume [000...127]

Specifies the pan and volume of each timbre.

These parameters can also be set from the P0: Play, Mixer page. (☞ P0: 0-2a)



## Combination P2: Edit-Trk Param

### 2-1: MIDI Channel (MIDI Ch)

Here you can make MIDI settings for each timbre.

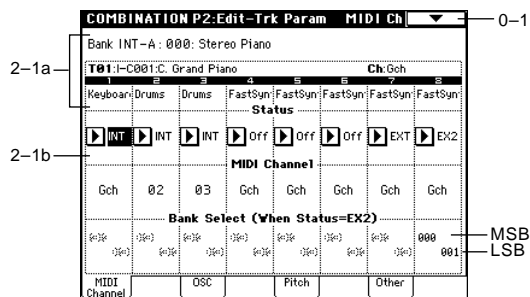

### 2-1a: Combination Name, Selected Timbre Information, Timbre Number, Program Category

#### Combination Name

Displays the bank, number, and name of the combination selected in Combination P0: Play.

#### Selected Timbre Information

Displays information about the selected timbre (1-8). (≡P0: 0-1b)

#### Timbre Number (1...8)

Displays the timbre number. (≡P0: 0-1c)

#### Program Category

Displays the category of the program assigned to the timbre. (≡P0: 0-2a)

### 2-1b: Status, MIDI Channel, Bank Select

#### Status [INT, Off, EXT, EX2]

“Status” can also be set from the P0: Play, Program Select page. (≡P0: 0-1c)

#### MIDI Channel [01...16, Gch]

Sets the MIDI transmit/receive channel for each timbre 1-8.

**Gch:** The timbre will use the channel that has been selected as the global MIDI channel “MIDI Channel” (Global P1: 1-1a).

When “Status” is INT, MIDI messages will be received on the channel you specify here. If this setting is the same as the global MIDI channel, the internal tone generator will sound according to the internal settings. If this is set to **EXT** or **EX2**, playing the TRITON STUDIO will transmit MIDI messages on the MIDI channel specified here. (Messages will also be transmitted simultaneously on the global MIDI channel.)

#### Bank Select (When Status=EX2) [000:000...127:127]

Specifies the bank number that will be transmitted when “Status” is set to **EX2**. The value at left is the MSB, and the value at right is the LSB.

This setting has no effect if “Status” is other than **EX2**.

### 2-2: OSC

These settings specify how each timbre will be played.

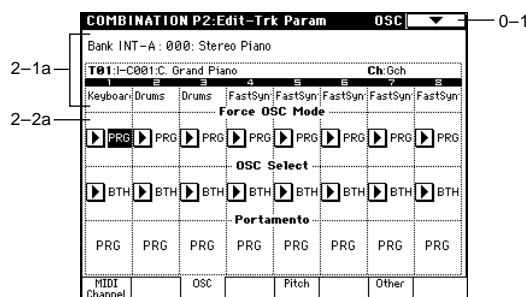

### 2-2a: Force OSC Mode, OSC Select, Portamento

#### Force OSC Mode [PRG, Poly, MN, LGT]

Specifies the *Voice Assign Mode* (Program P1: 1-1b) of the program selected for each timbre 1-8.

**PRG:** The settings of the program will be used.

**Poly:** The timbre will play polyphonically, regardless of the settings of the program.

**MN (Mono):** The timbre will play monophonically, regardless of the settings of the program.

**LGT (Legato):** The timbre will play monophonically, with single triggering (legato).

When using MN or LGT settings, the note priority will follow the “Priority” (Program P1: 1-1b) setting of the program.

#### OSC Select [BTH, OS1, OS2]

Specifies the “Oscillator Mode” of the program selected for each timbre 1-8. If the “Oscillator Mode” (Program P1: 1-1a) is **Double**, you can specify that either or both oscillators sound.

**BTH (Both):** OSC1 and 2 will sound as specified by the settings of the program.

**OS1:** Only OSC1 will sound.

**OS2:** Only OSC2 will sound. (If “Oscillator Mode” is **Single** or **Drums**, there will be no sound.)

#### Portamento [PRG, Off, 001...127]

Make portamento settings for each timbre 1-8.

**PRG:** Portamento will be applied as specified by the program settings.

**Off:** Portamento will be off, even if the original program settings specified for it to be on.

**001...127:** Portamento will be applied with the portamento time you specify here, even if it is turned off by the program settings.

**MIDI** If the “Status” (0-1c, 2-1b) is set to INT, CC#05 (portamento time) and CC#65 (portamento switch) messages will be received and will control and change these settings. (If the setting is PRG, CC#05 portamento time will not be received.) These messages will be received on the MIDI channel specified for each timbre by “MIDI Channel” (2-1b).

## 2-3: Pitch

Here you can make pitch-related settings for each timbre.

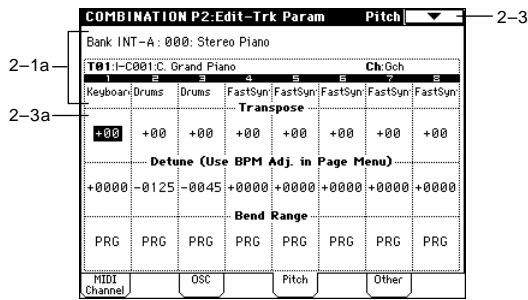

### 2-3a: Transpose, Detune, Bend Range

**Transpose** [-24...+24]

Adjusts the pitch of each timbre in semitone steps.  
12 units equal one octave.

**MIDI** When "Status" (0-1c, 2-1b) is INT, this parameter will affect the pitches sounded by the TRITON STUDIO. When "Status" is EXT, this parameter will affect the note numbers of the MIDI note messages that are transmitted.

For example if you make settings of +04 and +07 respectively for two timbres that are set to EXT, playing the C key will transmit a C note number on the global MIDI channel, and at the same time will also transmit E and G note numbers on the MIDI channels of those timbres.

**Detune (Use BPM Adj. in Page Menu)** [-1200...+1200]

Adjusts the pitch of each timbre in one-cent units.

0: Normal pitch.

**note** You can also use the "Detune BPM Adjust" page menu command to automatically make a detune setting from a calculation in BPM units.

**MIDI** "Transpose" and "Detune" can be controlled via MIDI RPN messages. Depending on the "Oscillator Mode" (Program P1: 1-1a) settings of the programs used by timbres 1-8, they can be controlled as follows.

When "Oscillator Mode" is **Single** or **Double** MIDI RPN Coarse Tune can be received to control and change the setting of "Transpose," and RPN Fine Tune can be received to control and change the setting of "Detune."

When "Oscillator Mode" is **Drums** MIDI RPN Coarse Tune and Fine Tune can be received to control and change the setting of "Detune." The controllable range is ±1 octave for coarse tune and fine tune together.

**Bend Range** [PRG, -24...+24]

Specifies the amount of pitch change that will occur when the pitch bender is operated, in semitone units.

**PRG:** The pitch range specified by the program will be used.  
**-24+24:** This setting will be used regardless of the setting in the program.

**MIDI** The MIDI RPN Pitch Bend Change message can be received to control this and change the setting. (However it will not be received if this parameter is set to **PRG**.) This message is received on the MIDI channel for each timbre set by "MIDI Channel" (2-1b).

## ▼ 2-3: Page Menu Command

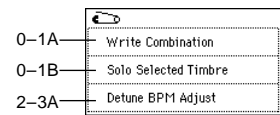

### 2-3A: Detune BPM Adjust

If the program of a timbre uses a phrase or rhythm loop multisample (or sample that was created in the Sampling mode) is matched to a specific BPM, you can use this Utility to modify its BPM value. "Detune BPM Adjust" changes the BPM of a phrase or rhythm by modifying its pitch. This is valid only for a timbre when "Detune" is selected. When this Utility is executed, the selected "Detune" value will be set automatically. (Program P1: 1-2a, 1-2b, Global P5: 5-1b, 5-1c)

- 1 Select "Detune BPM Adjust" to access the dialog box.

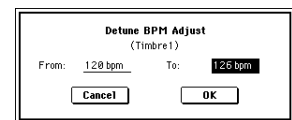

- 2 In "From" specify the original BPM value. In "To" specify the desired BPM value. The appropriate "Detune" value will be calculated automatically from these two values.  
For example if you set "From" to 60 bpm and "To" to 120 bpm, the "Detune" parameter will be set to +1200 (one octave up).
  - 3 To execute the Detune BPM Adjust command, press the **OK** button. To cancel, press the **Cancel** button.
- !** The detune value that is calculated when you execute this command will be added to "Detune" +0000. You must set the "From" BPM value when "Detune" is +0000. For example if you execute "From" 60 bpm "To" 120 bpm, and then execute "From" 120 bpm "To" 60 bpm, will not return to the original result. (Rather, this will set Detune= -1200, which is one octave down.)

## 2-4: Other

Here you can make various other settings for each timbre.

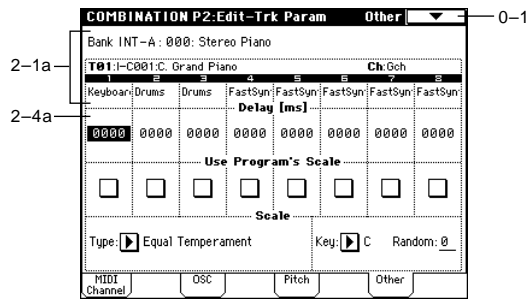

### 2-4a: Delay, Use Program's Scale, Scale

**Delay [ms] (Delay Time)** [0000...5000, KeyOff]

For each timbre, this specifies a delay time from note-on until the sound begins.

**KeyOff:** The note will begin sounding at note-off. In this case, the sound will not die away if the sustain level of the program's amp EG is other than 0. This setting is used when creating harpsichord sounds. Normally you will set this to 0.

**Use Program's Scale** [Off, On]

Each timbre can use the scale that is specified by *Scale* (Program P1: 1-1c).

**On (checked):** The scale specified by the program will be used.

**Off (unchecked):** The scale specified by *Scale* will be used.

**Scale:**

Specifies the scale that the combination will use.

**Type (Combi's Scale)** [Equal Temperament...User Octave Scale15]

Select the type of scale (see "Type" Program P1: 1-1c).

**Key** [C...B]

Selects the tonic key of the selected scale (see "Key" Program P1: 1-1c).

**Random** [0...7]

As this **value is increased**, an increasingly random deviation will be added to the pitch at each note-on (see "Random" Program P1: 1-1c)

## Combination P3: Edit-MIDI Filter

These settings allow you to apply filters to the MIDI data that will be transmitted and received by each timbre 1-8. For example even if two timbres are being played by the same MIDI channel, you can make settings so that the damper pedal will apply to one but not the other.

**On (checked):** Transmission and reception of MIDI data is enabled. When "Status" (0-1c, 2-1b) is INT, operation of the built-in controllers or incoming MIDI data will apply the effect of the checked item to the program of the corresponding timbre. (The effect dynamic modulation function is not affected by this setting.)

When "Status" is EXT or EX2, operation of the built-in controllers will transmit MIDI data on that timbre's MIDI channel. MIDI transmission and reception settings for the entire TRITON STUDIO are made in "MIDI Filter" (Global P1: 1-1b).

The Edit-MIDI Filter-3 and -4 pages contain MIDI filters for assignable controllers (whose function can be set by the user), and if these are assigned to MIDI control changes, the filter settings will affect those control changes.

In this case, if the assignable controllers have been set to control changes that are also found in the Edit-MIDI Filter-1 or -2 pages, the settings in the MIDI 1 and MIDI 2 pages will take priority. Also, if the same control change is assigned to two or more controllers in the Edit-MIDI Filter-3 and -4 pages, checking any one of them will enable that control change.

**Off (unchecked):** Transmission and reception of MIDI data is disabled.

### 3-1: MIDI 1 (MIDI Filter -1)

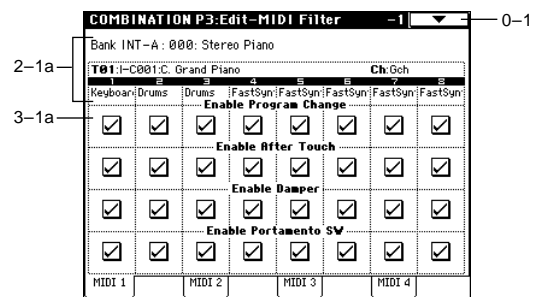

#### 3-1a: Enable Program Change, Enable After Touch, Enable Damper, Enable Portamento SW

**Enable Program Change** [Off, On]

Specifies whether or not MIDI program change messages will be transmitted and received.

**Enable After Touch** [Off, On]

Specifies whether or not MIDI after touch messages will be transmitted and received.

**Enable Damper** [Off, On]

Specifies whether or not MIDI control change CC#64 hold (damper pedal) messages will be transmitted and received.

**Enable Portamento SW** [Off, On]

Specifies whether or not MIDI control change CC#65 portamento on/off messages will be transmitted and received.

### 3-2: MIDI 2 (MIDI Filter -2)

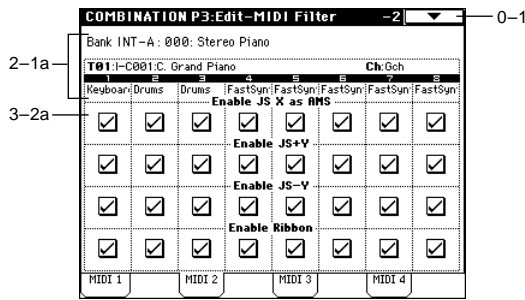

#### 3-2a: Enable JS X as AMS, Enable JS+Y, Enable JS-Y, Enable Ribbon

##### Enable JS X as AMS [Off, On]

Specifies whether or not MIDI pitch bend messages (the X axis of the TRITON STUDIO's joystick) will be received to control the AMS ("Alternate Modulation Source (AMS)" p.241) effect assigned to JS X. (This is not a filter for MIDI pitch bend message reception.)

##### Enable JS+Y [Off, On]

Specifies whether or not MIDI control change CC#1 (the +Y axis of the TRITON STUDIO's joystick, or specified as the "B" assignment of a realtime control knob) will be transmitted or received.

##### Enable JS-Y [Off, On]

Specifies whether or not MIDI control change CC#2 (the -Y axis of the TRITON STUDIO's joystick, or specified as the "B" assignment of a realtime control knob) will be transmitted or received.

##### Enable Ribbon [Off, On]

Specifies whether or not MIDI control change CC#16 (the TRITON STUDIO's ribbon controller, or specified as the "B" assignment of a realtime control knob) will be transmitted or received.

### 3-3: MIDI 3 (MIDI Filter -3)

Specifies whether or not the effects of A and B modes for the REALTIME CONTROL knobs [1], [2], [3] and [4] will be transmitted and received. In A-mode, the MIDI control message for each knob is fixed. In B-mode, the message for each knob can be assigned in Controller page.

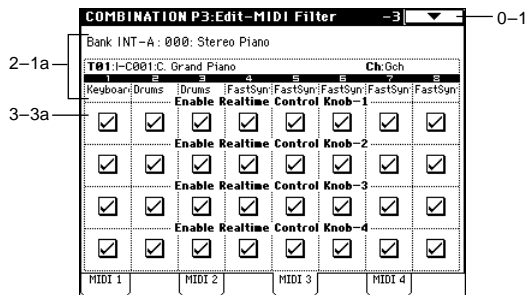

### 3-3a: Enable Realtime Control Knob -1...4

##### Enable Realtime Control Knob -1 [Off, On]

Specifies whether or not the A-mode MIDI control message CC#74 (the TRITON STUDIO's low pass filter cutoff frequency) and the B-mode MIDI control message assigned to knob [1] will be transmitted and received.

##### Enable Realtime Control Knob -2 [Off, On]

Specifies whether or not the A-mode MIDI control message CC#71 (the TRITON STUDIO's low pass filter resonance or high pass filter cutoff frequency) and the B-mode MIDI control message assigned to knob [2] will be transmitted and received.

##### Enable Realtime Control Knob -3 [Off, On]

Specifies whether or not the A-mode MIDI control message CC#79 (the TRITON STUDIO's filter EG intensity) and the B-mode MIDI control message assigned to knob [3] will be transmitted and received.

##### Enable Realtime Control Knob -4 [Off, On]

Specifies whether or not the A-mode MIDI control message CC#72 (the EG release time for the TRITON STUDIO's filter and amplifier) and the B-mode MIDI control message assigned to knob [4] will be transmitted and received.

### 3-4: MIDI 4 (MIDI Filter -4)

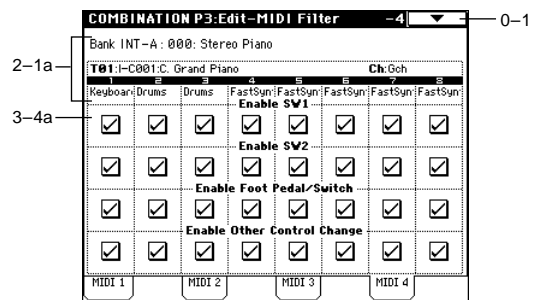

#### 3-4a: Enable SW1, Enable SW2, Enable Other Control Change

##### Enable SW1, Enable SW2 [Off, On]

Specifies whether or not the effect of the [SW1] and [SW2] keys will be transmitted and received. The function of these keys is specified in the P4: Edit-Zone/ Ctrl. Controller page. This filter setting is valid for settings of SW1 Mod.: CC#80, SW2 Mod.: CC#81, or Porta.SW: CC#65.

##### Enable Foot Pedal/Switch [Off, On]

Specifies whether or not the effect of the ASSIGNABLE PEDAL/SWITCH will be transmitted and received. The function is assigned in Global P2: Controller page. This filter setting is valid when a MIDI control change is assigned.

##### Enable Other Control Change [Off, On]

Specifies whether or not MIDI control messages not covered in the preceding items MIDI Filter 1-4 will be transmitted and received.

## Combination P4: Edit-Zone/Ctrl

### 4-1: Key Z (Key Zone)

These settings specify the keyboard range in which each timbre will sound.

The top/bottom key parameters specify the range of notes in which **timbres 1-8** will sound, and the top/bottom slope parameters specify the range over which the original volume will be reached.

By setting timbres of different sounds in ranges that do not overlap, you can play different sounds in different ranges of the keyboard (**Key Split**).

By setting the ranges to overlap, you can play two or more sounds with a single note (**Layer**).

If you set the slopes (the grayed portion) to overlap, the sounds will overlap, and the proportion of the overlap will change according to the keyboard location (**Positional Cross-fade**).

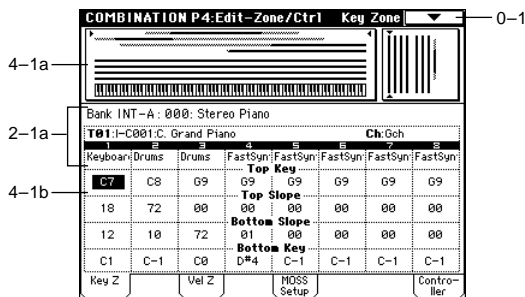

#### 4-1a: Zone Map

This area indicates the note and velocity ranges in which each timbre will sound.

The LCD screen will display a line to indicate the range of notes and velocities that will sound, and will show the slope portion in gray.

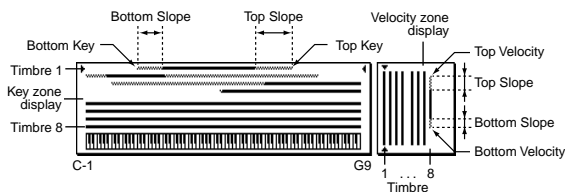

#### 4-1b: Top Key, Top Slope, Bottom Slope, Bottom Key

##### Top Key [C-1...G9]

Specifies the top key (upper limit) of the notes that will sound each timbre 1-8.

##### Top Slope [00...72]

Specifies the range of keys (12 is one octave) over which the volume will be reached starting from the top key.

**0:** The volume will be at the original level from the top key.  
**12:** The volume will increase gradually as you play downward, and will reach the original volume one octave below the top key.

**60:** The volume will increase gradually as you play downward, and will reach the original volume five octaves below the top key.

##### Bottom Slope [00...72]

Specifies the range of keys (12 is one octave) over which the volume will be reached starting from the bottom key.

**0:** The volume will be at the original level from the bottom key.

**12:** The volume will increase gradually as you play upward, and will reach the original volume one octave above the bottom key.

**60:** The volume will increase gradually as you play upward, and will reach the original volume five octaves above the bottom key.

##### Bottom Key [C-1...G9]

Specifies the bottom key (lower limit) of the notes that will sound each timbre 1-8.

How volume will change according to keyboard location

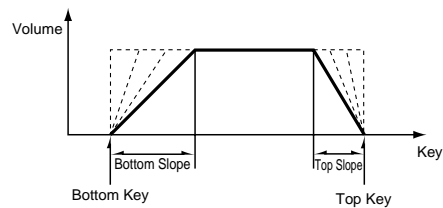

**note** "Top Key" and "Bottom Key" settings can also be input by holding down the [ENTER] key and playing a note on the keyboard.

**!** It is not possible to set the bottom key above the top key of the same timbre. Nor is it possible for the top and bottom slopes to overlap.

### 4-2: Vel Z (Vel Zone)

Sets the Top/Bottom Velocity parameters to specify the range of velocities that will sound for each timbre 1-8, and set the Top/Bottom Slope parameters to specify the range over which the volume will change.

By setting two or more timbres to velocity zones that do not overlap, you can use variations in playing dynamics to play different sounds (**Velocity Switch**).

If you set two or more timbres to velocity zones that overlap, the sounds will be heard together (**Layer**).

If the slope ranges (gray line) overlap, different sounds will be sounded together, and your playing dynamics will determine the proportion of each sound (**Velocity Cross-fade**).

**!** It is not possible to set the bottom velocity greater than the top velocity for the same timbre. Nor can the top slope and the bottom slope overlap.

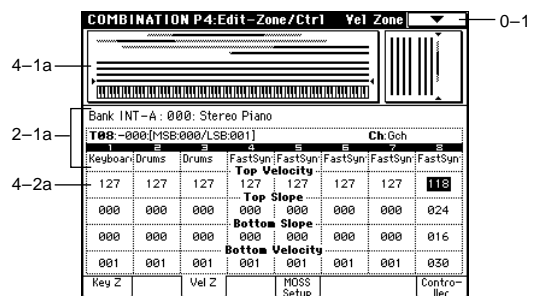

#### 4-2a: Top Velocity, Top Slope, Bottom Slope, Bottom Velocity

##### Top Velocity [1...127]

Specifies the maximum velocity value that will sound each timbre 1-8.

##### Top Slope [0...120]

Specifies the number of velocity steps over which the original volume will be reached, starting from the Top Velocity.

- 0:** The volume will be at the original value from the top velocity.
- 120:** The volume will decrease as the velocity approaches the top velocity.

##### Bottom Slope [0...120]

Specifies the number of velocity steps over which the original volume will be reached, starting from the Bottom Velocity.

- 0:** The volume will be at the original value from the bottom velocity.
- 120:** The volume will decrease as the velocity approaches the bottom velocity.

##### Bottom Velocity [1...127]

Specifies the minimum velocity value that will sound each timbre 1-8.

How volume will change according to keyboard location

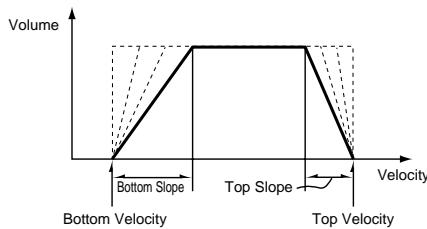

**note** "Top Velocity" and "Bottom Velocity" settings can also be input by holding down the [ENTER] key and playing a note on the keyboard.

#### 4-3: MOSS Setup (MOSS)

This page is displayed when the EXB-MOSS option has been installed. For details refer to the owner's manual included with the EXB-MOSS.

#### 4-4: Controller (Control)

Here you can set the Combination mode functions of the [SW1] key, [SW2] key, and the B-mode functions of REAL-TIME CONTROL knobs [1]-[4].

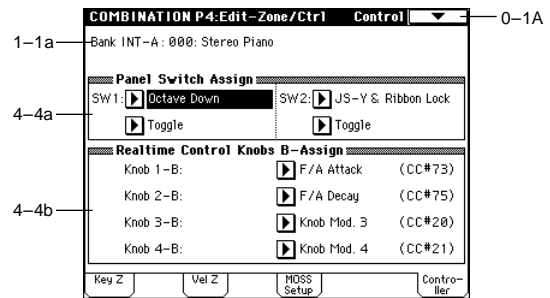

##### 4-4a: Panel Switch Assign

These settings assign the function of the [SW1] and [SW2] keys ("SW1, SW2 Assign List" p.249).

Since the function assignments of the [SW1] and [SW2] keys made for the program assigned to each timbre are not valid inside of a combination, they must be newly set using these parameters.

- SW1 (SW1 Assign) **AMSource** [Off, ..., After Touch Lock]
- SW1 Mode [Toggle, Momentary]
- SW2 (SW2 Assign) **AMSource** [Off, ..., After Touch Lock]
- SW2 Mode [Toggle, Momentary]

Program P1: 1-4a

##### 4-4b: Realtime Control Knobs B-Assign

These settings assign functions (mainly various control changes) to the B-mode of the REALTIME CONTROL knobs [1]-[4] ("Realtime Control Knobs B-Assign List" p.250).

The functions you specify here will be controlled when you operate the REALTIME CONTROL knobs [1]-[4] in B-mode.

Since the REALTIME CONTROL knob [1]-[4] function assignments made for the program assigned to each timbre are not valid inside a combination, they must be newly set using these parameters.

- Knob 1-B **AMSource** [Off, ..., MIDI CC#95]
- Knob 2-B **AMSource** [Off, ..., MIDI CC#95]
- Knob 3-B **AMSource** [Off, ..., MIDI CC#95]
- Knob 4-B **AMSource** [Off, ..., MIDI CC#95]

Program P1: 1-4b

## Combination P7: Edit-Arp.

These parameters specify how the arpeggiator will function within the combination. Two arpeggiators can run simultaneously.

This offers a variety of possibilities, such as applying separate arpeggio patterns to two sounds that have been assigned as a keyboard split, or using velocity to switch between two arpeggio patterns.

### 7-1: Setup

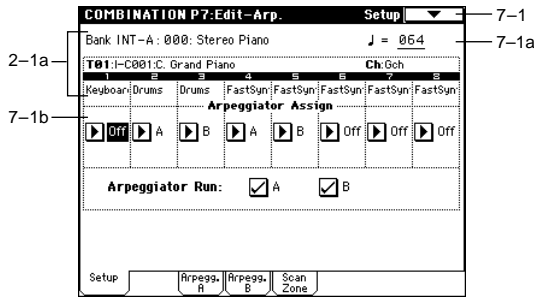

#### 7-1a: ♩ (Tempo) [040...240, EXT]

Specifies the tempo of the arpeggiator. This can also be set by the [TEMPO] knob, or in the P0: Play page. (☞0-1a)

#### 7-1b: Arpeggiator Assign, Arpeggiator Run

##### Arpeggiator Assign [Off, A, B]

Assigns arpeggiator A or B to each timbre 1-8. When the ARPEGGIATOR [ON/OFF] key is on, the arpeggiator specified for each timbre will operate according to "Arpeggiator Run A, B" and these settings.

**Off:** The arpeggiator will not operate.

**A:** Arpeggiator A will operate. Use the settings in the Arpeggiator A page to select the arpeggio pattern and to set parameters.

**B:** Arpeggiator B will operate. Use the settings in the Arpeggiator B page to select the arpeggio pattern and to set parameters.

**MIDI** If the "Status" (0-1c, 2-1b) of the timbre is **INT**, each timbre 1-8 will be sounded by the note data generated by the assigned arpeggiator, regardless of the "MIDI Channel" (2-1b) setting of the timbre. If a timbre is set to **EXT** or **EX2**, MIDI note data will be transmitted on the "MIDI Channel" of that timbre.

In this case, arpeggiator A (or B) will be triggered (operated) by all MIDI channels specified for the "MIDI Channel" parameter of any timbre 1-8 assigned to arpeggiator A or B.

**⚡** If Local Control ("Local Control On," Global P1: 1-1a) is ON, the keyboard will not trigger the arpeggiator. The arpeggiator will be triggered via MIDI IN. Turn Local Control OFF if you have recorded only the trigger notes on an external sequencer, and wish to playback the external sequencer to trigger the TRITON STUDIO's arpeggiator.

If you want the note data generated by the arpeggiator to be recorded on the external sequencer, turn Local Control ON, and turn off the echo back function on your external sequencer.

**MIDI** You can control the arpeggiator from an external sequencer, or use an external sequencer to record arpeggio note data. (☞p.266)

#### Example 1)

Set the "MIDI Channel" (2-1b) of timbres 1 and 2 to **Gch**, and set "Status" (0-1c, 2-1b) to **INT**. Assign arpeggiator A to timbre 1 and arpeggiator B to timbre 2, and check "Arpeggiator Run A, B" (0-3a, 7-1b).

- When the ARPEGGIATOR [ON/OFF] key is off, timbres 1 and 2 will sound simultaneously (layered) when you play the keyboard.
- When the ARPEGGIATOR [ON/OFF] key is turned on, timbre 1 will be played by arpeggiator A, and timbre 2 will be played by arpeggiator B.

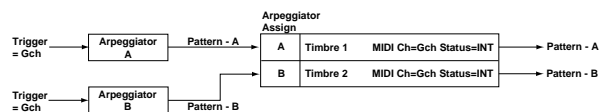

#### Example 2)

The "MIDI Channel" (2-1b) of timbres 1, 2, 3, 4, and 5 are set respectively to **Gch**, **Gch**, **02**, **Gch**, and **03**. Their "Status" (0-1c, 2-1b) is set respectively to **INT**, **Off**, **INT**, **Off**, and **INT**. Assign arpeggiator A to timbres 2 and 3, assign arpeggiator B to timbres 4 and 5, and check "Arpeggiator Run A, B" (0-3a, 7-1b).

- When the ARPEGGIATOR [ON/OFF] key is off, playing the keyboard will sound only timbre 1. (Timbres 2 and 4 are receiving the **Gch**, but they will not sound since their "Status" is **Off**.)
- When you turn on the ARPEGGIATOR [ON/OFF] key, arpeggiator A will operate for timbres 2 and 3, and arpeggiator B will operate independently for timbres 4 and 5. (Arpeggiators A and B are triggered by receiving note data on any MIDI channel of an assigned timbre, but in this example they are being triggered from the **Gch**.)

When you play the keyboard, arpeggiator A will operate for timbres 2 and 3, but only timbre 3 whose "Status" is **INT** will sound. Similarly, arpeggiator B will operate for timbres 4 and 5, but only timbre 5 whose "Status" is **INT** will sound.

In this way, you can make settings so that a timbre does not sound when the arpeggiator is off, but sounds only when the arpeggiator is on.

This type of setting is used in preloaded combinations which sound the drums only when the arpeggiator is on.

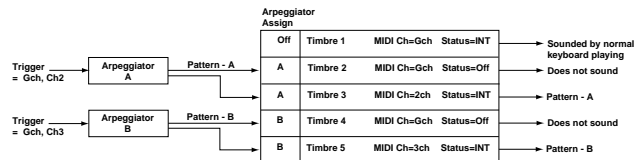

#### Arpeggiator Run A, B

When the ARPEGGIATOR [ON/OFF] key is on, the arpeggiator(s) checked here will run if they are assigned to a timbre by "Arpeggiator Assign" (7-1b). (☞0-3a)

▼ 7-1: Page Menu Command

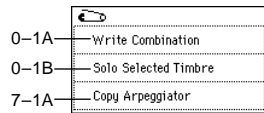

7-1A: Copy Arpeggiator

This command can copy arpeggiator settings from another location to the current Combi.

- ① Select "Copy Arpeggiator" to access the dialog box.



- ② In "From" select the source (mode, bank, number) of the arpeggiator you wish to copy. If you are copying from Combination, Song, or Song Play mode, select either A or B to if you wish to copy settings from only one arpeggiator, or select A&B if you wish to copy the settings of both arpeggiators.
- ③ If you are copying from a Program, or are copying either A or B from Combination, Song, or Song Play mode, select either A or B as the "To" copy destination.
- ④ To execute the Copy Arpeggiator command, press the OK button. To cancel, press the Cancel button.

7-2: Arpegg. A (Arpeggiator A)

7-3: Arpegg. B (Arpeggiator B)

The Arpeggiator A pages allow you to adjust the settings for arpeggiator A. The Arpeggiator B pages allow you to adjust the settings for arpeggiator B.

**note** You can also use the "Copy Arpeggiator" page menu command to copy arpeggiator settings from Program mode or another mode.

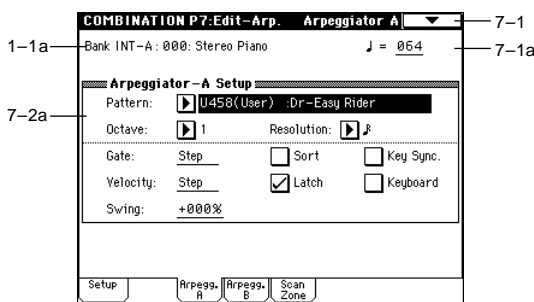

7-2(3)a: Arpeggiator-A(B) Setup

Pattern*	[P00...P04, U000(I-A/B)...U506(User)]
Octave*	[1, 2, 3, 4]
Resolution*	[♪ <sub>3</sub> , ♪, ♪ <sub>3</sub> , ♪, ♪ <sub>3</sub> , ♪]
Gate	[000...100%, Step]
Velocity	[001...127, Key, Step]
Swing	[-100...+100%]
Sort*	[Off, On]
Latch*	[Off, On]

Key Sync\* [Off, On]  
 Keyboard\* [Off, On]

These parameters are the arpeggiator settings for the combination. (≡ "Program P7: Edit-Arpeggiator")

\* These parameters can also be set from "0-3(4): Arpegg. A(B)".

7-4: Scan Zone (Scan Zone A/B)

These settings specify the note and velocity ranges that will operate arpeggiators A and B.

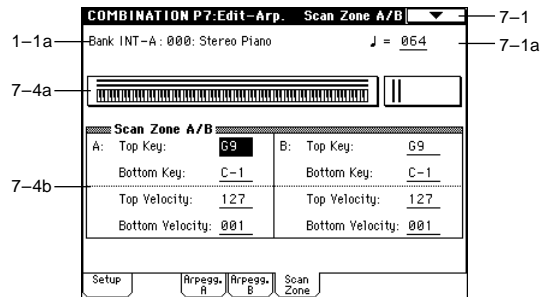

7-4a: Zone Map

This shows the Scan Zone for each arpeggiator, A and B.

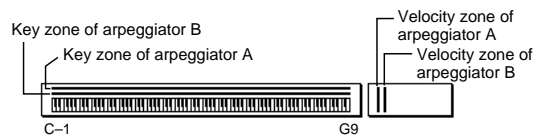

7-4b: Scan Zone A/B

A:

Top Key [C-1...G9]  
 Bottom Key [C-1...G9]

Specifies the range of notes (keys) that will operate arpeggiator A. "Top Key" specifies the upper limit, and "Bottom Key" specifies the lower limit.

Top Velocity [001...127]  
 Bottom Velocity [001...127]

Specifies the range of velocities that will operate arpeggiator A. "Top Velocity" specifies the upper limit, and "Bottom Velocity" specifies the lower limit.

B:

Top Key [C-1...G9]  
 Bottom Key [C-1...G9]

Top Velocity [001...127]  
 Bottom Velocity [001...127]

Specifies the range of notes (keys) and velocities that will operate arpeggiator B (≡ A).

**note** The values of these parameters can also be entered by holding down the [ENTER] key and playing a note on the keyboard.



## Combination P8: Edit-Insert FX

You can also specify the bus routing for the program used by each timbre 1-8.

☞ For details on insertion effects, refer to p.178 “8. Effect Guide.”

### 8-1: Routing

Specifies the bus to which the program oscillator(s) used by each timbre 1-8 will be sent. You can also set the send levels to the master effects from this page.

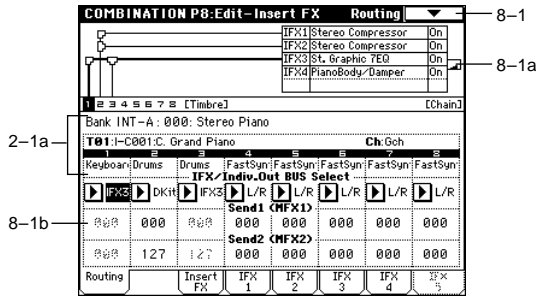

#### 8-1a: Routing Map

This shows the status of the insert effects. For each insert effect, this indicates the routing, the name of the selected effect, the on/off status, and chain status. The effect type, on/off status and chain status can be modified in the Insert FX page (8-2).

#### 8-1b: BUS Select (IFX/Indiv.Out BUS Select), Send1 (MFX1), Send2 (MFX2)

##### BUS Select (IFX/Indiv.Out BUS Select)

[DKit, L/R, IFX1...5, 1...4, 1/2, 3/4, Off]

For each timbre 1-8, these parameters specify the bus to which the program oscillator(s) will be sent. The current settings can also be viewed in the **Routing Map**.

**DKit:** This can be selected only if the program for which settings are being made is a drum program (“**Oscillator Mode Drums**”). With a setting of **DKit**, the “BUS Select” (Global P5: 5-2b) setting made for each key of the drum kit will be used. For example if the “BUS Select” settings of the drum kit have assigned Snare sounds to IFX1 and Kick sounds to IFX2, setting this parameter to **DKit** will send the Snare sounds to IFX1 and Kick sounds to IFX2. If you wish to modify these routings, use the page menu command “Drum Kit IFX Patch” (8-1C).

⚠ If this is set to 1/2 or 3/4, the programs of timbres 1-8 will be sent in stereo from AUDIO OUTPUT (INDIVIDUAL) 1/2 or 3/4. If the pan of the program oscillator is controlled by MIDI control change CC#10 (pan) or AMS, the sound will be output with the pan setting that is in effect at the moment of note-on. Unlike the case when this parameter is set to L/R to output the sound from (MAIN) L/MONO and R, the pan of a sounding note will not change in realtime. If you wish to move the pan of a sounding note in realtime and output it from AUDIO OUTPUT (INDIVIDUAL) 1/2 or 3/4, you must set “BUS Select” to **IFX1** (or **IFX2-IFX5**), select **000: No Effect** for “IFX1” (or

**IFX2-IFX5**) (8-2), and for the sound that has passed through the IFX, set “BUS Select” (8-2) to either 1/2 or 3/4.

Send1 (MFX1) [000...127]  
Send2 (MFX2) [000...127]

For each timbre 1-8, these parameters set the send level to master effects 1 and 2. These settings are valid when “BUS Select” is set to L/R or Off. When **IFX 1, 2, 3, 4** or **5** are selected, the send levels to master effects 1 and 2 are set by the “Send 1” and “Send 2” parameters of the Insert FX page, after the sound has passed through IFX1-5. If “BUS Select” is set to **1, 2, 3, 4, 1/2, or 3/4**, these settings are ignored.

**MIDI** Control change CC#93 can be used to control the Send 1 level, and CC#91 to control the Send 2, and modify their respective settings. These messages will be received on the MIDI channel specified for each timbre in the P2: MIDI channel page.

The actual send levels are determined by multiplying this value with the send level “Send 1” and “Send 2” (Program P8: 8-1d) for each oscillator of the program selected for the timbre.

#### ▼ 8-1: Page Menu Command

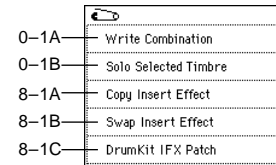

#### 8-1A: Copy Insert Effect

☞ “Program P8: 8-1A: Copy Insert Effect.”

However, the MIDI control channel specified for “Ctrl Ch” of the IFX1-5 pages will not be copied.

#### 8-1B: Swap Insert Effect

☞ “Program P8: 8-1B: Swap Insert Effect.”

However, the MIDI control channel specified for “Ctrl Ch” of the IFX1-5 pages will not be swapped.

#### 8-1C: DrumKit IFX Patch

This command applies a patch to the “BUS Select” settings of each key of the drum kit, allowing you to temporarily change the connections to the insert effects. This command is available only if a drum program has been selected for the timbre and the “BUS Select” (8-1b) parameter is set to **DKit**. Furthermore, this command can be executed only if the “BUS Select” (Global P5: 5-2b) for the individual keys of that drum kit are set to **IFX1-5**.

① Select “**DKit IFX Patch**” to access the dialog box.

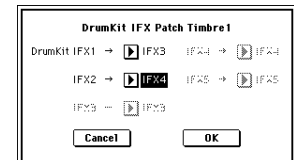

② In the Drum Kit “IFX” popup, select the insert effect to which you want to patch.  
③ To execute the Drum Kit Insert Effect Patch command, press the **OK** button. To cancel, press the **Cancel** button. To restore the condition of the drum kit, execute IFX1→IFX1, IFX2→IFX2, IFX3→IFX3, IFX4→IFX4, and IFX5→IFX5.

## 8-2: Insert FX

Here you can select the type of each insert effect, turn it on/off, and make chain settings etc.

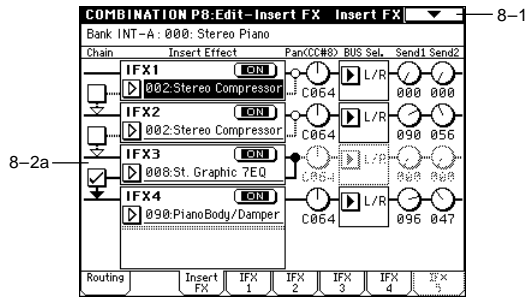

### 8-2a: IFX1, 2, 3, 4, 5

IFX1, 5	[000...089]
IFX2, 3, 4	[000...102]
IFX1, 2, 3, 4, 5 On/Off	[Off, ON]
Chain	[Off, On]
Pan(CC#8) (Post IFX PanCC#8)	[L000...C064...R127]
BUS Sel. (BUS Select)	[L/R, 1, 2, 3, 4, 1/2, 3/4, Off]
Send1	[000...127]
Send2	[000...127]

These parameters are the same as in Program mode. (☞ Program 8-2a)

However, unlike the case in Program mode, the “Ctrl Ch” (8-3a - 7a) MIDI channel is used to control dynamic modulation (Dmod), “Pan (CC#8),” “Send1,” and “Send2” for the insert effects. The control changes used are the same as in Program mode.

## 8-3: IFX 1

## 8-4: IFX 2

## 8-5: IFX 3

## 8-6: IFX 4

## 8-7: IFX 5

These are the parameters for IFX1, 2, 3, 4, and 5 that were selected in the Insert FX page (☞ p.187-).

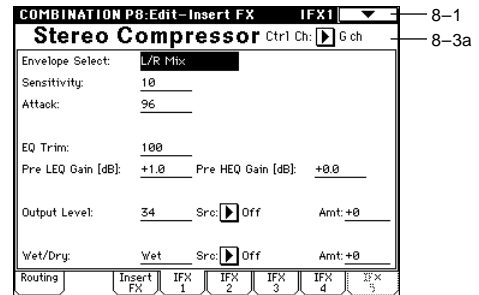

### 8-3(~7)a: Ctrl Ch

Ctrl Ch [Ch01...16, G ch, All Routed]

**MIDI** This parameter specifies the MIDI channel that will be used to control effect dynamic modulation (Dmod), pan following the insert effect (CC#8), Send 1, and Send 2.

The channel number of the timbre routed through this IFX will be followed by a “\*” displayed at the right of **Ch01-16**. If two or timbres with different MIDI channel settings are routed through the same IFX, this parameter specifies which of these channels will be used to control the effect.

**G ch:** The global MIDI channel “MIDI Channel” (Global mode P1: 1-1a) will be used to control the effect. Normally you will set this to **G ch**.

**All Routed:** The channel of any timbre routed through this effect can be used to control the effect. (Channels of each routed timbre will be indicated by “\*”).

**⚠** If the “BUS Select” (8-1b) of a timbre for which a drum program is selected is set to **DKit**, the MIDI channel of that timbre will be valid if any IFX1-5 is set to **All Routed**, regardless of the “BUS Select” (Global P5: 5-2b) settings or the settings of the “DrumKit IFX Patch” page menu command.

## Combination P9: Edit-Master FX

For details on master effects, refer to p.182 "8. Effect Guide."

### 9-1: Master FX

Here you can select the type of each master effect, turn it on/off, and make chain and master EQ settings.

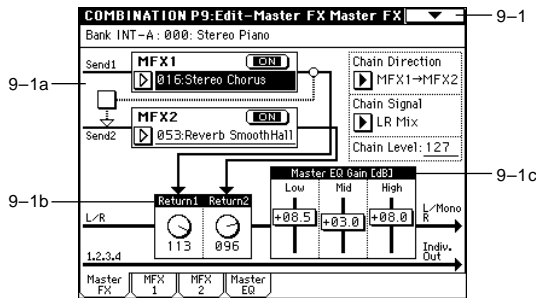

#### 9-1a: MFX1, 2

MFX1, 2	[000...089]
MFX1, 2 On/Off	[Off, ON]
Chain	[Off, On]
Chain Direction	[MFX1→MFX2, MFX2→MFX1]
Chain Signal	[LR Mix, L Only, R Only]
Chain Level	[000...127]

#### 9-1b: Return Level

Return 1, 2	[000...127]
-------------	-------------

#### 9-1c: Master EQ Gain [dB]

Low	[-18.0...+18.0]
Mid	[-18.0...+18.0]
High	[-18.0...+18.0]

These settings are the same as in Program mode (see "Program 9-1: Master FX").

#### ▼ 9-1: Page Menu Command

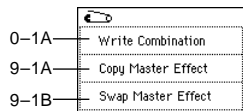

#### 9-1A: Copy Master Effect

"Program P9: 9-1A: Copy Master Effect." However, the MIDI control channel that is specified by "Ctrl Ch" of the MFX 1 and 2 pages will not be copied.

#### 9-1B: Swap Master Effect

"Program P9: 9-1B: Swap Master Effect." However, the MIDI control channel that is specified by "Ctrl Ch" of the MFX 1 and 2 pages will not be swapped.

### 9-2: MFX 1

### 9-3: MFX 2

Here you can set the parameters for the MFX 1 and 2 effects that were selected in the Master FX page (see p.187).

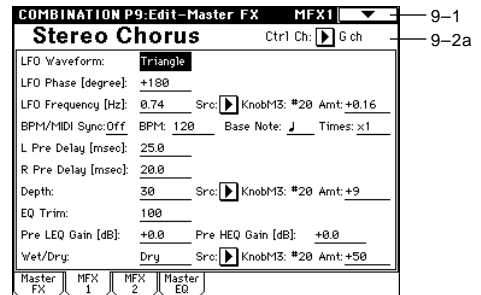

#### 9-2(3)a: Ctrl Ch

Ctrl Ch [Ch01...16, G ch]

**MIDI** This parameter specifies the MIDI channel that will control dynamic modulation (Dmod) for the master effect.

**G ch**: The global MIDI channel "MIDI Channel" (Global P1: 1-1a) will be used for control. Normally you will set this to **G ch**.

### 9-4: Master EQ

The master EQ is a three-band stereo EQ. It is located immediately before the AUDIO OUTPUT (MAIN OUT) L/ MONO and R from the L/R bus, and adjusts the overall tonal character of the sound (see p.239).

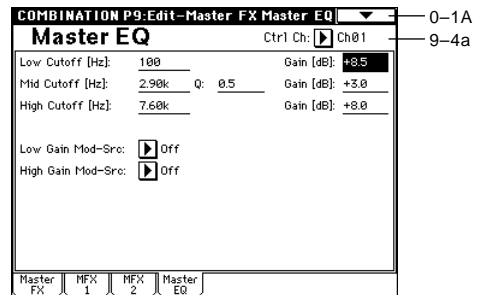

#### 9-4a: Ctrl Ch

Ctrl Ch [Ch01...16, G ch]

**MIDI** This parameter specifies the MIDI channel that will control dynamic modulation (Dmod) for the master EQ.

**G ch**: The global MIDI channel "MIDI Channel" (Global P1: 1-1a) will be used for control. Normally you will set this to **G ch**.

The MEQ High Gain and MEQ Low gain can be controlled by assigning a modulation source to the "Low Gain Mod-Src:" and the "High Gain Mod-Src:" functions on this page.

# 3. Sequencer mode

In Sequencer mode you can use the built-in 16-track sequencer to play, record, and edit songs. You can also arrange multiple songs in the Cue List and play them back in succession.

Here you can also record and edit patterns, copy a created pattern or preset pattern into a song, or use patterns from the RPPR (Realtime Pattern Play Recording) function. Both songs and patterns can be recorded while using the arpeggiator.

Executing the Sampling mode "Time Slice" command (Sampling P2: 2-1B) will divide the sample and will at the same time create song performance data for these divided samples. You can then freely re-create the original rhythm loop in various ways; for example you can change the song tempo in Sequencer mode to play the rhythm loop at a different tempo without changing the pitch, or you can edit the sequence data to change the note numbers or timing.

In addition, while the song plays back, you can play the keyboard or input an external audio source (e.g., vocal or guitar) from AUDIO INPUT etc. and sample it to automatically capture audio data to go with your sequencer song. In other words, you can create audio tracks while running the sequencer, just as if you were using a recorder. (the In-Track Sampling function)

You can also sample performances produced by playing songs, patterns, cue lists, the arpeggiator, or RPPR.

Furthermore, a song you create can be resampled to the internal hard disk, and then, using the included CDRW-1 option etc., written to a CD in Disk mode to produce an audio CD. (BG p.118)

**⚠** These settings and any song data that you have recorded will not be backed up when the power is turned off. Before turning off the power, be sure to save important data on a floppy disk, hard disk, CD-R/RW, external SCSI device, or a data filer. Immediately after the power is turned on, memory will not contain any song data, so in order to playback the sequencer, you will need to load data from the floppy disk etc., or receive a MIDI bulk data dump from an external MIDI sequencer (BG p.144).

## Sequencer P0: Play/Rec

### 0-1: Prog. 1-8 (Program T01-08)

### 0-2: Prog. 9-16 (Program T09-16)

Here you can make basic settings for recording and playing back songs, and can select the program that will be used by each track.



### 0-1a: Location, Meter, Tempo, Tempo Mode, Song Select, Track Select, Reso, RPPR On/Off

#### Location

[001:01.000...999:16.191]

This display shows the current position in the song. From the left, the numbers are the measure, beat, and clock. When you modify these values, the current location will change.

**MIDI** When "MIDI Clock" (Global P1:1-1a) is set to **Internal**, changing the location will cause Song Position Pointer messages to be transmitted. Also if the "MIDI Clock" parameter is set to **External MIDI** or **External mLAN**, and "Receive Ext. Realtime Command" (Global P1: 1-1a) is on, the location will change if a Song Position Pointer message is received from the specified source.

**⚠** The range in which the beat and clock can be modified will depend on the currently specified time signature.

#### Meter

[\*\*/\*\*, 1/4...16/16]

This is the time signature at the current location of the song. The time signature can be changed at each measure.

**\*\*/\*\*:** This will be displayed when you press the SEQUENCER [REC/WRITE] key. Specify this when you wish to use the time signature that is already recorded for that measure, and wish to record without changing the time signature.

**1/4-16/4, 1/8-16/8, 1/16-16/16:** This is the time signature at the current location of the song.

After pressing the SEQUENCER [REC/WRITE] key, specify the time signature here. Then press the SEQUENCER [START/STOP] key to begin recording, and the specified time signature will be recorded on the **Master Track** and on previously-recorded tracks. Be aware that if you press the SEQUENCER [START/STOP] key during the pre-count to stop recording, the time signature will not be recorded. Normally, you will specify the time signature when you record the first track, and select **\*\*/\*\*** when recording subsequent tracks.

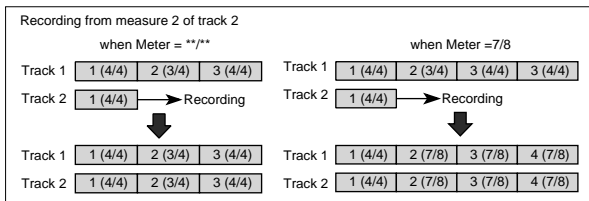

### Changing the time signature in the middle of a song

If you know beforehand the location at which you wish to change time signatures in the middle of a song, use "Insert Measure" (5-1H) to specify and insert the time signature for each measure of the same time signature, and then record your musical data. Alternatively, if you wish to change the time signature in the middle of a song which already contains musical data, use "Track Select" to specify the **Master Track** (or any **Track01-16** which contains data), and use "Event Edit" (5-1B) to modify the time signature of the Bar event.

If the number of beats in a measure increases when you modify the time signature, rests will be inserted in the portion that was added. Conversely if the number of beats decreases, that portion will not be played. However if you return to the original time signature, the data that had been hidden will once again be played. (The data itself will not be erased.)

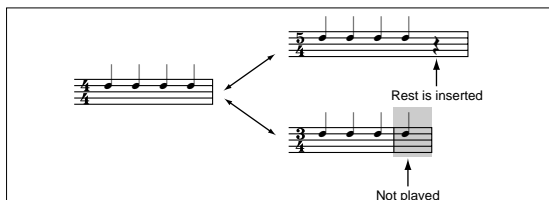

### ♪ (Tempo) [040...240, EXT]

This sets the playback tempo of the song and the tempo of the arpeggiator.

**040...240:** When the "Tempo Mode" is **Manu**, this tempo will be used for recording and playback. When "Tempo Mode" is **REC**, this tempo will be recorded on the master track.

**EXT:** This will appear when "MIDI Clock" (Global P1: 1-1a) is either **External MIDI** or **External mLAN**. The tempo of the internal sequencer will synchronize with the MIDI Clock messages received from an external sequencer etc. When "MIDI Clock" is **Internal**, the above tempo setting (**040...240**) will be used.

**MIDI** If **Tempo** is selected as an alternate modulation source, ♩ = 120 will be the base value.

### Tempo Mode [Auto, Manu, REC]

**Auto:** The tempo will follow the tempo of the **Master Track**. The tempo of the master track can be specified by using "Event Edit" (5-1B) with **Master Track** chosen in "Track Select," or by the **REC** operation described below. When **Auto** is selected, it will not be possible to modify the "♪ (Tempo)" setting while a song is playing or recording (or during standby).

**Manu (Manual):** The "♪ (Tempo)" setting will be used.

**REC:** Tempo changes will be recorded on the **Master Track**. Select this after pressing the SEQUENCER [REC/WRITE] key. When **REC** is selected and you are recording in real-time, modify the "Tempo" value to change the tempo. This cannot be selected when the Preferences page item "Recording Setup" is set to **Loop All Tracks**. Tempo changes can also be created using "Event Edit" (5-1B) or "Create Control Data" (5-1L).

**note** If you wish to record only the tempo changes, set "Recording Setup" (0-8a) to **OverDub**, and the tempo will be recorded on the master track without being affected by the musical data of "Track Select."

### Song Select [000...199]

Select the song that you want to record or play back. Either select the song name from the popup menu, or use numeric keys [0]-[9] to specify the song number and then press the [ENTER] key.

If you want to **create a new song**, choose a number from the popup menu whose song name is blank, or use the numeric keys [0]-[9] to specify the song number and press the [ENTER] key to access the dialog box. Then specify "Set Length" to specify the number of measures in the song, and press the **OK** button.



**note** If you want to change the length of a song after creating it, execute the page menu command "Set Song Length" (5-1Q). When creating a new song, you can specify the length to be somewhat longer than necessary, and after you have finished recording and editing, use "Set Song Length" to specify the correct length.

**MIDI** If "MIDI Clock" (Global P1: 1-1a) is **Internal**, changing the song will cause Song Select and Song Position Pointer messages to be transmitted. If "MIDI Clock" is **External MIDI** or **External mLAN**, Song Select messages can be received from the specified source to change songs.

When the song changes, tracks whose track status ("Status" (2-1a)) is **EXT**, **EX2** or **BTH** will transmit Bank Select, Program Change, Volume, Panpot, Poramento, Send1, 2, Post IFX Pan, and Post IFX send 1, 2 messages on the MIDI channel of the respective track.

### Track Select [Track01...Track16, Master Track]

**Track01-Track16:** Select the track(s) that will record or play song data.

The track names specified in "Track Name" (5-2).

When you perform realtime recording on a single track, the musical data will be recorded on the track you select here.

When you perform realtime recording on two or more tracks simultaneously (≡ "Multi REC" 0-8a), the "PLAY/MUTE/REC" (0-1c) will select the recording track, regardless of the setting you make here.

**Master Track:** Selects the master track when you wish to use the P5: Track Edit page menu commands to edit the tempo track. When using realtime recording or step recording, it is not possible to record the master track alone.

**MIDI** When you play the keyboard of the TRITON STUDIO and operate its controllers, the internal tone generator will sound according to the settings (program, level etc.) of the tracks that are selected here (if "Status" 2-1a/2a is **INT** or **BOTH**), and other tracks whose MIDI channels match will also sound at the same time (if "Status" is **INT** or **BOTH**). Messages will also be transmitted on the MIDI channels of these tracks (whose "Status" is **EXT**, **EX2** or **BOTH**).

**Reso (Realtime Quantize Resolution)** [Hi,  $\frac{1}{3}$  ...  $\frac{1}{4}$ ]

This corrects the timing of data as it is recorded in realtime. (It does not affect previously-recorded data.)

**Hi (High Resolution):** Timing will not be corrected. Data will be recorded at the maximum resolution ( $\frac{1}{192}$ ).

$\frac{1}{3}$  -  $\frac{1}{4}$ : Data will be corrected to the nearest interval of the specified timing as it is recorded. For example if you select  $\frac{1}{3}$ , data will be corrected to the nearest 32nd note triplet interval. If you select  $\frac{1}{4}$ , data will be corrected to the nearest quarter note interval.

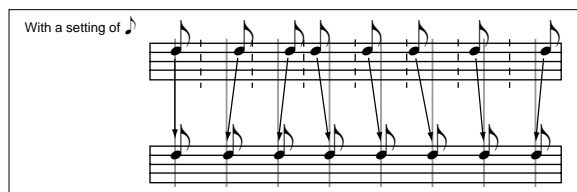

Since all that musical data that is recorded will be corrected to the specified timing resolution, coarse settings of this parameter will cause continuous controllers such as pitch bend to be recorded in "stairstep" fashion.

In such cases, use a setting of **Hi** to record, and then use "Quantize" (5-1N) to correct only the desired type of data (notes etc.). It is best to avoid recording at a stiff resolution to begin with.

**RPPR On/Off** [Off, On]

This turns the RPPR (Realtime Pattern Play/Recording) function on/off. RPPR lets you assign a pattern to each note of the keyboard, so that the pattern will playback (or be recorded) when you press the appropriate key.

**On (checked):** The RPPR function will be on. If a pattern has been assigned to each key in the P6: Pattern/RPPR, RPPR Setup page, pressing that key will perform the assigned pattern (P6-3: RPPR Setup).

**0-1(2)b: Selected Track Information**

Displays information for the track (1-16) that is currently being edited or selected by "Track Select."

**T (Track)** (01...08 (09...16))

Indicates the track number and the program bank/number/name specified for that track.

**Ch** (01...16)

Indicates the MIDI channel number specified for the track.

**RPPR** (NoAssign, C#2...C8)

This shows the key number(s) that will start the RPPR pattern assigned to the track. (If there are numerous keys, not all will be shown. To view all of the assignments, use the P6: Pattern/RPPR, Pattern Edit page.)

**0-1(2)c: Track Number, Category, Bank/Program, PLAY/MUTE/REC, SOLO ON/OFF****Track Number** (1...8 (9...16))

Indicates the track number.

Use the parameters located below "Track Number" to make settings for that track number.

**Category** [00...15]

The program to be used by the track can be selected by category. All programs are classified into one of sixteen categories. You can select the desired category, and then choose programs from that category.

When you press the popup button, the Category/Track Program Select menu will appear. ("Category/Program Select menu"  $\Rightarrow$  Program P0: 0-1a)

**Program Select (Bank/Program)**

[INT-A...INT-F, G, g(1)...g(9), g(d), EXB-A...EXB-G]

Selects the program that will be used by the track. The lower line displays part of the program name.

If "Program Select" is selected, you can use the BANK [INT-A]-[EXB-G] keys and VALUE controller to make the setting. If you press the popup button, the Bank/Track Program Select menu will appear, allowing you to select a program. ("Bank/Program Select menu"  $\Rightarrow$  Program P0: 0-1a)

**note** If you select "Program Select," the BANK key LED will light to indicate the bank of the program selected for the track.

**Bank INT-F** can be selected if the EXB-MOSS option is installed. If this is installed, 128 special EXB-MOSS programs can be used.

The program you select here will be used when the song is played or recorded from the beginning. If the program is changed while recording, the program change will be recorded as musical data, and the program will change during playback. You can also change the program manually during playback. However if musical data (program change data) is already recorded, the program will change at that point.

**MIDI** If the "Status" (2-1a/2a) is either INT or BTH, programs can be selected by receiving MIDI program change messages. Also, when the song is changed or when the song returns to the beginning, tracks whose "Status" is EXT, EX2 or BTH will transmit the bank and program numbers via MIDI. Tracks whose "Status" is EX2 will show Bank as "-" and will transmit the bank number that was selected in the "Bank Select" (2-1a/2a) setting.

**PLAY/MUTE/REC** [PLAY, MUTE, REC]

Here you can mute each track, and select the recording track(s) when performing multi-track recording. During playback, or for single-track recording (normal recording), it is possible only to select **PLAY** or **MUTE** for tracks (playback tracks) other than the recording track. For multi-track recording, tracks can be set to **PLAY**, **MUTE**, or **REC**. The setting will alternate each time you press the **PLAY/MUTE/REC button**.

**PLAY:** The track will play.

**MUTE:** The track will be muted (silent).

**REC:** This will be displayed during single-track recording (normal recording). It cannot be selected.

When you use multi-track recording (the Preferences page "Multi REC" is on), select **REC** for the tracks that you wish to record.

**SOLO ON/OFF** [SOLO ON, SOLO OFF]

This turns the Solo function on/off.

Only the track that is set to **SOLO ON** will sound. Other tracks will be muted.

The setting will alternate on/off each time you press the **SOLO ON/OFF button**.

**MIDI** If tracks whose "Status" (2-1a/2a) is BTH, EXT, or EX2 are muted by Mute or by the Solo function, note on/off messages will not be transmitted on the MIDI channel selected for those tracks.

When the page menu command “Solo Selected Track” (0-1B) is on, its Solo status will be given priority (if ON). When you press “SOLO ON/OFF” or the parameter of another track, only that track will be soloed, and will sound.

## ▼ 0-1: Page Menu Command

0-1A	Memory Status	Load Template Song	0-1G
0-1B	Solo Selected Track	Save Template Song	0-1H
0-1C	Rename Song	FF/REW Speed	0-1I
0-1D	Delete Song	Set Location	0-1J
0-1E	Copy From Song	GM Initialize	0-1K
0-1F	Copy From Combi		

### 0-1A: Memory Status

This displays the remaining amount of sequencer memory.

### 0-1B: Solo Selected Track

The Solo function will alternate on/off each time you select this command.

① Select the page menu command “Solo Selected Track.” When you select this command, a check mark will be added at the left of the “Solo Selected Track” in the menu, and the Solo function will be turned on.

② In a page that displays parameters for each track, select the track that you want to solo (e.g., by using “Program Select” in the P0: Play, Program Select page), and only that track will sound, while the other tracks will be muted. The “Selected Track Information” (0-1b/2b) in each page will indicate [Solo]. This function cannot be selected in pages that do not contain parameters for individual tracks.

If you want to solo another track, select a parameter of that track.

③ To cancel the Solo function, once again choose “Solo Selected Track.”

When this Solo function is on, only the selected track will be soloed and will sound when you press “SOLO ON/OFF” (0-1c/2c) or a parameter of another track – even if two or more “SOLO ON/OFF” buttons are turned on.

**MIDI** If the tracks that have been muted by the Solo function have a “Status” (2-1a) setting of **EXT**, **EX2**, or **BTH**, the MIDI note-on/off messages of that track will not be transmitted.

### 0-1C: Rename Song

Here you can rename the selected song. A name of up to sixteen characters can be input. (BG p.53, 57)

### 0-1D: Delete Song

This command deletes the currently selected song.

① Select “Delete Song” to access the dialog box.

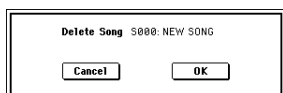

② If you wish to execute the Delete Song command, press the **OK** button. To cancel, press the **Cancel** button. When you execute this command, the musical data, setting data, and patterns etc. of the currently selected song will be erased, and the memory area allocated to that song will be freed.

### 0-1E: Copy From Song

This command copies all of the setting data and musical data from the specified song to the currently selected song.

① Select “Copy From Song” to access the dialog box.



② In “From,” specify the copy source song number.

③ Select the data that you wish to copy.

**All:** will copy all setting data and musical data (track events and patterns, etc.).

**Without Track/Pattern Events:** will copy only the setting data of songs, except for Play Loop and RPPR data.

④ To execute the Copy Song operation, press the **OK** button. To cancel, press the **Cancel** button.

Be aware that if you execute “All,” all setting data and musical data of the currently selected song will be erased and rewritten by the data from the copy source song. If you execute “Without Track/Pattern Events,” song setting data other than Play Loop and RPPR will be rewritten.

### 0-1F: Copy From Combi (Copy from Combination)

This command copies the parameters of the specified combination to the setting data of the currently selected song.

① Select “Copy From Combi” to access the dialog box.

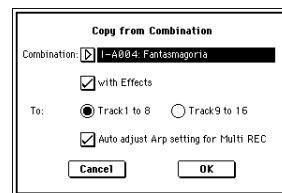

② In “Combination,” select the copy source destination.

③ Use “with Effects” to specify whether effect and EQ settings will also be copied.

If this is **checked**, insert effects, master effects, and master EQ settings will also be copied.

④ Use “To” to select the copy-destination tracks (1-8 or 9-16).

⑤ If you selected **Track 1 to 8** as the “To” setting, you have the option of checking “Auto adjust Arp setting for Multi REC.” As necessary, this function will adjust the MIDI channel etc. of any tracks that need to be changed, and/or add new tracks, in order to ensure that when you perform multi-recording with the arpeggiator on, the same sound will be reproduced during recording as during playback.

**note** This function makes adjustments depending on the ARPEGGIATOR [ON/OFF] state of the combination. When you copy a combination that was written with the arpeggiator turned off, it is assumed that you will leave the arpeggiator off in the song as well. If you want to use the arpeggiator in the song, you should write the combination with the arpeggiator turned on, and then copy it to the song.

If this is **checked**, the MIDI channels etc. of the tracks will be corrected. “Multi REC” (0-8a) and “PLAY/MUTE/REC” (0-1c/2c) will also be set automatically. In addition, “Recording Setup” Over Write (0-8a) will be selected. (Note that the automatically-set “Multi REC” and “PLAY/MUTE/REC” will be reset when you re-select the song.)

**note** For details on the content that will be corrected, refer to “If the recorded performance is not reproduced correctly during playback” (BG p.96). The content described here will be corrected automatically. Depending on the settings of the combination, it may be necessary to make additional changes to the track settings in addition to the settings here.

- ⑥ Press the **OK button** to execute the Copy From Combination command, or press the **Cancel button** to cancel without executing.

When you execute the command, the song setting data of the currently selected song will be erased, and overwritten by the settings of the combination.

### 0–1G: Load Template Song

This command loads a template song as a song. The built-in sequencer contains sixteen different **preset template songs** (P00–15) that contain preset settings for programs and effects appropriate for various musical styles. You are also free to create your own favorite settings for programs, track parameters, and effects, and save them as one of sixteen **user template songs** (U00–15) (“Save as User Template Song” 0–1H).

- ① Select “**Load Template Song**” to access the dialog box.



- ② In “**From,**” specify the template song that you wish to load.
- ③ If you check “**Copy Pattern to Track too?**,” the “Copy Pattern To Track” dialog box will appear automatically after “Load Template Song” has been executed. If you execute **without checking** this, only the template song you specified in step ② will be loaded.
- ④ To load the template song, press the **OK button**. To cancel without loading, press the **Cancel button**. When you execute, song settings other than Play Loop and RPPR will be copied.

If in step ③ you checked “**Copy Pattern to Track too?**” and pressed the **OK button**, the “Copy Pattern To Track” dialog box will appear.

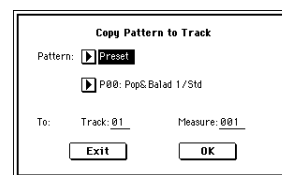

This dialog box is the same as in the page menu command “Copy To Track” (6–1I) (p.78).

- ⑤ In “**Pattern,**” select the pattern that you wish to copy. If you press the SEQUENCER [START/STOP] key, the selected pattern will play. In To “**Track,**” select the copy destination track. In “**Measure,**” specify the beginning measure of the copy destination.

**note** Track 1 of all sixteen preset template songs contains a drum category program. (In preset template songs P02, P04, P08, and P15 drum category programs are specified for multiple tracks.)

The pattern names of the 150 preset patterns indicate the musical genre and part of the optimal drum category program. (table below)

For example in **P00: Pop&Balad 1/Std**, the musical genre is “Pop&Balad 1,” and “Std” is part of the name of the drum category program that is most suitable. By loading the drum track for these preset template songs and the corresponding preset patterns, you can efficiently set up a drum track that is suited to each preset template song.

- ⑥ To execute, press the **OK button**. When you execute, “Measure” will count up automatically. You may then copy patterns as well. To exit the command, press the **Exit button**.

For details on how to copy preset patterns to a song along with the preset template song, refer to BG p.49.

Preset Template Song	Track No.: Name	Program	Corresponding Preset Pattern No.:Name
P00: Pop/Ballade	Track01: Drums	A036:Standard Kit	P00: Pop&Balad 1/Std ... P10: Pop(6/8) 3/Std
P01: Rock/Metal Rock	Track01: Drums	B020:Processed Kit	P11: Rock 1/Process ... P21: Rock11/Process
P02: R & B	Track01: Drums 1(Std 2)	B036:Standard Kit 2	P22: R&B 1/Std2 ... P27: R&B 6/Std2
	Track09: Drums 2(Std)	A036:Standard Kit	P28: R&B 7/Std ... P32: R&B11/Std
P03: Jazz	Track01: Drums	B004:Jazz/Brush Kits	P33: Jazz 1/Jazz ... P39: Jazz 7/Jazz
P04: Latin	Track01: Drums	B004:Jazz/Brush Kits	P40: Latin 1/Jazz ... P42: Latin 3/Jazz
	Track08: Percussion	B116:Percussion Kit	P46: Latin 7/Jazz ... P47: Latin 8/Jazz
P05: Reggae	Track01: Drums	B068:Drum'nBass Kit	P43: Latin 4/Perc ... P45: Latin 6/Perc
P06: Country	Track01: Drums	A036:Standard Kit	P48: Reggae 1/D'n'B ... P53: Reggae 6/D'n'B
P07: Folk	Track01: Drums	A036:Standard Kit	P54: Country 1/Std ... P57: Country 4/Std
P08: European Trad.	Track01: Drums	A036:Standard Kit	P58: Folk 1/Std ... P61: Folk 4/Std
	Track08: Percussion	B116:Percussion Kit	P62: E.Trad 1/Std ... P67: E.Trad(3/4)2/Std
P09: Orchestral	Track01: Percussion	A116:Orchestra&Ethnic	—
P10: Techno/Euro Beat	Track01: Drums	A020:House Kit	P68: Techno 1/House ... P78: Techno11/House
P11: House	Track01: Drums	A020:House Kit	P79: House 1/House ... P92: House14/House
P12: Drum'n'Bass	Track01: Drums	B068:Drum'n'Bass Kit	P93: Drum'nBs 1/D'n'B ... P108: Drum'nBs16/D'n'B
P13: Acid Jazz	Track01: Drums	B036:Standard Kit 2	P109: AcidJazz 1/Std2 ... P120: AcidJazz12/Std2
P14: Hip Hop/Rap	Track01: Drums	A068:HipHop Kit	P121: HipHop 1/HipHop ... P135: HipHop15/HipHop
P15: Big Beats	Track01: Drums 1(Hip/Hop)	A068:HipHop Kit	P136: Bigbeat 1/HipHop ... P143: Bigbeat 8/HipHop
	Track09: Drums 2(Tricky)	A004:!(Tricky) Kit!	P144: Bigbeat 9/Tricky ... P149: Bigbeat14/Tricky



## 0-1H: Save Template Song (Save as User Template Song)

This command saves the program selections, track parameters, and effect settings etc. of the current song as a user template song U00-15. The settings you save here can also be loaded in Song Play mode.

- 1 Select “**Save Template Song**” to access the dialog box.

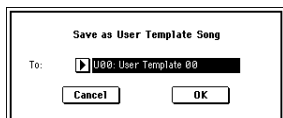

- 2 In “**To**,” specify the user template song (U00-15) in which the data will be saved.
- 3 To save the template song, press the **OK button**. To cancel, press the **Cancel button**.  
Be aware that when you execute this command, all setting data of the save destination User Template Song will be erased and rewritten with the current settings.

## 0-1I: FF/REW Speed

This allows you to set the speed at which fast-forward or rewind will occur when you press the [FF] key or [REW] key.

- 1 Select “**FF/REW Speed**” to access the dialog box.

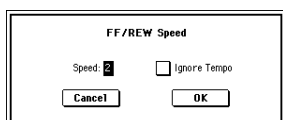

- 2 In “**Speed**,” specify the speed (relative to the playback tempo) at which fast-forward and rewind will occur. This setting is relative to the playback tempo. With a setting of **2**, this will occur at double the playback tempo; with a setting of **3**, triple the tempo; and with a setting of **4**, quadruple the tempo. However in sections where the playback data is dense, the fast-forward or rewind speed may slow down.

- 3 If “**Ignore Tempo**” is **checked**, the playback tempo and note length will be ignored, and fast-forward and rewind will be performed as fast as possible. The speed of fast-forward and rewind will differ between sections where the playback data is dense and sections where it is sparse. If this item is **unchecked**, fast-forward and rewind will be performed at the speed you specify for “**Speed**.”
- 4 To execute the settings, press the **OK button**. To cancel, press the **Cancel button**.

## 0-1J: Set Location (Set Location for Locate Key)

When you press the [LOCATE] key, you will move to the location specified here.

- 1 Select “**Set Location**” to access the dialog box.

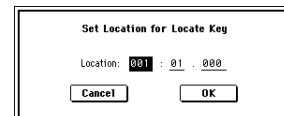

- 2 In “**Location**,” specify the location to which you will move when you press the [LOCATE] key. If you specify **001:01:000**, you will move to the beginning of the song when you press the [LOCATE] key.
- 3 To execute the settings, press the **OK button**. To cancel, press the **Cancel button**.

**note** When this dialog box is not open, you can hold down the [ENTER] key and press the [LOCATE] key to set the current location as the “Set Location” value.

## 0-1K: GM Initialize

This command transmits a GM System On message to the Sequencer mode, resetting all tracks to the GM settings (see table below).

## GM Initialize Parameter

	Parameter	Track1-9, 11-16	Track10	
P0	Bank/Program (Program Select)	G001:Acoustic Piano	g(d)001:STANDARD Kit	
	Pan	C064	C064	
	Volume	100	100	
P1	Status	–	–	The setting remains unchanged
	Use Program's Scale	–	–	The setting remains unchanged
P7	Arpeggiator Assign	–	–	The setting remains unchanged
	Other Arpeggiator parameters	–	–	The setting remains unchanged
P8	IFX/Indiv.Out BUS Select	L/R	DKit	
	Send1(MFX1)	0	0	
	Send2(MFX2)	40	40	
	IFX1-5	–	–	The setting remains unchanged
	Pan(CC#8)	–	–	The setting remains unchanged
	BUS Select	–	–	The setting remains unchanged
	Send1	–	–	The setting remains unchanged
	Send2	–	–	The setting remains unchanged
	Other Insert Effect parameters	–	–	The setting remains unchanged
P9	MFX1	–	–	016: Stereo Chorus
	MFX2	–	–	053: Reverb SmoothHall
	Return1	–	–	127
	Return2	–	–	050
	Other Master Effect and Master EQ parameters	–	–	Default settings

### 0-3: Mixer 1-8 (Mixer T01-08)

### 0-4: Mixer 9-16 (Mixer T09-16)

Here you can set the pan and volume of each track. The pan and volume that you specify here will be used when you playback or record from the beginning of the song. If you change the settings during recording, the changes will be recorded as musical data, and pan and volume will change during playback. You can also change the settings during playback. However when the song reaches a location where pan or volume data was recorded, the settings will change accordingly.

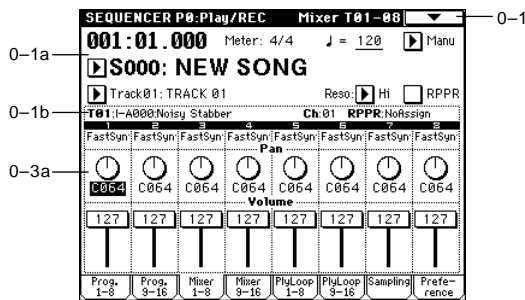

#### 0-3(4)a: Track Number, Program Category, Pan, Volume

**Track Number** (1...8 (9...16))

Indicates the track number. (☞ 0-1c/2c)

#### Program Category

Partially displays the name of the category used by the track.

**Pan** [RND, L001...C064...R127]

Sets the pan of tracks 1-16.

**L001...C064...R127:** A setting of L001 is far left, and R127 is far right. A setting of C064 will reproduce the pan setting of the oscillator in Program mode.

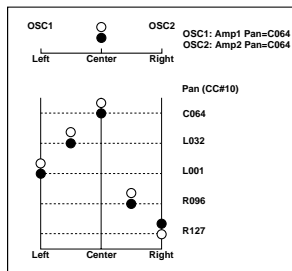
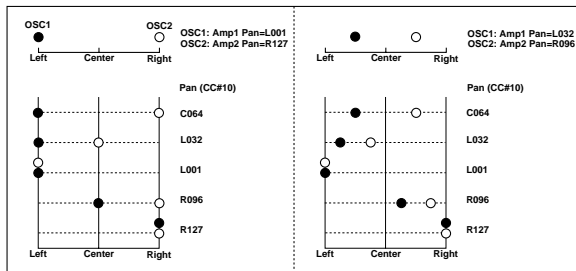

If a mono-type insertion effect is inserted, this setting will be ignored. In this case, the P8: Insert Effect, Insert FX page "Pan (CC#8)" setting will adjust the pan of the sound following the insertion effect. ("3. Mixer" ☞ p.181)

**RND:** The sound will be panned randomly at each note-on.

**[MIDI]** If "Status" (2-1a/2a) is INT or BTH, CC#10 Panpot can be received to control the panning. When receiving CC#10, a value of 0 is far left, 64 is center, and 127 is far right. When you change the song or return to the beginning of the song, tracks whose "Status" is EXT, EX2 or BTH will transmit the pan you specify here as a MIDI message (except for RND).

**Volume** [000...127]

Sets the volume of tracks 1-16.

**[MIDI]** When "Status" (2-1a/2a) is INT or BTH, CC#7 Volume can be received to control the volume. The volume of a track is determined by multiplying the MIDI Volume (CC#7) and Expression (CC#11) values. When you change the song or return to the beginning of the song, tracks whose "Status" is EXT, EX2 or BTH will transmit the volume you specify here as a MIDI Volume message.

### 0-5: PlyLoop 1-8 (PlayLoop T01-08)

### 0-6: PlyLoop 9-16 (PlayLoop T09-16)

When playing or recording a song, you can independently loop the playback of tracks 1-16.



#### 0-5(6)a: Play Loop, Loop Start Measure, Loop End Measure, Play Intro

**Track Play Loop** [Off, On]

Turns looping on/off for each track 1-16.

**On (checked):** That track will loop between "Loop Start Measure" and "Loop End Measure."

**Loop Start Measure** [001...999]

Specifies the first measure of the loop.

**Loop End Measure** [001...999]

Specifies the last measure of the loop.

**Play Intro** [Off, On]

**On (checked):** After the measures before the specified "Loop Start Measure" are played once, the region of "Loop Start Measure" - "Loop End Measure" will be played repeatedly. For example, you can use this on a drum track to make it play a fill-in and then begin looping.

**Off (unchecked):** Playback will begin from the "Loop Start Measure," and will begin looping immediately.

**⚠** This will be valid if "Track Play Loop" is checked and "Loop Start Measure" is set to other than 001.

Example) When "Play Intro" is checked

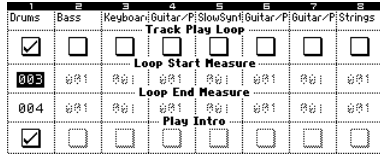

Track 1 will loop as follows.  
M001-M002-M003-M004-M003-M004-M003-M004...

When "Play Intro" is not checked

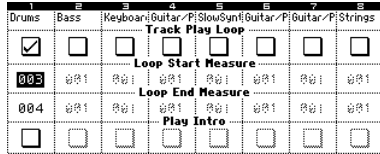

Track 1 will loop as follows.  
M003-M004-M003-M004-M003-M004-M003-M004...

In this way, you can use "Track Play Loop" to make the real-time recording process more efficient (☞BG p.50).

## 0-7: Sampling

Here you can adjust the settings for analog/digital audio signal input (AUDIO INPUT, S/P DIF, EXB-mLAN) and the settings for sampling in Sequencer mode. (☞p.49)  
You can sample either an external audio signal, or a performance played on the TRITON STUDIO.

It is not possible to realtime-record a song or pattern while sampling.

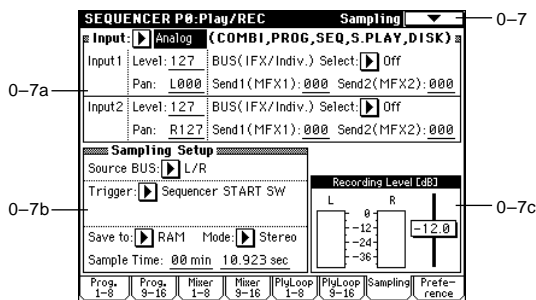

### 0-7a: Input (COMBI, PROG, SEQ, S.PLAY, DISK)

Input [Analog, S/P DIF, mLAN]  
Input1:  
Input2:  
Level [0...127]  
Pan [L000...C064...R127]  
BUS(IFX/Indiv.) Select [L/R, IFX1...5, 1, 2, 3, 4, 1/2, 3/4, Off]  
Send1(MFX1), Send2(MFX2) [000...127]

Here you can specify the analog/digital audio input source, and specify the input level, bus, and the send levels to the master effects.

**note** The various *Input* settings will apply to Combination, Program, Sequencer, Song Play, and Disk modes. (☞Global P0: 0-3a)

### 0-7b: Sampling Setup

Source BUS [L/R, Indiv.1/2]  
Save to [RAM, DISK]  
Mode (Sample Mode) [L-Mono, R-Mono, Stereo]  
Sample Time [min sec]  
Make sampling-related settings for Sequencer mode. (☞Program P0: 0-3)  
Trigger [Sampling START SW, Note On, Threshold, Sequencer START SW]

Specifies the trigger that will initiate sampling.  
Sampling START SW: (☞Program P0: 0-3)

**note** In Sequencer mode, the metronome count will operate according to the *Metronome Setup* (0-8b) setting.

**Note On:** (☞Program P0: 0-3)

**Threshold:** Sampling will begin automatically when the input level exceeds the specified "Level" value. (☞Sampling P0: 0-7b)

**Sequencer START SW:** Press the SAMPLING [REC] key and then the SAMPLING [START/STOP] key to enter sampling-standby mode. Then press the SEQUENCER [START/STOP] key to begin sampling. Use this when you want to resample the song playback.

**note** The various *Sampling Setup* settings apply to the entire Sequencer mode, not to individual songs.

### 0-7c: Recording Level [dB]

ADC OVERLOAD !!  
Recording Level [-inf, -72.0...0.0...+18.0 dB]  
Adjusts the signal level at the final stage of sampling in Sequencer mode. (☞Sampling P0: 0-1d)

This setting defaults to -12 dB when you turn on the power. At a setting of -12 dB, CLIP will not appear even if you play the Song at its maximum level. (☞Program P0: 0-3c "Recording Level")

## 0-7: Page Menu Command

0-1A	Memory Status	Load Template Song	0-1G
0-1B	Solo Selected Track	Save Template Song	0-1H
0-1C	Rename Song	FF/REW Speed	0-1I
0-1D	Delete Song	Set Location	0-1J
0-1E	Copy From Song	Optimize RAM	Program 0-3B
0-1F	Copy From Combi	Select Bank & Smpl No.	0-7A

☞Program P0: 0-3D: Select Directory

### 0-7A: Select Bank & Smpl No.

Here you can specify the RAM bank and sample number into which the sample will be written. You can also specify whether the sample will be automatically converted into a program after sampling. "Select Bank & Smpl No." can be selected if you have chosen RAM for "Save to."

① Choose "Select Bank & Smpl No." to access the dialog box.

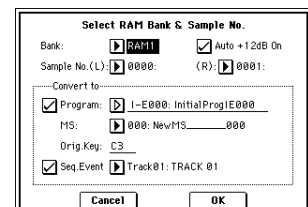

- ② In “**Bank**,” specify the bank of sample memory (RAM) into which sampling will be performed.
- ③ In “**Sample No.**,” choose a sample number where the sampling will be performed. By default, this will be the lowest-numbered of the vacant sample numbers. If you select ---:---No Assign--- or a sample number that already contains data, the sample will automatically be sampled into the lowest-numbered vacant sample number. If you are sampling in stereo, “**Sample No.(L)**” and “**Sample No.(R)**” will be created.
- ④ Set “**Auto +12 dB On.**”  
**On (checked):** “+12 dB” (Sampling P2: 2-1c) will automatically be turned on for samples you record. Samples for which “+12 dB” is on will play back approximately +12 dB louder than if this setting were off.

When you resample a performance in Program, Combination, or Sequencer modes, you should normally set “**Recording Level**” to **about -12.0 (dB)** so that the recording level will be as high as possible without clipping. When you resample, the sound will be recorded at the optimum level for sampled data, but the playback level at playback will not be as loud as it was during the resampling process (if “+12 dB” (Sampling P2: 2-1c) is off). In such cases, you can check the “**Auto +12 dB On**” check box when you resample, so that “+12 dB” (Sampling P2: 2-1c) will automatically be **on**, making the sample play back at the same level as when it was resampled. In these modes, the power-on default settings are “**Recording Level**” at -12.0 (dB) and “**Auto +12 dB On.**” If you resample a performance in the respective mode with these settings, the sample will play back at the same level at which it was resampled.

**note** If you want to monitor your performance in Program, Combination, or Sequencer mode, while sampling only the external audio signal from AUDIO INPUT etc. (with the “**Source BUS**” **Indiv.1/2 setting**: 0-7b), we recommend that you set “**Recording Level**” to **about +0.0 (dB)** and turn off “**Auto +12 dB On**” when you resample.

**note** The “**Auto +12 dB On**” setting is made independently for Program, Combination, Sequencer, and Sampling modes.

- ⑤ “**Convert to**” lets you specify whether the sample will automatically be converted to a program after sampling. You can also specify whether a note event will be created at the time of sampling.  
 If the “**Program**” check box is **checked**, the sample will automatically be converted to a program. (Sampling P0: 0-1a)  
 At the right, use “**Program**” and “**MS**” to specify the program number and multisample number of the program that will be created.  
 “**Orig.Key**” (Sampling P0: 0-1b) specifies the location of the original key. The multisample will be created with an “**Index**” (Sampling P0: 0-1a) having this key as its “**Top Key**” (Sampling P0: 0-1b). “**Orig.Key**” will increment after sampling, so that the next sample will be assigned to the next higher key.  
 If you check the “**Seq.Event**” check box, a note event will automatically be created in the track specified by “**Track**.” Note-on will occur at the location at which sampling began, and note-off will occur at the location at which sampling ended. The note event will be created as in “**Recording Setup**” **Over Dub** mode (i.e., it will be added without erasing existing events). If you are sampling repeatedly without stopping the song playback, the event(s) will be automatically created when you stop song playback. The “**Program Select**” (0-1c/2c) of the

“**Track**” you created will automatically will automatically change to the program you specified in “**Program**.”

**note** “**Seq.Event**” is available only if “**Program**” has been checked.

- ⑥ Press the **OK** button to apply the settings you made, or press the **Cancel** button to discard any settings you made after accessing the dialog box.

## 0-8: Preference

Here you can select the method of realtime recording, and set the metronome.

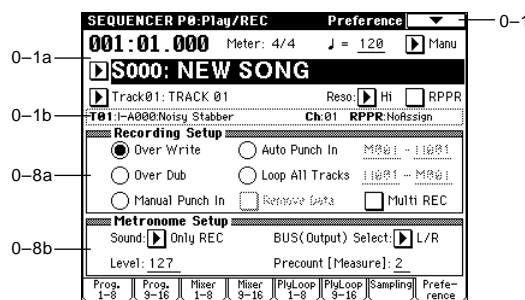

### 0-8a: Recording Setup

#### Recording Mode [Over Write...Loop All Tracks]

Selects the method of realtime recording. Refer to BG p.83 for the realtime recording.

#### Over Write

When recording for the first time, you will normally select this method.

To begin recording, press the SEQUENCER [REC/WRITE] key and then the SEQUENCER [START/STOP] key. To stop recording, press the SEQUENCER [START/STOP] key once again.

Be aware that when this method of recording is used to record on a track that already contains data, any previously existing data will be erased starting from the measure at which you begin recording and from all subsequent measures.

#### Over Dub

Select this method when you wish to add data to a previously-recorded track.

To begin recording, press the SEQUENCER [REC/WRITE] key and then the SEQUENCER [START/STOP] key. To stop recording, press the SEQUENCER [START/STOP] key once again.

The newly recorded data will be added to the previously recorded data already residing in that track.

#### Manual Punch In

Select this method when you wish to use the SEQUENCER [REC/WRITE] key or a foot switch to re-record selected portions of a previously-recorded track.

Press the SEQUENCER [START/STOP] key to playback the song. When you reach the measure at which you wish to begin re-writing the data, press the SEQUENCER [REC/WRITE] key or the foot switch, and recording will begin. When you are finished recording, press the SEQUENCER [REC/WRITE] key or the foot switch once again, and recording will end.

## Auto Punch In

Select this method when you wish to automatically re-record selected portions of a previously-recorded track. If you select **Auto Punch In**, the display will indicate “M\*\*\*-M\*\*\* (Auto Punch In Start Measure–Auto Punch In End Measure)” at the right, allowing you to specify the range of measures that will be rewritten.

Press the SEQUENCER [REC/WRITE] key and then the SEQUENCER [START/STOP] key, and playback will occur until the specified measure is reached. Then, recording will occur only over the specified area (“Start Measure”–“End Measure”), rewriting it with the newly recorded data.

### M–M (Auto Punch In Start Measure – Auto Punch In End Measure) [M001...M999 – M001...M999]

When “Recording Mode” is set to **Auto Punch In**, specify the measures at which recording will start and end.

## Loop All Tracks

Select this method when you wish to repeatedly record a specified area of a track, and continue adding data. This is suitable for creating drum patterns, etc.

If you select **Loop All Tracks**, the display will indicate “M\*\*\*-M\*\*\* (Loop Start Measure–Loop End Measure)” at the right, allowing you to specify the range of measures that will be recorded repeatedly.

Press the SEQUENCER [REC/WRITE] key and then the SEQUENCER [START/STOP] key, and playback will occur until the specified measure is reached. Then, recording will occur repeatedly over the specified area (“Loop Start Measure”–“Loop End Measure”). Previously-recorded data will remain, and the new data will be added. While recording, you can check “Remove Data” to delete unwanted data.

 If “Multi REC” is checked, this parameter will not be available.

### M–M (Loop Start Measure – Loop End Measure) [M001...M999 – M001...M999]

Specifies the range of measures over which recording will repeat when “Recording Mode” is set to **Loop All Tracks**. Specify the range of measures in which recording will be repeated.

### Remove Data [Off, On]

Unwanted playback data can be removed while you record using the **Loop All Tracks** setting. This is available when “Recording Mode” is set to **Loop All Tracks**.

**On (checked):** You can delete unwanted musical data while recording with **Loop All Tracks**. During recording, press the key (note number) that corresponds to the musical data you wish to delete. All occurrences of that note number will be deleted for the interval that you continue holding down the key. Controller data can also be erased in a similar way. For example while you move and hold the joystick in the X (horizontal) direction, bender data will be erased. While you apply pressure to the keyboard, after touch data will be erased.

Also, you can press and hold down the SEQUENCER [REC/WRITE] key to delete all musical data for as long as the key is held.

### Multi REC [Off, On]

**On (checked):** Multi-track recording mode will be selected. Use this mode when you wish to simultaneously record multiple tracks.

Use this when you want to realtime-record a performance played by the arpeggiator on multiple tracks of differing channels.

If this is **checked**, the “PLAY/MUTE/REC” setting (0–1c/2c) (button) of all tracks will be set simultaneously to **REC**. For tracks that you do not want to record, press “PLAY/MUTE/REC” (button) to select either **PLAY** or **MUTE** (the setting will cycle in the order of PLAY→MUTE→REC).

This mode can also be used when you wish to playback a connected multi-track sequencer, and record all of the MIDI data it transmits in one pass into the TRITON STUDIO’s sequencer (see BG p.85).

Multiple channels of MIDI data can be received and simultaneously recorded onto multiple tracks.

In this case, tracks whose “PLAY/MUTE/REC” setting is **REC** will record MIDI data whose channel matches their own MIDI channel setting, regardless of the “Track Select” (0–1a) setting.

In this case you will probably want to set “MIDI Clock” (Global P1: 1–1a) to **External MIDI** or **External mLAN**, to sync up with an external sequencer. However, changes in tempo will not be recorded. (“Recording musical data from an external device” see p.266)

**Off (unchecked):** Single track recording mode will be selected. Recording will occur on the track selected by “Track Select.”

 This cannot be selected if “Recording Mode” is set to **Loop All Tracks**.

---

## 0–8b: Metronome Setup

Here you can make metronome settings.

### Sound [Only REC, REC & Play, Off]

**Only REC:** The metronome will sound only during recording.

**REC & Play:** The metronome will sound during recording and playback.

**Off:** The metronome will not sound. However, the pre-count will sound before recording begins.

This parameter can also be set from “Metronome Sound” (6–1b).

### BUS (Output) Select [L/R, L, R, 1, 2, 3, 4, 1/2, 3/4]

Selects the output destination of the metronome sound.

**L/R, L, R:** Output from OUTPUT (MAIN) L/Mono and/or R.

**1, 2, 3, 4, 1/2, 3/4:** Output from OUTPUT (INDIVIDUAL) 1, 2, 3, 4 respectively.

### Level [000...127]

Sets the volume of the metronome.

### Precount [Measure] [0...2]

Specifies the pre-count that will occur before recording begins.

With a setting of **0**, recording will begin the instant you press the SEQUENCER [START/STOP] key (after first pressing the SEQUENCER [REC/WRITE] key).

# Sequencer P1: Cue List

## 1-1: Cue List

The cue list allows you to playback multiple songs in succession. You can specify a number of repetitions for each song. The TRITON STUDIO allows you to create twenty cue lists. In a single cue list you can freely connect up to 99 songs. Each unit in a cue list is called a “step,” and you can specify a song number and a repeat (number of repetitions) for each step.

For example you could create each part of a song (intro, melody A, melody B, break, solo backing, ending etc.) as an individual song, and use a cue list to play the intro twice, melody A four times, melody B four times, the break twice, melody A four times ... etc. to produce the entire song. In cases when you wish to change the structure of the song, this Cue List function can help you work more efficiently. The page menu command “Convert to Song” (1-1D) lets you convert the songs in a cue list into a single song. For example you can use a cue list to create the backing, convert the cue list to a song, and then add solo phrases on unused tracks.

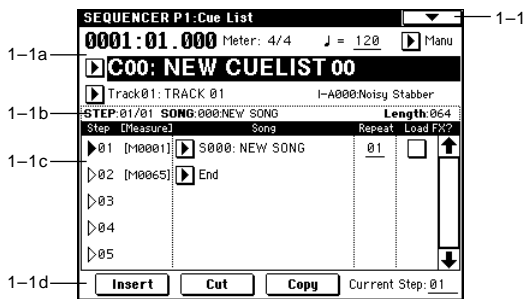

### 1-1a: Location, Meter, ♩, Tempo Mode, Cue List Select, Track Select

**Location** [0001:01.000...9999:16.191]

This displays the current location within the selected cue list.

From the left, the numbers indicate the measure, beat, and clock. Each can be set separately, and this will change the current location within the cue list.

The range of the beat and clock will depend on the time signature of the corresponding song.

**MIDI** When “MIDI Clock” (Global P1: 1-1a) is **Internal**, a Song Position Pointer message will be transmitted each time you change the location within the cue list. If “MIDI Clock” is set to **External MIDI** or **External mLAN**, and “Receive Ext. Realtime Commands” (Global P1: 1-1a) is turned on, receiving a Song Position Pointer message from the specified source will cause the location to change.

If the location exceeds the allowable data range of a Song Position Pointer message, it will not be transmitted.

**Meter (Time Signature)** [1/4...16/16]

This displays the time signature of the currently-playing song.

**♩ (Tempo)** [040...240]

Specifies the tempo at which the song in the cue list will be played (see “0-1a: Tempo”).

**Tempo Mode** [Auto, Manu]

**Auto:** Playback will follow the tempo specified by each song in the cue list. It will not be possible to change the “♩ (Tempo)” setting during playback.

**Manu (Manual):** Tempo specified in the song will be ignored, and playback will use the tempo specified above for “♩ (Tempo).”

**Cue List Select** [C00...C19: name]

Selects the cue list that you wish to play.

When using a cue list to play songs, you must first load the necessary data into internal memory, either from media (floppy disk etc.), or by a MIDI data dump from an external sequencer.

**MIDI** When “MIDI Clock” (Global P1: 1-1a) is **Internal**, selecting a cue list in this page will cause a Song Select message (corresponding to the cue list number) and Song Position Pointer message to be transmitted. When “MIDI Clock” is **External MIDI** or **External mLAN**, a Song Select message from the specified source will switch cue lists.

**Track Select** [Track01...Track16: name]

Selects the track that you wish to play manually from the keyboard along with the playback of the cue list.

While a cue list is playing, you can play along using the track settings and musical data of the song selected by the current “Step” (1-1c).

The track selected here can be specified independently for each song in the cue list.

When you are playing back different songs in succession, and want to play along using the same program on the keyboard, set “Track Select” (0-1a) to the same track and program for each step.

At the right you can view the program bank, program number, and name of the program selected for “Track Select.”

### 1-1b: Selected Step Information

This shows information on the currently selected or playing “Step.”

**STEP** (01...99/01...99)

The selected step number is shown at the left, and the total number of steps (not including the last step) is shown at the right.

**SONG** (000...199)

This shows the number and name of the song for the currently selected step.

**Length** (000...999)

This shows the number of measures in the song for the currently selected step.

### 1-1c: Step, Song, Repeat, Load FX?

**Step [Measure]** [01...100 (M0001...M9999)]

This displays the step number and its starting measure. “Step” indicates each step number. The “Step” indicated by the ► symbol is the currently-selected or currently-playing step. This can be directly selected by “Song” (1-1c) or “Current Step” (1-1d). When stopped, pressing the SEQUENCER [START/STOP] key will cause playback to begin from this step.

“Measure” indicates the starting measure of each step. This cannot be edited.

## Song (Cue Edit - Song)

[S000...S199: name/End, Continue to Step01]

**S000...S199:** Specifies a song for each step. This cannot be edited during playback.

**End and Continue to Step01** can be specified only for the last step of the cue list.

**End:** Playback will stop at the last step of the cue list.

**Continue to Step01:** At the last step of the cue list, playback will return to "Step" 01 and the cue list will continue playing endlessly. To stop, press the SEQUENCER [START/STOP] key.

## Repeat [01...64, FS]

Specifies the number of times that the song of this step will be repeated.

**FS:** A foot switch connected to the rear panel can be used to specify the point at which the song will stop repeating.

When you press the foot switch, that repetition of the song will finish playing, and then playback will continue to the next step. Set "**Foot Switch Assign**" (Global P2: 2-1a) to **Cue Repeat Control**.

## Load FX? (Cue Edit-Load Fx) [Off, On]

Specifies whether the effects specified by the song assigned to each step will be used.

**On (checked):** The effect settings of the song specified for the current step will be used. When playback moves to the next step, the effect settings will also change.

**Off (unchecked):** The effect settings will not change.

⚠ Depending on the effect settings, a certain amount of time may be required to switch effects. In this case, playback will not be smooth from song to song. If you want to transition smoothly from song to song inside of a cue list, check "**FX Load?**" in "**Step**" 01. For the remaining steps, do not check "**FX Load?**" With these settings, the effects will be set before playback begins, so there will be no time lag to interrupt the smooth transition between songs.

Although it is not possible to change the effect types in the middle of a cue list, you can use the dynamic modulation function or MIDI control changes (effect control) to apply reverb more deeply to certain songs, or raise the LFO speed for other songs, etc.

When using a cue list to construct a song, we recommend this method. When you execute the "Convert to Song" (1-1D) page menu command, the effect settings of the "**Step**" 01 song will be specified at the beginning of the song that is created by the conversion.

Even when "**Load FX?**" is not checked, there may be a time lag in the transition from one song to the next, depending on the musical data in the song. There may also be cases in which the musical data at the transition between songs does not play at the correct timing. To fix this, you can edit the musical data of the song, or convert the cue list to a single song. If you use "Convert to Song" (1-1D) to convert the cue list to a song, there will be no time lag at the transition, and the musical data will play at the correct timing.

## 1-1d: Insert, Cut, Copy, Current Step

### Insert

When you press the **Insert button**, the step data that was temporarily saved in the buffer by the **Copy button** or **Cut button** will be inserted at the "Current Step." (If copy or cut has not been executed, default data will be inserted.)

### Cut

When you press the **Cut button**, the "Current Step" will be cut, and its data will be saved temporarily in the buffer. If you **Insert** immediately after you cut, the data will return the state in which it was before you cut.

### Copy

When you press the **Copy button**, the data of the "Current Step" will be saved temporarily in the buffer.

Press the **Insert button** to insert the copied step into the "Current Step."

## Current Step [01...100]

Selects the step that will be inserted, cut or copied.

If you wish to playback from a step in the middle of the cue list, select the desired step here, and press the SEQUENCER [START/STOP] key.

**For details on creating and editing a cue list, refer to BG p.90.**

## ▼ 1-1: Page Menu Command

0-1A	Memory Status	Convert to Song	1-1D
1-1A	Rename Cue List	Copy Song	1-1E
1-1B	Delete Cue List	FF/REW Speed	0-1I
1-1C	Copy Cue List	Set Location	0-1J

### 1-1A: Rename Cue List

This command renames the selected cue list. A name of up to sixteen characters can be input. (ⓃBG p.57)

### 1-1B: Delete Cue List

This command deletes the currently selected cue list.

- 1 Select "**Delete Cue List**" to access the dialog box.

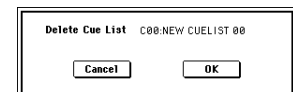

- 2 To execute the Delete Cue List command, press the **OK button**. To cancel, press the **Cancel button**. When you execute this command, the data of the currently selected cue list will be deleted.

### 1-1C: Copy Cue List

This command copies the settings of another cue list to the currently selected cue list.

- 1 Select "**Copy Cue List**" to access the dialog box.

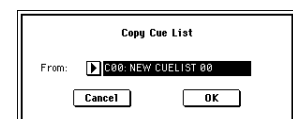

- 2 In "**From**," specify the copy source cue list.
- 3 To execute the Copy Cue List command, press the **OK button**. To cancel, press the **Cancel button**. When you execute, the setting data of the selected cue list will be deleted, and replaced by the copy-source data.

## 1-1D: Convert to Song (Convert Cue List to Song)

This command converts a cue list consisting of multiple songs to a single song. Although it is not possible to record additional tracks into a cue list, you can convert the cue list to a song, and then record solos etc. onto open tracks. Also, it will be necessary to convert a cue list to a song if you wish to write it to a floppy disk as SMF data. During the conversion, the track and effect settings of the song specified for “**Step** 01” will be copied to the beginning of the resulting song, and all track and effect settings of subsequent songs will use the settings of the song for “**Step** 01.”

- ① Select the cue list (C00–19) that you want to convert to a song.
- ② Select “**Convert to Song**” to access the dialog box.

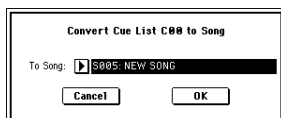

- ③ In “**To Song**,” specify the conversion destination song number.  
If you select a new song, a confirmation dialog box will appear.  
Press the **OK** button to create a new song, into which the cue list will be converted.
- ④ Press the **OK** button to execute the conversion, or press the **Cancel** button to cancel without executing.  
If you selected a song that already contains settings and performance data, executing this command will erase the data of that song and replace it with the data that was converted from the cue list. Use this command with caution.  
After executing this command, you can press the [COMPARE] key to return to the state prior to execution.

The “Convert to Song” command converts a cue list to a song as described below.

- **Song/Track parameter settings for “Step” 01**  
Song/Track parameters will use the settings of the “**Step** 01” song.
- **MIDI Channel**  
The MIDI channel of each track will be according to the settings of the “**Step** 01” song. If “**Step** 02” and following songs have different settings, it may not be possible to convert the playback result of the cue list into a song. As far as possible, try to keep the MIDI channel assignments consistent between songs that you intend to use as part of a play list that will be converted into a song.

The following track parameters will not be reflected in the conversion. As with the MIDI channels, we recommend that you keep these settings consistent between all songs in the cue list.

SOLO ON/OFF, Status, MIDI Channel, Bank Select (When Status = EX2), Force OSC Mode, OSC Select, Delay, Use Programs Scale, MIDI Filter, Key Zone, Velocity Zone

- **Converting Song/Track parameters into track events**  
Second and subsequent repeats of the “**Step** 01” song, and the settings of “**Step** 02” and following songs will all be converted into track events (musical data). The following data will be converted.

Track1–16	Program Select, Pan, Volume, Portamento, Detune, Bend Range
Master Track	Tempo, Meter

If “**Pan**” (0–3a/4a) is **RDN**, it will be converted to **C064**.  
If “**Portamento**” (2–3a/4a) is **PRG**, or if “**Bend Range**”

(2–5a/6a) is **PRG** or a **negative value**, these will not be reflected in the conversion.

- **“Detune”** (2–5a/6a) will be divided into RPN Fine Tuning and Coarse Tuning, and converted into events. For example if the “Detune” setting of +600, Fine Tuning will be 00 and Coarse Tuning will be 6. Fine Tuning will modify the playback pitch (Detune). Coarse Tuning will change the notes that are played back (Transpose). For this reason with some programs such as drum programs, the playback result produced by a cue list may not be reproduced when the cue list is converted into a song.
- **“PLAY/MUTE”**  
(PO: Program T01–08, 09–16 “PLAY/MUTE/REC”)  
The “PLAY/MUTE” track parameters will be reflected in the song. “SOLO ON/OFF” will not be reflected.
- **“Track Play Loop”** (PO: PlyLoop 1–8, 9–16 page)  
If “Track Play Loop” is on, the area from “Loop Start” to “Loop End” will be expanded as far as the last measure in the master track.  
Example)  
If “Track Play Loop” is **M005–M008**, and the master track contains 10 measures, the data will be expanded from the beginning of the track as **M005, 6, 7, 8, M005, 6, 7, 8, M005, 6**.
- **“Play Intro”** (PO: PlyLoop 1–8, 9–16 page)  
If “Track Play Loop” is on, the data will be developed according to the Play Loop setting until the last measure of the master track.  
If “Play Intro” is checked, the data from the beginning of the track until “Loop End” will be developed, and then the data from “Loop Start” until “Loop End” will be developed until the last measure of the master track.  
For example if “Track Play Loop” is **M005–M008** and the master track ends at measure 10, **checking “Play Intro”** will cause the data to be developed from the beginning of the track as **M001, 2, 3, 4, 5, 6, 7, 8, M005, 6, 7, 8, M005, 6**. If “Play Intro” is not checked, refer to the example in “Track Play Loop.”
- **Patterns**  
Patterns in the “**Step** 01” song will be copied as patterns of the converted song.  
If there is a second or subsequent repeat for “**Step** 01,” or if the tracks of “**Step** 02” and subsequent songs contain patterns, they will be expanded into track events (musical data).
- **“Transpose”**  
If the “Transpose” (2–5a/6a) of the tracks in “**Step** 02” and subsequent songs differ from the settings of the “**Step** 01” song, the note numbers of the note data will be shifted.  
Example)  
If “**Step** 01” “Transpose” = +1 and “**Step** 02” “Transpose” –1, the actual note numbers of the “**Step** 02” track note data will be shifted downward by 2.
- **“Repeat” FS (Foot Switch) → “Repeat” 1**  
If “Repeat” is set to **FS (Foot Switch)**, it will be converted as “**Repeat** 1.”

- **When you execute “Convert to Song”** to convert a cue list to a song, the repeat settings within the cue list and the pattern and track play loop settings of the songs used by the cue list will all be converted into events such as note data. For this reason, the amount of data will increase significantly, and in some cases there may not be enough internal memory to perform the conversion. In particular if the cue list uses long songs, or if



numerous repeats have been specified, or if many patterns are used by the songs, you should try executing the "Convert to Song" command from time to time as you create the cue list, in order to verify the amount of memory that will be required for the conversion.

 A cue list that is longer than 999 measures cannot be converted into a song.

### 1-1E: Copy Song

This command copies a portion (a number of measures) of the song specified by "Step," and makes it into a song. This is convenient when you want to modify the structure or development of the songs in a cue list.

For example if you have an eight-measure song and want to repeat measures 5-8, you can use this command to create a four-measure song out of that portion. Then you can assign the resulting song to a step in a cue list, and repeat it.

- ① In "Current Step," or "Song" select the desired step.
- ② Select "Copy Song" to access the dialog box.



- ③ In "From Measure," specify the first measure in the copy source song. In "To End of Measure," specify the last measure.
- ④ In "To Song," specify the song into which the data will be converted. If you select a new song, a dialog box will ask you for confirmation. Press the **OK** button to create a new song and copy the data to that song. If you select an existing song that already contains settings and/or musical data, executing this command will erase the data of that song and rewrite it with the data from the copy source. Before you execute, be sure that you will not be losing important data.
- ⑤ If you check "Replace to original Song in Cue List" and execute this command, the "Current Step" song will be replaced by the newly created song. If you execute **without checking** this box, the newly created song can be selected later for the desired step of the cue list.
- ⑥ To execute the Copy Song operation, press the **OK** button. To cancel, press the **Cancel** button.

## Sequencer P2: Trk Param

### 2-1: MIDI Ch 1-8 (MIDI Ch T01-08)

### 2-2: MIDI Ch 9-16 (MIDI Ch T09-16)

Here you can make MIDI-related settings for each track.

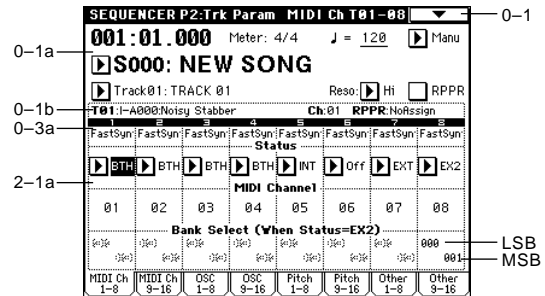

#### 2-1(2)a: Status, MIDI Channel, Bank Select

##### Status

[INT, Off, BTH, EXT, EX2]

This sets the status of MIDI and the internal tone generator for each track.

**INT:** When the musical data recorded in the track is played back, or when you use "Track Select" (0-1a) to select a track that is set to INT and play the keyboard and operate the controllers, the internal tone generator of the TRITON STUDIO will sound, and MIDI data will not be transmitted to an external device.

**Off:** The program will not sound, nor will MIDI data be transmitted.

**BTH:** The operation of both INT and EXT will be performed. When the musical data recorded in the track is played back, or when you select a track that is set to BTH and play the keyboard and operate the controllers, the internal tone generator of the TRITON STUDIO will sound, and at the same time MIDI data will also be transmitted to an external device.

**EXT:** When the musical data recorded in the track is played back, or when you select a track that is set to EXT and play the keyboard and operate the controllers, MIDI data will be transmitted to an external device, but the internal tone generator of the TRITON STUDIO will not sound.

When you select another song or return to the beginning of the song, the program change, volume, panpot, portamento, sends 1 and 2, post IFX pan, and post IFX sends 1 and 2 of each track set to EXT will be transmitted via MIDI.

**EX2:** "Bank Select (When Status=EX2)" will be enabled.

Instead of the INT-A-EXB-G bank numbers that can be selected on the TRITON STUDIO, the bank number you specify here will be transmitted. In other respects this is the same as EXT.

**MIDI** MIDI data is transmitted and received on the MIDI channel that is specified separately for each track by "MIDI Channel."

	Recorded data Keyboard and controller operations		Received data	
	Internal tone generator	MIDI OUT	Internal tone generator	MIDI OUT
INT	●	×	●	—
EXT, EX2	×	●	×	—
BTH	●	●	●	—

## MIDI Channel [01...16]

Specifies the MIDI channel that the track will use to transmit and receive musical data. The MIDI channel you specify here will be the receive channel when “Status” is INT, the transmit channel when it is EXT or EX2, and the receive/transmit channel when it is BTH. Tracks set to INT which have the same MIDI channel will sound and be controlled identically when they receive MIDI data or data from the sequencer tracks.

## Bank Select (When Status=EX2) [000:000...127:127]

When “Status” is set to EX2, this sets the bank number that will be transmitted.

The left value is the MSB, and the right value is the LSB.

When “Status” is other than EX2, this setting has no effect.

## 2-3: OSC 1-8 (OSC T01-08)

## 2-4: OSC 9-16 (OSC T09-16)

These parameters specify how each track will be sounded.



## 2-3(4)a: Force OSC Mode, OSC Select, Portamento

### Force OSC Mode [PRG, Poly, MN, LGT]

Selects the *Voice Assign Mode* (Program P1: 1-1b) of the program selected for each track 1-16 (≡Combination P2: 2-2a).

### OSC Select [BTH, OS1, OS2]

Specifies the “Oscillator Mode” of the program selected for each track 1-16. If the “Oscillator Mode” is **Double**, you can use this setting to make only one or the other oscillator sound (≡Combination P2: 2-2a).

### Portamento [PRG, Off, 001...127]

Specifies the portamento effect for each track 1-16 (≡Combination P2: 2-2a).

**MIDI** The portamento setting you make here will be used when the song is played or recorded from the beginning. If you change the setting while recording, it will be recorded as part of the musical data. (However if you set this to PRG, it will not be recorded.) You can change this setting during playback. However if you come to any Portamento On/Off data or Portamento Time data that was recorded, the settings will change accordingly.

When the track whose “Status” (2-1a/2a) is INT or BTH, MIDI control change CC#5 (Portamento Time) and CC#65 (Portamento Switch) can be received to control this and change the setting. (If the setting is PRG, CC#05 Portamento Time will not be received.)

When you switch songs or return to the beginning of the song, tracks whose “Status” is BTH, EXT, or EX2 will transmit this setting via MIDI. If this is Off, CC#65 with a value of 0 will be transmitted. If this is 001-127, a

CC#65 of 127 and CC#05 of 1-127 will be transmitted. If this is set to PRG, nothing will be transmitted. This data is transmitted and received on the MIDI channel specified for each track by “MIDI Channel” (2-1a/2a).

## 2-5: Pitch 1-8 (Pitch T01-08)

## 2-6: Pitch 9-16 (Pitch T09-16)

Here you can make pitch-related settings for each track.

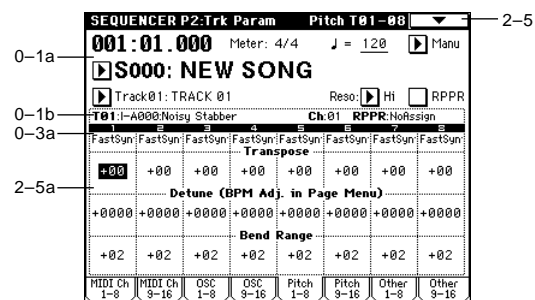

## 2-5(6)a: Transpose, Detune, Bend Range

### Transpose [-24...+24]

Adjusts the pitch of each track in semitone steps. 12 steps are one octave.

### Detune (BPM Adj. in Page Menu) [-1200... +1200]

Adjusts the pitch of each track in one-cent steps from the normal pitch.

0: Normal pitch.

You can use the “Detune BPM Adjust” (2-5A) page menu command to make a calculation in BPM units and set Detune automatically.

**MIDI** “Transpose” and “Detune” settings do not affect the note data that is transmitted via MIDI. “Transpose” and “Detune” are controlled by received MIDI RPN messages. The “Oscillator Mode” (Program P1:1-1a) of the programs selected for tracks 1-16 will be controlled as follows. These messages will be received on the MIDI channel that is specified for each track by “MIDI Channel” (2-1a/2a).

- If “Oscillator Mode” is **Single** or **Double**, MIDI RPN Coarse Tune messages can be received to control and change the “Transpose” setting, and Fine Tune messages to control and change the “Detune” setting.
- If “Oscillator Mode” is **Drums**, MIDI RPN Coarse Tune and Fine Tune messages can be received to control and change the “Detune” setting. The range of control will be ±1 octave when Coarse Tune and Fine Tune are added.

### Bend Range [PRG, -24...+24]

Specifies the range of pitch change in semitone steps that will occur when the pitch bender is operated.

**PRG:** The pitch range specified by the program will be used. -24+24: Regardless of the setting of the program, pitch bending will use the range you specify here.

**MIDI** This setting can be controlled and changed by received MIDI RPN Pitch Bend Range messages. (These messages will not be received if the setting is PRG.)

## ▼ 2-5: Page Menu Command

0-1A	Memory Status	Load Template Song	0-1G
0-1B	Solo Selected Track	Save Template Song	0-1H
0-1C	Rename Song	FF/REW Speed	0-1I
0-1D	Delete Song	Set Location	0-1J
0-1E	Copy From Song	Detune BPM Adjust	2-5A
0-1F	Copy From Combi		

### 2-5A: Detune BPM Adjust

When the program selected for a track uses a phrase, rhythm loop multisample (or sample that was created to match a specific BPM in Sampling mode or loaded from disk in Disk mode) you can use this command to change the BPM of the phrase or rhythm. The BPM can be adjusted by modifying the pitch. This command is available when the "Detune" setting of that track is selected. When you execute this command, the selected "Detune" value will be adjusted. For the procedure, refer to "Detune BPM Adjust" (Combination P2: 2-3A).

## 2-7: Other 1-8 (Other T01-08)

## 2-8: Other 9-16 (Other T09-16)

Here you can make additional settings for each track.

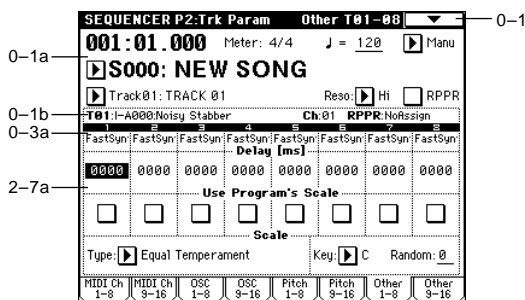

### 2-7(8)a: Delay [ms], Use Program's Scale, Scale

**Delay [ms]** [0000...5000, KeyOff]

Specifies a delay time from when a track receives a note-on until it actually sounds.

**KeyOff:** The sound will begin when note-off occurs. In this case, the sound will continue indefinitely unless the amp EG Sustain Level of the program is other than 0. This setting is useful for simulating harpsichord sounds.

Normally you will leave this at 0.

**Use Program's Scale** [Off, On]

Each track can use the scale that is specified for the program by "Scale."

**On (checked):** The scale that is saved with the program will be used.

**Off (unchecked):** The scale specified here by *Scale* will be used.

**Scale:**

Specifies the scale that will be used for the song.

**Type (Song's Scale)**

[Equal Temperament...User Octave Scale15]

Selects the type of scale (see "Type" Program P1: 1-1c).

**Key**

[C...B]

Selects the tonic key of the selected scale (see "Key" Program P1: 1-1c).

**Random**

[0...7]

As this **value is increased**, an increasingly random deviation will be added to the pitch at each note-on (see "Random" Program P1: 1-1c).

## Sequencer P3: MIDI Filter

Here you can select whether or not to apply filtering to the MIDI data received by tracks 1–16. For example even if two tracks are receiving the same MIDI channels, one can be made to respond to damper pedal activity while the other does not.

**MIDI** These MIDI filter settings have no effect on the MIDI messages that have already been recorded.

**MIDI** These settings affect the MIDI messages that are transmitted when you adjust program, pan, volume, portamento and send 1/2 parameters of a track whose “Status” (2–1a/2a) is set to **BTH**, **EXT**, or **EX2**.

**On (checked):** Reception of MIDI data is enabled. Tracks whose “Status” (2–1a/2a) is **INT** or **BTH** will receive these types of MIDI messages on their respective channels. The type of effects that are checked will be applied to the program of each track when the TRITON STUDIO’s controllers are operated or when MIDI data is received. (The effect dynamic modulation function is not affected by these settings.) Settings that regulate MIDI transmission/reception of the TRITON STUDIO itself are made in *MIDI Filter* (Global P1: 1–1b).

If the user-assignable controllers that can be filtered in the MIDI 3 and MIDI 4 pages are set to MIDI control changes, filtering will be performed for these control changes. In this case, any control change filtering that is being performed in the MIDI 1 and MIDI 2 pages will be given priority. Furthermore, if the same control change is assigned to multiple controllers for which there are filter settings in the MIDI 3 and 4 pages, checking any one of these will enable that control change.

**Off (Unchecked):** Reception of MIDI data is disabled.

### 3–1: MIDI 1 1–8 (MIDI Filter –1 T01–08)

### 3–2: MIDI 1 9–16 (MIDI Filter –1 T09–16)

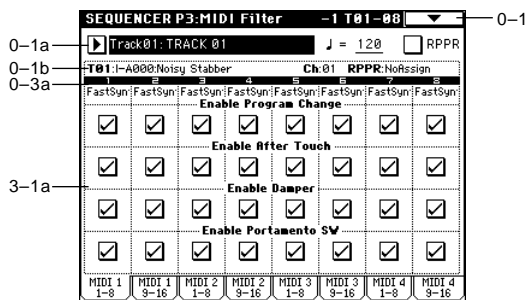

#### 3–1(2)a: Enable Program Change, Enable After Touch, Enable Damper, Enable Portamento SW

**Enable Program Change** [Off, On]  
Specifies whether or not MIDI program change messages will be received.

**Enable After Touch** [Off, On]  
Specifies whether or not MIDI after touch messages will be received.

**Enable Damper** [Off, On]  
Specifies whether or not MIDI control message CC#64 Hold (damper pedal) will be received.

**Enable Portamento SW** [Off, On]

Specifies whether or not MIDI control message CC#65 Portamento On/Off will be received.

### 3–3: MIDI 2 1–8 (MIDI Filter –2 T01–08)

### 3–4: MIDI 2 9–16 (MIDI Filter –2 T09–16)

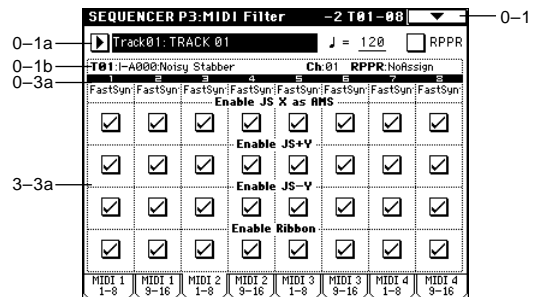

#### 3–3(4)a: Enable JS X as AMS, Enable JS+Y, Enable JS-Y, Enable Ribbon

**Enable JS X as AMS** [Off, On]

Allow incoming MIDI pitch bend messages (the X-axis of the TRITON STUDIO’s joystick) to control the AMS (p.242) that is specified for JS X. (This is not a reception filter for MIDI pitch bend messages.)

**Enable JS+Y** [Off, On]

Specifies whether or not MIDI control message CC#1 (the +Y axis of the TRITON STUDIO’s joystick, or assigned to B-mode of the REALTIME CONTROL knobs [1]–[4]) will be received.

**Enable JS-Y** [Off, On]

Specifies whether or not MIDI control message CC#2 (the –Y axis of the TRITON STUDIO’s joystick, or assigned to B-mode of the REALTIME CONTROL knobs [1]–[4]) will be received.

**Enable Ribbon** [Off, On]

Specifies whether or not MIDI control message CC#16 (the TRITON STUDIO’s ribbon controller, or assigned to B-mode of the REALTIME CONTROL knobs [1]–[4]) will be received.

### 3–5: MIDI 3 1–8 (MIDI Filter –3 T01–08)

### 3–6: MIDI 3 9–16 (MIDI Filter –3 T09–16)

Here you can specify whether the A and B-mode effects of the REALTIME CONTROL knobs [1]–[4] will be transmitted and received. The A-mode MIDI controller messages for each knob are fixed. The B-mode messages can be set in P4: Zone/Ctrl, Controller page.

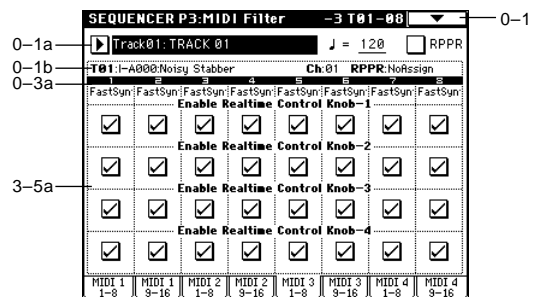

### 3-5(6)a: Enable Realtime Control Knob 1...4

**Enable Realtime Control Knob 1** [Off, On]

Specifies whether or not the A-mode MIDI control message CC#74 (the TRITON STUDIO's low pass filter cutoff frequency) and the B-mode MIDI control message will be received.

**Enable Realtime Control Knob 2** [Off, On]

Specifies whether or not the A-mode MIDI control message CC#71 (the TRITON STUDIO's low pass filter resonance or high pass filter cutoff frequency) and the B-mode MIDI control message will be received.

**Enable Realtime Control Knob 3** [Off, On]

Specifies whether or not the A-mode MIDI control message CC#79 (the TRITON STUDIO's filter EG intensity) and the B-mode MIDI control message will be received.

**Enable Realtime Control Knob 4** [Off, On]

Specifies whether or not the A-mode MIDI control message CC#72 (the release time of the TRITON STUDIO's filter and amplifier EG's) and the B-mode MIDI control message will be received.

### 3-7: MIDI 4 1-8 (MIDI Filter -4 T01-08)

### 3-8: MIDI 4 9-16 (MIDI Filter -4 T09-16)

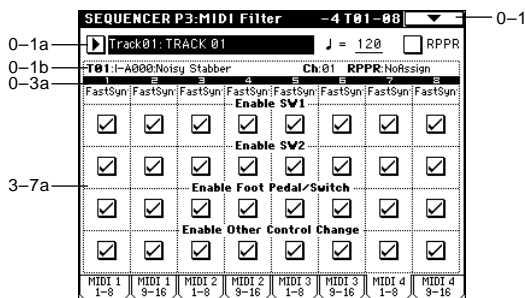

### 3-7(8)a: Enable SW1, Enable SW2, Enable Foot Pedal/Switch, Enable Other Control Change

**Enable SW1, Enable SW2** [Off, On]

Specifies whether or not the effect of the [SW1] and [SW2] keys will be received.

The function of these keys can be set in P4: Zone/Ctrl, Controller page.

This is valid when the switches are set to **SW1 Mod.:CC#80**, **SW2 Mod.:CC#81** or **Porta.SW:CC#65**.

**Enable Foot Pedal/Switch** [Off, On]

Specifies whether or not the effect of the ASSIGNABLE PEDAL/SWITCH will be received. The function of this switch is set in Global P2. This is valid when the switch is set to a MIDI control change.

**Enable Other Control Change** [Off, On]

Specifies whether or not MIDI controller messages other than those included in MIDI Filter 1-4 will be received.

## Sequencer P4: Zone/Ctrl

### 4-1: Key Z 1-8 (Key Zone T01-08)

### 4-2: Key Z 9-16 (Key Zone T09-16)

Here you can specify the range of keys that will be sounded by each track.

Top/Bottom Key settings specify the range of notes that will be sounded by **tracks 1-16**, and Top/Bottom Slope settings specify the range from the top/bottom key until the original volume is reached.

**MIDI** These settings do not affect MIDI transmission/reception. All note data that is received will be recorded into the internal sequencer, and all note data from the internal sequencer or from the keyboard will be transmitted.

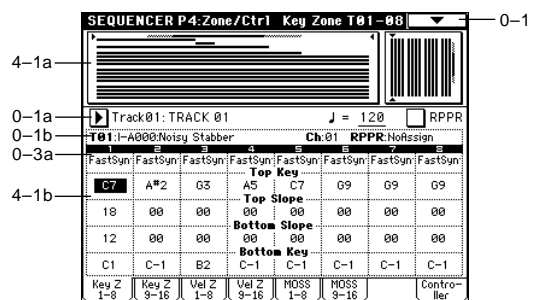

### 4-1a: Zone Map

This shows the range of notes and velocities that will be sounded by each track 1-16.

The note and velocity ranges are shown as lines, and the slope area within the range is shown in gray.

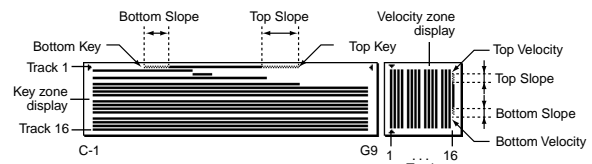

### 4-1(2)b: Top Key, Top Slope, Bottom Slope, Bottom Key

**Top Key** [C-1...G9]

Specifies the top key (upper limit) that will be sounded by each track 1-16.

**Top Slope** [00...72]

Specifies the key range (12 is one octave) from the top key until the original volume is reached.

**Bottom Slope** [00...72]

Specifies the key range (12 is one octave) from the bottom key until the original volume is reached.

**Bottom Key** [C-1...G9]

Specifies the bottom key (lower limit) that will be sounded by each track 1-16.

**note** You can also enter a value for these parameters by playing a note while you hold down the [ENTER] key.

### 4-3: Vel Z 1-8 (Vel Zone T01-08)

### 4-4: Vel Z 9-16 (Vel Zone T09-16)

Here you can set the Top/Bottom Velocity parameters to specify the range of velocities that will be sounded by tracks 1-16, and Top/Bottom Slope specify the range over which the volume will be adjusted.

**MIDI** These settings do not affect MIDI transmission/reception. All note data that is received will be recorded into the internal sequencer, and all note data from the internal sequencer or from the keyboard will be transmitted.

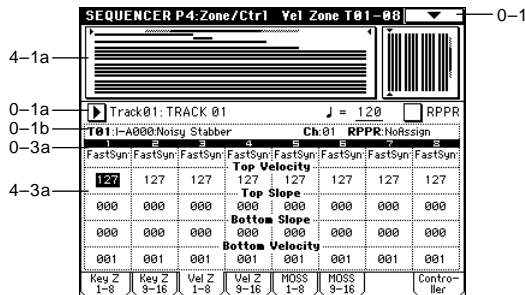

#### 4-3(4)a: Top Velocity, Top Slope, Bottom Slope, Bottom Velocity

##### Top Velocity [1...127]

Specifies the maximum velocity that will be sounded by each track 1-16.

##### Top Slope [0...120]

Specifies the range of values over which the volume will be adjusted from the top velocity until the original volume is reached.

##### Bottom Slope [0...120]

Specifies the range of values over which the volume will be adjusted from the bottom velocity until the original volume is reached.

##### Bottom Velocity [1...127]

Specifies the minimum velocity that will be sounded by each track 1-16.

**note** You can also enter a value for these parameters by playing a note while you hold down the [ENTER] key.

### 4-5: MOSS 1-8 (MOSS T01-08)

### 4-6: MOSS 9-16 (MOSS T09-16)

This page is displayed when the EXB-MOSS option has been installed. For details refer to the owner's manual included with the EXB-MOSS.

### 4-7: Controller (Controller Setup)

Here you can set the functions that the [SW1] key, [SW2] key, and the B-mode functions that the REALTIME CONTROL knobs [1]-[4] will have in Sequencer mode.

**MIDI** When these switches or knobs are operated during recording, the MIDI messages that you assign here will be recorded.

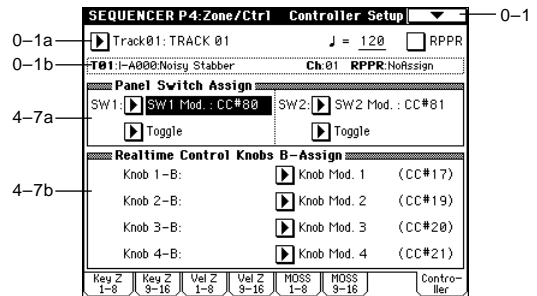

#### 4-7a: Panel Switch Assign

Assigns functions to the [SW1] and [SW2] keys ("SW1, SW2 Assign List" p.249).

Since the functions assigned to these switches by the program assigned to each track will no longer be valid, you can make new assignments here.

SW1 (SW1 Assign) **AMSource** [Off, ..., After Touch Lock]

SW1 Mode [Toggle, Momentary]

SW2 (SW2 Assign) **AMSource** [Off, ..., After Touch Lock]

SW2 Mode [Toggle, Momentary]

Program P1: 1-4a

#### 4-7b: Realtime Control Knobs B-Assign

Here you can set the B-mode functions (mainly various control changes) that the REALTIME CONTROL knobs [1]-[4] will have in Sequencer mode ("Realtime Control Knobs B-Assign List" p.250). The functions you specify here will operate when you rotate the REALTIME CONTROL knobs [1]-[4] in B-mode.

Since the functions assigned to these knobs by the program assigned to each track will no longer be valid, you can make new assignments here.

Knob 1-B **AMSource** [Off, ..., MIDI CC#95]

Knob 2-B **AMSource** [Off, ..., MIDI CC#95]

Knob 3-B **AMSource** [Off, ..., MIDI CC#95]

Knob 4-B **AMSource** [Off, ..., MIDI CC#95]

Program P1: 1-4b

# Sequencer P5: Track Edit

## 5-1: Track Edit

Here you can make settings for the currently selected track, edit previously-recorded performance data, and perform step recording.

When you wish to edit musical data or perform step recording, specify the desired area. Then select the appropriate page menu command.

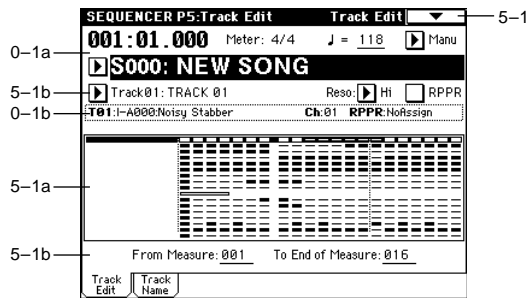

### 5-1a: Track data Map

This area shows the presence or absence of performance data, and indicates the range of editing, etc. (The track selected by "Track Select" will be highlighted.)

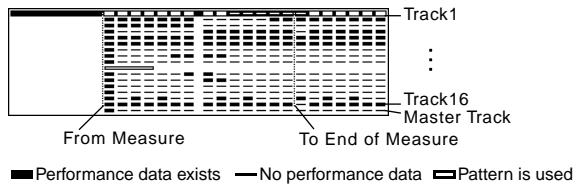

### 5-1b: Track Select, From Measure, To End of Measure

**Track Select** [Track01...Track16, Master Track]

Selects the track that you wish to edit (or copy from) or record.

If you wish to select all tracks, it is not necessary to specify them here. Check the "All Tracks" item within the dialog box of the page menu command.

**Master Track:** Edit the tempo or time signature of the master track.

**From Measure** [001...999]

**To End of Measure** [001...999]

Specifies the range of measures that you wish to edit (or copy from) or step-record.

Use "From Measure" to specify the starting measure, and "To End of Measure" to specify the ending measure.

## 5-1: Page Menu Command

0-1A	Memory Status	Delete Measure	Quantize	5-1G	5-1N
5-1A	Step Recording	Insert Measure	Shift/Erase Note	5-1H	5-1O
5-1B	Event Edit	Repeat Measure	Modify Velocity	5-1I	5-1P
5-1C	Erase Track	Copy Measure	FF/REW Speed	5-1J	0-1I
5-1D	Copy Track	Move Measure	Set Location	5-1K	0-1J
5-1E	Bounce Track	Create Ctrl Data	Set Song Length	5-1L	5-1Q
5-1F	Erase Measure	Erase Ctrl Data		5-1L	5-1M

### 5-1A: Step Recording

Step recording allows you to specify the length and velocity of each note numerically, and to input the pitches from the keyboard. You can use the **Rest button** and **Tie button** to input a rest or tie.

⚠ If you use step recording to input data into a track that already contains sequence data, all data will be erased from the "From Measure" and subsequent measures. If after inputting, you decide to revert to the prior data, use the Compare function.





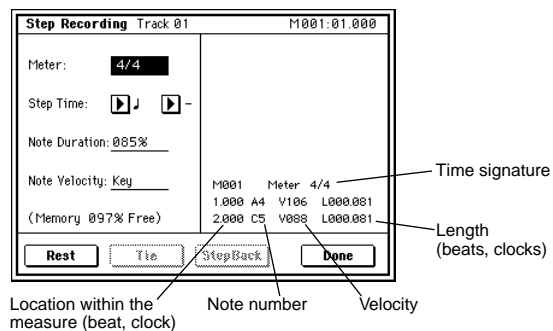













To input data with a continuously-changing value such as pitch bend, it is best to use "Create Ctrl Data" (5-1L). To input individual data events such as program changes, use "Event Edit" (5-1B).

- Use "**Track Select**" to select the track into which you wish to input data, and use "**From Measure**" (5-1b) to specify the measure at which you wish to begin input.
- When you select "**Step Recording**," the following dialog box will appear.



- In "**Meter**," set the time signature. This will show the time signature that has already been set for the measure. If you change the time signature setting, the time signature data of the measures you record will change, and all tracks will change to the time signature you specified.
- In "**Step Time**," specify the length (in terms of a note value) of the basic interval at which you will input data. From the popup menu at the left, select the note length in a range of  $\bullet$  (whole note) through  $\text{32nd}$  note. If you want the selected note value to be a dotted note or a triplet, use the popup menu at the right to select a dot "**(Dot)**" or triplet "**3 (Triplet)**." To use the unmodified value of the selected note, choose "- (Normal)."

The following table shows the number of clocks represented by each "Step Time" selection.

 (0:24)	 (0:48)	 (0:96)	 (1:00)	 (2:00)	 (4:00)
 (0:36)	 (0:72)	 (0:144)	 (1:96)	 (3:00)	 (6:00)
 (0:16)	 (0:32)	 (0:64)	 (0:128)	 (1:64)	 (2:128)

- ⑤ In "Note Duration," specify the length that the note will actually be held, relative to the "Step Time." In general, **100%** will be tenuto, **85%** will be normal, and **50%** will be staccato.
- ⑥ Use "Note Velocity" to specify the velocity value (keyboard playing strength) of the note data. With the [PAUSE] key pressed, you can hold down the [ENTER] key and play a note on the keyboard to specify the velocity value. If you set this to **Key**, the actual velocity at which you played the key will be input.
- ⑦ Input the note events described below by playing notes on the keyboard or by pressing the buttons in the lower part of the dialog box.

#### • Inputting notes

When you press a key on the keyboard, that note number will be input as a note of the length specified in ④.

When you press a chord on the keyboard, those note numbers will be input as chords of the length specified in ④. Since each of the note numbers you press before releasing all of the keys will be input at the same location, the notes will be input as a chord even if they are actually played at different times.

Each time you press and release the keyboard, the location will advance by the length specified in ④.

#### • Inputting rests

Press the **Rest button** to input a rest of the length specified in ④.

#### • Inputting a tie

If you press the **Tie button** without pressing the keyboard, the previously-input note will be tied, and lengthened by the amount specified in ④.

If you press the **Tie button** while holding down a note, the note you are playing will be tied, and lengthened by the amount specified in ④.

You can even input notes as shown in the following diagram.

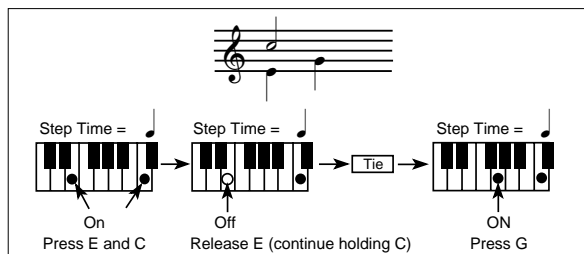

#### • Deleting a note or rest

To delete a note or rest, press the **StepBack button**. The location will move backward by the amount specified in ④, and the data in that interval will be deleted.

#### • Auditioning the next note before input

If you wish to make sure of the next note before you actually input it, press the [PAUSE] key (the LED will light). Now when you press a key, you will hear sound but the note will not be input. Press the [PAUSE] key once again

(the LED will go dark) to cancel the pause mode and resume input.

- ⑧ When you are finished with step recording, press the **Done button**. If you press the [COMPARE] key, you will return to the condition of before you began step recording.

### 5-1B: Event Edit

Here you can edit individual events of music data that were input.

- ① Use "**Track Select**" to select the track that you wish to edit, and use "**From Measure**" (5-1b) field to specify the measure at which you wish to begin editing. If you selected **Track01-16** in "**Track Select**," selecting this command will open the Set Event Filters dialog box. If you selected **Master Track** in "**Track Select**," this dialog box will not appear.

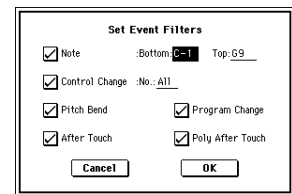

In the **Set Event Filters** dialog box you can select the types of events (musical data) that will appear and can be edited in the event edit window.

For "**Note**" you can set "**Bottom**" and "**Top**" to specify the range of notes available for editing. These settings can also be entered by holding down the [ENTER] key and pressing a key. Normally you will leave these set at **C-1** and **G9**.

"**Control Change**" lets you specify the control change number. Normally you will leave this set at **ALL**. You can also check various other events ("Pitch Bend," "Program Change," "After Touch," and "Poly After Touch").

- ② Press the **OK button** to open the Event Edit dialog box.

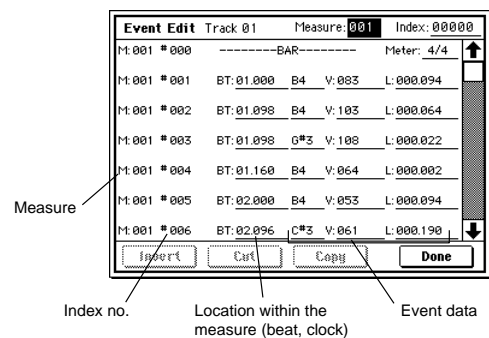

- ③ In the upper part of the dialog box, "**Measure**" and "**Index**" show the measure that you are editing and the events of the index numbers within the measure. You can touch the scroll bar located at the right to move to the event that you wish to edit.
- ④ Select the event that you wish to edit, and use the VALUE controller etc. to modify its value(s).
  - By modifying the value of the "**BT**" (Beat, Tick) location within the measure, you can move the event within the measure.
  - You can edit each event by modifying its data value(s). When you select a note event, it will sound.
- ⑤ You can press the buttons located at the bottom of the dialog box to edit events as follows.
  - **Inserting an event**  
Select the location "**BT**" at which you wish to insert an event, and press the **Insert button** to insert an event.



- **Deleting an event**  
Select the event that you wish to delete, and press the **Cut button** to delete the event.
  - **Moving an event**  
You can use the **Cut button** and **Insert button** to move an event (by “cut and paste”).  
Use the **Cut button** to delete the event that you wish to move, then use the **Insert button** to insert it at the desired location.  
You can also move an event by modifying its “BT” value.
  - **Copying an event**  
Select the event that you wish to copy, and press the **Copy button**. Then select the copy destination and press the **Insert button** to insert the event at that location.
- ⑥ When you are finished event editing, press the **Done button**. If you press the [COMPARE] key you will return the data to the condition in which it was before you began event editing.

The following table shows the types of musical data that can be edited by “Event Edit” and the range of their values.

BAR (displayed only) (Measure line)		Meter: 1/4...16/16 *1 (Time signature)
C-1...G9 *2 (Note data)	V: 1...127 *2 (Velocity)	L: 000.000...15984.000 (Length: beats, clocks)
PAFT (Polyphonic after touch)	C-1...G9 (Note number)	0...127 (Value)
CTRL (Control change)	C: 0...101 (Control change number)	0...127 (Value)
PROG (Program change)	Bank: I-A...I-F, 000...127, G, g(1)...g(9) g(d), - - -, E-A...E-G (Program bank)	P: 0...127, 1...128 (G, g(1)...g(d)) (Program number)
AFTT (After Touch)	0...127 (value)	
BEND (Pitch bend)	-8192...+8191 (value)	

 \*1 Be aware that because the time signature is recorded in the master track, modifying it from any track will affect the same measure of all tracks, causing them all to be played in the modified time signature.

 \*2 Note data and velocity values can also be entered by holding down the [ENTER] key and playing a note on the keyboard.

Pattern numbers will be displayed in locations in which a pattern has been “put” (placed). At the end of the track there will be an indication of **End of Track**.

### 5-1C: Erase Track

This command erases the data from the specified track. However, it is not possible to erase the master track by itself.

- ① In “**Track Select**,” select the track that you wish to erase.
- ② Select “**Erase Track**” to access the dialog box.



If you check “**All Tracks**,” the musical data of all tracks will be erased.

- ③ To execute the Erase Track command, press the **OK button**. To cancel, press the **Cancel button**.

### 5-1D: Copy Track

This command copies musical data from the copy source track to the specified track.

Be aware that when you execute the Copy Track command, any track data that was in the copy destination track will be erased.

- ① Select “**Copy Track**” to access the dialog box.



- ② In “**From**,” select the copy source track. In “**To**,” select the copy destination. (By default, “From” will be the track you selected in “Track Select.”)
- ③ To execute the Copy Track command, press the **OK button**. To cancel, press the **Cancel button**.

### 5-1E: Bounce Track

This command combines the musical data of the bounce source and bounce destination tracks, and places the combined data in the bound destination. All musical data in the bounce source will be erased.

If MIDI control data existed in the bounce source track and bounce destination track, unexpected results may occur during playback after the bounce command is executed. To prevent this from happening, use “Event Edit” (5-1B) or “Erase Control Data” (5-1M) to edit the MIDI control data of the two tracks before you use Bounce Track.

- ① Select “**Bounce Track**” to access the dialog box.

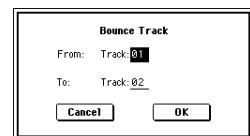

- ② In “**From**,” specify the bounce source track. In “**To**” specify the bounce destination track. (By default, “From” will be the track you selected in “Track Select.”)
- ③ To execute the Bounce Track command, press the **OK button**. To cancel, press the **Cancel button**.

### 5-1F: Erase Measure

This command erases the specified type(s) of musical data from the specified range of measures. The Erase Measure command can also be used to remove only a specific type of data. Unlike the Delete Measure command, executing the Erase Measure command does not cause the subsequent measures of musical data to be moved forward.

- ① Use “**Track Select**” to select a track.
- ② Select “**Erase Measure**” to access the dialog box.

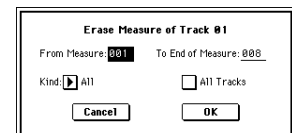

- ③ In “**From Measure**” select the first measure to be erased, and in “**To End of Measure**” select the last measure to be erased. (By default, “From Measure” and “To End of Measure” will be set to the range that you specified in the Track Edit page.)
- ④ In “**Kind**,” specify the type of data that will be erased. **All** will erase all types of data from the track, **Note** will erase note data, **Control Change** will erase control change data, **After Touch** will erase both channel pressure and polyphonic key pressure data, **Pitch Bend** will erase pitch bend data, and **Program Change** will erase program change data.

- ⑤ If you check **“All Tracks,”** the specified type of data will be erased from all tracks.
- ⑥ To execute the Erase Measure command, press the **OK button**. To cancel, press the **Cancel button**.

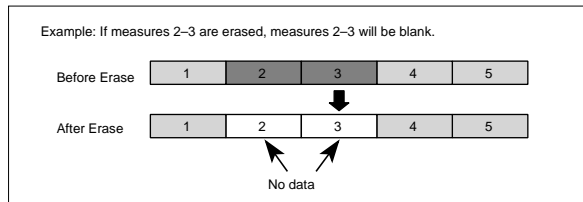

**!** If control data extends across measures that were erased and measures that were not erased, only the data within the range being erased will be erased. However if note data extends across two or more measures, deleting any of the intervening measures will delete that note data from the following measures as well.

**note** Note data can also be erased using **“Shift/Erase Note”** (5-1O). Use this command when you wish to erase a specific range of notes, or to erase notes from a specific **“Beat.Tick.”**

**note** Control Change data can also be erased using **“Erase Control Data”** (5-1M). Use this when you wish to erase a specific type of control change, or to erase control change data from a specific **“Beat.Tick”** range.

### 5-1G: Delete Measure

This command deletes the specified measures. When the Delete Measure command is executed, the musical data following the deleted measures will be moved towards the beginning of the sequence.

- ① Use **“Track Select”** to select the track.
- ② Select **“Delete Measure”** to access the dialog box.

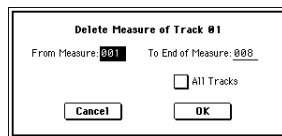

- ③ In **“From Measure”** select the first measure that you wish to delete, and in **“To End of Measure”** select the last measure that you wish to delete. (By default, **“From Measure”** and **“To End of Measure”** will be the range that you specified in the Track Edit page.)
- ④ If you wish to delete musical data from all tracks including the master track, **check “All Tracks.”** If this is **not checked**, data will be deleted only from the track that was selected by **“Track Select.”**
- ⑤ To execute the Delete Measure command, press the **OK button**. To cancel, press the **Cancel button**.

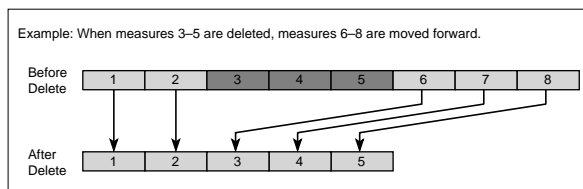

**!** If in ④ you uncheck **“All Tracks”** and execute this operation, the measures will not be deleted from the master track. Time signature and tempo data will remain unchanged, and the time signature and tempo of the measures that were moved forward as a result of the Delete operation will change.

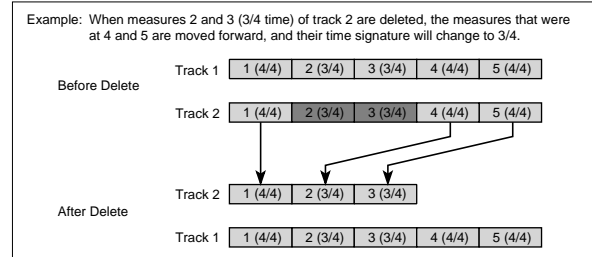

**!** If in ④ you **check “All Tracks”** and execute this operation, the specified measures of musical data will be deleted from all tracks including the master track, and the time signature and tempo will also move forward by the number of measures that were deleted. If control data extends across a line between measures that were deleted and measures that were not deleted, only the data within the range being deleted will be erased. However if note data extends across two or more measures, deleting any of the intervening measures will delete that note data from the following measures as well.

### 5-1H: Insert Measure

This command inserts the specified number of measures into the specified track. When you execute the Insert Measure command, the musical data following the insert location will be moved backward.

If musical data is inserted into a range of measure across which note data has been tied, a note-off will be created immediately before the inserted measure, and the subsequent portion of the note will be deleted.

- ① In **“Track Select,”** specify the track into which you wish to insert.
- ② Select **“Insert Measure”** to access the dialog box.

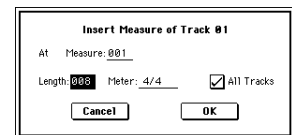

- ③ In **“At Measure,”** specify the measure location at which the data will be inserted. (The measure you specified in Track Edit page **“From Measure”** will be set as a default.)
- ④ In **“Length,”** specify the number of measures that will be inserted.
- ⑤ In **“Meter,”** specify the time signature of the measures that will be inserted. If you want the inserted measures to match the existing time signature, specify **\*\*/\*\***. With any setting other than **\*\*/\*\***, the time signature of the inserted measures will change, and the specified time signature will apply to all tracks for those measures.
- ⑥ If you wish to insert measures into all tracks including the master track, **check “All Tracks.”** The musical data following the inserted measures will playback in the same way it did before the measures were inserted. If **“All Tracks”** is **unchecked**, the measures will be inserted only into the specified track. At this time, the musical data following the inserted location will be moved toward the end of the sequence by the number of measures that were inserted. However, the time signature and tempo recorded in the master track and will not change.
- ⑦ To execute the Insert Measure command, press the **OK button**. To cancel, press the **Cancel button**.

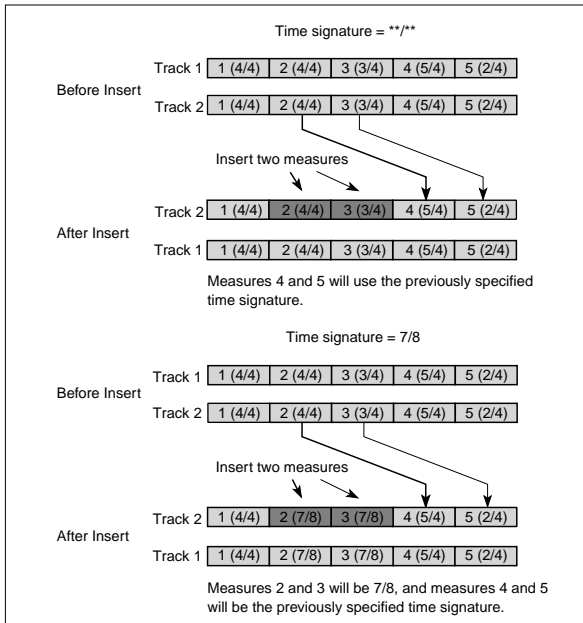

### 5-1I: Repeat Measure

This command repeatedly inserts the specified measures for the specified number of times. When you execute the Repeat Measure command, the measures will be inserted following the measure specified by "To End of Measure," and musical data following the inserted data will be moved backward. It is convenient to use this command when you have a song that you playback with "Track Play Loop" (0-5a/6a) turned on, and wish to expand it into musical data.

- Use "Track Select" to select the track whose measures you wish to repeat.
- Select "Repeat Measure" to access the dialog box.

Repeat Measure of Track 01

From Measure: 001 To End of Measure: 004

Times: 002  All Tracks

Cancel OK

- In "From Measure" and "To End of Measure," specify the range of measures that will be repeated. (By default, "From Measure" and "To End of Measure" will be set to the range you specified in the Track Edit page.)
- In "Times," specify the number of repetitions. For example if you set "From Measure" to 001, "To End of Measure" to 004, and "Times" to 2, the musical data of measures 1-4 will be inserted into measures 5-8. The result will be that measures 1-4 will be played twice.
- If you wish to repeat the musical data of all tracks including the master track, check "All Tracks."
- To execute the Repeat Measure command, press the OK button. To cancel, press the Cancel button.

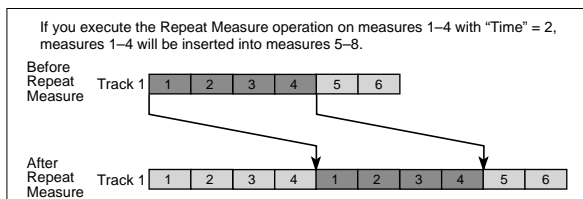

### 5-1J: Copy Measure

This command copies the measures of musical data specified as the "From" source to the beginning of the measure specified as the "To" location.

When you execute the Copy Measure command, the existing track data at the copy destination will be rewritten.

- Select the copy source song.
- Select "Copy Measure" to access the dialog box.

Copy Measure

From (Song 000) : Track: 01  All Tracks

From Measure: 001 To End of Measure: 008

To: Song: 000 Track: 02 Measure: 001

Cancel OK

- In "From": "Track," select the copy source track. (By default, this will be the track you selected in "Track Select.")  
If you check "All Tracks," the musical data of all tracks including the master track will be copied.
- In "From Measure" and "To End of Measure," specify the range of copy source measures. (By default, "From Measure" and "To End of Measure" will be the range that you specified in the Track Edit page.)
- In "To: Song," specify the copy destination song. In "Track" (when "All Tracks" is unchecked) specify the copy destination track. In "Measure," specify the first measure where the copied measures will be inserted.
- To execute the Copy Measure operation, press the OK button. To cancel, press the Cancel button.

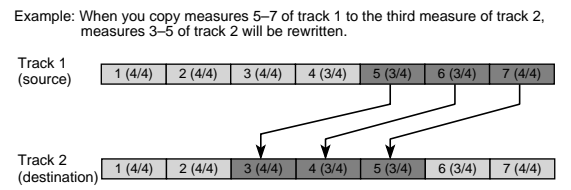

### 5-1K: Move Measure

This command moves measures of musical data to a specified destination. When you execute the Move Measure command, musical data following the move source will be moved forward according to the number of measures moved, and musical data following the move destination will be moved backward correspondingly.

- Select "Move Measure" to access the dialog box.

Move Measure

From: Track: 01  All Tracks

From Measure: 001 To End of Measure: 008

To: Track: 02 Measure: 001

Cancel OK

- In "From": "Track," select the move source track. (By default, this will be the track you selected in "Track Select.")  
If you check "All Tracks," musical data of all tracks including the master track will be moved.
- In "From Measure" and "To End of Measure," specify the range of measures that will be moved. (By default, "From Measure" and "To End of Measure" will be the range that you specified in the Track Edit page.)
- In "To: Track" (if "All Tracks" is unchecked), specify the move destination track. In "Measure," specify the first measure of the move destination.
- To execute the Move Measure command, press the OK button. To cancel, press the Cancel button.

### 5-1L: Create Ctrl Data (Create Control Data)

This command gradually varies continuous-type data (e.g., control change, after touch, pitch bend, tempo) in the specified area.

- In **"Track Select,"** select the track on which you wish to perform the Create Control Data command.  
If you wish to modify tempo data, select **Master Track** as the track. In this case, the step ④ item **"Kind"** will be set to **"Tempo."**
- Select **"Create Ctrl Data"** to access the dialog box.

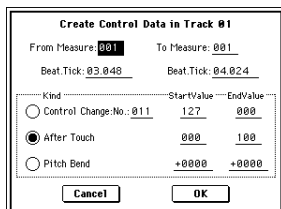

- Specify the range into which the control data will be inserted.  
In **"From Measure"** and **"To End of Measure"** specify the measures, and in **"Beat.Tick"** specify the beat and clock. (By default, **"From Measure"** and **"To End of Measure"** will be set to the range you specified in the Track Edit page.)
- "Kind"** to the type of musical data (event) that you wish to create.  
**Control change:** Control change data will be inserted. In this case, use **"#"** to specify the control change number.  
**After Touch:** Aftertouch data will be inserted.  
**Pitch Bend:** Pitch bend data will be inserted.
- In **"Start Value,"** select the starting value of the control data. In **"End Value,"** select the ending value of the control data. By default, the **"Start Value"** will be set to the value of the existing data at the start location. If you wish to create control data that changes smoothly from the starting location, you can leave the **"Start Value"** unchanged, and set only the **"End Value."**
- To execute the Create Control Data command, press the **OK button**. To cancel, press the **Cancel button**.

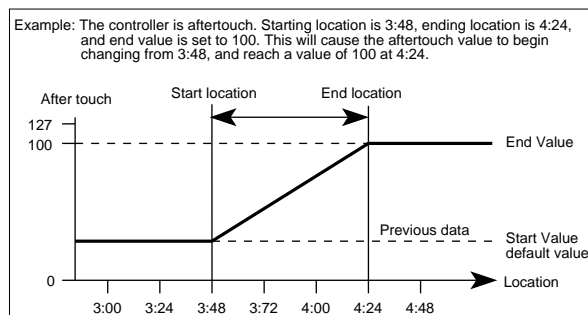

- ⚠** When you execute Create Control Data, a large amount of sequencer memory will be consumed. For this reason it may not be possible to execute this command if there is a limited amount of memory remaining. In such cases, first use **"Quantize"** (5-1N) to quantize the data and remove unnecessary control data. Alternatively, you could quantize the data that was inserted by the Create Control Data command.

### 5-1M: Erase Ctrl Data (Erase Control Data)

This command erases data such as control changes, after touch, pitch bend, or tempo in the specified range.

- In **"Track Select,"** select the track from which you wish to erase control data.  
If you wish to erase tempo data, select **Master Track**. In this case, the **"Kind"** item in step ④ will be **Tempo**.
- Select **"Erase Ctrl Data"** to access the dialog box.

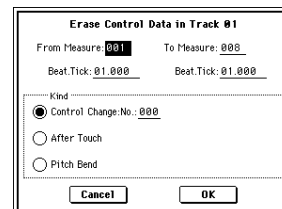

- Specify the range from which you wish to erase control data.  
In **"From Measure"** to **"To End of Measure"** specify the measures, and in **"Beat.Tick"** specify the beat and clock. (By default, **"From Measure"** and **"To End of Measure"** will be the range that was specified in the Track Edit page.)
- "Kind"** to the type of musical data (event) that you wish to erase.  
**Control change:** Control change data will be erased. In this case, use **"#"** to specify the control change number.  
**After Touch:** Aftertouch data will be erased.  
**Pitch Bend:** Pitch bend data will be erased.
- To execute the Erase Control Data command, press the **OK button**. To cancel, press the **Cancel button**.

**note** If you wish to erase all control change data from specified measures, you can also use **"Erase Measure"** (5-1F) and set **"Kind"** to **Control Change**. However, this Erase Control Data command allows you to specify the range using **"Beat.Tick,"** and also to erase only specific types of control change data.

### 5-1N: Quantize

This command corrects the timing of musical data that already exists in the sequencer. When you execute the Quantize operation, the musical data will be affected as follows:

- When you execute Quantize on note data, the timing of the note-on will be corrected, but the length (duration of the note) will not be affected.
- If the Quantize resolution is set to **Hi**, the timing will be adjusted to units of the base resolution ( $\frac{1}{192}$ ), so note data will not be affected. However, continuous controller data such as joystick or after touch which occupies a large amount of memory will be processed so that two or more data events of an identical type existing at a single interval of the timing resolution will be combined into a single event, thus conserving memory. Similarly, two or more data events of an identical type existing at the identical timing will be combined into one, also conserving memory.

- In **"Track Select,"** specify the track.
- Select **"Quantize"** to access the dialog box.

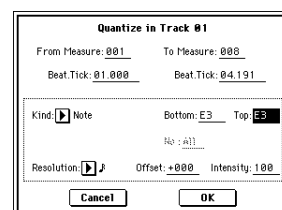

- Specify the range that will be quantized.

In “**From Measure**” and “**To End of Measure**,” specify the measures. In “**Beat.Tick**” specify the beat and clock. (By default, “From Measure” and “To End of Measure” will be the range that you specified in the Track Edit page.)

- ④ In “**Kind**,” select the type of musical data (events) that you wish to quantize.

**All:** Quantization will be applied to all performance data.  
**Note:** Quantization will be applied only to note data. Use “**Bottom**” and “**Top**” to specify the range of notes. “**Bottom**” specifies the lowest note that will be affected, and “**Top**” specifies the highest note. You can use this when you want to quantize only a specific note or notes (for example, just the snare sounds of a drum track). If you want to quantize all notes, set these parameters **C-1** and **G9** respectively. These note settings can also be input by holding down the [Enter] key and playing a note on the keyboard.

**Control Change:** Quantization will be applied to control changes. If you want to quantize only a specific control change, specify the number (“No.”). If you want to quantize all control changes, select **All**.

**After Touch:** Quantize both Channel Pressure and Polyphonic Key Pressure messages.

**Pitch Bend:** Pitch bend data will be quantized.

**Program Change:** Program change data will be quantized.

- ⑤ In “**Resolution**,” specify the timing resolution to which the data will be corrected.

By setting a lower resolution you can save more memory, but the timing of the playback may not be acceptable.

- ⑥ In “**Offset**,” specify the number of clock ticks by which the data will be moved forward or backward relative to the standard timing. A setting of **96** will be ♩, and **48** will be ♪. Positive (+) settings will adjust the data forward, and negative (-) settings will adjust the data backward. This allows you to simulate “pushing” or “dragging” the beat.

- ⑦ In “**Intensity**,” specify the degree of sensitivity to which the timing will be corrected; i.e., how close to the locations specified by ⑤ and ⑥ the data will be moved. With a setting of **0**, no correction will take place. With a setting of **100**, the data will be moved all the way to the timing intervals specified by ⑤ and ⑥.

- ⑧ To execute the Quantize command, press the **OK button**. To cancel, press the **Cancel button**.

\* By varying the “Offset” and “Intensity” settings you can create quantize effects such as the following.

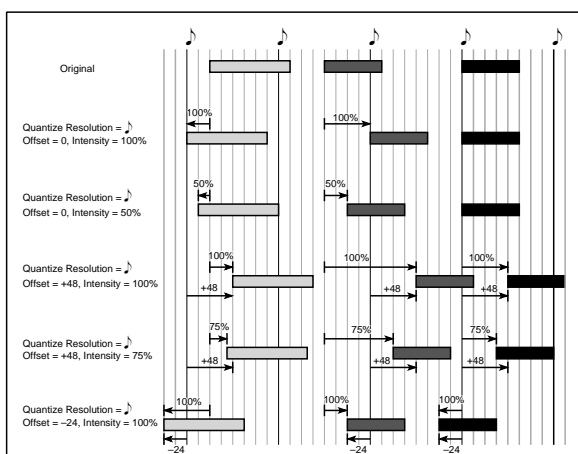

## 5-10: Shift/Erase Note

This command shifts (moves) or erases the specified note numbers in a specified track and range of measures.

- ① In “**Track Select**,” select the track on which you wish to execute the Shift/Erase Note command.  
 ② Select “**Shift/Erase Note**” to access the dialog box.

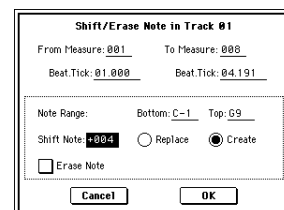

- ③ Specify the range in which you wish to shift or erase note numbers.

In “**From Measure**” and “**To End of Measure**,” specify the measures. In “**Beat.Tick**,” specify the beat and clock. (By default, “From Measure” and “To End of Measure” will be the range that you specified in the Track Edit page.)

- ④ Specify the range of notes that you wish to shift or erase. “**Note Range: Bottom**” specifies the lower limit, and “**Top**” specifies the upper limit. If you wish to edit all notes, set “**Bottom**” to **C-1** and “**Top**” to **G9**. These settings can also be made by holding down the [ENTER] key as you play a note.

### • Shifting notes

- ⑤ In “**Shift Note**,” specify the amount by which you wish to move the note.

The amount of shift is set in semitone steps over a range of **-127**–**+127**. **+1** will shift the note a semitone upward.

- ⑥ Select either “**Replace**” to move the note numbers, or “**Create**” to generate additional notes.

For example if you are editing a track that uses a drum program, you can use “Replace” to exchange the current snare sound for a different snare sound assigned to a different key, or use “Create” to add a sound effect at a different note # to the snare sound. Alternatively, you can use “Create” to add an octave doubling to an existing guitar phrase, etc.

- ⑦ To execute the Shift Note command, press the **OK button**. To cancel, press the **Cancel button**.

### • Erasing notes

- ⑤ Check “**Erase Note**.”

If you wish to erase all note data in the specified range of measures, you can also use the “**Erase Measure**” command (5-1F) and set “**Kind**” to **Note**. However, this Shift/Erase Note command lets you specify the “**Beat.Tick**” range, and to erase only specific ranges of note data.

- ⑥ To execute the Erase Note command, press the **OK button**. To cancel, press the **Cancel button**.

### 5-1P: Modify Velocity

This command modifies the velocity values of notes in the specified area so that they will change over time according to a selected curve.

- 1 In "**Track Select**," specify the track whose velocity will be modified.
- 2 Select "**Modify Velocity**" to access the dialog box.

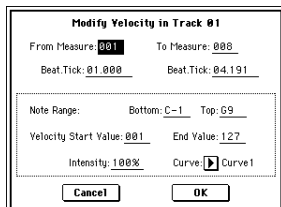

- 3 Specify the range in which note velocity will be modified. "**From Measure**" and "**To End of Measure**" specify the measure, and "**Beat.Tick**" specify the beat and clock. (By default, "From Measure" and "To End of Measure" will be set to the range that you specified in the Track Edit page.)
- 4 Specify the range of notes that will be affected by the Modify Velocity command. **Note Range "Bottom"** is the lower limit, and "**Top**" is the upper limit. If you wish to edit all notes, set "**Bottom**" to C-1 and "**Top**" to G9. These settings can also be made by holding down the [ENTER] key as you play a note on the keyboard.
- 5 In "**Velocity Start Value**" specify the value at which the velocity data will start, and in "**End Value**" specify the final velocity value. These settings can also be made by holding down the [ENTER] key as you play a note on the keyboard.
- 6 In "**Intensity**," specify the degree to which the velocity data will be adjusted toward the curve you specify in 7. With a setting of 0 [%], the velocity will not change. With a setting of 100 [%], the velocity will be exactly as described by the curve.
- 7 "**Curve**"\* lets you select from six types of curve to specify how the velocity will change over time.
- 8 To execute the Modify Velocity operation, press the **OK button**. To cancel, press the **Cancel button**.

\* The six curves are as follows.

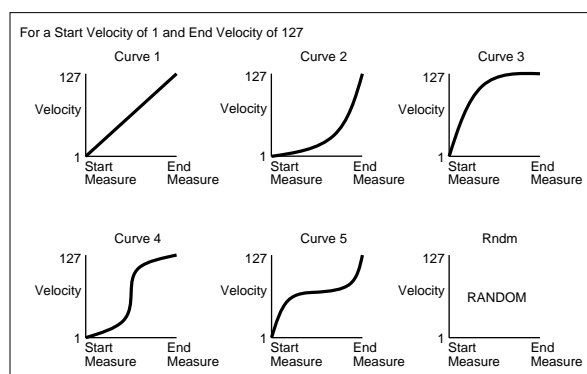

### 5-1Q: Set Song Length

This command changes the length of the specified song. When it is executed, the length of the master track will change, and the number of measures played will change.

- 1 Select "**Set Song Length**" to access the dialog box.

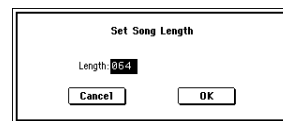

- 2 In "**Length**," specify the length of the song.
- 3 To execute the Set Song Length command, press the **OK button**. To cancel without executing, press the **Cancel button**.

⚠ Be aware that if you shorten the song, data will also be deleted from the tracks other than the master track.

## 5-2: Track Name

Here you can assign a name to each track.

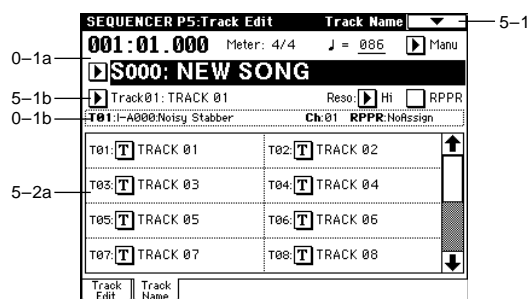

### 5-2a: Track Name

**Track Name** [TRACK 01...TRACK 16]

Press the text edit button to access the dialog box, and input the desired name. Up to 16 characters may be used. (BG p.53, 57)

## Sequencer P6: Pattern/RPPR

On the TRITON STUDIO you can use **preset patterns P000-149**, and **user patterns U00-99**. One song can contain up to one hundred user patterns. Preset patterns suitable for use in a drum track are provided in memory, and can be selected from any song.

Preset patterns cannot be edited, but you may copy a preset pattern to a user pattern, and edit.

User patterns can be created by realtime recording (including recording that uses the arpeggiator), step recording, the Get From Track command (obtaining data from a track), or the Copy Pattern command (copying from another pattern) (☞BG p.86).

These patterns can be assigned to each key by the RPPR (Realtime Pattern Play/Recording) function and played by pressing a single key, and the resulting performance can be recorded on the sequencer (☞RPPR Setup page).

### 6-1: Pattern Edit

Here you can record a pattern, edit it, and assign it to a track in a song.

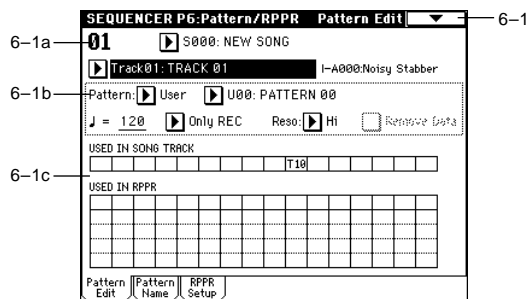

#### 6-1a: Location, Song Select, Track Select

**Location** [01...99]  
Displays the current measure location of the selected pattern.

**Song Select** [000...199: name]  
Selects a song.  
The user pattern will be created in the song you select.

**Track Select** [Track01...Track16, Master Track]  
Selects the track that will be used to record/play the pattern data. The pattern data will be recorded/played using the settings of the track you select. The area at the right displays the program bank, number, and name for the selected track.

#### 6-1b: Pattern, Pattern Select, Tempo, Metronome Sound, Reso, Remove Data

If you wish to record pattern data, use "Pattern" and "Pattern Select" to select a user pattern and pattern number. Next, use the "Pattern Parameter" page menu command to set the number of measures in the pattern and its time signature. Then you can perform realtime recording in the Pattern Edit page, or step recording by using the "Step Recording (Loop Type)" page menu command. Finally, use page menu commands as desired to perform event editing or other types of editing.

**Pattern (Pattern Bank)** [Preset, User]  
Selects the type of pattern.

If **Preset** is selected, it will not be possible to record. You will be able to select and execute the "Copy Pattern," "Bounce Pattern," "Put to Track," and "Copy to Track" page menu commands.

**Pattern Select** [P000...149, U00...U99]  
Selects a pattern. User patterns can be renamed in the Pattern Name page.

**♩ (Tempo)** [040...240, EXT]  
Specifies the playback tempo of the pattern. (☞0-1a).

**Metronome Sound** [Only REC, REC & Play, Off]  
Specifies whether the metronome will sound during recording or playback. (☞0-8b, "Sound," "Metronome Setup")

**Reso (Resolution)** [Hi,  $\frac{3}{8}$  ... ♩]  
Specifies how the timing of the data being recorded into the pattern will be corrected. (☞0-1a "Reso (Resolution).")

**Remove Data** [Off, On]

**On (checked):** Unwanted performance data can be removed during pattern recording. The procedure is the same as explained in "Remove Data" of Loop All Tracks. (☞0-8a)

#### 6-1c: USED IN SONG TRACK, USED IN RPPR

##### USED IN SONG TRACK

This area indicates the song tracks in which the selected pattern is used.

##### USED IN RPPR

This area indicates the RPPR in which the selected pattern is used. The assigned key and the specified track are shown.

#### How to record a user pattern

- 1 Use "Song Select" to select the song in which you want to create a user pattern.
- 2 Use "Track Select" to select the sound that you will record.  
The pattern you record will sound according to your choice in "Track Select."
- 3 Use "Pattern Bank" and "Pattern Select" to select User pattern and the desired pattern number.
- 4 Select the page menu command "Pattern Parameter," and in the dialog box, specify the number of measures and time signature of the pattern.
- 5 Check the tempo in "♩".
- 6 If you want to record in realtime, set "Reso" to specify the resolution, and press the SEQUENCER [REC/WRITE] key and then the [START/STOP] key to begin recording.

When you finish recording to the end of the measures specified by "Pattern Parameter," you will return to the first measure, and can continue recording while adding more material. (☞"Loop All Tracks" 0-8a)

If you want to perform step recording, select the page menu command "Step Recording (Loop Type)" to access the dialog box, and record.

## ▼ 6-1: Page Menu Command

0-1A	Memory Status	Bounce Pattern	6-1F
6-1A	Step Recording (Loop Type)	Get From Track	6-1G
6-1B	Event Edit	Put To Track	6-1H
6-1C	Pattern Parameter	Copy To Track	6-1I
6-1D	Erase Pattern	FF/REW Speed	0-1I
6-1E	Copy Pattern		

### 6-1A: Step Recording (Loop Type)

Here you can perform step recording into a pattern. This is available when a user pattern is selected.

- ① In "Pattern" and "Pattern Select," specify the pattern. By default, the pattern length is one measure. If you wish to change the number of measures in the pattern, set the "Pattern Parameter" (6-1C).
- ② Select "Step Recording (Loop Type)" to access the dialog box.

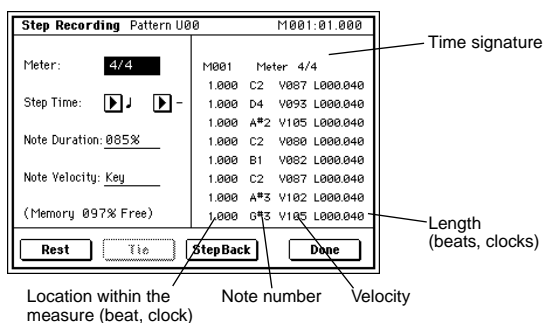

- ③ The remaining steps are the same as when step recording on a track. Refer to steps ③ and following in "Step Recording" (5-1A). However, step recording a pattern differs from step recording a track in that when you reach the end of the pattern, you will return to the beginning and continue recording, in this way continuing to add more data.

### 6-1B: Event Edit

Here you can edit individual events of the musical data in a pattern.

Use "Pattern" and "Pattern Select" to specify the pattern, and then select this command.

The remaining steps are the same as when Event Editing a track. ⌘ "Event Edit" (5-1B).

### 6-1C: Pattern Parameter

This command specifies the number of measures and the time signature of the selected pattern.

- ① Use "Pattern" and "Pattern Select" to specify the pattern.
- ② Select "Pattern Parameter" to access the dialog box.

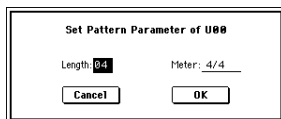

- ③ In "Length," specify the number of measures in the pattern.
- ④ In "Meter," specify the time signature of the pattern. However, this time signature is only temporary, and when you "put" or "copy" the pattern in a track of a song, the pattern will play according to the time signature of that measure.
- ⑤ To execute the Pattern Parameter settings, press the **OK button**. To cancel, press the **Cancel button**.

### 6-1D: Erase Pattern

This command erases the data from the selected pattern.

- ① Use "Pattern" and "Pattern Select" to specify the pattern.
- ② Select "Erase Pattern" to access the dialog box.

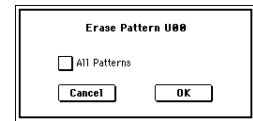

- ③ If you check "All Patterns," all user patterns in the song will be erased. If "All Patterns" is not checked, only the pattern specified in ① will be erased.
- ④ To execute the Erase Pattern command, press the **OK button**. To cancel, press the **Cancel button**.

### 6-1E: Copy Pattern

This command copies the settings and musical data of the selected pattern to another pattern.

User patterns belong to a particular song, but you can use the Copy Pattern command to use the same pattern in another song.

Also, while preset patterns cannot be edited, you can copy a preset pattern to a user pattern and then edit and save it as a user pattern. Be aware that when you execute the Copy Pattern operation, the pattern settings and musical data of the copy destination will be erased.

- ① Select "Copy Pattern" to access the dialog box.

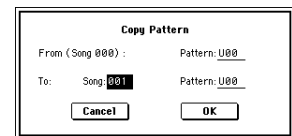

- ② In **From (Song\*\*\*): "Pattern,"** specify the copy source pattern. (By default, this will be the song and pattern that was selected in the Pattern Edit page.)
- ③ In **To: "Song" and "Pattern,"** specify the copy destination song and pattern. For "Pattern," only user patterns **U00-U99** can be specified.
- ④ To execute the Copy Pattern command, press the **OK button**. To cancel, press the **Cancel button**.

### 6-1F: Bounce Pattern

This command combines the musical data of the bounce source pattern and bounce destination pattern, and places the combined musical data in the bounce destination. The time signature and length of the pattern following execution will be according to the settings of the bounce destination. Unlike the Track Bounce operation, the musical data of the bounce source will not be erased.

If MIDI control data exists in the selected pattern and in the bounce destination pattern, the resulting playback following the bounce operation may produce unexpected results. We recommend that you use "Event Edit" (6-1B) to prepare the MIDI control data of the two patterns before executing the Bounce Pattern command.

- ① Use "Pattern" and "Pattern Select" to specify the bounce source pattern.
- ② Select "Bounce Pattern" to access the dialog box.

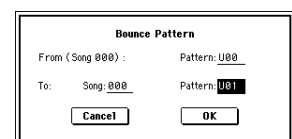

- ③ In **From (Song\*\*\*): "Pattern,"** select the bounce source pattern. (By default, the song and pattern that are selected in the Pattern Edit page will be chosen.)



- ④ In **To: "Song"** and **"Pattern,"** select the bounce destination song and pattern. For **"Pattern,"** only user patterns **U00-U99** can be specified.
- ⑤ To execute the Bounce Pattern command, press the **OK button**. To cancel, press the **Cancel button**.

### 6-1G: Get From Track

This command takes musical data from a track and loads it into the specified pattern.

- ① Use **"Pattern"** and **"Pattern Select"** to specify the pattern.
- ② In **"Pattern Parameter"** (6-1C), specify the pattern length of the **"get"** destination.
- ③ Select **"Get From Track"** to access the dialog box.

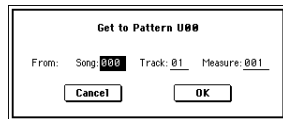

- ④ In **"Song,"** select the **"get"** source song.
- ⑤ In **"Track,"** select the **"get"** source track.
- ⑥ In **"Measure,"** specify the first measure of the **"get"** source.
- ⑦ To execute the Get From Track command, press the **OK button**. To cancel, press the **Cancel button**.

### 6-1H: Put To Track

This command places a pattern into a track.

Unlike the **"Copy to Track"** (6-1I), this command only places the pattern number in the song, so that when playback reaches that point, the pattern will be recalled. The musical data of the pattern will not actually exist in the track. By creating patterns that contain frequently-used phrases or drum patterns, and then placing them on the tracks, you can conserve memory.

Be aware that when you edit a pattern, all locations in the song where that pattern has been placed will be affected.

When you execute the Put to Track command, the musical data will be affected as follows.

- Musical data previously existing at the **"put"** destination will be erased.
- The pattern that you **"put"** will playback according to the time signature that is specified by the measures of the **"put"** destination.
- Control data such as pitch bend etc. (but not including volume data) previously existing in the track will be reset immediately before the measure at which the pattern was **"put."**

If you wish to use control data such as pitch bend in the measures in which a pattern is **"put,"** you must first write the control data into the pattern.

To delete a pattern that has been placed in a track you can use **"Erase Measure"** (5-1F), specifying the area in which the pattern was **"put,"** and setting **"Kind"** to **All**.

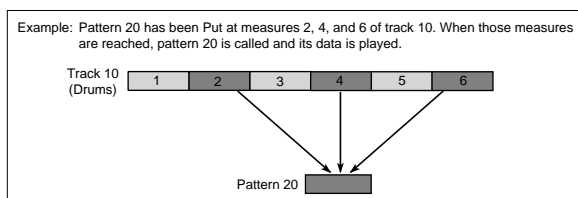

- ① Select **"Put to Track"** to access the dialog box.

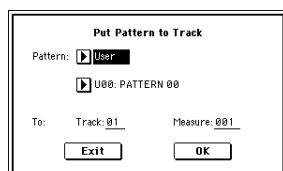

**note** If you press the SEQUENCER [START/STOP] key while the dialog box is open, the selected pattern will play back.

- ② In **"Pattern"** and **"Pattern Select,"** select the **"put"** source pattern. (By default, this will be the pattern selected in the Pattern Edit page)
- ③ In **"To Track,"** select the **"put"** destination track.
- ④ In **"Measure,"** specify the first measure of the **"put"** destination.
- ⑤ To execute the Put to Track command, press the **OK button**. When you execute the command, **"Measure"** will automatically count up. If you wish to, you can continue **"putting"** the pattern. To exit the command, press the **Exit button**.

### 6-1I: Copy To Track

This command copies the specified area of musical data from the specified pattern to a track as musical data.

Unlike the Put To Track command, this command actually writes the musical data of the pattern into the track, so that you can edit the copied data in the track. Even if you later edit the copy source pattern, the musical data of the song will not be affected.

When you execute the Copy to Track command, the musical data will be affected as follows.

- Musical data previously existing in the copy destination measures will be erased.
- The musical data that is copied will playback according to the time signature specified at the copy destination measures.

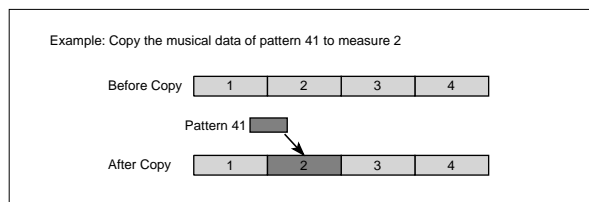

The procedure is the same as for the Put to Track command. ⌨ "Put To Track" (6-1H).

## 6-2: Pattern Name

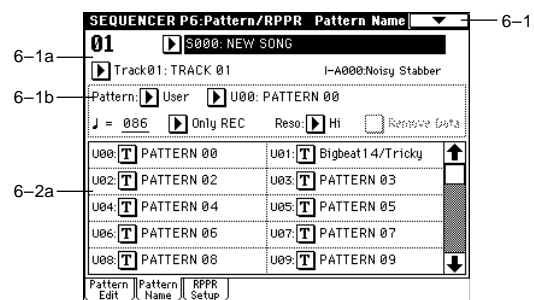

### 6-2a: Pattern name

**Pattern name** [U00...U99]  
Here you can rename the pattern. Press the text edit button to access the dialog box, and input the name. Up to 16 characters can be input. (⌨ BG p.53, 57)

## 6-3: RPPR Setup

Here you can make settings for the RPPR (Realtime Pattern Play/Recording) function. RPPR lets you assign patterns from a song to individual keys, and then playback patterns simply by pressing individual notes on the keyboard. The results can be recorded to the sequencer.

For each song, you can assign either a preset pattern or a user pattern to each of the seventy two keys in the range C#2-C8. For each key, you can specify the pattern, track number, and how the pattern will be played.

The arpeggiator is not operated by patterns played back by RPPR. When RPPR is on, keys for which no pattern is assigned will sound the track selected by "Track Select." At this time, the arpeggiator will operate if either arpeggiator A or B is selected for that track and turned on. RPPR will not be triggered by notes generated by the arpeggiator.

When Local Control is OFF ("Local Control On" Global P1: 1-1a), the keyboard will not trigger RPPR pattern playback. Notes received at MIDI IN on the channel of the track currently selected by "Track Select" will trigger patterns. If you have recorded only the trigger notes on an external sequencer and wish to use the playback from the external sequencer to trigger RPPR patterns on TRITON STUDIO, set Local Control OFF.

If you want the note data generated by RPPR to be recorded by the external sequencer, set Local Control ON, and turn off the echo back function of the external sequencer. (p.267)

In the RPPR Setup page, RPPR is turned on automatically. This will be the same result as when the RPPR check box (0-1a) in each page is checked.

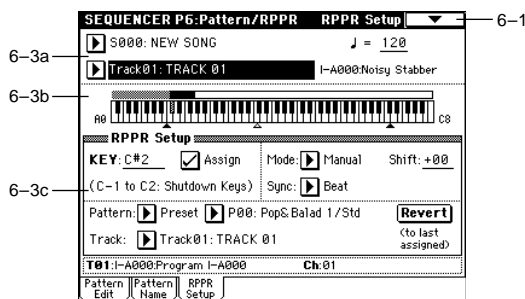

### 6-3a: Song Select, Track Select, Tempo

**Song Select** [000...199: name]

Selects the desired song. The RPPR settings will be assigned to the song you select here.

**Track Select** [Track01...Track16, Master Track]

Selects the track that will be played by keys that are not assigned to RPPR. Select the track that you want to play from the keyboard.

**Tempo** [040...240, EXT]  
Specifies the playback tempo of the patterns. (p.0-1a)

### 6-3b: Keyboard & Assigned drawing

This shows the selected key, and the keys to which a pattern has been assigned by the RPPR function. (Assignments are not possible for the keys displayed in gray.)

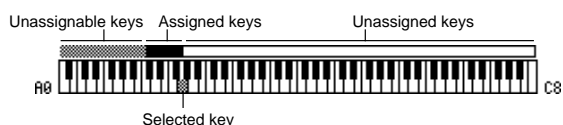

### 6-3c: RPPR Setup

**KEY (Key Select)** [C#2...C8]

Specifies the key to which you want to assign an RPPR pattern.

The following parameters will apply to the key that you select here.

This can also be selected by holding down the [ENTER] key and playing a note on the keyboard.

**Assign** [Off, On]

**On (checked):** When you playback the key specified by "KEY," the pattern selected in "Pattern" will be triggered.

**Off (unchecked):** That key will sound the currently selected track at the corresponding pitch, just as in normal Sequencer mode.

**Pattern (Pattern Bank)** [Preset, User]

**Pattern Select** [P000...149, U00...99]

Selects the RPPR pattern for the key selected in "KEY." If the selected user pattern contains no musical data, there will be no sound when you press that key.

**Track** [Track 01...Track16: name]

Selects the track that will be used for the RPPR pattern selected for the "KEY." When you play the key, the pattern will be played according to the settings of the track you select here. Track settings are made in P0: Play/REC, P2: Trk Param, P3: MIDI Filter, and P4: Zone/Ctrl. When you record in realtime with the RPPN function turned on, the data will be recorded on the track you select here. (p.94)

The line below displays the program bank/name and MIDI channel (Ch) that are specified for the "Track."

### Revert

When you press this button, the "Pattern (Pattern Bank)," "Pattern Select," and "Track" settings of the last-edited "KEY" for which "Assign" was checked will be copied to these parameters of the currently selected "KEY"

**Example: Assigning preset patterns P00, P01, and P02 to "KEY"**

Before you begin, assign a drum program such as INT-A036 to track 1.

- Set "KEY" to C#2, and check "Assign." Set "Pattern (Pattern Bank)" to Preset, "Pattern Select" to P00, and "Track" to Track01.

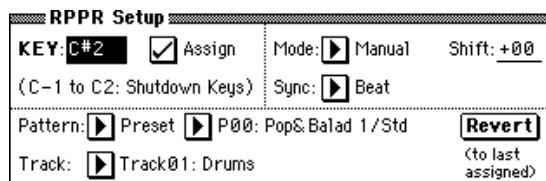

- ② Set "KEY" to D2, and press the **Revert** button. The "Pattern (Pattern Bank)," "Pattern Select," and "Track" settings that you specified in step ① will be copied automatically.
- ③ Edit only "Pattern Select." Select "Pattern Select," and press the [△] key to select P01: Pop&Balad 2/Std.
- ④ Set "KEY" to D#2, and press the **Revert** button. The "Pattern (Pattern Bank)" P01: Pop&Balad 2/Std you selected in step ③, as well as the "Pattern Select" and "Track" settings, will be copied automatically.
- ⑤ As you did in step ③, set "Pattern Select" to P02: Pop&Balad 3/Std.

By using "Revert" in this way, you can efficiently specify "Pattern (Pattern Bank)," "Pattern Select," and "Track" settings for each "KEY" when creating RPPR data. This is particularly convenient when, as in the above example, the patterns that you want to assign to the keys are numbered consecutively (or are nearby each other), and use the same track.

### Mode [Once, Manual, Endless]

Specifies the way in which the pattern assigned to the specified "KEY" will be played.

**Once:** When you press the key, the complete pattern will playback once to the end and then stop.

**Manual:** The pattern will continue repeating as long as you continue holding the key, and will stop as soon as you release the key.

**Endless:** The pattern will continue repeating even after you release the key. To stop the pattern playback, press any note below C2, or press the same key once again.

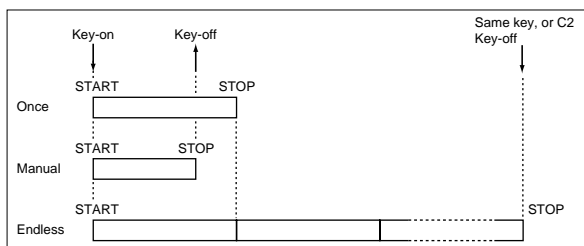

### Shift [-12...+12]

Adjusts the playback pitch of the pattern for the specified "KEY" in semitone steps over a range of ±1 octave. With a setting of 0, the pattern will be played at its original pitch.

### Sync [Off, Beat, Measure, SEQ]

Specifies the way in which the pattern playback will be synchronized when you press the specified "KEY."

**Off:** The pattern will begin playing at the moment you press the note.

**Beat:** The pattern will synchronize to the beats of the pattern that was started by the first key (i.e., the first note-on that occurs from a condition where no notes of the keyboard are pressed). This setting is suitable when you wish to play phrase patterns in unison.

**Measure:** The pattern will synchronize to the measures of the pattern that was started by the first key. This setting is suitable for rhythm, bass or drum patterns.

**SEQ:** The pattern will synchronize to the measures of the sequencer song.

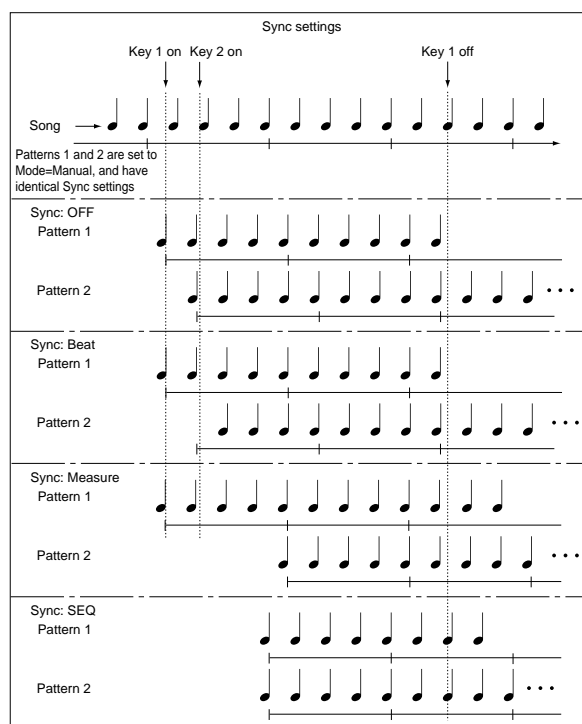

- When **Beat** or **Measure** are selected, pattern playback will begin when you press the first key. The second and subsequent patterns that are triggered from the keyboard will synchronize to the pattern that was started by the first key; with a setting of **Beat** they will synchronize in steps of a beat, and with a setting of **Measure** they will synchronize in steps of a measure.
- When **SEQ** is selected, the pattern will playback in synchronization with the measures of the sequencer song. The pattern will synchronize with the currently-playing song, so you must start the song before you play notes on the keyboard.
- **Beat**, **Measure**, and **SEQ** will cause the pattern to start immediately if you play the key within a thirty-second note of the timing of the respective beat or measure, but if you play the key later than this, the start of the pattern will be delayed by a beat.

#### Stopping playback of a RPPR pattern

By pressing C2 (or any note lower than C2), all the patterns being played by RPPR will stop.

The patterns of keys whose "Sync" setting is Off will stop immediately, but the playback of other keys will stop at the beginning of the next beat or measure. Pattern playback of keys whose "Sync" setting is other than Off can be stopped immediately by rapidly pressing C2 or any lower note twice in succession.

## Sequencer P7: Arpeggiator

Here you can specify how the arpeggiator will operate in Sequencer mode. These settings can be made for each song. In Sequencer mode (as in Combination mode), you can run the two arpeggiators simultaneously. This allows you to apply different arpeggio patterns to two sounds that have been split across the keyboard, or use velocity to switch between two different arpeggio patterns, etc.

In Sequencer mode, the musical data generated by the arpeggiator during song track or pattern realtime-recording can be recorded. While you record, you can modify the arpeggio pattern and parameters, and adjust the [GATE] knob and [VELOCITY] knob etc.

 It is not possible to set the tempo of the arpeggiator and the sequencer independently.

When “MIDI Clock” (Global P1: 1–1a) is **Internal**, the arpeggiator can be synchronized to the internal sequencer. (☞ BG p.138)

- When you turn on the arpeggiator and press the SEQUENCER [START/STOP] key, the arpeggiator will synchronize to the timing of the sequencer.
- When you press the SEQUENCER [START/STOP] key, the arpeggiator and sequencer will both stop. If you wish to stop only the arpeggiator, press the ARPEGGIATOR [ON/OFF] key to turn off.

When the arpeggiator “Key Sync” is **off**, you can turn on the ARPEGGIATOR [ON/OFF] key and play the keyboard to start the arpeggiator running during the pre-count before realtime recording begins, so that the arpeggiator performance will be recorded from the beginning of the pattern at the same time that recording begins.

 When “MIDI Clock” is **External MIDI** or **External mLAN**, the MIDI realtime clock messages transmitted from the external MIDI device connected to MIDI IN or the mLAN connector can perform the same type of control.

Even in this case, you can start/stop using the SEQUENCER [START/STOP] key of the TRITON STUDIO's sequencer.

### 7-1: Setup 1–8 (Setup T01-08)

### 7-2: Setup 9–16 (Setup T09-16)



### 7-1(2)a: Arpeggiator Assign, Arpeggiator Run A, B

#### Arpeggiator Assign [Off, A, B]

This assigns arpeggiator A or arpeggiator B to each track 1–8, 9–16. When the ARPEGGIATOR [ON/OFF] key is turned on, the arpeggiator specified for each track will run, subject to the “Arpeggiator Run A, B” settings and setting here.

**Off:** The arpeggiator will not operate.

**A:** Arpeggiator A will operate. Use the Arpeggiator A page to select the arpeggio pattern and set the parameters.

**B:** Arpeggiator B will operate. Use the Arpeggiator B page to select the arpeggio pattern and set the parameters.

For tracks that you wish to realtime-record, select either arpeggiator A or B. If you specify an arpeggiator for two or more tracks, the arpeggiator will play each of the tracks you specify.

You can set A and B to two different MIDI channels, and control one from the keyboard and the other from an external MIDI device connected to MIDI IN. You can also use multi-track recording (**Multi REC**) to simultaneously record the note data that is generated from the two arpeggiators.

#### Example 1)

On tracks 1 and 2, set “MIDI Channel” (2–1a) to **01** and “Status” (2–1a) to **INT**. Assign arpeggiator A to track 1 and arpeggiator B to track 2, and check “Arpeggiator Run A, B” (7–1a). In “Track Select,” choose **Track01**. With the ARPEGGIATOR [ON/OFF] key **OFF**, play the keyboard and tracks 1 and 2 will sound simultaneously. When you turn **on** the ARPEGGIATOR [ON/OFF] key and play the keyboard, arpeggiator A will operate for track 1 and arpeggiator B will operate for track 2.

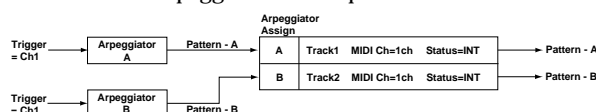

#### Example 2)

For tracks 1, 2 and 3, set the “MIDI Channel” (2–1a) to **01**, **02**, and **03** respectively, and set “Status” (2–1a) to **INT**. Assign arpeggiator A to tracks 1 and 2, and arpeggiator B to track 3. Check the “Arpeggiator Run A, B” (7–1a) setting.

- In “Track Select,” choose **Track01**.  
Playing the keyboard when the ARPEGGIATOR [ON/OFF] key is **off** will play the sound assigned to track 1. Playing the keyboard when the ARPEGGIATOR [ON/OFF] key is **on** will cause arpeggiator A to operate for tracks 1 and 2, and produce sound for both tracks.
- In “Track Select,” choose **Track02**.  
Playing the keyboard when the ARPEGGIATOR [ON/OFF] key is **off** will play the sound assigned to track 2. Playing the keyboard when the ARPEGGIATOR [ON/OFF] key is **on** will cause arpeggiator A to operate for tracks 1 and 2, and produce sound for both tracks.
- In “Track Select,” choose **Track03**.  
Playing the keyboard when the ARPEGGIATOR [ON/OFF] key is **off** will play the sound assigned to track 3. Playing the keyboard when the ARPEGGIATOR [ON/OFF] key is **on** will cause arpeggiator B to operate for track 3, and play the sound assigned to track 3.

- Alternatively, you could choose **Track01** in “**Track Select**” to run arpeggiator A for tracks 1 and 2, and use an external MIDI device connected to the TRITON STUDIO’s MIDI IN to send note data to MIDI channel 3 to play arpeggiator B.

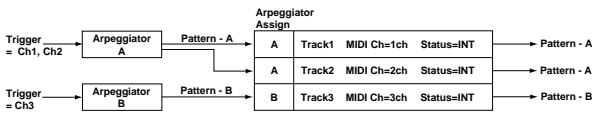

The arpeggiator cannot be triggered by the notes played by the sequencer.

**MIDI** If the track “**Status**” (2-1a/2a) is set to **INT** or **BTH**, tracks 1-16 to which arpeggiator A or B are assigned will be sounded by the note data generated by the arpeggiator, regardless of the “**MIDI Channel**” (2-1a/2a) setting of that track. If the track “**Status**” is set to **BTH**, **EXT**, or **EX2**, the track will transmit MIDI note data on the “**MIDI Channel**” of that track. In this case, arpeggiator A or B will be triggered by the “**MIDI Channel**” of any track 1-16 to which the corresponding arpeggiator is assigned.

**MIDI** If the “**Local Control On**” (Global P1: 1-1a) is turned OFF, the arpeggiator will not be triggered by note data from the keyboard. It will be triggered by note data received at MIDI IN. If you wish to record just the trigger notes on an external sequencer and run the TRITON STUDIO’s arpeggiator in this way, turn Local Control OFF.

If you want the note data generated by the arpeggiator to be recorded on the external sequencer, turn Local Control ON, and turn off the echo back function of the external sequencer. (p.267)

### Arpeggiator Run A, B

When the ARPEGGIATOR [ON/OFF] key is on, the arpeggiator(s) that are checked here will function for the track(s) to which they are assigned by “Arpeggiator Assign.”

When the arpeggiator is on, A and B can be turned on/off independently.

### 7-1: Page Menu Command

0-1A	Memory Status	Copy From Combi	0-1F
0-1B	Solo Selected Track	Copy Arpeggiator	7-1A
0-1C	Rename Song	FF/REW Speed	0-1I
0-1D	Delete Song	Set Location	0-1J
0-1E	Copy From Song		

### 7-1A: Copy Arpeggiator

This command copies arpeggiator settings.  
 Ⓜ “Combination 7-1A: Copy Arpeggiator.”

### 7-3: Arpegg. A (Arpeggiator A)

### 7-4: Arpegg. B (Arpeggiator B)

In the Arpegg. A page you can make settings for arpeggiator A, and in the Arpegg. B page you can make settings for arpeggiator B.

**note** The “Copy Arpeggiator” (7-1A) page menu command can also be used to copy arpeggiator settings from another mode such as Program mode.

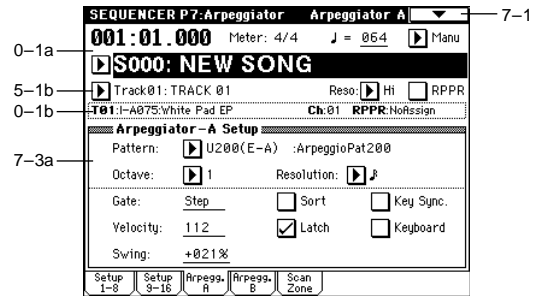

### 7-3(4)a: Arpeggiator-A(B) Setup

Pattern	[P000...P004, U000(I-A/B)...U506(User)]
Octave	[1, 2, 3, 4]
Resolution	[♩, ♪, ♫, ♮, ♯, ♭, ♮]
Gate	[000...100(%), Step]
Velocity	[001...127, Key, Step]
Swing	[-100...+100(%)]
Sort	[Off, On]
Latch	[Off, On]
Key Sync.	[Off, On]
Keyboard	[Off, On]

These are the arpeggiator parameters for the song.  
 Ⓜ “Program 7-1: Arpegg. Setup (Arpeggiator Setup)”

### 7-5: Scan Zone (Scan Zone A/B)

Specifies the range of notes and velocities that will trigger each arpeggiator A and B.

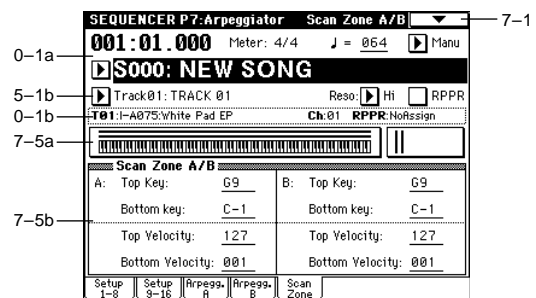

### 7-5a: Zone Map

This shows the Scan Zone settings for arpeggiators A and B.  
 (p.267) “Combination “Zone Map” 7-4a)

## 7-5b: Scan Zone A/B

A:

Top Key [C-1...G9]

Bottom Key [C-1...G9]

Specify the range of notes (keys) that will trigger arpeggiator A. "Top Key" is the upper limit, and "Bottom Key" is the lower limit.

Top Velocity [001...127]

Bottom Velocity [001...127]

Specify the range of velocities that will trigger arpeggiator A. "Top Velocity" is the upper limit, and "Bottom Velocity" is the lower limit.

B:

Top Key [C-1...G9]

Bottom Key [C-1...G9]

Top Velocity [001...127]

Bottom Velocity [001...127]

Specify the range of notes (keys) and velocities that will trigger arpeggiator B (≡A).

**note** The value of these parameters can also be input by holding down the [ENTER] key and playing a note on the keyboard.

## Sequencer P8: Insert Effect

Here you can make insert effect settings, and specify the bus etc. for the program used by each track 1-16.

≡ For details on insert effects, refer to p.178 "8. Effect Guide."

### 8-1: Routing 1-8 (Routing T01-08)

### 8-2: Routing 9-16 (Routing T09-16)

Specify the bus to which the program oscillator(s) of each track 1-16 will be sent. You can also set the amount of signal that will be sent to the master effects.

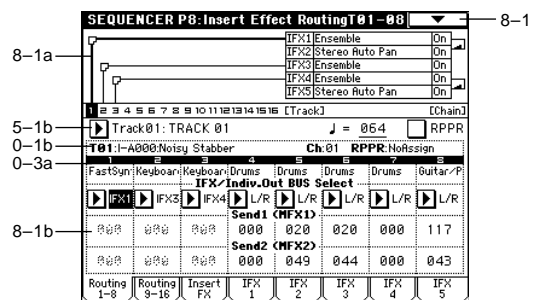

### 8-1a: Routing Map

This shows the status of the insert effects: the insert effect routing, the names of the selected effects, the on/off status, and chaining.

The effect type, on/off, and chain settings can be made in the Insert FX page (8-2).

### 8-1(2)b: BUS Select (IFX/Indiv.Out BUS Select), Send1 (MFX1), Send2 (MFX2)

#### BUS Select (IFX/Indiv.Out BUS Select)

[DKit, L/R, IFX1...5, 1...4, 1/2, 3/4, Off]

These settings specify the bus to which the program oscillator(s) of each track 1-16 will be sent.

The status of the settings can also be viewed in the "Routing Map" (≡Combination P8-1: Routing).

⚠ When 1/2 or 3/4 are selected, the program of the corresponding track 1-16 will be output in stereo from AUDIO OUTPUT (INDIVIDUAL) 1 and 2 or 3 and 4. If you use CC#10 (pan) or AMS to control the panning of the program oscillator, the new pan setting will be applied at the next note-on. Unlike the case when you select L/R to output the sound from (MAIN) L/MONO and R, the pan of a sounding note cannot be varied in realtime.

If you wish to vary the pan of a sounding note in realtime, and output the result from AUDIO OUTPUT (INDIVIDUAL) 1 and 2 or 3 and 4, set "BUS Select" to IFX1 (or IFX2-IFX5), select 000: No Effect for "IFX1" (or IFX2-IFX5) (8-3), and select either 1/2 or 3/4 for "BUS Select" (8-3) after the signal passes through IFX.

Send1 (MFX1) [000...127]  
 Send2 (MFX2) [000...127]

Here you can adjust the send levels from tracks 1-16 to master effects 1 and 2. This is valid when "BUS Select" is set either to L/R or Off. If IFX 1, 2, 3, 4, or 5 is selected, the send level to the master effects 1 and 2 is set by the "Send 1" and "Send 2" parameters located in the Insert FX page, after the signal passes through IFX 1-5.

These settings have no effect if "BUS Select" is set to 1, 2, 3, 4, 1/2 or 3/4.

The send 1 and 2 settings you make here will be used when the song is played or recorded from the beginning. If you change the settings while recording, the change will be recorded as part of the musical data, and the send amount will change when the data is played back. You can also change these settings during playback. However if send 1 and 2 data has been recorded, the settings will change accordingly.

**MIDI** If "Status" (2-1a/2a) is either INT or BTH, CC#93 and #91 can be received to control send 1 and 2 respectively and change their settings. When you switch songs or return to the beginning of a song, tracks whose "Status" is EXT, EX2 or BTH will transmit these settings via MIDI. This data will be transmitted on the MIDI channel of each track as set by "MIDI Channel" (2-1a/2a). The actual send level is determined by multiplying the value of these parameters with the send level settings of the oscillator(s) of the program used by the track ("Send1" and "Send2," Program P8: 8-1d).

### ▼ 8-1: Page Menu Command

0-1A	Memory Status
0-1B	Solo Selected Track
8-1A	Copy Insert Effect
8-1B	Swap Insert Effect
8-1C	DrumKit IFX Patch
0-1I	FF/REW Speed
0-1J	Set Location

#### 8-1A: Copy Insert Effect

☞ "Program P8: 8-1A: Copy Insert Effect."

However, the MIDI control channel specified in "Ctrl Ch" of the IFX 1-5 page will not be copied.

#### 8-1B: Swap Insert Effect

☞ "Program P8: 8-1B: Swap Insert Effect."

However, the MIDI control channel specified in "Ctrl Ch" of the IFX 1-5 page will not be swapped.

#### 8-1C: DrumKit IFX Patch

☞ "Combination P8: 8-1C: DrumKit IFX Patch."

## 8-3: Insert FX

Here you can select the type of the insert effects, turn them on/off, and make chain settings.

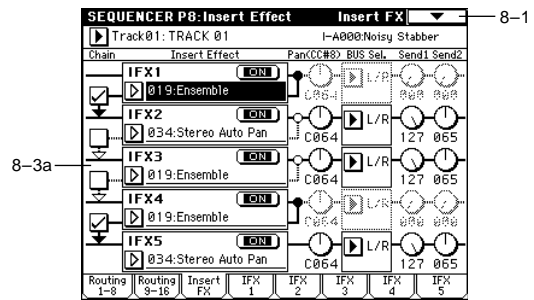

### 8-3a: IFX1, 2, 3, 4, 5

IFX1, 5 [000...089]  
 IFX2, 3, 4 [000...102]  
 IFX1, 2, 3, 4, 5 On/Off [Off, ON]  
 Chain [Off, On]  
 Pan(CC#8) (Post IFX PanCC#8) [L000...C064...R127]  
 BUS Sel. (BUS Select) [L/R, 1, 2, 3, 4, 1/2, 3/4, Off]  
 Send1 [000...127]  
 Send2 [000...127]

These functions are the same as in Program mode. (☞ Program 8-2a)

However unlike in Program mode, the "Ctrl Ch" (8-4a - 8a) is used as the MIDI channel that controls insert effect dynamic modulation (Dmod) and the "Pan (CC#8)," "Send 1," and "Send 2" that follows the insert effect. The control changes used are the same as in Program mode.

The pan (CC#8), send 1 and 2 settings you make here will be used when the song is played or recorded from the beginning. If you change the settings while recording, the changes will be recorded as part of the musical data, and the settings will change when the data is played back. You can also change these settings during playback. However if pan (CC#8), send 1, or 2 data has been recorded, the settings will change accordingly.

**MIDI** If "Status" (2-1a/2a) is either INT or BTH, CC#8, CC#93, and CC#91 can be received to control the pan following the insert effect, send 1, or send 2 respectively, and change their settings. When you switch songs or return to the beginning of the song, tracks whose "Status" is BTH, EXT, or EX2 will transmit these settings via MIDI. This data will be transmitted on the MIDI channels specified in the IFX 1-5 pages (8-4 - 8-8).

## 8-4: IFX 1

## 8-5: IFX 2

## 8-6: IFX 3

## 8-7: IFX 4

## 8-8: IFX 5

Set the parameters for the effects selected for IFX 1-5 in the Insert FX page (p.187-).

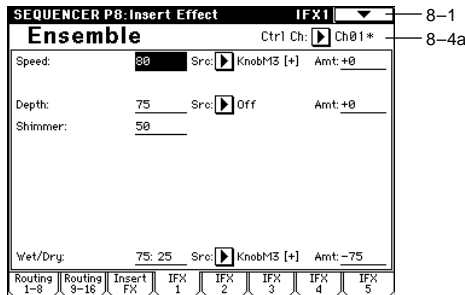

### 8-4(~8)a: Ctrl Ch [Ch01...16, All Routed]

**MIDI** Selects the MIDI channel that will control effect dynamic modulation (Dmod), pan following the insert effect (CC#8), Send 1 (CC#93), and Send 2 (CC#91).

An asterisk "\*" will appear at the right of the channel number Ch01-16 for tracks that are routed through these IFX. If you have routed multiple tracks that have differing MIDI channel settings, you can specify here which of these channels will be used to control the effect.

**All Routed:** Control can be performed from any of the MIDI channels of the tracks that are routed.

**🔊** If you have selected **DKit** as the "BUS Select" (8-1b/2b) of a track for which a drum program is selected, the MIDI channel of that timbre will be valid if **All Routed** is selected for any one of IFX 1-5, regardless of the "BUS Select" (Global P5: 5-2b) setting of the drum kit, or of the setting of the "DrumKit IFX Patch" page menu command.

## Sequencer P9: Master Effect

For details on the master effects, refer to p.182 "8. Effect Guide."

### 9-1: Master FX

Here you can select the type of master effects, turn them on/off, and make chain and master EQ settings. These parameters are the same as in Program mode. "Program 9-1: Master FX (Master Effects)"

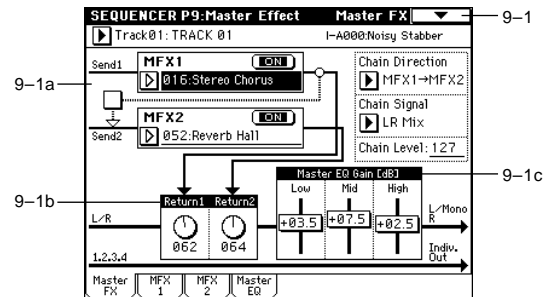

### ▼ 9-1: Page Menu Command

0-1A	Memory Status
9-1A	Copy Master Effect
9-1B	Swap Master Effect
0-1I	FF/REW Speed
0-1J	Set Location

#### 9-1A: Copy Master Effect

"Program P9: 9-1A: Copy Master Effect."

However, the MIDI control channel specified in "Ctrl Ch" of the MFX 1 and 2 pages will not be copied.

#### 9-1B: Swap Master Effect

"Program P9: 9-1B: Swap Master Effect."

However, the MIDI control channel specified in "Ctrl Ch" of the MFX 1 and 2 pages will not be swapped.



## 9-2: MFX 1

## 9-3: MFX 2

Here you can set the parameters of the MFX 1 and 2 effects that were selected in the Master FX page (see p.187-).

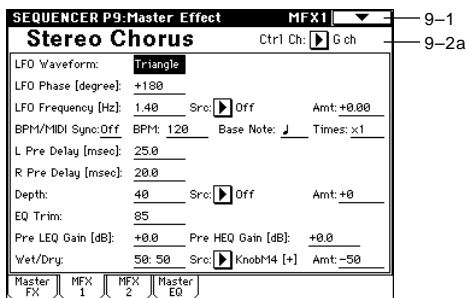

### 9-2(3)a: Ctrl Ch

Ctrl Ch [Ch01...16, Gch]

**MIDI** Specifies the MIDI channel that will control dynamic modulation (Dmod) for the master effects. If **Gch** is selected, the global MIDI channel "MIDI Channel" (Global P1: 1-1a) will be used.

## 9-4: Master EQ

The master EQ is a three-band stereo EQ. It is used to perform overall equalizing (tonal adjustment) on the sound from the L/R bus immediately before it is output to AUDIO OUTPUT (MAIN OUT) L/MONO and R (see p.239).

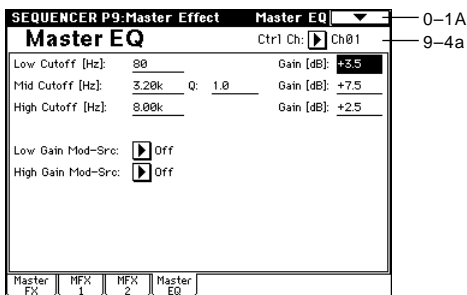

### 9-4a: Ctrl Ch

Ctrl Ch [Ch01...16, Gch]

**MIDI** Specifies the MIDI channel that will control dynamic modulation (Dmod) for the master EQ. If **Gch** is selected, the global MIDI channel "MIDI Channel" (Global P1: 1-1a) will be used.

The MEQ High Gain and MEQ Low gain can be controlled by assigning a modulation source to the "Low Gain Mod-Src:" and the "High Gain Mod-Src:" functions on this page.

# 4. Sampling mode

## An overview of sampling on the TRITON STUDIO

On the TRITON STUDIO, 48 kHz stereo 16-bit samples from an external device connected to the AUDIO INPUT jacks, S/P DIF IN jack, or mLAN connector (if the EXB-mLAN option is installed) can be recorded into the internal sample memory (RAM) or to the internal hard drive. At this time, analog signals will be converted into digital signals, and digital signals will be recorded while still in digital form. A performance using the TRITON STUDIO's filters, effects, arpeggiator, and sequencer can be resampled.

The TRITON STUDIO comes with 16 Mbytes of sample memory (RAM) and an internal hard disk. (For the capacity of the hard disk, refer to BG p.153)

The 16 Mbytes of **sample memory (RAM)** allow you to sample approximately 2 minutes 54 seconds in mono, or approximately 1 minute 27 seconds in stereo. By adding additional 72-pin SIMM boards, you can expand the memory to a maximum of 96 Mbytes (when the standard 16 Mbytes are replaced by three 32 Mbyte SIMM boards). In this case, you will be able to record up to six samples that are each approximately 2 minutes 54 seconds each for mono (or approximately 1 minute 27 seconds for stereo). (For details on the 72-pin SIMM boards that can be used, and how to install them, refer to p.286)

When sampling to the **hard drive**, a single sample file can be up to 80 minutes long for either stereo or mono (mono: approximately 440 Mbyte, stereo: approximately 879 Mbyte). This will create a WAVE file.

The TRITON STUDIO supports a wide range of sources and formats as described below.

### Sampling mode

1. An analog audio signal from a mic or audio device connected to the AUDIO INPUT jacks can be converted into a digital signal and sampled. An insert effect can also be applied while sampling.
2. A digital audio signal from a digital audio device connected to the S/P DIF jack can be sampled directly. An insert effect can also be applied while sampling. Sample rates of 48 kHz and 96 kHz are supported for the S/P DIF input and output. 96 kHz sample rate data will be converted into 48 kHz when it is sampled.
3. A digital audio signal from a digital audio device connected to the mLAN connector (if the EXB-mLAN option is installed) can be sampled directly. An insert effect can also be applied while sampling.
4. The analog audio output signal from an audio CD inserted into the CDRW-1 option (if installed) is internally connected to the AUDIO INPUT jacks. The CD can be played back on the TRITON STUDIO, and the analog audio signal converted into a digital signal and sampled. (If you are using a CD-R/RW drive connected to the SCSI connector, use a cable to connect it to the AUDIO INPUT jacks.)
5. A digital audio signal from an audio CD played back on the CDRW-1 option (if installed) or a CD-R/RW drive connected to the SCSI connector can be sampled directly (the Ripping function).
6. Resampling can be performed by applying insert effects to one or more existing samples, and once again sampling them internally. You can select either "Auto," where insert effect processing will be performed automatically on the sample you specify, or "Manual," where you can manually apply an insert effect and play the sample manually for resampling.

### Program, Combination, and Sequencer modes

1. A performance that uses the various functions of each mode (filters, effects, arpeggiator, sequencer, etc.) can be resampled. (Program: p.4, Combination: p.36, Sequencer: p.49, 56)
2. External audio sources can be sampled from the various input jacks (see "Sampling mode" paragraphs 1, 2, and 3, above). At this time, you can mix your playing on the TRITON STUDIO with the external audio, or monitor your playing on the TRITON STUDIO while sampling only the external audio from the input jacks. You can also add the master effects when sampling.
3. In Sequencer mode, you can sample an external audio source while the sequencer song plays back, and the appropriate note data will automatically be created in a track. This lets you sample vocals or guitar while the sequencer is running, just as though you were using a multi-track recorder. (In-Track Sampling function)

Samples recorded in Sampling mode, or in the Program, Combination, and Sequencer modes can be used as waveforms for the tone generator.

Samples recorded to sample memory (RAM) can be used as tone generator waveforms.

Samples recorded to the hard disk (WAVE files) can be loaded into sample memory (RAM) and used as tone generator waveforms. WAVE files can also be written to the CDRW-1 option (if installed) or a CD-R/RW drive connected to the SCSI connector, to create an audio CD.

- Individual samples (WAVE files) from the hard disk up to 16 Mbyte in size for mono or 32 Mbyte for stereo (if the sample memory has been expanded to 32 Mbyte or more) can be loaded into sample memory (RAM).

### Editing in Sampling mode

In Sampling mode, sample data created via sampling or loaded from media (including WAVE or AIFF formats) can be assigned to indexes (zones) to create a multisample. One multisample can contain multiple indexes.

A multisample you create can easily be converted into a program (Convert MS to Program" 0-1G). When a multisample is converted, the filter, amp, and effect settings will automatically be created with the program. The program can also be used in Combination mode or Sequencer mode. A sample can also be used as a drum sample in a drum kit.

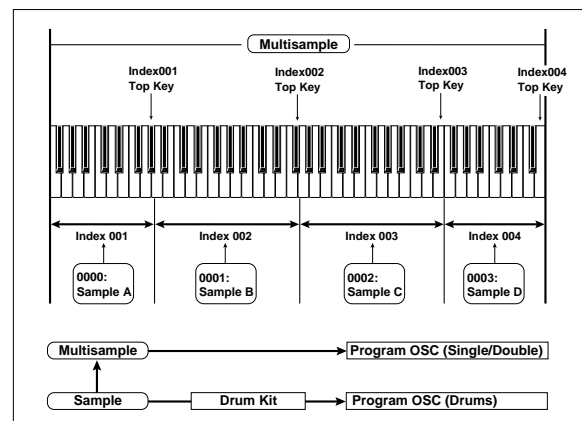

**MIDI** Regardless of the page you are in, the selected multi-sample or sample will sound when you play the keyboard, allowing you to hear the edited content of that page.

When you turn off the power, all multisample and sample data in Sampling mode will be lost. Before you turn off the power, be sure to save important data to floppy disk, hard disk, CD-R/RW or external SCSI device (see BG p.60).

When the TRITON STUDIO is turned on, memory will contain no multisamples or samples, so you will first need to load previously-saved data before you can playback or edit it.

There is no Compare function that allows you to restore sample data to the state it was in before it was edited. If you wish to preserve the unedited state of the data, use "Copy MS" (0-1E) or "Copy Sample" (0-1B) etc. to make a copy of the multisample or sample before you begin editing.

In some of the page menu commands in P1 or P2, you can **uncheck** the "Overwrite" item in the dialog box so that the unedited sample data will be preserved even after you execute the command (see 1-1: Page Menu Command "About Overwrite").

When executing a sample edit operation or when you finish recording a stereo sample, you may hear a slight noise. This does not affect the audio data that has been edited or sampled.

#### **Cautions regarding sample data**

- The sample data memory areas Bank 1-6 each contain 16 Mbyte. Of this 16 Mbyte (8,388,608 samples), sixteen samples (the first and last eight samples) are used as internal work area.
- The first and last samples of each sample are used as internal work area. These two samples are added automatically when a sample is recorded or when an .AIFF or .WAVE file is loaded. This means that if you record a sample of one second, this will result in 48,000 samples of data, but four samples will be added to this, so that sample memory (RAM) will actually contain 48,004 samples of data.

If "Auto Optimize RAM" (Global P0: 0-3b) is **on**, and the writing destination for sampling data is **RAM**, the sample memory (RAM) will automatically be optimized after the data has been written. This is turned **on** by default, but you may switch it **on/off** as necessary. (see "Optimize RAM" 0-1M)

## Sampling P0: Recording

Here you can set the input level and make other basic settings for sampling (sample recording), and make basic settings for multisamples and samples.

Normally you will record samples in this page.

### 0-1: Recording

Here you can select the multisample that you wish to record, specify the index sample, make settings, select the memory bank, and adjust the final level of the input signal.

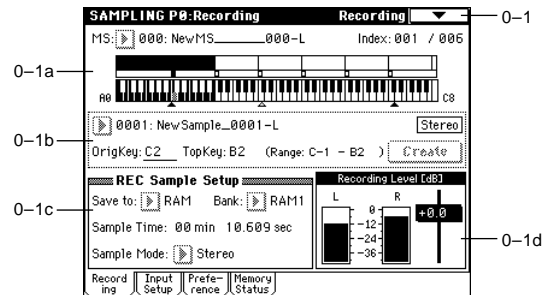

#### 0-1a: MS, Index, Keyboard & Index

##### MS (Multisample Select)

[000...999]

Selects the multisample.

Each multisample consists of the samples for one or more indexes (an "index" is a range or zone of keys).

This parameter can also be set from P1-P3.

To create a new multisample,

- Press the "MS" popup button to access the popup menu, and select a number for which the multisample name is blank. Alternatively, use the numeric keys [0]-[9] to specify a new multisample number, and press the [ENTER] key. When you select a new multisample number, the "Create New Multisample" dialog box will appear.



- If you wish to create a stereo multisample, **check "Stereo."**

- To create the multisample, press the **OK button**. To cancel, press the **Cancel button**.

A multisample will be created as follows (example).

Mono type 001: NewMS\_0001\_001

Stereo type 001: NewMS\_0001\_001-L

001: NewMS\_0001\_001-R

##### Index

[xxx (001...128)/yyy (001...128)]

Selects the index for which you wish to sample.

Each zone in a multisample is called an "index." For example on the 61 note keyboard, a multisample could be divided into six zones of one octave (12 keys) each. Each of these zones is referred to as an "index." You will assign a sample to each of these indexes.

**xxx:** The selected index. Choose the desired index.

**yyy:** The total number of indexes in the multisample.

**note** You can also select an index by holding down the [ENTER] key and playing a note on the keyboard. The index that includes this note will be selected. The key you specify will be the base key, and will be displayed in gray in “Keyboard & Index” (☞ “Keyboard & Index”).

This parameter can also be set from P1: Sample Edit, P2: Loop Edit, or P3: Multisample. Sampling and editing in the respective page will apply to the index that you select here.

When the power is turned on, this index will default to **001/001**. This indicates that only one index exists. To increase the number of indexes, use “Create” in this page. When you press the **Create button**, indexes will automatically be added from the left-most zone, as **002/002**, **003/003**, ... (The position, zone width, and original key location of the index that is created when you press the **Create button** can be set in Create Zone Preference (0-3a, 3-2a). You are also free to modify the zone width and original key location later.)

### Keyboard & Index

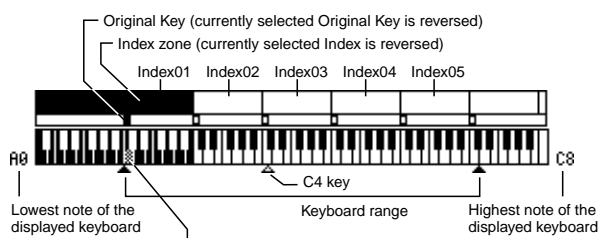

By holding down the [ENTER] key and playing a note, you can select the corresponding index, and the specified key will be the base key and will be shown in gray.

This displays the zones and original keys of the selected multisample. The black triangle shows the keyboard range, and the white triangle shows the C4 key. The note numbers at left and right show the keyboard note range that is displayed.

#### **note** The base key (displayed in gray)

- In P1: Sample Edit you can press the SAMPLING [START/STOP] key to play the sample of the selected “Index” in one-shot mode from “Edit Range Start” – “Edit Range End.” At this time, the sample will sound at the pitch of the base key.
- Playback in the grid display of P1 and P2 will be according to the playback pitch of the base key selected here, and the specified tempo BPM/resolution (set in P1 and P2).
- The “Pitch BPM Adjust” (3-1A) function is based on the playback pitch of the base key you specify here.

You can use the “Keyboard Display” (0-1J) page menu command to change the displayed range of the keyboard.

### 0-1b: Sample Select, OrigKey, TopKey, Create

Here you can set the sample, original key, and range of the selected index.

#### Sample Select [----: ---No Assign----, 0000...3999]

Selects a sample that you sampled or loaded in Disk mode, and play a note within the index range to sound that sample.

This parameter can also be set from P1-P3 (Multisample pages). Sampling and editing in the respective page will apply to the sample you select here.

----: ---No Assign----: No sample is assigned to the index. There will be no sound when you play the keyboard.

To record a sample, select a vacant sample such as **0000**. When you record a sample, data will be loaded into the selected sample. The sample name (such as NewSample\_0000) will be shown beside the number. This sample name can be modified using the “Rename Sample” (0-1C) page menu command.

You can also record a sample even when ----:---No Assign--- is displayed. In this case, a sample number will be selected automatically.

Even if you record to a sample that already contains data, the selected sample will not be overwritten –the data will automatically be sampled to a vacant sample, and the newly recorded sample will replace the previous sample in the index. If you wish to delete a sample, execute the “Delete Sample” (0-1A) page menu command.

**note** When you press the popup button, the thousand samples that include the selected sample will be displayed. To select the thousand’s place, use the VALUE controllers.

#### OrigKey (Original Key)

[C-1...G9]

Specifies the key that will play the sample at its original pitch (i.e., the pitch at which it was recorded). The pitch will change in semitone steps relative to the original key. For example, suppose that you recorded a sample with “OrigKey” of F2. When the zone of the index is C2-B2, pressing the F2 key would playback the sample at its original pitch. Pressing F#2 would playback the sample a semitone higher. Pressing E2 would playback the sample a semitone lower. The pitch of this sampled sound will change in semitone steps between C2 and B2, centered at F2. The original key location can also be viewed in “Keyboard & Index.”

**note** If “Constant Pitch” (3-1b) is checked, the sample will be sounded at its original pitch by all notes in the zone.

#### TopKey (Top Key)

[C-1...G9]

Specifies the highest key in the zone of the index. The zone is defined by this “Top Key.” For example, suppose that you set a “TopKey” of B2 for index 001/002, and a “TopKey” of B3 for index 002/002. This means that the zone of index 001 will be B2 and lower, and the zone of index 002 will be C3-B3.

#### Range

This indicates the zone (area) that was determined by the “TopKey” setting.

The sample selected by “Sample Select” will sound in this area. The zone for each index can also be viewed in “Keyboard & Index.”

#### Create

This creates an index. Use this when you wish to add a sample to a multisample.

When you press the **Create button**, a new index will be created according to the *Create Zone Preference* (0-3a, 3-2a) parameters “Position,” “Zone Range,” and “Original Key Position.” If you wish to delete an index or exchange indexes, use P3: Multisample.

**⚠** If when you execute “Create” (0-1b, 3-1c) or “Insert” (3-1c) it is not possible to create a new index according to your *Create Zone Preference* settings, one of the following dialog boxes will appear. If you wish to create a new index, perform the following procedure.

- **Set Top Key:** Select “Index” **001**, set “Position” (0-3a, 3-2a) to **Left (to Selected Index)**, and execute “Create”

or "Insert" to open the dialog box. So that a new index can be created at the left of index 1, re-set the "Top Key" setting, and press the **OK** button.

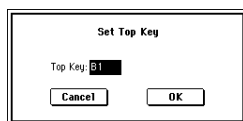

- **Set Zone Range:** If you execute "Create" when it is not possible to create a new index according to the *Create Zone Preference* settings, the following dialog box will appear. This dialog box will also appear if you execute "Insert" when it is not possible to create a new index with the contents of the "Cut" or "Copy" (3-1c). Re-set the "Zone Range" (0-3a, 3-2a), and press the **OK** button.

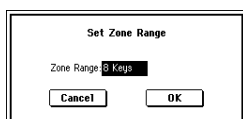

## Stereo

A **[Stereo]** indication will appear here if you have selected a stereo multisample or sample, or if you recorded a sample with "**Sample Mode**" (0-1c) set to **Stereo**.

### About stereo multisamples and stereo samples

**Stereo multisamples:** Under the following conditions, two multisamples will be handled as a stereo multisample.

- If you **checked "Stereo"** when creating a new multisample (i.e., selected a new multisample in "MS" 0-1a)
- If you executed the "**MS Mono To Stereo**" (0-1H) page menu command
- If you sampled with "**Sample Mode**" (0-1c) set to **Stereo**

In these cases, a stereo multisample will be created automatically using the following criteria.

1. The last two characters of the two multisample names will be -L and -R respectively, and the earlier portion of the names are identical.
2. The two multisamples will have the same number of indexes, and their zone settings are identical.

**Stereo samples:** Under the following condition, two samples will be handled as a stereo sample.

- When the samples were recorded with a "**Sample Mode**" (0-1c) setting of **Stereo**.
- If you executed the "**Sample Mono To Stereo**" (0-1I) page menu command

In these cases, a stereo multisample will be created automatically using the following criteria.

1. The last two characters of the sample name will be -L and -R respectively, and the earlier portion of the names are identical.
2. Two samples that satisfy condition 1. for stereo multisamples are selected.

▲ Stereo multisamples and samples are distinguished internally by their multisample name or sample name. If you use "Rename MS" (0-1F) or "Rename Sample" (0-1C) etc. to modify the multisample name or sample name, please pay attention to the above conditions.

▲ As a condition of a stereo sample, the sampling rates must be identical. You can verify the sampling rate of a sample by using the page menu command "Rate Convert" (1-1K). Be aware that if you use "Rate Convert" to convert the -L and -R samples to differing sampling rates, they will not be handled as a stereo sample.

## 0-1c: REC Sample Setup

Here you can select the memory bank into which you will sample, specify the sampling time, and select either mono or stereo sampling.

### Save to [RAM, DISK]

Specifies the destination to which the data will be written during sampling.

**RAM:** The sound will be sampled into sample memory (RAM).

A sample written into sample memory can be heard immediately in Sampling mode.

▲ Data written into sample memory (RAM) will be lost when the power is turned off, so you must save it if you want to keep it.

**DISK:** The sound will be sampled into the internal hard disk or into a hard disk (sold separately) connected to the SCSI connector.

Use the page menu command "Select Directory" (0-1N) to select the writing-destination drive and directory, and to specify the filename.

When you sample, a WAVE file will be created.

To hear the results of sampling, you can either load the file in Disk mode into sample memory (RAM), or use the page menu command "Select Directory" etc. to select the file, and then press the SAMPLING [START/STOP] key.

▲ A hard disk sample (WAVE file) as large as 16 Mbyte for mono or 32 Mbyte for stereo (if sample memory has been expanded to 32 Mbyte or more) can be loaded into sample memory (RAM).

▲ It is not possible to record a sample directly onto CD-R/RW. Nor do we recommend recording a sample directly onto a removable disk.

### Bank (RAM BANK) [RAM1...RAM6]

Specifies the RAM bank and sample number into which the data will be written during sampling. This can be specified if **RAM** is selected for "Save to."

Sample memory (RAM) consists of six banks, each with 16 Mbytes. The TRITON STUDIO comes with one 16 Mbyte of DRAM SIMM board. In this state, **RAM1** will always be selected for "**Bank (RAM Bank)**," and **RAM2, 3, 4, 5, and 6** cannot be selected.

By adding additional DRAM SIMM boards, you can expand the memory to a maximum of 96 Mbytes (when three 32 Mbyte SIMM boards are installed). (☞p.286)

#### How installed SIMM's relate to available banks

SIMM Slot No.	SIMM capacity	RAM Bank	Time
Slot 1	16 Mbyte	1	16 Mbyte: approximately 2 minutes 54 seconds (mono) approximately 1 minute 27 seconds (stereo)
	32 Mbyte	1, 2	
Slot 2	16 Mbyte	3	96 Mbyte: approximately 2 minutes 54 seconds (mono) x 6 total of approximately 17 minutes 28 seconds
	32 Mbyte	3, 4	
Slot 3	16 Mbyte	5	approximately 1 minute 27 seconds (stereo) x 6 total of approximately 8 minutes 44 seconds
	32 Mbyte	5, 6	

▲ The TRITON STUDIO is shipped with a 16 Mbyte SIMM installed in Slot 1. This allows you to select only **RAM1** for "**Bank (RAM Bank)**."

For example if Slot 1 contains the factory-installed 16 Mbyte SIMM, and you have installed a 32 Mbyte SIMM in Slot 2 and a 16 Mbyte SIMM in Slot 3, you will be able to select **RAM1** (16 Mbyte), **RAM3** (16 Mbyte), **RAM4** (16 Mbyte), and **RAM5** (16 Mbyte) for “**Bank (RAM)**.” Each bank is 16 Mbytes. (If a 32 Mbyte SIMM is installed in each Slot1, Slot2, and Slot3, all banks can be selected, and the total size will be 96 Mbytes.)

#### Sample Time [min sec]

Specifies the time that you wish to sample. This can be set in 0.001 second increments. This parameter indicates amount of remaining memory in the selected memory bank (the available sampling time). If you record a sample in this condition ([REC]→[START]→[STOP]), the change in time will be displayed automatically.

If you have sufficient memory, it is a good idea to set an ample “Sample Time,” and to use the “Truncate” (1-1A, 2-1A) page menu command after you sample to delete unwanted portions of the sample and reduce it to the minimum size necessary. You can also press the SAMPLING [START/STOP] key to stop recording after you have recorded the desired material (For details on the sampling procedure, refer to BG p.37, 102).

If the writing destination (“Save to”) is **RAM**, the maximum value will be calculated from the space remaining in the selected bank. If the writing destination (“Save to”) is **DISK**, the maximum value will be calculated from the space remaining in the disk specified by “Select Directory.” A maximum of 80 minutes can be sampled in one sample file for either mono or stereo (mono: approximately 440 Mbyte, stereo: approximately 879 Mbyte).

 If the writing destination is (“Save to”) is **RAM**, and “Auto Optimize RAM” (Global P0: 0-3b) is not **checked**, unused sample RAM will accumulate, decreasing the amount of available sample memory (RAM). If this occurs, execute the page menu command “Optimize RAM” (0-1M) to reclaim unused RAM.

The remaining amount of RAM can be checked in Sampling mode P0: Memory Status.

The remaining amount of memory will depend on the following conditions:

1. The amount of memory that is installed.
2. Whether the sample is stereo or mono. When the “**Sample Mode**” (0-1c) is set to **Stereo**, the memory capacity will be halved.
3. The time specified for “Pre Trigger REC” (0-2b: a function that automatically samples the sound even before you begin sampling) will be subtracted from the amount of memory that actually remains.

#### Sample Mode [L-Mono, R-Mono, Stereo]

Specifies the channel(s) that you want to sample, and specify whether a mono or stereo sample will be created.

The sound that is sent to the internal L and/or R bus or the internal Indiv. 1 and/or 2 bus you specify as the “**Source BUS**” (0-2b) will be sampled.

**L-Mono:** The sound of the internal **L** channel or internal **Indiv. 1** channel specified by “**Source BUS**” will be sampled in mono.

**R-Mono:** The sound of the internal **R** channel or internal **Indiv. 2** channel specified by “**Source BUS**” will be sampled in mono.

**Stereo:** The sound of the internal **L** and **R** channels or the internal **Indiv. 1** and **2** channels specified by “**Source BUS**” will be sampled in stereo. When you sample in stereo, a stereo multisample and samples will be created.

#### Example 1: Sampling a monaural source connected to AUDIO INPUT 1 without applying internal effects

“Input”	(0-2a)	<b>Analog</b>
<i>Input1</i> “Pan”	(0-2a)	<b>L000</b>
<i>Input1</i> “Level”	(0-2a)	<b>127</b>
<i>Input1</i> “BUS(IFX/indiv.)Select”	(0-2a)	<b>L/R</b>
“Source BUS”	(0-2b)	<b>L/R</b>
“Resample”	(0-2b)	<b>Manual</b>
“Recording Level [dB]”	(0-1d)	<b>The desired level</b>
“Sample Mode”	(0-1c)	<b>L-Mono</b>

#### Example 2: Stereo-sampling a monaural source connected to AUDIO INPUT 1 and processed by internal insert effect IFX1 052: Reverb Hall

“Input”	(0-2a)	<b>Analog</b>
<i>Input1</i> “Pan”	(0-2a)	<b>C064</b>
<i>Input1</i> “Level”	(0-2a)	<b>127</b>
<i>Input1</i> “BUS(IFX/indiv.)Select”	(0-2a)	<b>IFX1</b>
“Source BUS”	(0-2b)	<b>L/R</b>
“Resample”	(0-2b)	<b>Manual</b>
IFX1(P8)	Select and assign <b>052: Reverb Hall</b>	
“Recording Level [dB]”	(0-1d)	<b>The desired level</b>
“Sample Mode”	(0-1c)	<b>Stereo</b>

#### Example 3: Sampling a stereo source connected to AUDIO INPUT 1, 2 without applying internal effects

“Input”	(0-2a)	<b>Analog</b>
<i>Input1</i> “Pan”	(0-2a)	<b>L000</b>
<i>Input1</i> “Level”	(0-2a)	<b>127</b>
<i>Input1</i> “BUS(IFX/indiv.)Select”	(0-2a)	<b>L/R</b>
<i>Input2</i> “Pan”	(0-2a)	<b>R127</b>
<i>Input2</i> “Level”	(0-2a)	<b>127</b>
<i>Input2</i> “BUS(IFX/indiv.)Select”	(0-2a)	<b>L/R</b>
“Source BUS”	(0-2b)	<b>L/R</b>
“Resample”	(0-2b)	<b>Manual</b>
“Recording Level [dB]”	(0-1d)	<b>The desired level</b>
“Sample Mode”	(0-1c)	<b>Stereo</b>

#### Example 4: Stereo-sampling a stereo source connected to AUDIO INPUT 1, 2 and processed by internal insert effect IFX1 008: St.Graphic 7EQ

“Input”	(0-2a)	<b>Analog</b>
<i>Input1</i> “Pan”	(0-2a)	<b>L000</b>
<i>Input1</i> “Level”	(0-2a)	<b>127</b>
<i>Input1</i> “BUS(IFX/indiv.)Select”	(0-2a)	<b>IFX1</b>
<i>Input2</i> “Pan”	(0-2a)	<b>R127</b>
<i>Input2</i> “Level”	(0-2a)	<b>127</b>
<i>Input2</i> “BUS(IFX/indiv.)Select”	(0-2a)	<b>IFX1</b>
“Source BUS”	(0-2b)	<b>L/R</b>
“Resample”	(0-2b)	<b>Manual</b>
IFX1(P8)	Select and assign <b>008: St.Graphic 7EQ</b>	
“Recording Level [dB]”	(0-1d)	<b>The desired level</b>
“Sample Mode”	(0-1c)	<b>Stereo</b>

 If you want to sample a digital source connected to S/P DIF IN or to the EXB-mLAN option, set “**Input**” (0-2a) to **S/P DIF** or **mLAN**. If **S/P DIF** is selected, make settings for the L channel in *Input1*, and settings for the R channel in *Input2*.

 When stereo sampling ends, you may hear noise in the audio output, but this does not affect the sound that was sampled.

 For details on settings for resampling, refer to “Resample” (0-2b).

## 0-1d: Recording Level [dB]

**Recording Level** [-inf, -72.0... 0.0...+18.0]

This adjusts the signal level at the final stage of sampling. When you sample, make sure that the level is as high as possible without allowing the level meter to indicate "CLIP!!." This setting can also be made in the P0-2: Input/Setup page. When you press the **SAMPLING [REC]** key you will enter sampling standby mode. Use the slider to adjust the signal level.

Initially set this to **0.0**, and make adjustments so that the level is as high as possible without exceeding 0 dB in the bar display. If 0 dB is exceeded, the display will indicate "CLIP!!" This means that the level of the sampling signal is too high, so use the slider to adjust the level.

**note** In order to sample with the widest possible dynamic range when sampling from the AUDIO INPUT 1,2 jacks, adjust the rear panel [LEVEL] knob to the maximum level that does not cause "ADC OVERLOAD !!" (0-2b) to appear. Then set "Level" (0-2a) to **127**, and adjust "Recording Level" (0-1d, 0-2c) to the maximum level that does not cause "CLIP!!" to appear.

Adjusting "Recording Level" will not affect the sound that is output, but will affect the data that is sampled. For this reason, it is possible that distortion can be heard in the sampled sound even though you did not hear distortion while sampling.

If the sound is still distorted even if you lower the "Recording Level," when analog signal is input, it is possible that distortion is occurring in the input stage of the AUDIO INPUT, or that distortion is being caused by the settings of the internal effect. Excessive signal levels in the input stage of the AUDIO INPUT can be verified in the P0: Input Setup page. If an indication of "ADC OVERLOAD !!" appears above the "Recording Level" bar display, the distortion is due to excessive levels in the input stage of the AUDIO INPUT. Adjust the rear panel [LEVEL] knob until the "ADC OVERLOAD !!" display no longer appears. If there is still distortion even after [LEVEL] knob has been lowered, it is possible that the distortion is being caused by the settings of the internal effect. Lower the "(Input 1, 2) Level" (0-2a), or adjust the effect settings.

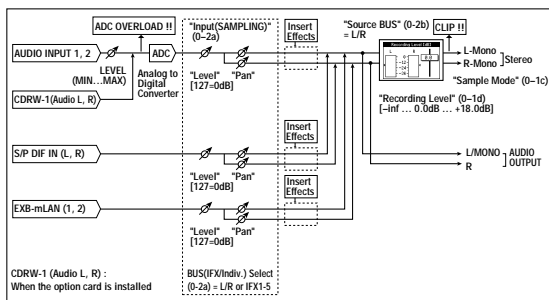

**note** If you have sampled at a low input level, you can execute **Normalize** in "Normalize/Level Adj." (1-1I) to amplify the level to the maximum possible without clipping.

## ▼ 0-1: Page Menu Command

0-1A	Delete Sample	MS Mono To Stereo	0-1H
0-1B	Copy Sample	Sample Mono To Stereo	0-1I
0-1C	Rename Sample	Keyboard Display	0-1J
0-1D	Delete MS	Move Sample	0-1K
0-1E	Copy MS	Move MS	0-1L
0-1F	Rename MS	Optimize RAM	0-1M
0-1G	Convert MS To Program	Select Directory	0-1N

## 0-1A: Delete Sample

This command deletes all samples, the currently selected sample, or unused samples (samples not mapped to a multisample).

① Select "**Delete Sample**" to access the dialog box.

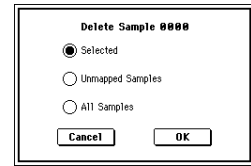

② Use the radio buttons to specify which samples will be deleted.

**Selected:** The currently selected sample will be deleted. The sample assignment for "Index" (0-1a) will change to **--No Assign--**.

**Unmapped Samples:** All samples that are not mapped (used) in a multisample or drum kit will be deleted.

**All Samples:** All samples in memory will be deleted. The sample assignments of all multisamples will change to **--No Assign--**.

③ To execute the Delete Sample command, press the **OK** button. To cancel, press the **Cancel** button.

If the sample data (waveform data) of the sample you delete is being used by another sample, the sample data itself will not be deleted. Only the sample will be deleted.

## 0-1B: Copy Sample

This command copies the currently selected sample to another sample.

**note** The copy destination sample number will automatically be included in the resulting sample name. If necessary, use "Rename Sample" (0-1C) to rename it. When doing so, make sure that the name is not identical to any other sample name. (The sample name is used to distinguish stereo samples. ¶p.90)

① Use "Sample Select" (0-1b) to select the copy-source sample.

② Select "**Copy Sample**" to access the dialog box.

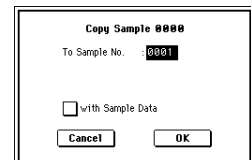

③ Specify the sample number of the copy destination.

**[Stereo]** When copying a stereo sample, specify both the L and R channels for the copy destination sample number.

④ If you check "**with Sample Data**": Executing the copy will simultaneously copy the sample data (waveform data) as well. The copy source and copy destination samples will exist as completely independent samples. For example, you would use this when you wish to start with the same sample data, and edit it separately in P1: Sample Edit to create two or more different types of sample. If you do **not** check "**with Sample Data**": Executing the copy will not copy the sample data (waveform data). The newly created sample will share the sample data of the copy source sample. For example, you would use this when you wish to use P2: Loop Edit to create two or more versions of the same sample data with different loop addresses. Sample memory area will not be consumed by this type of copy. If you use P1: Sample Edit to edit the sample data, the results will affect all samples that share this sample data.

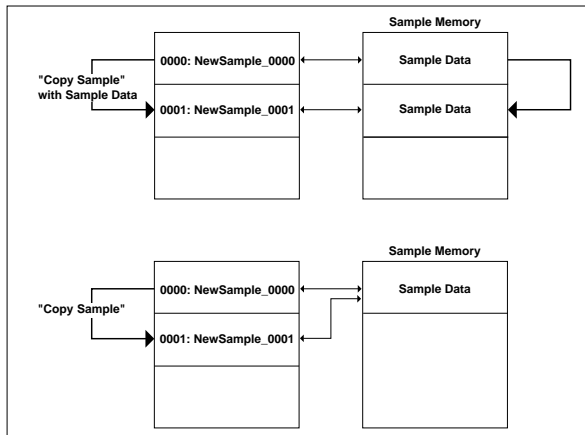

⑤ To execute the Copy Sample command, press the **OK button**. To cancel, press the **Cancel button**.

### 0-1C: Rename Sample

This command lets you modify the name of the currently selected sample.

- ① Use "Sample Select" (0-1b) to select the sample whose name you want to edit.
- ② Select "**Rename Sample**" to access the dialog box.

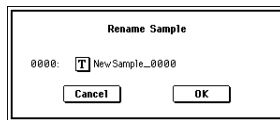

- ③ Press the text edit button to open the text edit dialog box, and input the desired sample name (up to sixteen characters).  
**[Stereo]** If the multisample is stereo and a stereo sample is selected, you can input up to fourteen characters for the sample name. This is because the last two characters are reserved for -L and -R. If you rename up to fourteen characters of the sample of either the L or the R channel, the other sample will automatically be renamed.
- ④ To execute the Rename Sample command, press the **OK button**. To cancel, press the **Cancel button**.

### 0-1D: Delete MS (Delete Multisample)

This command deletes the currently selected multisample or all multisamples.

- ① Use "MS (Multisample Select)" (0-1a) to select the multisample that you want to delete.
- ② Select "**Delete MS**" to access the dialog box.

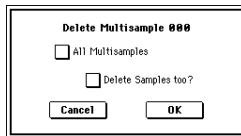

- ③ **All Multisamples:** Check this if you wish to delete all multisamples.
- ④ **Delete Samples too?:** Check this if you also wish to delete the samples included in the deleted multisample(s). However, samples that are mapped to (used by) other multisamples or drum kits will not be deleted.
- ⑤ To execute the Delete Multisample command, press the **OK button**. To cancel, press the **Cancel button**.

**⚠** Even if you also choose to delete the samples that are included in the deleted multisample(s), any sample data (waveform data) used by these samples that is shared with other samples will not be deleted. Only the sample itself will be deleted.

### 0-1E: Copy MS (Copy Multisample)

This command copies the selected multisample to another multisample.

**note** The copy destination multisample number will automatically be included in the resulting multisample name. If necessary, use "Rename MS" (0-1F) to rename it. When doing so, make sure that the name is not identical to any other multisample name. (The multisample name is used to distinguish stereo multisamples. see p.90)

- ① Use "MS (Multisample Select)" (0-1a) to select the copy-source multisample.
- ② Select "**Copy MS**" to access the dialog box.



- ③ Specify the copy destination multisample number.  
**[Stereo]** When copying a stereo multisample, copy both the L and R channels of the copy destination multisample number.
- ④ To execute the Copy Multisample command, press the **OK button**. To cancel, press the **Cancel button**.  
 When a multisample is copied, the samples assigned to the multisample will also be copied at the same time. At this time, they will be automatically copied to vacant sample numbers. The sample data (waveform data) will be shared between the copy source and copy destination. (Additional sample memory area will not be consumed.)

### 0-1F: Rename MS (Rename Multisample)

This command modifies the name of the currently selected multisample.

- ① Use "MS (Multisample Select)" (0-1a) to select the multisample whose name you want to edit.
- ② Select "**Rename MS**" to access the dialog box.

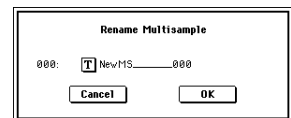

- ③ Press the text edit button to move to the text edit dialog box, and input a multisample name of up to sixteen characters.  
**[Stereo]** If the selected multisample is **stereo**, up to fourteen characters can be input as the multisample name. This is because the last two characters are reserved for -L and -R. If you rename up to fourteen characters of the multisample of either the L or the R channel, the other multisample name will automatically be renamed.
- ④ To execute the Rename Multisample command, press the **OK button**. To cancel, press the **Cancel button**.

### 0-1G: Convert MS To Program (Convert Multisample To Program)

This command converts the selected multisample into a program.

If you have recorded a sample or created a multisample and would like to play it in Program mode, Combination mode, or Sequencer mode, you must create a program that uses that multisample for its oscillator.

It is possible to set the Program mode OSC1 and OSC2 parameters "High MS Bank," "Low MS Bank" (Program P1: 1-2a) to select a RAM bank, so that a multisample that you created in Sampling mode can be used in the program, and then to make program settings to specify how the multisample will be sounded.



However by executing the “Convert MS To Program” command, you can quickly and easily convert the Sampling mode settings into a new program, without having to make any Program mode settings as described above.

- ① Use “MS (Multisample Select)” (0–1a) to select the multisample that you want to convert to a program.
- ② Select “Convert MS To Program” to access the dialog box.

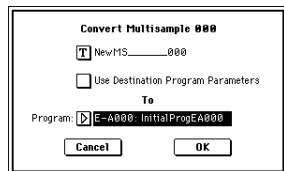

- ③ Press the text edit button to access the text edit dialog box, and input a multisample name of up to sixteen characters. By default, the multisample name will be specified automatically.
- ④ If “Use Destination Program Parameters” is unchecked: Executing the command will replace the multisample of the convert destination program with the multisample selected here, and will initialize the remaining program parameters. The sound that you hear in Sampling mode will be accurately reproduced by the program. A mono multisample will be converted into a program with an “Oscillator Mode” (Program P1: 1–1a) of **Single**, and a stereo multisample will be converted into a **Double** program. If “Use Destination Program Parameters” is checked: Executing this command will replace the multisample of the convert destination program with the multisample selected here, and will not initialize the remaining program parameters. Use this setting if you wish to use the parameter settings of an existing preset program, etc.

⚠ If you check “Use Destination Program Parameters,” be aware of the following points.

- If the selected multisample is mono, the “Oscillator Mode” of the convert destination program must be **Single**. Conversely, if the selected multisample is stereo, the “Oscillator Mode” of the convert destination program must be **Double**. If you attempt to execute this command when these conditions are not satisfied, a message will indicate “Oscillator Mode conflicts.” You will need to change the “Oscillator Mode” setting of the convert destination program.
  - **[Stereo]** If the selected multisample is stereo, the stereo position of the multisample in Sampling mode can be reproduced by setting the convert destination program to the following pan settings: “Amp 1 Pan” **L000**, and “Amp 2 Pan” **R127** (Program P4: Amp 1 Lvl/Pan page and Amp 2 Lvl/Pan page).
- ⑤ In **To “Program,”** select the convert destination program. When the edit cell is selected, you can use the numeric keys [0]–[9], the [VALUE] dial, the [VALUE] slider, and [△] [▽] keys to make a selection. When you press the popup button, the Bank/Program Select menu will appear. Here you can select a program by bank.

⚠ It is recommended that you use **bank INT-E** as the program bank for Sampling mode.

- ⑥ To execute the Convert Multisample To Program command, press the **OK button**. To cancel, press the **Cancel button**.

## 0–1H: MS Mono To Stereo/MS Stereo To Mono (Change Multisample Type)

This command converts a mono multisample to stereo, or a stereo multisample to mono. If the selected multisample is mono, the dialog box will allow you to execute “MS Mono To Stereo.” If the selected multisample is stereo, the dialog box will allow you to execute “MS Stereo To Mono.”

- ① Use “MS (Multisample Select)” (0–1a) to select the multisample that you want to change to stereo or mono.
- ② Choose either “MS Mono To Stereo” or “MS Stereo To Mono” to access the dialog box.

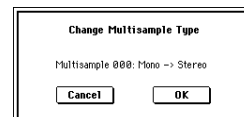

- ③ To execute the Change Multisample Type command, press the **OK button**. To cancel, press the **Cancel button**. When you execute this command, the multisample type and sample assignment will change as follows.

### MS Mono To Stereo

- The selected multisample will be converted to stereo. The last two characters of the multisample name will be overwritten as **-L**.
- An identical multisample will be newly created, but with the last two characters of the multisample name overwritten as **-R**.
- Mono samples assigned to the original multisample will be assigned to both **-L** and **-R** multisamples.
- If samples assigned to the original multisample are part of a stereo pair of samples, the **-L** and **-R** samples will be assigned to the **-L** and **-R** multisamples.

### **[Stereo]**: MS Stereo To Mono

- The selected multisample will be converted to mono. The **-L** or **-R** at the end of the multisample name will be deleted.
- Multisamples that are stereo pairs of the selected multisample will be deleted.

## 0–1I: Sample Mono To Stereo (Change Sample Type)

This command converts a mono sample to stereo. This can be executed when a mono sample is selected.

- ① Use “Sample Select” (0–1b) to select the sample that you want to change to stereo.
- ② Select “Sample Mono To Stereo” to access the dialog box.

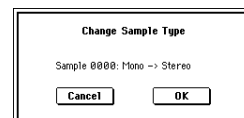

- ③ To execute the Change Sample Type command, press the **OK button**. To cancel, press the **Cancel button**. When you execute this command, the sample type will change as follows.
  - The selected sample will become a stereo sample. “**-L**” will be overwritten into the last two characters of the sample name.
  - An identically named sample will be created with “**-R**” as the last two characters of the sample name. Also, if the selected multisample is mono, it will change to stereo.
  - The last two characters of the multisample name will be overwritten as “**-L**”.
  - A new multisample will be created with the same name, but whose last two characters are “**-R**”.

- The stereo sample that was created will be assigned automatically.

### 0-1J: Keyboard Display

This command selects the range of the keyboard display. Normally you will select **88Key Normal (A0-C8)**.

- ① Select “**Keyboard Display**” to access the dialog box.

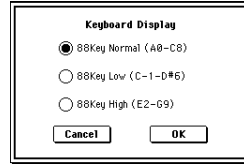

- ② Use the **radio buttons** to select the displayed range.
- ③ To execute the Keyboard Display command, press the **OK button**. To cancel, press the **Cancel button**.

### 0-1K: Move Sample

This command lets you move the currently selected sample to the specified number (i.e., to change the sample number), or to rearrange the sample numbers so that they start from 0000 after samples have become discontinuous as a result of creating or editing. (See Following illustration)

When you reassign the sample numbers, the sample numbers within the multisamples and drum kits that use these sample will also be automatically reassigned. (This means that the samples of the multisamples and drum kits need not be reassigned following this operation.)

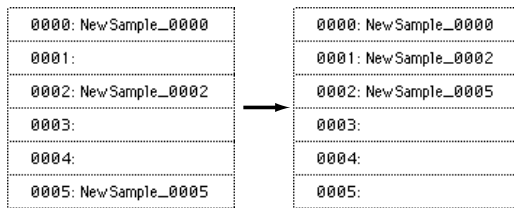

- ① Use “**Sample Select**” (0-1b) to select the copy source sample.
- ② Select “**Move Sample**” to access the dialog box.



- ③ Use **To “Sample”** to specify the move destination sample number.

**[Stereo]** When moving a stereo sample, you must move the samples individually.

If you wish to reassign (pack) all sample numbers starting at 0000, check “**Optimize Empty Sample No.**”

- ④ If “**Adjust Sample Assign in Drum Kit**” is checked, and if the samples being moved are mapped to (used by) a drum kit, those sample numbers will also be automatically modified. Normally you will leave this checked.

Samples mapped to (used by) multisamples will be automatically changed to the new sample numbers regardless of this setting.

- ⑤ To execute the Move Sample operation, press the **OK button**. To cancel without executing, press the **Cancel button**.

### Example)

If data already exists at the move destination sample number, the sample will not be overwritten; instead, all subsequent samples will be renumbered upward.

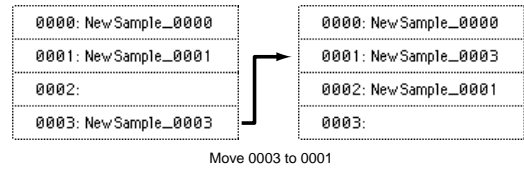

### Example)

If there is no empty sample number and forward movement is not possible, samples will be renumbered downward.

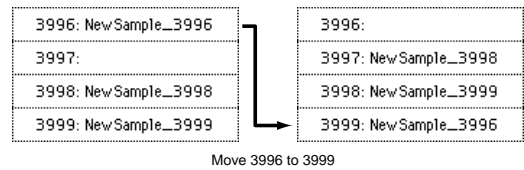

### 0-1L: Move MS (Move Multisample)

This command lets you move the currently selected multi-sample to the specified number (i.e., to change the multi-sample number), or to rearrange the multisample numbers so that they start from 000 after multisamples have become discontinuous as a result of creating or editing. (See Following illustration)

When you reassign the multisample numbers, the multisample numbers within the programs that use these multisamples will also be automatically reassigned. (This means that you do not need to reselect the multisamples in Program mode following this operation.)

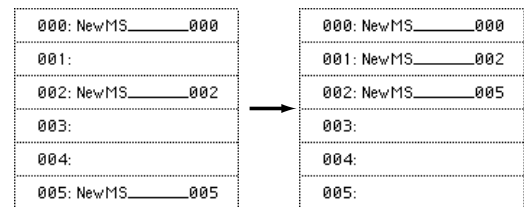

- ① Use “**MS (Multisample Select)**” (0-1a) to select the multi-sample that you wish to move.
- ② Select “**Move MS**” to access the dialog box.

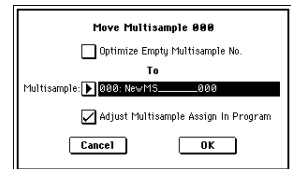

- ③ In **To “Multisample,”** specify the move destination multi-sample number.

**[Stereo]** When moving a stereo multisample, you will need to move each part separately.

If you wish to rearrange all multisamples consecutively, check “**Optimize Empty Multisample No.**”

- ④ If “**Adjust Multisample Assign in Program**” is checked and if the multisamples being moved are used in programs, the multisample numbers of the programs will also be reassigned automatically. Normally you will leave this checked.
- ⑤ To execute the Move Multisample command, click the **OK button**. If you decide not to execute, click the **Cancel button**.

**Example)**

If data already exists at the move destination multisample number, the multisample will not be overwritten; instead, all subsequent multisamples will be renumbered upward.

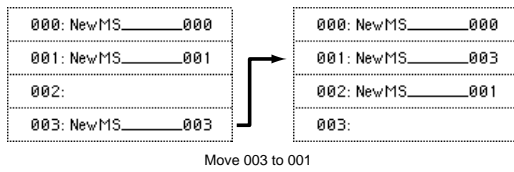

**Example)**

If there is no empty multisample number and forward movement is not possible, multisamples will be renumbered downward.

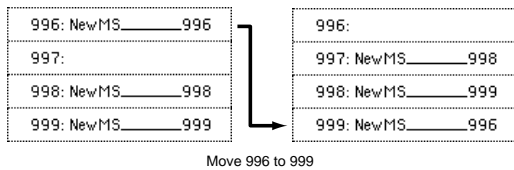

**0-1M: Optimize RAM**

This command optimizes the sample memory (RAM). When you execute the optimize command, any memory areas containing unused data will be rearranged, allowing you to utilize all of the remaining memory. If you run out of memory, try executing "Optimize RAM." The remaining amount of RAM can be checked in P0: Memory Status.

- ① Select "Optimize RAM" to access the dialog box.

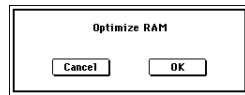

- ② Press the **OK** button to execute the optimize command, or press the **Cancel** button to cancel without executing.

**note** If "Auto Optimize RAM" (Global P0: 0-3b) is checked, RAM will be optimized automatically.

**0-1N: Select Directory**

This command lets you specify the save-destination disk (hard disk), directory, and filename for the WAVE file that will be created by sampling. You can also use this "Select Directory" command to listen to audio from a WAVE file that was saved to disk. The "Select Directory" command is available when "Save to" is set to **DISK**.

Specifying the save-destination for a WAVE file

- ① Select "Save Directory" to access the dialog box.

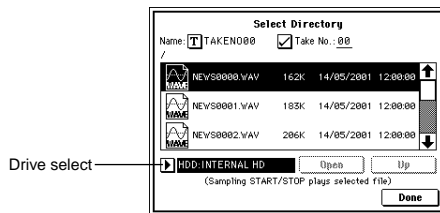

- ② Use "Drive select" to select the drive into which the data will be written during sampling.
- ③ Use the **Open** button and **Up** button to move between directories.
- ④ In the "Name" field, specify a name for the WAVE file that will be written during sampling.

If you check "Take No.," a two digit "take number" will be added at the end of the filename when it is saved. The number will automatically increment each time you sample. When sampling repeatedly, this is convenient since it allows each file to be saved with a different filename.

If "Take No." is not checked, up to eight character can be entered in the "Name" field. If "Take No." is checked, up to six characters can be entered.

- ⑤ Press the **Done** button to complete the settings.

**Playing back a WAVE file**

- ① Select "Select Directory" to access the dialog box.
- ② Use "Drive select," the **Open** button, and the **Up** button to select the drive and directory, and select the WAVE file (44.1 kHz or 48 kHz) that you want to play.
- ③ Press the SAMPLING [START/STOP] key. The selected WAVE file will play.
- ④ Press the SAMPLING [START/STOP] key once again to stop.

⚠ If the WAVE file is mono, the same sound will be output to L and R.

⚠ While a WAVE file is playing back, the TRITON STUDIO will not produce sound in response to your keyboard playing or to note data received at MIDI IN. Also, the arpeggiator will stop.

**0-2: Input/Setup**

Here you can select the input source for analog/digital audio signals, and specify the input level, bus, and the send levels to the master effects. You can also set-up for recording.

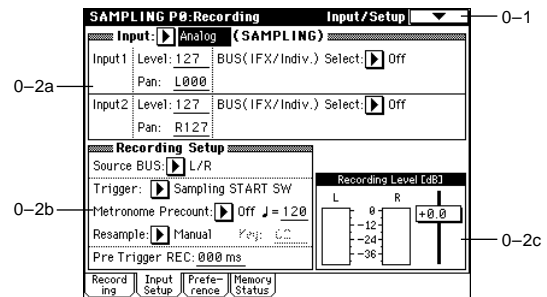

**0-2a: Input (SAMPLING)**

⚠ The settings you make here are valid only in Sampling mode. These settings will also be valid when you move from Sampling mode to Global mode.

External audio input settings for the TRITON STUDIO outside of Sampling mode are made in "Input (COMBI, PROG, SEQ, S.PLAY, DISK)" (Global P0: 0-3a).

**Input [Analog, S/P DIF, mLAN]**

Specifies the external audio source for input to the TRITON STUDIO.

**note** Analog, S/P DIF, and mLAN each have their own independent settings. After setting this "Input" parameter to select one of these sources, make settings for the various Input1 and Input2 parameters. Multiple external audio input sources can be input simultaneously.

**Analog:** The analog audio output from a device connected to the AUDIO INPUT 1 and AUDIO INPUT 2 jacks can be input to the TRITON STUDIO.

If the CDRW-1 option is installed, you can use P5: Audio CD to play back an audio CD. In this case as well, the audio will be input to the TRITON STUDIO as specified by the settings you make here. The L channel corresponds to Input 1, and the R channel corresponds to Input 2.

**S/P DIF:** The digital audio output from an instrument or DAT etc. connected to the S/P DIF IN jack can be input to the TRITON STUDIO. The L channel of the S/P DIF input will be input as specified by the *Input1* setting below, and the R channel as specified by the *Input2* setting.

Sample rates of 48 kHz and 96 kHz are supported for S/P DIF input and output. This is specified by “**S/P DIF Sample Rate**” (Global P0: 0–2a). 96 kHz sample rate data will be converted to 48 kHz when it is sampled.

**mLAN:** The digital audio output of an instrument or other device connected to the mLAN connector (when the EXB-mLAN option is installed) can be input to the TRITON STUDIO.

In the Global mode P0: mLAN Input page you must specify the audio source that will be input. (☞ Global P0: 0–5)

 In order to select mLAN, the **EXB-mLAN** option must be installed, and you must set “**System Clock**” (Global P0: 0–2a) to **mLAN**.

#### **Input1:**

#### **Input2:**

**Level** [0...127]

Specifies the level of the external audio signal that will be input (selected by “**Input**” 0–2a). Normally you will set this at 127.

**note** The analog audio signals from the AUDIO INPUT 1, 2 jacks and from the CDRW-1 option are converted by a AD converter from analog to digital signals. This parameter sets the level of the signal immediately after it has been converted into digital form. If the sound is distorted even though this level setting is very low, it is possible that the sound is distorting earlier than the AD converter. Try adjusting the [LEVEL] knob or the output level of the external audio source.

**Pan** [L000...C064...R127]

Specifies the panning of the external audio signal being input (specified by “**Input**”). When inputting a stereo audio source, you will normally set *Input1* to **L000** and *Input2* to **R127**. (For example settings, ☞ p.91, BG p.37, 102)

#### **BUS (IFX/Indiv.) Select**

[L/R, IFX1...5, 1...4, 1/2, 3/4, Off]

Specifies the bus to which the external audio signal will be sent.

**L/R:** The external audio signal will be sent to the L/R bus. Normally you will select **L/R**.

**IFX1...5:** The external audio signal will be sent to the corresponding IFX1–5 bus. Select this when you want to apply an insert effect while sampling. (“2–3. Sampling mode” ☞ p.180)

**1...4, 1/2, 3/4:** The external audio signal will be sent to the corresponding bus(s) 1–4. (“2–3. Sampling mode” ☞ p.180)

**Off:** The external audio signal will not be input.

### **0–2b: Recording Setup**

**Source BUS** [L/R, Indiv.1/2]

Selects the source that you want to sample. The sound being sent to this bus will be sampled.

**L/R:** The sound being sent to the **L/R** bus will be sampled. The external audio signal(s) (specified by “**Input**” 0–2a) sent

to the **L/R** bus, and the sound played by the TRITON STUDIO from its keyboard or from MIDI input etc. and sent to the **L/R** bus, will be sampled. You will also use the **L/R** setting when sampling a sound processed by an insert effect.

**Indiv.1/2:** The sound being sent to the **INDIVIDUAL 1, 2**, or **1/2** buses will be sampled.

The external audio signal(s) (specified by “**Input**” 0–2a) sent to the **1, 2**, or **1/2** buses, and the sound played by the TRITON STUDIO from its keyboard or from MIDI input etc. and sent to the **INDIVIDUAL 1, 2**, or **1/2** buses, will be sampled.

**Trigger** [Sampling START SW, Note On, Threshold]

Specifies how sampling will be initiated.

**Sampling START SW:** Pressing the SAMPLING [REC] key will cause the TRITON STUDIO to enter sampling-standby mode, and sampling will begin when you press the SAMPLING [START/STOP] key.

- ① Press the SAMPLING [REC] key to enter sampling-standby mode.
- ② Use the “Recording Level [dB]” slider to adjust the sampling level.
- ③ Sampling will begin when you press the SAMPLING [START/STOP] key. (If you are using the “Metronome Precount” function, pressing the SAMPLING [START/STOP] key will cause sampling to begin after the metronome sounds a count-down. If *Metronome Setup* “**BUS (Output) Select**” (0–3c) is set to **L/R**, the metronome will stop sounding at the moment that sampling begins.
- ④ To stop sampling, press the [START/STOP] key once again. Sampling will also stop automatically if it continues to the specified “Sample Time” (0–1c).

If you want to apply an effect etc. to an existing sample and automatically create a new sample (Resampling), set “**Trigger**” to **Sampling START SW**, and set “**Resample**” (0–2b) to **Auto**. (☞ “Resample” Auto)

**Note On:** Sampling will begin when you play the keyboard after having pressing the SAMPLING [REC] key and then the SAMPLING [START/STOP] key.

**MIDI** Sampling will also begin if a MIDI note-on is received (instead of playing the keyboard).

- ① Perform steps ① and ②, above.
- ② Press the SAMPLING [START/STOP] key.
- ③ When you play the keyboard or when a MIDI note-on is received, sampling will start automatically.
- ④ To stop sampling, perform step ④, above.

**Threshold:** Sampling will begin automatically when the input level exceeds the specified “Level.”

- ① Press the SAMPLING [REC] key to enter sampling-standby mode.
- ② Use the “Recording Level [dB]” slider to adjust the sampling level.
-  Be careful of the change in the monitoring volume. (“Recording Level [dB]” 0–1d)
- ③ Adjust the “Level” setting. The black triangles at both sides of the “Recording Level [dB]” level bar display will indicate the “Level” value. Normally you will set this to a low a level as possible without allowing sampling to be triggered by noise.
- ④ Press the SAMPLING [START/STOP] key. When the input level exceeds the “Level” you specified, sampling will begin automatically.
- ⑤ To stop sampling, press the [START/STOP] key once again. Alternatively, sampling will end automatically if it continues to the time specified for “Sample Time” (0–1c).

## Metronome Precount [Off, 4, 8, 3, 6]

Specifies whether the metronome will sound a countdown when you use “Trigger” Sampling START SW to begin sampling.

This can be set only if “Trigger” is set to Sampling START SW.

**Off:** Sampling will begin immediately when you press the SAMPLING [START/STOP] key from recording-standby mode.

**4, 8, 3, 6:** When you press the SAMPLING [START/STOP] key from recording-standby mode, the metronome will count the specified number of beats at the “↓ (Tempo)” tempo, and then sampling will begin. If you set this to 4, sampling will begin on the count of 0 after a pre-count of 4-3-2-1-0.

**note** The output destination and level of the metronome sound are specified by *Metronome Setup* (0-3c).

## Resample [Manual, Auto]

Specifies how resampling will occur.

This can be set only if “Trigger” is set to Sampling START SW.

The process of sampling a sample (or samples) is called “resampling.”

You can apply effects to a sample and then resample it, or resample a performance of samples that you play.

**Manual:** This is the normal method. Use this when you want to sample an external input sound. If a sample is already assigned, the sample assigned for playing from the keyboard will be resampled together with the external input sound.

**Auto:** The sample assigned to the index will be resampled automatically. Use this when you want to apply an effect to an existing sample and resample the results.

① Set “Key” to the keyboard location where the sample you that you want to resample is assigned.

⚠ Sampling will not be possible if you specify a key to which a sample has not been assigned.

② If you want to apply an effect, go to the P8: Routing page and set “BUS (IFX) Select” (8-1b) to IFX1-5 to specify the insert effect that you want to use. Then set “Source BUS” (0-2b) to L/R.

③ Press the SAMPLING [REC] key to enter record-ready mode.

④ When you press the SAMPLING [START/STOP] key, the current sample will play back automatically, and the resampling will begin. If you play the keyboard at this time, the sound you play will be resampled together with the source sample.

⑤ When the sample assigned to the “Key” has played back for its full length, resampling will end automatically. Alternatively, you can stop resampling by pressing the SAMPLING [START/STOP] key once again.

**note** When resampling ends, the “BUS (IFX) Select” (8-1b) setting will automatically be reset to L/R. Please be aware of this if you want to resample once again. The parameters of the newly created sample will be automatically set the same as the source sample when played back.

## Key [C-1...G9]

When “Resample” is set to **Auto**, this specifies the note to which the sample to be resampled is assigned.

This can be set only if “Trigger” is set to Sampling START SW.

(☞) For the resampling procedure, refer to “Resample Auto.”

## Level [-63dB ... 0dB]

When sampling with “Trigger” set to **Threshold**, this specifies the level at which sampling will begin. This can be set only when “Trigger” is set to Threshold. (☞) Refer to step ③ of the “Trigger” Threshold procedure.)

## ↓ (Tempo) [040...240]

This sets the tempo of the count-down when “Metronome Precount” is used.

The tempo specified here will also be used when the LFO or delay time of the insert effect is controlled by the BPM/MIDI SYNC function during sampling (☞ p.248). This can also be set by the [TEMPO] knob.

## Pre Trigger REC [000...500ms]

If you want a portion of sound immediately before the start of sampling to be included in the recorded sample, set this parameter to specify the length.

When sampling with “Trigger” Threshold, sampling will start when the input signal exceeds the “Level” threshold level. However if the “Level” setting causes a portion of the attack to be lost, you can set the “Pre Trigger REC” parameter to capture the early attack as well.

When sampling with “Trigger” Sampling START SW, it is best to use “Metronome Precount” so that the instrumental performance etc. is sampled in tempo. If the performance is ahead of the tempo, this Pre Trigger REC parameter lets you sample without losing any of it.

⚠ If you increase this setting, you will always be sampling an unneeded portion ahead of the desired sample. Normally you should set this to **000 ms**, and specify the minimum required length when necessary.

## ADC OVERLOAD !!

The “ADC OVERLOAD !!” indication will appear if the signal level from AUDIO INPUT 1 and 2 exceeds the maximum level. If this occurs, adjust the [LEVEL] knob or the output level of the external sound source (☞ “Recording Level [dB]” 0-1d).

## 0-2c: Recording Level [dB]

Recording Level [dB] [-inf, -72.0... 0.0...+18.0]

☞ 0-1d

## 0-3: Preference

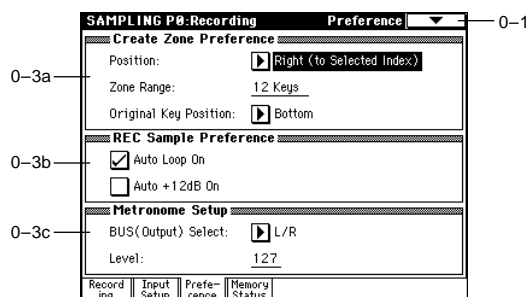

### 0-3a: Create Zone Preference

These settings define the initial state of the indexes that are created when you press the **Create** button (0-1b, 3-1c). Each new index will be created according to the settings you make here, but you are free to modify the settings later.

#### Position

[Right (to Selected Index), Left (to Selected Index)]

Specifies whether the new index will be created at the right or left of the selected index.

**Right (to Selected Index):** The new index will be created at the right of the currently selected index.

**Left (to Selected Index):** The new index will be created at the left of the currently selected index.

#### Zone Range [1 Key... 127 Keys]

Specifies the key range of the newly created index.

**1Key:** Each individual note of the keyboard will be an index. The sample of an index will sound at its original key when you play that note. This setting can be used similarly to pad (keyboard) type samplers.

**2 Keys-127 Keys:** The sample will change pitch in semitone steps across the specified number of keys, centered on the original key "OrigKey" (0-1b, 3-1b). If "**Constant Pitch**" (3-1b) is **checked**, the pitch will not change.

#### Original Key Position [Bottom, Center, Top]

Specifies where the original key will be located in the zone (specified by "Zone Range") for a newly created index.

**Bottom:** The lowest key in the zone will be the original key.

**Center:** The middle key in the zone will be the original key.

**Top:** The top key in the zone will be the original key.

### 0-3b: REC Sample Preference

#### Auto Loop On [Off, On]

**On (checked):** The recorded sample will automatically be played with looping turned on (☞ "Loop" (2-1c)).

#### Auto +12 dB On [Off, On]

This setting is used when you sample into sample memory (RAM) with "**Save to**" (0-1c) set to **RAM**. This setting is not used if "Save to" is set to **DISK**.

**On (checked):** The "+12 dB" (2-1c) setting will automatically be turned **on** for the samples you record. Samples for which "+12 dB" is on will play approximately +12 dB louder than if the "+12 dB" setting was off.

🔊 When you rip audio from an audio CD in the P5: Audio CD page, "+12 dB" will be turned off even if "Auto +12 dB On" is turned on.

You will normally turn this **off (unchecked)** when you sample an external audio source in Sampling mode, or apply insert effects to a sample and resample it. (In Sampling mode, the power-on default for this setting is Off.)

When you are sampling more than one external audio source, or an audio source mixed with your keyboard performance, set "Recording Level" to approximately -12.0 (dB) so that the recording level will be the optimum level that does not cause clipping. This will allow the sampled data to be recorded at the ideal level, but the playback level will be lower than it was during sampling. In such cases you can check "Auto +12 dB On" when you resample, so that "+12 dB" (2-1c) will be turned on, causing the playback level to be the same as the level during sampling.

**note** The "Auto +12 dB On" setting is set separately for each mode: Program, Combination, Sequencer, and Sampling.

### 0-3c: Metronome Setup

#### BUS(Output) Select [L/R, 1, 2, 3, 4]

Specifies the output destination of the metronome sound played by "Metronome Precount" (0-2b).

**L/R:** The metronome will be output from OUTPUT (MAIN) L/Mono, R, and the headphones.

**1, 2, 3, 4:** The metronome will be output from OUTPUT (INDIVIDUAL) 1, 2, 3, or 4 respectively.

#### Level [000...127]

Specifies the level of the metronome sound played by "Metronome Precount"

### 0-4: Memory Status

Free Sample Memory			
RAM Bank 1 :	174.7 sec	(15,384K byte)	100% free
RAM Bank 2 :	000.0 sec	(00,000K byte)	000% free
RAM Bank 3 :	000.0 sec	(00,000K byte)	000% free
RAM Bank 4 :	000.0 sec	(00,000K byte)	000% free
RAM Bank 5 :	000.0 sec	(00,000K byte)	000% free
RAM Bank 6 :	000.0 sec	(00,000K byte)	000% free

Free Number			
Multisample(MS) :	0999 / 1000	099% free	
Sample :	3999 / 4000	099% free	
Sample in MS :	3993 / 4000	099% free	

#### 0-4a: Free Sample Memory

This shows the remaining amount of memory (the time available for sampling, the size of the sample files that can be loaded in Disk mode, or the size available for editing) in RAM banks 1-6. The amount is shown in seconds, bytes, and a percentage (%). The display will depend on the amount of memory that is installed (☞ "RAM Bank" 0-1c).

#### 0-4b: Free Number

This shows the number of multisamples and samples that can be handled, and the maximum number of samples that can be used by multisamples. The remaining number and percentage (%) relative to this maximum is also displayed.

Multisample(MS)	[0000...0999/1000	000...099%]
Sample	[0000...4000/4000	000...100%]
Sample in MS	[0000...3999/4000	000...099%]

## Sampling P1: Sample Edit

Here you can edit sample data (waveform data). Editing operations such as deleting unwanted portions of the waveform, reversing the waveform, or lowering the sampling frequency can be performed in detail while viewing the “sample waveform display.”

### 1-1: Sample Edit

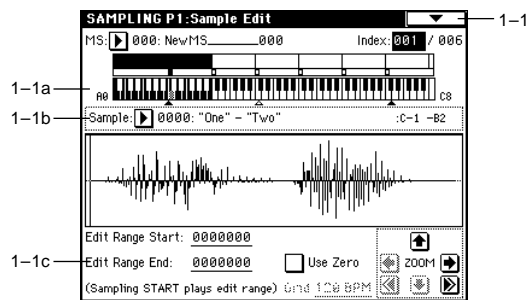

#### 1-1a: MS, Index, Keyboard & Index

**MS (Multisample Select)** [000...999]

Selects the multisample that contains the sample you wish to edit (⇨0-1a).

**Index** [xxx (001...128)/yyy (001...128)]

Selects the index of the sample you wish to edit. Your editing will affect the sample of the index that you select here, and the waveform will appear in the “sample waveform display” (⇨0-1a).

**note** An index can also be selected by holding down the [ENTER] key and playing a note on the keyboard. The index that includes this note will be selected. The key you played will be the base key, and will be displayed in gray in “Keyboard & Index” (⇨“Keyboard & Index” 0-1a).

**Keyboard & Index**

(⇨0-1a)

#### 1-1b: Sample Select, Range

**Sample Select** [----: ---No Assign---, 0000...3999]

**Range** [C-1...B9 — C-1...B9]

This shows the sample number and name for the selected index, and the range. If you modify “Sample,” the sample you specify here will be assigned to this index (⇨0-1b). The range of the index is shown at the right.

#### 1-1c: Sample waveform display, Edit Range Start, Edit Range End, Use Zero, Grid, ZOOM

##### Sample waveform display

This displays the waveform of the selected sample. The horizontal axis is the sample address (time axis), and the vertical axis is the sample level.

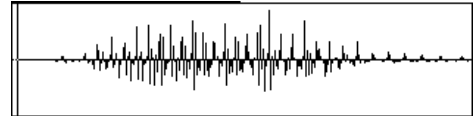

The thick line above the display border indicates the portion of the entire sample waveform that is displayed. As you zoom-in on the time axis, this will indicate which portion of the entire waveform is currently being viewed. If a stereo multisample or sample is selected, the L channel sample data of the multisample will be displayed in the upper half, and the R channel sample data in the lower half.

**Edit Range Start** [0000000...]

**Edit Range End** [0000000...]

This specifies the range (start address and end address) of the sample that will be edited by page menu commands. (This is shown in sample address units.)

The range you specify here will be highlighted in the “sample waveform display.”

**note** To audition the selected range, press the SAMPLING [START/STOP] key. The sample in the area between “Edit Range Start” and “Edit Range End” will sound at the pitch of the currently selected key (displayed in gray) (⇨“Keyboard & Index” 0-1a).

**Use Zero** [Off, On]

**On (checked):** When setting “Edit Range Start” and “Edit Range End,” it will be possible to select these only to locations where the waveform level is  $\pm 0$  (i.e., where the waveform crosses the center line of the “sample waveform display”). You can use the [VALUE] slider, [VALUE] dial, and [ $\Delta$ ] [ $\nabla$ ] keys [0]–[9] to automatically search for zero-cross addresses. By using the numeric keys you can search for the zero-cross address nearest to the value that you input.

**Off (unchecked):** “Edit Range Start” and “Edit Range End” can be set in increments of one. This is the normal setting.

**Grid** [040 BPM...480 BPM]

(⇨2-1c)

**ZOOM** This has no relation to the setting of the [TEMPO] knob.

##### ZOOM

These buttons let you zoom-in and zoom-out the “sample waveform display” along the horizontal axis (sample addresses) or vertical axis (sample level).

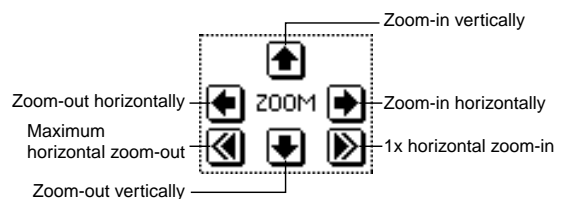

By zooming-in on the horizontal direction, you can move from the overall display where the waveform is shown as a solid line (1X magnification) to 2X or 4X magnification. (With 1X magnification, the display resolution of the LCD will be the same as the resolution of the sample addresses.)

For example if you change the sample address by one, the vertical line in the LCD that indicates the sample address will move in steps of one pixel.) In the vertical axis, you can zoom-in from 1X (full range display) to 512X (or 1024X in the case of stereo display).

Zoom-In/zoom-out will occur starting at the “Edit Range Start” or “Edit Range End” points you specify. (If a different parameter is selected when you zoom-in or -out, the zoom-in/out will be based on the last-selected point. If you re-select the “Edit Range Start” or “Edit Range End” points when the display is zoomed in or out, the display range will be adjusted so as to show the selected point.)

**Note** If the zoom ratio is low (1X or less), the “sample waveform display” may differ slightly from the displayed waveform before and after waveform editing, but this does not affect the playback sound. If this occurs, raising the zoom ratio will make the display accurate.

### ▼ 1-1: Page Menu Command

**Note** When using the page menu commands “Truncate” – “Volume Ramp” to edit the waveform data of a sample, first use “Edit Range Start” and “Edit Range End” to select the range that will be edited, and then choose and execute the desired page menu command.

**Note** There is no compare function that lets you return the edited result to the state before editing. If you wish to preserve the unedited sample, **uncheck** the “**Overwrite**”<sup>\*1</sup> item in the dialog box of each page menu command before you execute.

**Note** To edit the “Start” (start address) location at which the sample data (waveform data) will begin playing, the “LoopS” (loop start address), or “End” (end address), use P2: Loop Edit. If the above parameters are located within an area of sample addresses that are deleted or moved by your editing, they will automatically be moved.

#### **Stereo** Remarks on editing stereo samples

- For stereo samples, the L channel and R channel samples are edited simultaneously. If you wish to edit only the L channel or R channel, select a mono multisample, and select either the L channel or R channel sample for editing.
- For stereo samples, the display will indicate “Save to No.(L)” and “(R).” These respectively specify the writing-destination sample numbers for the L and R channels.
- If you “Copy” a mono sample into the buffer, and then “Insert,” “Mix,” or “Paste” it to a stereo sample, the data will be inserted, mixed, or pasted into both the L and R sides. (The result is that a stereo sample will be created.) If you “Copy” a stereo sample into the buffer, and then “Insert,” “Mix,” or “Paste” it to a mono sample, the L- and R-side data in the buffer will be mixed to mono, and then inserted, mixed, or pasted. (The result is that a mono sample will be created.)

You can also use these commands if you wish to monomix a stereo sample and use it as a mono sample. However, be aware that once a sample has been mixed to mono, it is no longer possible to return it to a stereo sample.

\*1: About “Overwrite”

When “**Overwrite**” is **unchecked**: When the command is executed, the edited sample will be saved in a different sample number. The unedited sample will remain without change.

When “**Overwrite**” is **checked**: When the command is executed, the edited sample will be overwritten onto the original sample (number). The original sample will be modified.

**Note** Normally, you will leave “Save to No.” at its default setting, and execute **without checking “Overwrite.”** When you execute, both the data before and after editing will be preserved, and the sample number of the edited data will be assigned as the sample of that index.

**Note** Loop Start Address “LoopS” and End Address “End” (2-1c) must be located at least eight addresses apart. If as a result of executing “Truncate” (1-1A), “Cut” (1-1B), or “Rate Convert” (1-1K), the Loop Start Address and End Address would be separated by less than eight addresses, the display will indicate “Sample length is shorter than minimum.” Please set the “Edit Range Start” and “Edit Range End” appropriately.

1-1A	Truncate	Paste	1-1G
1-1B	Cut	Insert Zero	1-1H
1-1C	Clear	Normalize/Level Adj.	1-1I
1-1D	Copy	Volume Ramp	1-1J
1-1E	Insert	Rate Convert	1-1K
1-1F	Mix	Reverse	1-1L

#### 1-1A: Truncate

This command deletes unwanted data that lies beyond the “Edit Range Start” and “Edit Range End.” Use this command when you wish to delete silence at the beginning or end of the waveform data.

**Note** If you wish to delete unneeded (unplayed) sample data after setting the Start Address “Start,” Loop Start Address “LoopS” and End Address “End” (2-1c), use the “Truncate” page menu command found in P2: Loop Edit.

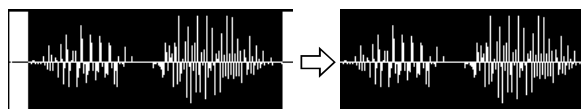

① Use “Sample Select” (1-1b) to select the sample that you wish to edit, and use “Edit Range Start” and “Edit Range End” to specify the editing range.

**Note** You can press the SAMPLING [START/STOP] key to hear the portion that will be left by the “Truncate” command.

② Select “**Truncate**” to access the dialog box.

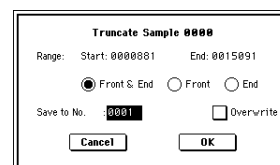

③ The editing range will be shown in Range “Start” and “End.”

④ Use the **radio buttons** to select the portion that will be deleted.

**Front & End:** The sample data that lies before the “Edit Range Start” and after the “Edit Range End” will be deleted.

**Front:** The sample data that lies before the “Edit Range Start” will be deleted.



**End:** The sample data that lies after the “Edit Range End” will be deleted.

- ⑤ In “Save to No.,” specify the save destination sample number. By default, an unused sample number will be selected.  
The sample number cannot be specified if “Overwrite” is checked (esp.101).  
**[Stereo]** For stereo samples, use “Save to No.(L)” and “(R)” to specify the save-destination of the L and R channels.
- ⑥ To execute the Truncate command, press the **OK button**. To cancel, press the **Cancel button**.

### 1-1B: Cut

This command deletes the data between the “Edit Range Start”-“Edit Range End.” Sample data located after the deleted portion will be moved toward the beginning of the sample.

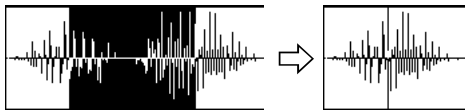

- ① Use “Sample Select” (1-1b) to select the sample that you wish to edit, and use “Edit Range Start” and “Edit Range End” to specify the editing range.

**note** You can press the SAMPLING [START/STOP] key to hear the portion that will be deleted by the “Cut” command.

- ② Select “Cut” to access the dialog box.

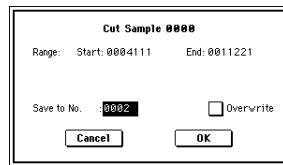

- ③ The range to be edited is shown by Range “Start” and “End.”
- ④ In “Save to No.,” specify the save destination sample number. By default, an unused sample number will be selected.  
The sample number cannot be specified if “Overwrite” is checked (esp.101).  
**[Stereo]** For stereo samples, use “Save to No.(L)” and “(R)” to specify the save-destination of the L and R channels.
- ⑤ To execute the Cut command, press the **OK button**. To cancel, press the **Cancel button**.

### 1-1C: Clear

This command converts the data between “Edit Range Start”-“Edit Range End” to zero values. Sample data before and after the edited range will not move.

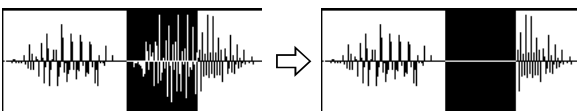

- ① Use “Sample Select” (1-1b) to select the sample that you wish to edit, and use “Edit Range Start”-“Edit Range End” to specify the editing range.

**note** You can press the SAMPLING [START/STOP] key to hear the portion that will be changed to zero-level by the “Clear” command.

- ② Select “Clear” to access the dialog box.

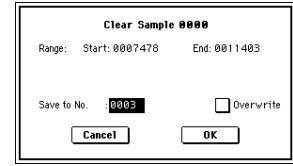

- ③ The range to be edited is shown by Range “Start” and “End.”
- ④ In “Save to No.,” specify the save destination sample number. By default, an unused sample number will be selected.  
The sample number cannot be specified if “Overwrite” is checked (esp.101).  
**[Stereo]** For stereo samples, use “Save to No.(L)” and “(R)” to specify the save-destination of the L and R channels.
- ⑤ To execute the Clear command, press the **OK button**. To cancel, press the **Cancel button**.

### 1-1D: Copy

This command copies the sample data from the area between “Edit Range Start”-“Edit Range End” into the sample data buffer. This data can then be used by the “Insert,” “Mix” or “Paste” commands.

**note** When you execute “Copy,” the data that is copied into the buffer actually consists only of the copy-source sample number, the “Edit Range Start” and “Edit Range End” locations and not the data itself. Do not delete the copy-source sample until you finish executing the “Insert,” “Mix,” or “Paste” command.

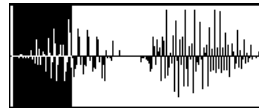

- ① Use “Sample Select” (1-1b) to select the sample that you wish to edit, and use “Edit Range Start” and “Edit Range End” to specify the editing range.

**note** You can press the SAMPLING [START/STOP] key to hear the portion that will be copied by the “Copy” command.

- ② Select “Copy” to access the dialog box.

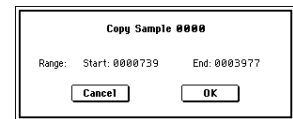

- ③ The range to be copied is shown by Range “Start” and “End.”
- ④ To execute the Copy command, press the **OK button**. To cancel, press the **Cancel button**.

### 1-1E: Insert

The sample data that was copied into the buffer by the “Copy” command will be inserted, starting at the “Edit Range Start” address. Any data that was located after this point will be moved toward the end of the sample.

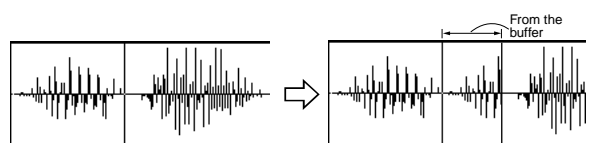

- ① Use “Sample Select” (1-1b) to select the sample that you wish to edit, and set “Edit Range Start” to specify the starting address. The “Edit Range End” setting is ignored.

- ② Select **“Insert”** to access the dialog box.

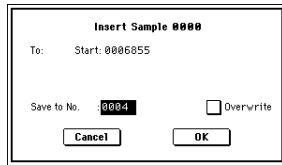

- ③ To **“Start”** will indicate the starting address at which the data will be inserted.
- ④ In **“Save to No.”**, specify the save destination sample number. By default, an unused sample number will be selected.  
The sample number cannot be specified if **“Overwrite”** is checked (⚠p.101).  
**[Stereo]** For stereo samples, use **“Save to No.(L)”** and **“(R)”** to specify the save-destination of the L and R channels.
- ⑤ To execute the **Insert** command, press the **OK** button. To cancel, press the **Cancel** button.

⚠ If the buffer into which data was placed by the **“Copy”** command contains no data, the display will indicate **“Source sample is empty.”**

**1-1F: Mix**

This command mixes the sample data that was placed in the buffer by **“Copy”** with the selected sample data. Mixing will begin at the **“Edit Range Start”** address.

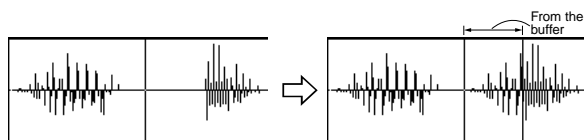

- ① Use **“Sample Select”** (1-1b) to select the sample that you wish to edit, and set **“Edit Range Start”** to specify the starting address. The **“Edit Range End”** setting is ignored.
- ② Select **“Mix”** to access the dialog box.

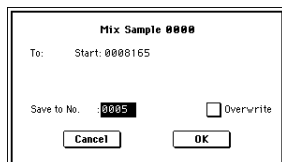

- ③ To **“Start”** will indicate the starting address at which the data will be mixed.
- ④ In **“Save to No.”**, specify the save destination sample number. By default, an unused sample number will be selected.  
The sample number cannot be specified if **“Overwrite”** is checked (⚠p.101).  
**[Stereo]** For stereo samples, use **“Save to No.(L)”** and **“(R)”** to specify the save-destination of the L and R channels.
- ⑤ To execute the **Mix** command, press the **OK** button. To cancel, press the **Cancel** button.

⚠ If the buffer into which data was placed by the **“Copy”** command contains no data, the display will indicate **“Source sample is empty.”**

**1-1G: Paste**

Beginning at the **“Edit Range Start”** address, this command places the sample data that was loaded into the buffer by **“Copy.”** The original data will be deleted, and overwritten by the sample data from the buffer. You can also place sample data into a blank sample. This is convenient when you wish to **“Copy”** part of a sample and create a new sample based on it.

**Pasting to a sample that contains sample data**

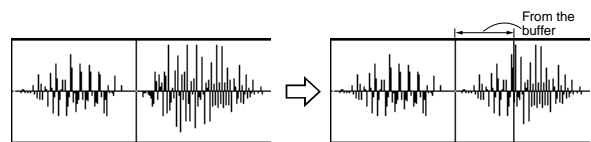

- ① Use **“Sample Select”** (1-1b) to select the sample that you wish to edit, and set **“Edit Range Start”** to specify the starting address. The **“Edit Range End”** setting is ignored.
- ② Select **“Paste”** to access the dialog box.

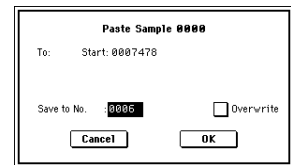

- ③ To **“Start”** will indicate the starting address at which the data will be pasted.
- ④ In **“Save to No.”**, specify the save destination sample number. By default, an unused sample number will be selected.  
The sample number cannot be specified if **“Overwrite”** is checked (⚠p.101).  
**[Stereo]** For stereo samples, use **“Save to No.(L)”** and **“(R)”** to specify the save-destination of the L and R channels.
- ⑤ To execute the **Paste** command, press the **OK** button. To cancel, press the **Cancel** button.

⚠ If the buffer into which data was placed by the **“Copy”** command contains no data, the display will indicate **“Source sample is empty.”**

**Pasting to a sample that contains no sample data**

- ① Select the vacant sample number that you wish to paste. If you select **----:---No Assign---** for **“Sample”** and then access the dialog box for this command, a vacant sample number will be selected automatically.
- ⚠ The **“Edit Range Start”** and **“Edit Range End”** settings will be ignored, and will have no effect. The beginning of the sample will be placed at address **0**.

- ② Select **“Paste”** to access the dialog box.

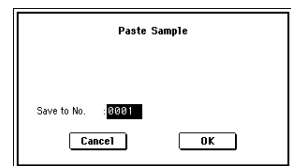

- ③ In **“Save to No.”**, specify the save destination sample number. If you wish to change it, re-specify the desired number.  
**[Stereo]** For stereo samples, use **“Save to No.(L)”** and **“(R)”** to specify the save-destination of the L and R channels.
- ④ To execute the **“Paste”** command, press the **OK** button. To cancel without executing, press the **Cancel** button.

**1-1H: Insert Zero**

This command inserts zero-level sample data (silence), beginning at the **“Edit Range Start”** address. The data that previously occupied that location will be moved toward the end of the sample.

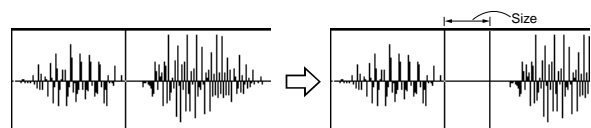

- ① Use "Sample Select" (1-1b) to select the sample that you wish to edit, and set "Edit Range Start" to specify the starting address. The "Edit Range End" setting is ignored.
- ② Select "Insert Zero" to access the dialog box.

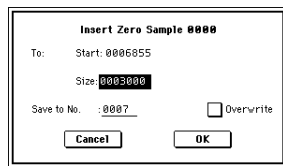

- ③ To "Start" will indicate the starting address at which the data will be inserted.
- ④ In "Size," specify the length of the data that will be inserted.
- ⑤ In "Save to No.," specify the save destination sample number. By default, an unused sample number will be selected. The sample number cannot be specified if "Overwrite" is checked (see p.101). **[Stereo]** For stereo samples, use "Save to No.(L)" and "(R)" to specify the save-destination of the L and R channels.
- ⑥ To execute the Insert Zero command, press the **OK button**. To cancel, press the **Cancel button**.

### 1-1I: Normalize/Level Adj.

This command uniformly modifies the data values (volume) of the data between the "Edit Range Start" – "Edit Range End." "Normalize" will amplify the level of the sample data as far as possible without allowing it to clip (distort). If the level of the sampled data is too low, you can execute this command to increase the dynamic range. "Level" allows you to raise or lower the level as desired.

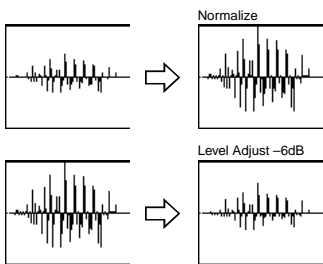

- ① Use "Sample Select" (1-1b) to select the sample that you wish to edit, and use "Edit Range Start" and "Edit Range End" to specify the editing range.

**note** You can press the SAMPLING [START/STOP] key to hear the portion that will be normalized or level-adjusted.

- ② Select "Normalize/Level Adj." to access the dialog box.

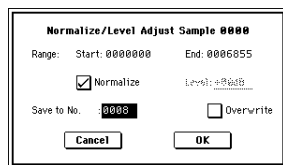

- ③ The range to be edited is shown by Range "Start" and "End."
- ④ If you check "Normalize" and execute, the data will be normalized. In this case, the "Level" setting will be ignored. If you wish to specify "Level" to modify the level of the sample data, do not check "Normalize."

**note** Each increase of +6 dB will approximately double the height of the waveform shown in the LCD. +12 dB will

be an increase of approximately 4X, and +18 dB will be approximately 8X. Conversely, each decrease of -6 dB will halve the level, so that -6 dB will be 1/2X and -12 dB will be approximately 1/4X. Executing the "Level" command with positive (+) settings may cause the sound to clip (i.e., distort at the point that amplification beyond the maximum level is impossible). Once the sample data has been boosted beyond the clipping point, re-executing this command with negative (-) settings of "Level" will simply lower the overall level of the clipped signal – the waveform will remain distorted. Also, if executing "Level" with negative (-) settings causes any portion of the sample data to reach a zero level, the zero data will not return to its original state even if you re-execute "Level" with positive (+) settings.

- ⑤ In "Save to No.," specify the save destination sample number. By default, an unused sample number will be selected. The sample number cannot be specified if "Overwrite" is checked (see p.101). **[Stereo]** For stereo samples, use "Save to No.(L)" and "(R)" to specify the save-destination of the L and R channels.
- ⑥ To execute the Normalize/Level Adjust command, press the **OK button**. To cancel, press the **Cancel button**.

**⚠** Be aware that if sample data of an extremely low level is normalized, any noise included in the sample will also be amplified.

### 1-1J: Volume Ramp

This command modifies the data values (volume) between the "Edit Range Start" and "Edit Range End." You can make the volume gradually increase (Fade In) or decrease (Fade Out) from the "Edit Range Start" to the "Edit Range End."

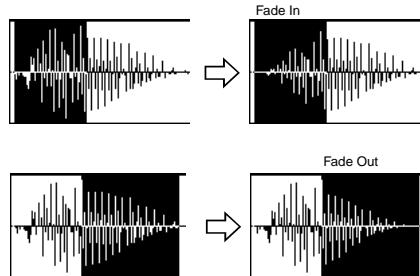

- ① Use "Sample Select" (1-1b) to select the sample that you wish to edit, and use "Edit Range Start" and "Edit Range End" to specify the editing range.

**note** You can press the SAMPLING [START/STOP] key to hear the portion on which "Volume Ramp" will be executed.

- ② Select "Volume Ramp" to access the dialog box.

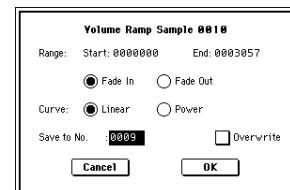

- ③ The range to be edited is shown by Range "Start" and "End."
- ④ Use the **radio buttons** to select the type of volume ramp. **Fade In:** The volume at Range "Start" will be zero, and will gradually increase toward "End." **Fade Out:** The volume will gradually decrease from the Range "Start" volume until it reaches zero at "End."

- ⑤ In “**Curve**,” specify the way in which the volume will change.  
**Linear:** The volume will change linearly. For normal fade-in or fade-out, select Linear.  
**Power:** The volume will change non-linearly. When you use “Mix” (1-1F) to combine a faded-in waveform with a different faded-out waveform (i.e., crossfade), using a **Linear** fade-in/out may produce an impression that the volume has dropped in the middle of the curve. In such cases, use **Power** to perform the fade-in/out.
- ⑥ In “Save to No.,” specify the save destination sample number. By default, an unused sample number will be selected.  
 The sample number cannot be specified if “Overwrite” is checked (☞p.101).  
**[Stereo]** For stereo samples, use “Save to No.(L)” and “(R)” to specify the save-destination of the L and R channels.
- ⑦ To execute the Volume Ramp command, press the **OK** button. To cancel, press the **Cancel** button.

**1-1K: Rate Convert**

This command lowers the sampling rate (frequency) of the sampled data by 2/3, 1/2, 1/3, 1/4, or 1/6. The sampling frequency of input is fixed at 48 kHz, but you can use this command to create “down-sampling” effects. The sample data is thinned to convert it into sample data of a lower sampling frequency.  
 The “Rate Convert” command is always executed on all waveform data of the selected sample, regardless of the “Edit Range Start” and “Edit Range End” settings.

- ① Use “Sample Select” (1-1b) to select the sample that you wish to edit.
- ② Select “**Rate Convert**” to access the dialog box.

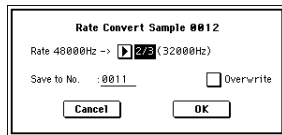

- ③ The sampling rate of the selected sample is shown at the right of “Rate.” At the right of the “->” you can select the desired amount of the sampling rate conversion: 2/3, 1/2, 1/3, 1/4 1/6. The sampling rate following conversion will be displayed in Hz.
- ④ In “Save to No.,” specify the save destination sample number. By default, an unused sample number will be selected.  
 The sample number cannot be specified if “Overwrite” is checked (☞p.101).  
**[Stereo]** For stereo samples, use “Save to No.(L)” and “(R)” to specify the save-destination of the L and R channels.
- ⑤ To execute the Insert Zero command, press the **OK** button. To cancel, press the **Cancel** button.

- ⚠ This command cannot be executed on a sample whose sampling rate is 11.025 kHz or less.
- ⚠ Stereo samples must have the same sampling rate. Although it is possible to select mono multisamples for -L and -R and convert their sampling rate separately, they can no longer be handled as a stereo sample in this case.

**1-1L: Reverse**

This command reverses the sample data (i.e., exchanges the beginning and end).  
 The “Reverse” command is always executed on all waveform data of the selected sample, regardless of the “Edit Range Start” and “Edit Range End” settings.

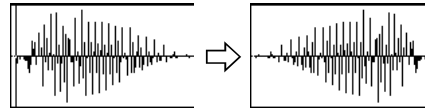

- ① Use “Sample Select” (1-1b) to select the sample that you wish to edit.
- ② Select “**Reverse**” to access the dialog box.

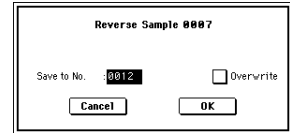

- ③ In “Save to No.,” specify the save destination sample number. By default, an unused sample number will be selected.  
 The sample number cannot be specified if “Overwrite” is checked (☞p.101).  
**[Stereo]** For stereo samples, use “Save to No.(L)” and “(R)” to specify the save-destination of the L and R channels.
- ④ To execute the Reverse command, press the **OK** button. To cancel, press the **Cancel** button.

**note** When you execute this command, all of the sample data will be rewritten to reverse its direction. The P2: Loop Edit also contains a “Rev” (2-1c) command, which simply reverses the playback direction without affecting the sample data itself.

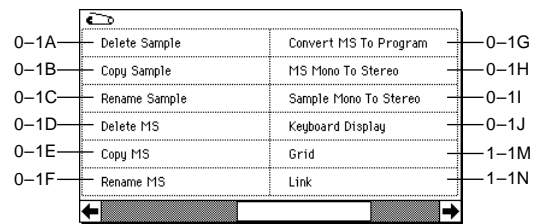

**1-1M: Grid**

This command displays a grid in the “sample waveform display.”  
 When you set the **Grid** to **On** and execute this command, vertical dotted lines will appear in the “sample waveform display” according to the specified resolution (“Resolution”) and tempo (“Grid” 1-1c, 2-1c). Use the grid when you wish to cut the sample data or determine waveform starting locations based on BPM values or beats.

**note** The vertical dotted lines will be shown starting at the “Start” (when Loop is off) or “Loop Start” (when Loop is on) (P2: Loop Edit) addresses, and are calculated according to the playback when the sample is played by the currently selected key (displayed in gray) (☞“Keyboard & Index” 0-1a).

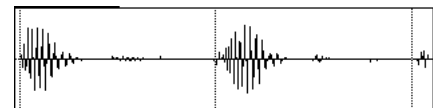

- ① Use “Sample Select” (1-1b) to select a sample.
- ② Select “**Grid**” to access the dialog box.

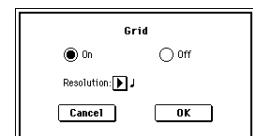

- ③ Use the **On/Off** Radio buttons to switch the grid on or off.

- ④ In **“Resolution,”** select the desired resolution for the grid. The grid that appears will be determined by this setting and by the **“Grid”** (1-1c, 2-1c) setting in the page.
- ⑤ To execute the settings, press the **OK button**. To cancel, press the **Cancel button**.

### 1-1N: Link

This command connects the currently selected sample with another sample.

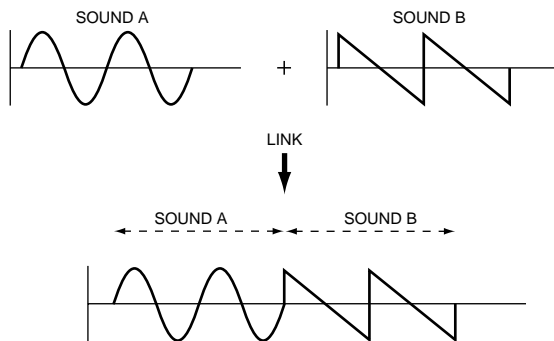

The volume of the two samples can be changed gradually at the transition to gradually mix the samples with each other. This is called **crossfade**, and can be used to produce a natural-sounding transition between the two sounds.

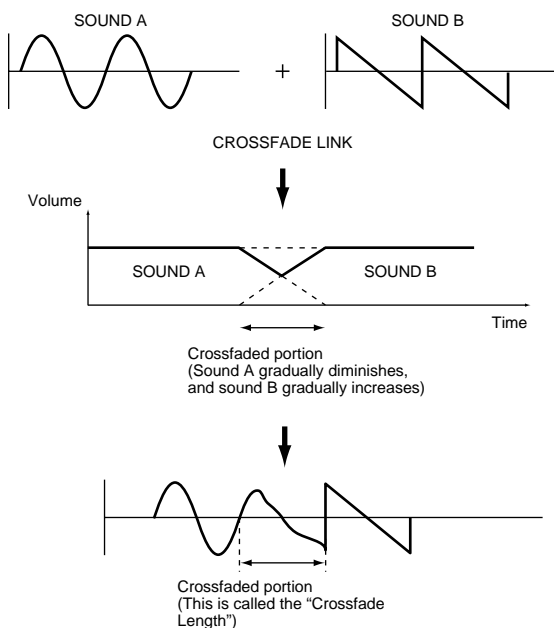

**“Link”** will be executed for all of the selected sample data, regardless of the **“Edit Range Start”** and **“Edit Range End”** settings.

- ① Use **“Sample Select”** (1-1b) to select the sample that will be placed in front by the Link command.
- ② Select **“Link”** to access the dialog box.

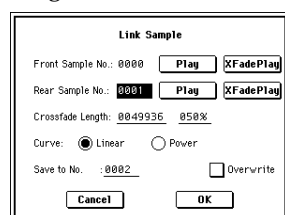

- ③ The sample number selected for **“Front Sample No.”** - Sound A in the above example - will be displayed. When the command is executed, this sample will be placed in front.

When you press the **Play button** located beside this parameter, the entire sample will be played. When the sample has played to the end, playback will stop automatically. If you want to stop playback mid-way through the sample, press the **Play button** once again.

**[Stereo]** If you select one side of a stereo sample, it will automatically be detected as a stereo sample, and the other side of the sample will also be processed by the Link command.

If the **“Front”** Sample is mono and the **Rear Sample** is stereo, the L and R of the **“Rear”** Sample will be mixed to mono before linking.

If the **“Front”** Sample is stereo and the **“Rear”** Sample is mono, the identical sample will be placed in L and R of the **“Rear”** Sample before linking.

- ④ Use **“Rear Sample No.”** - Sound B in the above example - to select the sample number that will be linked. When the command is executed, this sample will be placed in back.

When you press the **Play button** located beside this parameter, the entire sample will be played. When the sample has played to the end, playback will stop automatically. If you want to stop playback mid-way through the sample, press the **Play button** once again.

- ⑤ In **“Crossfade Length,”** specify the length over which the crossfade will occur. If you specify a % value, the proportion in relation to the entire **“Front”** Sample will be calculated automatically. If you specify **50%**, the last half of the **“Front”** Sample will crossfaded.

⚠ If the rear sample is short, the **“Crossfade Length”** cannot be set any longer than the length of the **“Rear”** sample. In this case, it will not be possible to specify a value up to 100%.

If you set **“Crossfade Length”** to other than **0**, **XFade-Play button** will be displayed. By holding down one of these buttons, you can play back just the crossfaded portion of the front or rear sample. Playback will stop after the length specified by **“Crossfade Length.”** To stop playback, press the **XFadePlay button** once again. If you do not want to X-fade, set this to **0**.

note

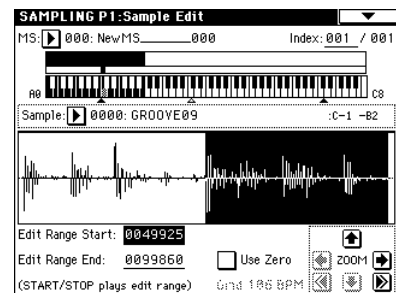

After selecting a sample in step ①, you can set **“Edit Range Start”** and specify the beginning of the crossfade while viewing the waveform. Set **“Edit Range End”** to the end of the sample. If you specify these, **“Crossfade Length”** will indicate the length determined by **“Edit Range Start”** and **“Edit Range End.”**

- ⑥ In **“Curve,”** specify how you want the volume to change in the crossfaded portion.

**Linear:** The volume will change linearly.

**Power:** The volume will change non-linearly. In some cases, **“Linear”** may sound as though the volume diminishes in the middle of the curve. If this occurs, use **“Power.”**

- ⑦ In **“Save to No.,”** specify the save destination sample number. An unused sample number will be selected by default.

The sample number cannot be specified if "Overwrite" is checked (see p.101).

**[Stereo]** For stereo samples, use "Save to No.(L)" and "(R)" to specify the save-destination of the L and R channels.

- ⑧ To execute the Link command, press the **OK** button. To cancel without executing, press the **Cancel** button.

**⚠** If you link samples of different sampling rates (such as created by "Rate Convert" see 1-1K), the newly created sample will have the sampling rate of the "Front" sample.

**⚠** One vacant sample is used in order to execute Link. Be aware that if there are no vacant samples, an error will occur.

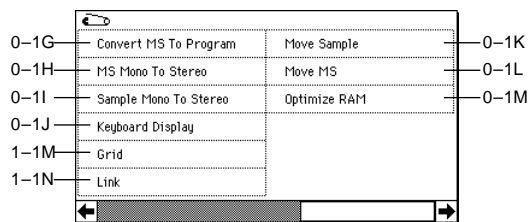

## Sampling P2: Loop Edit

### 2-1: Loop Edit

Here you can specify the portion of the sample that will be played back, set sample parameters, and edit the sample. Sample parameters that were loaded into internal sampling memory in Disk mode can also be edited in the same way. You can make detailed edits in single-sample steps while watching the sample waveform display.

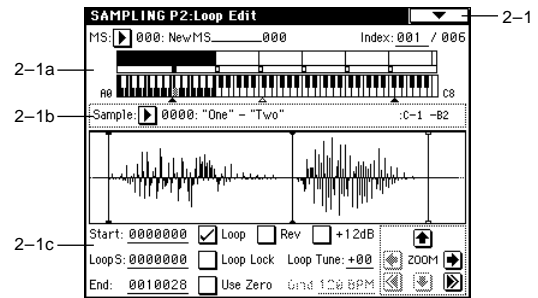

#### 2-1a: MS, Index, Keyboard & Index

**MS (Multisample Select)** [000...999]

Selects the multisample whose loop and other sample parameters you wish to edit (see 0-1a).

**Index** [xxx (001...127)/yyy (001...127)]

Selects the index whose loop and other sample parameters you wish to edit. Your edits will apply to the sample of the index selected here, and the waveform will appear in the "sample waveform display" (see 0-1a).

**note** You can also select an index by holding down the [ENTER] key and playing a note on the keyboard. The index that includes this note will be selected. The note you played will be the base key, and will be shown in gray in "Keyboard & Index." (see "Keyboard & Index" 0-1a)

**Keyboard & Index**

(see 0-1a)

#### 2-1b: Sample Select, Range

**Sample Select**

[----: ---No Assign----, 0000...3999]

**Range**

[C-1...G9 — C-1...G9]

This selects the sample of the index. If you change "Sample Select," the sample you specify will be assigned to this index (see 0-1b). The sample you select here will appear in the "sample waveform display."

The range of the index is displayed at the right.

**2-1c: Sample waveform display, Start, LoopS, End, Loop, Rev, +12 dB, Loop Lock, Loop Tune, Use Zero, Grid, ZOOM**

**Sample waveform display**

The waveform of the "Sample Select" is displayed here (☞1-1c).

**Start (Start Address)** [0000000...]

Specifies the starting address for sample playback (This value is in units of a sample address).

**LoopS (Loop Start Address)** [0000000...]

Specifies the loop start address for sample playback. This is valid when Loop is On. This value is in units of a sample address (☞"S.Offset" Program P1: 1-2a).

**End (End Address)** [0000000...]

Specifies the ending address for sample playback (This value is in units of a sample address).

▲ Loop Start Address and End Address must be located at least eight addresses apart. This setting will be applied automatically when you set the addresses.

**Loop (Loop On)** [Off, On]

Specifies whether or not the sample will be looped.

**On (checked):** When played, the sample will continue looping from "LoopS" to "End"; e.g., "Start" → "End" → "LoopS" → "End" → "LoopS" → ...

**Off (unchecked):** The sample will playback once from "Start" → "End" (one-shot playback).

If you sample with "Auto Loop On" (0-3b) checked, this item will automatically be checked.

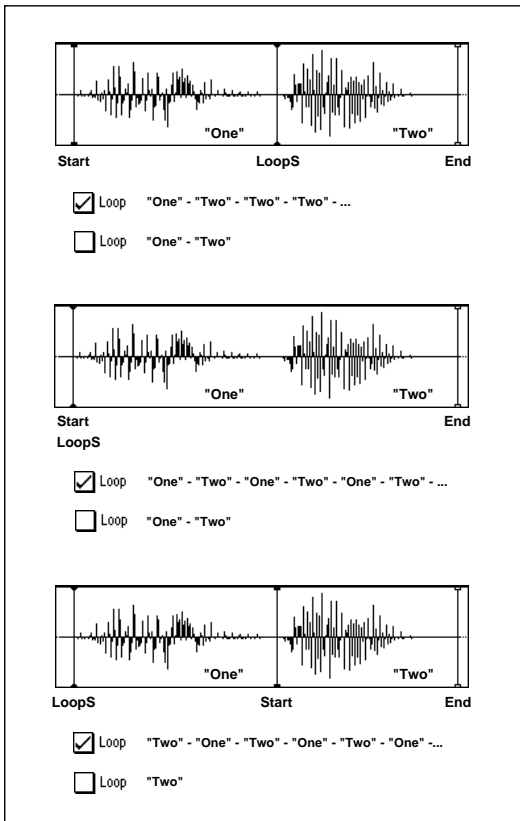

**Rev (Reverse)** [Off, On]

**On (checked):** The sample will be played backward, from "End" (end address) to "LoopS" (loop start address).

**+12 dB** [Off, On]

**On (checked):** The sample playback level will be approximately +12 dB louder than if this setting were Off (unchecked).

**Off (unchecked):** The sample will play back at the normal level. This is the same standard level as the playback level for ROM multisamples and drum samples.

Changing this on/off setting will not affect the sample data that appears in the sample waveform display.

This setting will automatically be turned on if you check "Auto +12 dB On" (Sampling: 0-3b, Program, Combination, Sequencer: "Select Bank & Smpl. No.") when you sample.

**note** This parameter is unique to the TRITON STUDIO. This setting will be preserved when you save the data as a KORG format sample file (.KSC, .KMP, .KSF). However, devices other than the TRITON STUDIO that support the KORG sample format such as the TRITON, TRITON-Rack, TRITON Le, and TRINITY will ignore this setting. (As of March 2002.) ("Data compatibility" ☞p.279) "+12 dB" will be turned off when you load an AKAI, AIFF, or WAVE format sample in Disk mode. This parameter is ignored when you use the Disk mode page menu command "Export Smpl AIF/WAV" (0-2H) to export an AIFF or WAVE format sample file.

**Loop Lock** [Off, On]

This fixes the length of the loop being edited.

**On (checked):** When the "LoopS" or "End" address is edited, the "End" or "LoopS" will be automatically adjusted so that the distance between "LoopS" and "End" (i.e., the loop length) does not change. This is convenient when you are creating a rhythm loop to match a specific tempo.

**Loop Tune** [-99...+99]

When looping is on ("Loop" is checked), you can adjust the playback pitch of the loop from "LoopS" to "End" over a range of ±99 cents. When you loop data that was sampled from a musical instrument etc., the pitch of the looped portion may sometimes be incorrect. Use this parameter to compensate for such cases.

**Use Zero** [Off, On]

**On (checked):** "Start," "End" and "LoopS" can be set these only to locations where the waveform level is ±0 (i.e., "zero-cross" addresses where the waveform crosses the center line of the "sample waveform display"). (☞1-1c)

**Off (unchecked):** "Start," "End" and "LoopS" can be set in steps of one unit. This is the normal setting.

**Grid** [040 BPM...480 BPM]

This displays vertical dotted lines in the "sample waveform display" to indicate the resolution and tempo. Use this when you wish to cut or edit the sample data based on a BPM value or beat. If you turn the page menu command "Grid" (1-1M) On and execute, a grid will be displayed. The spacing of the grid is determined by the "Resolution" setting of the "Grid" page menu command, relative to the playback pitch of the base key (the key displayed in gray in "Keyboard & Index" 0-1a) at the tempo value you specify here.

**note** The grid will begin at the "Start" address (when looping is off) or at the "Loop Start" address (when looping is on).

▲ This has no connection with the [TEMPO] knob.

**ZOOM**

This allows you to zoom-in/out in horizontal and vertical directions of the "sample waveform display" (☞1-1c).

## ▼ 2-1: Page Menu Command

**▲** For these commands, no Compare function is available that would let you return to the prior state after executing the command. If you want to retain the original sample when you edit, **uncheck** the “**Overwrite**” box in the dialog box of the page menu command.

**note** For notes about using “Overwrite” and on editing stereo samples, refer to “1-1: Page Menu Command.”

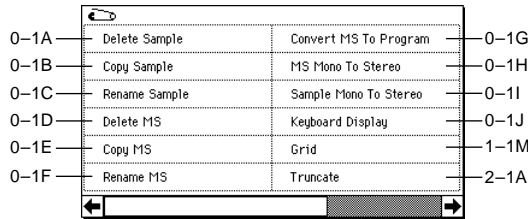

### 2-1A: Truncate

This command deletes unwanted data that lies outside of the “Start (Start Address),” “LoopS (Loop Start Address),” and “End (End Address)” (2-1c). After setting the start address, loop start address, and end address of the sample, use this command to delete unwanted sample data.

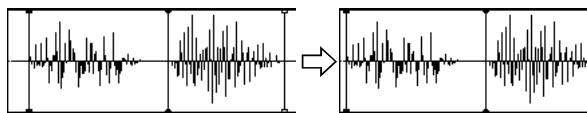

- 1 Use “Sample Select” (2-1b) to select the sample that you want to edit, and use “Start (Start Address)” or “LoopS (Loop Start Address)” and “End (End Address)” to specify the region that you want to edit.
- 2 Select “**Truncate**” to access the dialog box.

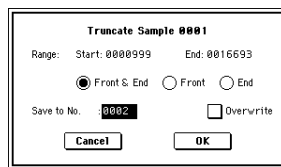

- 3 Range “Start” and “End” will show the range of data that will be edited.
- 4 Use the radio buttons to select the portion that will be deleted.

**Front & End:** The sample data that lies before the Range “Start” (start address or loop start address) and after the Range “End” (end address or loop start address) will be deleted.

**Front:** The sample data that lies before the Range “Start” (start address) will be deleted.

**End:** The sample data that lies after the Range “End” (end address) will be deleted.

- 5 In “**Save to No.**,” specify the save destination sample number. By default, an unused sample number will be selected. The sample number cannot be specified if “Overwrite” is checked (see p.101).

**[Stereo]** For stereo samples, use “Save to No.(L)” and “(R)” to specify the save-destination of the L and R channels.

- 6 To execute the Truncate command, press the **OK button**. To cancel, press the **Cancel button**.

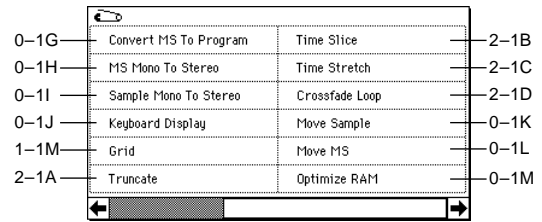

### 2-1B: Time Slice

Time Slice detects the attacks (e.g., kick and snare) within a rhythm loop sample (a sample that loops a drum pattern, etc.), and automatically divides the sample into individual percussion instrument notes. The divided percussion instrument notes will be created as individual samples, and automatically assigned as a multisample and program. Song performance data corresponding to the divided samples will also be created, so that in Sequencer mode you can adjust the tempo of the song to change only the tempo of the rhythm loop without affecting the pitch. The performance data that is created will use notes D2 and above, corresponding to the newly created samples of individual percussion instruments.

In addition to changing only the tempo of the rhythm loop without affecting the pitch, this makes it possible for you to exchange note numbers, change the timing, or edit the sequence data to freely create new rhythm loops, or even recreate the original loop.

Time Slice also allows you to change the pitch of the track without affecting the tempo for new creative possibilities. This command can also be executed on a stereo sample.

Original rhythm sample: Sample0

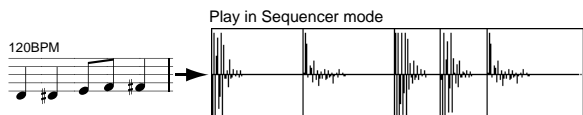
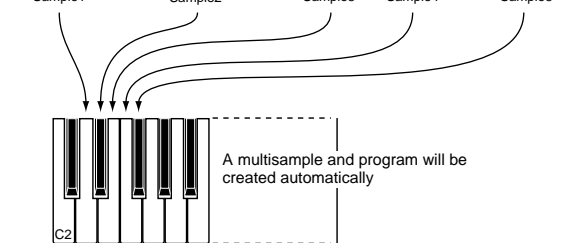
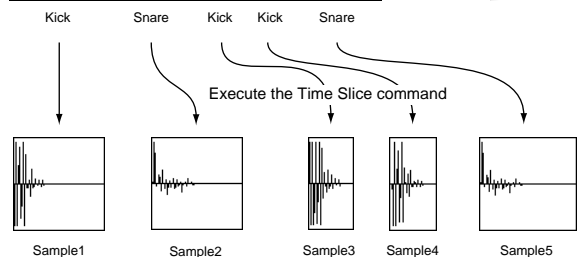
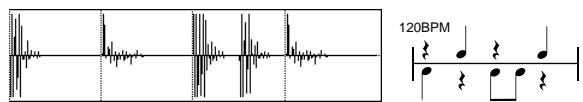



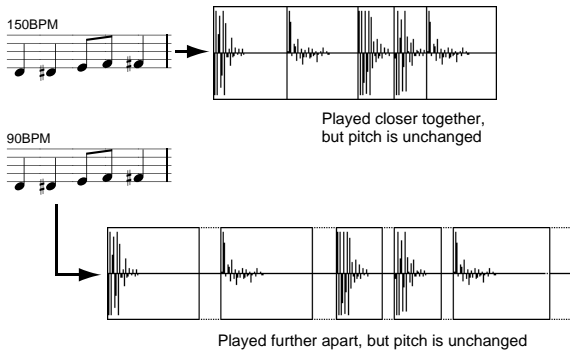

\* You can also use the Time Stretch command to control the compression of each sample to optimize the "spacing" to match the tempo. (F8) (9)

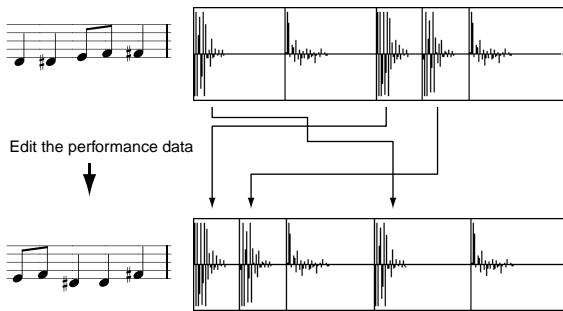

**note** As an alternative to the "Time Slice" command, "Time Stretch" (F8) (2-1C) is another way to change the tempo of a rhythm loop or similar sample. You may wish to use this if you don't need to divide the sample and create song performance data for the divided samples.

- 1 Select the sample in the "Sample Select" (2-1b) for which you wish to execute Time Slice.

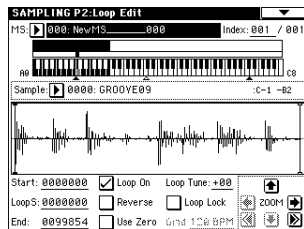

- 2 Select the "Time Slice" to access the dialog box.

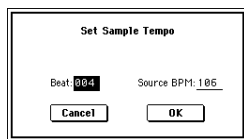

- 3 Specify the number of quarter-note beats and tempo of the currently selected sample. If you know the BPM of the original waveform, set "Source BPM." If you do not know the BPM, specify "Beat" and the BPM will be calculated automatically. The setting you make here will be used as the reference value when detecting the attack, when performing Time Stretch in step 9b, and when saving the sequence data in step 10.

**Beat:** Specifies the number of quarter-note beats. When you specify "Beat," the "Source BPM" will indicate the playback BPM at the original key. This BPM value will automatically be calculated from the start address to the end address (if loop is off) or from the loop start address to the end address (if loop is on) of the selected sample. If you know the BPM and it is different than the displayed value, change "Source BPM" to the correct value.

For example in the case of a 120 BPM sample of one measure of 4/4 time, set "Beat" to 4. The "Source BPM" will be calculated automatically. If the "Source BPM" is not set to 120, due to inaccuracies in the start address (or loop start address) and end address, change the "Source BPM" to 120.

**Source BPM:** Specifies the tempo at the original key of the source waveform.

- 4 To execute Time Slice, press the **OK button**. To cancel without executing, press the **Cancel button**. When you press the **OK button**, the attacks will be detected, the sample will automatically be sliced, and a dialog box will appear.

**[Stereo]** In the case of a stereo sample in which L and R have different lengths, silent data will automatically be added to the end of the shorter sample so that the two samples will be the same length.

- 5 If you want to re-set "Beat" and "Source BPM" after pressing the **OK button**, you can do so in step 9a).

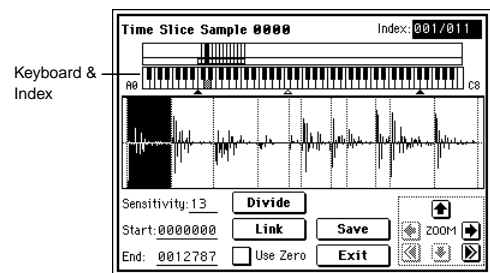

- 5 Listen to the samples that were divided by detecting their attacks. The sample before slicing is assigned to the C2 note of the keyboard, and the sliced samples are assigned to notes D2 and above. When you change the "Index," the corresponding display will be highlighted, allowing you to view the sliced waveforms.

**note** You can also select an index by holding down the [Enter] key and pressing a note on the keyboard. The index that is assigned to the note you pressed will be selected.

**note** To hear the sliced sounds, you can either press the corresponding note on the keyboard, or change the index to select the desired sample and then press the SAMPLING [START/STOP] key. When you press the SAMPLING [START/STOP] key, the sample in the range between the specified "Start" and "End" will be played at the original key.

**Keyboard & Index:** This shows the multisample that is being used temporarily in this dialog box. When you play the keyboard, this multisample will sound. It will behave in the same way as in normal pages (such as the Recording page). (F8) (0-1a)

**[Stereo]** In the case of a stereo sample, a stereo multisample will be temporarily used. The sample at each index will sound in stereo.

**Index** [Source, xxx(001...090)/yyy(001...090)]: Selects the sample index.

If this is set to **Source**, the original waveform before time slicing will be selected.

By selecting **xxx/yyy** you can specify individual samples that were sliced. **xxx** indicates the selected sample, and **yyy** indicates the total number of samples that were sliced. A maximum of 90 samples can be assigned to the keyboard. If more than 90 samples were sliced, this will display 90.

**Sample waveform display:** This displays a dotted vertical line at the locations where the sample was sliced, and a solid vertical line at the Start, Loop Start, and End locations. When “Index” is **xxx/yyy**, the sample of the selected index will be highlighted.

**[Stereo]** In the case of a stereo sample, the L channel sample data will be displayed above, and the R channel sample data will be displayed below.

**ZOOM:** You can zoom in and zoom out in the vertical and horizontal dimensions of the waveform shown in the sample waveform display. (☞ 1-1c)

- ⑥ If the slice locations are not appropriate, you can adjust “Sensitivity” to change the sensitivity at which the attacks are detected, in order to change the slice locations.

**Sensitivity** [00...30]:  
Adjusts the sensitivity at which the attacks are detected. By increasing this value, you can detect attacks at even lower levels, to create more finite slices.

- ⚠ The “level” in this case does not necessarily correspond to the “waveform level.”

Depending on the sample, the desired slicing may not occur even if you increase the “Sensitivity.” If the attack portion of the following sample has overlapped into the end of the sample, or if the sample contains two sounds, make adjustments in step ⑦.

- ⑦ Make adjustments where the automatic attack detection did not occur correctly. Change “Index” to select the sample that you wish to adjust. Make adjustments by changing “Start” and “End,” and by executing “Divide” or “Link” to adjust the slice location.

**Start:** Specify the start address for the sample of the currently selected “Index.” At the same time, the end address of the sample for the preceding “Index” will also be adjusted.

**End:** Specify the end address for the sample of the currently selected “Index.” At the same time, the start address of the sample for the next “Index” will also be adjusted.

- ⚠ If “Index” is set to **Source**, the address of the original waveform will be modified. If you change the start address, the loop start address will also be changed at the same time.

- note** When adjusting the “Start” and “End” addresses of the divided samples, use “ZOOM” to increase the magnification (×1 or more) so that the sample waveform is displayed accurately when you make adjustments. (☞ 1-1c)

**Use Zero:** (☞ 1-1c)

- note** If you wish to adjust the “Start” or “End” address of a divided sample, it is best to first **check** “Use Zero.” In general, using zero-cross points to specify sample addresses will make it less likely that clicks or pops will occur, particularly at the end address.

**Divide:** This splits the sample of the currently selected “Index” into two. Use this when you wish to add another location to slice the sample. Modify “End” or “Start” to adjust the divided sample.

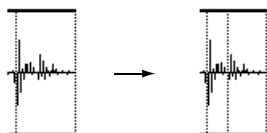

**Link:** This joins the sample of the currently selected “Index” to the sample of the next “Index.” Use this when you wish to merge together two sliced locations.

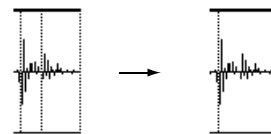

- ⚠ Be aware that if you change the “Sensitivity” after adjusting the slice location, the attacks will be re-detected and the sample will automatically be sliced again.

- note** When you use Time Slice on a rhythm loop sample, the quality of the playback in Sequencer mode will depend largely on the “cutoff” of each percussion instrument sound that was sliced.

**What kind of slices will produce the best result?**

#### A. Divide the separate percussion instrument notes as finely as possible

For example in the case of a sample where the decay of the kick is overlapped by the hi-hat, the attack sound of the kick and the attack sound of the hi-hat should be sliced to create two samples. If these sounds are left as one sample (containing both kick and hi-hat), their rhythm may become incorrect when the sample is played at a different tempo.

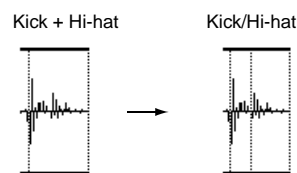

If the sample is not sliced appropriately even after you adjust the “Sensitivity,” use “Divide” to divide the sample into halves, and adjust “End” and “Start” as needed.

#### B. Make sure that each divided sample has a clear attack

The attack portion is vital for percussion sounds. Slice the sample at a point where the attack will be sounded crisply.

#### C. Avoid the noise that can occur toward the end of each divided sample

For example as shown in the above right illustration, noise can be present at the end of the kick sample. Adjust the end address of the kick sample so that the noise is not obtrusive.

In this case, adjusting the end address will also affect the start address of the hi-hat sample. While listening to the two samples, make adjustments so that the noise at the end of the kick sample is as inconspicuous as possible, and also that the hi-hat attack is heard cleanly.

Pay attention to these points as you adjust “Sensitivity.” If necessary, use the methods described above to edit each sample.

The noise occurring at the end of the sample in “C.” will be automatically reduced when you execute steps ⑧ and following. You should adjust “Sensitivity” while paying particular attention to sections “A” and “B,” and then execute step ⑨. If the noise is still obtrusive, then you can adjust the end address.

- ⑧ Save the sliced samples to the multisample to which they have been assigned. When you press the **Save** button, the “Save Samples & MS” dialog box will appear.

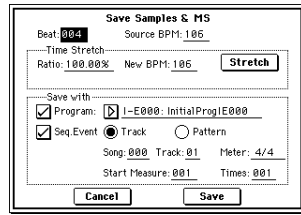

- ③ Use **Time Stretch** to adjust the length of the sliced samples. When you press the **Stretch** button, Time Stretch (a function that expands or shrinks the length of a sample without affecting its pitch) will be applied to the sliced sample.

If you wish to save the sliced sample as it is, proceed to step ⑩ without executing Time Stretch.

Sometimes when a sliced sample is played in Sequencer mode and the tempo is slowed down, the silent portion between samples may become obvious or noise may be more apparent, producing an unnatural-sounding result. To avoid this, you can use Time Stretch to adjust the length of the individual samples. The length of the samples will automatically be optimized according to the "Ratio" and "New BPM" settings.

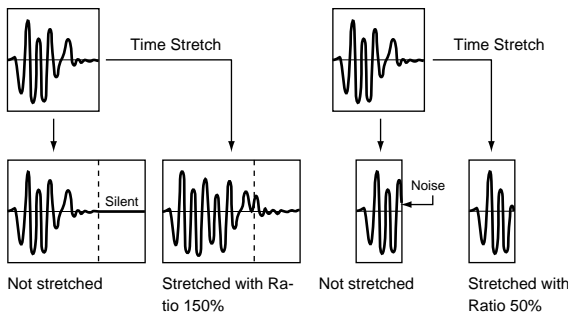

**note** If you execute Time Stretch at **100%**, the sample length will not change but the end of the sample will be faded out, reducing the noise.

- Set "**Beat**" and "**Source BPM**." The method is the same as in step ③. If you wish to change the value you set in step ③, you can change it here.
- Specify the length of the sample that will be created by Time Stretch.

- To specify the length as a ratio**  
Set "**Ratio**." The available range is **50.00–200.00%**. If you specify **50.00%**, the sample length will be halved. (The tempo will double.) If you specify **200.00%**, the sample length will double. (The tempo will be halved.)

- To match an existing BPM tempo value**  
Use "**New BPM**" to specify the BPM value of the sample you wish to create. The "**Ratio**" will automatically be calculated from the "**Source BPM**" and the "**New BPM**" values.

⚠ It is not possible to make settings that would cause "Source BPM" or "New BPM" to exceed the range of 40–480.

It is not possible to make settings that would cause "Ratio" to exceed the range of 50.00–200.00.

Press the **Stretch** button to execute Time Stretch. When you execute the command, the time-stretched samples will automatically be assigned to notes D2 and above of the keyboard, allowing you to audition the sound. You can change "Ratio" and "New BPM" as many times as desired and continue auditioning the result.

**note** When you audition the time-stretched samples, the sound you hear is the sound of each divided sample as it will be played in Sequencer mode. If there is obtrusive noise or if the attack is not sound cleanly, return to step ⑦ and adjust the "Start" and "End" addresses, etc.

- ⑩ Set "**Save with**" to specify the data that will be created simultaneously when you press the **Save** button to save the samples

**Program:** If this check box is **checked**, the multisample will be converted to a program when you save it. Specify the destination program number.

**Stereo** In the case of a stereo sample, the program pan will automatically be set. This allows the stereo position in Sampling mode to be reproduced by the program.

**Seq.Event:** If this check box is **checked**, sequence data to play the sliced samples will automatically be created after the data is saved. You can specify whether the sequence data to play back the sliced samples will be created as track data or as pattern data. If pattern data is created, you can also assign the pattern to RPPR.

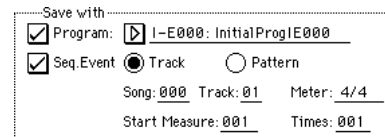

If you choose the **Track** radio button, track data will be created. Use "**Song**," "**Track**," and "**Meter**" to specify the song number, track number, and time signature of the data that will be created.

The track data that is created will start at the measure specified by "**Start Measure**," and will repeat for the number of times specified by "**Time**."

- ⚠ When track data is created, any data that had existed within the specified range of measures will be erased. Data outside this range will not be erased.

If you **check** both "**Program**" and "**Seq.Event**" and select the **Track**, the song parameter "**Program Select**" (Sequencer 0–1c/2c) will automatically be specified if the "**Start Measure**" is 001. Also, a program change will be created at the "**Start Measure**" location. In Sequencer mode you can select the song and play it back to hear the result immediately. Normally you will check both of these boxes.

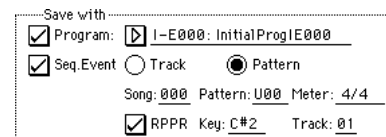

If you choose the **Pattern** radio button, pattern data will be created. Use "**Song**," "**Track**," and "**Meter**" to specify the song number, pattern number, and time signature of the data that will be created.

**RPPR:** If you **check** the check box, pattern data to play the sliced samples will be assigned to RPPR when you save. Use "**Key**" and "**Track**" to specify the key and track that will be created.

If "**Program**," "**Seq.Event**," and "**RPPR**" are **all checked**, the song parameters "Program Select" (Sequencer 0–1c/2c) and "RPPR ON/OFF" (Sequencer 0–1a) will both be specified automatically. "RPPR ON/OFF" will be turned on.

In Sequencer mode you can select the song and pattern to play back the results immediately. If "RPPR" is checked, pressing the specified key will play the pattern. Normally you will check both of these boxes.

**note** In some cases, the sample End address setting etc. may increase the number of measures in the pattern, so that it no longer loops precisely. In such cases, re-specify the "Length" in Sequencer mode "Pattern Parameter" (Sequencer 6-1c).

**note** If you use "Seq.Event" and "Start Measure" 001, the "Tempo" (⌘0-1c) of the track data or pattern data that is created will be the value specified by "New BPM" if you executed Time Stretch. If you did not execute Time Stretch, the tempo will be the value specified for "Source BPM."

If you set "Start Measure" to 001 and create a track, and if a tempo event exists only at the beginning of the master track, the tempo of that event will also be the value that you specified as "New BPM" or "Source BPM."

**!** If you save to a song that already contains data, the time-sliced samples may not play back in the same way as original sample if the time signature is different. You must set a matching time signature in the master track.

⑪ If you wish to save, press the **Save button**. If you decide not to save, press the **Cancel button**. When you save, the samples and multisample will automatically be saved to vacant samples and multisamples.

**[Stereo]** In the case of stereo samples, the samples and multisample will be saved in stereo.

⑫ By repeating steps ⑥-⑪ you can create as many samples and multisamples as desired.

⑬ Press the **Exit button** to exit the Time Slice command.

**!** If you exit Time Slice without using the Save button to save the samples and multisamples, be aware that the samples and multisamples you create will be lost.

**!** Before executing Time Slice on a long sample, you should first divide the sample into measures. In some cases, it may not be possible to assign the sample to the keyboard or create sequence data.

Time Slices requires vacant samples, multisamples, and relative parameters in order to execute. Be sure that there is sufficient free area before you execute. If there is insufficient free area, an error will occur.

**note** If you open the Time Slice dialog box on the same sample, it will be sliced in the same way as previously. These slice locations will also be used if you execute **Slice** in "Time Stretch" (⌘2-1C), so that you can execute Time Stretch without having to make the settings again.

If you wish to detect the attacks again or to re-do the operation, change the "Sensitivity" after you open the dialog box.

### 2-1C: Time Stretch

Time Stretch is a function that modifies the tempo by lengthening or shortening a sample without changing its pitch. This is convenient when you wish to change the tempo of a rhythm loop (drums) or a melodic sample (e.g., vocal, strings, winds) to match the tempo of another sample or of the sequencer. The Triton provides two ways in which Time Stretch can be executed. This command also supports stereo samples.

#### Sustaining

This type is suitable for sustained sounds such as vocal or instruments. Using it to change the tempo of phrases such as guitar or piano will also produce good results.

#### Slice

This type is suitable for decay-type instruments such as drums. Using it to change the tempo of drum or percussion loops will produce good results with minimal effect on the attack.

**note** It is possible to change the pitch when you adjust the tempo of a rhythm loop or similar sample. ("Pitch BPM Adjust" ⌘3-1A, "Detune BPM Adjust" ⌘Combination 2-3A, Sequencer 2-5A). You can create an interesting effect by raising or lowering the pitch of a drum sound.

#### To use Time Stretch (Sustaining)

① Select the sample that you wish to time-stretch using the **Sustaining** method.

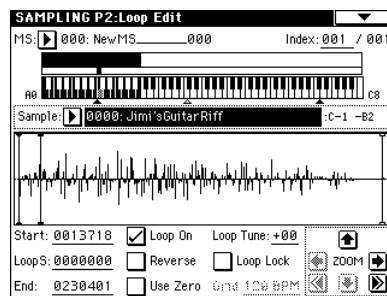

② Select the "Time Stretch" command to access this dialog box, where you can select the desired time stretch method.



③ Use the radio buttons to select **Sustaining**. Then press the **OK button** to execute, or the **Cancel button** to cancel without executing.

**[Stereo]** If the L and R of a stereo sample are different in length, blank data will automatically be added to the end of the shorter sample so that it matches the longer side.

④ A dialog box for executing Time Stretch will appear.



⑤ Set "Quality" to specify the desired audio quality of the sample produce by Time Stretch. The range is 0-7. Although it will depend on the sample, higher settings will produce better results. However, be aware that higher settings will also require a longer time to execute. Since you can try this as many times as you like, you should normally start with about 4, and raise or lower the setting gradually.

⑥ Set the proportional length of the sample that will be created by Time Stretch.

- **To specify the length as a ratio**

Set "Ratio." The available range is 50.00%–200.00%. If you specify 50.00%, the sample length will be halved. (The tempo will double.) If you specify 200.00%, the sample length will double. (The tempo will be halved.)

- **To match an existing BPM tempo value**

Set "Beat" as the number of quarter-note beats. When you change "Beat," the "Source BPM" value will be changed automatically.

"Source BPM" will indicate the playback BPM value at the original key. This BPM value is automatically calcu-

lated according to the length from the start address to the end address (if loop is off) or from the loop start address to the end address (if loop is on). If you already know the BPM value and the calculated value is incorrect, change it to the correct value.

Use “**New BPM**” to specify the BPM value of the sample you wish to create. “**Ratio**” will automatically be calculated from the “**Source BPM**” and “**New BPM**” values. For example if you have a one-measure 120 BPM sample in 4/4 time, and would like to change it to 150 BPM, you would set “**Beat**” to 4. The “**Source BPM**” will be calculated automatically. If the “**Source BPM**” is not calculated as 120 due to inaccuracies in the start address (or loop start address) or end address, adjust “**Source BPM**” to the correct value of 120.

Next, set “**New BPM**” to 150. The “**Ratio**” will be calculated automatically.

- ⚠ It is not possible to make settings that would cause “**Source BPM**” or “**New BPM**” to exceed the range of 40–480.  
It is not possible to make settings that would cause “**Ratio**” to exceed the range of 50.00–200.00.
- ⚠ Depending on the sample, the length may not be exactly as you specify, due to limitations in processing accuracy.
- ⑦ To execute the Time Stretch operation, press the **OK button**. To cancel without executing, press the **Cancel button**.  
When you press the **OK button**, the Time Stretch dialog box will appear.

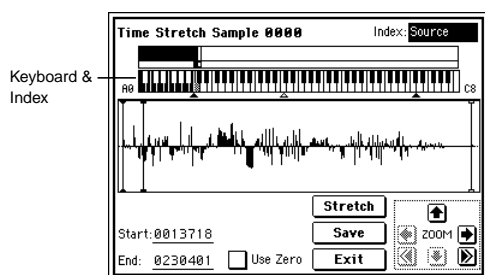

- ⑧ Audition the sample that was created by Time Stretch. The sample before being time-stretched is assigned to the C2 note of the keyboard, and the sample that was time-stretched is assigned to C#2. You can change the “**Index**” to check the waveform.

**Keyboard & Index:** This shows the multisample that is used temporarily in this dialog box.

When you play the keyboard, this multisample will sound. It will behave just as in normal pages (e.g., the Recording page). (☞0–1a)

[Stereo] In the case of a stereo sample, a stereo multisample will be used temporarily. The sample at each index will sound in stereo.

**Index** [Source, Result]:

Selects the index for the sample whose waveform you wish to display.

If you select **Source**, the original waveform before time-stretching will be selected.

If you select **Result**, the time-stretched sample will be selected.

- note** You can also select the index by holding down the [Enter] key and pressing a note on the keyboard. The index that includes that note will be selected.

**Sample waveform display:** This shows the waveform of the selected sample. As in 2-1: Loop Edit, the Start, Loop Start, and End addresses are shown by a solid line.

[Stereo] In the case of a stereo sample, the L channel sample data will be displayed above, and the R channel data below.

**ZOOM:** This controls horizontal and vertical zoom in/out for the waveform shown in the “sample waveform display.” (☞1–1c)

**Start:**

**End:**

Specify the start address and end address of the sample for the currently selected index.

When you execute Time Stretch, the addresses will be specified automatically, but the playback may be slightly skewed due to inaccuracies in the end address, etc. If this occurs, you can correct the addresses manually.

- ⚠ When you change the start address, the loop start address will also be changed simultaneously. If you wish to independently adjust the start address and loop start address, save the data in step ⑩, and then make settings in the P2: Loop Edit page.

- note** To audition the sound in the specified range, play the keyboard or press the SAMPLING [START/STOP] key. When you press the SAMPLING [START/STOP] key, the sample in the range specified by “**Start**” and “**End**” will sound at the original key.

**Use Zero:** (☞1–1c)

- ⑨ If you press the **Stretch button**, the Time Stretch dialog box will appear, and you can re-do the time stretch once again. Execute Time Stretch as described in step ⑥.
- ⑩ Save the sample that you created. Press the **Save button**, and the Save dialog box will appear.

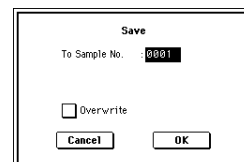

In “**To Sample No.**,” specify the save destination sample number. By default, an unused sample number will be selected. If “**Overwrite**” is checked, this cannot be selected.

The sample number cannot be specified if “**Overwrite**” is checked (☞p.101).

[Stereo] For stereo samples, use “**Save to No.(L)**” and “**(R)**” to specify the save-destination of the L and R channels.

To execute the Save operation, press the **OK button**. To cancel without saving press the **Cancel button**.

- ⑪ By repeating steps ⑨–⑩ you can create more samples as desired.
- ⑫ Press the **Exit button** to exit the Time Stretch operation. The index will specify the last-saved sample number.

- note** If you wish to use the saved sample in Program mode or Sequencer mode, you must either execute “**Convert MS to Program**” (☞0–1G), or use Program mode “**Multisample Select**” (☞Program P1–2) to select the multisample and create a program.

- ⚠ Be aware that if you exit Time Stretch without using the **Save button** then press the **OK button** to save the sample, the sample(s) you created will be lost.

- Time Stretch requires vacant samples, multisamples, and relative parameters in order to execute. Before you execute, make sure that there is sufficient free space. If there is not, an error will occur.

**To use Time Stretch (Slice)**

- Select the sample that you wish to time-stretch using the **Slice** method

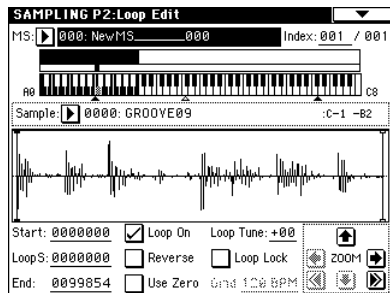

- Select the **Time Stretch** command from the Page Menu to access this dialog box, where you can select the desired time stretch method.



- Use the radio buttons to select **Slice**. Then press the **OK** button to execute, or the **Cancel** button to cancel without executing.

**Stereo** If the L and R of a stereo sample are different in length, blank data will automatically be added to the end of the shorter sample so that it matches the longer side.

- A dialog box for executing Time Stretch will appear.



- Specify the number of quarter note beats and tempo of the currently selected sample. If you already know the BPM value, set "Source BPM." If you do not know the BPM, setting "Beat" will cause the BPM to be calculated automatically. The settings here are also used as the reference values when detecting the attacks at which the sample is divided.

**Beat:** Specify the number of quarter note beats. When you change "Beat," the "Source BPM" will indicate the BPM value for playback at the original key. This BPM value is automatically calculated according to the length from the start address to the end address (if loop is off) or from the loop start address to the end address (if loop is on). If you already know the BPM value and the calculated value is incorrect, change "Source BPM" to the correct value.

For example if you have a one-measure 120 BPM sample in 4/4 time, you would set "Beat" to **4**. The "Source BPM" will be calculated automatically. If the "Source BPM" is not calculated as 120 due to inaccuracies in the start address (or loop start address) or end address, adjust "**Source BPM**" to the correct value of **120**.

**Source BPM:** Specify the tempo at the original key of the original waveform.

- "Source BPM" cannot be set or displayed outside the range of 40–480.

- Set the proportional length of the sample that will be created by Time Stretch.

- To specify the length as a ratio**

Set "**Ratio**." The available range is **50.00%–200.00%**. If you specify **50.00%**, the sample length will be halved. (The tempo will double.) If you specify **200.00%**, the sample length will double. (The tempo will be halved.) The tempo of the sample created by execution will be calculated automatically from the "Ratio" and "Source BPM," and displayed in "New BPM."

- To match a desired BPM tempo value**

Set "New BPM" to the desired BPM value of the sample that will be created. "Ratio" will automatically be calculated from the "Source BPM" and "New BPM" values.

- It is not possible to set or display "New BPM" outside the range of 40–480. It is not possible to set or display "Ratio" outside the range of 50.00–200.00.

- To execute Time Stretch, press the **OK** button. To cancel without executing, press the **Cancel** button. When you press the **OK** button, the attacks will be detected and the sample will be divided automatically, and time stretch will be performed.

The Time Stretch dialog box will appear.

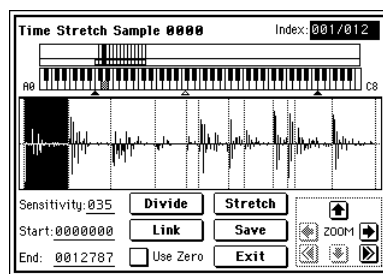

- Audition the results that were created by Time Stretch. The sample before being time-stretched is assigned to the C2 note of the keyboard. The time-stretched sample is assigned to C#2. Sliced (divided) samples will be assigned consecutively upward, starting from D2 on the keyboard.

**Index** [Source, Result, xxx(001...090)/yyy(001...090)]: Selects the index for the sample whose waveform you wish to display.

If you select **Source**, the original waveform before time-stretching will be selected.

If you select **Result**, the time-stretched sample will be selected.

If you set this to **xxx/yyy**, an individually sliced sample will be selected. **xxx** is the selected index, and **yyy** indicates the total number of sliced samples. A maximum of 90 samples can be assigned to the keyboard. If the sample was sliced into more than 90 samples, this will be displayed as 90.

- note** You can also select an index by holding down the [Enter] key and playing a note on the keyboard. The index that includes that note will be selected.

- When you execute Time Stretch, the addresses will be specified automatically. However, playback may be slightly offset due to inaccuracies in the end address, etc. If this occurs, set "Index" to Result, and use "Start" and "End" to re-specify the addresses.

**Keyboard & Index:** This shows the multisample that is temporarily used in this dialog box.

When you play the keyboard, this multisample will sound. It will act in the same way as in normal pages (e.g., the Recording pages). (E<sup>ST</sup>0–1a)

**Stereo** In the case of a stereo sample, a stereo multisample will be used temporarily. The sample of each index will sound in stereo.

**Sample waveform display:** This displays the waveform of the selected sample. If the "Index" is other than **Result**, the locations at which the sample is sliced will be indicated by a dotted line (vertical). If "Index" is set to **xxx/yyy**, the sample of the selected index will be highlighted. If "Index" is other than **xxx/yyy**, the Start, Loop Start, and End addresses will be indicated by solid lines (vertical).

**[Stereo]** In the case of a stereo sample, the L channel sample data will be displayed above, and the R channel sample data will be displayed below.

**ZOOM:** Here you can zoom in/out vertically and horizontally on the waveform displayed in the "sample waveform display." (☞ 1-1c)

- ⑨ If the slice locations are not appropriate, use "Sensitivity" to modify the sensitivity at which the attacks are detected, thus changing the slice locations.

Sensitivity [00...30]:

Start:

End:

Use Zero:

Divide:

Link:

Refer to "2-1B: Time Slice" steps ⑥ and ⑦. (☞ 2-1B)

- ⑩ When you press the **Stretch** button, the Time Stretch dialog box will appear, and you can re-do the time stretch. Execute Time Stretch using the same procedure as in step ⑤. If the sample slice locations are not appropriate, this will also affect the result of Time Stretch. For details on setting the slice locations, refer to "2-1B: Time Slice," steps ⑥ and ⑦. (☞ 2-1B)
- ⑪ Save the sample you created. Press the **Save** button, and the Save dialog box will appear.

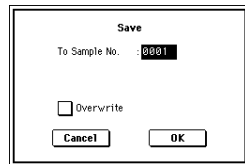

In "To Sample No.," specify the save destination sample number. By default, an unused sample number will be selected. If "Overwrite" is checked, this cannot be set. If you wish to delete the original sample data and overwrite it with the edited sample, check "Overwrite."

- ⚡ If you execute this command with "Overwrite" checked, the original sample data will be deleted, and overwritten by the edited sample data. Thus, in the Time Stretch dialog box that appears after execution, the edited sample data will automatically have its attacks detected and sliced, and displayed in "Index" **Source**.

**[Stereo]** For stereo samples, use "Save to No.(L)" and "(R)" to specify the save-destination of the L and R channels.

To execute the Save, press the **OK** button. To cancel without executing, press the **Cancel** button.

- ⑫ By repeating steps ⑩-⑪ you can create more samples as desired.
- ⑬ Press the **Exit** button to end the Time Stretch operation. The last-saved sample number will be set for the index.

**note** If you wish to use the saved sample in Program mode or Sequencer mode, you must either execute "Convert MS to Program" (0-1G), or use Program mode "High Multisample," "Low Multisample" (Program P1: 1-2a/2b) to select the multisample and create a program.

- ⚡ Be aware that if you exit Time Stretch without using the **Save** button then press the **OK** button to save the sample, the sample(s) you created will be lost.

- ⚡ Before executing the Slice on a long sample, you should first divide the sample into measures. In some cases, it may not be possible to assign the sample to the keyboard or edit the slice locations.

Time Stretch requires vacant samples, multisamples, and relative parameters in order to execute. Before you execute, make sure that there is sufficient free space. If there is not, an error will occur.

**note** If you open the time slice (Slice) dialog box on the same sample, it will be sliced in the same way it previously was. These slice locations will also be used if you execute "Time Slice" (2-1B), so that you can execute time stretch without having to make the settings again. If you wish to detect the attacks again or to re-do the operation, change the "Sensitivity" after you open the dialog box.

## 2-1D: Crossfade Loop

When looping a pitched instrument sample of a complex sound such as strings or woodwinds to make the sound sustain, it is necessary to create a long loop to preserve the rich character of the sound. Crossfade Loop can be used to minimize the difference in sound between the two regions to create a natural-sounding loop.

In order to solve such problems, Crossfade Loop causes the sound to change gradually from the end to the beginning of the loop.

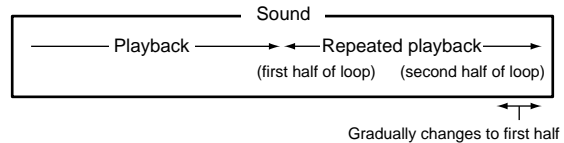

In actuality, the sample data is created as follows. A specific length (the "Crossfade Length") of the waveform immediately before the beginning of the loop is taken and mixed with the end portion.

At this time, the waveform level of the portion immediately before the end (the length specified by "Crossfade Length") will gradually decrease, and the waveform level immediately before the beginning of the loop will gradually increase as the two are mixed.

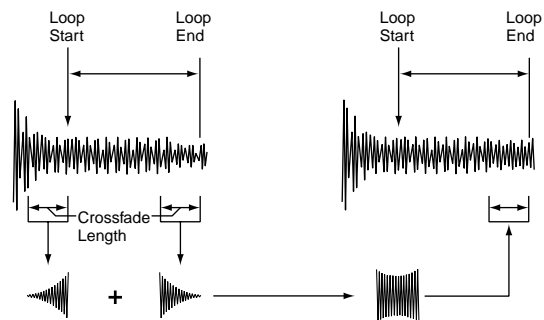

- ① Select the sample that you wish to Crossfade Loop.
- ② Select "Crossfade Loop" to access the dialog box.

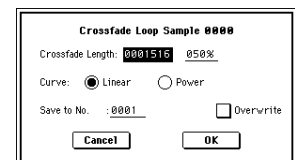

- ③ In “**Crossfade Length**,” specify the length of the sample that you wish to crossfade. If you set this as %, “Crossfade Length” will be calculated automatically. Specify the proportion of the “Crossfade Length” relative to the length between the loop start and loop end. If you set this to **50%**, crossfade will be performed on the second half of the region between loop start and loop end.

 If the length from the beginning of the sample to the loop start is shorter than the length from the loop start to the loop end, “Crossfade Length” can be set only up to the length from the beginning of the sample to the loop start. In this case, a setting of 100% will not be possible.

- ④ Set “**Curve**” to specify how the volume will change in the crossfaded region.

**Linear:** The volume will change linearly.

**Power:** The volume will change non-linearly. Sometimes a setting of Linear will produce the impression that the volume has dropped in the middle of the curve. In such cases, use Power.

- ⑤ In “**Save to No.**,” specify the save destination sample number. By default, an unused sample number will be selected.

The sample number cannot be specified if “Overwrite” is checked (p.101).

 For stereo samples, use “Save to No.(L)” and “(R)” to specify the save-destination of the L and R channels.

- ⑥ To execute Crossfade Loop, press the **OK button**. To cancel without executing, press the **Cancel button**.

## Sampling P3: Multisample

Here you can make settings for multisamples. You can create indexes for a multisample, and then assign a sample to each index. (These basic settings can also be performed in P0: Recording page) In addition, you can delete, copy, or insert an index, and perform detailed editing such as adjusting the level and pitch of the sample for each index.

### 3-1: Multisample

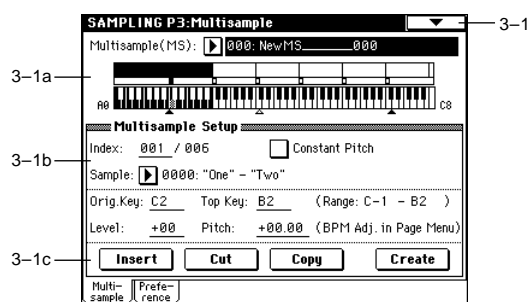

#### 3-1a: Multisample (MS), Keyboard & Index

**Multisample (MS)** [000...999]

Select the multisample that you wish to edit (p.0-1a).

#### Keyboard & Index

(p.0-1a)

#### 3-1b: Multisample Setup

**Index** [xxx (001...127)/yyy (001...127)]

Selects the index that you wish to edit (p.0-1a).

 You can also select an index by holding down the [ENTER] key and playing a note on the keyboard. The index that includes this note will be selected. The selected key will be the base key, and will be displayed in gray in “Keyboard & Index.”

#### Constant Pitch

**On (checked):** All notes in the zone of the index will sound at the pitch of the original key. Use this setting when you have sampled a drum sound or a rhythm loop, and want it to always playback at the original pitch.

**Off (unchecked):** The pitch will change in semitone steps, based on the original key. Use this setting when you have sampled a musical instrument sound etc. and would like to play it conventionally from the keyboard.

#### Stereo

This area will indicate “Stereo” if a stereo multisample or sample is selected, or if you sampled with a setting of **Stereo** in “**Sample Mode**” (0-1c) (p.0-1c).

**Sample** [----: ---No Assign----, 0000...3999]

This shows the number and name of the sample that is assigned to the selected index. You can also select a sample here (p.0-1b).

**Orig.Key (Original Key)** [C-1...G9]

Specifies the original key of the sample (p.0-1b).



## Top Key [C-1...G9]

Specifies the highest key in the zone of the index. The zone is defined by this "Top Key" (≡0-1b).

## Range

This shows the range of the zone that is determined by the "Top Key" setting. The selected sample data will playback within this area. Zone settings for an index can also be viewed in "Keyboard & Index" (≡0-1a).

## Level [-99...+99]

Adjusts the playback level of the sample. Use this when you need to adjust the level balance between samples within a multisample.

0: Unity level

-: The level will be lowered.

+: The level will be raised.

⚠ Since in Sampling mode the playback unity level will normally be the maximum level, adjustments in the + direction will have no effect. If **Volume (CC#07)** or **Expression (CC#11)** has been assigned to the ASSIGNABLE PEDAL or as the B-mode function of a REAL-TIME CONTROLS knob [1]-[4] and these controllers have been operated, or if these MIDI messages have been received to lower the playback unity level, then adjustments in the + direction will be valid. (≡Program P1: 1-2A, Sample Parameters: Level)

**note** The playback level will also be affected by the "+12 dB" (2-1c) setting. If "+12 dB" is on, the sample will playback approximately +12 dB louder.

## Pitch [-64.00...+63.00]

Adjusts the playback pitch of the sample in one-cent steps (≡p.11, Pitch).

0: The sample will sound at the original pitch when the original key is played.

-: The pitch will be lowered. At a setting of -12.00 the pitch will be one octave lower.

+: The pitch will be raised. At a setting of +12.00 the pitch will be one octave higher.

You can also use "Pitch" to make fine adjustments in the length of a rhythm loop. For example with a setting of +12.00, the playback speed will be doubled, and the loop playback time will be 1/2. (≡Program P1: 1-2A, Sample Parameters: Pitch)

**note** The "Pitch BPM Adjust" page menu command lets you set the playback time in terms of a BPM value (≡3-1A).

## 3-1c: Insert, Cut, Copy, Create

### Insert

This creates an index. When you press the **Insert button**, a new index will be created according to the "Position" setting (0-3a, 3-2a). At this time, the contents of the index that was cut or copied by "Cut" or "Copy" (i.e., the "Zone Range," "Original Key Position," "Level" and "Pitch") will be assigned at the same time. (The sample will automatically be copied or assigned to a different number.)

⚠ If it is not possible to create a new index when you execute "Create" or "Insert," a dialog box will appear. If this occurs, refer to "Create" (0-1b).

⚠ If you have not yet executed "Cut" or "Copy," such as immediately after power-on, the new index will be created according to the Create Zone Preference settings (0-3a, 3-2a) "Position," "Zone Range," and "Original Key Position."

### Cut

This deletes the selected index. At the same time, the contents of the deleted index are copied to the "Insert" buffer.

### Copy

This copies the content of the selected index to the "Insert" buffer.

### Create

This creates an index. When you press the **Create button**, a new index will be created according to the settings of "Position," "Zone Range," and "Original Key Position" (3-2a, 0-3a) (≡0-1b).

## ▼ 3-1: Page Menu Command

0-1A	Delete Sample	Convert MS To Program	0-1G
0-1B	Copy Sample	MS Mono To Stereo	0-1H
0-1C	Rename Sample	Sample Mono To Stereo	0-1I
0-1D	Delete MS	Keyboard Display	0-1J
0-1E	Copy MS	Pitch BPM Adjust	3-1A
0-1F	Rename MS	Move Sample	0-1K

### 3-1A: Pitch BPM Adjust

This command sets the "Pitch" (3-1b) of the selected index on the basis of a BPM value. Raising the pitch of sample playback will increase the playback speed. Lowering the pitch will slow down the playback speed. This can be used to match the loop length etc. of the sample to a tempo of the desired BPM value.

① Select "**Pitch BPM Adjust**" to access the dialog box.

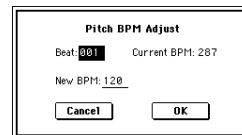

② Specify "Beat." This is specified in quarter-note beats.  
③ "Current BPM" will show the BPM value at the base key (displayed in gray). This BPM value is calculated automatically from the start address to the end address of the sample (if looping is off) or from the loop start address to the end address (if looping is on).

For example if the start and end address of the sample are two seconds apart, the original key is specified as the base key, and "Beat" is set to 4, "Current BPM" would be 120. If "Beat" is set to 2, the display would indicate "Current BPM" as 60.

⚠ It is not possible for this display to exceed the range of 40-480.

④ In "New BPM," specify the BPM value that will result from the conversion of the "Current BPM" value.  
⑤ To execute the Pitch BPM Adjust command, press the **OK button**. To cancel, press the **Cancel button**.

When you execute this command, the "Pitch" (3-1b) value will be set automatically. For example if you modify a quarter-note 120 BPM sample to 240 BPM, the "Pitch" will be set to +12.00.

⚠ This calculation is performed within the TRITON STUDIO's limits of precision. Minor discrepancies may occur in the final BPM calculation.

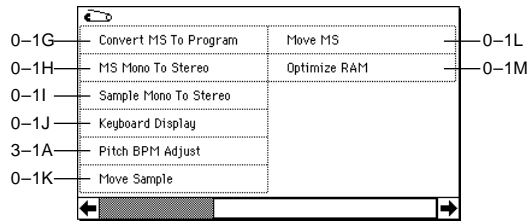

### 3-2: Preference

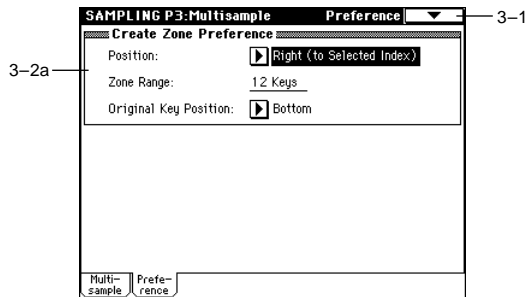

#### 3-2a: Create Zone Preference

Here you can specify the default settings for indices that are created by executing "Create" (3-1c, 0-1b). New indexes will be created according the settings you specify here. You are free to modify the settings of an index later. Also, when you execute "Insert" (3-1c), the "Position" setting specified here will be used. (See *Create Zone Preference*: 0-3a)

## Sampling P4: Controller Setup

### 4-1: Controller Setup

Specifies the functions that the [SW1] key, [SW2] key, and the B-mode functions of the REALTIME CONTROL knobs [1]-[4] will have in Sampling mode.

**!** In Sampling mode, it is not possible to use AMS to control program parameters.

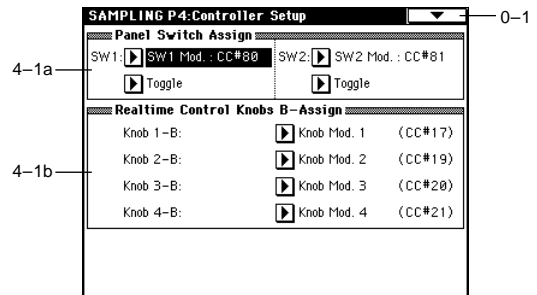

#### 4-1a: Pannel Switch Assign

Assigns the functions of the [SW1] and [SW2] keys ("SW1, SW2 Assign List" p.249).

SW1 (SW1 Assign)	[Off...After Touch Lock]
SW1 Mode	[Toggle, Momentary]
SW2 (SW2 Assign)	[Off...After Touch Lock]
SW2 Mode	[Toggle, Momentary]

Program P1: 1-4a

#### 4-1b: Realtime Control Knobs B-Assign

Assigns the B-mode functions (mainly various types of control change) for the REALTIME CONTROL knobs [1]-[4] ("Realtime Control Knobs B-Assign List" p.250). The functions you specify here will operate when the REALTIME CONTROL knobs [1]-[4] are operated in B-mode.

Knob 1-B	[Off...MIDI CC#95]
Knob 2-B	[Off...MIDI CC#95]
Knob 3-B	[Off...MIDI CC#95]
Knob 4-B	[Off...MIDI CC#95]

Program P1: 1-4b

These controllers can be used to make realtime changes in effect dynamic modulation functions etc. while you sample.

#### Example settings

Sample an external audio signal while using knob [1] (B-mode) to adjust the "Wet/Dry" balance of 044: Stereo/Cross Delay (assigned to IFX1) and knob [2] (B-mode) to adjust the post-IFX "Pan" in realtime.

- ① Set "BUS (IFX) Select" (0-2a) to IFX1.
- ② Select 044: Stereo/Cross Delay for "IFX1."
- ③ Set the IFX1 page "Wet/Dry" setting to Dry, "Src" to KnobM1[+], and "Amt" to +50.
- ④ In *Realtime Control Knobs B-Assign*, set "Knob 1-B" to Knob Mod.1 (CC#17), and set "Knob 2-B" to Post IFX Pan (CC#08).

- ⑤ Press the [REALTIME CONTROLS] key to make the “B” LED light.
- ⑥ Rotate knob [1], [2] and the panning of the external input sound and the delay will change. You can sample the sound while you modify it.

## Sampling P5: Audio CD

### 5-1: Audio CD

Here you can sample the playback of an audio CD, or copy digital information from an audio CD (“ripping”).

Sound can be sampled from an audio CD in the following two ways.

- The analog audio output from an audio CD played in the CDRW-1 option (if installed) is internally connected to the AUDIO INPUT jacks. If you are using a CD-R/RW drive connected to the SCSI connector, use audio cables to connect the drive to the AUDIO INPUT jacks. In either case, the procedure is the same as when sampling analog audio from the AUDIO INPUT jacks. The audio will play back on the TRITON STUDIO according to the “**Input Analog** (0-2a) settings. Set “Level,” “BUS (IFX/Indiv.) Select” (normally set to L/R) for *Input1* (L channel) and *Input2* (R channel).
- A certain passage of digital audio information stored on audio CD (played in the installed CDRW-1 or a CD-R/RW drive connected to the SCSI connector) can be acquired in its digital state and saved as a sample. This “ripping” function allows you to bypass the usual Digital-to-Analog and Analog-to-Digital converters and preserve the digital signal in its original state. Digital ripping is executed by the page menu command “Destination” (5-1A).

⚠ Some CD-R/RW drives do not support ripping (i.e., a CD-R/RW drive that does not read CD-DA data). In this case, the display will indicate “Error in reading from medium.”

Use the various SEQUENCER keys to control the audio CD.

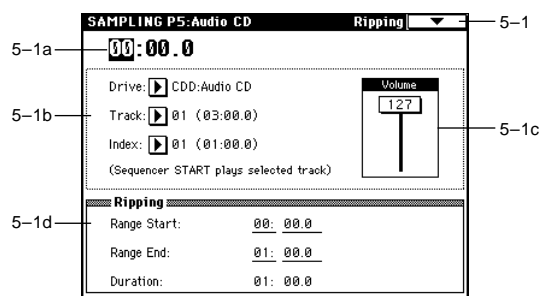

- SEQUENCER [START/STOP] key : play/stop  
 [FF>>] key : fast-forward  
 [<<REW] key : rewind  
 [PAUSE] key : pause  
 [LOCATE] key : return to the beginning of the track

⚠ If the CDRW-1 option is installed, playing the keyboard or operating the controllers during playback may produce physical shock that causes the playback to skip or reading errors to occur, preventing playback from occurring normally.

#### 5-1a: Location

**Location** [00:00.0...]

Indicates the current location of the track being played (“Track”). When stopped, this indicates the location at which playback will begin. If you re-select “Track” or “Index,” this will be 00:00.0.

## 5-1b: Drive, Track, Index

**Drive (Drive select)** [ID0...6, CDD: Name]

Selects the CD-R/RW drive that contains the audio CD that you want to play or rip.

 Drives other than a CD-R/RW drive cannot be selected here.

**Track (Track Select)** [01...]

Selects the track of the audio CD that you want to play or rip.

**Index** [01...]

Selects the index of the audio CD that you want to play or rip. This can be selected only if you have selected a track that contains index data.

 In the case of some CD-R/RW drives, index information cannot be obtained.

## 5-1c: Volume

**Volume** [0...127]

Adjusts the volume of the audio signal that is output from the CD-R/RW drive.

 Some CD-R/RW drives do not support this, meaning that this adjustment may not affect the volume.

## 5-1d: Ripping

Makes settings for ripping data from a CD. If the cursor is located at "Range Start" or "Range End," CD playback will occur from "Range Start" to "Range End." Ripping is executed in the page menu command "Destination" (5-1A).

**Range Start** [00:00.0...]

Specify the starting location of the data that will be ripped. When you re-select "Track" or "Index," this will be reset to 00:00.0.

**note** If the cursor is located at "Range Start" or "Range End," pressing the [ENTER] key during playback will set "Range Start" or "Range End" to the timing of that moment. If you press the [ENTER] key two or more times, the location at which the key was last pressed will be specified.

If cursor is located at other than "Range Start" or "Range End," pressing the [ENTER] key once will specify "Range Start," and pressing it once again will set "Range End." If you press the [ENTER] key three or more times, the "Range Start" and "Range End" will be set to the locations of the last press and the last-but-one press.

**Range End** [00:00.0...]

Specifies the ending location of the data that will be ripped. When you re-select "Track" or "Index," this will be reset to the ending time of the selected track or index.

**Duration** [00:00.0...]

Displays the length of time between "Range Start" and "Range End."

## ▼ 5-1: Page Menu Command

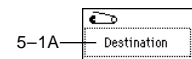

### 5-1A: Destination

Specifies the writing data of the ripped data, and execute ripping. Ripping will create a stereo 44,100 Hz sample. You can rip to sample memory (RAM), hard disk, floppy disk, or a removable disk (sold separately) connected to the SCSI connector. If you select **Disk**, a WAVE file will be created.

 If the CDRW-1 option is installed, playing the keyboard or operating the controllers during ripping may produce physical shock that causes data skips or reading errors, preventing ripping from occurring normally.

#### Ripping to sample memory (RAM)

- ① Select "**Destination**" to access the dialog box.
- ② In the "**To**" field, select **RAM**.

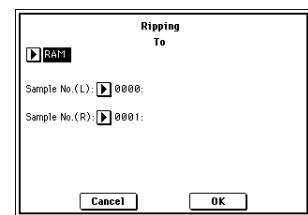

- ③ In "**Sample No.(L)**" and "**Sample No.(R)**," specify the destination to which the stereo sample data created by ripping will be written. By default, the lowest-numbered vacant sample will be displayed. Normally you will leave this default setting unchanged.
- ④ Press the **OK button** to execute ripping, or press the **Cancel button** to cancel without executing.

#### Ripping to the hard disk or other disk

- ① Select "**Destination**" to access the dialog box.
- ② In the "**To**" field, select **DISK**.

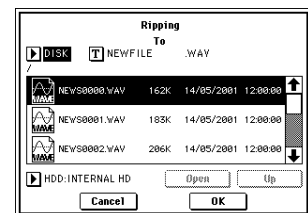

- ③ Specify a name for the WAVE file that will be saved.
- ④ In "**Drive select**," select the hard disk or other disk to which the data will be saved.
- ⑤ Use the **Open button** and **Up button** to select the desired directory on the save-destination disk.
- ⑥ Press the **OK button** to execute ripping, or press the **Cancel button** to cancel without executing.

## Sampling P8: Insert Effect

Here you can make insert effect settings for use in Sampling mode.

If you want to apply insert effect IFX1-5 to the external audio signal specified by "Input" and sample the result, set the P0: Recording, Input/Setup page **Input1** and **Input2** "BUS (IFX/Indiv.) Select" parameters to IFX1-5, and adjust the effect settings.

If you want to apply effects to a previously-sampled sample or a sample you loaded, and resample the result, set the P8: Insert Effect page "BUS (IFX) Select" parameter to IFX1-5, and adjust the effect settings. (☞ "Resample" 0-2b)

☞ For details on insert effects, refer to p.178 "8. Effect Guide."

⚠ In Sampling mode, master effects 1 and 2 and the master EQ cannot be used.

**note** Insertion effect settings in Sampling mode are not backed up when the power is turned off. If you wish to keep the insertion effect settings, you can use "Copy Insert Effect."

For example, you can copy the insertion effect settings of Sampling mode to a program or combination in order save them. When you write the program or combination, the settings will be saved in internal memory. In Sampling mode, you can use "Copy Insert Effect" (8-1A) to copy these effect settings from the program or combination back into Sampling mode and use them.

### 8-1: Routing

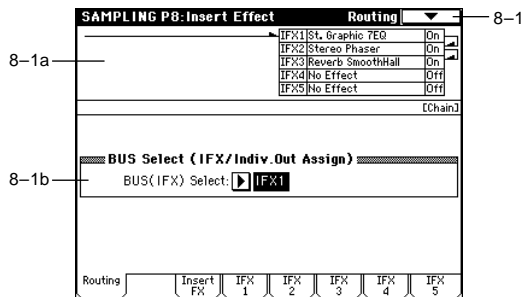

#### 8-1a: Routing Map

##### Routing Map

This displays the status of the insert effect settings. Insert effect routing, the name of the specified effect, on/off, and chain are displayed. Insert effect type, on/off, and chain settings are made in the P8: Edit-Insert Effect, Insert FX page.

#### 8-1b: BUS Select

**BUS(IFX) Select** [L/R, IFX1...5, 1...4, 1/2, 3/4, Off]

Selects the bus.

If you want to apply an effect to a sample (multisample) that you sampled or loaded, select IFX1-5. (☞ "Resample" 0-2b)

⚠ After you resample, L/R will automatically be selected as the "BUS (IFX) Select" setting. Be aware of this when you want to resample again.

### 8-1: Page Menu Command

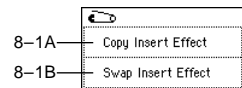

#### 8-1A: Copy Insert Effect

☞ "Program P8: 8-1A: Copy Insert Effect."

#### 8-1B: Swap Insert Effect

☞ "Program P8: 8-1B: Swap Insert Effect."

### 8-2: Insert FX

Here you can select insert effects, switch them on/off, make chain settings, and specify the pan of the sound after passing through the insert effect.

These parameters are the same as in Program mode. Refer to Program mode "8-2: Insert FX"

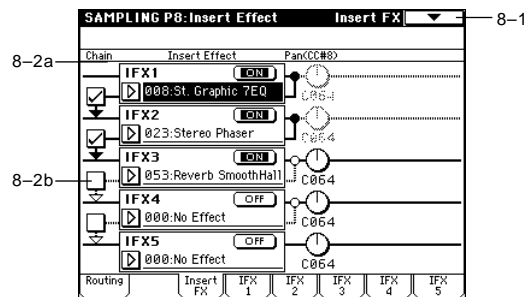

#### 8-3: IFX 1

#### 8-4: IFX 2

#### 8-5: IFX 3

#### 8-6: IFX 4

#### 8-7: IFX 5

Set the effect parameters for the IFX 1, 2, 3, 4 and 5 effects that you selected in the Insert FX page (☞ p.187-).

**note** Effect Dmod (dynamic modulation) is controlled by the global MIDI channel specified in Global Mode P1.

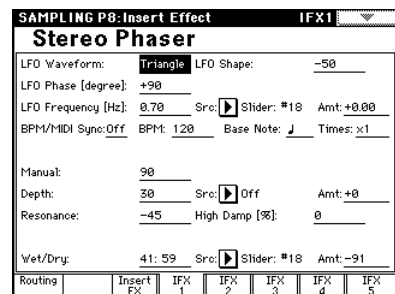

# 5. Song Play mode

In Song Play mode you can load Standard MIDI Files (SMF) from floppy disk, the internal hard disk or external SCSI device, or play them directly as they are being loaded. A jukebox function is provided to playback these SMF files in any order you specify. You can also use the arpeggiator or realtime controllers during playback. In Song Play mode you can playback SMF data and make related settings. The TRITON STUDIO is able to playback SMF **format 0** or **format 1** data.

## Song Play P0: Prog/Mix

0-1: Prog. 1-8 (Program T01-08)

0-2: Prog. 9-16 (Program T09-16)

Here you can make settings for SMF playback, and make basic settings such as selecting the program for each track.



0-1a: Location, Meter, Tempo, Jukebox, File, Play

**Location** [001:01.000...999:16.191]

This is the current location within the SMF. From the left, this indicates the measure (Location Measure), beat (Location Beat), and clock (Location Tick). You can set each of these individually, and this will move the current location within the song.

**MIDI** When you change the location, a Song Position Pointer message will be transmitted.

**Meter** [\*/\*, 1/4...16/16]

This indicates the time signature at the current location of the SMF.

**Tempo** [040...240]

Specifies the playback tempo of the SMF. In Song Play mode, this tempo will be used regardless of the "MIDI Clock" setting (Global P1: 1-1a).

**Jukebox** [Off, On]

**On (checked):** SMF files in the jukebox list will be played back in succession. You will also check this when you wish to create a jukebox list. In the Jump menu (displayed when you press the [MENU] key), select P3: Jukebox, and create the list.

**File (File select)** [000...999]

From a floppy disk etc., select the SMF that you wish to play back.

You can select SMF files from the currently selected directory. If you wish to select from another directory, use the P3: Select Directory to select the directory.

When "**Jukebox**" is **checked**, you can select SMF files from the jukebox list in the P3: Jukebox.

This parameter will not be displayed if there are no SMF files in the directory, or if no SMF files have been registered in the jukebox list.

**MIDI** If the CDRW-1 option is installed, and you play the keyboard or operate the controllers during playback, the physical shock may cause data skips or read errors, so that the playback may not occur correctly.

**Name**

This displays the song name of the SMF that you selected in "File (File select)."

**Play (Track Select)** [Track01 [Ch01]...Track16 [Ch16]]

Specifies the track (channel) that will sound when you play the keyboard.

The bank number, program number, and name of the program used by the track is displayed to the right.

**MIDI** In Song Play mode, MIDI channels 1-16 correspond to tracks 1-16.

0-1(2)b: Selected Track Information

This area displays information for the track (1-16) that is currently selected for editing or selected by "Play (Track Select)."

**T (Track)** (01...08 (09...16))

This displays the track number of the track currently selected for editing or selected by "Play (Track Select)," and the program bank, number, and name of the program specified for that track.

**Ch** (01...16)

This displays the MIDI channel number of the track that is currently selected for editing or selected by "Play (Track Select)."

0-1(2)c: Track Number, Category, Bank/Program, PLAY/MUTE, SOLO ON/OFF

**Track Number** (1...8 (9...16))

Displays the track number. Use the parameters below "Track Number" to make settings for that track number.

**Category** [00...15]

Selects a program for the track by category. Each program is classified into one of sixteen categories. You can press the category and select programs within that category. This is convenient when you want to find a program by category, or to select a different program within the same category.

## Program Select (Bank/Program)

[INT-A...INT-F, G, g(1)...g(9), g(d), EXB-A...EXB-G]

Selects the program that will be used by each track.

The lower line will display part of the program name.

If "Program Select" is selected, you can use the BANK [INT-A]-[EXB-G] keys and the VALUE controller to select the program.

When you press the popup button, the Bank/Track Program menu will appear, allowing you to select a program. (≡Program P0:0-1a)

**note** If "Program Select" is selected, the BANK key LED will light to indicate the program bank of the selected track.

**⚡** Bank INT-F can be selected if the EXB-MOSS option is installed. When this is installed, you will be able to use 128 special EXB-MOSS programs.

**MIDI** If "Status" (1-1a/2a) is either INT or BTH, you can select a program by receiving a MIDI program change. MIDI channels 1-16 will control tracks 1-16 respectively.

## PLAY/MUTE [PLAY, MUTE]

This sets the playback/mute status of each track.

The setting will alternate each time you press the **PLAY/MUTE button**.

**PLAY:** The track will play.

**MUTE:** The track will be muted.

## SOLO ON/OFF [SOLO OFF, SOLO ON]

Switches the Solo function on/off. Only the track set to **SOLO ON** will be heard. All other tracks will be muted.

**MIDI** If a track muted by the Mute or Solo function has a "Status" (1-1a/2a) of **EXT** or **BTH**, the MIDI note-on/off messages of that track will not be transmitted. (However, the track selected by "Play (Track Select)" (0-1a) is an exception.)

**⚡** If the page menu command "Solo Selected Track" (0-1B) is ON, its solo settings will take priority (when ON). When you press "SOLO ON/OFF" or press a parameter of another track, only that track will be soloed and will sound.

## GM Initialize Parameter

	Parameter	Track1-9, 11-16	Track10	
<b>P0</b>	Bank/Program	G001:Acoustic Piano	g(d)001:STANDARD Kit	
	Pan	C064	C064	
	Volume	100	100	
<b>P1</b>	Status	-	-	The setting remains unchanged
	Use Program's Scale	-	-	The setting remains unchanged
<b>P7</b>	Arpeggiator Assign	-	-	The setting remains unchanged
	Other Arpeggiator parameters	-	-	The setting remains unchanged
<b>P8</b>	IFX/Indiv.Out BUS Select	L/R	DKit	
	Send1(MFX1)	0	0	
	Send2(MFX2)	40	40	
	IFX1-5	-	-	The setting remains unchanged
	Pan(CC#8)	-	-	The setting remains unchanged
	BUS Select	-	-	The setting remains unchanged
	Send1	-	-	The setting remains unchanged
	Send2	-	-	The setting remains unchanged
	Other Insert Effect parameters	-	-	The setting remains unchanged
	<b>P9</b>	MFX1	-	-
MFX2		-	-	053: Reverb SmoothHall
Return1		-	-	127
Return2		-	-	050
Other Master Effect and Master EQ parameters		-	-	Default settings

## ▼ 0-1: Page Menu Command

0-1A	GM Initialize
0-1B	Solo Selected Track
0-1C	Load Template Song
0-1D	Save Template Song
0-1E	Set Location

### 0-1A: GM Initialize

This command transmits a GM System On message to Song Play mode, resetting all tracks to the GM settings (≡table below).

**MIDI** In Song Play mode when a GM System On message is received from an external device or if the SMF contains a GM System On message, the tone generator will be reset to the GM settings in the same way as when this command is executed (However even in these cases, the parameters of the P9: Master Effect will not be reset).

### 0-1B: Solo Selected Track

This command switches the solo function on and off. When switch on, only the selected track will sound and the remaining tracks will be muted (the Solo function). To solo a different track, select one of the parameters of that track (≡Sequencer P0: 0-1B).

**MIDI** If a track muted by the Mute or Solo function has a "Status" (1-1a/2a) of **EXT** or **BTH**, the MIDI note-on/off messages of that track will not be transmitted.

### 0-1C: Load Template Song

This command loads a preset template song (one of sixteen types P00-15) or a user template song (one of sixteen types U00-15) into the song (≡Sequencer P0: 0-1G).

## 0-1D: Save Template Song

This command saves the programs, the track parameters, and the effect settings etc. as a user template song U00-15 (☞Sequencer P0: 0-1H).

The settings that are saved here can also be loaded in Sequencer mode.

## 0-1E: Set Location

By pressing the [LOCATE] key you can move to the location specified here (☞Sequencer P0: 0-1J).

## 0-3: Mixer 1-8 (Mixer T01-08)

## 0-4: Mixer 9-16 (Mixer T09-16)

Set the pan and volume for each track (channel).

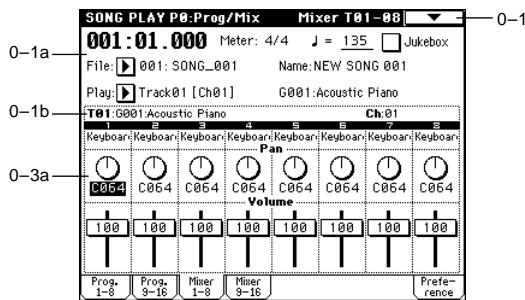

### 0-3(4)a: Track Number, Program Category, Pan, Volume

#### Track Number

Indicates the track number. (☞0-1c/2c)

#### Program Category

Displays part of the program category name used by the track.

#### Pan

[RND, L001...C064...R127]

Sets the panning for each track (channel) 1-16 (☞Sequencer P0: 0-3b).

**MIDI** Tracks whose "Status" (1-1a/2a) is **INT** or **BTH** can receive MIDI control change (CC#10) to control the panpot. When receiving CC#10, a value of 0 or 1 will be far left, 64 will be center, and 127 will be far right. Tracks 1-16 will be controlled by MIDI channels 1-16 respectively.

#### Volume

[0...127]

Sets the volume of each track (channel) 1-16.

**MIDI** Tracks whose "Status" (1-1a/2a) is **INT** or **BTH** can receive MIDI control change (CC#7) to control the volume. The actual volume of a track is determined by multiplying the MIDI volume (CC#7) and expression (CC#11) values. Tracks 1-16 will be controlled by MIDI channels 1-16 respectively.

## 0-5: Preference

Here you can make settings for playing SMF files consecutively, and make settings for the metronome.

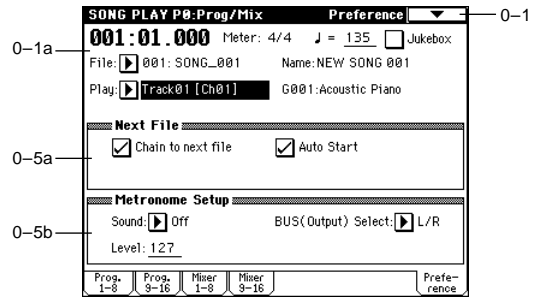

### 0-5a: Next File

Specifies whether or not the next file will be played back in succession when the currently selected SMF finishes playing.

#### Chain to next file

[Off, On]

**On (checked):** When the currently selected file finishes playing, the next file will automatically be selected.

#### Auto Start

[Off, On]

**On (checked):** When the currently selected SMF finishes playing, the next file will automatically begin playing. This is valid when "Chain to next file" is checked.

### 0-5b: Metronome Setup

Makes settings for the metronome.

#### Sound

[On, Off]

**On:** The metronome will sound during playback. The sound of the metronome will be output to the bus selected by "BUS Select."

#### BUS (Output) Select (BUS Select)

[L/R, L, R, 1, 2, 3, 4, 1/2, 3/4]

Specifies the output destination of the metronome sound (☞Sequencer P0: 0-7b).

#### Level

[000...127]

Sets the volume of the metronome.



## Song Play P1: Track

For each track, you can specify the status of the internal tone generator and the scale.

### 1-1: Status 1-8 (Status/Scale T01-08)

### 1-2: Status 9-16 (Status/Scale T09-16)

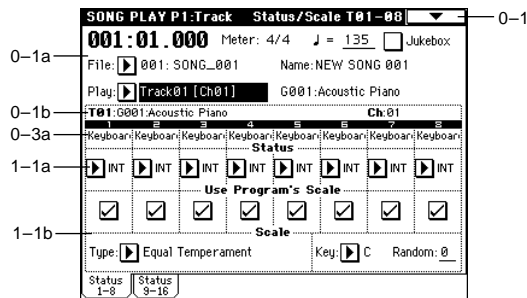

### 1-1(2)a: Status

**Status** [INT, Off, BTH, EXT]

Specifies whether each track will transmit/receive MIDI data and/or sound the internal tone generator.

**INT:** When you playback the musical data of this track, or operate the TRITON STUDIO's keyboard or controllers when "Play (Track Select)" (0-1g) is set to a track whose setting is INT, the TRITON STUDIO's internal tone generator will sound, but MIDI messages will not be transmitted to external devices.

**Off:** The program will not sound, nor will MIDI messages be transmitted.

**BTH:** The operations of both INT and EXT will occur. When you play the musical data of this track, or operate the TRITON STUDIO's keyboard or controllers when "Play (Track Select)" is set to a track whose setting is BTH, the TRITON STUDIO's internal tone generator will sound, and MIDI messages will also be transmitted to external devices.

**EXT:** When you playback the musical of this track, or operate the TRITON STUDIO's keyboard or controllers when "Play (Track Select)" is set to a track whose setting is EXT, MIDI messages will be transmitted to external devices, but the TRITON STUDIO's internal tone generator will not sound.

Status	Musical data Keyboard and controller operations		Received data	
	Internal tone generator	MIDI OUT	Internal tone generator	MIDI OUT
INT	●	×	●	—
EXT	×	●	×	—
BTH	●	●	●	—

### 1-1(2)b: Use Program's Scale/Scale

**Use Program's Scale** [Off, On]

For each track you can specify whether or not the scale specified for the program in "Scale" (Program P1: 1-1c) will be used.

**On (checked):** The scale specified by the program will be used.

**Off (unchecked):** The scale specified by "Scale" (1-1b/2b) will be used.

**Scale:**

Select the scale that will be used in Song Play mode.

**Type** [Equal Temperament...User Octave Scale15]

Selects the scale type (☞ "Type" Program P1: 1-1c).

**Key (Scale Key)** [C...B]

Selects the tonic key of the selected scale (☞ "Key" Program P1: 1-1c).

**Random** [0...7]

As this **value is raised**, an increasing amount of random deviation will be applied to the pitch at note-on (☞ "Random" Program P1: 1-1c).

### 1-3: MOSS 1-8 (MOSS Setup T01-08)

### 1-4: MOSS 9-16 (MOSS Setup T09-16)

This page is displayed only when the EXB-MOSS option has been installed.

For details refer to the EXB-MOSS owner's manual.

## Song Play P2: Controller Setup

Specifies the functions that the [SW1] key, [SW2] key, and the B-mode functions of the REALTIME CONTROL knobs [1]–[4] will have in Song Play mode. The functions you specify can be used when playing the track selected by “Play (Track Select).”

**MIDI** If the track you select in “Play (Track Select)” has a “Status” (1–1a/2a) setting of either **BTH** or **EXT**, operating a controller that has been assigned a CC# will cause MIDI control change (CC#) messages to be transmitted on the MIDI channel of that track.

### ▼ 2–1: Page Menu Command

0–1C	Load Template Song
0–1D	Save Template Song
0–1E	Set Location

## 2–1: Controller Setup (Preference)

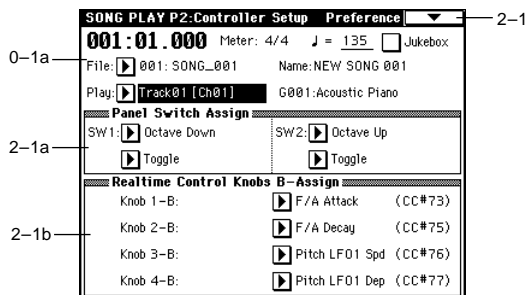

### 2–1a: Panel Switch Assign

Assigns the functions of the [SW1] and [SW2] keys. (“SW1, SW2 Assign List” p.249)

**⚠** Since the [SW1] and [SW2] functions of the program assigned to each track will not be valid, you can make new settings here.

SW1	<b>AMSource</b>	[Off, ..., After Touch Lock]
	Toggle/Momentary	[Toggle, Momentary]
SW2	<b>AMSource</b>	[Off, ..., After Touch Lock]
	Toggle/Momentary	[Toggle, Momentary]

Program P1: 1–4a

### 2–1b: Realtime Control Knobs B–Assign

Assigns the B-mode functions (mainly various types of control change) for the REALTIME CONTROL knobs [1]–[4] (“Realtime Control Knobs B–Assign List” p.250). The functions you specify here will operate when the REALTIME CONTROL knobs [1]–[4] are operated in B-mode. Since the REALTIME CONTROL knobs [1]–[4] B-mode functions of the program assigned to each track will not be valid, you can make new settings here.

Knob 1–B	<b>AMSource</b>	[Off, ..., MIDI CC#95]
Knob 2–B	<b>AMSource</b>	[Off, ..., MIDI CC#95]
Knob 3–B	<b>AMSource</b>	[Off, ..., MIDI CC#95]
Knob 4–B	<b>AMSource</b>	[Off, ..., MIDI CC#95]

Program P1: 1–4b

## Song Play P3: Select Directory/ Jukebox

The contents of this display will depend on the “Jukebox” (0-1a) setting.

**Off (unchecked):** “3-1: Select Directory” will be displayed.  
**On (checked):** “3-1: Jukebox” will be displayed.

### 3-1: Select Directory

From a floppy disk inserted into the floppy disk drive, the internal hard disk, or an external SCSI device, select the directory containing the SMF that you want to play.

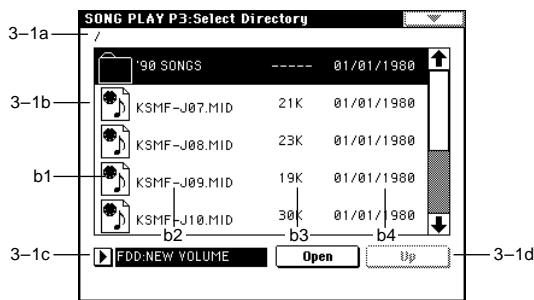

#### 3-1a: Current directory

The currently displayed directory selected for operations is called the “current directory.” The full pathname of the directory will be shown in the LCD screen. A slash “/” is used to delimit levels of the directory hierarchy. You can use the **Open button** and **Up button** to change the current directory.

#### 3-1b: Directory window

File information for the current directory is shown here. You can select a file or directory in this window.

##### b1: Files/icons

These indicate SMF and DOS directory files. (For details on icons, refer to Disk mode “Files, directories, and icons” (p.155))

##### b2: File name

The name of the SMF and the directory name.

##### b3: Size

This is the size (number of bytes) of the SMF.

##### b4: Save date

This is the date (from the left: day, month, year) that was assigned when the SMF was saved.

#### 3-1c: Drive select

**Drive select** [FDD, ID0...6, HDD, CDD: Name]

Selects the device (floppy disk or hard disk etc.) from which data will be played back.

The drive type and the volume label assigned to the media will be displayed. (☞”Drive select” Disk 0-1c)

⚠ If the CDRW-1 option is installed, and you play the keyboard or operate the controllers during playback, the physical shock may cause data skips or read errors, so that the playback may not occur correctly.

#### 3-1d: Open button, Up button

##### Open button

When you press the **Open button** the directory will be opened, and the current directory will move one level downward in the directory hierarchy.

##### Up button

When you press the **Up button**, the current directory will move one level upward in the directory hierarchy. This button is available when a directory is selected in the directory window.

### 3-1: Jukebox

Here you can create a jukebox list to specify the order in which SMF songs will be played. Up to 100 songs can be registered in a jukebox list. Lists can be saved and loaded using page menu commands 3-1B and 3-1A. Before saving to a disk, you must turn off the write protect setting of the disk.

⚠ If you want to save data to a floppy disk or removable disk, you must first turn off the write protect setting of the disk.

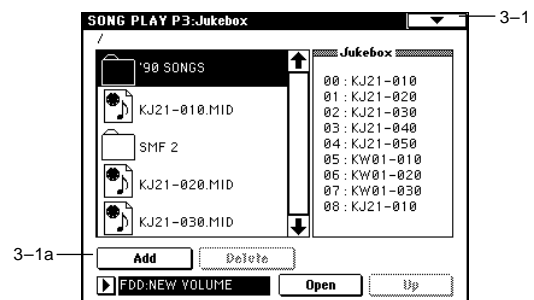

#### 3-1a: Add button, Delete button

##### Add button

This adds an SMF to the jukebox list. In the directory window, select the SMF that you wish to add to the jukebox list, and press this button to add the SMF to the list.

##### Delete button

This deletes an SMF from the jukebox list.

### ▼ 3-1: Page Menu Command

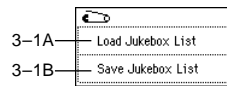

#### 3-1A: Load Jukebox List

This command loads the jukebox list that you wish to use.

- In the directory window, select a jukebox list file (file-name extension .JKB), and then select "**Load Jukebox List**".

The following dialog box will appear.

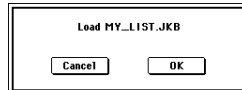

- To load the jukebox list, press the **OK button**. To cancel, press the **Cancel button**.

#### 3-1B: Save Jukebox List

This command saves the jukebox list you created as a file.

- Create a jukebox list, and then select "**Save Jukebox List**" to open the following dialog box.

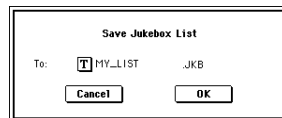

- Press the text edit button to move to the text edit dialog box, and input a filename.
- To save the jukebox list, press the **OK button**. To cancel, press the **Cancel button**.  
When you press the **OK button**, the jukebox list file will be saved on the media that is selected in drive select.

## Song Play P7: Arpeggiator

Here you can make arpeggiator settings for use in Song Play mode.

You can assign the arpeggiator to the "Play (Track Select)" track, and play arpeggios with the tempo synchronized to SMF playback.

You can assign arpeggiators A and B to two different tracks, and switch "Play (Track Select)" to switch between arpeggiators as you perform. Or you can switch arpeggio patterns or parameters and operate the [GATE] and [VELOCITY] knobs while you play.

The arpeggiator can be synchronized to the start of SMF playback.

- Turn on the arpeggiator and press the SEQUENCER [START/STOP] key, and the arpeggiator will synchronize with the playback timing of the SMF.
- If you press the SEQUENCER [START/STOP] key, and both the SMF playback and the arpeggiator will stop. If you wish to stop only the arpeggiator, turn off the ARPEGGIATOR [ON/OFF] key.

### 7-1: Setup 1-8 (Setup T01-08)

### 7-2: Setup 9-16 (Setup T09-16)



#### 7-1(2)a: Arpeggiator Assign, Arpeggiator Run

##### Arpeggiator Assign [Off, A, B]

When the ARPEGGIATOR [ON/OFF] key is on, the arpeggiator(s) will function according to the "Arpeggiator Run A, B" settings and the settings of each track.

**Off:** The arpeggiator will not operate.

**A:** Arpeggio A will operate. In the Arpeggiator A page you can select the arpeggio pattern and set the parameters.

**B:** Arpeggio B will operate. In the Arpeggiator B page you can select the arpeggio pattern and set the parameters.

Select either arpeggiator **A** or **B** for the play track that you will be playing manually along with the SMF playback. If you select an arpeggiator for two or more tracks, the arpeggiator will sound all the tracks to which it is assigned.

As another possibility, you can assign arpeggiator **A** and **B** to two tracks, select one track as the play track to be controlled from the keyboard, and control the other track from an external MIDI device connected to MIDI IN.

The arpeggiator will not be applied to notes played back from an SMF.

**MIDI** If tracks 1–16 to which arpeggiator A or B are assigned have a track “Status” (1–1a/2a) of either INT or BTH, they will be played by note data generated by the arpeggiator regardless of the “Ch” (0–1b) setting of each track. In the case of BTH or EXT, MIDI note data will be transmitted on the “Ch” of each track. In this case, arpeggiator A or B can be triggered by any MIDI channel specified by the “Ch” of a track 1–16 to which arpeggiator A or B is assigned. For example if arpeggiator A is assigned to tracks 1 and 2, the arpeggiator will be triggered by both MIDI channels 1 and 2.

⚡ If (“Local Control On” Global P1: 1–1a) is set to off, the arpeggiator will not be triggered by note data from the keyboard. The arpeggiator will be triggered only by note data from MIDI IN.

### Example 1)

Here’s how you can use “Play (Track Select)” (0–1a) to switch between tracks 1 and 2 to use different arpeggiators for each track, in synchronization with SMF playback.

For tracks 1 and 2, set “Status” (1–1a/2a) to INT. Assign arpeggiator A to track 1, arpeggiator B to track 2, and check “Arpeggiator Run A, B” (7–1a).

For “Play (Track Select),” select Track01.

If the ARPEGGIATOR [ON/OFF] key is off, playing the keyboard will cause track 1 to sound.

When you turn on the ARPEGGIATOR [ON/OFF] key, arpeggiator A will run, and track 1 will be sounded by the arpeggiator.

Use “Play (Track Select)” to select Track 02.

Arpeggiator B will run, and track 2 will be sounded by the arpeggiator.

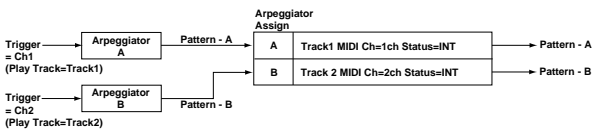

### Arpeggiator Run A, B

When the ARPEGGIATOR [ON/OFF] key is on, the arpeggiator(s) you check here will operate for the tracks to which they have been assigned. When the arpeggiator key is on, A and B can be turned on/off independently.

### ▼ 7–1: Page Menu Command

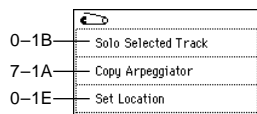

### 7–1A: Copy Arpeggiator

This command copies arpeggiator settings.

☞ “Combination 7–1A: Copy Arpeggiator.”

## 7–3: Arpegg. A (Arpeggiator A)

### 7–4: Arpegg. B (Arpeggiator B)

In the Arpegg. A page you can make settings for arpeggiator A, and in the Arpegg. B page you can make settings for arpeggiator B.

**note** You can also use the “Copy Arpeggiator” page menu command to copy settings from another mode, such as Program mode.

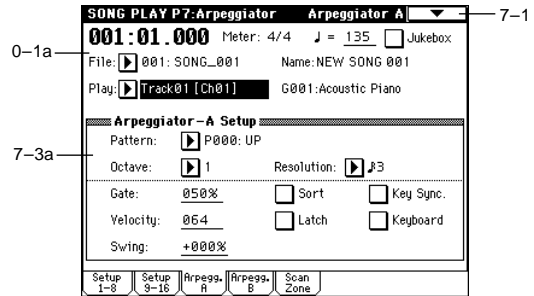

### 7–3(4)a: Arpeggiator–A(B) Setup

Pattern	[P00...P04, U000(I-A/B)...U506(User)]
Octave	[1, 2, 3, 4]
Resolution	[♪ <sub>3</sub> , ♪, ♪ <sub>3</sub> , ♪, ♪ <sub>3</sub> , ♪]
Gate	[000...100(%) , Step]
Velocity	[001...127, Key, Step]
Swing	[-100...+100(%)]
Sort	[Off, On]
Latch	[Off, On]
Key Sync.	[Off, On]
Keyboard	[Off, On]

These are the arpeggiator parameters for the Song Play mode (☞ “Program 7–1: Arpeg. Setup”).

## 7–5: Scan Zone (Scan Zone A/B)

Here you can specify the range of notes and velocities that will control each arpeggiator A and B.

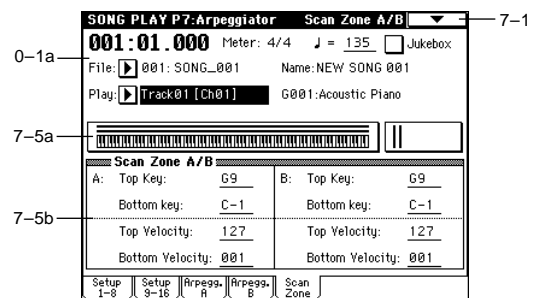

### 7–5a: Zone Map

This area displays the “Scan Zone” area for each arpeggiator A and B (☞ Combination “Zone Map” 7–4a).

## 7-5b: Scan Zone A/B

A:

Top Key [C-1...G9]

Bottom Key [C-1...G9]

Specify the range of notes (keys) that will trigger arpeggiator A. "Top Key" is the highest note of the range, and "Bottom Key" is the lowest note.

Top Velocity [001...127]

Bottom Velocity [001...127]

Specify the range of velocities that will trigger arpeggiator A. "Top Velocity" is the highest velocity of the range, and "Bottom Velocity" is the lowest velocity.

B:

Top Key [C-1...G9]

Bottom Key [C-1...G9]

Top Velocity [001...127]

Bottom Velocity [001...127]

Specify the range of notes (keys) and velocities that will trigger arpeggiator B (≡A).

**note** The value of these parameters can also be set by holding down the [ENTER] key and playing a note on the keyboard.

## Song Play P8: Insert Effect

Here you can make insert effect settings. You can also specify the bus for the program used by each track 1-16.

≡ For details on the insert effects, refer to p.178 "8. Effect Guide."

### 8-1: Routing 1-8 (Routing T01-08)

### 8-2: Routing 9-16 (Routing T09-16)

Specify the bus to which the program oscillator of each track 1-16 will be sent. You can also set the send amount to the master effect.

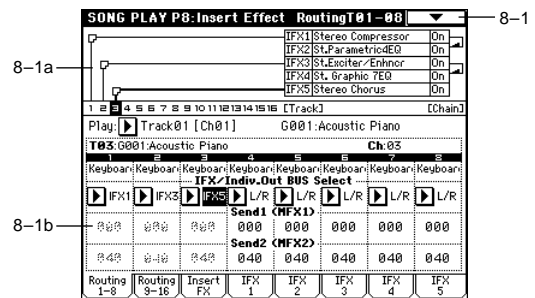

### 8-1a: Routing Map

This displays the settings of the insert effects, showing the routing status, the name of the selected effect, the on/off status, and chaining. Effect type, on/off, and chain settings can be made in the Insert FX pages.

### 8-1(2)b: IFX/Indiv.Out BUS Select (BUS Select), Send1 (MFX1), Send2 (MFX2)

#### IFX/Indiv.Out BUS Select (BUS Select)

[DKit, L/R, IFX1...5, 1...4, 1/2, 3/4, Off]

Specify the bus to which the program oscillator of each track 1-16 will be sent. The status of these settings can also be viewed in "Routing Map" (≡Combination P8-1: Routing).

With a setting of 1/2 or 3/4, the program of each track 1-16 will be output in stereo from AUDIO OUTPUT (INDIVIDUAL) 1 and 2, or 3 and 4. If the panning of the program oscillator is controlled using CC#10 (pan) or AMS etc., the pan setting will be applied each time note-on occurs. Unlike the case with a setting of L/R when the sound is output from (MAIN) L/MONO and R, the panning of a sounding note will not move in real-time.

If you wish to make realtime changes in the panning of a sounding note and output the result from AUDIO OUTPUT (INDIVIDUAL) 1 and 2, or 3 and 4, set "BUS Select" to IFX1 (or IFX2-IFX5), select 000: No Effect for "IFX1" (or IFX2-IFX5) (8-3), and set the "BUS Select" (8-3) after the signal passes through the effects to either 1/2 or 3/4.

Send1 (MFX1) [000...127]  
 Send2 (MFX2) [000...127]

Specify the send levels from tracks 1–16 to master effects 1 and 2. This is valid when “**BUS Select**” (8–1b) is set either to **L/R** or **Off**. If **IFX 1, 2, 3, 4, or 5** is selected, the send levels to master effects 1 and 2 are set by “**Send 1**” and “**Send 2**” (in the Insert FX page) after the signal passes through IFX1–5. These settings are invalid if “**BUS Select**” is set to **1, 2, 3, 4, 1/2 or 3/4**.

The send 1 and 2 settings you make here will be used when the SMF is played back from the beginning. You can also modify the settings during playback. However if the SMF contains send 1 or 2 data, the settings will change accordingly.

**MIDI** If “**Status**” (2–1a) is **INT** or **BTH**, MIDI control change (CC) #93 or #91 can be received to control send 1 or 2 and change the setting. Tracks 1–16 will be controlled by this data on MIDI channels 1–16 respectively. The actual send levels are determined by multiplying the value of these settings with the send level settings “**Send 1**” and “**Send 2**” (Program P8: 8–1d) of each oscillator of the program used by the track.

### ▼ 8–1: Page Menu Command

0–1B	Solo Selected Track
8–1A	Copy Insert Effect
8–1B	Swap Insert Effect
8–1C	DrumKit IFX Patch
0–1E	Set Location

### 8–1A: Copy Insert Effect

☞ “Program P8: 8–1A: Copy Insert Effect.”  
 However, the MIDI control channel specified by “**Ctrl Ch**” in the IFX1–5 pages will not be copied.

### 8–1B: Swap Insert Effect

☞ “Program P8: 8–1B: Swap Insert Effect.”  
 However, the MIDI control channel specified by “**Ctrl Ch**” in the IFX1–5 pages will not be swapped.

### 8–1C: DrumKit IFX Patch

☞ “Combination P8: 8–1C: DrumKit IFX Patch.”

## 8–3: Insert FX

Here you can select the type of each insert effect, turn it on/off, and make chain settings etc.

These parameters are the same as in Program mode. ☞ Program mode “8–2: Insert Fx.”

However, unlike in Program mode, “**Pan (CC#8)**,” “**Send 1 (MFX1)**” and “**Send 2 (MFX2)**” will be controlled on the MIDI channel specified in each of the IFX1–5 pages. The control changes used are the same as in Program mode. The pan (CC#8) and send 1 and 2 settings you make here are used when you playback from the beginning of the SMF. You can change the settings during playback. However if the SMF contains pan (CC#8) or send 1 or 2 data, the settings will change accordingly.

**MIDI** If “**Status**” (1–1a/2a) is **INT** or **BTH**, MIDI control change CC#8, CC#93, and CC#91 will control the pan, send 1 and send 2 after the signal passes through the insert effect and will change the setting. This data will control the MIDI channels of IFX1–5 (8–4 – 8–8): IFX1–5 pages) respectively.

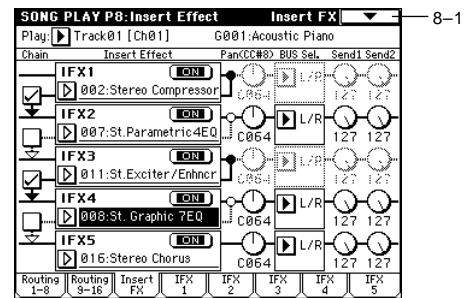

### 8–4: IFX 1

### 8–5: IFX 2

### 8–6: IFX 3

### 8–7: IFX 4

### 8–8: IFX 5

In the Insert FX pages you can set the parameters for the effects you selected in IFX1–5 (☞ p.187–).

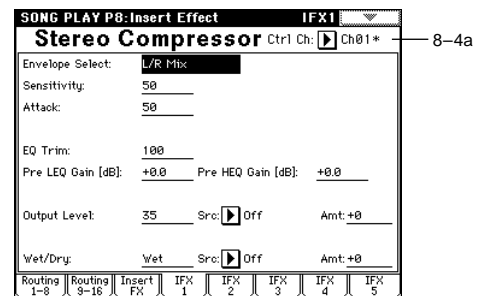

### 8–4(–8)a: Ctrl Ch

Ctrl Ch [Ch01...16, All Routed]

**MIDI** Specifies the MIDI channel that will control effect dynamic modulation (Dmod), pan following the insert effect (CC#8), Send 1 (CC#93), and Send 2 (CC#91).

An asterisk “\*” will be shown at the right of the channel number **Ch01–16** for each track that is routed through an IFX. If two or more tracks with different MIDI channels are routed, you can select here which of the channels will be used for control.

**All Routed:** Control will be possible on all of the MIDI channels of the routed tracks. An asterisk “\*” will be shown for the Ch of routed tracks (channels).

⚡ If the “**BUS Select**” (8–1b) of a track for which a drum program is selected has been set to **DKit**, the channel of that track will be effective when any of the IFX1–5 pages has been set to **All Routed**, regardless of the drum kit “**BUS Select**” (Global P5: 5–2b) settings or the “**Drum Kit IFX Patch**” page menu command settings.

## Song Play P9: Master Effect

For details on the master effects, refer to p.182 “8. Effect Guide.”

### 9-1: Master FX

Here you can select the type of each master effect, turn it on/off, and make chain and master EQ settings. These settings are the same as in Program mode. “Program 9-1: Master FX (Master Effects).”

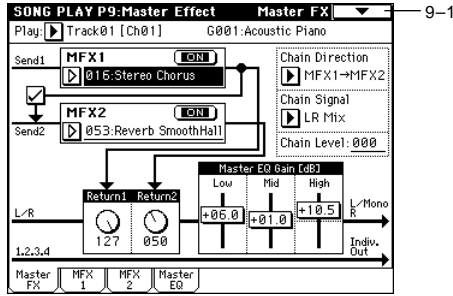

#### ▼ 9-1: Page Menu Command

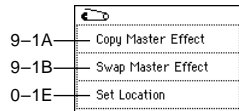

#### 9-1A: Copy Master Effect

“Program P9: 9-1A: Copy Master Effect.” However, the MIDI control channel specified by “Ctrl Ch” in the MFX1 and 2 pages will not be copied.

#### 9-1B: Swap Master Effect

“Program P9: 9-1B: Swap Master Effect.” However, the MIDI control channel specified by “Ctrl Ch” in the MFX1 and 2 pages will not be swapped.

### 9-2: MFX 1

### 9-3: MFX 2

Here you can set the parameters of the effects selected for MFX 1 and 2 in the Master FX page (p.187-).

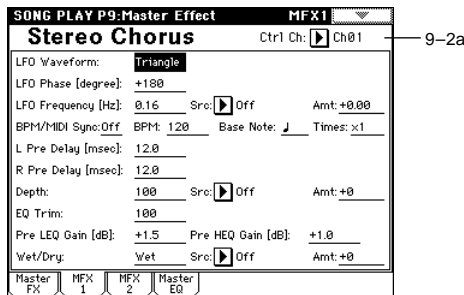

### 9-2(3)a: Ctrl Ch

Ctrl Ch [Ch01...16, Gch]

**MIDI** Specifies the MIDI channel that will control dynamic modulation (Dmod) for the master effects. With a setting of **Gch**, the global MIDI channel “MIDI Channel” (Global P1: 1-1a) will be used for control.

### 9-4: Master EQ

The master EQ is a three-band stereo EQ. It is located immediately before the L/R bus is sent from the AUDIO OUTPUT (MAIN OUT) L/MONO and R, and is used to apply overall equalization (tonal adjustments) (p.239).

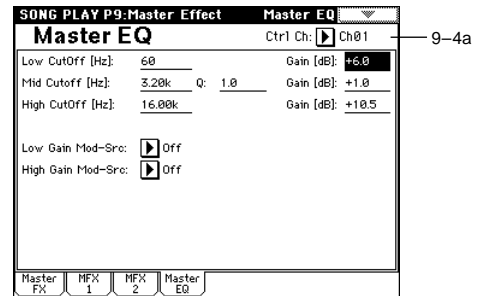

### 9-4a: Ctrl Ch

Ctrl Ch [Ch01...16, Gch]

**MIDI** Specifies the MIDI channel that will control dynamic modulation (Dmod) for the master EQ. With a setting of **Gch**, the global MIDI channel “MIDI Channel” (Global P1: 1-1a) will be used for control.

The MEQ High Gain and MEQ Low gain can be controlled by assigning a modulation source to the “Low Gain Mod-Src:” and the “High Gain Mod-Src:” functions on this page.





# 6. Global mode

In Global mode you can make settings that affect the entire instrument, such as master tuning, MIDI, and memory protect.

You can also edit user scales, drum kit setups, and user arpeggio patterns.

**!** If you want the settings you make in Global mode to be backed up when the power is turned off, you must write them into memory. To write your settings, use the page menu commands "Write Global Setting," "Write Drum Kits," or "Write Arpeggio Patterns." The SEQUENCER [REC/WRITE] key can also be used to access "Update Global Setting," "Update Drum Kits," and "Update Arpeggio Patterns." Simultaneously, the edited content will be written.

## Global P0: Basic Setup

### 0-1: Basic

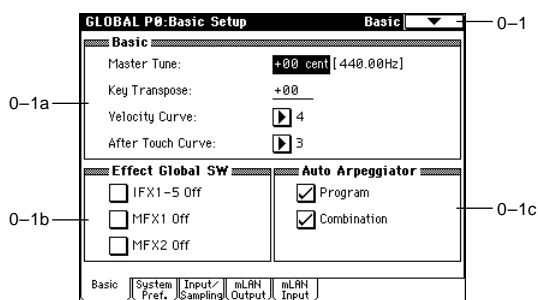

#### 0-1a: Basic

#### Master Tune

[-50cent (427.47Hz)...+50cent (452.89Hz)]

This adjusts the overall tuning of the entire TRITON STUDIO in one-cent units (semitone = 100 cents) over a range of  $\pm 50$  cents. With a setting of 0, the frequency of A4 will be 440 Hz.

**!** The A4 pitch given here is when **Equal Temperament** is selected as the scale. If a different scale is selected, A4 may not be 440 Hz.

#### Key Transpose

[-12...+12]

This adjusts the pitch in semitone steps over a  $\pm 1$  octave range.

This setting is applied at the location (**PreMIDI** or **PostMIDI**) specified by "**Convert Position**" (1-1a).

Note number transmitted	Transpose		
	-12	0	+12
61 keys	24...84 (C1...C6)	36...96 (C2...C7)	48...108 (C3...C8)
76 keys	16...91 (E0...G6)	28...103 (E1...G7)	40...115 (E2...G8)
88 keys	9...96 (A-1...C7)	21...108 (A0...C8)	33...120 (A1...C9)

**note** If "**Convert Position**" is set to **PreMIDI**, the note numbers transmitted from the TRITON STUDIO will be affected by this setting.

**MIDI** "**Master Tune**" can be controlled by the MIDI universal system exclusive message Master Fine Tuning (F0, 7F, nn, 04, 03, vv, mm, F7: nn=MIDI channel, vv/mm=value).

"**Key Transpose**" can be controlled by the MIDI universal system exclusive message Master Coarse Tuning (F0, 7F, nn, 04, 04, vv, mm, F7: nn=MIDI channel, vv/mm=value).

These messages are received on the **global MIDI channel** specified by "MIDI Channel" (1-1a).

In Program, Combination, Sequencer, and Song Play modes, MIDI RPN messages can be received to control the tuning and transposition of the program or timbre (Combination mode) or track (Sequencer/Song Play modes). Incoming MIDI RPN Fine Tune messages will make relative adjustments to the tuning specified by the "Master Tune" setting.

MIDI RPN Coarse Tune messages will make relative adjustments to the pitch specified by the "Key Transpose" setting. In Program mode these messages will be received on the global MIDI channel specified by "MIDI Channel" (1-1a), and in other modes they will be received on the MIDI channel specified for each timbre or track. (Detune, "Transpose" Combination P2: 2-3a, Sequencer P2: 2-5a/6a)

#### Velocity Curve

[1...8]

This specifies the way in which the volume and/or tone will change in response to variations in keyboard playing dynamics (velocity).

When "**Convert Position**" (1-1a) is **PreMIDI**, variations in keyboard playing dynamics will affect the velocity effect and the transmitted velocity data as shown in the left-hand diagram below. Incoming data will automatically use the velocity curve number 4 shown in the right-hand diagram. With a setting of **PostMIDI**, variations in keyboard playing dynamics (and in the velocity of incoming data) will respond as shown in the right-hand diagram below. If you are playing TRITON STUDIO's tone generator from an external keyboard or sequencer, and the overall sound is too bright or too dark, you can set the "**Convert Position**" parameter to **PostMIDI** and select the appropriate velocity curve here. For the transmitted data, the velocity curve number 4 shown in the left-hand diagram will automatically be selected.

For a setting of **PreMIDI**  
Velocity (KBD→MIDI Out)

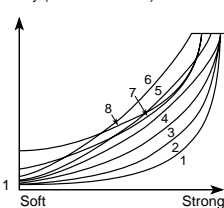

For a setting of **PostMIDI**  
Velocity (MIDI In→TG)

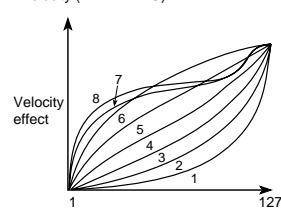

1, 2, 3: An effect will be obtained for strongly-played notes

4 (Normal): The normal curve

5, 6: An effect will be obtained even if you do not play very strongly

7: A certain amount of effect will be obtained even for softly-played notes

8: This curve produces the most regular effect. This setting is suitable when you do not need velocity sensitivity, or when

you wish to make the notes more consistent. However with this curve, control of softly-played notes will be more difficult, so use the curve that is most appropriate for your playing strength and style, and the effect that you wish to produce.

### After Touch Curve [1...8]

This specifies the way in which the volume and/or tone will change in response to variations in pressure (after touch) applied to the keyboard while playing a note.

When “Convert Position” (1-1a) is **PreMIDI**, variations in after touch pressure will affect the after touch effect and the transmitted after touch data as shown in the left-hand diagram below. Incoming data will automatically use the after touch curve number **3** shown in the right-hand diagram.

With a setting of **PostMIDI**, variations in after touch pressure (and in the value of incoming after touch data) will create change as shown in the right-hand diagram. For the transmitted data, the after touch curve number **3** shown in the left-hand diagram will automatically be selected.

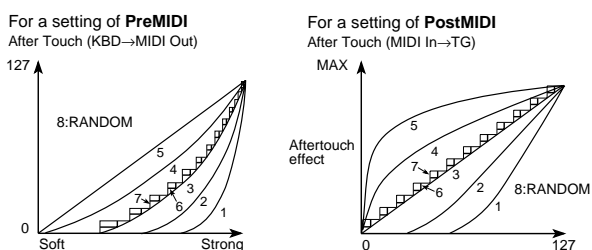

**1, 2:** This curve produces change when strong after touch pressure is applied

**3 (Normal):** The normal curve

**4, 5:** This curve produces change even when light pressure is applied

**6, 7:** These curves produce change in 24 or 12 steps respectively, and are appropriate for when you are recording after touch data on the sequencer and wish to conserve memory. (Set the “Convert Position” to **PreMIDI**.) Curve number 7 allows change over twelve steps, so when using after touch to modify the pitch, you can set the range of modification to one octave, and use after touch to vary the pitch in semitone steps.

**8:** This is a random curve. Use this when you wish to create special effects, or to use after touch to apply unpredictable modulation.

**MIDI** When “Convert Position” (1-1a) is **PreMIDI**, the setting you make here will be applied immediately after the keyboard, meaning that it will affect the data transmitted via MIDI, but will not affect the received data. With a setting of **PostMIDI**, the setting you make here will be applied immediately before the TRITON STUDIO’s internal tone generator, meaning that it will affect the data received via MIDI, but will not affect the transmitted data.

When you use the TRITON STUDIO’s keyboard to play the internal tone generator, the “Convert Position” setting will make no difference.

### 0-1b: Effect Global SW

#### IFX1-5 Off [Off, On]

**On (checked):** All insert effects IFX1-5 will be off.

**Off (unchecked):** The P8: Insert Effect settings for “IFX1 On/Off”-“IFX5 On/Off” in Program, Combination, Sequencer, Song Play, and Sampling modes will be valid.

#### MFX1 Off [Off, On]

**On (checked):** Master Effect (MFX1) will be off.

**Off (unchecked):** The P9: Master Effect setting “MFX1 On/Off” in Program, Combination, Sequencer, and Song Play modes will be valid.

#### MFX2 Off [Off, On]

**On (checked):** Master Effect (MFX2) will be off.

**Off (unchecked):** The P9: Master Effect setting “MFX2 On/Off” in Program, Combination, Sequencer, and Song Play modes will be valid.

**MIDI** When “IFX1-5 On/Off,” MFX1 “On/Off,” or MFX2 “On/Off” settings are switched, control change messages CC#92 (effect control 2), CC#94 (effect control 4), and CC#95 (effect control 5) will be transmitted respectively. The transmitted data will be 0 for off, and 127 for on.

### 0-1c: Auto Arpeggiator

#### Program (Auto Arp. Program) [Off, On]

**On (checked):** When a different program is selected, the arpeggiator settings stored in that program will automatically take effect.

**Off (unchecked):** The state of the arpeggiator will not change when the program is switched. Use this setting when you wish to keep the arpeggiator running while you select different program sounds.

#### Combination (Auto Arp. Combination) [Off, On]

**On (checked):** When a different combination is selected, the arpeggiator settings stored in that combination will automatically take effect.

**Off (unchecked):** The state of the arpeggiator will not change when the combination is switched. Use this setting when you wish to keep the arpeggiator running while you select different combination sounds.

### ▼ 0-1: Page Menu Command

0-1A	Write Global Setting
0-1B	Change all bank references
0-1C	Touch Panel Calibration
0-1D	Half Damper Calibration

#### 0-1A: Write Global Setting

This command writes Global mode settings (except for Drum Kits and User Arpeggio Patterns).

① Select “**Write Global Setting**” to access the dialog box.

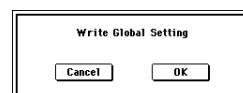

② To write the data, press the **OK button**. To cancel without writing, press the **Cancel button**.

You can also use the SEQUENCER [REC/WRITE] key to write data in the same way as the “Write Global Setting” command.

Press the SEQUENCER [REC/WRITE] key to access the “Update Global Setting” dialog box, and press the **OK button** to write the data.

**note** To write a drum kit or user arpeggio pattern, execute the appropriate utility menu command. (≡5-1A “Write Drum Kits,” 6-1A “Write Arpeggio Patterns”)

### 0-1B: Change all bank references

This command changes all program banks specified for timbres in combinations or tracks of songs.

- 1 Select "Change all bank references" to access the dialog box.

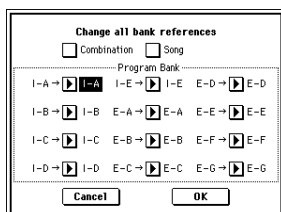

- 2 If you wish to change bank references for combinations, check "Combination." If you wish to change bank references for songs, check "Song."
- 3 In "Program Bank," specify the replacement for each bank.
- 4 To execute the Change All Bank References command, press the OK button. To cancel, press the Cancel button.

**!** If you change two or more different banks to the same bank, it will not be possible to use this function to change them back to different banks. Be careful that the change destination banks do not overlap.

### 0-1C: Touch Panel Calibration

If input via the LCD screen does not work as you expect, or if the edit cell moves to a location other than where you pressed the LCD screen, use this command to adjust the sensitivity of the LCD screen.

- 1 Select "Touch Panel Calibration" to access the dialog box.

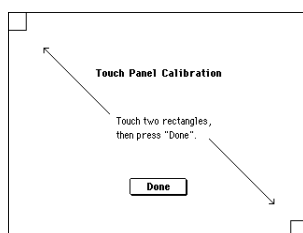

If you are unable to select this command from the page menu, hold down the [ENTER] key and press the [2] key to access the command.

- 2 Press the square in the upper left of the LCD. When your touch has been detected correctly the square will be highlighted.
- 3 Press the square in the lower right of the LCD. When your touch has been detected correctly the square will be highlighted.
- 4 Press the Done button. If your touch was not detected correctly, an error message will appear. Please perform the procedure once again.

### 0-1D: Half Damper Calibration

If a damper pedal that supports half damper (the DS-1H option) is connected to the DAMPER jack, here's how you can adjust the sensitivity if the damper effect is not applied appropriately.

**!** Since the half-damper pedal is highly sensitive, please use the optional DS-1H. Other pedals may not produce the appropriate effect, or may be impossible to calibrate correctly.

- 1 Connect a half-damper pedal to the DAMPER jack.

- 2 Select "Half Damper Calibration" to access the dialog box.

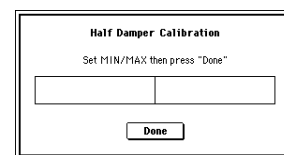

- 3 Press the half-damper pedal, and then release your foot from the pedal.
- 4 Press the Done button. If the adjustment could not be performed correctly, an error message will be displayed. Please perform the procedure once again.

## 0-2: System Preference

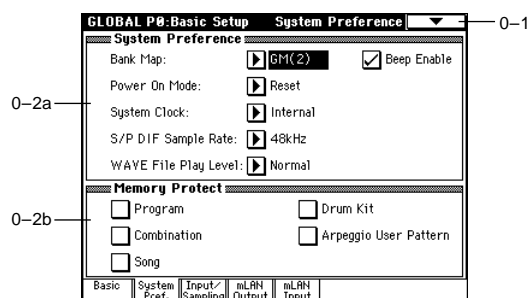

### 0-2a: System Preference

#### Bank Map [KORG, GM(2)]

Specifies the mapping of programs and combinations relative to Bank Select control change messages (CC#0 upper byte and CC#32 lower byte).

The bank select messages shown in the table below will be received (R) and transmitted (T) for program banks INT-A-INT-F, G, g(1)...g(9), g(d), EXB-A-EXB-G (INT-F is only for the EXB-MOSS option) and Combination banks INT-A-INT-E, and EXB-A-EXB-G.

Bank	Bank Map: KORG	Bank Map: GM(2)
INT-A	00.00 R/T	63.00 R/T
INT-B	00.01 R/T	63.01 R/T
INT-C	00.02 R/T	63.02 R/T
INT-D	00.03 R/T	63.03 R/T
INT-E	00.04 R/T	63.04 R/T
INT-F	00.05 R/T	63.05 R/T
G, g(1)...g(9)	121.00, 121.01...09 R/T	121.00, 121.01...09 R/T
	56.00 R	56.00 R 00.00, 00.01...(XG) R 00.00, 01.00...(GS) R
g(d)	120.00 R/T	120.00 R/T
	62.00 R	62.00 R
		63.127 R (->Korg MUTE)
EXB-A	00.08 R/T	63.08 R/T
EXB-B	00.09 R/T	63.09 R/T
EXB-C	00.10 R/T	63.10 R/T
EXB-D	00.11 R/T	63.11 R/T
EXB-E	00.12 R/T	63.12 R/T
EXB-F	00.13 R/T	63.13 R/T
EXB-G	00.14 R/T	63.14 R/T

## Power On Mode

[Reset, Memorize]

Specifies the condition at power-on.

**Reset:** The TRITON STUDIO will be in Combination mode P0: Play, and Combination A000 will be selected.

**Memorize:** The location (mode and page) where you were when the power was last turned off, and the last-selected program or combination number will be selected.

⚠ This function does not memorize the contents of any parameters that were edited. Before turning off the power, be sure to write your data or save it in Disk mode.

## System Clock [Internal, Word Clock, mLAN, S/P DIF]

Specifies the system clock of the TRITON STUDIO.

**Internal:** The TRITON STUDIO will operate with its own internal clock. Normally you will use this setting.

**Word Clock:** The system clock of the TRITON STUDIO will use the word clock of the ADAT Optical format-compatible device connected to the WORD CLOCK IN connector (if the EXB-DI option is connected).

**mLAN:** The system clock of the TRITON STUDIO will use the EXB-mLAN word clock. Use the mLAN setting when inputting digital audio signals from a digital audio device connected to the mLAN connector (if the EXB-mLAN option is installed).

**S/P DIF:** The TRITON STUDIO will operate using the system clock of the S/P DIF Optical format-compatible device connected to the S/P DIF IN jack.

**note** If the EXB-DI or EXB-mLAN options are not installed, **Word Clock** or **mLAN** cannot be selected.

⚠ If the system clock selected by the “System Clock” setting cannot be detected correctly, due to a cable being pulled out or for some other reason, an error message of “\*\*\* Clock Error!” will blink in the status bar (\*\*\*) will indicate the name of the clock). Check whether there is a problem with the cable.

If a “System Clock” setting of **Word Clock**, or **S/P DIF** has been stored, and the corresponding clock is not being input correctly when the power is turned on, an error message of “\*\*\* Clock Error!” will blink in the status bar (\*\*\*) will indicate the name of the clock), and the TRITON STUDIO will not sound correctly. For details on how to use these options, refer to p.286.

**note** The “System Clock” setting can be stored by the “Write Global Setting” utility.

## S/P DIF Sample Rate

[48 kHz, 96 kHz (Normal), 96 kHz (Hi Enhanced)]

Specifies the sample rate (sampling frequency) of the S/P DIF input and output.

**48 kHz:** Digital audio will be input/output at 48 kHz. All digital signals within the TRITON STUDIO are processed at a sampling frequency of 48 kHz.

The internal digital signals will be transmitted to and received from external digital audio devices without any change in the sampling rate.

**96 kHz (Normal):** Digital audio will be input/output at 96 kHz. The 48 kHz internal digital signals will be converted into 96 kHz for output. Digital signals from a 96 kHz external digital audio device will be converted into 48 kHz for input.

**96 kHz (Hi Enhanced):** Digital audio will be input/output at 96 kHz just as for the 96 kHz (Normal) setting. However, 96 kHz (Hi Enhanced) uses a special algorithm only on the transmitted data, to dynamically emphasize the high-frequency data above approximately 20 kHz for output.

Conceptual frequency response of the audio data transmitted with each setting

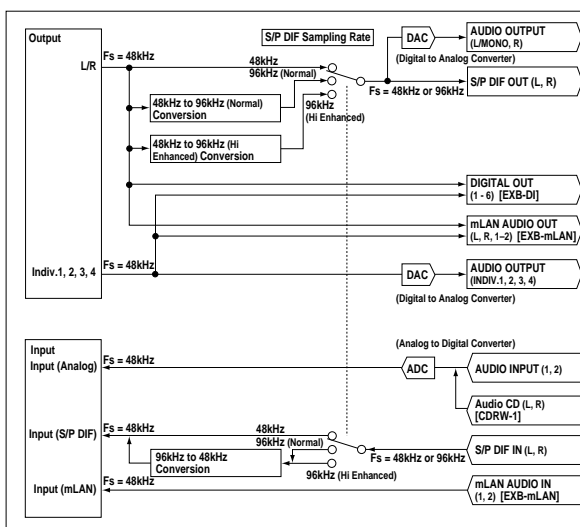
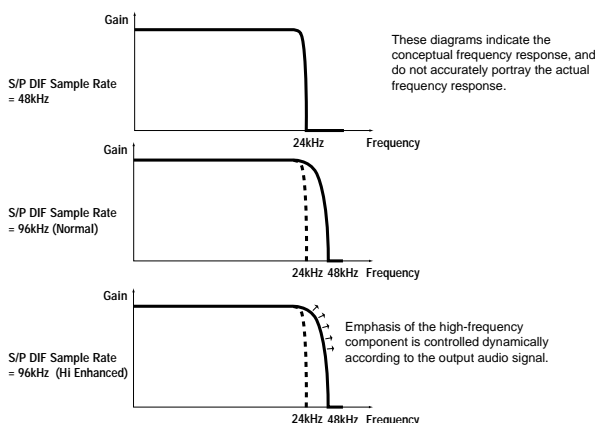

⚠ The tonal character of the analog audio from the AUDIO OUTPUT (MAIN) L/MONO and R jacks and headphone jack will also be affected by this setting. If data of a frequency other than specified here is input to the S/P DIF jack, the upper part of the LCD will indicate “S/P DIF Clock Error!”

## WAVE File Play Level [Normal, High (+12dB)]

Specifies the playback level when a WAVE file from the internal hard drive etc. is played on the TRITON STUDIO. This setting applies only to playback of a WAVE file. This will apply to the following pages and dialog boxes.

- Program, Combination, and Sequencer page menu command “Select Directory” 0-3D)
- Sampling page menu command “Select Directory” (0-1N)
- Disk Mode directory window (0-1b)
- Disk Mode Make Audio CD audio track list (0-4b), page menu command “Insert” (0-4C)

**Normal:** The WAVE file will play back at the normal level. This is the same standard level as when “+12 dB” (Sampling P2: 2-1c) is off.

**High (+12 dB):** Selects this setting when you want to play back a WAVE file on the TRITON STUDIO and record it via S/P DIF OUT, DIGITAL OUT (if the EXB-DI is installed), or the mLAN connector (if the EXB-mLAN is installed) on an external digital audio device. This will raise the digital output level by approximately 12 dB to match the level of the external digital audio device. Please be aware that the volume of the AUDIO OUTPUT L/MONO and R, and headphone jacks will also rise at this time.

When this setting is at Normal, the WAVE file playback level on the TRITON STUDIO is set approximately 12 dB lower than the maximum digital output level in order to match the level of the oscillators etc. Normally you should set this at **Normal**, and change it to **High (+12 dB)** as necessary when you want to record a WAVE file to an external digital audio device.

This is the same standard level as when “+12 dB” (Sampling P2: 2–1c) is on.

**Beep Enable** [Off, On]

**On (checked):** A beep will be heard when you press an object in the LCD screen.

### 0–2b: Memory Protect

**Program** [Off, On]

This setting protects the internal program memory.

**On (checked):** Internal program memory will be protected, and the following write operations cannot be performed.

- Writing a program
- Receiving program data via MIDI data dump
- Loading program data from disk

**Off (unchecked):** Data can be written to internal program memory.

**Combination** [Off, On]

This setting protects the internal combination memory.

**On (checked):** Internal combination memory will be protected, and the following write operations cannot be performed.

- Writing a combination
- Receiving combination data via MIDI data dump
- Loading combination data from disk

**Off (unchecked):** Data can be written to internal combination memory.

**Song** [Off, On]

This setting protects the internal song memory. However, when the power is turned off, the song data in song memory will be lost regardless of this setting.

**On (checked):** Internal song memory will be protected, and the following write operations cannot be performed.

- Recording to the sequencer
- Receiving song data via MIDI data dump
- Loading song data from disk

**Off (unchecked):** Data can be written to internal song memory.

**Drum Kit** [Off, On]

This setting protects the internal drum kit memory.

**On (checked):** Internal drum kit memory will be protected, and the following write operations cannot be performed.

- Writing a drum kit
- Receiving drum kit data via MIDI data dump
- Loading drum kit data from disk

**Off (unchecked):** Data can be written to internal drum kit memory.

**Arpeggio User Pattern** [Off, On]

This setting protects the internal user arpeggio pattern memory.

**On (checked):** Internal user arpeggio pattern memory will be protected, and the following write operations cannot be performed.

- Writing an user arpeggio pattern

- Receiving user arpeggio pattern data via MIDI data dump
- Loading user arpeggio pattern data from disk

**Off (unchecked):** Data can be written to internal user arpeggio pattern memory.

## 0–3: Input/Sampling

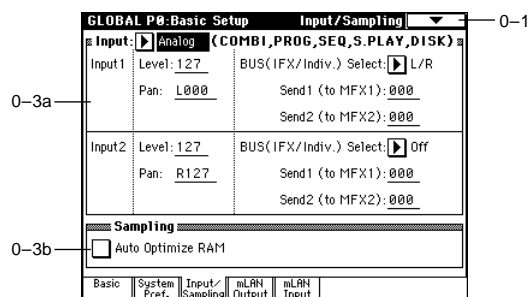

### 0–3a: Input (COMBI, PROG, SEQ, S.PLAY, DISK)

Here you can select the input source for an analog/digital audio signal, and specify the input level, bus, and send levels to the master effects. These settings will apply in Combination, Program, Sequencer, Song Play, and Disk modes.

Insert effects, master effects, and the master EQ can be applied to the input audio signal. The TRITON STUDIO can be used as a 6-in 6-out effect processor, or in conjunction with external sources. (Effect 093: Vocoder can be used as a vocoder effect that controls an internal sound by an external mic input.)

These audio signal inputs can also be sampled in Combination, Program, and Sequencer modes. In addition, performances using functions such as the keyboard or arpeggiator can also be sampled at the same time in these modes.

**Note** These settings do not apply in Sampling mode. If you move from Sampling mode to Global mode, the “Input” setting of Sampling mode will be maintained, and you will not be able to check the settings of this page. You must move from the mode (Combination, Program, Sequencer, Song Play, or Disk) in which the external audio signals are input. Settings for inputting external audio signals in Sampling mode are made in the same way in Sampling P0: Input/Setup, **Input (SAMPLING)**. (The master effects and master EQ cannot be used in Sampling mode.)

**Input** [Analog, S/P DIF, mLAN]

Makes settings for external audio sources that will be input to the TRITON STUDIO.

**Note** Separate settings can be made for **Analog**, **S/P DIF**, and **mLAN**. First use this “Input” setting to select a source, and then set the various parameters for **Input1** and **Input2**. Multiple external audio sources can be input simultaneously. If you want to save these settings, execute “Write Global Setting.”

**Analog:** The analog audio output from an instrument or other device connected to the AUDIO INPUT 1 and 2 jacks will be input to the TRITON STUDIO.

In the Disk mode Play Audio CD page, an audio CD placed in the CDRW-1 option (if installed) can be played. In this case, the audio will be input to the TRITON STUDIO according to the settings you make here. The L channel corresponds to **Input1**, and the R channel to **Input2**.

**S/P DIF:** The digital audio output from an instrument or DAT etc. connected to the S/P DIF jack will be input to the TRITON STUDIO. Use Input1 (below) to make settings for the L channel of the S/P DIF IN connector, and Input2 for the R channel. The S/P DIF input/output supports sampling rates of 48 kHz and 96 kHz. The sampling rate is specified by "S/P DIF Sample Rate" (Global P0: 0-2a). Data at a sample rate of 96 kHz will be converted into 48 kHz for input.

**mLAN:** The digital audio output from an instrument or other device connected to the mLAN connector (if the EXB-mLAN option is installed) will be input to the TRITON STUDIO.

You will need to make settings in the Global mode P0: mLAN Input page to specify the source that will be input.

 In order to select **mLAN**, the EXB-mLAN option must be installed, and "System Clock" (Global P0: 0-2a) must be set to **mLAN**.

**Input1:**

**Input2:**

**Level** [0...127]

Specifies the level of the external audio signal being input (specified by "Input"). Normally you will set this to **127**.

 The analog audio signal from the AUDIO INPUT 1 and 2 jacks and from the CDRW-1 option is converted into digital form by an AD converter. This parameter sets the level of the signal immediately after it is converted into a digital signal. If the sound is still distorted even when this level is lowered significantly, it is possible that the distortion is occurring before the AD converter. Use the [LEVEL] knob or the output level control of your external audio source to make adjustments.

**Pan** [L000...C064...R127]

Sets the pan of the external audio signal being input (specified by "Input"). If you are inputting a stereo audio source, you will normally set *Input1* to **L000**, and *Input2* to **R127** (or *Input1* to **R127** and *Input2* to **L000**). If you are inputting a monaural audio source, you will normally set this to **C064**.

**BUS (IFX/Indiv.) Select** [L/R, IFX1...5, 1...4, 1/2, 3/4, Off]

Specifies the bus to which the external audio signal being input (specified by "Input") will be sent. ("2-4. Audio Input" )

**Send1 (to MFX1), Send2 (to MFX2)** [000...127]

In the same as for the oscillator(s) of a program, this parameter specifies the level that is sent from the external audio signal being input (specified by "Input") to the master effects. If "BUS (IFX) Select" has been set to **IFX1-5**, the send level to the master effects is specified by "Send1" and "Send2" (Program 8-1d. Combination, Sequencer, Song Play 8-1b) after the signal has passed through IFX1-5. ("2-4. Audio Input" )

 If "BUS (IFX/Indiv.) Select" is set to other than **Off**, and you raise the "Level" setting, the external audio source will be input to the TRITON STUDIO. At this time if audio cables are connected to the AUDIO INPUT 1 or 2 jacks, the noise component will be input via the AD converters into the TRITON STUDIO even if there is no audio input, and depending on the settings, may be output from the AUDIO OUTPUT L/R, 1, 2, 3 and 4 jacks. If you want to perform using only internal sounds such as programs, combinations, and songs, and are not using external audio inputs, you should set "BUS (IFX/Indiv.) Select" to **Off**, or set "Level" to **0**.

Similarly, if you are not using the S/P DIF connector or mLAN connector, you should turn "BUS (IFX/Indiv.) Select" **Off**, or set "Level" to **0**.

If audio cables are not connected to the AUDIO INPUT 1 and 2 jacks, the input to the TRITON STUDIO via the AD converter is forced to zero, and no noise component will be output.

## 0-3b: Sampling

**Auto Optimize RAM** [Off, On]

If RAM is specified as the data writing destination for sampling, this parameter specifies whether the sample memory (RAM) will be optimized after data is written.

Optimization rearranges any unused memory areas so that all of the remaining memory can be used.

**On (checked):** RAM will automatically be optimized when sampling ends.

With this setting, you will always be able to sample without wasting RAM, but the sound will stop when sampling ends. If a song was playing in Sequencer mode, the playback will stop.

**Off (unchecked):** RAM will not be optimized when sampling ends. Since the sound will not stop when sampling ends, this setting is convenient when you want to consecutively sample several sections while a song plays or while listening to an input source such as a CD.

If "Auto Optimize RAM" is turned **Off (unchecked)** and unused areas have accumulated in memory, you can execute the page menu command "Optimize RAM" (Program P0: 0-3B, Combination P0: 0-3B, Sequencer P0: 0-3B, Sampling) to optimize the RAM.

 The remaining amount of sample memory (RAM) can be checked in Sampling Mode P0: Memory Status.

## 0-4: mLAN Output

Here you can make mLAN output plug settings for the TRITON STUDIO's audio (L, R, Indiv. 1-4) and MIDI. This can be selected if the EXB-mLAN option is installed.

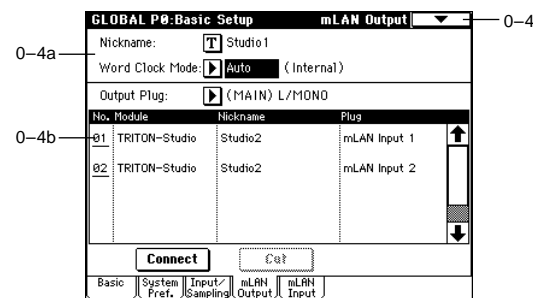

For more about mLAN, refer to the "EXB-mLAN owner's manual" and "mLAN guide" included with the EXB-mLAN.

### 0-4a: Nickname, Word Clock Mode

#### Nickname

Specifies the nickname for the EXB-mLAN installed in the TRITON STUDIO. The nickname you specify here will be displayed on external devices connected to the EXB-mLAN. Some external devices may not display the nickname.

**Word Clock Mode** [Auto, Manual]

Specifies the word clock of the EXB-mLAN.

**Auto:** The word clock master/slave setting will be made automatically.

**Manual:** The TRITON STUDIO will be the word clock master, and the slave devices will synchronize to the clock of the EXB-mLAN. However if settings are changed on a connected external device, the external device will become the master.

The current word clock setting is shown in parentheses. If this is **Internal**, the EXB-mLAN is the master. If this is **External**, one of the connected external devices is the master, and the EXB-mLAN is the slave.

#### 0-4b: Output Plug, No., Module, Nickname, Plug, Connect, Cut

##### Output Plug

[L (Main), R (Main), 1 (Individual)...4, MIDI]

Selects the TRITON STUDIO's mLAN output plug that you want to connect.

**No.** [01...62]

Up to 62 output destinations can be specified for one mLAN plug. When you execute **Connect** to make a connection, the connection number here will be assigned automatically. To break a connection, select the No. of the connection that you want to break, and execute **Cut**.

##### Module, Nickname, Plug

This area displays the module name, nickname, and plug name of the currently-connected output destinations.

##### Connect

This button connects the TRITON STUDIO's output plug to an external device connected to the EXB-mLAN.

##### Cut

This button disconnects the TRITON STUDIO's output plug from an external device connected to the EXB-mLAN.

##### To make a connection

- Use "**Output Plug**" to select the TRITON STUDIO output plug that you want to connect.
- Press the **Connect** button to access the dialog box.

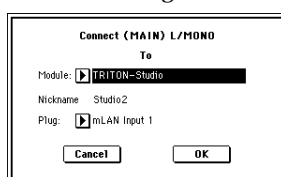

- Use "**Module**" to specify the output destination module. When you press the "Module" popup button, the nickname will be displayed in parentheses beside the module name. The nickname will also be automatically displayed in the dialog box. Use "**Plug**" to select the plug that you want to connect.
- Press the **OK** button to make the connection, or press the **Cancel** button to cancel without connecting. When you make the connection, a connection No. will be added, and the connected module name, nickname, and plug name will be displayed.

##### To break a connection

- Select the connection number ("No.") that you want to break.
- Press the **Cut** button to break the connection.

#### ▼ 0-4: Page Menu Command

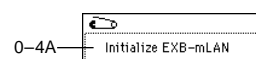

#### 0-4A: Initialize EXB-mLAN

This command initializes the mLAN connection settings of the EXB-mLAN, its word clock synchronization state, and other internal settings for use with the TRITON STUDIO.

- Select "**Initialize EXB-mLAN**" to access the dialog box.

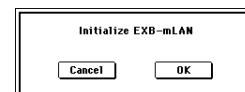

- Press the **OK** button to execute initialization, or press the **Cancel** button to cancel without initializing.

**Note** You must execute this initialization after the EXB-mLAN is first installed in the TRITON STUDIO.

**Note** If an error message of "Failed in the initialization of EXB-mLAN" is displayed when "Initialize EXB-mLAN" is executed, disconnect the IEEE 1394 cable from the mLAN connector of the TRITON STUDIO, and execute the command once again. If an error still occurs, please contact your Korg distributor.

#### 0-5: mLAN Input

Here you can make mLAN input plug settings for digital audio signals and MIDI that are output from an external mLAN device.

You can specify the input source for the TRITON STUDIO's mLAN Input 1 and 2, and for mLAN MIDI IN.

**Note** Only one output can be connected to each input.

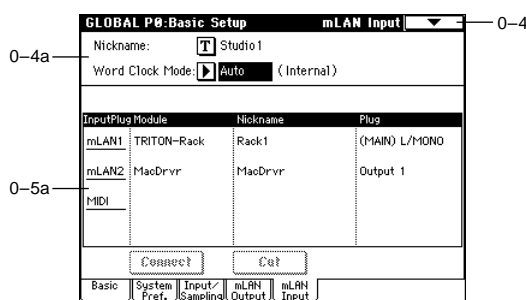

For more about mLAN, refer to the "EXB-mLAN owner's manual" and "mLAN guide" included with the EXB-mLAN.

#### 0-5a: Input Plug, Module, Nickname, Plug, Connect, Cut

**Input Plug** [mLAN1, mLAN2, MIDI]

Selects the TRITON STUDIO's mLAN input plug that you want to connect.

If you want to make a connection or break a connection, select the mLAN input plug here, and execute **Connect** or **Cut**.

If you want the sound that is input to **mLAN1** or **mLAN2** to be heard from the TRITON STUDIO, make settings here, and then set "Input" (Global P0: 0-3a, Sampling P0: 0-2a).

**Note** When setting "Input," you must set "**System Clock**" (Global P0: 0-2a) to **mLAN**.



## Module, Nickname, Plug

This area displays the module name, nickname, and plug name of the currently-connected input sources.

## Connect

This button connects the TRITON STUDIO's input plug to an external device connected to the EXB-mLAN.

## Cut

This button disconnects the TRITON STUDIO's input plug from an external device connected to the EXB-mLAN.

## To make a connection

- 1 Use **"Input Plug"** to select the TRITON STUDIO input plug that you want to connect.
- 2 Press the **Connect button** to access the dialog box.

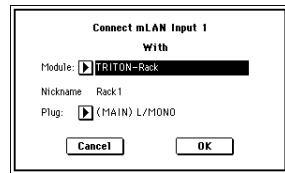

- 3 Use **"Module"** to specify the input source module. When you press the "Module" popup button, the nickname will be displayed in parentheses beside the module name. The nickname will also be automatically displayed in the dialog box. Use **"Plug"** to select the plug that you want to connect.
- 4 Press the **OK button** to make the connection, or press the **Cancel button** to cancel without connecting.
- 5 If you want the input sound to be heard from the TRITON STUDIO, set **"System Clock"** (Global P0: 0-2a) to **mLAN**, and then set **"Input"** (Global P0: 0-3a, Sampling P0: 0-2a).

## To break a connection

- 1 Select the **"Input Plug"** that you want to break.
- 2 Press the **Cut button**. The connection will be broken, and the display will be blank for the mLAN input plug whose connection you broke.

**note** "Nickname," "Word Clock Mode," and Connection data are stored by the EXB-mLAN. It is not necessary to write Global Settings to save this data.

# Global P1: MIDI

## 1-1: MIDI

Here you can make MIDI-related settings that affect the entire TRITON STUDIO.

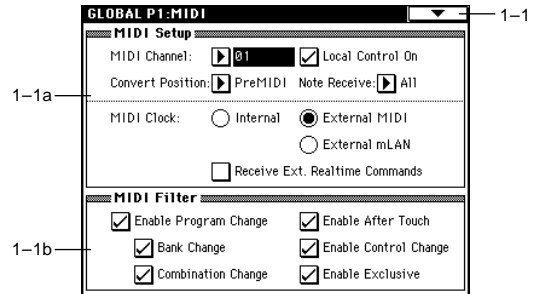

### 1-1a: MIDI Setup

#### MIDI Channel (Global MIDI Channel)

[1...16]

Sets the global MIDI channel.

The global MIDI channel is used in the following cases.

- When transmitting and receiving performance data in Program mode (Program P0: Play) and Sampling mode.
- When selecting combinations via MIDI in Combination mode (Combination P0: Play).
- When controlling timbres or effects that have been set to **Gch** in various modes
- When transmitting and receiving system exclusive messages

#### MIDI received

In Program mode (P0: Play), MIDI data is received on the global MIDI channel, but in Combination mode (P0: Play) or Sequencer mode, MIDI data is received on the MIDI channel specified for each timbre or track.

In Combination mode (P0: Play), program changes received on the global MIDI channel will switch the combination (see 1-1b: **MIDI Filter**).

Use the global MIDI channel to switch IFX 1-5, MFX1 and MFX2 on/off.

To control the pan following IFX, sends 1/2, MFX 1/2 and MEQ, use the global MIDI channel when in the Program or Sampling mode; while in the Combination, Sequencer, or Song Play modes, use the channel specified separately by "Ctrl Ch" for IFX1-5, MFX1, MFX2, and MEQ. By setting "Ctrl Ch" to **Gch**, you can control these parameters from the global MIDI channel.

#### MIDI transmission when TRITON STUDIO's controllers are operated

In Program mode and Sampling mode, this data will be transmitted on the global MIDI channel. In Combination mode, data will be transmitted simultaneously on the global MIDI channel and on the MIDI channels of timbres whose **"Status"** (Combination 0-1c, 2-1b) is set to **EXT** or **EX2**.

In Sequencer mode, musical data will be transmitted on the channel specified for the currently selected track (Sequencer 0-1a) (whose **"Status"** is **BTH**, **EXT**, or **EX2**).

#### Local Control On

**Checked (Local Control On):** The TRITON STUDIO's internal tone generator will be controlled by its own keyboard, joystick, SW1 and SW2, and connected foot pedal. If you are playing the TRITON STUDIO by itself, leave this setting checked.

**Unchecked (Local Control Off):** The TRITON STUDIO's keyboard and joystick etc. will be disconnected from the internal tone generator.

This means that operating the TRITON STUDIO (playing its keyboard and using the joystick, or playing back the sequencer) will not sound its internal tone generator. Uncheck this setting if echo-back from an external sequencer causes notes to be sounded in duplicate.

**MIDI** Even if this setting is unchecked, MIDI transmission and reception will occur normally. Playing the keyboard will cause the corresponding note data to be transmitted, and received note data will sound the TRITON STUDIO's internal tone generator.

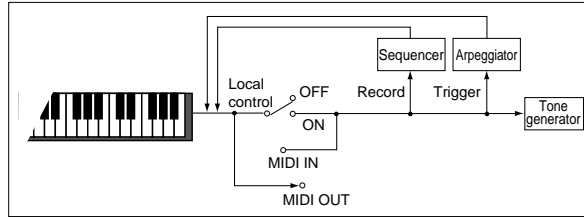

### Note Receive (Note Receive Filter) [All, Even, Odd]

This setting specifies whether even-numbered, odd-numbered, or all note numbers will be sounded when note data is received from the TRITON STUDIO's keyboard or from an external MIDI device. By connecting the TRITON STUDIO to another TRITON STUDIO and setting one instrument to **Even** and the other to **Odd**, you can effectively double the polyphony by dividing the notes between the two instruments.

**All:** All note numbers will be received. Normally you will leave this set to **All**.

**Even:** Even-numbered notes (C, D, E, F#, G#, A#) will sound.

**Odd:** Odd-numbered notes (C#, D#, F, G, A, B) will sound.

**MIDI** This setting has no effect on the MIDI data that is received.

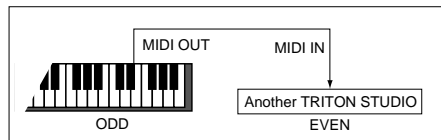

### Convert Position [PreMIDI, PostMIDI]

This setting specifies the location at which the Transpose, Velocity Curve, and After Touch Curve settings will be applied. This setting will affect the MIDI data that is transmitted and received, and the data that is recorded on the internal sequencer.

When using the TRITON STUDIO's keyboard to play the internal tone generator, the Transpose, Velocity Curve, and After Touch Curve settings will always take effect regardless of this setting.

**PreMIDI:** Velocity Curve, After Touch Curve, and Transpose will be applied to the data that is transmitted from the TRITON STUDIO's keyboard.

This means that the Velocity Curve, After Touch Curve, and Transpose settings will affect the data that is transmitted from MIDI OUT when the TRITON STUDIO's keyboard is played, and the data that is recorded on the internal sequencer. MIDI data received from MIDI IN or the data played back by the internal sequencer will not be affected.

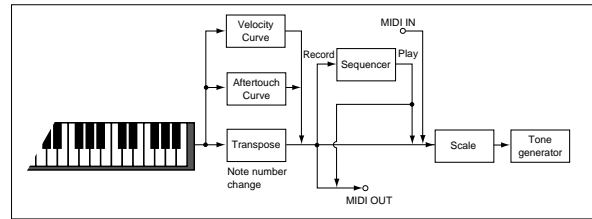

**PostMIDI:** Velocity Curve, After Touch Curve, and Transpose will be applied to data before it enters the tone generator.

This means that the Velocity Curve, After Touch Curve, and Transpose settings will affect the data that is sent to the internal tone generator when you play the TRITON STUDIO's keyboard, when the internal sequencer is played back, or when data is received from MIDI IN.

This setting will not affect the data that is transmitted from MIDI OUT or recorded on the internal sequencer when you play the TRITON STUDIO's keyboard or playback the sequencer.

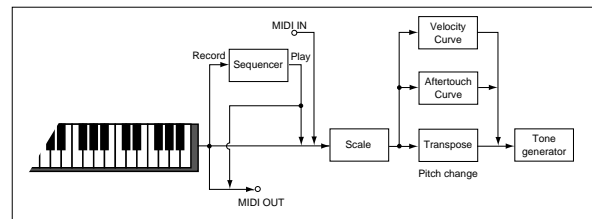

### MIDI Clock (MIDI Clock Source)

[Internal, External MIDI, External mLAN]

Sets this parameter when you wish to synchronize an external MIDI device (sequencer or rhythm machine etc.) with the TRITON STUDIO's internal arpeggiator or sequencer.

**Internal:** The internal arpeggiator and sequencer will synchronize to the TRITON STUDIO's own internal clock. Select the **Internal** setting when using the TRITON STUDIO by itself, or when you want the TRITON STUDIO to be the **master** (controlling device) so that another connected external MIDI device will synchronize to the MIDI Clock messages transmitted from the TRITON STUDIO.

**External MIDI:** The arpeggiator and sequencer of the TRITON STUDIO will synchronize to MIDI Clock messages transmitted from an external MIDI device connected to the MIDI IN connector.

**External mLAN:** The TRITON STUDIO will synchronize to the MIDI Clock messages transmitted by an external MIDI device connected to the mLAN connector, and the internal arpeggiator and internal sequencer of the TRITON STUDIO will operate as a **slave device**.

If you want the TRITON STUDIO to function as a **slave** (the device that is controlled) so that it synchronizes to the MIDI Clock transmitted from an external MIDI device, set this parameter to either **External MIDI** or **External mLAN**. The TRITON STUDIO will respond to MIDI Common messages and Realtime messages (Song Position Pointer, Song SELECT, Start, Continue, and Stop) from an external sequencer.

**In Song Play mode,** the TRITON STUDIO will operate in synchronization with its own internal clock regardless of this setting.

### Receive Ext. Realtime Commands [Off, On]

**Off (unchecked):** When "MIDI Clock" is set to **External MIDI** or **External mLAN**, MIDI Common messages and Realtime messages (Song Position Pointer, Start, Continue, and Stop) will not be received. (Song Select will be received.)

**note** Use this setting if receiving these messages from an external MIDI sequencer would cause the song settings of the TRITON STUDIO to be unwantedly reset.

**On (checked):** The above Common messages (including Song Select) and Realtime messages will be received.

 This parameter cannot be set if "MIDI Clock" is Internal.

## 1-1b: MIDI Filter

### Enable Program Change [Off, On]

**On (checked):** Program changes will be transmitted and received.

In Program mode (P0: Play), the program will be switched when a program change message is received on the global MIDI channel specified by "MIDI Channel" (1-1a). When you switch programs, a program change message will be transmitted on the global MIDI channel.

In Combination mode (P0: Play), the combination will be switched when a program change message is received on the global MIDI channel. However, it is possible to set the "Enable Combination Change" parameter so that the combination is not switched. When a program change is received on the channel specified for each timbre by "MIDI Channel" (Combination P2: 2-1b), the program of that timbre will be switched. However, the program changes for each timbre will be affected by the setting of the "Enable Program Change" parameter (Combination P3: 3-1a).

When you switch combinations, a program change message will be transmitted on the global MIDI channel, and also transmitted simultaneously on the channel of timbres whose "Status" (Combination P0: 0-1c, 2-1b) is set to **EXT** or **EX2**. In Sequencer mode, incoming program change messages on a channel that corresponds to a track whose "Status" (Sequencer P2: 2-1a/2a) is set to **INT** or **BTH** will switch programs on that track. When you select a song or playback sequencer data, program changes will be transmitted on the channels of tracks whose "Status" is set to **BTH**, **EXT**, or **EX2**.

**Off (unchecked):** Program changes will not be transmitted or received.

### Enable Bank Change [Off, On]

**On (checked):** The Bank Select control change message will be transmitted together with program change messages. This is valid when "Enable Program Change" is checked.

**Off (unchecked):** Bank Select messages will not be transmitted or received.

 When recording on the internal sequencer, bank select messages will be recorded regardless of this setting. However for playback, this setting will apply.

### Enable Combination Change [Off, On]

**On (checked):** When in Combination P0: Play, an incoming program change message on the global MIDI channel set by "MIDI Channel" (1-1a) will switch combinations. This is valid when "Enable Program Change" is checked. An incoming program change on a channel other than the global MIDI channel will switch the program of any timbre that matches that MIDI channel.

**Off (unchecked):** An incoming program change message on the global MIDI channel will switch the program of any timbre whose "MIDI Channel" (Combination P2: 2-1b) matches the global MIDI channel. The combination will not be switched.

The program changes for each timbre will be affected by the setting of the "Enable Program Change" parameter (Combination P3: 3-1a).

### Enable After Touch [Off, On]

**On (checked):** MIDI after touch messages will be transmitted and received.

**Off (unchecked):** MIDI after touch messages will neither be transmitted nor received.

When recording sounds that do not require the use of after touch, you can uncheck this parameter to save memory. This setting has no effect when you use the internal sequencer to playback sequence data that was recorded with after touch data; i.e., after touch will be transmitted via MIDI. The TRITON STUDIO's keyboard transmits only channel after touch; it does not transmit polyphonic after touch. However, since the TRITON STUDIO does support polyphonic after touch as an Alternate Modulation Source (AMS), it can receive polyphonic after touch to control individual notes.

### Enable Control Change [Off, On]

**On (checked):** Control change messages will be transmitted and received.

**Off (unchecked):** Control change messages will neither be transmitted nor received.

This setting has no effect when you use the internal sequencer to playback sequence data that was recorded with control change data; i.e., the control changes previously recorded into the sequencer will be transmitted via MIDI.

### Enable Exclusive [Off, On]

**On (checked):** System exclusive data will be transmitted and received. Check this setting when you wish to use a connected computer etc. to edit the TRITON STUDIO, or vice versa.

**Off (unchecked):** System exclusive data will neither be transmitted nor received. Normally you will leave this unchecked. However, system exclusive data will be transmitted and received while the page menu commands ("Dump Program"-"Dump All") of this page are displayed.

## ▼ 1-1: Page Menu Command

### 1-1A: Dump Program

### 1-1B: Dump Combination

### 1-1C: Dump Drum Kit

### 1-1D: Dump Arpeggio Pattern

### 1-1E: Dump Global Setting

### 1-1F: Dump Sequencer

### 1-1G: Dump All

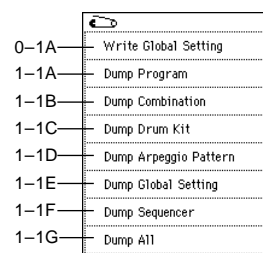

These commands allow the TRITON STUDIO's data to be transmitted to another connected TRITON STUDIO, MIDI data filter, or computer in the form of system exclusive data.

Select the desired command (refer to the following table), and a dialog box will appear.

Select the bank or timbre etc. of the data to be dumped. Then press the **OK button**.

Dump Program	Programs of all banks, programs of the specified bank, one program
Dump Combination	Combinations of all banks, combinations of the specified bank, one combination
Dump Drum Kit	All drum kits, One drum kit
Dump Arpeggio Pattern	All arpeggio patterns, One arpeggio pattern
Dump Global	Global settings (except for the Drum Kits and User Arpeggio Patterns of Global mode)
Dump Sequencer	All song data and cue list data
Dump All	All banks of programs + combinations + drum kits + arpeggio patterns + global settings + song data and cue list data

## Transmission

- Do not touch the TRITON STUDIO's switches or turn off the power while data is being transmitted.

### Data dump transmission procedure

- Connect the TRITON STUDIO to the device that will receive the data dump.  
If you are using a computer that can receive MIDI exclusive messages, connect the TRITON STUDIO's MIDI OUT connector to the MIDI IN connector of the MIDI interface connected to your computer (☞p.258).

- Some USB-MIDI interface devices may not be able to transmit or receive the TRITON STUDIO's MIDI exclusive messages.

If you are using a MIDI data filer, connect the TRITON STUDIO's MIDI OUT connector to the MIDI IN connector of the MIDI data filer. (☞p.258)

- Select Global P1: MIDI.
- From the page menu commands, select the type of data that you wish to dump.  
The following illustration shows the dialog box that will appear when "Dump Program" is selected.

If you wish to dump all programs, select "All." To dump one bank select "Bank," or to dump one program select "Single."

- In "To," specify the output connector from which the data will be transmitted.

**MIDI OUT:** MIDI OUT connector  
**mLAN:** mLAN connector

- note** If the EXB-mLAN is not installed, the mLAN parameter will not be displayed, and the output destination will always be MIDI OUT.

- note** **Regarding MIDI dump to a computer via mLAN**  
As with the TRITON-Rack, it is not currently possible to record or play back data dumped on any OMS-compatible application.

- Press the **OK button** to transmit the data.  
While the data is being transmitted, the display will indicate "Now Transmitting MIDI Data."  
The size of the data and the time required for transmission will depend on the type of data.

The following table shows the size of each data dump, and the time required.

Type of data to be dumped	Data size (Bytes)		Time required (Sec)	
	TRITON STUDIO	If EXB-MOSS is installed	TRITON STUDIO	If EXB-MOSS is installed
Data All	2608712-3979708	2697068-4068065	834.8-1273.5	863.1-1301.8
Program All	947941	1036297	303.3	331.6
Program Bank (IA..IE/EA..EG)	79004	---	25.3	---
Program Bank (IF)	---	88366	---	28.3
Program Single (IA..IE/EA..EG)	627	---	0.2	---
Program Single (IF)	---	700	---	0.2
Combination All	786441	←	251.7	←
Combination Bank	65545	←	21.0	←
Combination Single	521	←	0.2	←
Drum Kit All	676727	←	216.6	←
Drum Kit Single	4709	←	1.5	←
Arpeggio Pattern All	185427	←	59.3	←
Arpeggio Pattern Single	375	←	0.1	←
Global Setting	1009	←	0.3	←
Sequencer Data	11211-1382208	←	3.6-442.3	←

- When performing a data dump from the TRITON STUDIO onto a MIDI data filer, do not transmit multiple data dumps together. If multiple data is saved together, the TRITON STUDIO will have less than the required time (right column in the table above) to write the data into memory, and will be unable to receive all of the data correctly.

## Reception

- Do not touch the TRITON STUDIO's switches or turn off the power while data is being received.
- Before receiving MIDI data, we recommend that you close any dialog box, jump page, or page menu command, with the exception of the "Save Exclusive (Receive and Save MIDI Exclusive Data)" dialog box (Disk P0: 0-2G). Also, a data dump cannot be received while you are editing a cue list in the Sequencer mode P1: Cue List page. In this case, please exit cue list editing for the time being.

- After a data dump is received, the TRITON STUDIO will require up to 3 seconds to process the data and write it into memory. During this time, the display will indicate "Now writing into internal memory." While this display is shown, you must under no circumstances turn off the power of the TRITON STUDIO. If the power is turned off during this time, the TRITON STUDIO may fail to operate correctly when the power is turned on again. If this occurs, hold down the [MENU] key and the [9] key while you turn on the power. However when this is done, the contents of memory will be initialized. Transmission and reception of MIDI data is also impossible during this time. When receiving multiple data dumps in succession, you must allow an interval between the transmission of each data dump (☞table below).

### Processing time for writing into memory

Type of data dumped	Processing time for writing into memory
All	Approximately 3 seconds
All Programs	Approximately 2 seconds
All Combinations	Approximately 1 second
All Drum Kits	Approximately 1 second
All Arpeggio Patterns	Approximately 2 seconds
Global Setting	Approximately 1 second
Sequencer	Approximately 1 second

- MIDI cannot be transmitted or received while data is being written into internal memory. Also, transmission of Active Sensing (FEh) from the MIDI OUT connector and mLAN connector (if the EXB-mLAN option is installed) will be halted.

### Data dump reception procedure

- If you are using a computer that can receive MIDI exclusive messages, connect the TRITON STUDIO's MIDI OUT connector to the MIDI IN connector of the MIDI interface connected to your computer (☞p.258).
- Some USB-MIDI interface devices may not be able to transmit or receive the TRITON STUDIO's MIDI exclusive messages.

If you are using a MIDI data filer, connect the TRITON STUDIO's MIDI OUT connector to the MIDI IN connector of the MIDI data filer. (☞p.258)

- Set the MIDI channel of the MIDI device to match the global MIDI channel "MIDI Channel" (1-1a) of the TRITON STUDIO.

If you want the TRITON STUDIO to receive data that was previously transmitted to a MIDI device, you must set the global MIDI channel of the TRITON STUDIO to

the same global MIDI channel that was used when the data was transmitted.  
To set the MIDI channel of the transmitting device, refer to the owner's manual for that device.

- ③ Either check "Enable Exclusive" (1-1b), or display one of the page menu commands of this page. When one of these page menu commands is displayed, data dumps can be received regardless of the "Enable Exclusive" (1-1b) setting.
- ④ Transmit the data from the other device. For the procedure, refer to the owner's manual for the device you are using. While the data is being received, the display will indicate "Now received MIDI data."

## Global P2: Controller

### 2-1: Controller

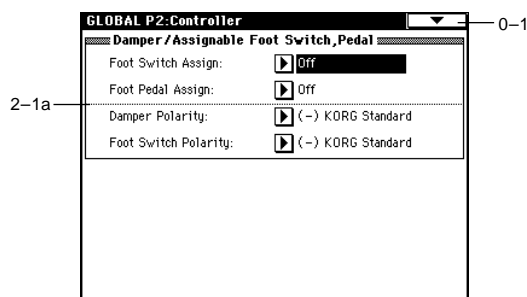

#### 2-1a: Damper/Assignable Foot Switch, Pedal

##### Foot Switch Assign [Off...SW 2]

Selects the function that will be controlled by a pedal switch (PS-1 option [sold separately]) connected to the ASSIGNABLE SWITCH jack ("Foot Switch Assign List" p.251).

##### Foot Pedal Assign [Off...Knob 4]

Selects the function that will be controlled by a foot volume pedal (XVP-10 or EXP-2 option [sold separately]) connected to the ASSIGNABLE PEDAL jack ("Foot Pedal Assign List" p.252).

##### Damper Polarity [(-)KORG Standard, (+)]

Sets this to match the polarity of the damper pedal connected to the DAMPER jack.  
If a Korg DS-1H (sold separately) damper pedal is connected, the pedal switch polarity will be (↓), so select (-) **KORG Standard** for this setting. If you have connected a damper pedal with a positive (↑) polarity, select (+) for this setting. (↓ is open-type, ↑ is closed-type.) If the polarity does not match, operating the damper pedal will not produce the correct result. If no damper pedal is connected, set this to (-) **KORG Standard**.

##### Foot Switch Polarity [(-)KORG Standard, (+)]

Sets this to match the polarity of the pedal switch connected to the ASSIGNABLE SWITCH jack.  
If a Korg PS-1 (sold separately) pedal switch is connected, the pedal switch polarity will be (↓), so select (-) **KORG Standard** for this setting. If you have connected a pedal switch with a positive (↑) polarity, select (+) for this setting. (↓ is open-type, ↑ is closed-type.) If the polarity does not match, operating the pedal switch will not produce the correct result. If no pedal switch is connected, set this to (-) **KORG Standard**.

## Global P3: User Scale

### 3-1: User Scale

Here you can make settings for sixteen different User Octave Scales and one User All Notes scale. The user scales you create here can be selected from the following pages.

- Program P1: Edit-Basic, Program Basic page
- Combination P2: Edit-Trk Param, Other page
- Sequencer P2: Trk Param, Other T01-08, T09-16 page
- Song Play P1: Track, Status/Scale T01-08, T09-16 page

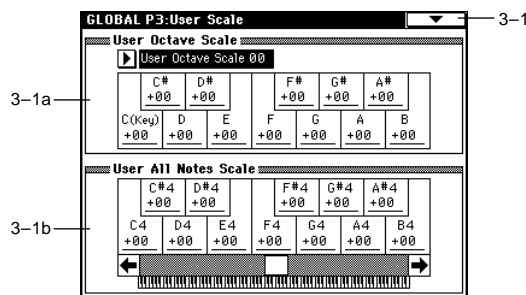

⚠ If you wish to keep an edited user scale after the power is turned off, be sure to write (save) your settings. Use the page menu command "Write Global Setting" or press the SEQUENCER [REC/WRITE] key to access the dialog box, and write the data.

#### 3-1a: User Octave Scale

**User Octave Scale** [User Octave Scale 00...15]  
Selects the User Octave Scale that you want to edit.

##### Tune [-99...+99]

Makes pitch settings for each note in the octave. When you adjust the pitch of each note in the octave (C-B) in one-cent steps, your settings will be applied to all octaves. This adjustment is relative to equal temperament. A setting of -99 lowers the pitch approximately a semitone below normal pitch. A setting of +99 raises the pitch approximately a semitone above normal pitch.

**note** The note can also be selected by holding down the [ENTER] key and playing a note on the keyboard.

**note** By executing the page menu command "Copy Scale," you can copy settings from a preset scale (other than Stretch) or from another user scale.

### 3-1b: User All Notes Scale

Tune [-99...+99]

Makes independent pitch settings for each of the 128 notes. Adjust the pitch of each of the 128 notes (C-1 – G9) in one-cent steps. This adjustment is relative to equal temperament. A setting of -99 lowers the pitch approximately a semitone below normal pitch.

A setting of +99 raises the pitch approximately a semitone above normal pitch.

Use the horizontal scroll bar to move to the key range that you want to set, and select the key that you want to specify.

**note** The note can also be selected by holding down the [ENTER] key and playing a note on the keyboard.

**note** By executing the page menu command “Copy Scale,” you can copy settings from a preset scale (including Stretch) or another user scale.

### ▼ 3-1: Page Menu Command

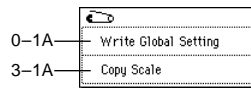

#### 3-1A: Copy Scale

This command copies data from a preset scale or between user scales. For details on the preset scales, refer to “Type” (Program P1: 1-1c).

- 1 Select “Copy Scale” to access the dialog box.

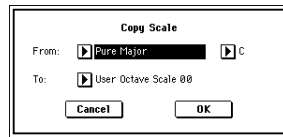

- 2 Use “From” to select the copy-source scale. If you select **Pure Major** or **Pure Minor**, specify the “Key” (located at the right) as well. **Stretch** cannot be selected if “To” is **User All Notes Scale**.
- 3 In “To,” selects the copy destination scale.
- 4 To execute the Copy Scale command, press the **OK button**. To cancel, press the **Cancel button**.

## Global P4: Category Name

### 4-1: Program Cat.

#### 4-2: Comb Cat.

When you write from the Write Program dialog box (Program P0: 0-1A) or Write Combination dialog box (Combination P0: 0-1A), one of the category names you edit here can be assigned to the program or combination.

In Program, Combination, Sequencer, and Song Play modes, you can use the (category) popup menu to select programs or combinations by category.

With the factory settings, the categories are set as the following types of instruments.

4-1a

GLOBAL P4:Category Name		Program Cat.
00:	Keyboard	08: Bass
01:	Organ	09: SlowSynth
02:	Bell/Mallet	10: FastSynth
03:	Strings	11: LeadSynth
04:	Vocal/Airy	12: MotionSynth
05:	Brass	13: SE
06:	Woodwind/Reed	14: Hit/Arpg
07:	Guitar/Plucked	15: Drums
Program Cat.		Comb Cat.

4-2a

GLOBAL P4:Category Name		Comb Cat.
00:	Keyboard	08: Pads
01:	Organ	09: Motion Synth
02:	Bell/Mallet/Perc	10: Synth
03:	Strings	11: LeadSplits
04:	BrassReed	12: BassSplits
05:	Orchestral	13: Complex S. SE
06:	World	14: Rhythmic Pattern
07:	Guitar/Plucked	15: Ds/Hits
Program Cat.		Comb Cat.

#### 4-1(2)a: Category name

Edits the category name.

Press the text edit button or the category name that you want to edit, to access the text edit dialog box and input the desired name. Up to 16 characters can be input. (BG p.57) You can name each of the sixteen program categories and sixteen combination categories.

**!** If you want the edited user category settings to be backed up when the power is turned off, you must write (save) the settings.

Execute the page menu command “Write Global Setting” or press the SEQUENCER [REC/WRITE] key to access the dialog box, and write the settings.

## Global P5: Drum Kit

Here you can create drum kits by assigning a drum instrument (drum sample) to each key.

A drum kit that you create or edit here can be selected in Program mode P1: Edit Basic “**Drum Kit**” (when “**Oscillator Mode**” is **Drums**) as an oscillator, and processed through the filter, amp and effects in the same way as a “multisample” (when “**Oscillator Mode**” is **Single** or **Double**).

When you wish to edit a drum kit, enter Program mode, select a program that uses a drum kit (i.e., whose “**Oscillator Mode**” is **Drums**), and then move to this page. A program that uses a drum kit will already have filter, amp, and effect settings etc. suitable for drum sounds. (Programs in the separate “**VNL**” that use a drum kit are indicated by a  symbol.)

Even if a program with an “**Oscillator Mode**” of **Single** or **Double** is selected in Program mode, the program will sound using its own filter and amp settings etc. Effects will sound according to the settings of the program you selected. You must set “**Octave**” (Program P1: 1-2a) to +0[8]. With any setting other than +0[8], the key locations and drum sounds will not correspond correctly.

 When a particular drum kit is edited, all programs that use that drum kit will be affected.

 If “**Enable Exclusive**” (1-1b) is checked, the drum kit can be edited using exclusive data.

 If you want the edited drum kit settings to be backed up after you turn off the power, you must write them into memory.

Execute the page menu command “**Write Global Setting**” or press the **SEQUENCER [REC/WRITE]** key to access the dialog box, and write the settings.

 For details on creating a drum kit, refer to BG p.128.

### 5-1: Sample Setup

Here you can select a drum kit, assign High and Low drum samples to each key, and set parameters for the High and Low drum samples.

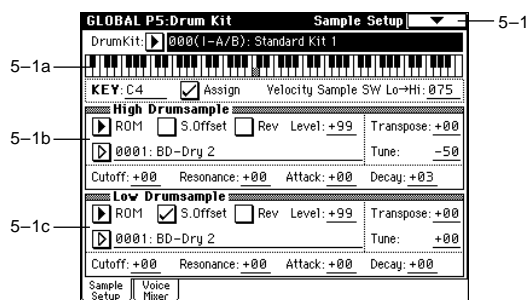



### 5-1a: Drum Kit, KeySelect, Assign, Velocity Sample SW

**Drum Kit** [000(I-A/B)...143(User)]

Selects the drum kit that you wish to edit.

00(I-A/B)...15(I-A/B)	Preloaded drum kits
16(E-A)...31(E-A) 32(E-B)...47(E-B) 48(E-C)...63(E-C) 64(E-D)...79(E-D) 80(E-E)...95(E-E) 96(E-F)...111(E-F) 112(E-G)...127(E-G)	User drum kits, EXB-PCM series drum kits
128(User)...143(User)	User drum kits (some preloaded drum kits)

 If you want to edit a drum kit (such as a preloaded drum kit) that is used by a program, it is a good idea to use the page menu command “**Copy Drum Kit**” to copy it to an unused number in **016 (E-A)–143 (User)**, and then edit the copy. Numbers 016 (E-A)–127 (E-G) are normally used to load drum kits for the EXB-PCM series options (some models do not have included drum kits).

 If you want to edit the name of the drum kit, execute the page menu command “**Rename Drum Kit**.”

**KEY** [C-1...G9]

Selects the key to which the drum sample (and its settings) will be assigned.

Use the VALUE controller to specify the key. You can also select the key by holding down the [ENTER] key and playing a note on the keyboard.

Two drum samples, High and Low, can be assigned to each key, allowing you to switch between them by velocity.

If you check “**Assign**” for the key you select here, the **High Drumsample**, **Low Drumsample**, **Voice Assign Mode**, and **Mixer** parameters (see below) will be used.

**Assign** [Off, On]

**On (checked):** The drum samples you assigned for “**High Drumsample**” and “**Low Drumsample**” will sound. Normally you will check this parameter.

**Off (unchecked):** The selected drumsamples will be invalid, and the drum samples of the key to the right will sound. At this time, the pitch will be a semitone lower than the pitch of the key to the right. Uncheck this parameter when you wish to play a drumsample at differing pitches.

**Velocity Sample SW Lo→Hi** [001...127]

Specifies the velocity value at which you will switch from the “**Low Drumsample**” to the “**High Drumsample**.” Velocities above this value will sound the “**High Drumsample**,” and velocities below this value will sound the “**Low Drumsample**.” If you do not wish to use velocity switching, set this to **001** and specify only the “**High Drumsample**” ( “**Velocity M.Sample SW Lo→Hi**” Program P1: 1-2c).

### 5-1b: High Drumsample

**High Drumsample Bank** [ROM, RAM, EXB\* ...]

**High Drumsample** [000...416, 0000...3999, 000...]

Selects the High drum sample by its bank and drumsample number. The drumsample you select here will sound when the velocity is greater than the “**Velocity Sample SW Lo→Hi**” (5-1a) setting.

**ROM:** Selects preset drum samples. For “**High Drumsample**” you can select from **000: BD-Dry 1–416: Vox-Wah Gtr 4**.

( $\text{E}3\text{F}$  "VNL")

**RAM:** Selects samples that you created in the Sampling mode, or that were loaded into the TRITON STUDIO in the Disk mode. For "**High Drumsample**" you can select from 0000-3999.

**note** When you press the popup button, the group of 1000 samples that include the currently selected sample will be displayed. To select a sample from a different set of 1000, use the VALUE controller to input the number.

**EXB\*:** Selects drum samples from a EXB-PCM series option. This can be selected only if an option board containing drum samples is installed. The "\*" will indicate the type of option board that is installed. The number of drum samples for "**High Drumsample**" will differ depending on the option that is installed.

**note** AKAI S1000/S3000 format, AIFF format, or WAVE format data can also be loaded in Disk mode as samples, and used as drum samples.

**!** The **EXB\*** display will depend on the type of option board.

**!** If you have selected a drum kit that uses drum samples from a EXB-PCM series option, and the drum sample does not match because the corresponding EXB-PCM (expansion board) is not installed, "**Bank**" will indicate **ROM**. In this case, that drum sample will not sound. When you re-select the drum sample bank, it will sound.

When you press the "**High Drumsample**" popup button, a list of drum samples will appear, allowing you to select a drum sample from the list. If **ROM** has been selected for "**High Drumsample Bank**," you can select drum samples from a tabbed list organized by instrumental category.

Category/ROM Drumsample Select menu:

High ROM Drumsample		BD-Normal		
BD Normal	0000: BD-Dry 1	0008: BD-Jazz 1		Orchest
BD Dance	0001: BD-Dry 2	0009: BD-Jazz 2		Analag
BD Normal	0002: BD-Dry 3	0010: BD-Pillow		Scratch
BD Dance	0003: BD-Dry 4	0011: BD-Woofier		Pierous
Tom	0004: BD-Dry 5	0012: BD-Hondo Kill		Industri
BD Normal	0005: BD-Dry 6	0013: BD-Terminator		Voice
BD Dance	0006: BD-Soft	0014: BD-Tubby		SE
Crash/Ride	0007: BD-Soft Room	0015: BD-Gated		

**!** It is not possible to edit the category names of drum samples, or to re-assign the category.

**S.Offset (Start Offset)** [Off, On]

**On (checked):** The sound will begin from a location later than the beginning of the drum sample waveform. The start offset location is preset for each drum sample. This parameter has no effect on a drum sample that contains no start offset setting.

However when a **RAM** bank is selected, this will depend on the selected drum sample. If you select a drum sample that includes one of the following types of sample, **checking** this item will cause playback to start from the Loop Start Address.

- A sample that was recorded (sampled) in Sampling mode etc.
- A sample whose Loop Start Address was edited in Sampling mode after the sample was loaded in Disk mode
- A sample whose Loop Start Address was specified automatically when it was loaded as an AKAI, AIFF, or WAVE file in Disk mode

**Off (unchecked):** Playback will start from the beginning of the drum sample waveform.

**Rev (Reverse)** [Off, On]

**On (checked):** The drum sample waveform will playback in "one-shot" reverse. The location at which the reverse playback will start and end is pre-determined for each drum sample.

RAM bank samples for which "Start" and "End" (Sampling P2: 2-1c) have been set will be played back (in reverse) from "End" to "Start."

**!** This setting will not affect the playback direction of a drum sample that is already set to reverse playback or reverse-loop playback.

**!** This parameter will not change the playback direction of a sample for which "**Rev**" (Sampling P2: 2-1c) is **checked**.

**Level** [-99...+99]

Specifies the volume.

Keys for which a value of +99 is specified will sound at a volume twice as high as the amp level of the program which uses that drum kit. Keys for which a value of 0 is specified will sound at the volume of the amp level of the program which uses that drum kit.

Keys for which a value of -99 is specified will not sound.

**Transpose** [-64...+63]

Adjusts the pitch in semitone steps.

+12 is one octave up, and -12 is one octave down.

**Tune** [-99...+99]

Adjusts the pitch in one-cent steps.

-99 is a semitone lower, and +99 is a semitone higher.

**Cutoff (Filter-Cutoff)** [-64...+63]

Adjust the cutoff frequency of the filter. The cutoff frequency for each key is determined by adding this value to the filter "Frequency (Cutoff Frequency)" (Program P3: 3-1b, 3-5) of the program that uses this drum kit.

**Resonance (Filter-Resonance)** [-64...+63]

Adjusts the filter resonance. The filter resonance for each key is determined by adding this value to the filter "Resonance" (Program: P3: 3-1b, 3-5) of the program that uses this drum kit. (When the "Filter Type" Program P3: 3-1a) is **Low Pass & High Pass**, there will be no resonance effect.)

**Attack (Amp-Attack)** [-64...+63]

Adjusts the attack time of the volume (Amplifier). The attack time for each key is determined by adding this value to the amp EG Attack Time of the program that uses this drum kit.

**Decay (Amp-Decay)** [-64...+63]

Adjusts the decay time of the volume (Amplifier). The decay time for each key is determined by adding this value to the amp EG Decay Time of the program that uses this drum kit.

## 5-1c: Low Drumsample

**Low Drumsample Bank** [ROM, RAM, EXB\*...]

**Low Drumsample** [000...416, 0000...3999, 000...]

Specifies the bank and drumsample number to select the Low drumsample. The drumsample you select here will sound when the velocity is less than the "**Velocity Sample SW Lo→Hi**" (5-1a) setting. ( $\text{E}3\text{F}$  5-1b)



S.Offset (Start Offset)	[Off, On]
Rev (Reverse)	[Off, On]
Level	[-99...+99]
Transpose	[-64...+63]
Tune	[-99...+99]
Cutoff (Filter-Cutoff)	[-64...+63]
Resonance (Filter-Resonance)	[-64...+63]
Attack (Amp-Attack)	[-64...+63]
Decay (Amp-Decay)	[-64...+63]

(☞ 5-1b)

## ▼ 5-1: Page Menu Command

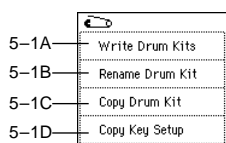

### 5-1A: Write Drum Kits

This command writes all drum kits 000 (I-A/B)-143 (User).

- 1 Select **“Write Drum Kits”** to access the dialog box.
- 2 To execute the Write command press the **OK button**. To cancel without executing press the **Cancel button**.  
You can also press the SEQUENCER [REC/WRITE] key to write arpeggio patterns in the same way as the “Write Drum Kits” command. Press the SEQUENCER [REC/WRITE] key to access the dialog box, and write the data.

### 5-1B: Rename Drum Kit

This command renames the selected drum kit. You can input a name of up to sixteen characters. (☞ BG p.57)

### 5-1C: Copy Drum Kit

This command copies the settings of another drum kit to the currently-edited drum kit.

**note** Drum kits 144-152 (GM) cannot be edited, but you may copy them to another drum kit and then edit them.

- 1 Select **“Copy Drum Kit”** to access the dialog box.

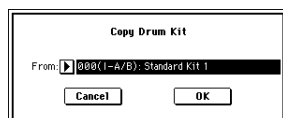

- 2 Select the copy source drum kit (**“From”**).
  - 3 To execute the Copy Drum Kit command press the **OK button**. To cancel without executing press the **Cancel button**.
- ⚠** Be aware that when you execute the **“Copy Drum Kit”** command, all settings of the currently selected drum kit will be overwritten.

### 5-1D: Copy Key Setup

This command copies the settings of an individual key to another key. You can also copy settings from two or more contiguous keys at once.

- 1 Select **“Copy Key Setup”** to access the dialog box.

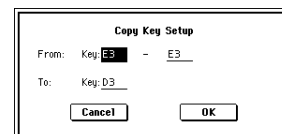

- 2 In **“From Key,”** select the range of keys that you wish to copy.
- 3 In **“To Key,”** select the copy destination key. If you selected two or more keys in “From Key,” their settings will be copied to the keys starting at “To Key” and continuing upward.
- 4 To execute the Copy Key Setup command, press the **OK button**. To cancel, press the **Cancel button**.

## 5-2: Voice/Mixer

For each key of a drum kit, you can set voice assign, pan, and effect routing etc.

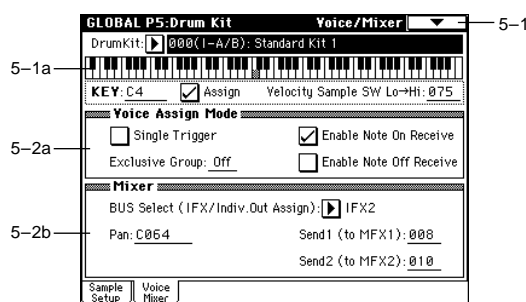

### 5-2a: Voice Assign Mode

**Single Trigger** [Off, On]

**On (checked):** Even when the same key (note) is played repeatedly, the previous note will be halted before the new note is begun, so that the notes will not overlap. Normally you will leave this **unchecked**.

**Exclusive Group (Exclusive Assign)** [Off, 001...127]

**001-127:** This allows you to assign keys to any of 127 groups. Keys assigned to the same group will be treated as a single group, and will be played monophonically with last-note priority. For example you might assign closed and open hi-hat sounds to the same group so that two or more hi-hat sounds can not sound simultaneously.

**Off:** Keys will not be grouped. Normally you will set this **Off**.

**Enable Note On Receive** [Off, On]

**On (checked):** Note-on messages will be received. Normally you will check this, but you can uncheck it if you do not want specific notes to sound.

Enable Note Off Receive [Off, On]

**On (checked):** Note-off messages will be received. Normally you will uncheck this. This parameter is valid when “Hold” (Program P1: 1–1b) is **checked** (Hold On). In the case of a drum program, you will normally select Hold On. In this case if “Enable Note Off Receive” is **checked**, note-off messages will be received, and the sound will stop (the release segment of the EG will begin) when the key is released.

## 5–2b: Mixer

 Drum kits will sound using the settings of the program that is selected in Program mode. These settings are valid when you have **checked** “Use DKit Setting” (Program P4: 4–1b) or “Use DKit Setting” (Program P8: 8–1b). Be aware that while editing a drum kit, the edited results will not be reflected unless these settings have been made.

**BUS Select (IFX/Indiv.Out Assign) (Bus Select)**  
[L/R, IFX1...5, 1...4, 1/2, 3/4, Off]

For each key, specify the bus to which the sound will be sent. For example you might send Snare sounds to **IFX1** and Kick sounds to **IFX2** to apply separate insert effects, and send the remaining sounds to L/R without applying insert effects.

**Pan [Random, L001...C064...R127]**

Specifies the panning for each key.

With a setting of **Random**, the drum sample will be panned randomly at each note-on.

**Send1 (to MFX1) [000...127]**

**Send2 (to MFX2) [000...127]**

For each key, specify the send levels to master effects 1 and 2. These settings are valid when “BUS Select” (5–2b) is set to L/R or Off.

If “BUS Select” is set to **IFX1–5**, the send level to master effects 1 and 2 will be determined by the Program, Combination, Sequencer, or Song Play mode P8: Insert FX page parameters “Send 1” and “Send 2” which are located after the sound passes through IFX1, 2, 3, 4, or 5.

## Global P6: User Arpeggio

Here you can create user arpeggio patterns.

In this page, the TRITON STUDIO will sound as it did in the mode you were in before entering Global mode.

**If you moved here from Program mode:** Your editing will apply to the arpeggio pattern that is selected by the program. Even if you moved from a program in which the arpeggiator is turned off, it can be turned on by the ARPEGGIATOR [ON/OFF] key.

**If you moved here from Combination mode:** Your editing will apply to the arpeggio pattern that is selected by the combination. Even if you moved from a combination in which the arpeggiator is turned off, it can be turned on by the ARPEGGIATOR [ON/OFF] key.

However, it is not possible to turn on an arpeggiator for which the “Arpeggiator Run” (Combination P0: 0–3a, P7: 7–1c) parameter A or B is not checked. Also, if the arpeggiator is not assigned to a timbre by “Arpeggiator Assign” (Combination P7: 7–1b), the arpeggiator will not run.

**If you moved here from Sequencer or Song Play mode:** Your editing will apply to the arpeggio pattern specified for the selected song.

Even if you moved here from settings in which the arpeggiator was turned off, you can use the ARPEGGIATOR [ON/OFF] key to turn it on. However, it is not possible to turn on an arpeggiator for which the “Arpeggiator Run” (P7: 7–1a/2a) parameter A or B is not checked. Also, the arpeggiator will not operate if it has not been assigned to a timbre in “Arpeggiator Assign” (P7: 7–1a/2a).

In each of the above cases, you can modify the settings of the arpeggio pattern even if the arpeggiator is not turned on. When editing a pattern, it is a good idea to turn on the arpeggiator and make sure that it is the pattern that you wish to edit.

 **If you moved here from Sampling mode:** The arpeggiator will not turn on, nor will it be possible to edit the arpeggio pattern.

 If you want the edited user arpeggio pattern settings to be backed up even when the power is turned off, you must write them into memory. Select the “Write Arpeggio Pattern” page menu command to access the Write Arpeggio Pattern dialog box. Alternatively, press the SEQUENCER [REC/WRITE] key to access the “Update Arpeggio Patterns” dialog box. Then press the **OK button** to write the edited data.

 For details on creating an arpeggio pattern, refer to BG p.130.

## 6–1: Pattern Setup



## 6-1a: Arpeggio Select, , Pattern, Length, Octave, Resolution, Sort, Latch, Key Sync., Keyboard

### Arpeggio Select [A, B]

If you have moved here from Combination, Sequencer or Song Play mode and edit an arpeggio pattern, you must select either arpeggiator **A** or **B** as the pattern to edit. Your editing will apply only to the selected one. **B** will not be displayed if you moved here from Program mode.

### (Tempo) [040...240, EXT]

Specifies the tempo.

This can also be adjusted by the ARPEGGIATOR [TEMPO] knob. If “MIDI Clock” (1-1a) is set to **External MIDI** or **External mLAN**, this will indicate EXT, and the arpeggiator will synchronize to MIDI Clock messages from an external MIDI device.

### Pattern [P000...P004, U000(I-A/B)...U506(User)]

Selects the pattern that you want to edit.

P000...P004	Preset arpeggio patterns
U000(I-A/B)...U199(I-A/B)	Preloaded arpeggio patterns
U200(E-A)...U215(E-A) U216(E-B)...U231(E-B) U232(E-C)...U247(E-C) U248(E-D)...U263(E-D) U264(E-E)...U279(E-E) U280(E-F)...U295(E-F) U296(E-G)...U311(E-G)	EXB-PCM series arpeggio patterns
U312(User)...U506(User)	User arpeggio patterns (some preloaded arpeggio patterns)

**note** If you want to edit an arpeggio pattern (such as a preloaded arpeggio pattern) that is also used by another program, it is a good idea to use the page menu command “Copy Arpeggio Pattern” to copy the arpeggio pattern to an unused number **U312 (User)–U506 (User)**, and then to edit the copy. Also, U200 (E-A)–U311 (E-G) are normally used to load arpeggio patterns for the EXB-PCM series options (some models do not include arpeggio patterns).

**note** If you want to edit the arpeggio pattern name, execute the page menu command “Rename Arpeggio Pattern.”

### Length (Pattern Length) [01...48]

Specifies the length of the arpeggio pattern. The arpeggio pattern will play the number of steps you specify here at the note value interval specified by “Resolution,” and will then begin again. This is not valid for preset arpeggio patterns **P000–P004**.

### Octave [1, 2, 3, 4]

### Resolution [, , , ,



### Sort [Off, On]

### Latch [Off, On]

### Key Sync. [Off, On]

### Keyboard [Off, On]

 Program P7 “7-1: Arpeg. Setup.”

 “Pattern,” “ (Tempo),” “Octave,” “Resolution,” “Sort,” “Latch,” “Key Sync.,” and “Keyboard” are parameters that can be set in Program, Combination, Song, and Song Play modes, but you can also set them here. If you move here from Program or Combination mode and set these parameters, you must return to the original mode and write them. These parameters cannot be written by the “Write Arpeggio Patterns” command in this page.

## 6-1b: Arpeggio Pattern Setup

 These parameters are not valid for preset patterns **P000–P004**.

### Arpeggio Tone Mode [Normal, Fixed Note]

This selects the **Tone** type of the arpeggio pattern.

**Normal:** This is the conventional arpeggiator type. Each **Tone** in the arpeggio will be the pitch of the note number that you are pressing on the keyboard.

**Fixed Note:** The note number of each **tone** will be fixed. The note numbers played on the keyboard will be ignored, and the arpeggio will sound using the pitches you specify for the **Tones**. Note numbers from the keyboard will only control the trigger timing of the arpeggiator. Fixed Note mode is ideal for arpeggio patterns that you are using as drum patterns.

In the P6: User Arpeggio, Pattern Edit page, the **Tone** indicators will be “●” when **Normal** is selected here, or “○” when **Fixed Note** is selected.

### Arpeggio Type [As Played...Up&Down]

Specifies the relationship between the arpeggio notes specified from the keyboard and the **Tone** at each step.

**As Played:** If there are more **Tones** in a step than arpeggio notes specified (notes played on the keyboard), those steps will not sound.

**As Played (Fill):** If there are more **Tones** in a step than arpeggio notes specified (notes played on the keyboard), the last arpeggio note (the last-played note if “**Sort**” is **Off**, or the highest note if “**Sort**” is **On**) will sound for those steps.

**Running Up:** If there are more **Tones** in a step than arpeggio notes specified (notes played on the keyboard), the arpeggio will return to the first note (the first-pressed note if “**Sort**” is **Off**, or the lowest note if “**Sort**” is **On**) and sound it.

**Up&Down:** If there are more **Tones** in a step than arpeggio notes specified (notes played on the keyboard), the arpeggio will return in reverse direction from the last arpeggio note back toward the first.

**Example)**

If you set “**Length**” to **04**, “**Step No.**” **01** to **Tone0**, “**Step No.**” **02** to **Tone1**,” “**Step No.**” **03** to **Tone2**, “**Step No.**” **04** to **Tone3**, and simultaneously play three notes to produce an arpeggio, the following results will be produced depending on the “**Arpeggio Type**.”

**As Played:** 0 → 1 → 2 → rest → 0 → 1 → 2 → rest → 0 ...

**As Played (Fill):** 0 → 1 → 2 → 2 → 0 → 1 → 2 → 2 → 0 ...

**Running Up:** 0 → 1 → 2 → 0 → 0 → 1 → 2 → 0 → 0 ...

**Up&Down:** 0 → 1 → 2 → 1 → 0 → 1 → 2 → 1 → 0 ...

### Octave Motion [Up, Down, Both, Parallel]

Specifies the operation when “**Octave**” is set to 2-4 octaves.

**Up:** Notes will repeatedly ascend within the specified range of octaves.

**Down:** Notes will repeatedly descend within the specified number of octaves.

**Both:** Notes will repeatedly ascend and descend within the specified number of octaves.

**Parallel:** The notes of the specified octaves will sound simultaneously.

### Fixed Note Mode [Trigger As Played, Trigger All Tones]

When the “**Arpeggio Tone Mode**” is **Fixed Note**, specify the condition that will trigger the **Tones**.

**Trigger As Played:** The **Tones** will be triggered according to the number of keys pressed.

**Trigger All Tones:** Pressing a single key will trigger all **Tones**.

### Example)

We will use a “**Arpeggio Tone Mode**” **Fixed Note** pattern on drums. **Tone 1** is assigned a note number that will sound a kick, **Tone 2** a snare, and **Tone 3** a hi-hat.

With a setting of **Trigger As Played**, pressing one key will sound only **Tone 1** (kick). Pressing two keys will sound **Tone 1** (kick) and **Tone 2** (snare). Pressing three keys will sound all three Tones 1–3 (kick, snare, hi-hat). If the “**Velocity**” of each Tone is set to **Key**, each **Tone** will be sounded at the velocity with which each key was played.

With a setting of **Trigger All Tones**, playing one key is sufficient to sound all three; **Tone 1** (kick), **Tone 2** (snare), and **Tone 3** (hi-hat). If the “**Velocity**” of each Tone is set to **Key**, the Tones will be sounded at the corresponding velocity each time a key is pressed.

⚠ Be aware that when you execute “**Copy Arpeggio Pattern**,” all settings of the currently selected arpeggio pattern will be overwritten.

## 6–2: Pattern Edit

Here you can input **Tones 0–11** for each step **01 to 48**. “**Step**” can be a maximum of 48 steps, and **Tone** corresponds to up to twelve notes for the (up to) twelve keys pressed simultaneously. If “**Sort**” (6–1a) is **checked**, the notes that were pressed will correspond in ascending order of pitch to **Tones 0, 1**, etc. If “**Sort**” (6–1a) is **unchecked**, the notes that were pressed will correspond to **Tones 0, 1**, etc. in the order in which they were pressed.

⚠ These parameters are not valid for preset patterns P000–P004.

### ▼ 6–1: Page Menu Command

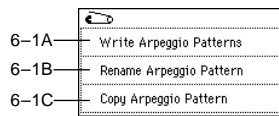

#### 6–1A: Write Arpeggio Patterns

This command writes user arpeggio patterns U000 (I-A/B)–U506 (User).

- 1 Select “**Write Arpeggio Patterns**” to access the dialog box.
- 2 To execute the Write command press the **OK** button. To cancel without executing press the **Cancel** button. You can also press the SEQUENCER [REC/WRITE] key to write arpeggio patterns in the same way as the “Write Arpeggio Patterns” command. Press the SEQUENCER [REC/WRITE] key to access the dialog box, and write the data.

⚠ “Pattern,” “♩ (Tempo),” “Octave,” “Resolution,” “Sort,” “Latch,” “Key Sync,” and “Keyboard” are parameters that are set in Program, Combination, Song, and Song Play modes. The Write operation executed here does not save these parameters. If you move here from Program or Combination mode and set these parameters, you must return to the original mode and write them.

#### 6–1B: Rename Arpeggio Pattern

This command renames the selected user arpeggio pattern. Up to sixteen characters can be used. (≡BG p.57) Preset patterns P000–P004 cannot be renamed.

#### 6–1C: Copy Arpeggio Pattern

This command copies the settings of another user arpeggio pattern to the currently selected arpeggio pattern. It is not possible to copy from a preset arpeggio pattern P000–P004.

- 1 Select “**Copy Arpeggio Pattern**” to access the dialog box.

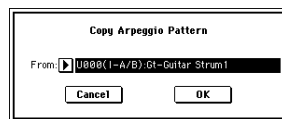

- 2 Select the copy source arpeggio pattern “**From**.”
- 3 To execute the Copy Arpeggio Pattern command press the **OK** button. To cancel without executing press the **Cancel** button.

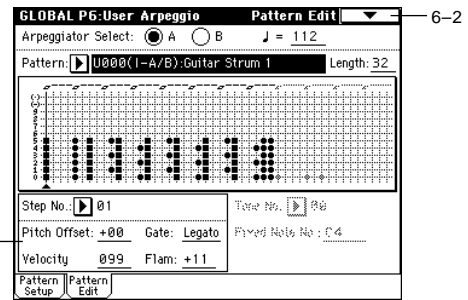

#### 6–2a: Step No., Pitch Offset, Gate, Velocity, Flam, Tone No., Fixed Note No.

##### Step No. (Step Number) [01...48]

Selects the step that you wish to edit, and set/reset each **Tone**. When the “**Step No**” is selected, use the numeric keys to input the **Tones**. Numeric keys [0]–[9] correspond to **Tones 0–9**, [–] corresponds to **Tone 10**, and [./10’s HOLD] to **Tone 11**. Each time you press a key, the **Tone** will be set or reset.

When “**Arpeggio Tone Mode**” (6–1b) is **Normal**, the display will indicate “●.” When set to **Fixed Note**, the display will indicate “○.”

If you wish to delete all **Tones** of a step, use the “Delete” page menu command. To insert a blank step, use the “Insert” page menu command.

##### Pitch Offset [–48...+48]

For each step, the pitch corresponding to the **Tone** can be raised or lowered in semitone steps. This lets you make settings for the same tone in each step to create a melody, or to make settings for two or more tones in each step to play parallel chords.

##### Gate [Off, 001...100%, Legato]

**Off**: That step will not sound even if **Tones** have been specified.

**Legato**: Notes will continue sounding until the same **Tone** is sounded next, or until the pattern returns to the beginning.

At this time, the display will change to “□” or “■.” This setting is valid when the Program, Combination, Song, or Song Play mode parameter “Gate” (Program P7: 7–1a, Combination P7: 7–2a/3a, Sequencer/Song Play P7: 7–3a/4a) is set to **Step**. When making this setting, make sure that “Gate” is set to **Step** in the mode from which you arrived here.

**Velocity** [001...127, Key]

**Key:** The Tone of the step will sound with the velocity at which the key was played.

**001-127:** The specified velocity value will always be used. This setting is valid when the Program, Combination, Song, or Song Play mode parameter "Velocity" (Program P7: 7-1a, Combination P7: 7-2a/3a, Sequencer/Song Play P7: 7-3a/4a) is set to **Step**.

When making this setting, make sure that "Velocity" is set to **Step** in the mode from which you arrived here.

**Flam** [-99...+99]

Specifies how the note timing will be skewed when two or more **Tones** are specified in the same step.

**00:** All **Tones** will sound simultaneously.  
**+01-+99:** The timing of the notes will be skewed in the order of the **Tone** number. (When "Sort" is **ON**, from low note to high note. When "Sort" is **OFF**, in the order in which keys were pressed.)  
**-01- -99:** The timing of the notes will be skewed in the opposite direction as "+."  
 To simulate chords strummed on a guitar, it is effective to set "+" values for odd-numbered steps and "-" values for even-numbered steps.  
 This is not valid for preset patterns P000-P004.

**Tone No. (Tone Number)** [01...12]

This is valid when "Arpeggio Tone Mode" (6-1b) is set to **Fixed Note**. This selects the Tone.

**Fixed Note No. (Fixed Note Number)** [C-1...G9]

Specifies the note number for the selected **Tone**. You can also input this value by holding down the [ENTER] key and pressing a note on the keyboard.

▼ **6-2: Page Menu Command**

6-1A	Write Arpeggio Pattern	Copy Step	6-2B
6-1B	Rename Arpeggio Pattern	Delete Step	6-2C
6-1C	Copy Arpeggio Pattern	Insert Step	6-2D
6-2A	Initialize Steps	Rotate Step	6-2E

**6-2A: Initialize Steps**

This command initializes the step parameters ("Tone," "Pitch Offset," "Gate," "Velocity," "Flam") of the arpeggio pattern.

- 1 Select "**Initialize Steps**" to access the dialog box.



- 2 **Empty** will initialize all tones to a blank state. **Full** will initialize all tones to a full state.
- 3 To execute the Initialize Steps operation, press the **OK button**. To cancel, press the **Cancel button**.

**6-2B: Copy Step**

This command copies the settings of a specific step. The settings of two or more adjacent steps can also be copied together.

- 1 Select "**Copy Step**" to access the dialog box.

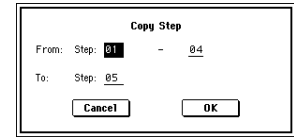

- 2 In "**From Step**," select the range of steps that you wish to copy.
- 3 In "**To Step**," select the copy destination step. If you selected more than one step in "From Step," the steps will be copied starting at "To Step" and continuing through the steps to the right.
- 4 To execute the Copy Step operation, press the **OK button**. To cancel, press the **Cancel button**.

**6-2C: Delete Step**

This command deletes the step parameters ("Tone," "Pitch Offset," "Gate," "Velocity," "Flam") of the currently selected step number. Subsequent steps will move one column toward the left.

- 1 Select "**Delete Step**" to access the dialog box.



- 2 To execute the Delete Step operation, press the **OK button**. To cancel without executing, press the **Cancel button**.

**6-2D: Insert Step**

This command inserts an empty step into the currently selected step number. Subsequent steps will be moved one step to the right.

- 1 Select "**Insert Step**" to access the dialog box.

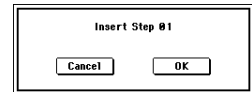

- 2 To execute the Insert Step operation, press the **OK button**. To cancel without executing, press the **Cancel button**.

**6-2E: Rotate Step**

This command rotates the step settings.

- 1 Select "**Rotate Step**" to access the dialog box.

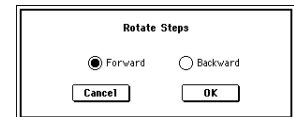

- 2 Select the type "Direction" of rotation. For example, suppose there is a pattern of "**Length**" 4. If you select **Forward**, the settings of Step 1 will be rewritten to 2, Step 2 → 3, Step 3 → 4, Step 4 → 1. If you select **Backward**, the settings of Step 1 will be rewritten to 4, Step 2 → 1, Step 3 → 2, Step 4 → 3.
- 3 To execute the Rotate Step operation, press the **OK button**. To cancel without executing, press the **Cancel button**.

# 7. Disk mode

In this mode, you can save and load various types of internal memory data to and from a floppy disk, the internal hard drive, a CDRW-1 option, or a connected external SCSI device.

You can also create an audio CD from WAVE files and listen to it.

In this mode you can also copy or delete files, or format a disk.

The following media can be used.

## Floppy disks

MS-DOS format 3.5 inch 2HD or 2DD

Floppy disk capacity after formatting on the TRITON STUDIO:

2HD: 1.44 Mbyte (18 sectors/track), 2DD: 720 Kbyte (9 sectors/track)

## Hard drives, removable media drives

MS-DOS format FAT16 and FAT32 supported

Recognizable FAT32: up to 2 Terabytes = 2,000 Gbyte capacity:  
FAT16: up to 4 Gbyte

(For details on connecting an external SCSI device and setting the ID, refer to p.298.)

## CD-R/RW

UDF format is supported. UDF format CD-R/RW can be written and read. (Packet writing support p.299)

CD-DA (audio data) can be recorded/played, and ISO9660 (level 1) format can be read.

## Files, directories, and icons

The TRITON STUDIO manages data on disks and other media in a hierarchical manner, using files and directories. The contents of a file (whether it is a file or a directory) are indicated not only by the name but also graphically by an icon. Files and directories have differently shaped icons.

The TRITON STUDIO collectively refers to files and directories recognizable by MS-DOS (readable by a MS-DOS computer), and UDF format and ISO9660 format files and directories as "DOS files" and "DOS directories." Different types of DOS file are distinguished by the extension added to their filename.

In the case of a DOS file with an extension other than listed below, selecting "Load selected" to access the dialog box will cause the file to be considered to be a Standard MIDI File (SMF). However, in this case non-SMF files cannot be loaded.

Extension	Type
.PCG	Program, combination, drum kit, user arpeggio pattern, global settings (TRITON STUDIO format)
.SNG	Song, cue list (TRITON STUDIO format)
.JKB	Jukebox list (TRITON STUDIO format)
.MID	Standard MIDI File (SMF)
.EXL	MIDI exclusive data
.KMP	Korg Multisample Parameter file (Korg format)
.KSF	Korg Sample File (Korg format)
.KSC	Korg Script File (Korg format)
.AIF	AIFF file
.WAV	WAVE file
.KCD	Audio track list (TRITON STUDIO format)

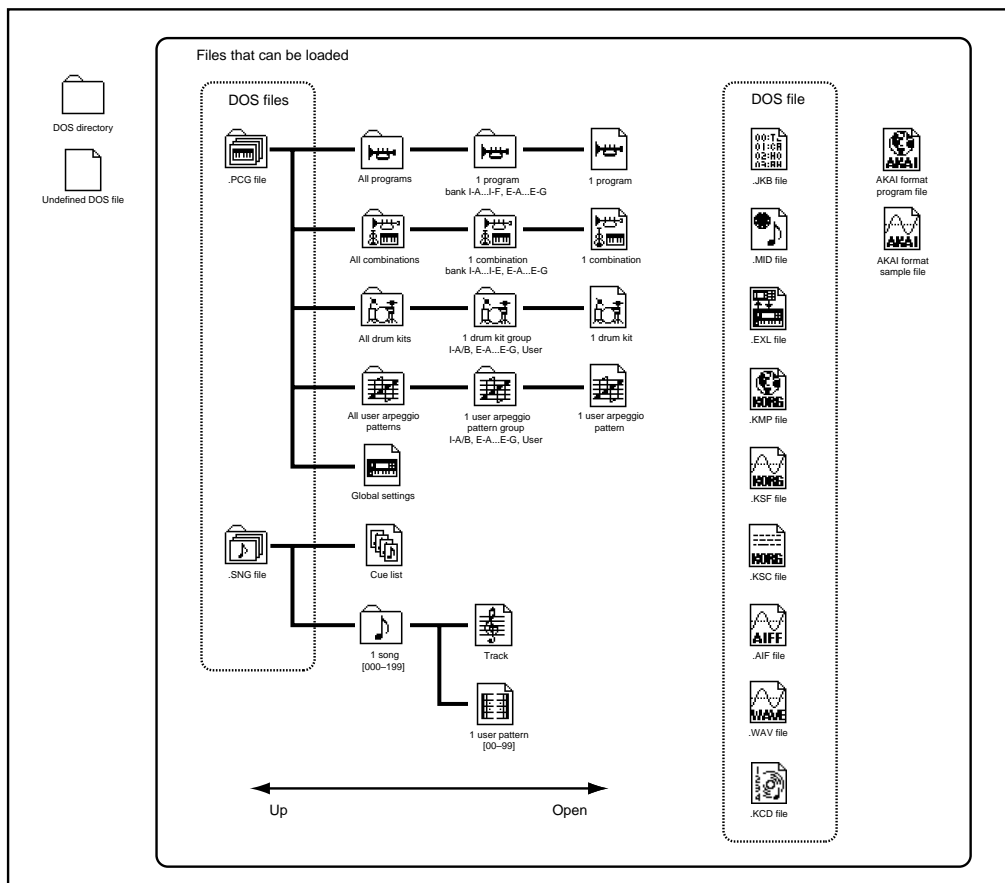

 .JKB files cannot be loaded or saved in Disk mode – only in Song Play mode.

When TRITON STUDIO data is saved, one of these filename extensions will be added automatically, according to the type of data. If these filename extensions are modified on a computer, the file will be treated as an undefined file when it is reloaded back into the TRITON STUDIO, and will be handled as a Standard MIDI File.

Files handled by the TRITON STUDIO have the shown in the previous page structure. Since .PCG and .SNG files can be opened to divide their contents, they are displayed as directory icons.

For details on compatibility with other devices such as the TRITON/pro/proX and the TRITON-Rack (see p.279).

## 0-1: Load

Here you can load a selected file or directory into internal memory.

Use the **Open button** and **Up button** to select the desired file or directory. Then use the “Load selected” (0-1C) page menu command to select and load the data.

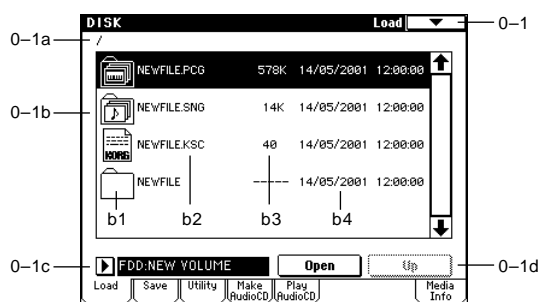

**note** Within a .PCG file, you can listen to a program, combination, user drum kit, or user arpeggio pattern file (whose bank and group you opened) directly from the media simply by selecting it in the directory window; i.e., you do not have to load it into internal memory. In the case of a combination, each timbre will sound using the programs in internal memory. In the case of a user drum kit or user arpeggio pattern, the sound parameters of the program that was selected before entering Disk mode will be used.

**note** In the Load, Save, and Utility pages, you can select a WAVE file whose sampling rate (frequency) is 44.1 kHz or 48 kHz, and press the SAMPLING [START/STOP] key to play back the sample. If you select a WAVE file that can be played back, the display will indicate “(Sampling START/STOP plays selected file).”

 While a WAVE file is playing back, the TRITON STUDIO will not sound in response to its keyboard or to note data received at MIDI IN. The arpeggiator will also stop.

### 0-1a: Current directory

The directory currently selected for processing is referred to as the “current directory.”

The LCD screen will show the full path name of the directory. A slash “/” character is used as the delimiter between directory levels. To change the current directory, use the Open button and Up button (0-1d).

### 0-1b: Directory window

#### Directory window

File information for the current directory is shown here. You can select a file or directory in this window.

#### b1: File/icon

The icon indicates the type of file.

For details on icons shown in the previous page.

#### b2: File name

This is the name of the file (DOS file).

If the page menu command “Translation” (0-1B) is turned on, the DOS filename of a .KMP (Korg multisample parameter) file or .KSF (Korg sample) file that is loaded will be replaced in the display by the multisample name or sample name that was specified in Sampling mode.

#### b3: Size

This is the size of the file (in bytes).

#### Save date and time

This is the date and time at which the file was saved. From the left, this is the day, month, year, hour, minute, and second. The TRITON STUDIO contains a calendar and clock. When a file is saved, the date and time will be assigned automatically. You can set the date and time in “Set Date/Time” (0-3E).

### 0-1c: Drive select

#### Drive select [FDD, ID0...6, HDD, CDD: Name]

Selects the device (floppy disk or hard disk etc.) that will be used for loading and saving.

The volume label assigned to the media will be displayed.

**FDD:** Floppy disk drive

**ID0...6:** External SCSI device ID0-6

**HDD:** Internal hard drive

**CDD:** Internal CD-RW drive (if the CDRW-1 option is installed)

**No Label:** Media that has no volume label

**Unformatted:** Media that has not been formatted

**No Disc:** Media is not inserted in the CD-ROM or CD-R/RW drive

**No Disk:** Media is not inserted in the removable media drive (other than a CD-ROM or CD-R/RW drive)

The volume label display of a CD-R/RW drive will depend on the inserted media and the page.

**Blank Disc:** Blank media. (If you want to use this disc as a packet-writing-compatible disc, you must format it (see p.299). If you want to use this disc to create an audio CD, you do not need to format it.)

**Media volume label:** Media that contains data

**Audio CD:** Audio CD

**Unfinalized:** An audio CD that has not been finalized

**Audio CD or media volume label:** Media that contains both data and audio. In this case, “Audio CD” will be displayed in both the Make Audio CD page and the Play Audio CD page, and the volume label of the media will be displayed in all other pages.

## 0-1d: Open button, Up button

### Open button

When you press the **Open button**, the directory will open, and the current directory will move one level downward. This can be used when a directory has been selected in the directory window.

### Up button

When you press the **Up button**, the directory will move one level upward.

## ▼ 0-1: Page Menu Command

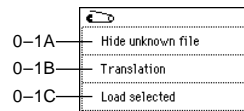

### 0-1A: Hide unknown files

**Checked:** Undefined files will not be displayed in the directory window. However, this is valid only if the current directory is a DOS directory.

### 0-1B: Translation

**Checked:** The multisample names and sample names used in Sampling mode will be displayed instead of the DOS file names, a .KMP (Korg Multisample Parameter) and .KSF (Korg Sample File).

### 0-1C: Load selected

This command loads the file or directory that was selected in the "directory window" (0-1b) into the internal memory. When you choose "Load selected," a dialog box will appear. The dialog box will differ depending on the type of file to be loaded.

If a file to be loaded cannot be found, or when loading a file that was saved across media

If a necessary file cannot be found in the current directory or in a lower directory when loading multisamples, sample data, .PCG, or .SNG files, a dialog box like the following (Where is a ...) will appear.

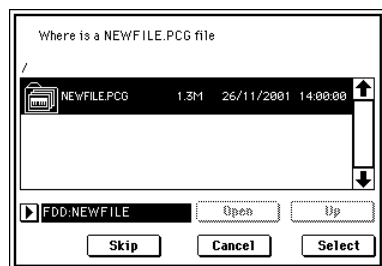

This will appear in the following cases.

- If when loading a .KSC file, a .KMP file used by it cannot be found.
- If when loading a .KMP file, a .KSF file cannot be found
- If when loading an S1000/S3000 format Program file, a Sample file cannot be found.
- If loading a .KSF file that was larger than the media capacity and was therefore saved on multiple media, when the first media has been loaded and the second disk etc. needs to be specified.
- When loading a .PCG file that was split across two or more volumes of media, when the first volume has been loaded and the second disk etc. is now required.

- When loading a .PCG file and also simultaneously loading a .SNG file, if the identically-named .SNG file are not found in the current directory after loading the .PCG file.

If this dialog box appears, take the following action.

- ① Select the directory that contains the file indicated by "Where is a..." If the specified file is located on another disk, exchange disks. Then press the directory window in the LCD screen to make the TRITON STUDIO recognize the disk, and select the appropriate directory.

 It is not possible to open .PCG or .SNG files in the "Where is a ..." dialog box. The **Open button** cannot be used for .PCG or .SNG files.

- ② Press the **Select button** to resume loading. Loading will be aborted if you press the **Cancel button**. If you want to abort the loading process, press the **OK button**. If you press the **Skip button**, the indicated file will be skipped, and the next file will be loaded.

Except for special situations such as when the disk containing the indicated file has been damaged or cannot be found, you should use the **Select button** to continue the loading process.

### 1) Load .PCG:

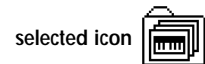

Data in the .PCG file will be loaded.

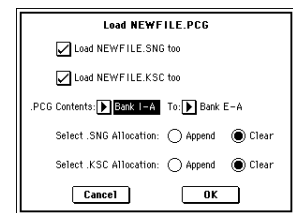

- ① Use the "Load \*\*\*\*\*.SNG too" and "Load \*\*\*\*\*.KSC too" check boxes to select the .SNG file and .KSC file.
- If you **check** "Load \*\*\*\*\*.SNG too," the file with an identical name to the .PCG file and an extension of .SNG will also be loaded.
- If you **check** "Load \*\*\*\*\*.KSC too," the file with an identical name to the .PCG file and an extension of .KSC will also be loaded.

If this file does not exist in the current directory, load it as described in the above procedure "If a file to be loaded cannot be found,..."

- ② In ".PCG Contents," specify the data to be loaded.

**All:** Load all data from the .PCG file.

**Bank I-A-I-E, E-A-E-G:** Load data of the specified bank. In this case, use "To" **Bank I-A-I-E, E-A-E-G** to specify the load destination bank. When you execute the load, the combinations, programs, drum kits, and user arpeggio pattern data of only the specified bank will be loaded to the load destination bank. Global settings will not be loaded.

The bank of the programs used by combinations, the numbers of user arpeggio pattern used by combinations/programs, and the number of the drum kits used by the Programs will be corrected automatically so that they are appropriate.

Similarly if a .SNG file is loaded simultaneously, the bank of the programs used by tracks of the Song (or if there are track/pattern events, the bank of the program within the event) will be corrected automatically so that they are appropriate.

 When loading a .PCG file from the floppy disk included with a EXB-PCM series option, you will normally use this method. (BG p.65)



- ⚡ If data of the specified bank is completely absent from the .PCG file, an error of “No readable data” will be displayed, and the load operation will be halted.
- ⚡ If the program data of the specified bank is not found in the .PCG file, the program banks of the combination or multi timbres/tracks will not be set.
- ⚡ If the user arpeggio patterns of the specified bank are not found in the .PCG file, the user arpeggio pattern numbers of combinations, programs (/Song) will not be set .
- ⚡ If the drum kits of the specified bank are not found in the .PCG file, the drum kit number of the programs will not be set.
- ⚡ If you specify banks I-C/I-D/I-E when loading a TRITON, TRITON-Rack or TRITON STUDIO .PCG file, drum kits and user arpeggio patterns will not be loaded.
- ⚡ If you use **All** to load a .PCG file from the TRITON/TRITONpro/TRITONproX, the following dialog box will appear if that .PCG file contains either Drumkit Bank C/Bank D/Bank User or User Arpeggio Pattern Bank C/Bank D. In this dialog box you can specify the loading destination for each bank. Only banks existing in the .PCG file are valid. Unless you check the box of a valid bank, that bank will not be loaded. Press the **OK** button to execute loading, or press the **Cancel** button to cancel without loading.

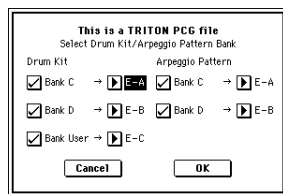

- ③ If “**Load \*\*\*\*\* .SNG too**” is checked, you can use “**Select .SNG Allocation**” to specify how song data within the .SNG file will be loaded.  
**Append:** The multi data will be loaded starting at the number that follows the last song data in memory. The song data within the .SNG file that is being loaded will be packed into the available locations (See the following diagram). Select this method when you wish to load song data from disk without erasing the song data that is already in memory.  
 Cue list data will not be loaded.

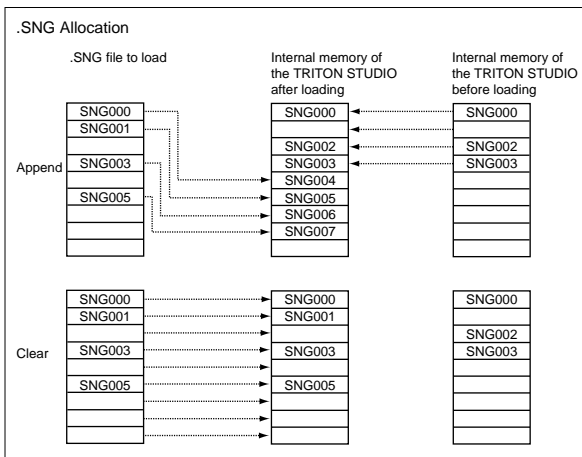

**Clear:** Erases all cue list data and song data from internal memory, and load the cue list data together with the state of the song data as it was when saved (See the following diagram). Select this when you want to reproduce the saved state immediately after power-on, etc.

- ④ “**.KSC Allocation**” is valid if “**Load \*\*\*\*\*.KSC too**” has been checked. You can specify how the multisamples and samples in the .KSC file will be loaded.

**Append:** Samples will be loaded starting at the first unoccupied number following the last multisample or sample that currently exists in memory (i.e., by having been sampled or loaded). At this time, only the valid multisamples or samples will be loaded, and they will be organized in numerical order. (See the following diagram)

At the same time, programs within the .PCG file that use multisamples from the .KSC file will automatically have the multisample settings for their oscillators rewritten so that each program uses the correct multisample. Drum kits in the .PCG file that use samples from the .KSC file will automatically have the sample settings for the drum kit rewritten so that the drum kit uses the correct samples.

**Clear:** All multisamples and samples currently in memory will be erased, and the multisamples and samples will be loaded in the same configuration in which they were saved. (See the following diagram)

If memory already contains multisamples or samples that you wish to keep, and you wish to load additional multisamples or samples from disk, select **Append**.

If the power has just been turned on, or you want to reproduce the state that was saved, select **Clear**.

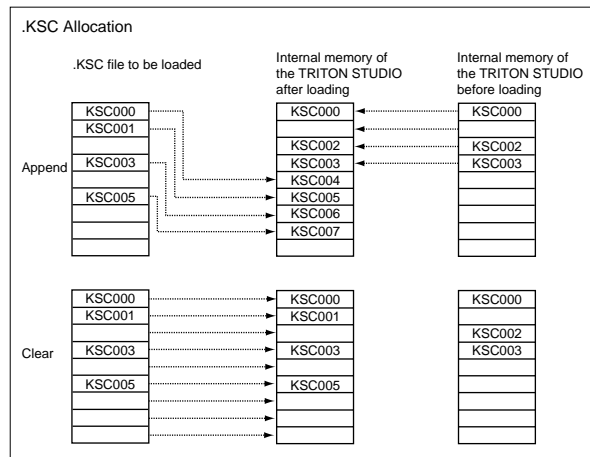

- ⑤ To load the data, press the **OK** button. To cancel without loading, press the **Cancel** button.

## 2) Load Programs:

selected icon



All program data from a .PCG file will be loaded.

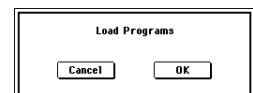

- ① To load the data, press the **OK** button. To cancel without loading, press the **Cancel** button.

3) Load Program Bank [Bank I-A...I-E, Bank E-A...E-G]:

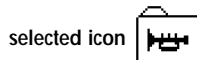

All program data of the selected bank will be loaded into the bank you specify.

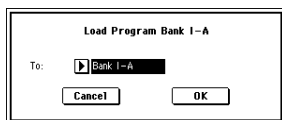

- 1 In "To," select the loading destination bank.

**Note** Bank I-F program data can be loaded only into bank I-F. If you select bank I-A-I-E, E-A-E-G it will not be possible to select bank I-F in "To."

- 2 To load the data, press the **OK button**. To cancel without loading, press the **Cancel button**.

4) Load a Program:

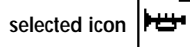

Data for the selected program will be loaded into the program number you specify.

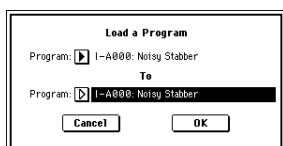

- 1 If you wish to load a program other than the one already selected, use "Program" (upper line) to select the program that you wish to load.

**note** The selected program can be played from the keyboard even before you load it. This is convenient when you want to audition the program to be loaded. (see p.156)

- 2 In "To Program," (lower line) select the bank and program into which the data will be loaded. When you press the popup button, the "Select Destination" window (see Program P0: 0-1a) will appear.

**Note** Data for one bank I-F program can be loaded only into bank I-F. If bank I-A - I-E or E-A - E-G is selected in "Program" (upper line), bank I-F cannot be selected in "To program" (lower line).

- 3 To load the data, press the **OK button**. To cancel without loading, press the **Cancel button**.

5) Load Combinations:

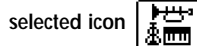

All combinations in the .PCG file will be loaded.

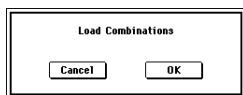

- 1 To load the data, press the **OK button**. To cancel without loading, press the **Cancel button**.

6) Load Combination Bank [I-A...I-E, E-A...E-G]:

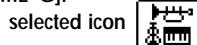

All combinations in the selected bank will be loaded into the bank you specify.

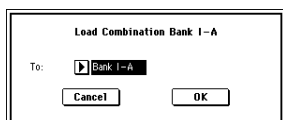

- 1 In "To," specify the loading destination bank.
- 2 To load the data, press the **OK button**. To cancel without loading, press the **Cancel button**.

7) Load a Combination:

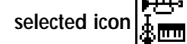

The combination you select will be loaded into the loading destination combination number you specify.



- 1 If you wish to load a combination other than the one already selected, use "Combination" (upper line) to select the combination that you wish to load.

**note** The selected combination can be played from the keyboard even before you load it. This is convenient when you want to audition the combination to be loaded. (see p.156)

- 2 In "To Combination" (lower line), select the bank and combination into which the data will be loaded. When you press the popup button, the "Select Destination" window (see Combination P0: 0-1a) will appear.
- 3 To load the data, press the **OK button**. To cancel without loading, press the **Cancel button**.

8) Load Drum Kits:

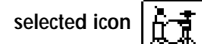

All drum kits in the .PCG file will be loaded.



- 1 To load the data, press the **OK button**. To cancel without loading, press the **Cancel button**.

9) Load Drum Kit

[00-15(I-A/B), 16-31(E-A)...112-127(E-G), 128-143(User)]:

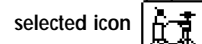

All drum kit data of the selected drum kit block will be loaded into the drum kit block you specify as the loading destination.

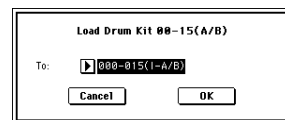

- 1 In "To," select the drum kit block into which the data will be loaded.
- 2 To load the data, press the **OK button**. To cancel without loading, press the **Cancel button**.

10) Load a Drum Kit:

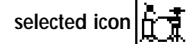

The selected drum kit will be loaded into the drum kit number you specify as the loading destination.



- 1 If you wish to load a drum kit other than the one already selected, use "Drum Kit" (upper line) to re-select the drum kit you wish to load.

**note** The selected drum kit can be played from the keyboard even before you load it. This is convenient when you want to audition the drum kit to be loaded. (☞p.156)

- ② In "To Drum Kit" (lower line), select the loading destination drum kit.
- ③ To load the data, press the **OK button**. To cancel without loading, press the **Cancel button**.

**11) Load Arpeggio Patterns:**  selected icon  
All user arpeggio pattern data in the .PCG file will be loaded.

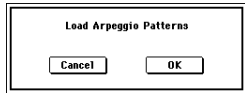

- ① To load the data, press the **OK button**. To cancel without loading, press the **Cancel button**.

**12) Load Arpeggio Pattern**  
[000-199(I-A/B), 200-215(E-A)...296-311(E-G), 312-506(User)]:

 selected icon  
All user arpeggio pattern data in the selected user arpeggio pattern block will be loaded into the user arpeggio pattern block you specify as the loading destination.

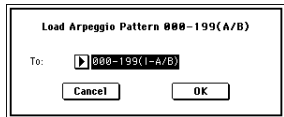

- ① In "To," select the loading destination user arpeggio pattern block.

 If you execute this command with 200 (E-A)-311 (E-G) specified as the loading destination for the selected user arpeggio pattern block 000-199 (I-A/B) and 312-506 (User), user arpeggio patterns 000-015 and 312-327 will be loaded. If you select 000-199 (I-A/B) and 312-506 (User) as the loading destination for 200 (E-A)-311 (E-G), the data will be loaded into user arpeggio patterns 000-015 and 312-327.

- ② To load the data, press the **OK button**. To cancel without loading, press the **Cancel button**.

**13) Load an Arpeggio Pattern:**  selected icon  
The selected user arpeggio pattern data will be loaded into the user arpeggio pattern number that you specify as the loading destination.

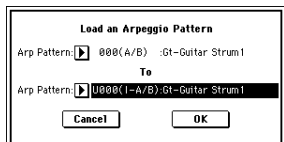

- ① If you wish to load an user arpeggio pattern other than the currently selected one, use "Arp Pattern" (upper line) to re-select the user arpeggio pattern that you wish to load.

**note** The selected user arpeggio pattern can be played from the keyboard even before you load it. This is convenient when you want to audition the user arpeggio pattern to be loaded. (☞p.156)

- ② In "To Arp Pattern" (lower line) specify the loading destination user arpeggio pattern.

- ③ To load the data, press the **OK button**. To cancel without loading, press the **Cancel button**.

**14) Load Global Setting:**  selected icon  
Global setting data in the .PCG file will be loaded.

 This includes Global mode parameters other than drum kits and user arpeggio patterns. Memory protect settings will not be loaded.

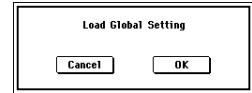

- ① To load the data, press the **OK button**. To cancel without loading, press the **Cancel button**.

**15) Load .SNG:**  selected icon  
All data in the .SNG file will be loaded.

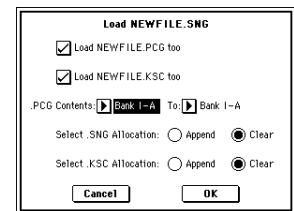

- ① Use "Select .SNG Allocation" to specify how the song data from the .SNG file will be loaded.

**Append:** The song will be loaded after the last song data that already exists in internal memory. At this time, the song data in the .SNG file being loaded will be packed forward. (☞p.158 ".SNG Allocation" diagram)

Select this when you want to add song data from disk without erasing the song data that currently exists in internal memory. Cue list data will not be loaded.

**Clear:** All cue list data and song data currently existing in internal memory will be erased, and the cue list data and the song data in the state in which it was saved will be loaded. (☞p.158 ".SNG Allocation" diagram)

Select this when you want to reproduce the saved state immediately after power-on, etc.

- ② If a .PCG file or .KSC file of the same filename exists in the current directory, you can select the "Load \*\*\*\*\*.PCG too" check box and "Load \*\*\*\*\*.KSC too" check box.

☞ "1) Load .PCG; ①"

- If you check "Load \*\*\*\*\*.PCG too," use ".PCG Contents" to specify the bank within the .PCG file.

☞ "1) Load .PCG; ①"

- If you check "Load \*\*\*\*\*.KSC too," use "Select .KSC Allocation" to specify how the song data from the .KSC file will be loaded.

☞ "1) Load .PCG; ④"

- ③ Press the **OK button** to load the data, or press the **Cancel button** to cancel without loading.

**16) Load Cue Lists:**  selected icon  
The cue list data in the .SNG file will be loaded.

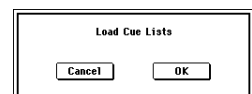

- ① To load the data, press the **OK button**. To cancel without loading, press the **Cancel button**.

### 17) Load a Song:

selected icon 

Data for the selected song will be loaded into the song number you specified as the load destination.



- 1 If you wish to load a song other than the selected song, use "Song" (upper line) to re-select the song to be loaded.
- 2 In "To Song" (lower line), select the loading destination song.
- 3 To load the data, press the **OK button**. To cancel without loading, press the **Cancel button**.

### 18) Load Tracks:

selected icon 

The event data of all tracks in the selected song will be loaded into the song you specify as the loading destination. However, it is not possible to specify an uncreated song as the loading destination.



- 1 In "Song," specify the loading destination song.
- 2 To load the data, press the **OK button**. To cancel without loading, press the **Cancel button**.

### 19) Load Pattern Data:

selected icon 

The selected user pattern will be loaded into a user pattern of the selected loading destination song. However, it is not possible to specify an uncreated song as the loading destination.

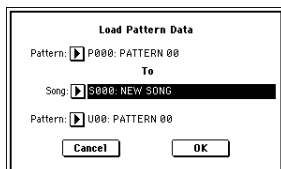

- 1 If you wish to load a user pattern other than the one already selected, use "Pattern" (upper line) to re-select the user pattern that you wish to load.
- 2 In "To Song" and "Pattern" (lower line), select the loading destination song and user pattern.
- 3 To load the data, press the **OK button**. To cancel without loading, press the **Cancel button**.

### 20) Load Standard MIDI File:

selected icon 

The selected Standard MIDI File will be loaded into the song number you select as the loading destination.

If you have selected an undefined file, it will be considered to be a Standard MIDI File, and will be loaded into the song you specify as the loading destination.



- 1 In "Song," select the loading destination song.
- 2 To load the data, press the **OK button**. To cancel without loading, press the **Cancel button**.

 If you select an undefined file and choose "Load selected," the file will be assumed to be a Standard MIDI File, and the "Load Standard MIDI File" dialog box will appear. When you execute loading, the file will be loaded into the song that was specified as the loading destination. However if the file format is inappropriate, the operation will be invalid and an error message will be displayed.

 The program bank and program numbers loaded into the song will follow the "Bank Map (Global P0: 0-2a)" setting. If "**Bank Map**" is **KORG**, bank A will be selected for bank select 00.00 (MSB.LSB). If "Bank Map" is **GM(2)**, bank G will be selected.

### 21) Load and Transmit MIDI Exclusive Data:

selected icon 

All data in the .EXL file will be loaded, and transmitted from MIDI OUT or mLAN (if the EXB-mLAN option is installed).

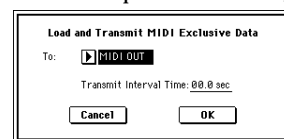

- 1 In "To," specify the output connector from which the data will be transmitted.  
**MIDI OUT:** the rear panel MIDI OUT connector  
**mLAN:** the rear panel mLAN connector (if the EXB-mLAN option is installed)
  - 2 If the .EXL file contains two or more exclusive data items, use "Transmit Interval Time" to specify the time interval that will be inserted between each item of exclusive data. If you are transmitting the data to another TRITON STUDIO, the required time interval will depend on the type of data. After transmitting all program data, you must allow an interval of approximately 2 seconds. For details refer to the Global mode section on Dump (≡ Global P1-1: Page Menu Command). For other MIDI devices, refer to their owner's manual.
  - 3 To load the data, press the **OK button**. To cancel without loading, press the **Cancel button**.
-  The maximum data size that can be transmitted is 1,048,576 bytes.

## Loading sample data

The paragraphs 22) Load .KSC, 23) Load .KMP, and 24) Load .KSF which follow explain how Korg format PCM data files are loaded into the sample memory (RAM) of the TRITON STUDIO.

### About the sample memory (RAM)

The TRITON STUDIO is shipped from the factory with 16 Mbytes of sample memory (RAM). (One 16 Mbyte SIMM is installed) By installing SIMM modules into any and all of the three 72 pin slots, you can expand the sample memory (RAM) to a maximum of 96 Mbytes (three 32 Mbyte SIMM's).

 It is not possible to load an individual sample that is larger than 16 Mbytes.

### Limitations on the maximum number that can be loaded

- Multisamples: up to 1,000
- Samples: up to 4,000
- Samples used by multisamples: up to 4,000

### About Korg format PCM data files

KSC files: 

Files with an filename extension of KSC (Korg Script) contain the names of .KMP and .KSF files.

When a .KSC file is loaded, the .KMP and .KSF files whose names it contains will also be loaded. This is a convenient way to load multiple multisamples and samples at once. When saving, a .KSC file and a directory with the same name as the .KSC file will be created. The .KMP files and .KSF files listed in the .KSC file will be saved in this directory.

KMP files: 

Files with a filename extension of KMP (Korg Multisample Parameter) contain the parameters which make up a single multisample. These parameters also include the filename of the .KSF files that are used by that multisample, so when a .KMP file is loaded, the necessary .KSF files will also be loaded at the same time.

When saving, a .KMP file and a directory with the same name will be created, and the .KSF files used by the multisample will be saved in this directory.

KSF files: 

Files with a filename extension of KSF (Korg Sample File) contain the parameters and waveform data which make up a single sample. A .KSF file can be used as one of the samples used by a multisample. A .KSF file can also be selected and used as a drum sample for a drum kit.

### Loading multiple files

You can use wild cards to specify multiple .KMP, .KSF, .AIF, .WAV, AKAI Program, and AKAI Sample files, and load them simultaneously.

**note** This capability can be used in 23) Load .KMP, 24) Load .KSF, 25) Load .AIF, 26) Load .WAV, 27) Load AKAI Sample File, and 28) Load AKAI Program file (p.164)

In the Load dialog box, press the text edit button to access the text input dialog box.

By specifying "\*" or "?" as wild cards in the selected filename, multiple sample files that have the same filename extension (same file format) and exist in the selected directory can be loaded simultaneously.



**Example)** A folder contains the following files, and you select "SFX\_A\_00.WAV" and specify wild cards to load multiple files simultaneously

PIANO.WAV, SFX\_A\_00.WAV, SFX\_A\_01.WAV, SFX\_B\_00.WAV, SFX\_B\_01.WAV, SFX\_C\_00.WAV

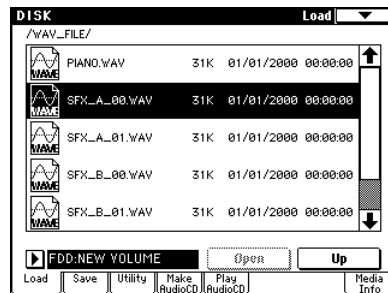

Select "SFX\_A\_00.WAV," and choose "Load selected" to access the dialog box.

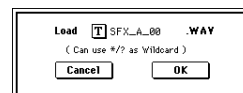

Press the **text edit button (T)** to access the text input dialog box, and specify the desired wildcards. (For the renaming procedure, refer to BG p.57)

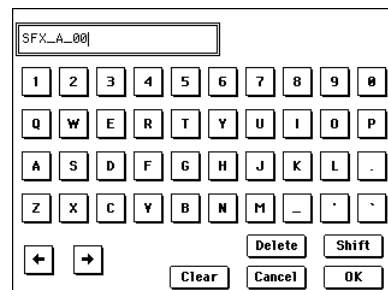

"\*" specifies the subsequent characters as a wild card.  
"?" specifies only one character as a wild card.

- 1) If you specify **SFX\_A\*** and execute loading, the following files will be loaded.  
SFX\_A\_00.WAV, SFX\_A\_01.WAV
- 2) If you specify **SFX\_?\_00** and execute loading, the following files will be loaded.  
SFX\_A\_00.WAV, SFX\_B\_00.WAV, SFX\_C\_00.WAV
- 3) If you specify **SFX\_\*\_00**, the result will be the same as if you specify "SFX\_\*", and the following files will be loaded.  
SFX\_A\_00.WAV, SFX\_A\_01.WAV, SFX\_B\_00.WAV, SFX\_B\_01.WAV, SFX\_C\_00.WAV
- 4) If you specify **\*** and execute loading, all of the WAVE files will be loaded as follows.  
PIANO.WAV, SFX\_A\_00.WAV, SFX\_A\_01.WAV, SFX\_B\_00.WAV, SFX\_B\_01.WAV, SFX\_C\_00.WAV

## 22) Load .KSC:

selected icon



The .KMP files and .KSF files listed in the .KSC file will be loaded as multisamples and samples respectively.

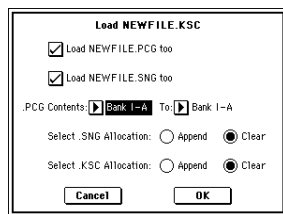

The .KMP files and .KSF files listed in the .KSC file are saved in a directory of the same name that is created automatically at the same time as the .KSC file.

- 1 "Select .KSC Allocation" allows you to specify how the multisamples and samples in the .KSC file will be loaded. **Append:** The data will be loaded into the numbers after the last multisample or sample number currently existing in sample memory (RAM) (i.e., that were previously sampled or loaded). In this case, only the valid multisamples and samples will be packed and loaded. (p.158 ".KSC Allocation" diagram)

If "Load \*\*\*\*\*.PCG too" is checked when you load the data, programs within the .PCG file that use multisamples from the .KSC file will automatically have the multi-sample settings for their oscillators rewritten so that each program uses the correct multisample. Drum kits in the .PCG file that use samples from the .KSC file will automatically have the sample settings for the drum kit rewritten so that the drum kit uses the correct samples.

**Clear:** All multisamples and samples currently existing in sample memory (RAM) will be cleared, and the multisamples and samples will be loaded in the same configuration as when they were saved (p.158 ".KSC Allocation" diagram).

Choose "Append" if sample memory (RAM) already contains multisamples and samples that you do not want to erase, and you would like to load additional multisamples and samples from media.

Choose "Clear" if you want to reproduce the state in which the data had been saved, for example immediately after power-on.

- 2 If the current directory contains a .PCG file or .SNG file of the same filename, you will be able to select the "Load \*\*\*\*\*.PCG too" and/or "Load \*\*\*\*\*.SNG too" checkboxes.

☞ "Load .PCG: ①"

- If you check "Load \*\*\*\*\*.PCG too," the .PCG file of the same name as the .KSC file will also be loaded.

☞ "Load .PCG: ②"

- If you check "Load \*\*\*\*\*.SNG too," the .SNG file of the same name as the .KSC file will also be loaded.

☞ "Load .PCG: ③"

- 3 To load the data, press the **OK button**. To cancel without loading, press the **Cancel button**.

If the .KSF files used by the .KMP file are not in the current directory or below it, a dialog box will appear, allowing you to specify the directory. Use the procedure "If a file to be loaded cannot be found,..." (p.157) to load the required .KSF files.

- ⚠ Since overflow checking of sample memory (RAM) is performed when loading each individual .KSF file, it is possible that an overflow may occur in the middle of the loading process.

## 23) Load .KMP:

selected icon



The selected .KMP file will be loaded as a multisample. The .KSF files used by the .KMP will also be loaded as samples.

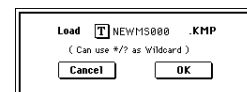

The .KSF files used by the .KMP file will be saved in an identically-named directory that is created automatically when the .KMP file is created.

- 1 To load the data, press the **OK button**. To cancel without loading, press the **Cancel button**.

Samples will be loaded starting at the first unoccupied number following the last multisample or sample that currently exists in the sample memory. Only valid multisamples or samples will be packed and loaded (Append load).

If the .KSF files used by the .KMP file are not in the current directory or below it, a dialog box will appear, allowing you to specify the directory. Use the procedure "If a file to be loaded cannot be found,..." (p.157) to load the required .KSF files.

- ⚠ Since sample memory (RAM) overflow checking is performed when loading each .KSF file, an overflow may occur during the loading process.

## 24) Load .KSF:

selected icon



The selected .KSF file will be loaded as a sample.

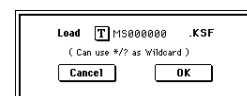

- 1 To load the data, press the **OK button**. To cancel without loading, press the **Cancel button**.

The sample will be loaded after the last multisample or sample that currently exists in the sample memory (RAM) (Append load).

### Loading AIFF files and WAVE files

The TRITON STUDIO can load AIFF format or WAVE format files, which are formats used to save audio data on personal computers etc. The loaded data can be used as a sample. When this data that has been loaded, it can be used as a sample or a drumsample.

## 25) Load .AIF:

selected icon



The selected AIFF file will be loaded as a sample.

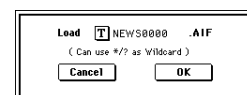

- 1 To load the data, press the **OK button**. To cancel without loading, press the **Cancel button**.

The sample will be loaded after the last sample that currently exists in the sample memory (RAM) (Append load).

- note** You can load multiple files within the directory. (p.162)

26) Load .WAV:

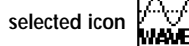

The selected WAVE file will be loaded as a sample.

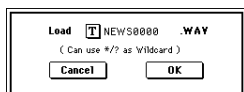

- ① To load the data, press the **OK button**. To cancel without loading, press the **Cancel button**.  
The sample will be loaded after the last sample that currently exists in the sample memory (RAM) (Append load).

**note** You can load multiple files within the directory. (☞p.162)

**!** Files with an extension of other than .AIF/.WAV cannot be recognized as AIFF/WAVE files. In this case, use the Utility "Rename" (0-3A) to change the last four characters of the filename to ".AIF"/".WAV"

**!** If the data that is loaded as a sample contains a loop point, you can set "S.Ofs(Start Offset)" (Program P1: 1-2a) on the TRITON STUDIO so that the sound will begin from the loop point.

**!** If data whose sample size is 8 bits or less is loaded, it will be converted into 16 bit data inside the TRITON STUDIO. This will mean that the amount of internal memory consumed will be approximately twice as large as the file size. The increase in size resulting from this conversion may mean that it is impossible to save that data on a media.

**Loading AKAI S1000/S3000 format Sample files and Program files**

The TRITON STUDIO can load AKAI S1000/S3000 format Sample files and Program files (☞p.165 "About AKAI Program files" for more information about compatibility). The loaded Sample or Program file data can be used as a sample or multisample respectively. When the loaded data is then saved to storage media, it will be saved as a Korg format .KSF file or .KMP file respectively.

AKAI S1000/S3000 format stereo Sample files and Program files whose names end in "-L" and "-R" can be loaded into the TRITON STUDIO as stereo samples and multisamples. When the above files are loaded, "-L" and "-R" will automatically be moved to the end of the sample name or multi-sample name (15th and 16th character) so that they can automatically be recognized as stereo samples or multisamples.

27) Load AKAI Sample File:

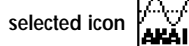

The selected Sample will be loaded as a sample.

- ① To load the data, press the **OK button**. To cancel without loading, press the **Cancel button**.  
The sample will be loaded after the last sample that currently exists in the sample memory (RAM) by having been sampled or loaded (Append load). If the loaded data is then saved to storage media, it will be saved as a Korg format .KSF file. (possible to export as a .AIF, .WAV format ☞0-2H "Export Smpl AIF/WAV")

**!** If the data that is loaded as a sample contains a loop point, you can set "S.Offset" (Program P1: 1-2a) on the TRITON STUDIO so that the sound will begin from the loop point.

**note** If the end (11th and 12th characters) of the sample name is "-L" and "-R," the "-L" and "-R" will automatically be moved to the end of the TRITON STUDIO's sample name (15th and 16th characters).

When you load two files whose sample names are identical except for ending in "-L" and "-R," and assign them to a stereo multisample in Sampling mode, they will be recognized as a stereo sample.

**Sample files**

Parameter	AKAI S1000/S3000 format	TRITON STUDIO format after loading
Loop points	Multiple settings possible	Of the multiple loop points, the settings for the first HOLD loop are used. If there is no HOLD loop, the longest loop will be used.
Loop length	Settable with resolution of less than one sample	Resolution of less than one sample is ignored

**note** You can load multiple files within the directory. (☞p.162)

28) Load AKAI Program File:

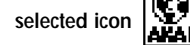

The selected Program file will be loaded as a multisample. When the loaded data is saved to storage media, a Program file will be saved as a .KMP file, and a Sample file will be saved as a .KSF file.

- ① To load the data, press the **OK button**. To cancel without loading, press the **Cancel button**.  
The sample will be loaded after the last multisample or sample that currently exists in the sample memory (RAM) (Append load). Only valid Program files or Samples files will be packed and loaded (Append load). If the Sample files used by the Program file are not in the current directory or below it, a dialog box will appear, allowing you to specify the directory. Use the procedure "If a file to be loaded cannot be found,..." (☞p.157) to load the required Sample files.

**!** Since sample memory (RAM) overflow checking is performed when loading each sample file, an overflow may occur during the loading process.

**!** If a loaded multisample is assigned samples whose sample names end in "-L" and "-R," an "-L" and "-R" will automatically be added to the end (15th and 16th characters) of the multisample name. When you load two multisamples whose multisample names are identical except for ending in "-L" and "-R," they will be recognized in Sampling mode as a stereo multisample.

### About AKAI Program files

The TRITON STUDIO will load only the key-map related parameters from the Program file.

AKAI format uses the concept of "key groups." For each key zone, up to four samples can be assigned, and these four can be switched or crossfaded by velocity. Key zones can also be crossfaded.

On the TRITON STUDIO, in contrast, there is one sample for each key zone, and you can use up to four multisamples to create a key map in the order of the velocity of each key group. It is not possible to crossfade key zones.

#### Example)

An AKAI format Program file "TESTPROGRAM" consists of four key groups, and each key group consists of up to three velocity zones. Key groups 1 and 2 are a layer whose low range is the same. When this is loaded into the TRITON STUDIO, three multisamples will be created, collected by velocity zone, and the numerals 1, 2, and 3 will be appended to each multisample name. At this time, the top key will be determined by the bottom key of the sample that is assigned at the right, and if the bottom key is the same (key groups 1 and 2 in the diagram), the higher-numbered key group will be used.

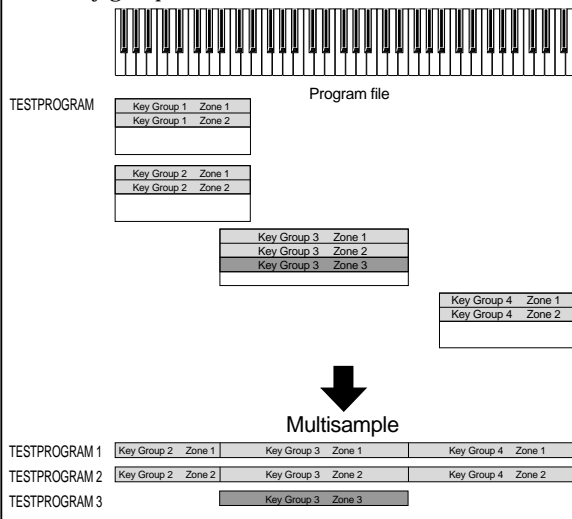

### Loading KCD files

#### 29) Load .KCD

The selected .KCD file will be loaded.

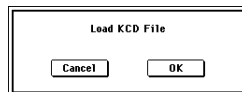

- 1 Press the **OK button** to load, or press the **Cancel button** to cancel without loading.

The loaded contents will be displayed in the Make Audio CD page. As the data is being loaded, the WAVE files in the list will be checked, and if a file does not exist, a message of "File/Path not found" will be displayed.

## 0-2: Save

Here you can save various data from internal memory to a variety of media.

Use the **Open button** and **Up button** to move to the desired directory (i.e., change the current directory), and then select the desired page menu command.

When you execute a Save operation, the data will be saved in the same level of the disk hierarchy as the files that are displayed.

- note** The TRITON STUDIO contains an internal calendar and clock. When you save a file, the date and time will be assigned automatically. The date and time can be set in "Set Data/Time" (0-3E).

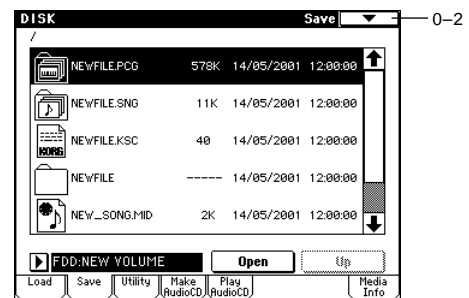

- !** To avoid errors, do not subject the TRITON STUDIO to vibration or physical shock while data is being written to the CDRW-1 option (if installed).

### ▼ 0-2: Page Menu Command

0-1A	Hide unknown file	Save to Std MIDI File	0-2F
0-1B	Translation	Save Exclusive	0-2G
0-2A	Save All	Export Smpl as AIF/WAV	0-2H
0-2B	Save PCG & SEQ	Save Audio CD Track List	0-2I
0-2C	Save PCG		
0-2D	Save SEQ		
0-2E	Save Sampling Data		

- !** When saving combinations with "Save All," "Save PCG & SNG," or "Save PCG," you should also try to save the programs used by each timbre (and the drum kits used by the programs) and the user arpeggio patterns at the same time.

Similarly when saving programs, you should also save the drum kit used by the program and the user arpeggio pattern at the same time.

- !** If multisamples or samples created in Sampling mode are used in a program or drum kit, we recommend that you save the data as "Save All."

Also when using "Save PCG" or "Save Sampling Data" to save an individual program, drum kit, or multisample or sample created in Sampling mode, we recommend that you save the data in the same directory with the same filename.

When using "Load PCG" to load a .PCG file, the .KSC file of the same name will be loaded at the same time so that the multisamples/samples that were saved with the program or drum kit will correspond correctly.

0-1  
0-2

Disk



If the data being saved does not fit on one volume of media  
When saving a .PCG, .KSC, .KMP, or .KSF file, and the data does not fit on a single floppy disk (or other volume of media), the display will ask "No space available on medium"



- Make sure that you have sufficient floppy disks (or other media) to save the data, and press the **OK button**. Saving will begin.
- When the disk is full, the following dialog box will appear. Remove the floppy disk from the disk drive, insert another floppy disk, and press the LCD screen to make the TRITON STUDIO detect the disk. If you want to specify a different SCSI device, choose "Drive select" (0-1c), and specify the save-destination media.

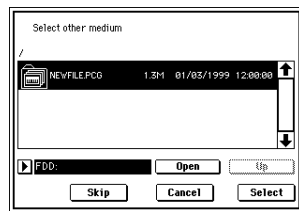

- Press the **Select button**. The Save process will be halted if you press the **Cancel button**. If you then want to abort the Save process, press the **OK button**. If you press the **Skip button**, the indicated file will be skipped, and the next file will be saved.

### 0-2A: Save All (PCG, SNG and KSC)

This command saves all programs, combinations, drum kits, user arpeggio patterns, and global settings as a **.PCG file**, songs and cues lists as a **.SNG file**, and multisamples and samples created in Sampling mode as a **.KSC file** to the specified media.

This command is valid only when the current directory is a DOS directory.

- Select "**Save All**" to access the dialog box.

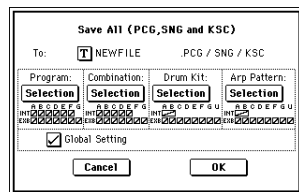

- Use the text edit button to move to the text input dialog box, and specify the filename. (☞ BG p.57) For example if you specify NEWFILE and execute the save command, files named NEWFILE.PCG, NEWFILE.SNG, and NEWFILE.KSC will be saved to the media.
- Select the bank(s) that you want to save. Programs, combinations, drum kits, and arpeggio patterns can be saved in units of banks. Information on the bank to be saved is displayed below each **Selection button**. Banks that are checked will be saved. If you want to modify the selections, press the Selection button to access the dialog box, and check the check boxes for the data you want to save.

Example: when the Selection button for Program is pressed

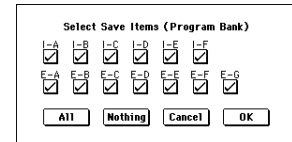

If you press the **All button**, all banks will be checked. If you press the **Nothing button**, all banks will be unchecked.

Press the **OK button** to change the selections as specified, or press the **Cancel button** to discard your changes.

To specify whether "Global Settings" will be saved, use the check box in step ①.

- To save the data, press the **OK button**. To cancel without saving, press the **Cancel button**.

If "No space available on medium" dialog box will appear. Refer to "If the data being saved does not fit on one volume of media," and use the procedure given there to save the data.

When you save, files will be created in the current directory. If the data you save extends across two or more disks, these files will be divided. In addition to the .PCG, .SNG, and .KSC files that will be created with the specified filename, one directory will also be created. The files listed in NEWFILE.KSC will be saved in this directory.

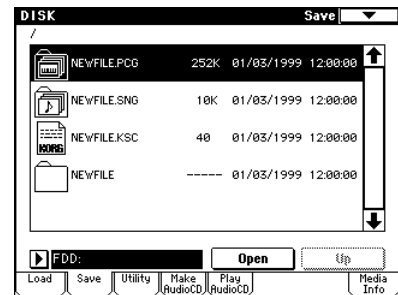

### 0-2B: Save PCG & SEQ

This command saves all internal memory programs, combinations, drum kits, user arpeggio patterns, and global settings as a **.PCG file**, and saves songs and cue lists to a **.SNG file** on the specified media.

This command is valid only when the current directory is a DOS directory.

- Select "**Save PCG & SEQ**" to access the dialog box.

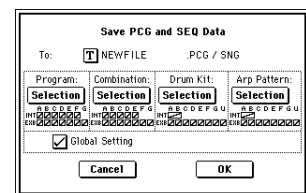

- Use the text edit button to move to the text input dialog box, and specify the filename. For example if you specify NEWFILE and execute the save command, files named NEWFILE.PCG and NEWFILE.SNG will be saved to the media.
- Select the bank(s) that you want to save. (☞ For the procedure, refer to "0-2A: Save All ③")
- To save the data, press the **OK button**. To cancel without saving, press the **Cancel button**.

## 0-2C: Save PCG

This command saves all internal memory programs, combinations, drum kits, user arpeggio patterns, and global settings as a .PCG file.

This command is valid only when the current directory is a DOS directory.

- 1 Select "Save PCG" to access the dialog box.

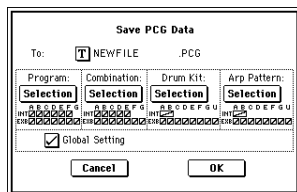

- 2 Use the text edit button to move to the text input dialog box, and specify the filename.  
For example if you specify NEWFILE and execute the save command, a file named NEWFILE.PCG will be saved to the media.
- 3 Select the bank(s) that you want to save.  
(For the procedure, refer to "0-2A: Save All")
- 4 To save the data, press the **OK** button. To cancel without saving, press the **Cancel** button.

## 0-2D: Save SEQ (Songs and Cue Lists)

This command saves all songs and cue lists from internal memory as a .SNG file.

This command is valid only when the current directory is a DOS directory.

- 1 Select "Save SEQ" to access the dialog box.

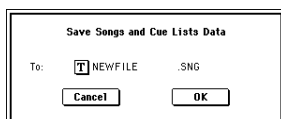

- 2 Use the text edit button to move to the text input dialog box, and specify the filename.  
For example if you specify NEWFILE and execute the save command, a file named NEWFILE.SNG will be saved to the media.
- 3 To save the data, press the **OK** button. To cancel without saving, press the **Cancel** button.

## 0-2E: Save Sampling Data (Multisamples and Samples)

When this command is executed, the following list of multi-sample and sample data will be saved to media as Korg format .KMP files, .KSF files, and a .KSC file that collects these files.

This is valid only when the current directory is a DOS directory.

- Multisample and sample data recorded or edited
- Multisample and sample data loaded in Disk mode
- Multisample and sample data in internal sample memory (RAM)

- 1 Select "Save Sampling Data" to access the dialog box.

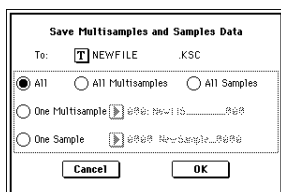

- 2 Press the text edit button to move to the text dialog box, and specify the filename (BG p.57).

- 3 Use "To" to specify the contents that will be saved. (All content will be saved in Korg format.) Use the following five radio buttons to make your selection.

**All:** All multisamples and samples from the Sample memory (RAM) will be saved as .KMP files and .KSF files. Simultaneously, a .KSC file and a directory to contain these files will also be created and saved.

The filename will be the .KSC filename and the directory name.

**All Multisamples:** All multisamples and samples (i.e., samples used by the multisamples) will be saved as .KMP files and .KSF files. Simultaneously, a .KSC file and a directory to contain these files will also be created and saved.

The filename will be the .KSC filename and the directory name.

**All Samples:** All samples will be saved as .KSF files. Simultaneously, a .KSC and directory to contain these files will also be created and saved.

The filename will be the .KSC filename and the directory name.

**One Multisample:** The selected multisample will be saved as a .KMP file. Simultaneously, a directory will also be created, and the samples used by the multisample will be saved in that directory.

The filename will be the .KMP filename and the directory name.

Initially, the filename will automatically be set to the first five characters (uppercase) of the sixteen-character multi-sample name + the multisample number.

### [Examples]

000: NewMS\_0000 → NEWMS000.KMP

001: 108bpmDrLoop00 → 108BP001.KMP

**One Sample:** The selected sample will be saved as a .KSF file.

The filename will be the .KSF filename name.

Initially, the filename will automatically be set to the first four characters (uppercase) of the sixteen-character sample name + the sample number.

### [Examples]

0000: NewSample\_0000 → NEWS0000.KSF

0001: C#3-EGuitar → C#3-0001.KSF

**note** If you wish to export the data in AIFF (.AIF) or WAVE (.WAV) format, select the Utility "Export Smpl AIF/WAV."

- 4 To save the data, press the **OK** button. To cancel without saving, press the **Cancel** button.

If the page menu command "Translation" (0-1B) is turned on, the names of .KMP files and .KSF files you save will be displayed as the multisample name or sample name. This is convenient when you are searching for the desired files on disk.

## 0-2F: Save to Std MIDI File (Save Song as Standard MIDI File)

This command saves the selected song from internal memory to storage media as a .MID file (Standard MIDI File).

This command is valid only when the current directory is a DOS directory.

- 1 Select "Save to Std MIDI File" to access the dialog box.



- ② In "Song," so the song that you wish to save.
- ③ Use the text edit button to access the text input dialog box, and specify the filename. By default, the first eight characters (uppercase) of the song name will be assigned automatically.
- ④ Use the radio buttons to specify the format.  
**Format 0** will save sixteen channels of MIDI data together in a single track.  
**Format 1** will save each MIDI channel to a separate track.
- ⑤ To save the data, press the **OK button**. To cancel, press the **Cancel button**.  
 The song data you save here can be played back on a device that supports Standard MIDI Files. However if you intend to playback the data on the TRITON STUDIO, we recommend that you use "Save SEQ" to save the data, since this will allow a higher degree of reproducibility.

## 0-2G: Save Exclusive (Receive and Save MIDI Exclusive Data)

Accumulates the received exclusive data in internal memory, and then save the data to media as an .EXL file. This command is valid only when the current directory is a DOS directory.

- ① When you select "**Save Exclusive**," the TRITON STUDIO will wait for exclusive data to be received. The following dialog box will appear.

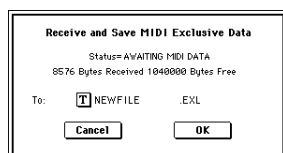

- ② Transmit the exclusive data that you wish to save to the TRITON STUDIO. While the data is being received, the display will indicate "Status=RECEIVING MIDI DATA." When reception ends, the size of the received data and the size of the remaining free area will be rewritten. The display will change to "Status=AWAITING MIDI DATA," and you can continue transmitting exclusive data to the TRITON STUDIO. During reception, the **Cancel button** and the **OK button** cannot be pressed.
- ③ Press the text edit button to access the text input dialog box, and specify the filename.
- ④ To save the data, press the **OK button**. To cancel without saving, press the **Cancel button**.

## 0-2H: Export Smpl AIF/WAV (Export Samples as AIFF/WAVE)

Sample data in Sample memory (RAM) that was recorded or edited in Sampling mode, or loaded in Disk mode, can be exported (written) to media as an AIFF or WAVE format sample file.

This is valid only when the current directory is a DOS directory.

**note** Normally, it is recommended that you use Save All or Save Sampling Data to save sample data in Korg format (.KSC, .KMP, .KSF). This will allow you to save the data in a way that preserves the state of the multisamples (and the samples that they use) as they exist in Sample memory (RAM).

Use "Export Smpl AIF/WAV" if you wish to use an AIFF or WAVE format compatible application on your computer to work with samples that were recorded or edited on the TRITON STUDIO.

- ⚠ "Export Smpl AIF/WAV" does not export multisample files. The exported AIFF or WAVE format samples can be re-loaded, but if the sample number when saving is different than the sample number when loading, you

may need to re-make certain settings, such as selecting the sample for each index of a multisample. Furthermore, the following parameters set in Sampling mode are lost by "Export Smpl AIF/WAV."

- Sample Name
- Loop Tune (Sampling 2-1c. "Loop Tune")
- Reverse (Sampling 2-1c. "Rev")
- +12 dB (Sampling 2-1c)

Samples that are handled by the TRITON STUDIO as stereo will be exported as two independent L and R files.

- ① Select "**Export Smpl AIF/WAV**" to access the dialog box.

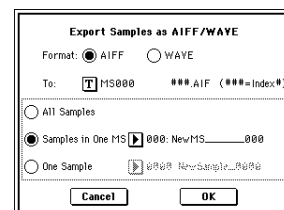

- ② In "**Format**," select either **AIFF** or **WAVE** as the file format for export.
- ③ Press the text edit button to move to the text dialog box, and specify the filename (see BG p.57).
- ④ In "**To**," specify the content that will be exported.

**All Samples:** All samples will be exported.

It will not be possible to specify the filename. The filename will automatically be assigned as the first four characters (uppercase) of the sixteen-character sample name + the sample number.

**[Examples]**

0000: NewSample\_0000→NEWS0000.AIF

0001: C#3-EGuitar→C#3-0001.WAV

**Samples in One MS:** All samples used by the selected multisample will be exported.

Only five characters of the filename can be specified. The five-character filename + the index number (001-128) in the multisample will be assigned automatically.

Initially, the filename will automatically be set to the first five characters (uppercase) of the sixteen-character multisample name.

**[Examples]**

000: NewMS\_000:

Sample selected for index 001 → MS000001.AIF

Sample selected for index 002 → MS000002.AIF

001: 108bpmDrLoop00:

Sample selected for index 001 → 108BP001.AIF

Sample selected for index 002 → 108BP002.AIF

- ⚠ When exporting **All Samples** or **Samples in One MS**, and all of the sample data does not fit on one volume of media (e.g., floppy disk), another dialog box will appear, directing you to specify the next media. ("If the data being saved does not fit on one volume of media" see p.166) However at this time if a single sample is larger than the capacity of the media, the sample cannot be exported. Either specify media with a larger capacity, or press **Skip button** to omit exporting that sample and proceed to exporting the next sample.

**One Sample:** The single selected sample will be exported.

The filename will be the filename of the .AIF or .WAV file. Initially, the filename will automatically be set to the first four characters (uppercase) of the sixteen-character sample name + the sample number.

- ⚠ When exporting **One Sample**, it is not possible to export sample data that will not fit on a single floppy disk (or a single volume of other media).

- ⑤ To export the data, press the **OK button**. To cancel without exporting, press the **Cancel button**.

### 0-2I: Save Audio CD Track List

This command saves a track list that you created in the Make Audio CD page. The drive and directory locations that contain each WAVE file, and the names of the WAVE files will be saved.

This command is valid only when the current directory is a DOS directory.

- ① Select "**Save Audio CD Track List**" to access the dialog box.

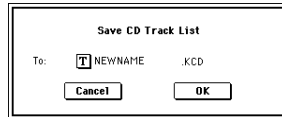

- ② Use the text edit button to move to the text input dialog box, and specify the filename. For example if you specify NEWFILE and save, NEWFILE.KCD will be saved to the media.
- ③ Press the **OK button** to save, or press the **Cancel button** to cancel without saving.

## 0-3: Utility

Here you can rename, copy, or delete the selected disk or file, create a new directory, format, and set the date and time.

After selecting a disk or file, select the desired page menu command.

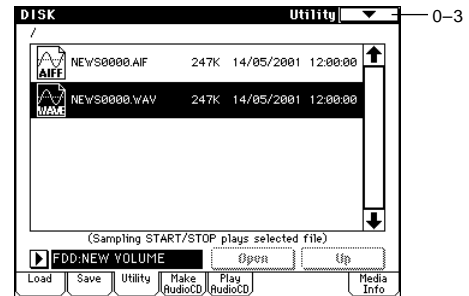

- ⚠ To avoid errors, do not subject the TRITON STUDIO to vibration or physical shock while data is being written to the CDRW-1 option (if installed) or while a disc is being formatted.

### ▼ 0-3: Page Menu Command

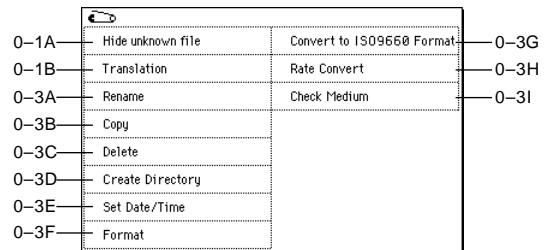

### 0-3A: Rename

This command renames the selected file or directory. This command is valid only when a DOS file or a DOS directory is selected.

- ① Select the file or directory whose name you want to edit.
- ② Select "**Rename**" to access the dialog box.

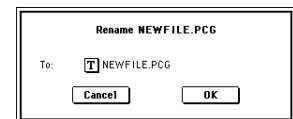

- ③ Press the text edit button to access the text input dialog box, and modify the name.
- ④ To rename the file or directory, press the **OK button**. To cancel, press the **Cancel button**.

### 0-3B: Copy

This command copies the selected file or directory. This command is valid only when a DOS file or a DOS directory is selected.

- ① Select the file or directory that you want to copy.
- ② Select "**Copy**" to access the dialog box.

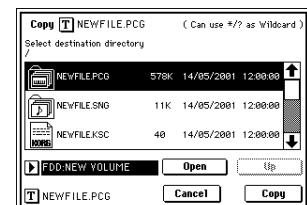

- ③ “Copy” will show the name of the selected file or directory.

If you wish to change the file or directory that will be copied, use the text edit button to move to the text input dialog box, and specify the filename that you wish to copy. (≡BG p.57)

(Can use \*/? as Wildcard): When you use the text edit button to access the text input dialog box and specify the name of the file or directory to be copied, you can use “\*” and “?” characters as wildcards. For example, if in the above example you specify **PRELOAD1.\*** (instead of **PRELOAD1.PCG**), all filenames of PRELOAD1. with any filename extension will be copied at the same time: i.e., PRELOAD1.PCG, PRELOAD1.SNG, PRELOAD1.KSC, ...

**Example)**

PRELOAD1.\* : PRELOAD1.PCG, PRELOAD1.SNG, PRELOAD1.KSC, ...  
 PRELOAD?.PCG : PRELOAD1.PCG, PRELOAD2.PCG, PRELOAD3.PCG, ...

**▲** When wildcards are used, only files will be subject to copying. Directories will not be copied.

- ④ Use the **Open button** and **Up button** to select the copy destination directory. If you wish to specify a different SCSI device, use “Drive Select” (0-1c) to select it.
- ⑤ If you wish to copy the file or directory with a different name, use the text edit button (in the lower line) to access the text input dialog box, and specify the name with which the file or directory will be copied. If you are using wildcards to simultaneously copy multiple files, it is not possible to modify the filename.
- ⑥ To copy the data, press the **OK button**. To cancel without copying, press the **Cancel button**.

**note** If you decide not to copy, press the **Abort button**.

**▲** If the drive that you selected in “Drive Select” is removable media (floppy disk, CD-R/RW, MO disc, removable hard disk etc.), it is not possible to copy to different media on the same drive.

**0-3C: Delete**

This command deletes the selected file or directory. This command is valid only if a DOS file or directory is selected.

- ① Select the file or directory that you want to delete.
- ② Select “**Delete**” to access the dialog box.

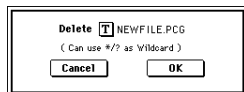

- ③ “Delete” will indicate the name of the selected file or directory.

If you wish to change the file or directory that is to be deleted, use the text edit button to access the text input dialog box, and specify the name of the file or directory that you wish to delete.

(Can use \*/? as Wildcard): When you use the text edit button to access the text input dialog box and specify the name of the file to be deleted, you can use the “\*” or “?” characters as wildcards. This allows you to simultaneously delete multiple files with identical filenames and different extensions, or files whose names are partially identical (≡0-3B “Copy”).

**▲** When wildcards are used, only files will be subject to deletion. Directories will not be deleted.

- ④ To delete the selected file or directory, press the **OK button**. To cancel without deleting, press the **Cancel button**.

**0-3D: Create Directory**

This command creates a new directory within the current directory.

- ① Select “**Create Directory**” to access the dialog box.



- ② Use the text edit button to access the text input dialog box, and specify the name of the new directory.
- ③ To create the directory, press the **OK button**. To cancel without creating the directory, press the **Cancel button**.

**0-3E: Set Date/Time**

This command sets the date and time of the TRITON STUDIO’s internal calendar.

- ① Select “**Set Date/Time**” to access the dialog box.

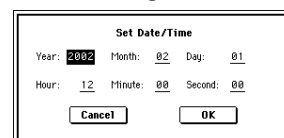

- ② Set each parameter.  
 “Year” 1980-2079  
 “Month” 1-12  
 “Day” 1-31  
 “Hour” 0-23  
 “Minute” 0-59  
 “Second” 0-59 (For other than CD-R/RW media, the number of seconds recorded in the file will always be an even-numbered value.)
- ③ To set the date and time, press the **OK button**. To cancel, press the **Cancel button**.

**0-3F: Format**

This command formats the selected media, such as a floppy disk or external SCSI device. The volume label (a name for the entire disk) you specify will be assigned to the disk. The volume label you assign here will be displayed in “Drive Select” (0-1c). The volume label can be a maximum of eleven characters.

**▲** When you format, all data saved on that media will be erased. If you had used a computer etc. to set up that drive so that it can be used as multiple drives (partitions), this data will also be erased. Be sure to double-check before you format.

**▲** After formatting, it is not possible to press the [COMPARE] key to return to the previous state.

- ① Make sure that the media you want to format is inserted.
- ② Use “Drive Select” (0-1c) to select the media that will be formatted.
- ③ Select “**Format**” to access the dialog box.

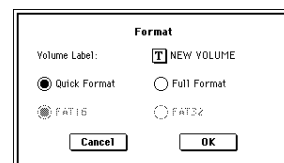

- ④ In “Volume Label,” use the text edit button to access the text input dialog box, and specify the volume label. The previously-specified volume label will be displayed. If no volume label had been specified for the disk, or if a non-DOS disk was inserted, this will indicate “NEW VOLUME.”

- Specify the initialization format. Normally you should use **Quick Format** to initialize the disk, and use **Full Format** if an error message of “Disk not Formatted” appears. **Quick Format:** Selects this if the media has already been physically formatted. Since only the system area of the media need be formatted, this will require less time. **Full Format:** Selects this when formatting media that has not been physically formatted. You should also select this type of formatting if writing errors occur frequently with this media.

**note** Normally, it is not necessary to perform a **Full Format** on SCSI media that has been physically formatted at 512 bytes/block. Perform the **Quick Format** for such media.

**!** Depending on the capacity of the media, executing Full Format may require many hours, or may not be completed successfully.

- Specify the file system. **FAT16** can format a maximum of 4 Gbyte. If you are using media larger than 4 Gbyte, use **FAT32** format to format it. (In the case of FAT32, the theoretical maximum is 2 TB = 2,000 Gbytes.)
- To format the media, press the **OK button**. To cancel without formatting, press the **Cancel button**. After a floppy disk has been formatted by the TRITON STUDIO, a 2HD floppy will hold 1.44 Mbyte (18 sectors/track), and a 2DD floppy will hold 720 Kbyte (9 sectors/track).

**note** If you want to use a CD-R/RW for writing packet data, you must format it (p.299). If you will be using it as an audio CD, formatting is not necessary.

### 0-3G: Convert to ISO9660 Format

This command converts UDF format CD-R media to ISO9660 format.

If a file that was saved by the TRITON STUDIO to CD-R is to be loaded by another device, you must execute this command to convert it to ISO9660 format.

Hard disk memory is used as temporary storage when making this conversion. This command cannot be selected if a hard drive is not connected.

- Select “**Convert to ISO9660**” to access the dialog box.



- Press the **OK button** to execute the conversion, or press the **Cancel button** to cancel without executing.

**!** Even if data is converted into ISO9660 format, some files may not be readable by certain devices.

### 0-3H: Rate Convert

This command converts the sampling rate (frequency) of the selected WAVE file from 48 kHz to 44.1 kHz.

This is valid only when a 48 kHz WAVE file is selected. When you use the Make Audio CD page to write a WAVE file to an audio CD, 48 kHz files will alternatively be converted to 44.1 kHz. This command is useful when you want to audition the sound converted to 44.1 kHz before writing it to CD.

- Select the file or directory whose sampling rate (frequency) you want to convert.

- Select “**Rate Convert**” to access the dialog box.

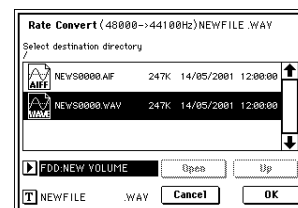

“Rate Convert” will indicate the name of the selected file.

- Use the **Open button** and **Up button** to select the save-destination directory. If you want to specify another SCSI device, use “Directory select” to specify it.
- If you want to change the filename for saving, press the text edit button in the lower line to access the text input dialog box, and specify the filename for saving.
- Press the **OK button** to execute the Rate Convert command, or press the **Cancel button** to cancel without executing.

### 0-3I: Check Medium

This command checks the selected MS-DOS format media for errors, and corrects them. Execute this command if you frequently experience messages such as “Error in writing to medium” while writing to disk, or “Buffer underrun error occurred” while sampling to hard disk.

- Make sure that the media you want to check has been inserted.
- Use “Drive select” to select the media that you want to check.
- Select “**Check Medium**” to access the dialog box.

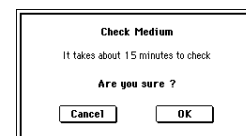

- Press the **OK button** to execute the check, or press the **Cancel button** to cancel.
- When checking has been completed, the recovered content will be displayed.

**note** If you want to stop the checking process before it has been completed, press the Abort button. Checking will require approximately 80 minutes for 5 Gbyte (FAT32) media, but the time required will vary depending on the media capacity and on the number of errors that are found.

## 0-4: Make Audio CD

If the CDRW-1 option is installed, or if a CD-R/RW drive is connected as an external SCSI device, you can create an audio CD in Disk mode.

Performances of the TRITON STUDIO's sequencer etc. can be resampled to the internal hard disk etc. as WAVE files, and these can be used to create an audio CD.

Audio CDs are created from 44.1 kHz or 48 kHz WAVE files. In this page, you can use the Insert button and Cut button etc. to arrange WAVE files in the audio track list, and then execute the page menu command "Write to CD" to write them to CD.

 WAVE files with a sampling frequency of 48 kHz will automatically be converted to 44.1 kHz when written to an audio CD ("Write to CD").

**note** If the cursor is located at the WAVE file name, you can press the SAMPLING [START/STOP] key to play back that file. This is convenient when you want to audition the sound. You can also erase the track data from CD-RW media.

### What is Finalize?

In order for an audio CD to be playable on a conventional CD player, or to be played on the TRITON STUDIO (Global 0-4: Play Audio CD page, Sampling P5: Audio CD page), the Finalize operation must be executed after all the desired audio tracks have been written to the CD-R/RW disc.

On the TRITON STUDIO, the page menu command "Write to CD" allows you to simply write the audio tracks without finalizing the disc, and this means that other audio tracks can be added to that CD-R/RW disc at a later time.

No more audio tracks can be added to a disc once that disc has been finalized, so be sure that all desired audio tracks have been written before you finalize.

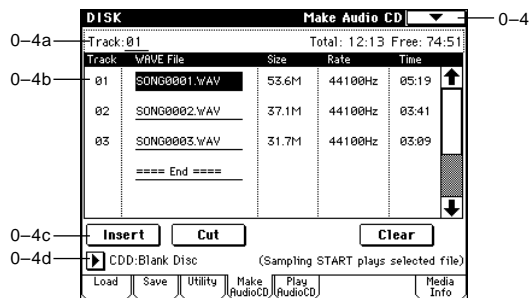

### 0-4a: Track, Total, Free

**Track (Track Select)** [01...99, --]

Specifies the track number that will be displayed at the top of the audio track list.

If unfinalized media is inserted, this field will indicate the number that follows the last track number on that media. For example if data up to "Track (Track Select)" 05 has already been written, this will indicate 06 and following (up to 99).

If "WAVE file" "====End====" is at the top, this will indicate --. Up to 99 tracks can be registered using the Insert button.

**Total** [00:00...]

Displays the total time of all WAVE files in the track list.

 If the "Total" time is greater than "Free," writing to CD-R/RW media will not be possible.

**Free** [00:00..., --:--]

Displays the time that remains on the media inserted in the CD-R/RW drive selected by "Drive select."

If a CD-R/RW drive is not connected, or if it contains no media, or if the inserted media has already been finalized, this will display --:--.

### 0-4b: Audio track list

**Track** (01...99)

Displays the track numbers of the WAVE files arranged in the audio track list. (≡0-4a "Track (Track Select)")

### WAVE File

Displays the names of the WAVE files.

To add a WAVE file, place the cursor at the WAVE file of the audio track that follows the audio track you want to add, and press the **Insert button**. To delete an audio track, place the cursor at the audio track that you want to delete, and press the **Cut button**.

**note** When you select a WAVE file (highlighted) and press the SAMPLING [START/STOP] key, the WAVE file will play back. The lower line will indicate "(Sampling START plays selected file)."

### Size, Rate, Time

This area displays information on the WAVE files in the audio track list.

**Size:** Data size (bytes)

**Rate:** Sampling frequency (Hz)

**Time:** Time (minutes: seconds)

 This information will not be displayed if you used "Load .KCD" etc. to load an audio track list, and the WAVE file is not found in the specified directory. In this case, use the **Cut button** to delete that audio track, or check whether the hard disk etc. is connected correctly.

### 0-4c: Insert, Cut, Clear

#### Insert

Adds an audio track to the audio track list.

Place the cursor at the WAVE file that follows the audio track you want to add, and press the **Insert button**. The following dialog box will appear.

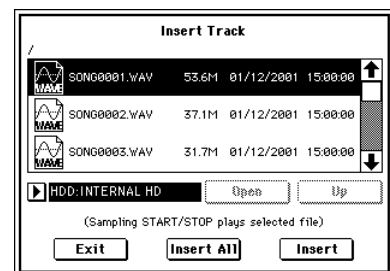

Use "Drive select" to select the drive (internal hard disk, etc.) that contains the file you want to add, use the Open button and Up button to move to the desired directory, and select the WAVE file. (≡0-1c, 0-1d)

**Insert:** Adds the selected (highlighted) WAVE file.

**Insert All:** Adds all WAVE files in the selected directory whose sampling frequency is 44.1 kHz or 48 kHz. The files will be added in the order in which they are displayed. When you execute **Insert** or **Insert All**, the WAVE file(s) will be added, and any subsequent audio tracks will be moved toward the end of the list.

**note** If you select a 44.1 kHz or 48 kHz WAVE file, you can press the SAMPLING [START/STOP] key to play it back. In this case, the lower line will indicate “(Sampling START/STOP plays selected file).”

If you press the **Exit button**, the dialog box will close, and no further WAVE files will be added.

You can continue adding as many WAVE files as desired until you press the **Exit button**.

### Cut

Deletes the audio track.

When you place the cursor at “WAVE File” of the audio track that you want to delete, and press the **Cut button**, that audio track will be deleted. Any subsequent audio tracks will be moved forward.

### Clear

Erases the audio track list.

**note** If you want to keep an audio track list, use “Save Audio CD Track List” (0-2I) to save it on floppy disk or other medium.

## 0-4d: Drive select

**Drive select** [ID0...6, CDD: Name]

Selects the CD-R/RW drive that contains the media that you will use to create an audio CD. (☞0-1c)



Drives other than a CD-R/RW drive cannot be selected here.

## ▼ 0-4: Page Menu Command

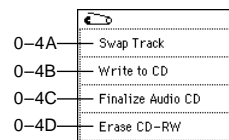

### 0-4A: Swap Track

This command exchanges (swaps) the order of two audio tracks.

- 1 Select “**Swap Track**” to access the dialog box.

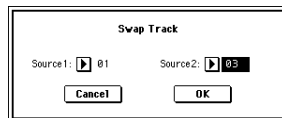

- 2 Use “**Source1**” and “**Source2**” to select the two audio tracks that you want to exchange.
- 3 Press the **OK button** to execute the Swap Track operation, or press the **Cancel button** to cancel without executing.

### 0-4B: Write to CD

When this command is executed, the WAVE files specified in the audio track list will be written as audio CD tracks. If desired, you can also finalize the disc (☞p.172) at this time.



To avoid errors, do not subject the TRITON STUDIO to vibration or physical shock while data is being written to the CDRW-1 option (if installed), or while formatting is taking place.

- 1 Create an audio track list, use “Drive select” to select the CD-R/RW drive, and make sure that CD-R/RW media is inserted in the drive.

- 2 Select “**Write to CD**” to access the dialog box.

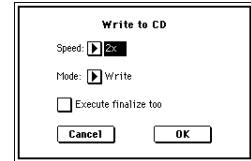

- 3 Use “**Speed**” to specify the writing speed. The writing speeds supported by your CD-R/RW drive will be displayed.



Be aware that if your system has a slower data transfer rate, using an excessively fast writing speed will produce writing errors. Depending on the drive you are using, problems with the speed may make it impossible to write, but you can perform a test beforehand to identify such problems. It is a good idea to perform a test write when you write for the first time, to verify the speed limitations of your drive.

Use “**Mode**” to specify the writing method.

**Test:** Tests whether the data can be written correctly. Data will not actually be written to the CD-R/RW media, but all other processing will occur just as if data were actually being written. Use this when you want to check whether writing can be performed correctly. If an error occurs, the display will indicate “Error in writing to medium.”

**Test and Write:** A test write will be performed, and if the test is successful, the disc will actually be written. We recommend that you use this method for fast writing speeds.

**Write:** The disk will only be written.

- 4 Specify whether the CD-R/RW media will be finalized after the audio tracks have been written to it.

If “**Execute finalize too**” is **checked**, the disc will be finalized.

If this is **not checked**, the disc will not be finalized.

**note** If you want only to finalize the disc, use “Finalize Audio CD” (0-4C).

- 5 Press the **OK button** to execute writing or test writing to the CD-R/RW media, or press the **Cancel button** to cancel without executing.



WAVE files with a 48 kHz sampling frequency will be converted to 44.1 kHz when they are written. In order for this processing to be performed, free space of approximately the same size as the WAVE file to be converted will be required on the drive that contains the WAVE file. Before executing, please make sure that the drive containing the WAVE file has enough free space.

**note** If the track is shorter than 4 seconds, silence will be automatically added to increase the length to 4 seconds.

**note** Two seconds of silence will be added to the end of each track except the last track.

### 0-4C: Finalize Audio CD

This command finalizes CD-R/RW media to which audio tracks have already been written.



To avoid errors, do not subject the TRITON STUDIO to vibration or physical shock while data is being written to the CDRW-1 option (if installed), or while formatting is taking place.

- 1 Use “Drive select” to select the drive, and make sure that the drive contains valid media.



- ② Select “**Finalize Audio CD**” to access the dialog box.

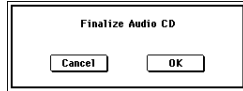

- ③ Press the **OK button** to execute the Finalize command, or press the **Cancel button** to cancel without executing.

#### 0-4D: Erase CD-RW

This command erases the audio tracks from CD-R/RW media.

- ⚠ To avoid errors, do not subject the TRITON STUDIO to vibration or physical shock while data is being written to the CDRW-1 option (if installed), or while formatting is taking place.

- ① Use “Drive select” to select the drive, and make sure that it contains data.
- ② Select “**Erase CD-RW**” to access the dialog box.

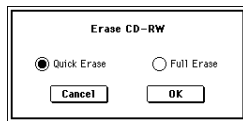

- ③ Select the mode by which the audio tracks will be erased.  
**Quick Erase:** Normally you will select this.  
**Full Erase:** The data will be erased completely. Substantial time will be required for the erasure.

- ⚠ When you execute **Quick Erase**, the files and data will appear to be gone, but the data itself will remain on the disc until it is overwritten. If you want to erase data that should not be seen by someone else, execute **Full Erase** to erase the data completely.

- ④ Press the **OK button** to execute the Erase operation, or press the **Cancel button** to cancel without executing.

## 0-5: Play Audio CD

If the CDRW-1 option is installed, or if a CD-R/RW drive is connected as an external SCSI device, you can play back audio CD's in Disk mode.

If you are using a SCSI-connected CD-ROM/R/RW drive, connect the audio outputs of the drive to the AUDIO INPUT 1 and 2 of the TRITON STUDIO.

It is convenient to use this method to verify a CD that you created in the Make Audio CD page.

The audio CD will play back according to the **Analog** setting for “**Input (COMBI, PROG, SEQ, S.PLAY, DISK).**”

- ⚠ It is not possible to play back an audio CD that has not been finalized.

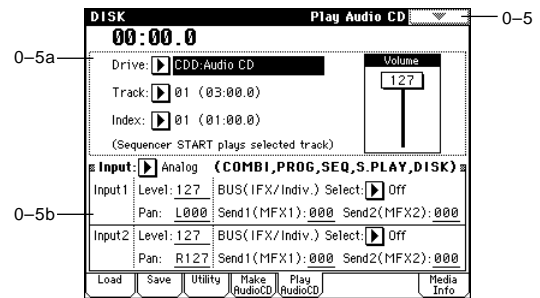

The audio CD can be controlled by the SEQUENCER keys.

- SEQUENCER [START/STOP] key : Play/Stop  
 [FF>>] key : Fast-forward  
 [<<REW] key : Rewind  
 [PAUSE] key : Pause  
 [LOCATE] key : Return to the beginning of the track

- ⚠ If the CDRW-1 option is installed, playing the TRITON STUDIO's keyboard or operating the controllers during CD playback may produce physical shock that causes the data to skip or read errors to occur, preventing playback from occurring normally. Please use caution.

### 0-5a: Location, Drive, Track, Index, Volume

**Location** (00:00.0...)

Displays the current location of the audio track that is playing. When stopped, this specifies the location at which playback will begin.

When “Track” or “Index” are re-selected, this will be 00:00.0.

**Drive**

Specifies the drive of the audio CD that will be played. Only CD-ROM/R/RW drives can be selected.

**Track** [01...]

Selects the audio CD track that will be played.

**Index** [01...]

Specifies the index of the audio CD that will be played. This is valid only if you have selected a track that has index data.

- ⚠ In the case of some CD-R/RW drives, index information cannot be obtained.

**Volume** [0...127]

Specifies the volume of the audio output from the CD-R/RW drive.

 Since some CD-R/RW drives do not support this, the volume may not change when you adjust this setting.

## 0-5b: Input

**Input** [Analog, S/P DIF, mLAN]

**Input1:**

**Input2:**

**Level** [0...127]

**Pan** [L000...C064...R127]

**BUS (IFX/Indiv.) Select** [L/R, IFX1...5, 1, 2, 3, 4, 1/2, 3/4, Off]

**Send1 (MFX1), Send2 (MFX2)** [000...127]

Here you can specify the input source, input level, pan, bus, and master effect send for analog/digital audio devices.

**note** Input settings are valid in Combination, Program, Sequencer, Song Play, and Disk modes. (≡ Global P0: 0-3a)

Normally you will set these parameters as follows.

**Input1** (L channel):

“Level” 127, “Pan” L000, “BUS (IFX/Indiv.) Select” L/R,

“Send1”/“Send2” 000

**Input2** (R channel):

“Level” 127, “Pan” R127, “BUS (IFX/Indiv.) Select” L/R,

“Send1”/“Send2” 000

## 0-6: Media Info (Media Information)

This displays information on the media that is selected by “Drive Select” (0-1c).

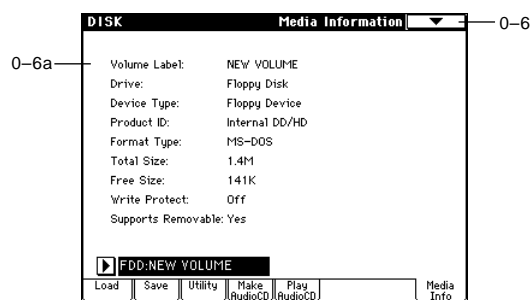

### 0-6a: Media Information

#### Volume Label:

The volume label of the media.

#### Drive:

This is the specified drive.

#### Device Type:

The type of media.

#### Product ID:

The Internal DD/HD, vendor ID, product, and product version, etc.

#### Format Type:

The type of format. If not formatted, this will indicate “Unformatted.”

#### Total Size:

The capacity of the media (in bytes).

#### Free Size:

The free capacity of the media (in bytes).

#### Write Protect:

The write protect status of the media. This will indicate “On” if protected, or “Off” if not protected.

#### Supports Removable:

This will indicate “Yes” if the media of the selected device can be removed (e.g., floppy disk, CD-R/RW disc, MO disc, removable hard disk). If the media is fixed, this will be “No.”

#### Drive select

Selects the drive. (≡0-1c)

0-4

0-5

0-6

Disk

---

## ▼ 0-6: Page Menu Command

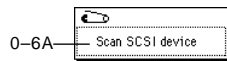

### 0-6A: Scan SCSI device

This command allows you to re-mount a connected SCSI device.

① Select “**Scan SCSI device.**”

The currently-connected SCSI devices will be re-scanned. Once scanning is completed, any valid SCSI device can be selected in “Drive Select.”

⚠ Never connect or disconnect a SCSI cable while the power of the TRITON STUDIO or of a SCSI device is turned on. Doing so can cause irreparable malfunctions.

# 8. Effect Guide

## Overview

The effects section of the TRITON STUDIO consists of five **Insert Effects**, two **Master Effects**, a stereo, three band **Master EQ**, and a **Mixer section** that controls the effect routings. You can select any of 102 digital Insert Effects or 89 digital Master Effects, as listed below:

### Classification of 102 effects

000–015	Filters and dynamics effect, such as EQ and compression
016–031	Pitch modulation and phase modulation effects, such as chorus and phaser
032–040	Other modulation and pitch-shifting effects, such as rotary speaker and pitch shifter
041–051	Early reflection and delay effects
052–057	Reverb effects
058–089	Mono effects and mono chain effects, in which two mono effects are internally connected in series
090–102	Double-size effects

Select the desired effects **000–089** from IFX 1, 2, 3, 4, and 5, and MFX 1 and 2. Effects **090–102** are double-size effects and use twice the area, compared to other effects. They are selected in IFX 2, 3, and 4.

## 1. Effects in each mode

In **Program mode**, you can process sounds using **Insert Effects**. This is something like processing an oscillator (OSC) output sound using a filter and an amplifier. Then, you can apply a modulation and reverb effect or other **Master Effect** to the processed sound to add ambience and space. Finally, before the sound is output from the OUTPUT (MAIN) L/MONO, and R connectors, you can fine-tune the tonal quality using the stereo, three-band **Master EQ**. You can adjust these settings for each Program individually.

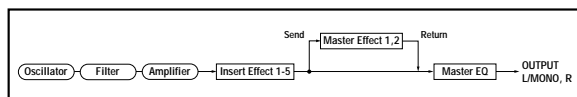

In **Combination mode**, **Sequencer mode**, and **Song Play mode**, you may process Program sounds for each timbre and track using the **Insert Effects**, add ambience and space to the entire sound using the **Master Effects**, and adjust the overall tonal quality using the **Master EQ**.

You can make these settings for each Combination in Combination mode, for each Song in Sequencer mode, and for the Song Play mode individually.

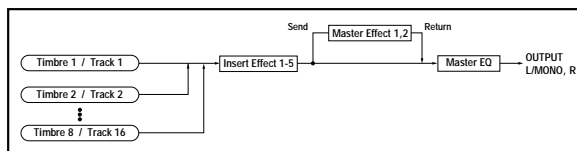

In **Sampling mode**, you can sample while applying **insert effects** to the internal audio input from AUDIO INPUT 1, 2, S/P DIF IN, or mLAN (if the EXB-mLAN is installed) jacks. Settings in Sampling mode are made in **Input (SAMPLING)** (Sampling P0: 0–2a). These settings are valid only for Sampling mode.

You can also sample while applying an insert effect to the samples assigned to a multisample. (Sampling P0: 0–2b)

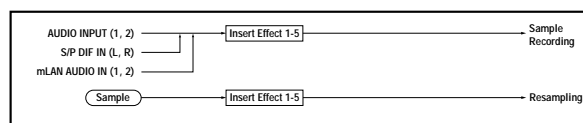

The external input from the **AUDIO INPUT 1, 2, S/P DIF IN**, or **mLAN** (if the EXB-mLAN option is installed) jacks is also valid in **modes** other than Sampling mode. In Program, Combination, Sequencer, and Song Play modes, you can use the **insert effects**, **master effects**, and **master EQ**. Settings for external input from the AUDIO INPUT 1, 2, S/P DIF IN, and mLAN (if the EXB-mLAN option is installed) can be made in “Input (COMBI, PROG, SEQ, S.PLAY, DISK)” (Global P0: 0–3a).

In these modes, the external input sound from each jack can be processed by the TRITON STUDIO’s effects and sampled, or the TRITON STUDIO can be used as a 6-in 6-out effect processor. The TRITON STUDIO can also be used as a vocoder effect (**093: Vocoder**) that uses external mic input to control internal sounds.

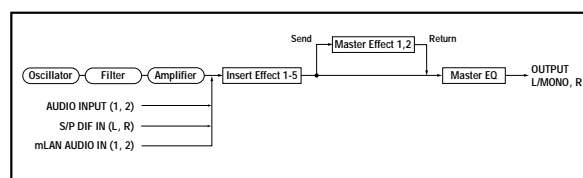

When effects are applied to the external input sound from the AUDIO INPUT 1, 2, S/P DIF IN, and mLAN (if the EXB-mLAN option is installed) jacks, certain effect types or parameter settings may cause oscillation to occur. If this occurs, adjust the input level, output level, or effect parameters. Please be aware of this particularly when using an effect that has a high gain.

## 2. Dynamic modulation (Dmod)

**Dynamic modulation** is a function that enables you to control and change in real-time certain parameters<sup>\*1</sup> of the TRITON STUDIO that govern the intensity of the effects during performance via the TRITON STUDIO’s controllers and incoming MIDI messages.

You can also control the effect parameters using the BPM/MIDI Sync function<sup>\*2</sup>. Using this function enables you to synchronize the LFO speed of modulation effects or the delay time of delay effects with the tempo of the arpeggiator or sequencer. For more information, refer to “Dynamic Modulation Source (Dmod)” (p.246).

<sup>\*1</sup> These effect parameters are marked with **D<sup>mod</sup>** (p.187-).

<sup>\*2</sup> The effect parameters marked with **Sync** support this function (p.192-).

## 3. Effect I/O

To achieve the best tonal quality, signals sent to the Master Effects should be output at the maximum level without clipping. Also, use the “Wet/Dry” parameter for the Insert Effects and the “Output Level” or “Return 1, 2” parameter for the Master Effects to adjust the effect output level.

**⚡** The TRITON STUDIO does not have an input level meter to detect the effect input level. If the input level is too low, the S/N ratio may decrease. On the other hand, if the input level is too high, clipping may occur.

The following table shows the parameters related to the level settings:

### Program mode

Input	OSC1/2 High, Low Level	(P1)
	Filter1/2 Trim	(P3)
	Amp1/2 Level	(P4)
	Send1/2	(P8)
	Effect Trim parameter *1	(P8, P9)
Output	Effect Wet/Dry parameter	(P8, P9)
	Return1, 2	(P9)

### Combination mode

Input	Volume	(P0, P1)
	Send1/2	(P8)
	Effect Trim parameter *1	(P8, P9)
Output	Effect Wet/Dry parameter	(P8, P9)
	Return1, 2	(P9)

### Sequencer mode

Input	Volume	(P0)
	Send1/2	(P8)
	Effect Trim parameter *1	(P8, P9)
Output	Effect Wet/Dry parameter	(P8, P9)
	Return1, 2	(P9)

### Song Play mode

Input	Volume	(P0)
	Send1/2	(P8)
	Effect Trim parameter *1	(P8, P9)
Output	Effect Wet/Dry parameter	(P8, P9)
	Return1, 2	(P9)

### Sampling mode

Input	AUDIO INPUT LEVEL on the rear panel	
	Level	(P0)
	Effect Trim parameter *1	(P8)
Output	Effect Wet/Dry parameter	(P8)

### Global mode \*2

Input	AUDIO INPUT LEVEL on the rear panel	
	Level	(P0)
	Send1/2	(P0)

\*1 Some effects may not have these parameters.

\*2 Use this parameter to set the Audio Input Level in all modes other than Sampling mode.

**note** The audio CD (input) level from the CDRW-1 option is controlled by "Volume" in Sampling mode P5 or Disk mode Play Audio CD.

## Insert Effects (IFX 1, 2, 3, 4, 5)

### 1. In/Out

**Insert Effects (IFX 1, 2, 3, 4, 5)** have a **stereo input** and a **stereo output**. If you select **Dry** (no effect) for the "Wet/Dry" parameter, the stereo input signal will be output in stereo without being processed by the effect. If you select **Wet** (effect applied), the processed signal will be output in one of the following ways:



If you select **000: No Effect**, stereo input signals are output in stereo without being processed.

The possible routing of stereo inputs and outputs is indicated in the upper left corner of the block diagram.

Pressing the **ON/OFF button** of **IFX 1-5** in the **P8: Insert FX** pages in each mode will toggle between **ON** and **OFF**. When **OFF** is selected, the effect will be bypassed, and the stereo input signal will be output in stereo without being processed.

**MIDI** The TRITON STUDIO can also turn IFX1-5 off separately from the setting of the ON/OFF button by receiving MIDI control change message CC#92. Value 0 will turn them off, and value 1-127 will turn them on. You can also use "Effect Global SW" (Global P0: 0-1b) to turn IFX1-5 on and off. This MIDI control is performed on MIDI Global Channel "MIDI Channel" (Global P1: 1-1a).

### Double-size effects

**Double-size effects 090-102** use twice the area of what other effects use.

You can select them for **Insert Effects IFX2, IFX3, and IFX4**. Note that if you select a double-size effect for IFX2, you cannot use IFX3. In the same way, if you select a double-size effect for IFX3 or IFX4, you cannot use IFX4 or IFX5 respectively.

### Selecting double-size effects for IFX2 and IFX4

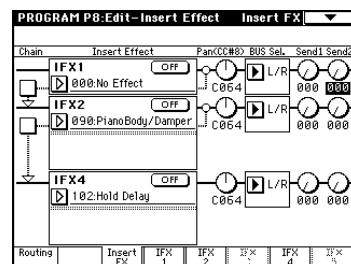

### Selecting a double-size effect for IFX3

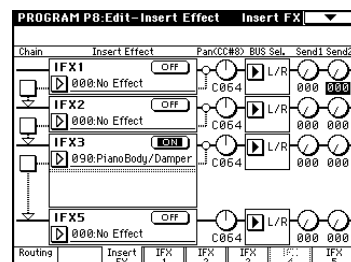

## 2. Routing

You can use up to five channels (IFX 1, 2, 3, 4, and 5) for the **Insert Effects** in any mode.

### 2-1. Program mode

Use **"BUS Select"** (Program P8: 8-1c) to set the destination bus of the oscillator output.

**L/R:** The signal is not sent to the Insert Effects. Instead, it is sent to AUDIO OUTPUT (MAIN) L/MONO and R after the Master EQ.

**IFX1-5:** The signal is sent to Insert Effects IFX 1, 2, 3, 4, 5.

**1, 2, 3, 4, 1/2, 3/4:** The signal is sent to AUDIO OUTPUT (INDIVIDUAL) 1, 2, 3, 4 ("Individual Outputs" [p.185](#)).

The signal is not sent to the Insert Effects, Master Effects, and or Master EQ.

**Off:** The signal is not sent to the L/R bus, 1, 2, 3, or 4 busses. After the Master Effects, the signal is output to AUDIO OUTPUT (MAIN). Select this option if you connect the Insert Effects with the Master Effects in series, with the send level specified by "Send1 (MFX1)" and "Send2 (MFX2)."

Use **"Send1 (to MFX1)"** and **"Send2 (to MFX2)"** (Program P8: 8-1d) to specify the send level for the Master Effects. This setting is effective if "BUS Select" is set to **L/R** or **Off**. If **"BUS Select"** (Program P8: 8-1c) is set to **IFX1-5**, use "Send1" and "Send2" (Program P8: 8-2a) to specify the send level of the post-IFX signal ([p.3. Mixer](#)).

**MIDI** Send1 responds to CC#93, and Send2 responds to CC#91. At this time, the actual send level uses the value of the Send 1 and 2 settings for Oscillators 1 and 2, multiplied by the Send 1 and 2 values received via MIDI.

If you are connecting the Insert Effects in series, **check** the **"Chain"** box (Program P8: 8-2a). If you check the box that is located between IFX1 and IFX2, the output signal from IFX1 is sent to IFX2. When the Insert Effects are connected in series, the values of the "Pan (CC#8)," "BUS Select," "Send1," and "Send2" parameters for the post-IFX signal will be used ([p.3. Mixer](#)).

The following figure shows an example of Oscillators 1 and 2 outputs being sent to IFX1.

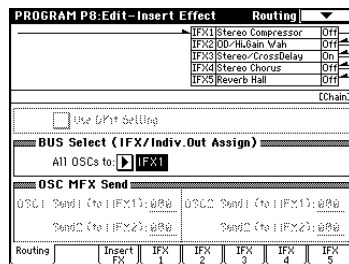

**Check** the **"Chain"** box to connect IFX1, 2, 3, 4, and 5 in series in this order. The "Pan (CC#8)," "BUS Select," "Send1," and "Send2" parameters for the post-IFX5 signal will be used.

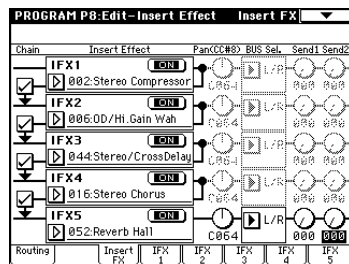

### — Settings for drum programs —

If you have selected **"Drums"** for **"Oscillator Mode"** (Program P1: 1-1a) of a Program, the **"USE DKit Setting"** box (Program P8: 8-1b) becomes available. If you **check this box**, **"BUS Select"** (Global P5: 5-2b) for each key of the selected DrumKit becomes effective.

For example, you can send a snare sound to IFX1 to apply the Gate effect, a kick sound to IFX2 to apply EQ, and other sounds to AUDIO OUTPUT (MAIN) L/MONO and R without applying any Insert Effects. If you **de-select the box**, all drum instrument outputs are sent to the bus specified by **"BUS Select"** (Program P8: 8-1c). You may apply any Insert Effects to all drum instruments, regardless of the DrumKit settings.

### 2-2. Combination, Sequencer, and Song Play modes

Use **"BUS Select"** (P8: "Routing" page in each mode) for timbres (Combination) and tracks (Sequencer, Song Play) to select an Insert Effect to apply to the corresponding timbres and tracks. You can route multiple timbres and tracks to a single Insert Effect.

As with Program mode, select **L/R, IFX1-5, 1-4, 1/2, 3/4, or Off** for each timbre and track.

**"Send1 (MFX1)"** and **"Send2 (MFX2)"** become available if **"BUS Select"** has been set to **L/R** or **Off**.

If **IFX1-5** is selected, use **"Send1"** and **"Send2"** for the post-IFX signal ([p.3. Mixer](#)).

**MIDI** Send1 responds to CC#93, and Send2 responds to CC#91. At this time, the actual send level uses the value of the Send 1 and 2 settings for Oscillators 1 and 2 of the Programs (selected for the timbres and tracks), multiplied by the Send 1 and 2 values received via MIDI ("Send Level" [p.183](#)).

The following figure shows an example of Combination mode. The Timbre 1 output is sent to **IFX1** and the Timbre 2 output is sent to **IFX2** according to the **"BUS Select"** setting. Other timbres are sent to **L/R**. The output signal passes through the Master EQ, then goes to AUDIO OUTPUT (MAIN) L/MONO and R.

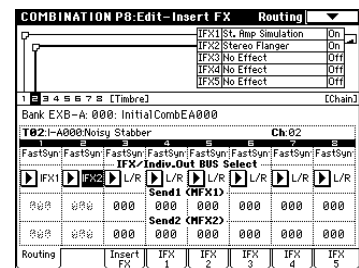

In the following example, the **"Chain"** box between IFX1 and IFX2 is **checked** so that the IFX1 output is sent to IFX2. **"IFX1: 001: St. Amp Simulation"** and **"IFX2: 020: Stereo Flanger"** are inserted to Timbre 1. **"IFX2: 020: Stereo Flanger"** is inserted to Timbre 2. The figure above ("Routing" pages) shows these settings. (In this example, IFX 3, 4, and 5 are not being used.)

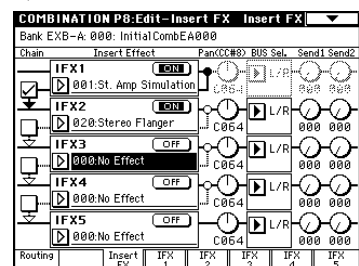

— Settings for drum Programs —

If a drum Program (“Oscillator Mode” Drums) is selected for timbres in **Combination mode** and for tracks in **Sequencer mode** and **Song Play mode**, you can select **DKit** for “BUS Select.” If you select **DKit**, the “BUS Select” (Global P5: 5–2b) settings for each key become effective, and each drum instrument sound will be routed to the corresponding buses (e.g.: the snare sound is sent to IFX1, kick sound to IFX2, and other sounds to L/MON and R). If you select anything other than **DKit**, you may apply any Insert Effects to all drum instruments, regardless of the DrumKit settings.

If you have selected **DKit** for “BUS Select,” you can select “DrumKit IFX Patch” (Combination P8: 8–1C) from the page menu. This option allows you to change the routing of the Insert Effects temporarily by changing “BUS Select” for each key. For example, assume that the DrumKit key assignment is set so that a snare sound is routed to IFX1 and a kick sound is routed to IFX2. In this case, if you wish to assign IFX 1 and 2 to the Programs used by other timbres and tracks, you can view the routing so that these DrumKit sounds are routed to IFX3 and IFX4 respectively. This type of patching is available only with the keys for which “BUS Select” (Global P5: 5–2b) is set to **IFX1–5**. You can check the settings with the Routing map. After you set “DrumKit IFX Patch,” press the **OK** button to confirm the setting. If you wish to restore the original DrumKit setting, set IFX1 to IFX1, IFX2 to IFX2, IFX3 to IFX3, IFX4 to IFX4, and IFX5 to IFX5.

In the following example, Drum Program is assigned to Timbre 1, and normal Programs are assigned to Timbres 2 and 3. “BUS Select” is set to **DKit** for Timbre 1, **IFX1** for Timbre 2, and **IFX2** for Timbre 3. With Timbre 1, the “BUS Select” (Global P5: 5–2b) for DrumKit setting becomes effective.

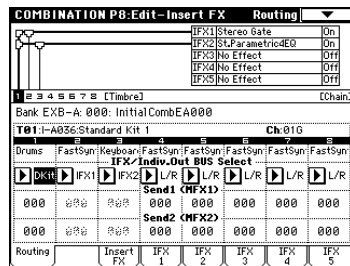

For example, assume that the snare sound is routed to IFX1, and the kick sound is routed to IFX2, and you wish to use an effect for a drum Program that is different from the effects for timbres 2 and 3. In this case, use “DrumKit IFX Patch.” Select “DrumKit IFX Patch” from the page menu to temporarily change the setting for the DrumKit from IFX1 to IFX3, and IFX2 to IFX4. When you confirm the setting, the snare sound will be routed to IFX3 and the kick sound will be routed to IFX4.

DrumKit IFX Patch dialog

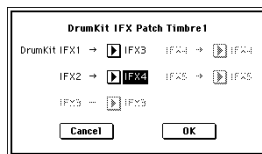

After setting the parameters

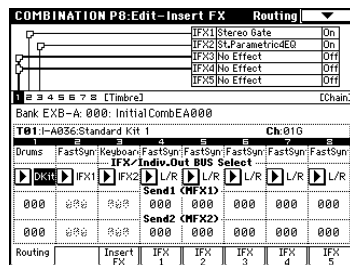

2–3. Sampling mode

The external input sounds from the AUDIO INPUT 1, 2, S/P DIF IN, and mLAN (if the EXB-mLAN is installed) jacks can be processed by the insert effects and sampled. You can also apply insert effects to the samples assigned to a multisample, and resample the result. In addition, an audio CD inserted in the CDRW-1 option can be played back, or processed by insert effects and sampled.

If you want to apply insert effects to an external sound and sample it, use “BUS Select” (Sampling P0: 0–2a) to set the bus for Input1 and 2. Settings for the input sound from the CDRW-1 are made by “Input” **Analog**, in the same way as for the external input sound from AUDIO INPUT 1 and 2. If you want to apply an insert effect to a sample and resample it, make settings for “BUS Select” (Sampling P8: 8–1b). In the respective “BUS Select,” specify the Input1 and 2 bus. You can choose from **L/R, IFX1–5, 1–4, 1/2, 3/4, and Off**.

In the example shown in the diagram below, the external input sound from Input1 and 2 is sent to **IFX1**. As in other modes, you can make insert effect settings in P8: Insert Effect, and apply the insert effect to the external input sound and sample the result.

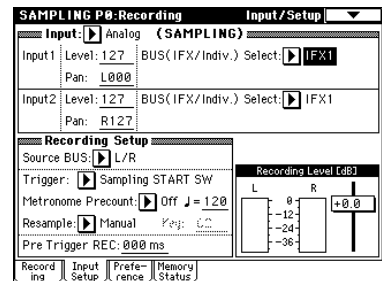

Here is an example of bus settings for applying IFX1 to the samples assigned to a multisample, and resampling the result.

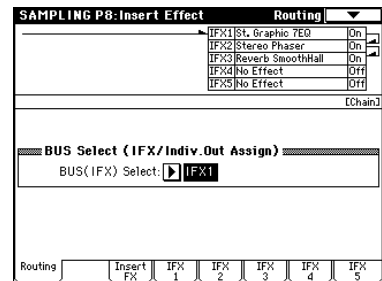

⚠ When you resample, L/R will automatically be selected as the “BUS (IFX) Select” setting. Please be aware of this if you continue sampling.

For details on any of these sampling methods, refer to BG p.39, 101.

2–4. Audio Input

In Program, Combination, Sequencer, Song Play, and Disk modes, you can apply the insert effects, master effects, and master EQ to the external input sounds from the AUDIO INPUT 1, 2, S/P DIF IN, and mLAN (if the EXB-mLAN option is installed). The external input sounds will be routed from these jacks to the effect(s) as specified by the “Input (COMBI, PROG, SEQ, S.PLAY, DISK)” (Global P0: 0–3a) settings.

In Disk mode, an inserted audio CD can be played back if the CDRW-1 option is installed. The input sound from the CDRW-1 is specified by “Input” **Analog** in the same way as for the external input sound from AUDIO INPUT 1 and 2.

**note** If you want to play back an audio CD without applying the TRITON STUDIO's effects, set "Input" Analog (COMBI, PROG, SEQ, S. PLAY, DISK) as settings for *Input1* to "Level" 127, "Pan" L000, "BUS Select" L/R, "Send1, 2" 000, and set *Input2* "Pan" to R127 and the remaining parameters to the same settings as for *Input1*.

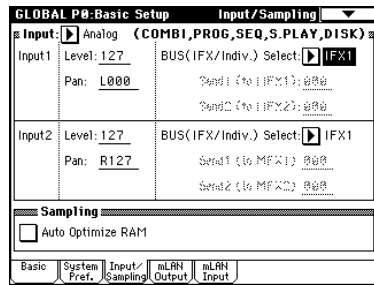

Use "BUS Select" (Global P0: 0-3a) to set Inputs 1/2 buses by selecting from L/R, IFX1-5, 1-4, 1/2, 3/4, and Off. "Send1 (to MFX1)" and "Send2 (to MFX2)" become effective only when "BUS Select" (Global P0: 0-3a) is set to L/R or Off. If IFX1-5 is selected, use "Send1" and "Send2" for the post-IFX signal (≡ "3. Mixer").

**⚠** This setting is ignored in Sampling mode. Refer to "2-3. Sampling Mode" for information on the Sampling mode settings.

Insert effect settings are made in P8: Insert Effect of 1 Program, 1 Combination, 1 Song, and Song Play modes. For the external input sound from the various input jacks, you can use the TRITON STUDIO's effects as a 6-in 6-out effect processor, or use them in conjunction with the internal sounds. For example, in Program mode or Combination mode, you can route the incoming signal from AUDIO INPUTS 1 and 2 and the oscillator sound to "Insert Effect 093: Vocoder" in order to set up a vocoder effect in which the internal sound is controlled by the mic inputs ("093: Vocoder" ≡ p.233).

**⚠** In Disk mode, the effects will have the settings of the previously-selected mode.

### 3. Mixer

Use "Pan (CC#8)," "BUS Select," "Send1," and "Send2" of the P8: "Insert FX" page for the post-IFX signal in all modes to set the pan/bus and the send level to the Master Effects MFX1 and MFX2.

If you have checked the "Chain" box to connect the Insert Effects in series, these parameters "Pan (CC#8)," "BUS Select," "Send1" and "Send2" for the post-IFX (last Insert Effect in the chain) signal become effective.

**⚠** The master effects cannot be used in Sampling mode. This means that here you can set only the "Pan" (CC#8) that follows the insert effects.

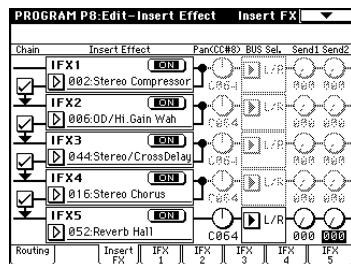

### 3-1. Pan (CC#8)

This parameter enables you to set the pan of the post-IFX signal.

If you are using the **stereo-in/stereo-out** Insert Effects (≡ "In/Out"), set this parameter to "C064" to enable the "Pan" settings for the oscillators (Program P4: 4-1b, 4-4), timbres (Combination P0: 0-2b, P1: 1-1b), tracks (Sequencer P0: 0-3a/4a, Song Play P0: 0-3a/4a), and audio inputs (Sampling P0: 0-2a, Global P0: 0-3a).

If you are using **mono-in/stereo-out** or **mono-in/mono-out** Insert Effects (≡ "In/Out"), the "Pan" settings for the oscillators, timbres, tracks and audio inputs are ignored, and they are set to Center. Use the "Pan (CC#8)" parameter (P8: "Insert FX" page) to set the pan. "L000" is hard left, and "R127" is hard right.

Insert Effect = Stereo In - Stereo Out

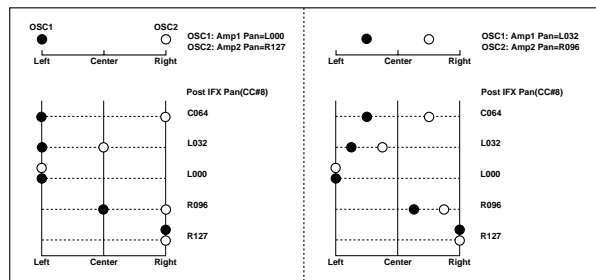

Insert Effect = Mono In - Stereo Out  
Mono In - Mono Out

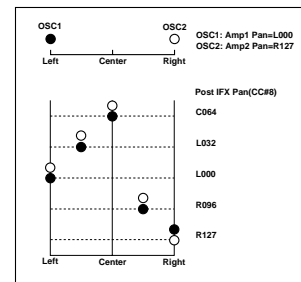

**MIDI** You can control these parameters via CC#8.

### 3-2. BUS Sel. (BUS Select)

This parameter enables you to specify the destination bus for the post-IFX signals. "L/R" is a common setting to send signals to the Master EQ before they are routed to the OUTPUT (MAIN) L/MONO and R outputs.

Select 1, 2, 3, 4, 1/2, or 3/4 to route the signals to OUTPUT (INDIVIDUAL) 1, 2, 3, or 4 (≡ "Individual Outputs"). Select "Off" so that no signals will be output to L/R, 1, 2, 3, or 4. In this case, the signals are routed from the Master Effects to AUDIO OUTPUT (MAIN). This setting is used when you are connecting the Insert Effects with the Master Effects in series using "Send1 (MFX1)" and "Send2 (MFX2)."

### 3-3. Send1, Send2

These parameters enable you to set the send level of the signals routed to Master Effects MFX1 and MFX2. These settings are effective only when "BUS Select" is set to L/R or Off.

If you are not using any Insert Effects, use "Send1" and "Send2" of the P8: "Routing" page in Program, Combination, Sequencer, and Song play modes to set the Master Effect send level (Use the Global P0: Input/Sampling page to set the send level for the audio inputs.).

**MIDI** "Send1" responds to CC#93 and "Send2" responds to CC#91.



## 4. Controlling the Insert Effects via MIDI

Using the Dynamic Modulation (Dmod) function enables you to control all effect parameters in real-time during performance from the controllers of the TRITON STUDIO or a connected MIDI sequencer. You can also control the **Pan (CC#8)**, “**Send1**,” and “**Send2**” parameters in the same way.

### 4-1. Program mode and Sampling mode

You can control the parameters on MIDI Global channel (MIDI Channel” (Global P1: 1-1a).

### 4-2. Combination mode

Use “Ctrl Ch” parameters of the “IFX1-5” pages to set up the control channels for IFX1, 2, 3, 4, and 5. Select an appropriate option from **Ch01-16**, **Gch**, and **All Routed**.

**Ch01-16:** Select this when you want to control each insert effect from a different channel. An “\*” symbol will be displayed at the right of the MIDI channel Ch01-16 of the timbre that is routed to each insert effect. If the routed timbres have different MIDI channel settings, this parameter is used to specify the channel that will control the insert effect.

**Gch:** Select this option if you wish to control the parameters on MIDI Global channel “MIDI Channel” (Global P1: 1-1a). This is a common setting.

**All Routed:** Select this option to control the parameters on all the channels (channels 1-16 that have a “\*” mark) that are routed to the corresponding Insert Effects.

### 4-3. Sequencer mode and Song Play mode

Use “Ctrl Ch” parameters of the “IFX1-5” pages to set up the control channels for IFX1, 2, 3, 4, and 5. Select an appropriate option from **Ch01-16** and **All Routed**.

**Ch01-16:** Select this when you want to control each insert effect from a different channel. An “\*” symbol will be displayed at the right of the MIDI channel Ch01-16 of the track that is routed to each insert effect. If two or more tracks with differing MIDI channels Ch01-16 are being sent to a single insert effect, this parameter is used to specify the one track that will control the insert effect.

**All Routed:** Select this option to control the parameters on all the channels (channels 1-16 that have a “\*” mark) that are routed to the corresponding Insert Effects.

“**All Routed**” is a typical option. If you wish to control the parameters on a single channel, you may select it from **Ch01-16**.

## Master Effects (MFX1, 2)

### 1. In/Out

The I/Os of **Master Effects MFX1** and **MFX2** are **mono-in/stereo-out**. “Send1” and “Send2” determine the send level to the Master Effects (“Routing” and “Mixer”). Stereo signals will be combined to a mono signal automatically and sent to the effects.

The Master Effects do not output any **Dry** signals (signals that are not processed by the effects). Therefore, they output only **Wet** (signals that are processed by the effects) signals (set via the “Wet/Dry” of the “MFX1” and “MFX2” pages). The output signals from the Master Effects are routed to the L/R bus with the output level specified by “Return1” and “Return2.” These output signals are mixed with the output signals from the bus specified by “BUS Select” (P8: “Routing” page in each mode) L/R, or with the output signals from the bus specified by “BUS Select” (“Insert FX” page in each mode) L/R, then routed to the Master EQ.

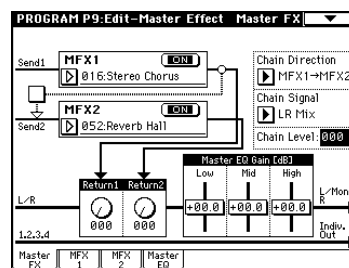

Selecting “000: No Effect” will mute the output. The processed signal will be output in one of the following ways, according to the type of **effects 001-089**.

Wet	Mono In - Mono Out	
	Mono In - Stereo Out	
	Stereo In - Stereo Out	

The possible routing of effect signal inputs and outputs is indicated in the upper left corner of the block diagram.

Pressing the **ON/OFF** button for MFX1 and 2 of the P9: Master FX page in each mode will toggle between **ON** and **OFF**. When **OFF** is selected, the output signals will be muted.

**MIDI** The TRITON STUDIO can also turn MFX 1 and 2 off separately from the setting of the ON/OFF button by receiving MIDI control change message CC#94 and CC#95 respectively. Value 0 will turn them off, and value 1-127 will turn them on. You can also use “Effect Global SW” (Global P0: 0-1b) to turn MFX1 and 2 on and off. This MIDI control is performed on MIDI Global Channel “MIDI Channel” (Global P1: 1-1a).

### Double-size effects

You cannot select double-size effects for **Master Effects MFX1** and **MFX2**.

## 2. Routing

You can use up to two channels (MFX1 and 2) for the Master Effects in any mode other than in Sampling mode. (You cannot use the Master Effects in Sampling mode.) If you are not using any Insert Effects in any mode, the Master Effects send levels are determined by the “Send1 (MFX1)” and “Send2 (MFX2)” parameters specified independently for the oscillators (Program), timbres (Combination), tracks (Sequencer and Song Play), and audio inputs (Global). For example, you can apply substantial reverberation to a piano sound assigned to the timbre and tracks, a small amount of reverberation to the strings sound, and no reverberation to the bass sound. If you are using the Insert Effects, set the “Send1” and “Send2” parameters for the post-IFX signals.

### 2-1. Program mode

Use the “Send1 (to MFX1)” and “Send2 (to MFX2)” parameters of the P8: “Routing” page, or the “Send1” and “Send2” parameters of the P8: “Insert FX” page for the post-IFX1-5 signals, to set the Master Effect send level.

If you have set “BUS Select” to L/R or Off, “Send1 (MFX1)” and “Send2 (MFX2)” of the “Routing” page are effective. These parameters can be set for oscillators 1 and 2 individually.

If you have set “BUS Select” to IFX1-5, “Send1” and “Send2” of the “Insert FX” page for the post-IFX1-5 signals are effective. If you are using the Insert Effects in chain (series), the “Send1” and “Send2” parameters for the post-IFX (last IFX) are effective.

If you have set “BUS Select” to 1, 2, 3, 4, 1/2, or 3/4, the oscillator signals are output directly to AUDIO OUTPUT (INDIVIDUAL) 1, 2, 3, or 4 (Individual Outputs”). In this case the Send 1 and Send 2 settings are ignored, and the Master Effects will not be applied. (p.185)

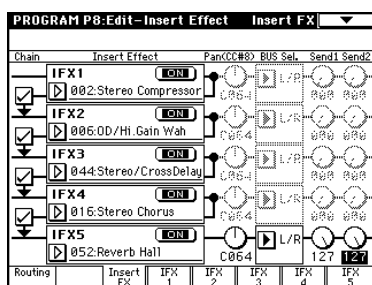
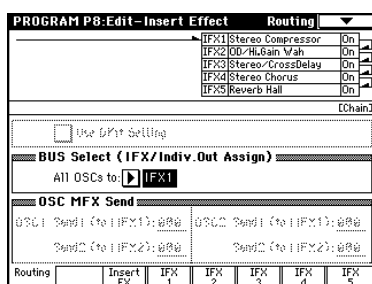
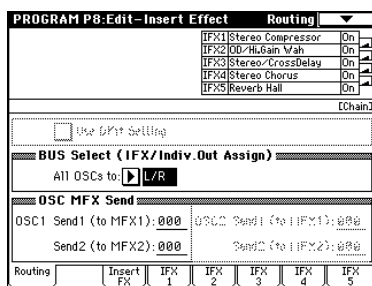

**MIDI** Send1 responds to CC#93 and Send2 responds to CC#91 on MIDI Global channel “MIDI Channel” (Global P1: 1-1a). At this time, the actual send level uses the value of the Send 1 and 2 settings for Oscillators 1 and 2, multiplied by the Send 1 and 2 values received via MIDI.

If you have selected “Drums” for “Oscillator Mode” (Program P1: 1-1a) of a Program, the “USE DKit Setting” box (Program P8: 8-1b) becomes available.

If you check this box, Send1 and Send2 levels for each key of the selected DrumKit become effective. If “BUS Select” (Global P5: 5-2b) is set to L/R or Off for a drum instrument key, “Send1 (to MFX1)” and “Send2(toMFX2)” (Global P5: 5-2b) become effective. If “BUS Select” is set to IFX1-5, “Send1” and “Send2” (Program P8: 8-2a) become effective. If this is unchecked, the routing will be the same as when “Oscillator Mode” is Single or Double, and the “Send1 (MFX1)” and “Send2 (MFX2)” (Program P8: 8-1d) settings or the post-IFX1-5 “Send1” and “Send2” settings of the P8: Insert FX page IFX1-5 (Program P8: 8-2a) will apply to all drum instruments.

### 2-2. Combination, Sequencer, and Song Play modes

Use “Send1 (MFX1)” and “Send2 (MFX2)” (P8: “Routing” page) for timbres (Combination) and tracks (Sequencer, Song Play) to set the Send1 and 2 levels for each timbre and track. As with Program mode, if “BUS Select” is set to L/R or Off, “Send1 (MFX1)” and “Send2 (MFX2)” become effective. At this time, the actual levels use these Send1 and 2 level values, multiplied by the send level values of oscillators 1 and 2 (“Oscillator Mode” is set to “Double”) of the Program P8: “Routing” page.

#### – Send level –

For example, if a Program’s “OSC1 Send1” is set to 127, “Send2” set to 064, “OSC2 Send1” set to 064, “Send2” set to 127, a Combination’s “Send1” set to 064, and “Send2” set to 127, the actual send levels of the combination are calculated as follows:

$$\begin{aligned} \text{OSC1 Send1} &= 127 (100\%) * 064 (50\%) = 064 (50\%) \\ \text{OSC1 Send2} &= 064 (50\%) * 127 (100\%) = 064 (50\%) \\ \text{OSC2 Send1} &= 064 (50\%) * 064 (50\%) = 032 (25\%) \\ \text{OSC2 Send2} &= 127 (100\%) * 127 (100\%) = 127 (100\%) \end{aligned}$$

If IFX1-5 is selected for “BUS Select”, use the “Send1” and “Send2” parameters for the post-IFX signals.

If 1, 2, 3, 4, 1/2, or 3/4 is selected instead, these Send1 and 2 settings are ignored and the Master Effect is not applied.

**MIDI** Send1 responds to CC#93, and Send2 responds to CC#91. If “Send1 (MFX1)” and Send2 (MFX2)” for each timbre/track are effective, the parameter will be controlled on the MIDI channels set for the corresponding timbres and tracks. If the “Send1” and “Send2” parameters for the post-IFX1-5 signals are effective, they can be controlled on the MIDI channels assigned to IFX1-5.

The following examples are in Combination mode. In the upper figure, “BUS Select” is set so that Timbre 1 is routed to IFX1, Timbre 2 to IFX2, Timbre 3 to IFX3, Timbre 4 to IFX4, Timbres 5 and 6 to IFX5, and Timbres 7 and 8 to L/R. In this case, use “Send1” and “Send2” for the post-IFX1 (001: St. Amp Simulation) signal to set the send level of the Timbre 1 routed to the Master Effect. (In this example they are set to 032 and 127.) In the same way, use “Send1” and “Send2” for the post-IFX2, 3, and 4 signals to set the send levels of Timbres 2, 3, and 4, and use the “Send1” and “Send2” parameters for the post-IFX5 signal to set the send levels of Timbres 5 and 6. For Timbres 7 and 8, the settings of “Send1 (MFX1)” and “Send2 (MFX2)” will be effective. (At

this time, the actual send levels use these Send 1 and 2 values multiplied by the Send1 and 2 settings for Program oscillators 1 and 2.)

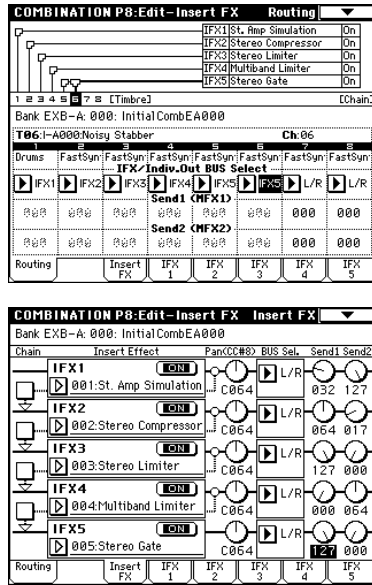

If drum Programs are selected for timbres in Combination mode and for tracks in Sequencer mode and Song Play mode, you can select “DKit” for “BUS Select.” If you select “DKit,” the “BUS Select” (Global P5: 5–2b) settings for each key become effective, and each drum instrument sound will be routed to the corresponding buses. At this time, the actual send levels use these Send 1 and 2 values, multiplied by the Send1 and 2 settings for each DrumKit key. (Use the “Send1” and “Send2” parameters for the post-IFX1–5 signal to set the send levels for the DrumKit keys for which the “BUS Select” parameters are set to IFX1–5.) If L/R or Off are selected, this Send1 or 2 level will be multiplied by the send levels specified in the Program P8: Routing page parameters “OSC1 Send1 (to MFX1)” and “Send2 (to MFX2)” (Program P8: 8–1d), in the same way as when “Oscillator Mode” is Single or Double. If “BUS Select” is set to IFX1–5, use “Send1” and “Send2” for the post-IFX signal. If “BUS Select” is set to 1, 2, 3, 4, 1/2, or 3/4, the Send 1 and 2 settings will be ignored.

### 2–3. Sampling Mode

You cannot use the Master Effects and Master EQ in Sampling mode.

### 2–4. Audio Input

In Program, Combination, Sequencer, Song Play, and Disk modes, the insert effects, master effects, and master EQ can be applied to the external input sound from the AUDIO INPUT 1, 2, S/P DIF IN, and mLAN jacks. The external sound input from these jacks will be routed to the effects according to the “Input (COMBI, PROG, SEQ, S.PLAY, DISK)” (Global P0: 0–3a) settings.

In Disk mode, you can play back an audio CD if the CDRW-1 option is installed. Settings for the sound input from the CDRW-1 are made by “Input” Analog, in the same way as for the external sound input from AUDIO 1 and 2.

**note** If you want to play back an audio CD without applying the TRITON STUDIO’s effects, set “Input” Analog settings for Input1 to “Level” 127, “Pan” L000, “BUS Select” L/R, “Send1, 2” 000, and set Input2 “Pan” to R127 and the remaining parameters to the same settings as for Input1.

Set the send level of the Input 1 and 2 signals routed to the Master Effects, using “Send1 (to MFX1)” and “Send2 (to MFX2)” (Global P0: 0–3a). These settings become effective only when “BUS Select” is set to L/R or Off. If IFX1–5 is selected, use the “Send1” and “Send2” parameters (see “3. Mixer”). If 1, 2, 3, 4, 1/2, or 3/4 is selected, the Send 1 and Send 2 settings are ignored.

These settings are ignored in Sampling mode.

Use P9: Master Effect in Program, Combination, Song, and Song Play modes to set the Master Effects and Master EQ.

In Disk mode, the effects will be set as they were in the previously-selected mode.

## 3. Mixer

The send levels will determine the levels at which the oscillator (Program), timbre (Combination), track (Sequencer), and audio input (set in the Program/Combination/Sequencer P0: Sampling page or the Global P0: Input/Sampling page) signals are input to the master effects. In the P9: Master FX page of each mode, you can specify the output level, chaining (series connection) between master effects, and adjust the master EQ gain.

### 3–1. Return1, Return2

These parameters determine the level of signals output from MFX1 and MFX2. A value on the left side of the “Wet/Dry” parameter of a target effect for MFX 1 and 2 is used as the output level (25% with the “Wet/Dry” parameter setting of 25:75, 100% with the Wet setting, and 0% with the Dry setting). The signals with the “Return1” and “Return2” settings are multiplied by these output levels, and sent to the L/R bus, then mixed with the output signals for which “BUS Select” is set to L/R or for which “BUS Select” of the “Insert FX” page is set to L/R.

For example, with MFX1 “Wet/Dry” set to 50:50 (50%) and “Return1” set to 64 (50%), the resultant effect level will be 25%. The effect level is maximum (100%) when “Wet/Dry” is set to “Wet” and “Return1” is set to 127.

### 3–2. Chain check box

Press this box to chain MFX1 and MFX2 to each other.

The following figure indicates that the output from “MFX1: 016: Stereo Chorus” is added to “MFX2: 052: Reverb Hall” input.

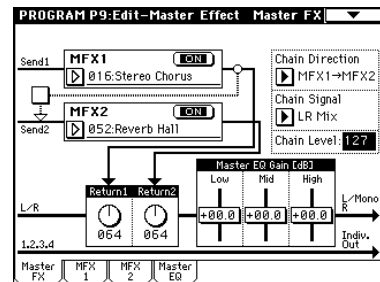

### 3-3. Chain Direction

If you have checked the “Chain” box, you can set the direction of the connection here. You can also visually confirm the direction on the LCD.

### 3-4. Chain Signal

This parameter enables you to select signals routed between MFX1 and 2. If the chain direction (order) is from MFX1 to MFX2, selecting **LR Mix** will cause the stereo L/R outputs from MFX1 to be mixed and input to MFX2. This setting is useful when you wish to serially connect delays that are panned to L and R (e.g., “043: L/C/R Delay”). Selecting **L Only** or **R Only** will cause only one channel of stereo outputs from MFX1 to be input to MFX2. This setting is suitable for a chain connection of a reverb effect and a modulation effect such as **016: Stereo Chorus**.

### 3-5. Chain Level

This parameter determines the level of signals routed from one MFX to the other MFX in a chain connection.

### 3-6. Master EQ Gain [dB]

These parameters are used to set the gain of the Low, Mid, and High stereo three-band EQ that is located right before AUDIO OUTPUT (MAIN) L/Mono and R. Low and High EQs are of the shelving type, and Mid EQ is a band type equalizer. These slider settings are linked with the Low, Mid, and High “Gain [dB]” parameters of the “MasterEQ” page. Use this “MasterEQ” page to set the center frequency, band width (for Mid), and dynamic modulation of the EQ bands.

## 4. Controlling the Master Effects via MIDI

You can use the Dynamic Modulation (Dmod) function to control all Master Effects parameters in real-time from the TRITON STUDIO’s controllers or from an external MIDI sequencer.

In **Program mode**, the parameters are controlled on MIDI Global channel “MIDI Channel” (Global P1: 1-1a).

In **Combination mode**, **Sequencer mode**, and **Song Play mode**, you can set the control channels for MFX1 and MFX2 using the “Ctrl Ch” parameters of the “MFX1-2” pages. Select the desired option from **Ch01-16**, and **Gch**.

**Ch01-16**: Select this option if you wish to control the parameters for each Master Effect on different channels.

**Gch**: Select this option if you wish to control the parameters on MIDI Global channel “MIDI Channel” (Global P1: 1-1a). This is the normal setting.

## Master EQ

The Master EQ (stereo, three-band EQ) is located right before AUDIO OUTPUT (MAIN) L/MONO, R. Low and High EQs are of the shelving type, and Mid EQ is a peaking type equalizer. You can control the Low Gain and High Gain parameters using the Dynamic Modulation function. The Master EQ is applied to the signal input from the L/R bus. For more information on the parameters (p.239).

## Main Output

The main L/MONO and R outputs of the TRITON STUDIO are output from the AUDIO OUTPUT (MAIN) L/MONO and R jacks, the S/P DIF OUT (MAIN) jack, and the headphone jack. If the EXB-DI option is installed, these outputs can be digitally output from the DIGITAL OUT jack, and from the mLAN connector if the EXB-mLAN option is installed.

## Individual Outputs

The TRITON STUDIO is equipped with four individual AUDIO OUTPUTS (INDIVIDUALS). You can route the oscillator (Program), timbre (Combination), and track (Sequencer) output or the post-IFX signals to these four individual outputs.

These can be digitally output from the DIGITAL OUT jack if the EXB-DI option is installed, or from the mLAN connector if the EXB-mLAN option is installed.

Use “BUS Select” of the P8: “Routing” page in Program, Combination, Sequencer, or Song Play mode to route the oscillators (Program), timbres (Combination), or tracks (Sequencer, Song Play) to AUDIO OUTPUTS (INDIVIDUAL). If you are using the Insert Effects, use “BUS Select” of the P8: Insert FX page to route the post-IFX signals.

**1, 2, 3, 4**: Mono signals are routed to AUDIO OUTPUTS (INDIVIDUAL).

**1/2, 3/4**: Stereo signals are routed to AUDIO OUTPUTS (INDIVIDUAL). Use AUDIO OUTPUTS (INDIVIDUAL) 1/2 in stereo for 1/2, and use AUDIO OUTPUTS (INDIVIDUAL) 3/4 in stereo for 3/4.

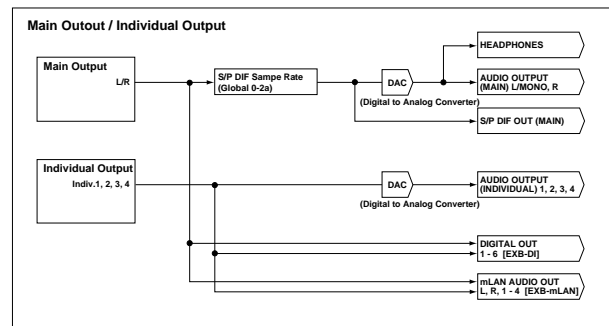

# Effect/Mixer Block Diagram

## Program mode

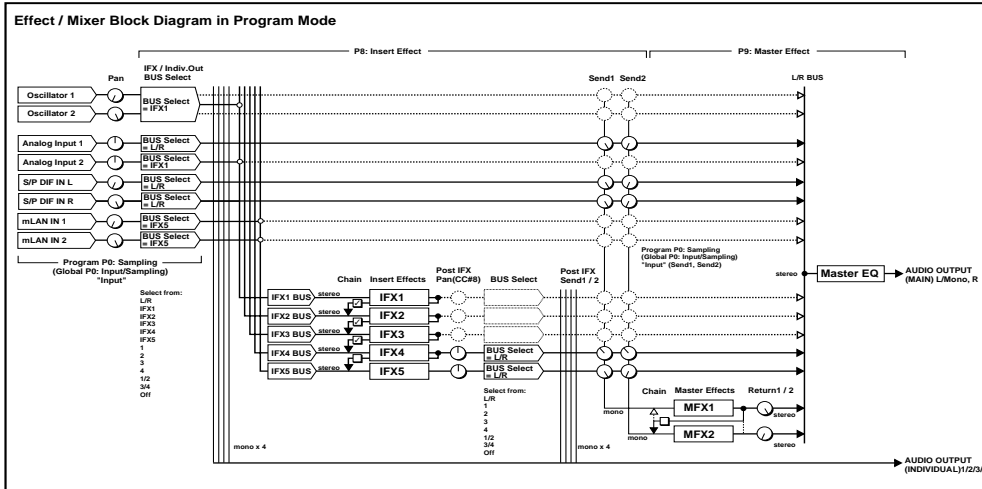

## Combination mode, Sequencer mode, Song Play mode, Disk mode

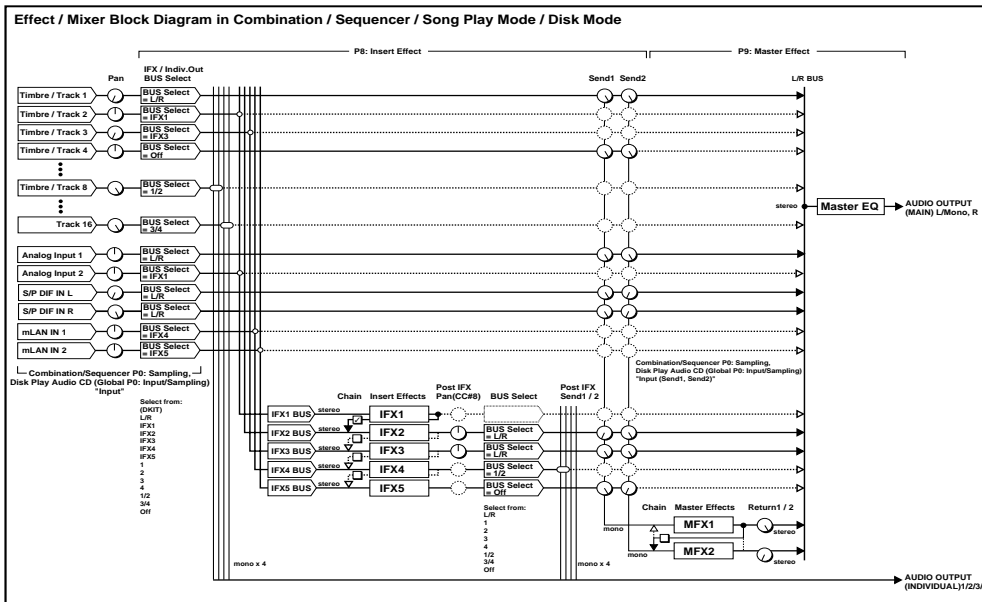

## Sampling mode

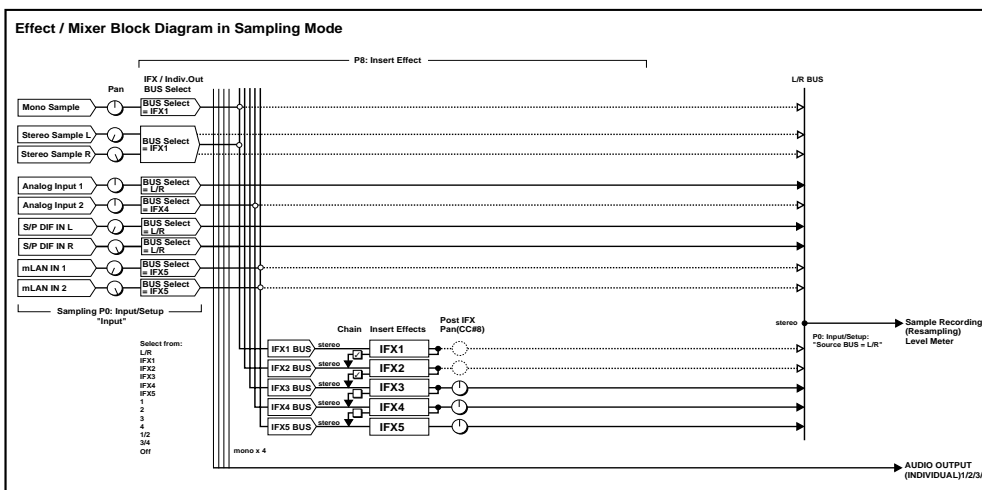

## Filter/Dynamic

Filter and dynamics control effects

### 000: No Effect

Select this option when you do not use any effects. The Insert Effect section outputs unprocessed signals and the Master Effect section mutes the output.

### 001: St. Amp Simulation (Stereo Amp Simulation)

This effect simulates the frequency response characteristics of guitar amplifiers. It produces a realistic effect as though the sound were being played through a guitar amp. It is also effective for organ and drum sounds.

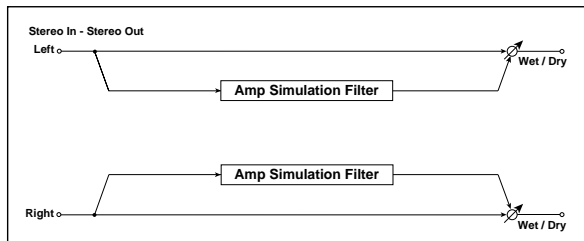

a	Amplifier Type Selects the type of guitar amplifier	SS, EL84, 6L6
b	Wet/Dry Sets the balance between the effect and dry sounds	Dry, 1:99...99:1, Wet <b>D<sup>mod</sup></b>
	Src Selects the modulation source of the effect balance	Off...Tempo
	Amt Sets the modulation amount of the effect balance	-100...+100

### 002: Stereo Compressor

This effect compresses the input signal to regulate the level and give a "punchy" effect. It is useful for guitar, piano, and drum sounds. This is a stereo compressor. You can link left and right channels, or use each channel separately.

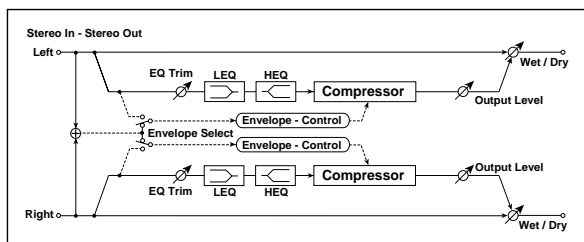

a	Envelope Select Determines whether the left and right channels are linked or used separately	L/R Mix, L/R Individually <b>E<sup>3</sup></b>
b	Sensitivity Sets the sensitivity	1...100 <b>E<sup>3</sup></b>
c	Attack Sets the attack level	1...100 <b>E<sup>3</sup></b>
d	EQ Trim Sets the EQ input level	0...100

e	Pre LEQ Gain [dB] Sets the gain of Low EQ	-15.0...+15.0dB
	Pre HEQ Gain [dB] Sets the gain of High EQ	-15.0...+15.0dB
f	Output Level Sets the output level of the compressor	0...100 <b>E<sup>3</sup></b> , <b>D<sup>mod</sup></b>
	Src Selects the modulation source for the compressor output level	Off...Tempo
	Amt Sets the modulation amount of the compressor output level	-100...+100
g	Wet/Dry Sets the balance between the effect and dry sounds	Dry, 1:99...99:1, Wet <b>D<sup>mod</sup></b>
	Src Selects the modulation source of the effect balance	Off...Tempo
	Amt Sets the modulation amount of the effect balance	-100...+100

#### a: Envelope Select

This parameter selects whether the left and right channels are linked to control both signals simultaneously, or whether each channel is controlled independently.

#### b: Sensitivity, f: Output Level

The "Sensitivity" parameter sets the sensitivity of the compressor. If this parameter is set to a higher value, lower level sounds will be boosted. With a higher Sensitivity, the overall volume level is higher. To adjust the final volume level, use the "Output Level" parameter.

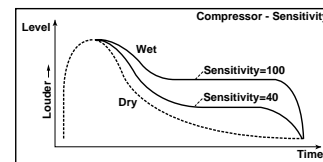

#### c: Attack

This parameter controls the attack level.

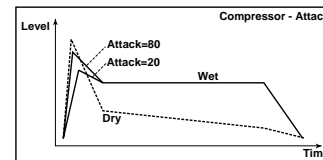

### 003: Stereo Limiter

The Limiter regulates the input signal level. It is similar to the Compressor, except that the Limiter compresses only signals that exceed the specified level to lower unnecessary peak signals. The Limiter applies a peaking-type EQ to the trigger signal (which controls the degree of the Limiter effect), allowing you to set any band width to be covered. This effect is a stereo limiter. You can link left and right channels, or use each channel individually.

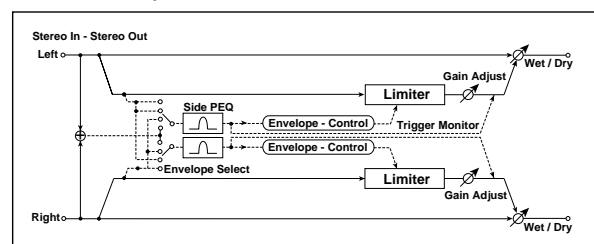

a	Envelope Select Selects from linking both channels, controlling only from left channel, only from the right channel, or controlling each channel individually	L/R Mix, L Only, R Only, L/R Individually	
b	Ratio Sets the signal compression ratio	1.0:1...50.0:1, Inf:1	
c	Threshold [dB] Sets the level above which the compressor is applied	-40...0dB	
d	Attack Sets the attack time	1...100	
	Release Sets the release time	1...100	
e	Gain Adjust [dB] Sets the output gain	-Inf, -38...+24dB	
	Src Selects the modulation source for the output gain	Off...Tempo	
	Amt Sets the modulation amount of the output gain	-63...+63	
f	Side PEQ Insert Toggles between on/off of the trigger signal's EQ	Off, On	
	Trigger Monitor Switches between effect output monitor and trigger signal monitor	Off, On	
g	Side PEQ Cutoff [Hz] Sets the EQ center frequency for the trigger signal	20...12.00kHz	
	Q Sets the EQ bandwidth for the trigger signal	0.5...10.0	
	Gain [dB] Sets the EQ gain for the trigger signal	-18.0...+18.0dB	
h	Wet/Dry Sets the balance between the effect and dry sounds	Dry, 1:99...99:1, Wet	
	Src Selects the modulation source of the effect balance	Off...Tempo	
	Amt Sets the modulation amount of the effect balance	-100...+100	

**a: Envelope Select**

When **L/R Mix** is selected for this parameter, the left and right channels are linked to control the Limiter using the mixed signal. If **L Only** (or **R Only**) is selected, the left and right channels are linked, and the Limiter is controlled via only the left (or right) channel.

With **L/R individually**, the left and right channels control the Limiter individually.

**b: Ratio, c: Threshold [dB], e: Gain Adjust [dB]**

This parameter sets the signal compression "Ratio". Compression is applied only when the signal level exceeds the "Threshold" value.

Adjust the output level using the "Gain Adjust" parameter, since compression causes the entire level to be reduced.

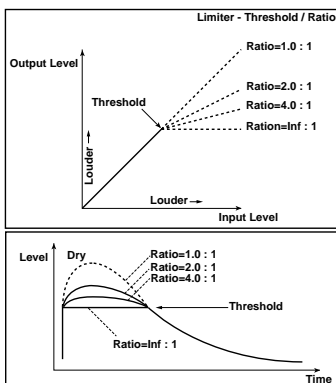

**d: Attack, d: Release**

These parameters set the attack time and release time. A higher attack time will cause the compression to be applied more slowly.

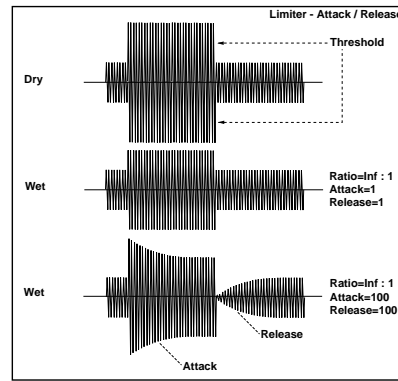

**f: Side PEQ Insert, g: Side PEQ Cutoff [Hz], g: Q, g: Gain [dB]**

These parameters are used to set the EQ applied to the trigger signal.

The Limiter determines whether the compression is applied or not, based on the post-EQ trigger signal. Setting the equalizer allows you to set the Limiter to respond to any frequency band.

**f: Trigger Monitor**

Setting this parameter **On** will cause the trigger signal to be output, instead of the effect sound. Use this parameter to check the trigger signal with EQ applied. Usually, set this to **Off**.

**004: Multiband Limiter**

This effect applies the Limiter to the low range, mid range, and high range of the input signal. You can control dynamics for each range to adjust the sound pressure of the low range, mid range, and high range in a different way from the EQ.

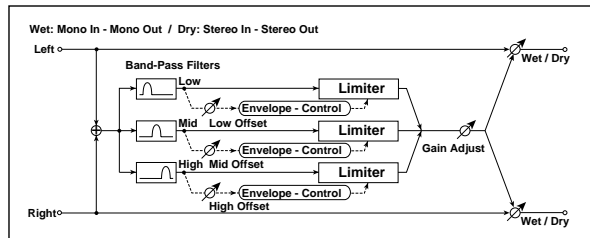

a	Ratio Sets the signal compression ratio	1.0:1...50.0:1, Inf:1	
b	Threshold [dB] Sets the level above which the compressor is applied	-40...0dB	
c	Attack Sets the attack time	1...100	
d	Release Sets the release time	1...100	
e	Low Offset [dB] Gain of the low-range trigger signal	-40...0dB	
f	Mid Offset [dB] Gain of the mid-range trigger signal	-40...0dB	
g	High Offset [dB] Gain of the high-range trigger signal	-40...0dB	
h	Gain Adjust [dB] Sets the output gain	-Inf, -38...+24dB	
	Src Selects the modulation source for the output gain	Off...Tempo	
	Amt Sets the modulation amount of the output gain	-63...+63	

i	Wet/Dry	Dry, 1:99...99:1, Wet	$D^{mod}$
	Src	Selects the modulation source of the effect balance	Off...Tempo
	Amt	Sets the modulation amount of the effect balance	-100...+100

**e: Low Offset [dB], f: Mid Offset [dB], g: High Offset [dB]**

These parameters set the gain of the trigger signal. For example, if you do not want to apply compression to the high range, reduce the "High Offset" value down below the "Threshold" level. In this way, the high range limiter will not respond, and compression will not be applied.

## 005: Stereo Gate

This effect mutes the input signal if its level is lower than the specified level. It also reverses the on and off operation of the gate, and uses Note On and Off messages to turn the gate on and off.

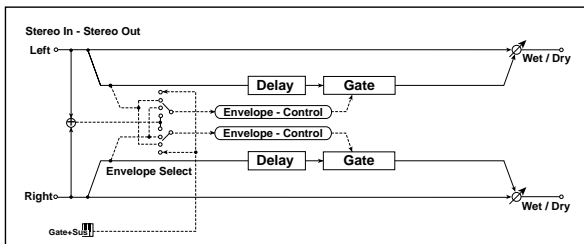

a	Envelope Select	D-mod, L/R Mix, L Only, R Only	$E^{3S}$ , $D^{mod}$
	Src	Selects from Control via the modulation source, mixing the left and right signals, Only left, and Only right	Off...Gate2+Dmpr
b	Polarity	Switches between non-reversed and reversed Gate on/off	+ - $E^{3S}$
c	Threshold	Sets the level to which the Gate is applied	0...100 $E^{3S}$
d	Attack	Sets the attack time	1...100 $E^{3S}$
	Release	Sets the release time	1...100 $E^{3S}$
e	Delay Time [msec]	Sets the delay time of the gate input	0...100msec $E^{3S}$
f	Wet/Dry	Dry, 1:99...99:1, Wet	$D^{mod}$
	Src	Selects the modulation source of the effect balance	Off...Tempo
	Amt	Sets the modulation amount of the effect balance	-100...+100

**a: Envelope Select, a: Src**

The "Envelope Select" parameter selects whether the gate on/off is triggered by the level of the input signal, or controlled directly by the modulation source. The Src parameter specifies the modulation source, selected from **Off** to **Gate2+Dmpr**. With "Envelope Select" = **L/R Mix**, the left and right channel signal mixture will trigger the gate on/off. When **L Only** or **R Only** is selected, the gate is controlled by either of the channel signals.

**b: Polarity**

This parameter reverses the Gate on/off operation. With a **negative** value, the gate is closed when the input signal level exceeds the Threshold. The gate operation controlled by the modulation source is also reversed.

**c: Threshold, d: Attack, d: Release**

This parameter sets the signal level below which Gate is applied when "Envelope Select" is set to **L/R Mix, L Only, or R Only**. The Attack and Release parameters set the Gate attack time and release time.

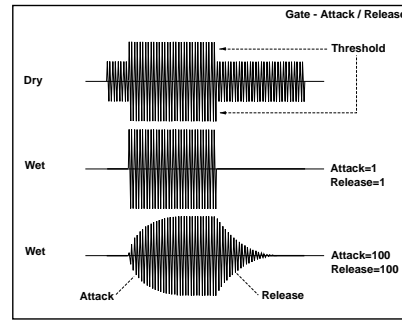
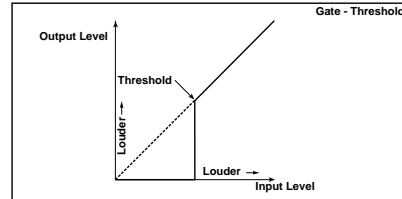

**e: Delay Time**

This parameter sets the delay time of the Gate input. If the sound has a very fast attack, increase the delay time so that the signal will be input after the Gate is opened. This will preserve the attack part of the sound.

## 006: OD/Hi.Gain Wah

(Overdrive/Hi.Gain Wah)

This distortion effect utilizes an Overdrive mode and a Hi-Gain mode. Controlling the wah effect, the 3-band EQ, and the amp simulation will allow you to create versatile distortion sounds. This effect is suitable for guitar and organ sounds.

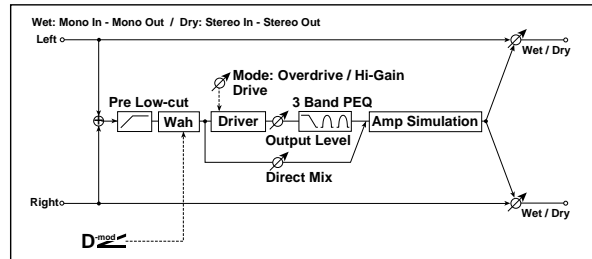

a	Wah	Switches Wah on/off	Off, On $E^{3S}$ , $D^{mod}$
	Src	Selects the modulation source that switches the Wah on and off	Off...Tempo
	Sw	Selects the switching mode for the modulation source that switches the Wah on and off	Toggle, Moment $E^{3S}$
b	Wah Sweep Range	Sets the range of Wah	-10...+10 $E^{3S}$ , $D^{mod}$
	Wah Sweep Src	Selects the modulation source that controls the Wah	Off...Tempo $E^{3S}$
c	Drive Mode	Switches between overdrive and hi-gain distortion	Overdrive, Hi-Gain
d	Drive	Sets the degree of distortion	1...100 $E^{3S}$
	Pre Low-cut	Sets the low range cut amount of the distortion input	0...10 $E^{3S}$



e	Output Level Sets the output level	0...50 E33, D-mod
	Src Selects the modulation source for the output level	Off...Tempo
f	Amt Sets the modulation amount of the output level	-50...+50
	Low Cutoff [Hz] Sets the center frequency for Low EQ (shelving type)	20...1.0kHz
g	Gain [dB] Sets the gain of Low EQ	-18...+18dB
	Mid1 Cutoff [Hz] Sets the center frequency for Mid/High EQ 1 (peaking type)	300...10.0kHz
h	Q Sets the band width of Mid/High EQ 1	0.5...10.0 E33
	Gain [dB] Sets the gain of Mid/High EQ 1	-18...+18dB
i	Mid2 Cutoff [Hz] Sets the center frequency for Mid/High EQ 2 (peaking type)	500...20.0kHz
	Q Sets the band width of Mid/High EQ 2	0.5...10.0 E33
j	Gain [dB] Sets the gain of Mid/High EQ 2	-18...+18dB
	Direct Mix Sets the amount of the dry sound mixed to the distortion	0...50
k	Speaker Simulation Switches the speaker simulation on/off	Off, On
	Wet/Dry Sets the balance between the effect and dry sounds	Dry, 1:99...99:1, Wet D-mod
l	Src Selects the modulation source of the effect balance	Off...Tempo
	Amt Sets the modulation amount of the effect balance	-100...+100

#### a: Wah

The Wah parameter switches the wah effect on/off.

#### a: Sw

This parameter sets how the wah effect is switched on and off via the modulation source.

When "Sw" = **Moment**, the wah effect is usually turned off. It is turned on only when you press the pedal or operate the joystick.

**MIDI** When a value for the modulation source is less than 64, "off" speed is selected, and when the value is 64 or higher, "on" is selected.

When "Sw" = **Toggle**, the wah effect is switched between on and off each time you press the pedal or operate the joystick.

**MIDI** The switch will be turned on/off each time the value of the modulation source exceeds 64.

#### b: Wah Sweep Range, b: Wah Sweep Src

This parameter sets the sweep range of the wah center frequency. A negative value will reverse the direction of sweep. The wah center frequency can be controlled by the modulation source specified in the "Wah Sweep Src" parameter.

#### d: Drive, e: Output Level

The degree of distortion is determined by the level of input signal and the setting of "Drive". Raising the "Drive" setting will cause the entire volume level to increase. Use the "Output Level" parameter to adjust the volume level. The "Output Level" parameter uses the signal level input to the 3-Band EQ. If clipping occurs at the 3-Band EQ, adjust the "Output Level" parameter.

#### d: Pre Low-cut

Cutting the signal in the low range before it is input to the Distortion will create a sharp distortion.

#### g: Q, h: Q

These parameters set the bandwidth of each equalizer. The higher the value, the narrower the band becomes.

## 007: St. Parametric 4EQ

### (Stereo Parametric 4-Band EQ)

This is a stereo 4-band parametric equalizer. You can select peaking type or shelving type for Band 1 and 4. The gain of Band 2 can be controlled by dynamic modulation.

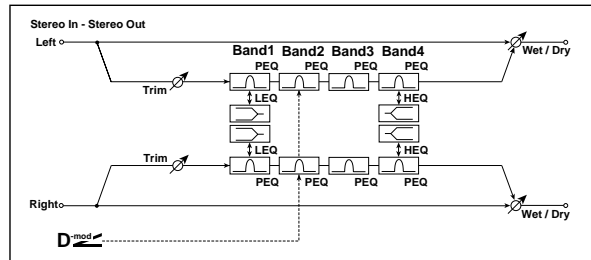

a	Trim Sets the input level	0...100
b	Band1 Type Selects the type of Band 1	Peaking, Shelving-Low E33
c	Band4 Type Selects the type of Band 4	Peaking, Shelving-High E33
d	Band2 Dynamic Gain Src Selects the modulation source of the Band 2 gain	Off...Tempo E33
e	Amt [dB] Sets the modulation amount of Band 2 gain	-18...+18dB E33
	Band1 Cutoff [Hz] Sets the center frequency of Band 1	20...1.00kHz
f	Q Sets the bandwidth of Band 1	0.5...10.0 E33 Fx:006
	Gain [dB] Sets the gain of Band 1	-18.0...+18.0dB E33, D-mod
g	Band2 Cutoff [Hz] Sets the center frequency of Band 2	50...10.00kHz
	Q Sets the bandwidth of Band 2	0.5...10.0 E33 Fx:006
h	Gain [dB] Sets the gain of Band 2	-18.0...+18.0dB E33, D-mod
	Band3 Cutoff [Hz] Sets the center frequency of Band 3	300...10.00kHz
i	Q Sets the bandwidth of Band 3	0.5...10.0 E33 Fx:006
	Gain [dB] Sets the gain of Band 3	-18.0...+18.0dB
j	Band4 Cutoff [Hz] Sets the center frequency of Band 4	500...20.00kHz
	Q Sets the bandwidth of Band 4	0.5...10.0 E33 Fx:006
k	Gain [dB] Sets the gain of Band 4	-18.0...+18.0dB
	Wet/Dry Sets the balance between the effect and dry sounds	Dry, 1:99...99:1, Wet D-mod
l	Src Selects the modulation source of the effect balance	Off...Tempo
	Amt Sets the modulation amount of the effect balance	-100...+100

#### b: Band1 Type, c: Band4 Type

Selects a filter type for Band 1 and 4.

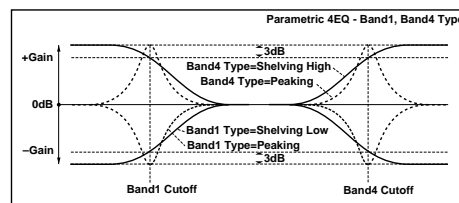

**d: Band2 Dynamic Gain Src, d: Amt [dB], f: Gain [dB]**  
 You can control the gain of Band 2 using the modulation source.

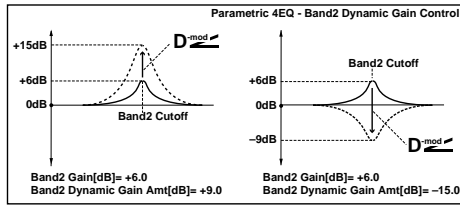

## 008: St. Graphic 7EQ (Stereo Graphic 7 Band EQ)

This is a stereo 7-band graphic equalizer. The bar graph of the gain setting for each band gives you a clear, visual idea of frequency responses. You can select a center frequency setting for each band from twelve types, according to the sound.

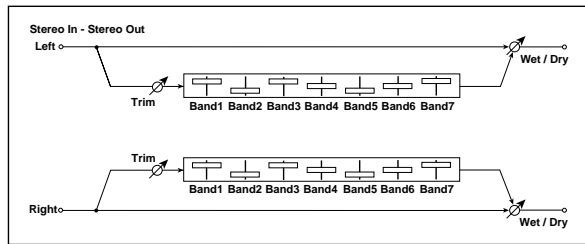

a	Type 1:Wide 1, 2:Wide 2, 3:Wide 3, 4:Half Wide 1, 5:Half Wide 2, 6:Half Wide 3, 7:Low, 8:Wide Low, 9:Mid, 10:Wide Mid, 11:High, 12:Wide High Selects a combination of center frequencies for each band	
b	Trim Sets the input level	0...100
c	Band1 [dB] Sets the gain of Band 1	-18.0...+18.0dB
d	Band2 [dB] Sets the gain of Band 2	-18.0...+18.0dB
e	Band3 [dB] Sets the gain of Band 3	-18.0...+18.0dB
f	Band4 [dB] Sets the gain of Band 4	-18.0...+18.0dB
g	Band5 [dB] Sets the gain of Band 5	-18.0...+18.0dB
h	Band6 [dB] Sets the gain of Band 6	-18.0...+18.0dB
i	Band7 [dB] Sets the gain of Band 7	-18.0...+18.0dB
j	Wet/Dry Sets the balance between the effect and dry sounds	Dry, 1:99...99:1, Wet
	Src Selects the modulation source of the effect balance	Off...Tempo
	Amt Sets the modulation amount of the effect balance	-100...+100

### a: Type

This parameter selects a combination of center frequencies for each band. Each center frequency is shown on the right edge of the LCD.

You can configure a 21-Band Graphic EQ ranging from 80Hz to 18kHz if you route three Graphic 7Band EQ effects in series, with a setting of **7:Low**, **9:Mid**, and **11:High** for each EQ.

## 009: St. Wah/Auto Wah (Stereo Wah/Auto Wah)

This stereo wah effect allows you to create sounds from vintage wah pedal simulation to auto-wah simulation, and much broader range settings.

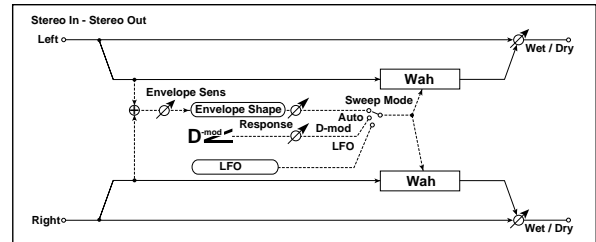

a	Frequency Bottom Sets the lower limit of the wah center frequency	0...100
	Frequency Top Sets the upper limit of the wah center frequency	0...100
b	Sweep Mode Selects the control from auto-wah, modulation source, and LFO	Auto, D-mod, LFO
	Src Selects the modulation source for the wah when Sweep Mode=D-mod	Off...Tempo
	Response Sets the response speed when Sweep Mode = Auto or D-mod	0...100
c	Envelope Sens (Envelope Sensitivity) Sets the sensitivity of auto-wah	0...100
	Envelope Shape Sets the sweep curve of auto-wah	-100...+100
d	LFO Frequency [Hz] Sets the LFO speed	0.02...20.00Hz
	Src Selects the modulation source of LFO speed	Off...Tempo
	Amt Sets the modulation amount of LFO speed	-20.00...+20.00Hz
e	BPM/MIDI Sync Switches between using the frequency of the LFO speed and using the tempo and notes	Off, On
	BPM Selects MIDI Clock and assigns tempo	MIDI, 40...240
	Base Note Selects the type of notes that specify the LFO speed	
	Times Sets the number of notes that specify the LFO speed	x1...x16
f	Resonance Sets the resonance amount	0...100
	Low Pass Filter Switches the Wah Low Pass Filter on and off	Off, On
g	Wet/Dry Sets the balance between the effect and dry sounds	Dry, 1:99...99:1, Wet
	Src Selects the modulation source of the effect balance	Off...Tempo
	Amt Sets the modulation amount of the effect balance	-100...+100

### a: Frequency Bottom, a: Frequency Top

The sweep width and direction of the wah filter are determined by the “Frequency Top” and “Frequency Bottom” settings.

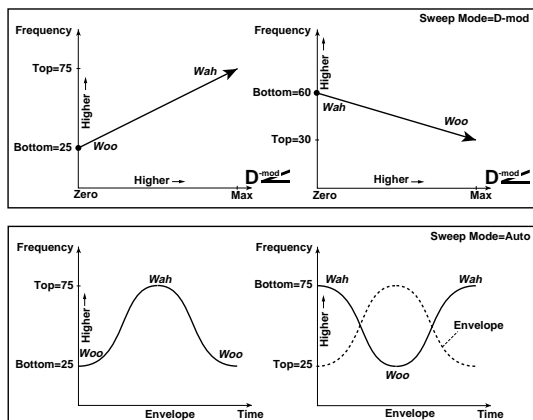

### b: Sweep Mode

This parameter changes the wah control mode. Setting “Sweep Mode” to **Auto** will select an auto-wah that sweeps according to envelope changes in the input signal level. Auto-wah is frequently used for funk guitar parts and clav sounds.

When “Sweep Mode” is set to **D-mod**, you can control the filter directly via the modulation source in the same way as a wah pedal.

When “Sweep Mode” is set to **LFO**, the effect uses LFO to sweep in cycle.

### c: Envelope Sens (Envelope Sensitivity)

This parameter sets the sensitivity of auto-wah. Increase the value if the input signal is too low to sweep. Reduce the value if the input signal is so high that the filter is stopped temporarily.

### c: Envelope Shape

This parameter determines the sweep curve for auto-wah.

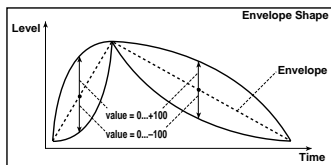

### d: LFO Frequency [Hz], e: BPM/MIDI Sync

When “BPM/MIDI Sync”=**Off**, the LFO speed uses the LFO Frequency parameter setting. When “BPM/MIDI Sync”=**On**, the LFO speed follows the “BPM”, “Base Note”, and “Times” settings.

### e: BPM, e: Base Note, e: Times

One cycle of LFO sweep is obtained by multiplying the length of a note (♩, ♪, ♫) (selected for “Base Note”, in relation to the tempo specified in (“BPM”, or the MIDI Clock tempo if “BPM” is set to **MIDI**) by the number specified in the Times parameter.

## 010: St. Random Filter (Stereo Random Filter)

This stereo band pass filter uses a step-shape waveform and random LFO for modulation. You can create a special effect from filter oscillation.

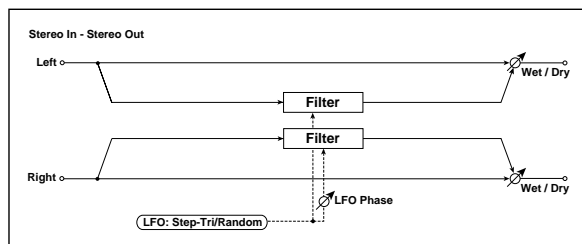

a	LFO Waveform Selects LFO Waveform	Step-Tri, Random ☑
b	LFO Phase [degree] Sets the LFO phase difference between the left and right	-180...+180 ☑
c	LFO Frequency [Hz] Sets the LFO speed	0.02...20.00Hz ☑, D-mod
	Src Selects the modulation source used for both LFO speed and step speed	Off...Tempo
d	Amt Sets the modulation amount of LFO speed	-20.00...+20.00Hz
	LFO Step Freq (Frequency) [Hz] Sets the LFO step speed (speed that changes in steps)	0.05...50.00Hz ☑, D-mod
e	Amt Sets the modulation amount of LFO step speed	-50.00...+50.00Hz
	BPM/MIDI Sync Switches between using the frequency of the LFO speed and using the tempo and notes	Off, On ☑ Fx:009, Sync
f	BPM Selects MIDI Clock and assigns tempo	MIDI, 40...240 ☑ Fx:009, ☑
	Base Note Selects the type of notes that specify the LFO speed	♩, ♪, ♫, ♮, ♯, ♭, ♮, ♯, ♭, ♮ ☑ Fx:009
	Times Sets the number of notes that specify the LFO speed	x1...x16 ☑ Fx:009
g	Step Base Note Selects the type of notes to specify the LFO step speed	♩, ♪, ♫, ♮, ♯, ♭, ♮, ♯, ♭, ♮ ☑, Sync
	Times Sets the number of notes to specify the LFO step speed	x1...x32 ☑
h	Manual Sets the filter center frequency	0...100
i	Depth Sets the modulation depth of filter center frequency	0...100
	Src Selects the modulation source of filter modulation	Off...Tempo
j	Amt Sets the modulation amount of filter modulation	-100...+100
	Resonance Sets the resonance amount	0...100
k	Wet/Dry Sets the balance between the effect and dry sounds	-Wet...-1:99, Dry, 1:99...Wet ☑, D-mod
	Src Selects the modulation source of the effect balance	Off...Tempo
	Amt Sets the modulation amount of the effect balance	-100...+100

### a: LFO Waveform, c: LFO Frequency [Hz],

### d: LFO Step Freq (Frequency) [Hz]

When “LFO Waveform” is set to **Step-Tri**, LFO is a step-shape, triangle waveform. The “LFO Frequency” parameter sets the original triangle waveform speed. Changing the “LFO Step Freq” parameter enables you to adjust the width of the steps.

When "LFO Waveform" is set to **Random**, the "LFO Step Freq" parameter uses a random LFO cycle.

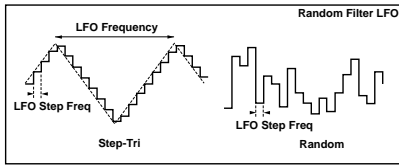

**b: LFO Phase [degree]**

Offsetting the left and right phases alters how modulation is applied to the left and right channels, creating a swelling affect.

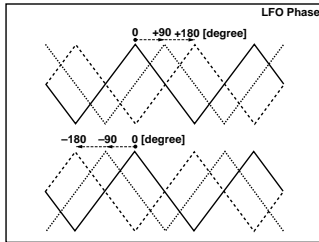

**e: BPM, f: Step Base Note, f: Times**

The width of an LFO step, or a cycle of random LFO, is obtained by multiplying the length of a note (1/n) (selected for "Step Base Note", in relation to the tempo specified in "BPM," or the MIDI Clock tempo if "BPM" is set to MIDI) by the number specified in the "Times" parameter.

**j: Wet/Dry**

The effect sound's phase will be reversed when you set this parameter in the range of values from **-Wet to -1:99**.

**011: St. Exciter/Enhncr**  
(Stereo Exciter/Enhancer)

This effect is a combination of the Exciter, which adds a punch to the sound and the Enhancer, which adds spread and presence.

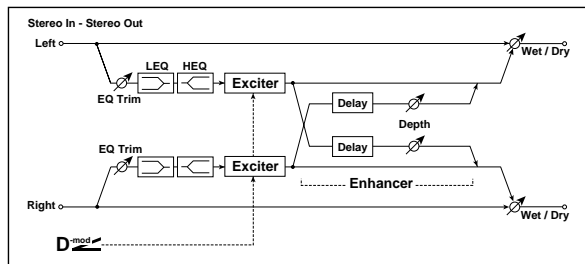

a	Exciter Blend	-100...+100
	Src	Off...Tempo
	Amt	-100...+100
b	Emphatic Point	0...70
	Src	Off...Tempo
	Amt	-70...+70
c	Enhancer Dly L (Enhancer Delay L) [msec]	0.0...50.0msec
d	Enhancer Dly R (Enhancer Delay R) [msec]	0.0...50.0msec

e	Enhancer Depth	0...100
	Src	Off...Tempo
	Amt	-100...+100
f	EQ Trim	0...100
g	Pre LEQ Gain [dB]	-15.0...+15.0dB
	Pre HEQ Gain [dB]	-15.0...+15.0dB
h	Wet/Dry	Dry, 1:99...99:1, Wet
	Src	Off...Tempo
	Amt	-100...+100

**a: Exciter Blend**

This parameter sets the depth (intensity) of the Exciter effect. Positive values give a frequency pattern (to be emphasized) different from negative values.

**b: Emphatic Point**

This parameter sets the frequency to be emphasized. Higher values will emphasize lower frequencies.

**c: Enhancer Dly L [msec], d: Enhancer Dly R [msec]**

These parameters set the delay time for the Enhancer left and right channel. Specifying a slightly different delay time for the left and right channel will add a stereo image, depth, and width to the sound.

**012: St. Sub Oscillator**  
(Stereo Sub Oscillator)

This effect adds very low frequencies to the input signal. It is very useful when simulating a roaring drum sound or emphasizing powerful low range. This effect is different from the equalizer in that you can add very low range harmonics. You can also adjust the oscillator frequency to match a particular note number, for use as an octaver.

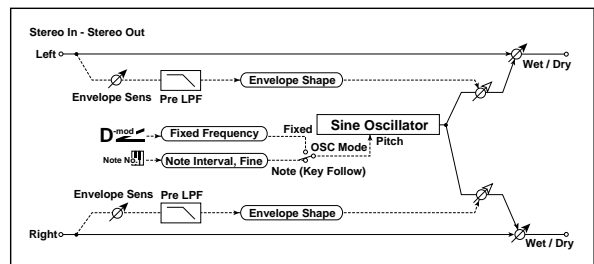

a	OSC Mode	Note (Key Follow), Fixed
b	Note Interval	-48...0
	Note Fine	-100...+100
	OSC Mode	Note (Key Follow), Fixed

c	Fixed Frequency [Hz] Sets the oscillator frequency when OSC Mode=Fixed	10.0...80.0Hz D-mod
	Src Selects the modulation source for the oscillator frequency when OSC Mode=Fixed	Off...Tempo
	Amt Sets the oscillator frequency modulation amount when OSC Mode=Fixed	-80...+80Hz
d	Envelope Pre LPF Sets the upper limit of the frequency range for which very low harmonics are added	1...100 E3
e	Envelope Sens (Envelope Sensitivity) Sets the sensitivity with which very low harmonics are added	0...100
	Envelope Shape Sets the oscillator's volume envelope curve	-100...+100
f	Wet/Dry Sets the balance between the effect and dry sounds	Dry, 1:99...99:1, Wet D-mod
	Src Selects the modulation source of the effect balance	Off...Tempo
	Amt Sets the modulation amount of the effect balance	-100...+100

**a: OSC Mode, b: Note Interval, b: Note Fine**

The "OSC Mode" parameter selects the oscillator operation mode. When **Note (Key Follow)** is selected, the oscillator's frequency is determined based on the note number, allowing you to use it as an octaver. The "Note Interval" parameter sets the pitch offset from the original note number by semitone steps. The "Note Fine" parameter allows you to fine-tune in steps of cents.

**d: Envelope Pre LPF**

This parameter sets the upper limit of the frequency range to which very low harmonics are added. Adjust this parameter if you do not want to add lower harmonics to the higher range.

## 013: Talking Modulator

This effect adds an unusual character, like a human voice, to the input signal. Modulating the tone via dynamic modulation, you can create an interesting effect that sounds as if the guitar or synthesizer is talking.

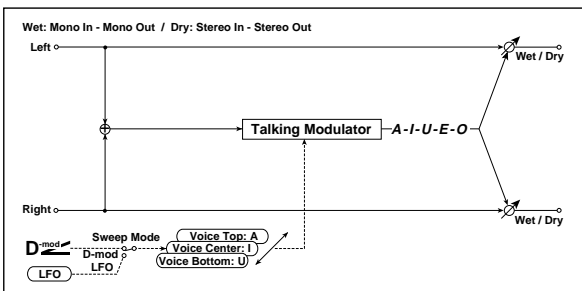

a	Sweep Mode Switches between modulation source control and LFO control	D-mod, LFO D-mod
b	Manual Voice Control Voice pattern control	Bottom, 1...49, Center, 51...99, Top
	Src Selects the modulation source that controls the voice pattern	Off...Tempo
c	Voice Top Selects a vowel sound at the top end of control	A, I, U, E, O E3
d	Voice Center Selects a vowel sound in the center of control	A, I, U, E, O E3
e	Voice Bottom Selects a vowel sound at the bottom end of control	A, I, U, E, O E3

f	LFO Frequency [Hz] Sets the LFO speed	0.02...20.00Hz E3 Fx:009, D-mod
	Src Selects the modulation source of LFO speed	Off...Tempo
g	Amt Sets the modulation amount of LFO speed	-20.00...+20.00Hz
	BPM/MIDI Sync Switches between using the frequency of the LFO speed and using the tempo and notes	Off, On E3 Fx:009, S9
	BPM Selects MIDI Clock and assigns tempo	MIDI, 40...240 E3 Fx:009
h	Base Note Selects the type of notes that specify the LFO speed	E3 Fx:009
	Times Sets the number of notes that specify the LFO speed	x1...x16 E3 Fx:009
i	Formant Shift Sets the frequency to which the effect is applied	-100...+100 E3
	Resonance Sets the Level of resonance of the voice pattern	0...100 E3
j	Wet/Dry Sets the balance between the effect and dry sounds	Dry, 1:99...99:1, Wet D-mod
	Src Selects the modulation source of the effect balance	Off...Tempo
	Amt Sets the modulation amount of the effect balance	-100...+100

**c: Voice Top, d: Voice Center, e: Voice Bottom**

These parameters assign vowels to the top, center, and bottom position of the controller.

E.g.: When "Voice Top"=A, "Voice Center"=I, and "Voice Bottom"=U:

If "Sweep Mode" is set to **D-mod** and **Ribbon** is selected as the modulation source, moving your finger from the right to left of the ribbon controller will change the sound from "a" to "i," then "u."

If Sweep Mode is set to **LFO**, the sound will change cyclically from "a" to "i," "u," "i," then "a."

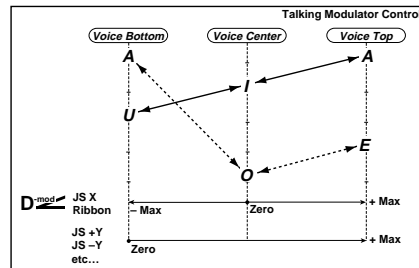

**h: Formant Shift**

This parameter adjusts the frequency level to which the effect is applied. If you wish to apply the effect to a higher-range sound, set this parameter to a higher value; to apply the effect to a lower-range sound, set this to a lower value.

**h: Resonance**

This parameter sets the intensity of resonance for the voice pattern. A larger value will add more character to the sound.

## 014: Stereo Decimator

This effect creates a rough sound like a cheap sampler by lowering the sampling frequency and data bit length. You can also simulate noise unique to a sampler (aliasing).

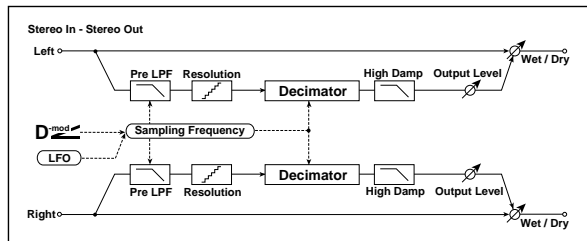

a	Pre LPF	Off, On	Selects whether the harmonic noise caused by a decrease in sampling frequency is generated or not
	High Damp [%]	0...100%	Sets the ratio of cut of the high range
b	Sampling Freq (Sampling Frequency) [Hz]	1.00k...48.00kHz	Sets the sampling frequency
	Src	Off...Tempo	Selects the modulation source of the sampling frequency
	Amt	-48.00k...+48.00kHz	Sets the modulation amount of the sampling frequency
c	LFO Frequency [Hz]	0.02...20.00Hz	Sets the LFO speed
	Src	Off...Tempo	Selects the modulation source of LFO speed
	Amt	-20.00...+20.00Hz	Sets the modulation amount of LFO speed
d	Depth	0...100	Sets the depth of the sampling frequency LFO modulation
	Src	Off...Tempo	Selects the LFO modulation source of the sampling frequency
	Amt	-100...+100	Sets the LFO modulation amount of the sampling frequency
e	Resolution	4...24	Sets the data bit length
f	Output Level	0...100	Sets the output level
	Src	Off...Tempo	Selects the modulation source for the output level
	Amt	-100...+100	Sets the modulation amount of the output level
g	Wet/Dry	Dry, 1:99...99:1, Wet	Sets the balance between the effect and dry sounds
	Src	Off...Tempo	Selects the modulation source of the effect balance
	Amt	-100...+100	Sets the modulation amount of the effect balance

### a: Pre LPF

If a sampler with a very low sampling frequency receives very high-pitched sound that could not be heard during playback, it could generate pitch noise that is unrelated to the original sound. Set "Pre LPF" to ON to prevent this noise from being generated. If you set the "Sampling Freq" to about 3kHz and set "Pre LPF" to OFF, you can create a sound like a ring modulator.

### e: Resolution, f: Output Level

If you set a smaller value for the "Resolution" parameter, the sound may be distorted. The volume level may also be changed. Use "Output Level" to adjust the level.

## 015: St. Analog Record

### (Stereo Analog Record)

This effect simulates the noise caused by scratches and dust on analog records. It also reproduces some of the modulation caused by a warped turntable.

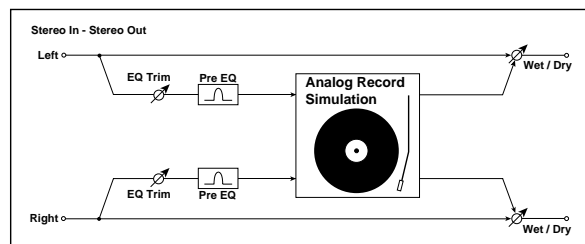

a	Speed [RPM]	33 1/3, 45, 78	Sets the r.p.m. of a record
b	Flutter	0...100	Sets the modulation depth
c	Noise Density	0...100	Sets the noise density
	Noise Tone	0...100	Sets the noise tone
d	Noise Level	0...100	Sets the noise level
	Src	Off...Tempo	Selects the modulation source for the noise level
	Amt	-100...+100	Sets the modulation amount of the noise level
e	Click Level	0...100	Sets the click noise level
	Src	Off...Tempo	Selects the modulation source for the click noise level
	Amt	-100...+100	Sets the modulation amount of the click noise level
f	EQ Trim	0...100	Sets the EQ input level
g	Pre EQ Cutoff [Hz]	300...10.00kHz	Sets the EQ center frequency
	Q	0.5...10.0	Sets the EQ band width
	Gain [dB]	-18.0...+18.0dB	Sets the EQ gain
h	Wet/Dry	Dry, 1:99...99:1, Wet	Sets the balance between the effect and dry sounds
	Src	Off...Tempo	Selects the modulation source of the effect balance
	Amt	-100...+100	Sets the modulation amount of the effect balance

### b: Flutter

This parameter enables you to set the depth of the modulation caused by a warped turntable.

### e: Click Level

This parameter enables you to set the level of the click noise that occurs once every rotation of the turntable. This simulation reproduces record noise, and the noise generated after the music on a vinyl record finishes.

# Pitch/Phase Mod.

## Pitch/phase modulation effects

### 016: Stereo Chorus

This effect adds thickness and warmth to the sound by modulating the delay time of the input signal. You can add spread to the sound by offsetting the phase of the left and right LFOs from each other.

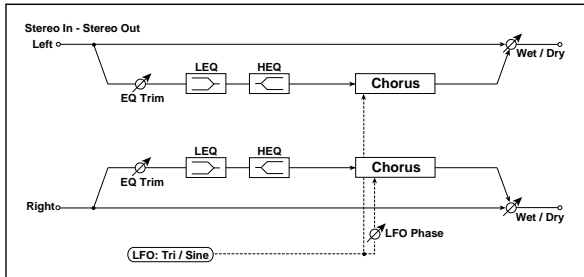

a	LFO Waveform Selects LFO Waveform	Triangle, Sine
b	LFO Phase [degree] Sets the LFO phase difference between the left and right	-180...+180 Fx:010
c	LFO Frequency [Hz] Sets the LFO speed	0.02...20.00Hz Fx:009, D-mod
	Src Selects the modulation source of LFO speed	Off...Tempo
	Amt Sets the modulation amount of LFO speed	-20.00...+20.00Hz
d	BPM/MIDI Sync Switches between using the frequency of the LFO speed and using the tempo and notes	Off, On Fx:009, Sync
	BPM Selects MIDI Clock and assigns tempo	MIDI, 40...240 Fx:009
	Base Note Selects the type of notes that specify the LFO speed	Fx:009
	Times Sets the number of notes that specify the LFO speed	x1...x16 Fx:009
e	L Pre Delay [msec] Sets the delay time for the left channel	0.0...50.0msec Fx
f	R Pre Delay [msec] Sets the delay time for the right channel	0.0...50.0msec Fx
g	Depth Sets the depth of LFO modulation	0...100 D-mod
	Src Selects the modulation source of the LFO modulation depth	Off...Tempo
	Amt Sets the modulation amount of the LFO modulation depth	-100...+100
h	EQ Trim Sets the EQ input level	0...100
i	Pre LEQ Gain [dB] Sets the gain of Low EQ	-15.0...+15.0dB
	Pre HEQ Gain [dB] Sets the gain of High EQ	-15.0...+15.0dB
j	Wet/Dry Sets the balance between the effect and dry sounds	-Wet...-1:99, Dry, 1:99...Wet Fx:010, D-mod
	Src Selects the modulation source of the effect balance	Off...Tempo
	Amt Sets the modulation amount of the effect balance	-100...+100

e: L Pre Delay [msec], f: R Pre Delay [msec]

Setting the left and right delay time individually allows you to control the stereo image.

### 017: St. Harmonic Chorus (Stereo Harmonic Chorus)

This effect applies chorus only to higher frequencies. This can be used to apply a chorus effect to a bass sound without making the sound thinner. You can also use this chorus block with feedback as a flanger.

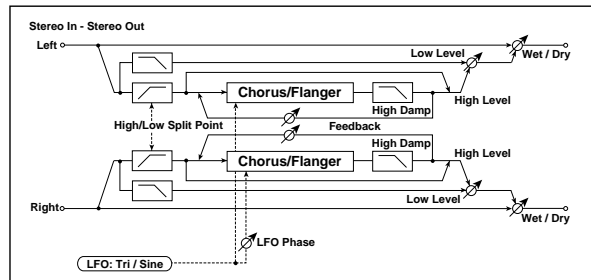

a	LFO Waveform Selects LFO Waveform	Triangle, Sine
b	LFO Phase [degree] Sets the LFO phase difference between the left and right	-180...+180 Fx:010
c	LFO Frequency [Hz] Sets the LFO speed	0.02...20.00Hz Fx:009, D-mod
	Src Selects the modulation source of LFO speed	Off...Tempo
	Amt Sets the modulation amount of LFO speed	-20.00...+20.00Hz
d	BPM/MIDI Sync Switches between using the frequency of the LFO speed and using the tempo and notes	Off, On Fx:009, Sync
	BPM Selects MIDI Clock and assigns tempo	MIDI, 40...240 Fx:009
	Base Note Selects the type of notes that specify the LFO speed	Fx:009
	Times Sets the number of notes that specify the LFO speed	x1...x16 Fx:009
e	Pre Delay [msec] Sets the delay time from the original sound	0.0...50.0msec
f	Depth Sets the depth of LFO modulation	0...100 D-mod
	Src Selects the modulation source of the LFO modulation depth	Off...Tempo
	Amt Sets the modulation amount of the LFO modulation depth	-100...+100
g	High/Low Split Point Sets the frequency split point between the low and high range	1...100 Fx
h	Feedback Sets the feed back amount of the chorus block	-100...+100 Fx
	High Damp [%] Sets the high range damping amount of the chorus block	0...100%
i	Low Level Sets the low range output level	0...100
	High Level Sets the high range (chorus) output level	0...100
j	Wet/Dry Sets the balance between the effect and dry sounds	Dry, 1:99...99:1, Wet D-mod
	Src Selects the modulation source of the effect balance	Off...Tempo
	Amt Sets the modulation amount of the effect balance	-100...+100

**g: High/Low Split Point**

This parameter sets the frequency that splits the high and low range. Only the high range will be sent to the chorus block.

**h: Feedback**

Sets the feedback amount of the chorus block. Increasing the feedback will allow you to use the effect as a flanger.

**018: Multitap Cho/Delay**  
(Multitap Chorus/Delay)

This effect has four chorus blocks with a different LFO phase. You can create a complex stereo image by setting each block's delay time, depth, output level, and pan individually. You can also fix some of the chorus blocks to combine the chorus and delay effects.

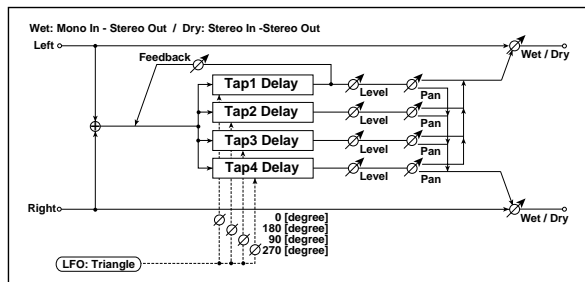

a	LFO Frequency [Hz] Sets the LFO speed	0.02...13.00Hz
	Tap1(000) [msec] Sets the Tap1 (LFO phase=0 degrees) delay time	0...570msec
b	Depth Sets the Tap1 chorus depth	0...30
	Level Sets the Tap1 output level	0...30
	Pan Sets the Tap1 stereo image	L6...L1, C, R1...R6
c	Tap2(180) [msec] Sets the Tap2 (LFO phase=180 degrees) delay time	0...570msec
	Depth Sets the Tap2 chorus depth	0...30
	Level Sets the Tap2 output level	0...30
	Pan Sets the Tap2 stereo image	L6...L1, C, R1...R6
d	Tap3(090) [msec] Sets the Tap3 (LFO phase=90 degrees) delay time	0...570msec
	Depth Sets the Tap3 chorus depth	0...30
	Level Sets the Tap3 output level	0...30
	Pan Sets the Tap3 stereo image	L6...L1, C, R1...R6
e	Tap4(270) [msec] Sets the Tap4 (LFO phase=270 degrees) delay time	0...570msec
	Depth Sets the Tap4 chorus depth	0...30
	Level Sets the Tap4 output level	0...30
	Pan Sets the Tap4 stereo image	L6...L1, C, R1...R6
f	Tap1 Feedback Sets the Tap1 feedback amount	-100...+100 D <sup>mod</sup>
	Src Selects the modulation source of Tap1 feedback amount and effect balance	Off...Tempo
	Amt Sets the Tap1 feedback amount and modulation amount	-100...+100

g	Wet/Dry Sets the balance between the effect and dry sounds	Dry, 1:99...99:1, Wet D <sup>mod</sup>
	Amt Sets the modulation amount of the effect balance	-100...+100

**019: Ensemble**

This Ensemble effect has three chorus blocks that use LFO to create subtle shimmering, and gives three dimensional depth and spread to the sound, because the signal is output from the left, right, and center.

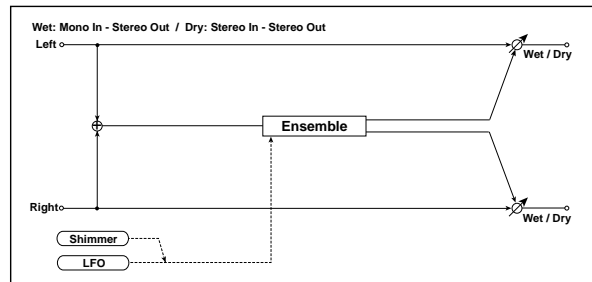

a	Speed Sets the LFO speed	1...100 D <sup>mod</sup>
	Src Selects the modulation source of LFO speed	Off...Tempo
b	Amt Sets the modulation amount of LFO speed	-100...+100
	Depth Sets the depth of LFO modulation	0...100 D <sup>mod</sup>
c	Src Selects the modulation source of the LFO modulation depth	Off...Tempo
	Amt Sets the modulation amount of the LFO modulation depth	-100...+100
d	Shimmer Sets the amount of shimmering of the LFO waveform	0...100
d	Wet/Dry Sets the balance between the effect and dry sounds	Dry, 1:99...99:1, Wet D <sup>mod</sup>
	Src Selects the modulation source of the effect balance	Off...Tempo
	Amt Sets the modulation amount of the effect balance	-100...+100

**c: Shimmer**

This parameter sets the amount of shimmering of the LFO waveform. Increasing this value adds more shimmering, making the chorus effect more complex and richer.

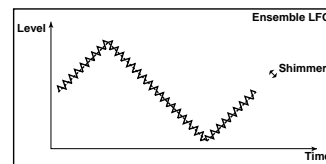



## 020: Stereo Flanger

This effect gives a significant swell and movement of pitch to the sound. It is more effective when applied to a sound with a lot of harmonics. This is a stereo flanger. You can add spread to the sound by offsetting the phase of the left and right LFOs from each other.

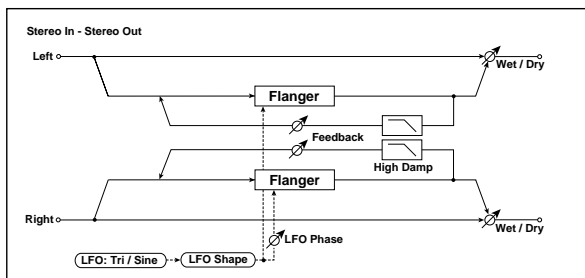

a	Delay Time [msec] Sets the delay time from the original sound	0.0...50.0msec
b	LFO Waveform Selects LFO Waveform	Triangle, Sine
	LFO Shape Determines how much the LFO waveform is changed	-100...+100
c	LFO Phase [degree] Sets the LFO phase difference between the left and right	-180...+180 Fx:010
d	LFO Frequency [Hz] Sets the LFO speed	0.02...20.00Hz Fx:009, D-mod
	Src Selects the modulation source of LFO speed	Off...Tempo
	Amt Sets the modulation amount of LFO speed	-20.00...+20.00Hz
e	BPM/MIDI Sync Switches between using the frequency of the LFO speed and using the tempo and notes	Off, On Fx:009, Sync
	BPM Selects MIDI Clock and assigns tempo	MIDI, 40...240 Fx:009
	Base Note Selects the type of notes that specify the LFO speed	MIDI, 40...240 Fx:009
	Times Sets the number of notes that specify the LFO speed	x1...x16 Fx:009
f	Depth Sets the depth of LFO modulation	0...100
g	Feedback Sets the feedback amount	-100...+100 Fx:
	High Damp [%] Sets the feedback damping amount in the high range	0...100% Fx:
h	Wet/Dry Sets the balance between the effect and dry sounds	-Wet...-1:99, Dry, 1:99...Wet Fx:010, D-mod
	Src Selects the modulation source of the effect balance	Off...Tempo
	Amt Sets the modulation amount of the effect balance	-100...+100

### b: LFO Shape

Changing the LFO waveform shape controls the peak sweep of flanging effects.

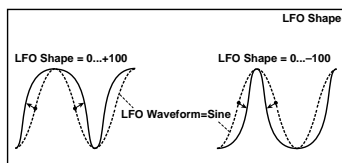

### g: Feedback, h: Wet/Dry

The peak shape of the positive and negative "Feedback" value is different. The harmonics will be emphasized when the effect sound is mixed with the dry sound if you set a positive value for both "Feedback" and "Wet/Dry", and if you set a negative value for both "Feedback" and "Wet/Dry".

### g: High Damp [%]

This parameter sets the amount of damping of the feedback in the high range. Increasing the value will cut high-range harmonics.

## 021: St. Random Flanger (Stereo Random Flanger)

The stereo effect uses a step-shape waveform and random LFO for modulation, creating a unique flanging effect.

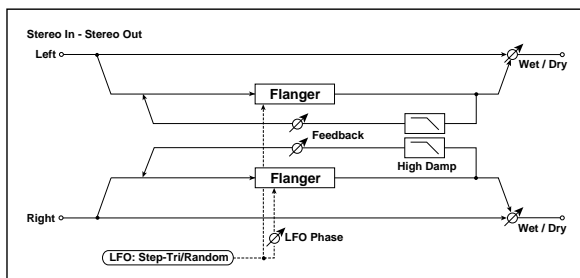

a	Delay Time [msec] Sets the delay time from the original sound	0.0...50.0msec
b	LFO Waveform Selects LFO Waveform	Step-Tri, Random Fx:010
c	LFO Phase [degree] Sets the LFO phase difference between the left and right	-180...+180 Fx:010
d	LFO Frequency [Hz] Sets the LFO speed	0.02...20.00Hz Fx:010, D-mod
	Src Selects the modulation source used for both LFO speed and step speed	Off...Tempo
	Amt Sets the modulation amount of LFO speed	-20.00...+20.00Hz
e	LFO Step Freq (Frequency) [Hz] Sets the LFO step speed (speed that changes in steps)	0.05...50.00Hz Fx:010, D-mod
	Amt Sets the modulation amount of LFO step speed	-50.00...+50.00Hz
	BPM/MIDI Sync Switches between using the frequency of the LFO speed and using the tempo and notes	Off, On Fx:009, Sync
f	BPM Selects MIDI Clock and assigns tempo	MIDI, 40...240 Fx:009, 010
	Base Note Selects the type of notes that specify the LFO speed	MIDI, 40...240 Fx:009
	Times Sets the number of notes that specify the LFO speed	x1...x16 Fx:009
g	Step Base Note Selects the type of notes to specify the LFO step speed	MIDI, 40...240 Fx:010, Sync
	Times Sets the number of notes to specify the LFO step speed	x1...x32 Fx:010
h	Depth Sets the depth of LFO modulation	0...100
i	Feedback Sets the feedback amount	-100...+100 Fx:020
	High Damp [%] Sets the feedback damping amount in the high range	0...100% Fx:020
j	Wet/Dry Sets the balance between the effect and dry sounds	-Wet...-1:99, Dry, 1:99...Wet Fx:010, 020, D-mod
	Src Selects the modulation source of the effect balance	Off...Tempo
	Amt Sets the modulation amount of the effect balance	-100...+100

## 022: St. Env. Flanger (Stereo Envelope Flanger)

This Flanger uses an envelope generator for modulation. You will obtain the same pattern of flanging each time you play. You can also control the Flanger directly using the modulation source.

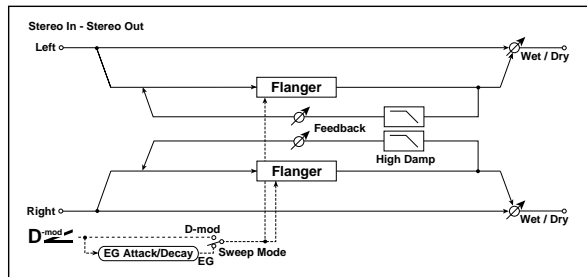

a	L Dly Bottom [msec] (L Delay Bottom) Sets the lower limit of the delay time on the left channel	0.0...50.0msec F <sup>3</sup> Fx:009
	L Dly Top [msec] (L Delay Top) Sets the upper limit of the delay time on the left channel	0.0...50.0msec F <sup>3</sup> Fx:009
b	R Dly Bottom [msec] (R Delay Bottom) Sets the lower limit of the delay time on the right channel	0.0...50.0msec F <sup>3</sup> Fx:009
	R Dly Top [msec] (R Delay Top) Sets the upper limit of the delay time on the right channel	0.0...50.0msec F <sup>3</sup> Fx:009
c	Sweep Mode Determines whether the flanger is controlled by the envelope generator or by the modulation source	EG, D-mod F <sup>3</sup> , D <sup>mod</sup>
	Src Selects the modulation source that triggers the EG (when EG is selected for Sweep Mode), or modulation source that causes the flanger to sweep (when D-mod is selected for Sweep Mode)	Off...Tempo F <sup>3</sup>
d	EG Attack Sets the EG attack speed	1...100 F <sup>3</sup>
	EG Decay Sets the EG decay speed	1...100 F <sup>3</sup>
e	Feedback Sets the feedback amount	-100...+100 F <sup>3</sup> Fx:020
f	High Damp [%] Sets the feedback damping amount in the high range	0...100% F <sup>3</sup> Fx:020
g	Wet/Dry Sets the balance between the effect and dry sounds	-Wet...-1:99, Dry, 1:99...Wet F <sup>3</sup> 010, 020, D <sup>mod</sup>
	Src Selects the modulation source of the effect balance	Off...Tempo
	Amt Sets the modulation amount of the effect balance	-100...+100

### c: Sweep Mode, c: Src

This parameter switches the flanger control mode. With "Sweep Mode" = EG, the flanger will sweep using the envelope generator. This envelope generator is included in the envelope flanger, and not related to the Pitch EG, Filter EG, or Amp EG.

The "Src" parameter selects the source that starts the envelope generator. If you select, for example, **Gate**, the envelope generator will start when the note-on message is received.

When "Sweep Mode" = **D-mod**, the modulation source can control the flanger directly. Select the modulation source using the "Src" parameter.

**MIDI** The effect is off when a value for the modulation source specified for the "Src" parameter is smaller than 64, and the effect is on when the value is 64 or higher. The Envelope Generator is triggered when the value changes from 63 or smaller to 64 or higher.

### d: EG Attack, d: EG Decay

Attack and Decay speed are the only adjustable parameters on this EG.

## 023: Stereo Phaser

This effect creates a swell by shifting the phase. It is very effective on electric piano sounds. You can add spread to the sound by offsetting the phase of the left and right LFOs from each other.

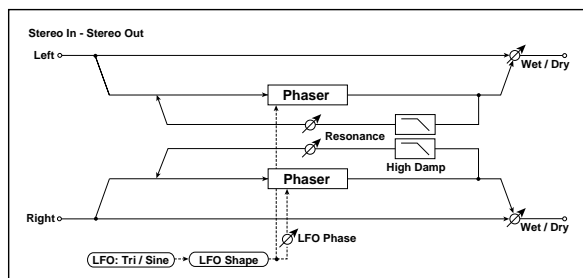

a	LFO Waveform Selects LFO Waveform	Triangle, Sine
	LFO Shape Determines how much the LFO waveform is changed	-100...+100 F <sup>3</sup> Fx:020
b	LFO Phase [degree] Sets the LFO phase difference between the left and right	-180...+180 F <sup>3</sup> Fx:010
	LFO Frequency [Hz] Sets the LFO speed	0.02...20.00Hz F <sup>3</sup> Fx:009, D <sup>mod</sup>
c	Src Selects the modulation source of LFO speed	Off...Tempo
	Amt Sets the modulation amount of LFO speed	-20.00...+20.00Hz
d	BPM/MIDI Sync Switches between using the frequency of the LFO speed and using the tempo and notes	Off, On F <sup>3</sup> Fx:009, S <sup>ync</sup>
	BPM Selects MIDI Clock and assigns tempo	MIDI, 40...240 F <sup>3</sup> Fx:009
	Base Note Selects the type of notes that specify the LFO speed	 F <sup>3</sup> Fx:009
	Times Sets the number of notes that specify the LFO speed	x1...x16 F <sup>3</sup> Fx:009
e	Manual Sets the frequency to which the effect is applied	0...100
f	Depth Sets the depth of LFO modulation	0...100 D <sup>mod</sup>
	Src Selects the modulation source for the LFO modulation depth	Off...Tempo
	Amt Sets the modulation amount of the LFO modulation depth	-100...+100
g	Resonance Sets the resonance amount	-100...+100 F <sup>3</sup>
	High Damp [%] Sets the resonance damping amount in the high range	0...100% F <sup>3</sup>
h	Wet/Dry Sets the balance between the effect and dry sounds	-Wet...-1:99, Dry, 1:99...Wet F <sup>3</sup> Fx:010, D <sup>mod</sup>
	Src Selects the modulation source of the effect balance	Off...Tempo
	Amt Sets the modulation amount of the effect balance	-100...+100

### g: Resonance, h: Wet/Dry

The peak shape of the positive and negative Feedback value is different. The harmonics will be emphasized when the effect sound is mixed with the dry sound, if you set a positive value for both "Resonance" and "Wet/Dry", and if you set a negative value for both "Resonance" and "Wet/Dry".

### g: High Damp [%]

This parameter sets the amount of damping of the resonance in the high range. Increasing the value will cut high-range harmonics.

## 024: St. Random Phaser (Stereo Random Phaser)

This is a stereo phaser. The effect uses a step-shape waveform and random LFO for modulation, creating a unique phasing effect.

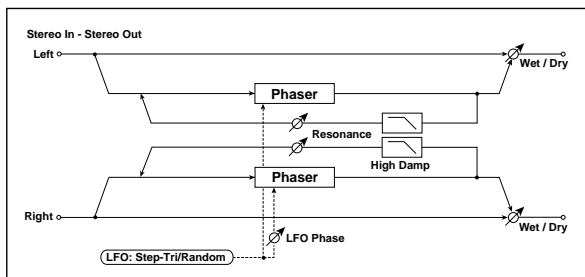

a	LFO Waveform Selects LFO Waveform	Step-Tri, Step-Sin, Random Fx:010
b	LFO Phase [degree] Sets the LFO phase difference between the left and right	-180...+180 Fx:010
c	LFO Frequency [Hz] Sets the LFO speed	0.02...20.00Hz Fx:010, D-mod
	Src Selects the modulation source commonly used for LFO speed and step speed	Off...Tempo
	Amt Sets the modulation amount of LFO speed	-20.00...+20.00Hz
d	LFO Step Freq (Frequency) [Hz] Sets the LFO step speed	0.05...50.00Hz Fx:010, D-mod
	Amt Sets the modulation amount of LFO step speed	-50.00...+50.00Hz
e	BPM/MIDI Sync Switches between using the frequency of the LFO speed and using the tempo and notes	Off, On Fx:009, Sync
	BPM Selects MIDI Clock and assigns tempo	MIDI, 40...240 Fx:009, 010
	Base Note Selects the type of notes that specify the LFO speed	 Fx:009
	Times Sets the number of notes that specify the LFO speed	x1...x16 Fx:009
f	Step Base Note Selects the type of notes to specify the LFO step speed	 Fx:010, Sync
	Times Sets the number of notes to specify the LFO step speed	x1...x32 Fx:010
g	Manual Sets the frequency to which the effect is applied	0...100
h	Depth Sets the depth of LFO modulation	0...100
i	Resonance Sets the resonance amount	-100...+100 Fx:023
	High Damp [%] Sets the resonance damping amount in the high range	0...100% Fx:023
j	Wet/Dry Sets the balance between the effect and dry sounds	-Wet...-1:99, Dry, 1:99...Wet Fx:010, 023, D-mod
	Src Selects the modulation source of the effect balance	Off...Tempo
	Amt Sets the modulation amount of the effect balance	-100...+100

## 025: St. Env. Phaser (Stereo Envelope Phaser)

This stereo phaser uses an envelope generator for modulation. You will obtain the same pattern of phasing each time you play. You can also control the Phaser directly using the modulation source.

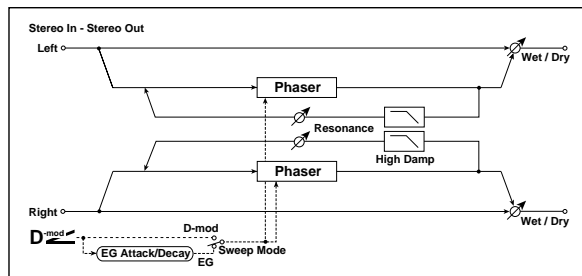

a	L Manu Bottom (L Manual Bottom) Sets the lower limit of the frequency range for the effect on the left channel	0...100 Fx:009
	L Manu Top (L Manual Top) Sets the upper limit of the frequency range for the effect on the left channel	0...100 Fx:009
b	R Manu Bottom (R Manual Bottom) Sets the lower limit of the frequency range for the effect on the right channel	0...100 Fx:009
	R Manu Top (R Manual Top) Sets the upper limit of the frequency range for the effect on the right channel	0...100 Fx:009
c	Sweep Mode Determines whether the flanger is controlled by the envelope generator or by the modulation source	EG, D-mod Fx:022, D-mod
	Src Selects the modulation source that triggers the EG (when EG is selected for Sweep Mode), or modulation source that causes the flanger to sweep (when D-mod is selected for Sweep Mode)	Off...Tempo
d	EG Attack Sets the EG attack speed	1...100 Fx:022
	EG Decay Sets the EG decay speed	1...100 Fx:022
e	Resonance Sets the resonance amount	-100...+100 Fx:023
f	High Damp [%] Sets the resonance damping amount in the high range	0...100% Fx:023
g	Wet/Dry Sets the balance between the effect and dry sounds	-Wet...-1:99, Dry, 1:99...Wet Fx:010, 023, D-mod
	Src Selects the modulation source of the effect balance	Off...Tempo
	Amt Sets the modulation amount of the effect balance	-100...+100



“AUTOFADE Src”=Gate1, “LFO Frequency [Hz]”=1.0  
 “LFO Frequency Mod”=AUTOFADE, “Amt”=3.0

**[MIDI]** The effect is off when a value for the dynamic modulation source specified for the “AUTOFADE Src” parameter is smaller than 64, and the effect is on when the value is 64 or higher. The AutoFade function is triggered when the value changes from 63 or smaller to 64 or higher.

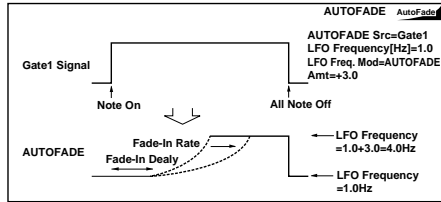

## 028: St. Auto Fade Mod.

(Stereo Auto Fade Modulation)

This stereo chorus/flanger effect enables you to control the LFO speed and effect balance using auto fade, and you can spread the sound by offsetting the phase of the left and right LFOs from each other.

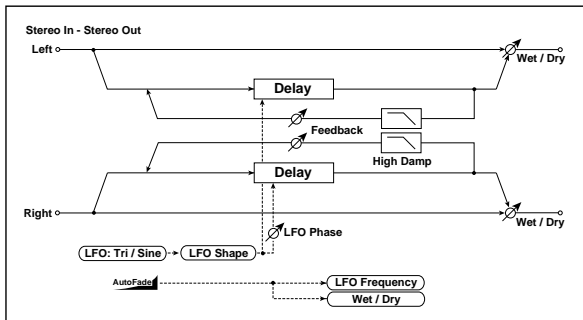

a	AUTOFADE Src	Off...Tempo
	Selects the modulation source that starts AutoFade	
	Rate	1...100
b	Fade-In Dly (Fade-In Delay) [msec]	00...2000msec
	Sets the fade-in delay time	
c	LFO Waveform	Triangle, Sine
	Selects LFO Waveform	
d	LFO Shape	-100...+100
	Determines how much the LFO waveform is changed	
e	LFO Phase [degree]	-180...+180
	Sets the LFO phase difference between the left and right	
f	LFO Frequency Mod	D-mod, AUTOFADE
	Switches between D-mod and AUTOFADE for the LFO frequency modulation	
g	LFO Frequency [Hz]	0.02...20.00Hz
	Sets the LFO speed	
	Src	Off...Tempo
h	Amt	-20.00...+20.00Hz
	Sets the modulation amount of LFO speed	
i	L Delay Time [msec]	0.0...500.0msec
	Sets the left channel delay time	
j	R Delay Time [msec]	0.0...500.0msec
	Sets the right channel delay time	
k	Depth	0...200
	Sets the depth of LFO modulation	

h	Feedback	-100...+100
	Sets the feedback amount	
i	High Damp [%]	0...100%
	Sets the feedback damping amount in the high range	
j	Wet/Dry Mod	D-mod, AUTOFADE
	Switches between D-mod and AUTOFADE for the effect balance modulation	
k	Wet/Dry	-Wet...-1:99, Dry, 1:99...Wet
	Sets the balance between the effect and dry sounds	
l	Src	Off...Tempo
	Selects the modulation source of the effect balance	
m	Amt	-100...+100
	Sets the modulation amount of the effect balance	

## 029: 2Voice Resonator

This effect resonates the input signal at a specified pitch. You can set the pitch, output level, and pan settings for two resonators individually. You can control the resonance intensity via an LFO.

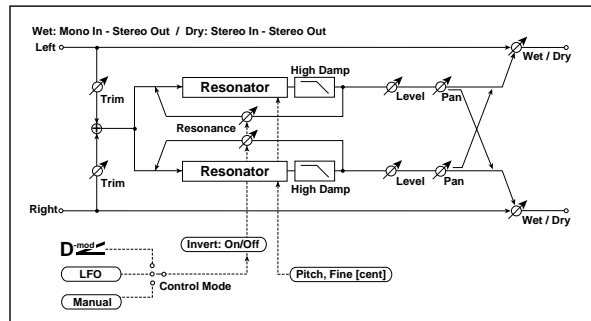

a	Control Mode	Manual, LFO, D-mod
	Switches the controls of resonance intensity	
b	LFO/D-mod Invert	Off, On
	Reverses the Voice 1 and 2 control when LFO/D-mod is selected	
c	LFO Frequency [Hz]	0.02...20.00Hz
	Sets the LFO speed	
d	D-mod Src	Off...Tempo
	Selects the modulation source that controls resonance intensity	
e	Mod. Depth	-100...+100
	Sets the amount of resonance intensity control via LFO/D-mod	
f	Trim	0...100
	Sets the input level at the resonator	
g	Voice1: Pitch	C0...B8
	Sets the voice1 Pitch for resonance	
h	Fine [cent]	-50...+50
	Fine-adjusts the voice 1 pitch for resonance	
i	Voice1: Resonance	-100...+100
	Sets the intensity of resonance when Control Mode = Manual	
j	High Damp [%]	0...100%
	Sets the damping amount of resonant sound in the high range	
k	Voice1: Level	0...100
	Sets the Voice1 output level	
l	Pan	L6...R6
	Sets the Voice1 stereo image	
m	Voice2: Pitch	C0...B8
	Sets the Voice2 Pitch for resonance	
n	Fine [cent]	-50...+50
	Fine-adjusts the voice 2 pitch for resonance	
o	Voice2: Resonance	-100...+100
	Sets the intensity of resonance when Control Mode = Manual	
p	High Damp [%]	0...100%
	Sets the damping amount of resonant sound in the high range	

i	Voice2: Level Sets the Voice2 output level	0...100
	Pan Sets the Voice2 stereo image	L6...R6
j	Wet/Dry Sets the balance between the effect and dry sounds	Dry, 1:99...99:1, Wet D <sup>mod</sup>
	Src Selects the modulation source of the effect balance	Off...Tempo
	Amt Sets the modulation amount of the effect balance	-100...+100

**a: Control Mode, e: Voice1: Resonance, h: Voice2: Resonance**  
This parameter determines the resonance intensity. When "Control Mode" = **Manual**, the "Resonance" parameter sets the intensity of resonance. If the "Resonance" parameter has a negative value, harmonics will be changed, and resonance will occur at a pitch one octave lower.

When "Control Mode" = **LFO**, the intensity of resonance varies according to the LFO. The LFO sways between positive and negative values, causing resonance to occur between specified pitches an octave apart in turn.

When "Control Mode" = **D-mod**, the resonance is controlled by the dynamic modulation source. If **JS X** or **Ribbon** is assigned as the modulation source, the pitch an octave higher and lower can be controlled, similar to when LFO is selected for Control Mode.

**a: LFO/D-mod Invert**

When "Control Mode" = **LFO** or **D-mod**, the controlled phase of either Voice 1 or 2 will be reversed. When the resonance pitch is set for Voice 1 (Resonance has a positive value), Voice 2 will resonate at a pitch an octave below (Resonance has a negative value).

**d: Voice1: Pitch, d: Fine [cent], g: Voice2: Pitch, g: Fine [cent]**

The Pitch parameter specifies the pitch of resonance by note name. The "Fine" parameter allows for fine adjustment in steps of cents.

**e: High Damp [%], h: High Damp [%]**

This parameter sets the damping amount of resonant sound in the high range. Lower values will make a metallic sound with a higher range of harmonics.

## 030: Doppler

This effect simulates the "Doppler effect" of a moving sound with a changing pitch, similar to the siren of an passing ambulance. Mixing the effect sound with the dry sound will create a unique chorus effect.

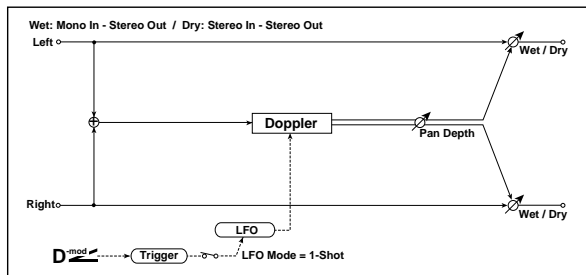

a	LFO Mode Switches LFO operation mode	Loop, 1-Shot F <sup>ES</sup> , D <sup>mod</sup>
	Src When LFO Mode is set to 1-Shot, this modulation source triggers the LFO	Off...Tempo F <sup>ES</sup>
b	LFO Sync Switches between LFO reset on and off when LFO Mode is set to Loop	Off, On F <sup>ES</sup>

c	LFO Frequency [Hz] Sets the LFO speed	0.02...20.00Hz F <sup>ES</sup> Fx:009, D <sup>mod</sup>
	Src Selects the modulation source of LFO speed	Off...Tempo
	Amt Sets the modulation amount of LFO speed	-20.00...+20.00Hz
d	BPM/MIDI Sync Switches between using the frequency of the LFO speed and using the tempo and notes	Off, On F <sup>ES</sup> Fx:009, S <sup>Sync</sup>
	BPM Selects MIDI Clock and assigns tempo	MIDI, 40...240 F <sup>ES</sup> Fx:009
	Base Note Selects the type of notes that specify the LFO speed	F <sup>ES</sup> Fx:009
e	Pitch Depth Sets the pitch variation of the moving sound	0...100 F <sup>ES</sup> , D <sup>mod</sup>
	Src Selects the modulation source of pitch variation	Off...Tempo
	Amt Sets the modulation amount of pitch variation	-100...+100
f	Pan Depth Sets the panning of the moving sound	-100...+100 F <sup>ES</sup> , D <sup>mod</sup>
	Src Selects the modulation source of panning	Off...Tempo
	Amt Sets the modulation amount of panning	-100...+100
g	Wet/Dry Sets the balance between the effect and dry sounds	Dry, 1:99...99:1, Wet D <sup>mod</sup>
	Src Selects the modulation source of the effect balance	Off...Tempo
	Amt Sets the modulation amount of the effect balance	-100...+100

**a: LFO Mode, a: Src, b: LFO Sync**

The "LFO Mode" parameter switches LFO operation mode. When **Loop** is selected, the Doppler effect will be created repeatedly. If "LFO Sync" is set to **On**, the LFO will be reset when the modulation source specified with the "Src" parameter is turned on. When "LFO Mode" is set to **1-Shot**, the Doppler effect is created only once when the modulation source specified in the "Src" field is turned on. At this time if you do not set the "Src" parameter, the Doppler effect will not be created, and no effect sound will be output.

**MIDI** The effect is off when a value for the modulation source specified for the "Src" parameter is smaller than 64, and the effect is on when the value is 64 or higher. The Doppler effect is triggered when the value changes from 63 or smaller to 64 or higher.

**e: Pitch Depth**

With the Doppler effect, the pitch is raised when the sound approaches, and the pitch is lowered when the sound goes away. This parameter sets this pitch variation.

**f: Pan Depth**

This parameter sets the width of the stereo image of the effect sound. With larger values, the sound seems to come and go from much further away. With positive values, the sound moves from left to right; with negative values, the sound moves from right to left.

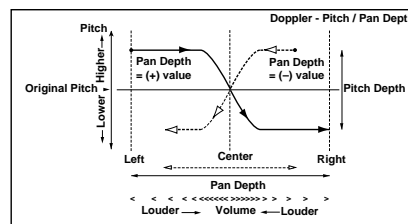

## 031: Scratch

This effect is applied by recording the input signal and moving the modulation source. It simulates the sound of scratches you can make using a turntable.

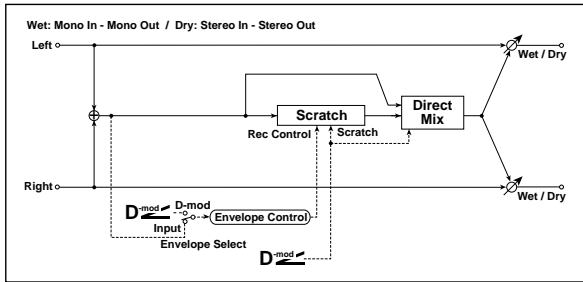

a	Scratch Source Selects the modulation source for simulation control	Off...Tempo [Icon], [D-mod]
b	Response Sets the speed of the response to the Scratch Source	0...100 [Icon]
c	Envelope Select Selects whether the start and end of recording is controlled via the modulation source or the input signal level	D-mod, Input [Icon], [D-mod]
	Src Selects the modulation source that controls recording when Envelope Select is set to D-mod	Off...Tempo [Icon]
d	Threshold Sets the recording start level when Envelope Select is set to Input	0...100 [Icon]
e	Response Sets the speed of the response to the end of recording	0...100 [Icon]
f	Direct Mix Selects how a dry sound is mixed	Always On, Always Off, Cross Fade [Icon]
g	Wet/Dry Sets the balance between the effect and dry sounds	Dry, 1:99...99:1, Wet [D-mod]
	Src Selects the modulation source of the effect balance	Off...Tempo
	Amt Sets the modulation amount of the effect balance	-100...+100

### a: Scratch Source, b: Response

The Scratch Source parameter enables you to select the modulation source that controls simulation. The value of the modulation source corresponds to the playback position. The Response parameter enables you to set the speed of the response to the modulation source.

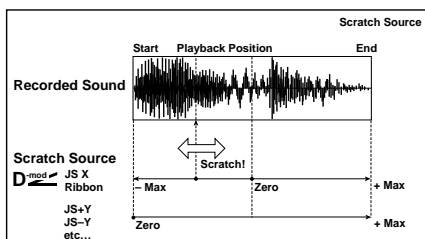

### c: Envelope Select, c: Src, d: Threshold

When "Envelope Select" is set to **D-mod**, the input signal will be recorded only when the modulation source value is 64 or higher. When "Envelope Select" is set to **Input**, the input signal will be recorded only when its level is over the Threshold value. The maximum recording time is 1365msec. If this is exceeded, the recorded data will start being erased from the top.

### e: Response

This parameter enables you to set the speed of the response to the end of recording. Set a smaller value when you are recording a phrase or rhythm pattern, and set a higher value if you are recording only one note.

### f: Direct Mix

With **Always On**, a dry sound is usually output. With **Always Off**, dry sounds are not output. With **Cross Fade**, a dry sound is usually output, and it is muted only when scratching. Set Wet/Dry to **Wet** to use this parameter effectively.

## Mod./P.Shift

Other modulation and pitch shift effects

### 032: Stereo Tremolo

This effect modulates the volume level of the input signal. The effect is stereo, and offsetting the LFO of the left and right phases from each other produces a tremolo effect between left and right.

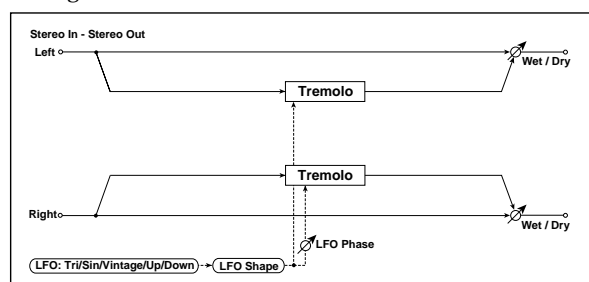

a	LFO Waveform	Triangle, Sine, Vintage, Up, Down
	Selects LFO Waveform	
b	LFO Phase [degree]	-180...+180
	Sets the LFO phase difference between the left and right	
c	LFO Frequency [Hz]	0.02...20.00Hz
	Sets the LFO speed	
	Src	Off...Tempo
	Sets the modulation source of LFO speed	
d	Amt	-20.00...+20.00Hz
	Sets the modulation amount of LFO speed	
	BPM/MIDI Sync	Off, On
	Switches between using the frequency of the LFO speed and using the tempo and notes	
e	BPM	MIDI, 40...240
	Selects MIDI Clock and assigns tempo	
	Base Note	
f	Selects the type of notes that specify the LFO speed	
	Times	x1...x16
	Sets the number of notes that specify the LFO speed	
g	Depth	0...100
	Sets the depth of LFO modulation	
	Src	Off...Tempo
	Selects the modulation source of the depth of modulation	
h	Amt	-100...+100
	Sets the modulation amount of the depth of modulation	
	Wet/Dry	Dry, 1:99...99:1, Wet
i	Sets the balance between the effect and dry sounds	
	Src	Off...Tempo
	Selects the modulation source of the effect balance	
j	Amt	-100...+100
	Sets the modulation amount of the effect balance	

#### a: LFO Waveform

This parameter selects the LFO waveform. **Vintage** wave simulates the characteristics of the tremolo created on a guitar amplifier. Combining this effect with the Amp Simulation will make a realistic, vintage tremolo amplifier sound.

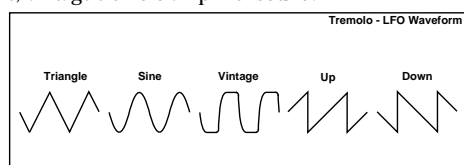

#### b: LFO Phase [degree]

This parameter determines the difference between the left and right LFO phases. A higher value will simulate the auto-pan effect in which the sound is panned between left and right.

### 033: St. Env. Tremolo

(Stereo Envelope Tremolo)

This effect uses the input signal level to modulate a stereo tremolo. You can simulate a tremolo effect that becomes deeper as it fades out while the level gets lower.

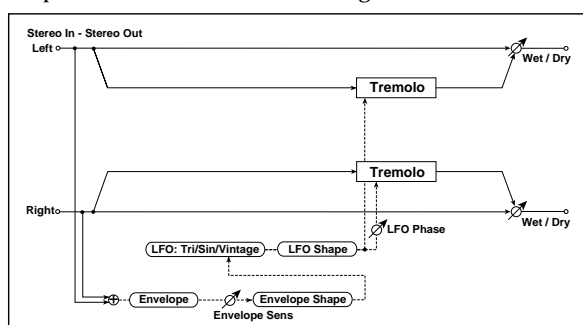

a	Envelope Sens (Envelope Sensitivity)	0...100
	Sets the envelope sensitivity of the input signal	
b	Envelope Shape	-100...+100
	Sets the envelope curve shape of the input signal	
c	LFO Waveform	Triangle, Sine, Vintage
	Selects LFO Waveform	
d	LFO Phase [degree]	-180...+180
	Sets the LFO phase difference between the left and right	
e	LFO Frequency [Hz]	0.02...20.00Hz
	Sets the LFO speed	
f	Envelope Amount [Hz]	-20.00...+20.00Hz
	Sets the changes of the LFO speed according to the input signal level	
g	Depth	0...100
	Sets the depth of LFO modulation	
h	Envelope Amount	-100...+100
	Sets the changes of the modulation depth according to the input signal level	
i	Wet/Dry	Dry, 1:99...99:1, Wet
	Sets the balance between the effect and dry sounds	
	Src	Off...Tempo
j	Selects the modulation source of the effect balance	
	Amt	-100...+100
Sets the modulation amount of the effect balance		

#### d: LFO Frequency [Hz], d: Envelope Amount [Hz],

#### e: Depth, e: Envelope Amount

These parameters set the modulation via an envelope (input signal level).

The "LFO speed" is obtained by adding the "LFO Frequency" value to the "Envelope Amount" value multiplied by the input signal. The LFO modulation depth is obtained by adding the Depth value to the "Envelope Amount" value multiplied by the input signal level.

- The following example indicates that the "Depth" is 0 with an LFO Frequency of 1.0Hz and the maximum input, and that the "Depth" is 100 with a Frequency of 8.0Hz with zero input. "LFO Frequency [Hz]" = 8.0, "Envelope Amount [Hz]" = -7.0



“Depth”=100, “Envelope Amount”=-100

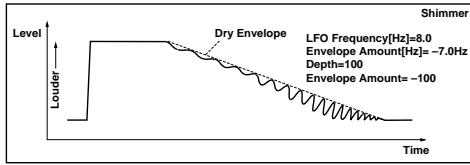

### 034: Stereo Auto Pan

This Auto Pan effect pans sound between left and right. It is stereo, and shifting the left and right LFO phases from each other will simulate the sound of the left and right channels crossing over each other by turns, or chasing each other.

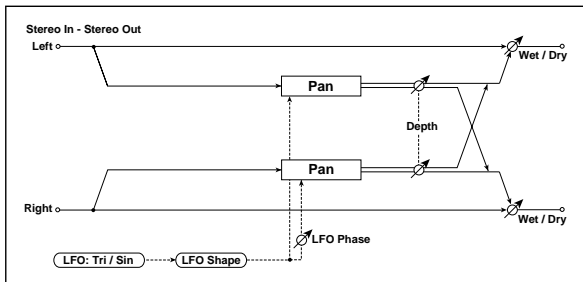

a	LFO Waveform	Triangle, Sine
	Selects LFO Waveform	
b	LFO Shape	-100...+100
	Determines how much the LFO waveform is changed	
c	LFO Phase [degree]	-180...+180
	Sets the LFO phase difference between the left and right	
	LFO Frequency [Hz]	0.02...20.00Hz
	Sets the LFO speed	
d	Src	Off...Tempo
	Selects the modulation source of LFO speed	
e	Amt	-20.00...+20.00Hz
	Sets the modulation amount of LFO speed	
	BPM/MIDI Sync	Off, On
	Switches between using the frequency of the LFO speed and using the tempo and notes	
f	BPM	MIDI, 40...240
	Selects MIDI Clock and assigns tempo	
	Base Note	
g	Selects the type of notes that specify the LFO speed	
	Times	x1...x16
h	Sets the number of notes that specify the LFO speed	
	Depth	0...100
i	Sets the depth of LFO modulation	
	Src	Off...Tempo
j	Selects the modulation source of the depth of modulation	
	Amt	-100...+100
k	Sets the modulation amount of the depth of modulation	
	Wet/Dry	Dry, 1:99...99:1, Wet
l	Sets the balance between the effect and dry sounds	
	Src	Off...Tempo
m	Selects the modulation source of the effect balance	
	Amt	-100...+100
n	Sets the modulation amount of the effect balance	

**a: LFO Shape**

You can change the panning curve by modifying the LFO waveform.

**b: LFO Phase**

This parameter determines the difference in the left and right LFO phases. When you change the value gradually from 0, the sound from the left and right channels will chase each other around. If you set the parameter to +180 or -180, the sound from each chan-

nel will cross over each other.

You need to input different sounds to each channel in order for this parameter to be effective.

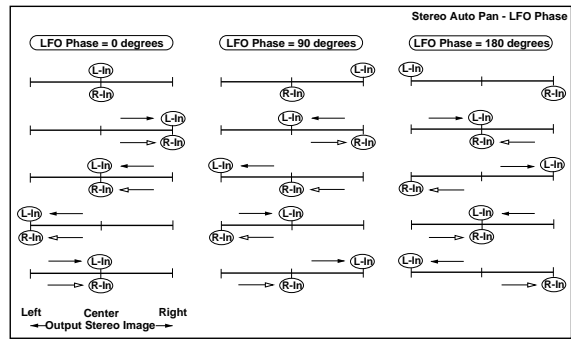

### 035: St. Phaser + Trml

(Stereo Phaser + Tremolo)

This effect has a stereo phaser and tremolo LFOs linked together. Swelling phaser modulation and tremolo effects synchronize with each other, creating a soothing modulation effect. It is suitable for electric piano type sounds.

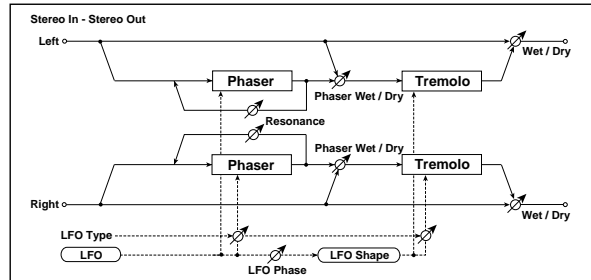

a	Type:	Phs - Trml...Phs LR - Trml LR
	Selects the type of the tremolo and phaser LFOs	
b	LFO Phase [degree]	-180...+180
	Sets the phase difference between the tremolo and phaser LFOs	
c	LFO Frequency [Hz]	0.02...20.00Hz
	Sets the LFO speed	
	Src	Off...Tempo
	Selects the modulation source of LFO speed	
d	Amt	-20.00...+20.00Hz
	Sets the modulation amount of LFO speed	
e	BPM/MIDI Sync	Off, On
	Switches between using the frequency of the LFO speed and using the tempo and notes	
	BPM	MIDI, 40...240
	Selects MIDI Clock and assigns tempo	
f	Base Note	
	Selects the type of notes that specify the LFO speed	
g	Times	x1...x16
	Sets the number of notes that specify the LFO speed	
h	Phaser Manual	0...100
	Sets the phaser frequency range	
i	Resonance	-100...+100
	Sets the phaser resonance amount	
j	Phaser Depth	0...100
	Sets the phaser modulation depth	
k	Src	Off...Tempo
	Selects the modulation source for the phaser modulation depth	
l	Amt	-100...+100
	Sets the modulation amount for the phaser modulation depth	
m	Phaser Wet/Dry	-Wet...-2:99, Dry, 2:99...Wet
	Sets the balance between the phaser effect and dry sounds	

g	Tremolo Shape	-100...+100	
	Sets the degree of the tremolo LFO shaping		Fx:020
h	Tremolo Depth	0...100	
	Sets the tremolo modulation depth		D <sup>mod</sup>
	Src	Off...Tempo	
i	Wet/Dry	Dry, 1:99...99:1, Wet	
	Sets the balance between the effect and dry sounds		Fx:009, D <sup>mod</sup>
	Src	Off...Tempo	
i	Wet/Dry	Dry, 1:99...99:1, Wet	
	Sets the balance between the effect and dry sounds		Fx:009, D <sup>mod</sup>
i	Src	Off...Tempo	
	Amt	-100...+100	
i	Wet/Dry	Dry, 1:99...99:1, Wet	
	Sets the balance between the effect and dry sounds		Fx:009, D <sup>mod</sup>
i	Src	Off...Tempo	
	Amt	-100...+100	

**a: Type, a: LFO Phase [degree]**

Select the type of phaser LFO and tremolo LFO for the "Type" parameter. How the effect sound moves or rotates depends on the type of LFO. Selecting "LFO Phase" enables you to offset the timing of the phaser peak and control a subtle movement and rotation of the sound.

**f: Phaser Wet/Dry, i: Wet/Dry**

The "Phaser Wet/Dry" parameter sets the balance between the phaser output and the dry sound. The "Wet/Dry" parameter sets the balance between the final phaser and tremolo output level and the dry sound.

### 036: St. Ring Modulator (Stereo Ring Modulator)

This effect creates a metallic sound by applying the oscillators to the input signal. Use the LFO or Dynamic Modulation to modulate the oscillator to create a radical modulation. Matching the oscillator frequency with a note number will produce a ring modulation effect in specific key ranges.

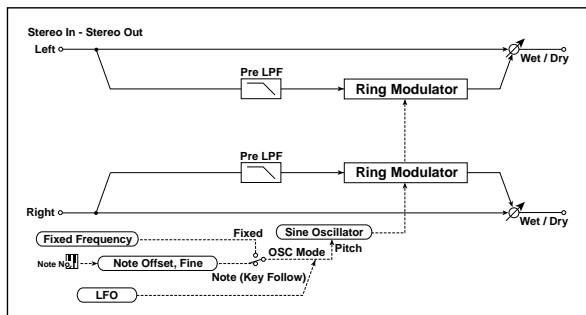

a	Pre LPF	0...100	
	Sets the damping amount of the high range input to the ring modulator		Fx:009
b	OSC Mode	Fixed, Note (Key Follow)	
	Switching between specifying the oscillator frequency and using a note number		Fx:009
c	Fixed Frequency [Hz]	0...12.00kHz	
	Sets the oscillator frequency when OSC Mode is set to Fixed		Fx:009, D <sup>mod</sup>
	Src	Off...Tempo	
c	Wet/Dry	Dry, 1:99...99:1, Wet	
	Sets the balance between the effect and dry sounds		Fx:009, D <sup>mod</sup>
	Src	Off...Tempo	
d	Note Offset	-48...+48	
	Sets the pitch difference from the original note when OSC Mode is set to Note (Key Follow)		Fx:009
d	Note Fine	-100...+100	
	Fine-adjusts the oscillator frequency		Fx:009

e	LFO Frequency [Hz]	0.02...20.00Hz	
	Sets the LFO speed of the oscillator frequency modulation		Fx:009, D <sup>mod</sup>
e	Src	Off...Tempo	
	Selects the modulation source of LFO speed		
e	Amt	-20.00...+20.00Hz	
	Sets the modulation amount of LFO speed		
f	BPM/MIDI Sync	Off, On	
	Switches between using the frequency of the LFO speed and using the tempo and notes		Fx:009, Sine
f	BPM	MIDI, 40...240	
	Selects MIDI Clock and assigns tempo		Fx:009
f	Base Note		
	Selects the type of notes that specify the LFO speed		Fx:009
f	Times	x1...x16	
	Sets the number of notes that specify the LFO speed		Fx:009
g	LFO Depth	0...100	
	Sets the depth of LFO modulation for the oscillator frequency		D <sup>mod</sup>
g	Src	Off...Tempo	
	Selects the modulation source of the depth of modulation		
g	Amt	-100...+100	
	Sets the modulation amount of the depth of modulation		
h	Wet/Dry	Dry, 1:99...99:1, Wet	
	Sets the balance between the effect and dry sounds		D <sup>mod</sup>
h	Src	Off...Tempo	
	Selects the modulation source of the effect balance		
h	Amt	-100...+100	
	Sets the modulation amount of the effect balance		

**a: Pre LPF**

This parameter enables you to set the damping amount of the high range sound input to the ring modulator. If the input sound contains lots of harmonics, the effect may sound dirty. In this case, cut a certain amount of high range.

**b: OSC Mode**

This parameter determines whether or not the oscillator frequency follows the note number.

**c: Fixed Frequency [Hz]**

This parameter sets the oscillator frequency when "OSC Mode" is set to Fixed.

**d: Note Offset, d: Note Fine**

These parameters for the oscillator are used when "OSC Mode" is set to Note (Key Follow). The "Note Offset" sets the pitch difference from the original note in semitone steps. The "Note Fine" parameter fine-adjusts the pitch in cent steps. Matching the oscillator frequency with the note number produces a ring modulation effect in the correct key.

### 037: Detune

Using this effect, you can obtain a detune effect that offsets the pitch of the effect sound slightly from the pitch of the input signal. Compared to the chorus effect, a more natural sound thickness will be created.

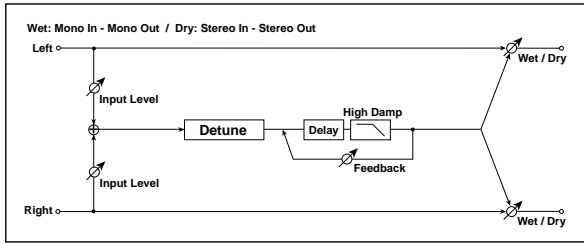

a	Pitch Shift [cent] Sets the pitch difference from the input signal	-100...+100cent	
	Src Selects the modulation source of the pitch shift	Off...Tempo	
	Amt Sets the modulation amount of the pitch shift	-100...+100cent	
b	Delay Time [msec] Sets the delay time	0...1000msec	
	Feedback Sets the feedback amount	-100...+100	
c	High Damp [%] Sets the damping amount in the high range	0...100%	
	Input Level Dmod [%] Sets the modulation amount of the input level	-100...+100	
d	Src Selects the modulation source for the input level	Off...Tempo	
	Wet/Dry Sets the balance between the effect and dry sounds	Dry, 1:99...99:1, Wet	
	Src Selects the modulation source of the effect balance	Off...Tempo	
e	Amt Sets the modulation amount of the effect balance	-100...+100	

**d: Input Level Dmod [%], d: Src**

This parameter sets the dynamic modulation of the input level.

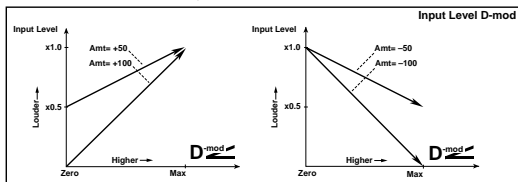

### 038: Pitch Shifter

This effect changes the pitch of the input signal. You can select from three types: Fast (quick response), Medium, and Slow (preserves tonal quality). You can also create an effect in which the pitch is gradually raised (or dropped) using the delay with feedback.

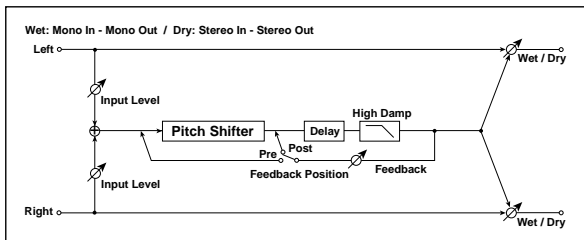

a	Mode Switches Pitch Shifter mode	Slow, Medium, Fast	
b	Pitch Shift [1/2tone] Sets the pitch shift amount by steps of a semitone	-24...+24	
	Src Selects the modulation source of pitch shift amount	Off...Tempo	
	Amt Sets the modulation amount of pitch shift amount	-24...+24	
c	Fine [cent] Sets the pitch shift amount by steps of a cent	-100...+100cent	
	Amt Sets the modulation amount of pitch shift amount	-100...+100cent	
d	Delay Time [msec] Sets the delay time	0...1000msec	
e	Feedback Position Switches the feedback connection.	Pre, Post	
	Feedback Sets the feedback amount	-100...+100	
f	High Damp [%] Sets the damping amount in the high range	0...100%	
	Input Level Dmod [%] Sets the modulation amount of the input level	-100...+100	
	Src Selects the modulation source for the input level	Off...Tempo	
g	Wet/Dry Sets the balance between the effect and dry sounds	Dry, 1:99...99:1, Wet	
	Src Selects the modulation source of the effect balance	Off...Tempo	
	Amt Sets the modulation amount of the effect balance	-100...+100	

**a: Mode**

This parameter switches the pitch shifter operating mode. With **Slow**, tonal quality will not be changed too much. With **Fast**, the effect becomes a Pitch Shifter that has a quick response, but may change the tone. **Medium** is in between these two. If you do not need to set too much pitch shift amount, set this parameter to **Slow**. If you wish to change the pitch significantly, use **Fast**.

**b: Pitch Shift [1/2tone], b: Src, b: Amt, c: Fine [cent], c: Amt**

The amount of pitch shift will use the value of the "Pitch Shift" plus the "Fine" value. The amount of modulation will use the c: Amt value plus d: "Amt."

Modulation Source is used both for "Pitch Shift" and "Fine."

**e: Feedback Position, f: Feedback**

When "Feedback Position" is set to **Pre**, the pitch shifter output is again input to the pitch shifter. Therefore, if you specify a higher value for the Feedback parameter, the pitch will be raised (or lowered) more and more each time feedback is repeated.

If "Feedback Position" is set to **Post**, the feedback signal will not pass through the pitch shifter again. Even if you specify a higher value for the Feedback parameter, the pitch-shifted sound will be repeated at the same pitch.

## 039: Pitch Shift Mod.

### (Pitch Shift Modulation)

This effect modulates the detuned pitch shift amount using an LFO, adding a clear spread and width to the sound by panning the effect sound and dry sound to the left and right. This is especially effective when the effect sound and dry sound output from stereo speakers are mixed.

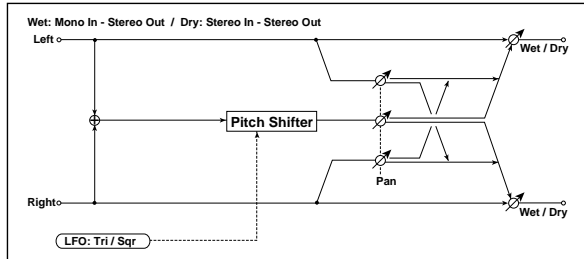

a	Pitch Shift [cent] Sets the pitch difference from the input signal	-100...+100cent E33
b	LFO Waveform Selects LFO Waveform	Triangle, Square E33
c	LFO Frequency [Hz] Sets the LFO speed	0.02...20.00Hz E33 Fx:009, Dmod
	Src Selects the modulation source of LFO speed	Off...Tempo E33
	Amt Sets the modulation amount of LFO speed	-20.00...+20.00Hz E33
d	BPM/MIDI Sync Switches between using the frequency of the LFO speed and using the tempo and notes	Off, On E33 Fx:009, Dmod
	BPM Selects MIDI Clock and assigns tempo	MIDI, 40...240 E33 Fx:009
	Base Note Selects the type of notes that specify the LFO speed	E33 Fx:009
	Times Sets the number of notes that specify the LFO speed	x1...x16 E33 Fx:009
e	Depth Sets the LFO modulation depth for pitch shift amount	-100...+100 E33, Dmod
	Src Selects the modulation source of the depth of modulation	Off...Tempo E33
	Amt Sets the modulation amount of the depth of modulation	-100...+100 E33
f	Pan Sets the panning effect sound and dry sound separately	L, 1:99...99:1, R E33
g	Wet/Dry Sets the balance between the effect and dry sounds	Dry, 1:99...99:1, Wet E33, Dmod
	Src Selects the modulation source of the effect balance	Off...Tempo E33
	Amt Sets the modulation amount of the effect balance	-100...+100 E33

#### a: Pitch Shift [cent], e: Depth

These parameters set the amount of pitch shift and amount of modulation by means of the LFO.

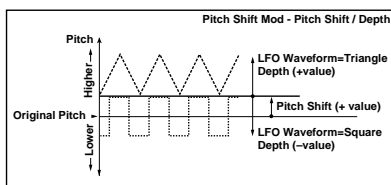

#### f: Pan, g: Wet/Dry

The Pan parameter pans the effect sound and dry sound to the left and right. With L, the effect sound is panned left, and the dry sound is panned right. With a Wet/Dry = Wet setting, the effect and dry sound will be output in a proportion of 1:1.

## 040: Rotary Speaker

This effect simulates a rotary speaker, and obtains a more realistic sound by simulating the rotor in the low range and the horn in the high range separately. The effect also simulates the stereo microphone settings.

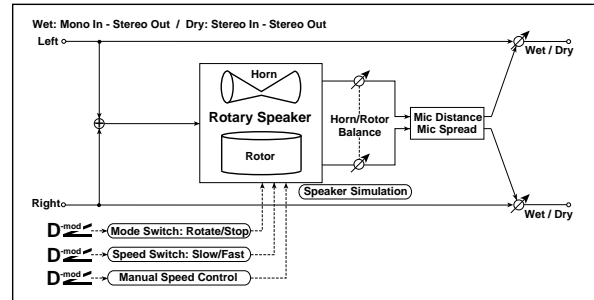

a	Mode Switch Switches between speaker rotation and stop	Rotate, Stop Dmod
	Src Selects the modulation source that toggles between rotation and stop	Off...Tempo E33
	Sw Selects switching mode of the modulation source that toggles between rotation and stop	Toggle, Moment E33
b	Speed Switch Switches the speaker rotation speed between slow and fast	Slow, Fast Dmod
	Src Selects the modulation source that toggles between slow and fast	Off...Tempo E33
	Sw Selects switching mode of the modulation source that toggles between slow and fast	Toggle, Moment E33
c	Manual Speed Ctrl (Manual Speed Control) Selects the modulation source in case the rotation speed is changed directly	Off...Tempo E33, Dmod
d	Horn Acceleration How quickly the horn rotation speed in the high range is switched	0...100 E33
	Horn Ratio Adjusts the (high-range side) horn rotation speed. Standard value is 1.00. Selecting "Stop" will stop the rotation	Stop, 0.50...2.00 E33
e	Rotor Acceleration Determines how quickly the rotor rotation speed in the low range is switched	0...100 E33
	Rotor Ratio Adjusts the (low-range side) rotor rotation speed. Standard value is 1.00. Selecting "Stop" will stop the rotation	Stop, 0.50...2.00 E33
f	Horn/Rotor Balance Sets the level balance between the high-range horn and low-range rotor	Rotor, 1...99, Horn E33
g	Mic Distance Sets the distance between the microphone and rotary speaker	0...100 E33
	Mic Spread Sets the angle of left and right microphones	0...100 E33
h	Wet/Dry Sets the balance between the effect and dry sounds	Dry, 1:99...99:1, Wet Dmod
	Src Selects the modulation source of the effect balance	Off...Tempo E33
	Amt Sets the modulation amount of the effect balance	-100...+100 E33

#### a: Sw

This parameter sets how the modulation source switches between rotation and stop.

When "Sw" = **Toggle**, the speaker rotates or stops alternately each time you press the pedal or operate the joystick.

**MIDI** Each time the value for the modulation source exceeds 64, the speaker rotates or stops alternately.

When "Sw" = **Moment**, the speaker is rotating. It stops only when you press the pedal or operate the joystick.

**MIDI** Rotation will occur when the value of the modulation source is less than 64, and will stop when the value is 64 or greater.

**b: Sw**

This parameter sets how the rotation speed (slow and fast) is switched via the modulation source.

When "Sw" = **Toggle**, the speed is switched between slow and fast each time you press the pedal or operate the joystick.

**MIDI** Slow/fast will alternate each time the value of the modulation source exceeds 64.

When "Sw" = **Moment**, the speed is usually slow. It becomes fast only when you press the pedal or operate the joystick.

**MIDI** When a value for the modulation source is less than 64, "slow" speed is selected, and when the value is 64 or higher, "fast" is selected.

**c: Manual Speed Ctrl**

If you wish to control the speaker rotation speed manually, not switching between Slow and Fast, select the modulation source in the "Manual Speed Ctrl" field. If manual control is not necessary, set this field to **Off**.

**d: Horn Acceleration, e: Rotor Acceleration**

On a real rotary speaker, the rotation speed is accelerated or decelerated gradually after you switch the speed. The "Horn Acceleration" parameter sets the speed at which the rotation is accelerated or decelerated.

**g: Mic Distance, g: Mic Spread**

This is a simulation of stereo microphone settings.

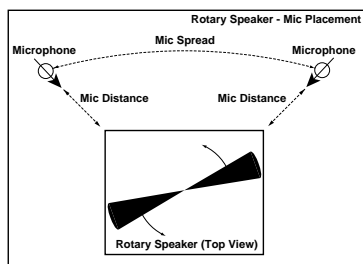

## ER/Delay

### Early reflection and delay effects

#### 041: Early Reflections

This effect is only the early reflection part of a reverberation sound, and adds presence to the sound. You can select one of the four decay curves.

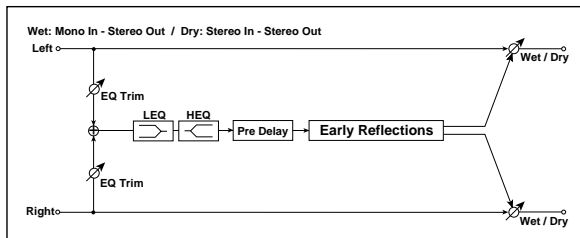

a	Type Selects the decay curve for the early reflection	Sharp, Loose, Modulated, Reverse	
b	ER Time [msec] Sets the time length of early reflection	10...800msec	
c	Pre Delay [msec] Sets the time taken from the original sound to the first early reflection	0...200msec	
d	EQ Trim Sets the input level of EQ applied to the effect sound	0...100	
e	Pre LEQ Gain [dB] Sets the gain of Low EQ	-15.0...+15.0dB	
	Pre HEQ Gain [dB] Sets the gain of High EQ	-15.0...+15.0dB	
f	Wet/Dry Sets the balance between the effect and dry sounds	Dry, 1:99...99:1, Wet	
	Src Selects the modulation source of the effect balance	Off...Tempo	
	Amt Sets the modulation amount of the effect balance	-100...+100	

**a: Type**

This parameter selects the decay curve for the early reflection.

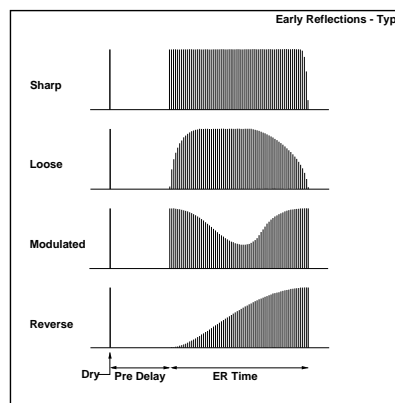

## 042: Auto Reverse

This effect records the input signal and automatically plays it in reverse (the effect is similar to a tape reverse sound).

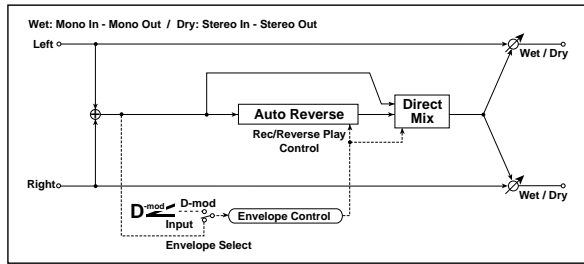

a	Rec Mode Sets the recording mode	Single, Multi
b	Reverse Time [msec] Sets the maximum duration of the reverse playback	20...1320msec
c	Envelope Select Selects whether the start and end of recording is controlled via the modulation source or the input signal level	D-mod, Input
	Src Selects the modulation source that controls recording when Envelope Select is set to D-mod	Off...Tempo
d	Threshold Sets the recording start level when Envelope Select is set to Input	0...100
e	Response Sets the speed of the response to the end of recording	0...100 Fx:031
f	Direct Mix Selects how a dry sound is mixed	Always On, Always Off, Cross Fade Fx:031
g	Wet/Dry Sets the balance between the effect and dry sounds	Dry, 1:99...99:1, Wet
	Src Selects the modulation source of the effect balance	Off...Tempo
	Amt Sets the modulation amount of the effect balance	-100...+100

### a: Rec Mode, b: Reverse Time

When "Rec Mode" is set to **Single**, you can set up to 1320msec for "Reverse Time." If recording starts during the reverse playback, the playback will be interrupted.

When "Rec Mode" is set to **Multi**, you can make another recording during the reverse playback. However, the maximum Reverse Time is limited to 660msec.

If you wish to record a phrase or rhythm pattern, set "Rec Mode" to **Single**. If you record only one note, set "Rec Mode" to **Multi**. The "Reverse Time" parameter specifies the maximum duration of the reverse playback. The part in excess of this limit will not be played in reverse. If you wish to add short pieces of the reverse playback of single notes, make the "Reverse Time" shorter.

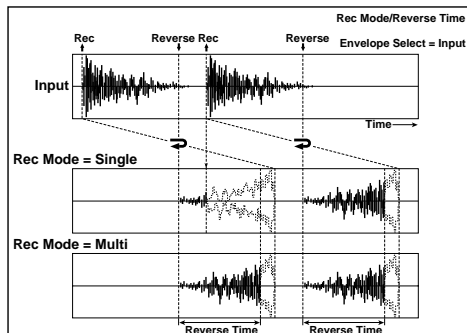

### c: Envelope Select, c: Src, d: Threshold

These parameters select the source to control the start and end of recording.

When "Envelope Select" is set to **D-mod**, the input signal will be recorded only when the value of the modulation source selected by the Src parameter is 64 or higher.

When "Envelope Select" is set to **Input**, the input signal will be recorded only when its level exceeds the Threshold level. When recording is completed, reverse playback starts immediately.

## 043: L/C/R Delay

This multitap delay outputs three Tap signals to the left, right, and center respectively. You can also adjust the left and right spread of the delay sound.

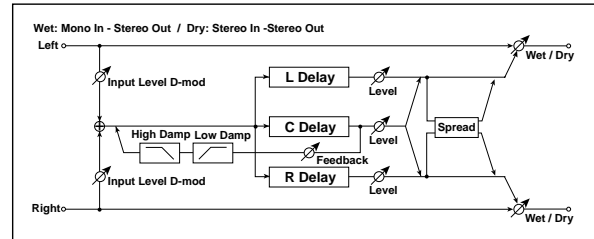

a	L Delay Time [msec] Sets the delay time of TapL	0...1360msec
	Level Sets the output level of TapL	0...50
b	C Delay Time [msec] Sets the delay time of TapC	0...1360msec
	Level Sets the output level of TapC	0...50
c	R Delay Time [msec] Sets the delay time of TapR	0...1360msec
	Level Sets the output level of TapR	0...50
d	Feedback (C Delay) Sets the feedback amount of TapC	-100...+100
	Src Selects the modulation source of the TapC feedback amount	Off...Tempo
	Amt Sets the modulation amount of the TapC feedback amount	-100...+100
e	High Damp [%] Sets the damping amount in the high range	0...100%
	Low Damp [%] Sets the damping amount in the low range	0...100%
f	Input Level Dmod [%] Sets the modulation amount of the input level	-100...+100 Fx:037, D-mod
	Src Selects the modulation source for the input level	Off...Tempo Fx:037
g	Spread Sets the width of the stereo image of the effect sound	0...50
h	Wet/Dry Sets the balance between the effect and dry sounds	Dry, 1:99...99:1, Wet
	Src Selects the modulation source of the effect balance	Off...Tempo
	Amt Sets the modulation amount of the effect balance	-100...+100

### e: High Damp [%], e: Low Damp [%]

These parameters set the damping amount of high range and low range. The tone of the delayed sound becomes darker and lighter as it feeds back.

### g: Spread

This parameter sets the pan width of the effect sound. The stereo image is widest with a value of 50, and the effect sound of both channels is output from the center with a value of 0.

## 044: Stereo/Cross Delay

This is a stereo delay, and can be used as a cross-feedback delay effect in which the delay sounds cross over between the left and right by changing the feedback routing.

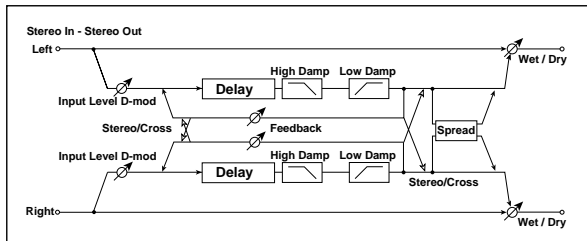

a	Stereo/Cross Switches between stereo delay and cross-feedback delay	Stereo, Cross
b	L Delay Time [msec] Sets the delay time for the left channel	0.0...680.0msec
c	R Delay Time [msec] Sets the delay time for the right channel	0.0...680.0msec
d	L Feedback Sets the feedback amount for the left channel	-100...+100 
	Src Selects the modulation source of feedback amount	Off...Tempo
	Amt L Sets the modulation amount of the left channel feedback	-100...+100
e	R Feedback Sets the feedback amount for the right channel	-100...+100 
	Amt R Sets the modulation amount of the right channel feedback	-100...+100
f	High Damp [%] Sets the damping amount in the high range	0...100% 
g	Low Damp [%] Sets the damping amount in the low range	0...100% 
h	Input Level Dmod [%] Sets the modulation amount of the input level	-100...+100 
	Src Selects the modulation source for the input level	Off...Tempo 
i	Spread Sets the width of the stereo image of the effect sound	-50...+50 
j	Wet/Dry Sets the balance between the effect and dry sounds	Dry, 1:99...99:1, Wet 
	Src Selects the modulation source of the effect balance	Off...Tempo
	Amt Sets the modulation amount of the effect balance	-100...+100

## 045: St. Multitap Delay

(Stereo Multitap Delay)

The left and right Multitap Delays have two taps respectively. Changing the routing of feedback and tap output allows you to create various patterns of complex effect sounds.

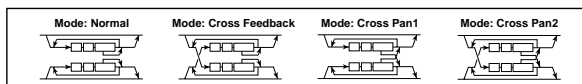
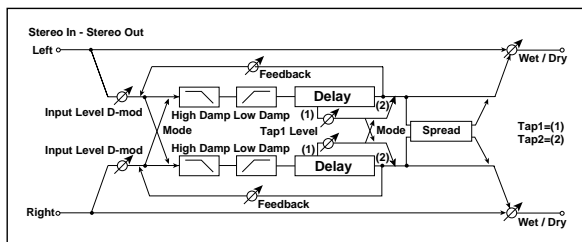

a	Mode Switches the left and right delay routing	Normal, Cross Feedback, Cross Pan1, Cross Pan2
b	Tap1 Time [msec] Sets the Tap1 delay time	0.0...680.0msec
c	Tap2 Time [msec] Sets the Tap2 delay time	0.0...680.0msec
d	Tap1 Level Sets the Tap1 output level	0...100 
e	Feedback (Tap2) Sets the Tap2 feedback amount	-100...+100 
	Src Selects the modulation source of the Tap2 feedback amount	Off...Tempo
	Amt Sets the modulation amount of the Tap2 feedback amount	-100...+100
f	High Damp [%] Sets the damping amount in the high range	0...100% 
g	Low Damp [%] Sets the damping amount in the low range	0...100% 
h	Input Level Dmod [%] Sets the modulation amount of the input level	-100...+100 
	Src Selects the modulation source for the input level	Off...Tempo 
i	Spread Sets the width of the stereo image of the effect sound	-100...+100 
	Src Selects the modulation source of the effect sound's stereo image width	Off...Tempo
	Amt Sets the modulation amount of the effect sound's stereo image width	-100...+100
j	Wet/Dry Sets the balance between the effect and dry sounds	Dry, 1:99...99:1, Wet 
	Src Selects the modulation source of the effect balance	Off...Tempo
	Amt Sets the modulation amount of the effect balance	-100...+100

### a: Mode

You can change how the left and right delay signals are panned by modifying the routing of the left and right delay as shown in the figure above. You need to input different sounds to each channel in order for this parameter to be effective.

### d: Tap1 Level

This parameter sets the output level of Tap1. Setting a different level from Tap2 will add a unique touch to a monotonous delay and feedback.

## 046: St. Modulation Delay (Stereo Modulation Delay)

This stereo delay uses an LFO to sweep the delay time. The pitch varies. You will obtain a delay sound with swell and shimmering. You can also control the delay time using a modulation source.

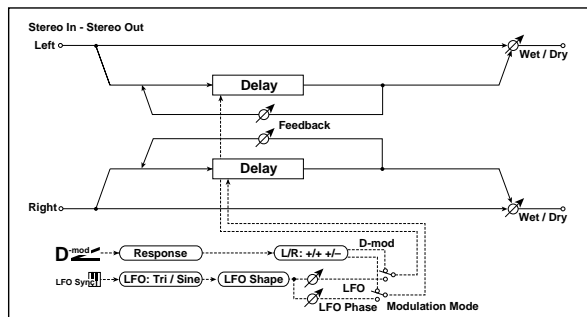

a	Modulation Mode	LFO, D-mod
	Switches between LFO modulation control and modulation source control	
b	D-mod Modulation	L/R: +/+, L/R: +/-
	Reversed L/R control by modulation source	
	Src	Off...Tempo
c	Response	0...30
	Sets the rate of response to the modulation source	
d	LFO Waveform	Triangle, Sine
	LFO Shape	-100...+100
e	LFO Frequency [Hz]	0.02...20.00Hz
	Sets the LFO speed	
f	LFO Sync	Off, On
	Switches LFO reset off/on	
g	Src	Off...Tempo
	Selects the modulation source that resets the LFO	
h	L LFO Phase [degree]	-180...+180
	Sets the phase obtained when the left LFO is reset	
i	R LFO Phase [degree]	-180...+180
	Sets the phase obtained when the right LFO is reset	
j	L Depth	0...200
	Sets the depth of the left LFO modulation	
k	R Depth	0...200
	Sets the depth of the right LFO modulation	
l	L Delay Time [msec]	0.0...500.0
	Sets the left delay time	
m	R Delay Time [msec]	0.0...500.0
	Sets the right delay time	
n	L Feedback	-100...+100
	Sets the feedback amount of left delay	
o	R Feedback	-100...+100
	Sets the feedback amount of right delay	
p	Wet/Dry	-1:99...0:100, Dry, 1:99...Wet
	Sets the balance between the effect and dry sounds	
	Src	Off...Tempo
	Selects the modulation source of the effect balance	
q	Amt	-100...+100
	Sets the modulation amount of the effect balance	

### b: D-mod Modulation

When the modulation source is used for control, this parameter reverses the left and right modulation direction.

e: LFO Sync, e: Src,  
f: L LFO Phase [degree], f: R LFO Phase [degree]

The LFO can be reset via a modulation source.

The "Src" parameter sets the modulation source that resets the LFO. For example, you can assign Gate as a modulation source so that the sweep always starts from the specified point.

"L LFO Phase" and "R LFO Phase" set the phase obtained when the left and right LFOs are reset. In this way, you can create changes in pitch sweep for the left and right channels individually.

**MIDI** The effect is off when a value of the modulation source specified in the "Src" parameter is 63 or smaller, and the effect is on when the value is 64 or higher. The LFO is triggered and reset to the "L LFO Phase" and "R LFO Phase" settings when the value changes from 63 or smaller to 64 or higher.

## 047: St. Dynamic Delay (Stereo Dynamic Delay)

This stereo delay controls the level of delay according to the input signal level. You can use this as a ducking delay that applies delay to the sound only when you play keys at a high velocity or only when the volume level is low.

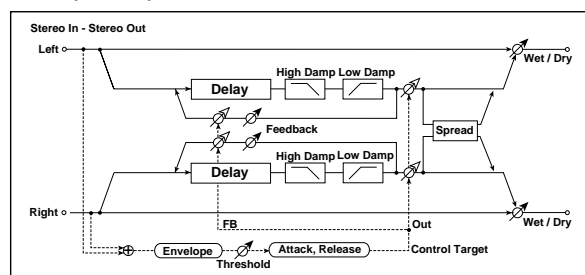

a	Control Target	None, Out, FB
	Selects from no control, output, and feedback	
b	Polarity	+, -
	Reverses level control	
c	Threshold	0...100
	Sets the level to which the effect is applied	
d	Offset	0...100
	Sets the offset of level control	
e	Attack	1...100
	Sets the attack time of level control	
f	Release	1...100
	Sets the release time of level control	
g	L Delay Time [msec]	0.0...680.0msec
	Sets the delay time for the left channel	
h	R Delay Time [msec]	0.0...680.0msec
	Sets the delay time for the right channel	
i	Feedback	-100...+100
	Sets the feedback amount	
j	High Damp [%]	0...100%
	Sets the damping amount in the high range	
k	Low Damp [%]	0...100%
	Sets the damping amount in the low range	
l	Spread	-100...+100
	Sets the width of the stereo image of the effect sound	
m	Wet/Dry	Dry, 1:99...99:1, Wet
	Sets the balance between the effect and dry sounds	
	Src	Off...Tempo
n	Src	Off...Tempo
	Selects the modulation source of the effect balance	
o	Amt	-100...+100
	Sets the modulation amount of the effect balance	



**a: Control Target**

This parameter selects no level control, delay output control (effect balance), or feedback amount control.

**a: Polarity, b: Threshold, b: Offset, c: Attack, d: Release**

The "Offset" parameter specifies the value for the "Control Target" parameter (that is set to None), expressed as the ratio relative to the parameter value (the "Wet/Dry" value with "Control Target"=Out, or the "Feedback" value with "Control Target"=FB).

When "Polarity" is **positive**, the "Control Target" value is obtained by multiplying the parameter value by the "Offset" value (if the input level is below the threshold), or equals the parameter value if the input level exceeds the threshold.

When "Polarity" is **negative**, Control Target value equals the parameter value if the input level is below the threshold, or is obtained by multiplying the parameter value by the "Offset" value if the level exceeds the threshold.

The "Attack" and "Release" parameters specify attack time and release time of delay level control.

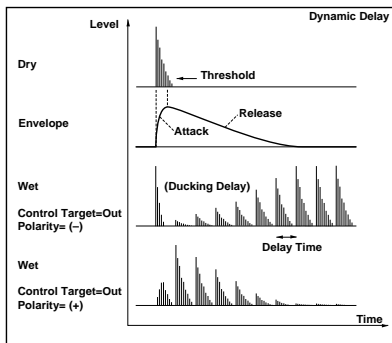

**048: St. Auto Panning Dly**  
(Stereo Auto Panning Delay)

This stereo delay effect pans the delay sound left and right using the LFO.

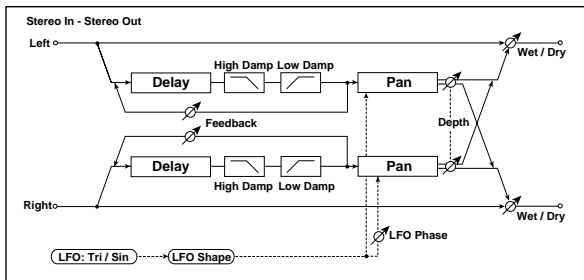

a	L Delay Time [msec]	0.0...680.0msec
	Sets the delay time for the left channel	
b	L Feedback	-100...+100
	Sets the feedback amount for the left channel	
c	R Delay Time [msec]	0.0...680.0msec
	Sets the delay time for the right channel	
d	R Feedback	-100...+100
	Sets the feedback amount for the right channel	
e	High Damp [%]	0...100% Fx:043
	Sets the damping amount in the high range	
f	Low Damp [%]	0...100% Fx:043
	Sets the damping amount in the low range	
g	LFO Waveform	Triangle, Sine
	Selects LFO Waveform	
h	LFO Shape	-100...+100 Fx:020
	Determines how much the LFO waveform is changed	
i	LFO Phase [degree]	-180...+180 Fx:034
	Sets the LFO phase difference between the left and right	

f	Panning Freq (Frequency) [Hz]	0.02...20.00Hz
g	Sets the panning speed	
	Panning Depth	0...100
	Sets the panning width	
h	Src	Off...Tempo
	Sets the modulation source for the panning width	
i	Amt	-100...+100
	Set the modulation amount of the panning width	
j	Wet/Dry	Dry, 1:99...99:1, Wet
	Sets the balance between the effect and dry sounds	
k	Src	Off...Tempo
	Sets the modulation source of the effect balance	
l	Amt	-100...+100
	Set the modulation amount of the effect balance	

**049: L/C/R BPM Delay**

The L/C/R delay enables you to match the delay time with the song tempo. You can also synchronize the delay time with the arpeggiator or sequencer. If you program the tempo before performance, you can achieve a delay effect that synchronizes with the song in real-time. Delay time is set by notes.

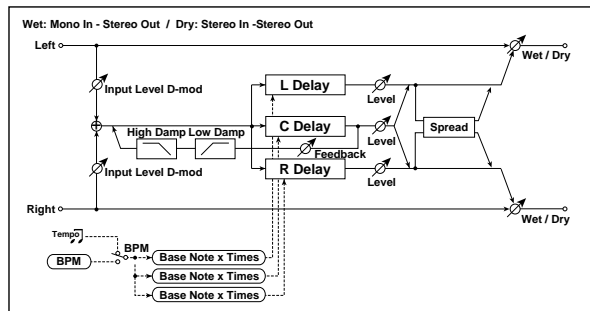

a	BPM	MIDI, 40...240
	Selects MIDI Clock and assigns tempo	
b	Time Over? >	----, OVER!!
	Displays an error message when the delay time exceeds the upper limit	
c	L Delay Base Note	
	Selects the type of notes to specify the delay time for TapL	
d	Times	x1...x16
	Sets the number of notes to specify the delay time for TapL	
e	Level	0...50
	Sets the output level of TapL	
f	C Delay Base Note	
	Selects the type of notes to specify the delay time for TapC	
g	Times	x1...x16
	Sets the number of notes to specify the delay time for TapC	
h	Level	0...50
	Sets the output level of TapC	
i	R Delay Base Note	
	Selects the type of notes to specify the delay time for TapR	
j	Times	x1...x16
	Sets the number of notes to specify the delay time for TapR	
k	Level	0...50
	Sets the output level of TapR	
l	Feedback (C Delay)	-100...+100
	Sets the feedback amount of TapC	
m	Src	Off...Tempo
	Selects the modulation source for the TapC feedback	
n	Amt	-100...+100
	Set the modulation amount of the TapC feedback	



e	High Damp [%] Sets the damping amount in the high range	0...100% Fx:043
	Low Damp [%] Sets the damping amount in the low range	0...100% Fx:043
f	Input Level Dmod [%] Sets the modulation amount of the input level	-100...+100 Fx:037, D <sup>mod</sup>
	Src Selects the modulation source for the input level	Off...Tempo Fx:037
g	Wet/Dry Sets the balance between the effect and dry sounds	Dry, 1:99...99:1, Wet D <sup>mod</sup>
	Src Selects the modulation source of the effect balance	Off...Tempo
	Amt Sets the modulation amount of the effect balance	-100...+100

**a: BPM, b: Rhythm Pattern**

With the tempo specified by the “BPM” parameter (or the MIDI Clock tempo if “BPM” is set to **MIDI**), the length of one beat equals the feedback delay time, and the interval between taps becomes equal. Selecting a rhythm pattern will automatically turn the tap outputs on and off. When “BPM” is set to **MIDI**, the lower limit of the “BPM” is **44**.

## Reverb

### Reverb effects

These effects simulate the ambience of reverberation in concert halls.

### 052: Reverb Hall

This hall-type reverb simulates the reverberation of mid-size concert halls or ensemble halls.

### 053: Reverb SmoothHall

This hall-type reverb simulates the reverberation of larger halls and stadiums, and creates a smooth release.

### 054: Reverb Wet Plate

This plate reverb simulates warm (dense) reverberation.

### 055: Reverb Dry Plate

This plate reverb simulates dry (light) reverberation.

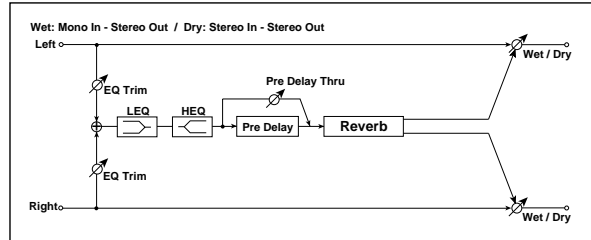

a	Reverb Time [sec] Sets the reverberation time	0.1...10.0sec
	High Damp [%] Sets the damping amount in the high range	0...100%
b	Pre Delay [msec] Sets the delay time from the dry sound	0...200msec Fx
	Pre Delay Thru [%] Sets the mix ratio of non-delay sound	0...100% Fx
c	EQ Trim Sets the EQ input level	0...100
d	Pre LEQ Gain [dB] Sets the gain of Low EQ	-15...+15dB
	Pre HEQ Gain [dB] Sets the gain of High EQ	-15...+15dB
e	Wet/Dry Sets the balance between the effect and dry sounds	Dry, 1:99...99:1, Wet D <sup>mod</sup>
	Src Selects the modulation source of the effect balance	Off...Tempo
	Amt Sets the modulation amount of the effect balance	-100...+100

**b: Pre Delay [msec], b: Pre Delay Thru [%]**

The “Pre Delay” sets the delay time to the reverb input, allowing you to control spaciousness. Using the “Pre Delay Thru” parameter, you can mix the dry sound without delay, emphasizing the attack of the sound.

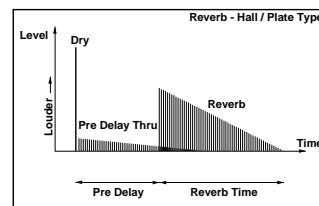

## 056: Reverb Room

This room-type reverb emphasizes the early reflections that make the sound tighter. Changing the balance between the early reflections and reverb sound allows you to simulate nuances, such as the type of walls of a room.

## 057: Reverb BrightRoom

This room-type reverb emphasizes the early reflections that make the sound brighter. See 056: Reverb Room.

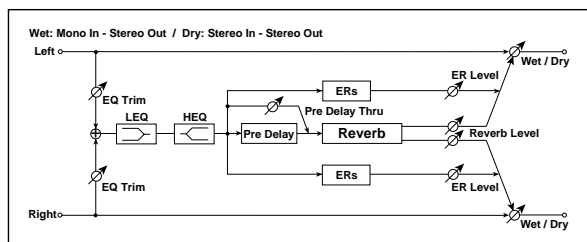

a	Reverb Time [sec] Sets the reverberation time	0.1...3.0sec
	High Damp [%] Sets the damping amount in the high range	0...100%
b	Pre Delay [msec] Sets the delay time from the dry sound	0...200msec Fx:052
	Pre Delay Thru [%] Sets the mix ratio of non-delay sound	0...100% Fx:052
c	ER Level Sets the level of early reflections	0...100 Fx
d	Reverb Level Sets the reverberation level	0...100 Fx
e	EQ Trim Sets the EQ input level	0...100
	Pre LEQ Gain [dB] Sets the gain of Low EQ	-15...+15dB
f	Pre HEQ Gain [dB] Sets the gain of High EQ	-15...+15dB
	Wet/Dry Sets the balance between the effect and dry sounds	Dry, 1:99...99:1, Wet D <sup>mod</sup>
g	Src Selects the modulation source of the effect balance	Off...Tempo
	Amt Sets the modulation amount of the effect balance	-100...+100

### c: ER Level, d: Reverb Level

These parameters set the early reflection level and reverb level. Changing these parameter values allows you to simulate the type of walls in the room. That is, a larger "ER Level" simulates a hard wall, and a larger "Reverb Level" simulates a soft wall.

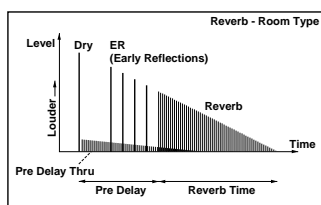

## Mono – Mono Chain

Effects that combine two mono effects connected in series

## 058: P4EQ – Exciter

(Parametric 4-Band EQ – Exciter)

This effect combines a mono-type four-band parametric equalizer and an exciter.

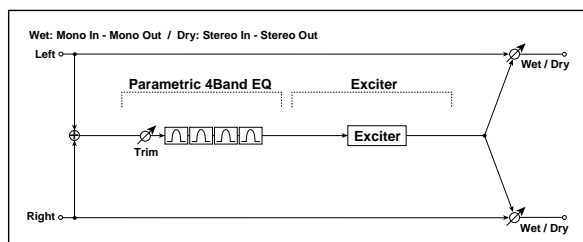

a	[E] Trim Sets the parametric EQ input level	0...100
	[E] Band1 Cutoff [Hz] Sets the center frequency of Band 1	20...1.00kHz
b	Q Sets the bandwidth of Band 1	0.5...10.0 Fx:006
	Gain [dB] Sets the gain of Band 1	-18...+18dB
	[E] Band2 Cutoff [Hz] Sets the center frequency of Band 2	50...5.00kHz
c	Q Sets the bandwidth of Band 2	0.5...10.0 Fx:006
	Gain [dB] Sets the gain of Band 2	-18...+18dB
	[E] Band3 Cutoff [Hz] Sets the center frequency for Band 3	300...10.00kHz
d	Q Sets the bandwidth of Band 3	0.5...10.0 Fx:006
	Gain [dB] Sets the gain of Band 3	-18...+18dB
	[E] Band4 Cutoff [Hz] Sets the center frequency for Band 4	500...20.00kHz
e	Q Sets the bandwidth of Band 4	0.5...10.0 Fx:006
	Gain [dB] Sets the gain of Band 4	-18...+18dB
	[X] Exciter Blend Sets the intensity (depth) of the Exciter effect	-100...+100 Fx:011
g	[X] Emphatic Point Sets the frequency range to be emphasized	0...70 Fx:011
	Wet/Dry Sets the balance between the effect and dry sounds	Dry, 1:99...99:1, Wet D <sup>mod</sup>
	Src Selects the modulation source of the effect balance	Off...Tempo
h	Amt Sets the modulation amount of the effect balance	-100...+100

## 059: P4EQ – Wah

(Parametric 4-Band EQ – Wah/Auto Wah)

This effect combines a mono-type four-band parametric equalizer and a wah. You can change the order of the connection.

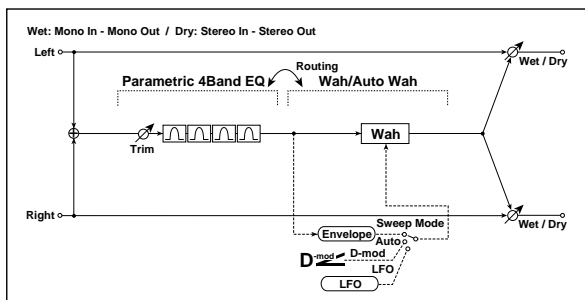

a	[E] Trim Sets the parametric EQ input level	0...100
b	[E] Band1 Cutoff [Hz] Sets the center frequency of Band 1	20...1.00kHz
	Q Sets the bandwidth of Band 1	0.5...10.0 Fx:006
	Gain [dB] Sets the gain of Band 1	-18...+18dB
c	[E] Band2 Cutoff [Hz] Sets the center frequency of Band 2	50...5.00kHz
	Q Sets the bandwidth of Band 2	0.5...10.0 Fx:006
	Gain [dB] Sets the gain of Band 2	-18...+18dB
d	[E] Band3 Cutoff [Hz] Sets the center frequency for Band 3	300...10.00kHz
	Q Sets the bandwidth of Band 3	0.5...10.0 Fx:006
	Gain [dB] Sets the gain of Band 3	-18...+18dB
e	[E] Band4 Cutoff [Hz] Sets the center frequency for Band 4	500...20.00kHz
	Q Sets the bandwidth of Band 4	0.5...10.0 Fx:006
	Gain [dB] Sets the gain of Band 4	-18...+18dB
f	[W] Frequency Bottom Sets the lower limit of the wah center frequency	0...100 Fx:009
	Frequency Top Sets the upper limit of the wah center frequency	0...100 Fx:009
g	[W] Sweep Mode Selects the control from auto-wah, modulation source, and LFO	Auto, D-mod, LFO Fx:009, D-mod
	Src Selects the modulation source for the wah when Sweep Mode=D-mod	Off...Tempo
h	[W] LFO Frequency [Hz] Sets the LFO speed	0.02...20.00Hz
	Resonance Sets the resonance amount	0...100
	LPF Switches the wah low pass filter on and off	Off, On
i	Routing Changes the order of the parametric equalizer and wah connection	PEQ → WAH, WAH → PEQ
j	Wet/Dry Sets the balance between the effect and dry sounds	Dry, 1:99...99:1, Wet D-mod
	Src Selects the modulation source of the effect balance	Off...Tempo
	Amt Sets the modulation amount of the effect balance	-100...+100

## 060: P4EQ – Cho/Flng

(Parametric 4-Band EQ – Chorus/Flanger)

This effect combines a mono-type four-band parametric equalizer and a chorus/flanger.

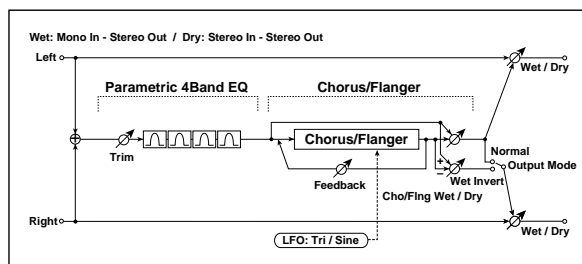

a	[E] Trim Sets the parametric EQ input level	0...100
b	[E] Band1 Cutoff [Hz] Sets the center frequency of Band 1	20...1.00kHz
	Q Sets the bandwidth of Band 1	0.5...10.0 Fx:006
	Gain [dB] Sets the gain of Band 1	-18...+18dB
c	[E] Band2 Cutoff [Hz] Sets the center frequency of Band 2	50...5.00kHz
	Q Sets the bandwidth of Band 2	0.5...10.0 Fx:006
	Gain [dB] Sets the gain of Band 2	-18...+18dB
d	[E] Band3 Cutoff [Hz] Sets the center frequency for Band 3	300...10.00kHz
	Q Sets the bandwidth of Band 3	0.5...10.0 Fx:006
	Gain [dB] Sets the gain of Band 3	-18...+18dB
e	[E] Band4 Cutoff [Hz] Sets the center frequency for Band 4	500...20.00kHz
	Q Sets the bandwidth of Band 4	0.5...10.0 Fx:006
	Gain [dB] Sets the gain of Band 4	-18...+18dB
f	[F] Delay Time [msec] Sets the delay time	0.0...50.0msec
g	[F] LFO Frequency [Hz] Sets the LFO speed	0.02...20.00Hz
	LFO Waveform Selects LFO Waveform	Triangle, Sine
h	[F] Depth Sets the depth of LFO modulation	0...100
	Feedback Sets the feedback amount	-100...+100 Fx:020
i	[F] Cho/Flng Wet/Dry Sets the effect balance of the chorus/flanger	-Wet...-2:98, Dry, 2:98...Wet Fx:010, 020
	Output Mode Selects the output mode for the chorus/flanger	Normal, Wet Invert Fx
j	Wet/Dry Sets the balance between the effect and dry sounds	Dry, 1:99...99:1, Wet D-mod
	Src Selects the modulation source of the effect balance	Off...Tempo
	Amt Sets the modulation amount of the effect balance	-100...+100

### i: Output Mode

When **Wet Invert** is selected, the right channel phase of the chorus/flanger effect sound is inverted. This creates pseudo-stereo effects and adds spread.

However, if a mono-input type effect is connected after this effect, the left and right sounds may cancel each other, eliminating the chorus/flanger effects.

## 061: P4EQ – Phaser

(Parametric 4-Band EQ – Phaser)

This effect combines a mono-type four-band parametric equalizer and a phaser.

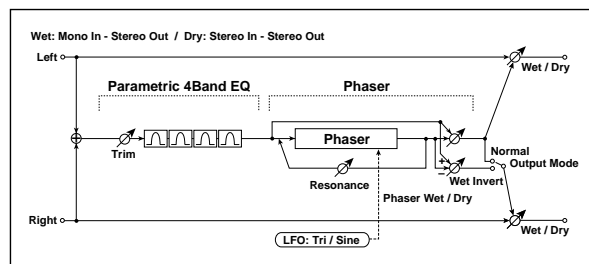

a	[E] Trim Sets the parametric EQ input level	0...100
b	[E] Band1 Cutoff [Hz] Sets the center frequency of Band 1	20...1.00kHz
	Q Sets the bandwidth of Band 1	0.5...10.0 Fx:006
	Gain [dB] Sets the gain of Band 1	-18...+18dB
c	[E] Band2 Cutoff [Hz] Sets the center frequency of Band 2	50...5.00kHz
	Q Sets the bandwidth of Band 2	0.5...10.0 Fx:006
	Gain [dB] Sets the gain of Band 2	-18...+18dB
d	[E] Band3 Cutoff [Hz] Sets the center frequency for Band 3	300...10.00kHz
	Q Sets the bandwidth of Band 3	0.5...10.0 Fx:006
	Gain [dB] Sets the gain of Band 3	-18...+18dB
e	[E] Band4 Cutoff [Hz] Sets the center frequency for Band 4	500...20.00kHz
	Q Sets the bandwidth of Band 4	0.5...10.0 Fx:006
	Gain [dB] Sets the gain of Band 4	-18...+18dB
f	[P] LFO Frequency [Hz] Sets the LFO speed	0.02...20.00Hz
	LFO Waveform Selects LFO Waveform	Triangle, Sine
g	[P] Manual Sets the frequency to which the effect is applied	0...100
h	[P] Depth Sets the depth of LFO modulation	0...100
	Resonance Sets the resonance amount	-100...+100 Fx:023
i	[P] Phaser Wet/Dry Sets the phaser effect balance	-Wet...-2:98, Dry, 2:98...Wet Fx:010, 023
	Output Mode Selects the phaser output mode	Normal, Wet Invert Fx:060
j	Wet/Dry Sets the balance between the effect and dry sounds	Dry, 1:99...99:1, Wet D <sup>mod</sup>
	Src Selects the modulation source of the effect balance	Off...Tempo
	Amt Sets the modulation amount of the effect balance	-100...+100

## 062: P4EQ – Mt. Delay

(Parametric 4-Band EQ – Multitap Delay)

This effect combines a mono-type four-band parametric equalizer and a multitap delay.

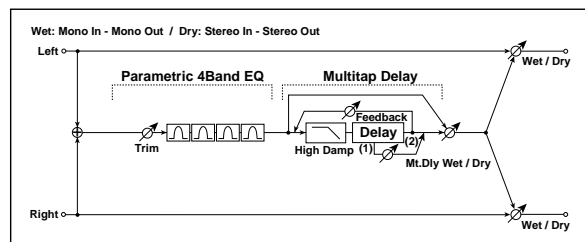

a	[E] Trim Sets the parametric EQ input level	0...100
b	[E] Band1 Cutoff [Hz] Sets the center frequency of Band 1	20...1.00kHz
	Q Sets the bandwidth of Band 1	0.5...10.0 Fx:006
	Gain [dB] Sets the gain of Band 1	-18...+18dB
c	[E] Band2 Cutoff [Hz] Sets the center frequency of Band 2	50...5.00kHz
	Q Sets the bandwidth of Band 2	0.5...10.0 Fx:006
	Gain [dB] Sets the gain of Band 2	-18...+18dB
d	[E] Band3 Cutoff [Hz] Sets the center frequency for Band 3	300...10.00kHz
	Q Sets the bandwidth of Band 3	0.5...10.0 Fx:006
	Gain [dB] Sets the gain of Band 3	-18...+18dB
e	[E] Band4 Cutoff [Hz] Sets the center frequency for Band 4	500...20.00kHz
	Q Sets the bandwidth of Band 4	0.5...10.0 Fx:006
	Gain [dB] Sets the gain of Band 4	-18...+18dB
f	[D] Tap1 Time [msec] Sets the Tap1 delay time	0...680msec
	Tap1 Level Sets the Tap1 output level	0...100 Fx:045
g	[D] Tap2 Time [msec] Sets the Tap2 delay time	0...680msec
	Feedback (Tap2) Sets the Tap2 feedback amount	-100...+100
h	[D] Mt.Delay Wet/Dry Sets the multitap delay effect balance	Dry, 2:98...98:2, Wet
	High Damp [%] Sets the damping amount in the high range	0...100% Fx:043
i	Wet/Dry Sets the balance between the effect and dry sounds	Dry, 1:99...99:1, Wet D <sup>mod</sup>
	Src Selects the modulation source of the effect balance	Off...Tempo
	Amt Sets the modulation amount of the effect balance	-100...+100

## 063: Comp – Wah

(Compressor – Wah/Auto Wah)

This effect combines a mono-type compressor and a wah. You can change the order of the connection.

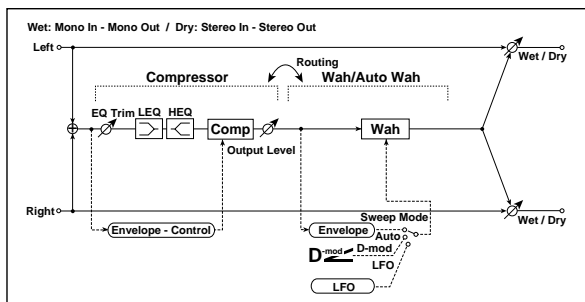

a	[C] Sensitivity Sets the sensitivity	1...100 Fx:002
b	[C] Attack Sets the attack level	1...100 Fx:002
	Output Level Sets the compressor output level	0...100 Fx:002
c	[C] EQ Trim Sets the EQ input level	0...100
d	[C] Pre LEQ Gain [dB] Sets the gain of Low EQ	-15...+15dB
	Pre HEQ Gain [dB] Sets the gain of High EQ	-15...+15dB
e	[W] Frequency Bottom Sets the lower limit of the wah center frequency	0...100 Fx:009
	Frequency Top Sets the upper limit of the wah center frequency	0...100 Fx:009
f	[W] Sweep Mode Selects the control from auto-wah, modulation source, and LFO	Auto, D-mod, LFO Fx:009, D-mod
	Src Selects the modulation source for the wah when Sweep Mode=D-mod	Off...Tempo
g	[W] LFO Frequency [Hz] Sets the LFO speed	0.02...20.00Hz
h	[W] Resonance Sets the resonance amount	0...100
	Low Pass Filter Switches the wah low pass filter on and off	Off, On
i	Routing Switches the order of the compressor and wah connection	CMP → WAH, WAH → CMP
j	Wet/Dry Sets the balance between the effect and dry sounds	Dry, 1:99...99:1, Wet D-mod
	Src Selects the modulation source of the effect balance	Off...Tempo
	Amt Sets the modulation amount of the effect balance	-100...+100

## 064: Comp – Amp Sim

(Compressor – Amp Simulation)

This effect combines a mono-type compressor and an amp simulation. You can change the order of the effect connection.

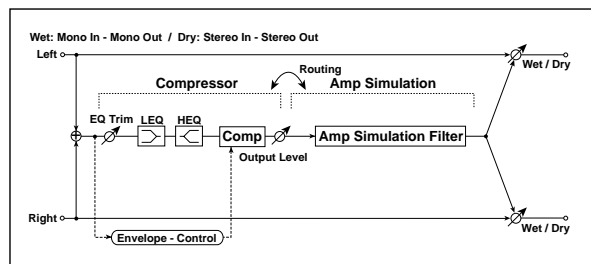

a	[C] Sensitivity Sets the sensitivity	1...100 Fx:002
b	[C] Attack Sets the attack level	1...100 Fx:002
	Output Level Sets the compressor output level	0...100 Fx:002
c	[C] EQ Trim Sets the EQ input level	0...100
d	[C] Pre LEQ Gain [dB] Sets the gain of Low EQ	-15...+15dB
	Pre HEQ Gain [dB] Sets the gain of High EQ	-15...+15dB
e	[A] Amplifier Type Selects the type of guitar amplifier	SS, EL84, 6L6
f	Routing Switches the order of the compressor and amp simulation connection	CMP → AMP, AMP → CMP
	Wet/Dry Sets the balance between the effect and dry sounds	Dry, 1:99...99:1, Wet D-mod
g	Src Selects the modulation source of the effect balance	Off...Tempo
	Amt Sets the modulation amount of the effect balance	-100...+100

## 065: Comp – OD/HiGain

(Compressor – Overdrive/Hi.Gain)

This effect combines a mono-type compressor and an overdrive/high-gain distortion. You can change the order of the effect connection.

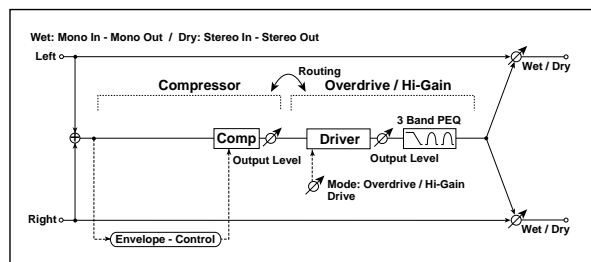

a	[C] Sensitivity Sets the sensitivity	1...100 Fx:002
b	[C] Attack Sets the attack level	1...100 Fx:002
	Output Level Sets the compressor output level	0...100 Fx:002
c	[O] Drive Mode Switches between overdrive and high-gain distortion	Overdrive, Hi-Gain
	Drive Sets the degree of distortion	1...100 Fx:006

d	[O] Output Level Sets the overdrive output level	0...50 Fx:006, D <sup>mod</sup>
	Src Selects the modulation source for the overdrive output level	Off...Tempo
	Amt Sets the modulation amount of the overdrive output level	-50...+50
e	[O] Low Cutoff [Hz] Sets the center frequency for Low EQ (shelving type)	20...1.00kHz
	Gain [dB] Sets the gain of Low EQ	-18...+18dB
f	[O] Mid1 Cutoff [Hz] Sets the center frequency for Mid/High EQ 1 (peaking type)	300...10.00kHz
	Q Sets the band width of Mid/High EQ 1	0.5...10.0 Fx:006
	Gain [dB] Sets the gain of Mid/High EQ 1	-18...+18dB
g	[O] Mid2 Cutoff [Hz] Sets the center frequency for Mid/High EQ 2 (peaking type)	500...20.00kHz
	Q Sets the band width of Mid/High EQ 2	0.5...10.0 Fx:006
	Gain [dB] Sets the gain of Mid/High EQ 2	-18...+18dB
h	Routing Switches the order of the compressor and overdrive connection	CMP → OD, OD → CMP
i	Wet/Dry Sets the balance between the effect and dry sounds	Dry, 1:99...99:1, Wet D <sup>mod</sup>
	Src Selects the modulation source of the effect balance	Off...Tempo
	Amt Sets the modulation amount of the effect balance	-100...+100

## 066: Comp – Param4EQ (Compressor – Parametric 4-Band EQ)

This effect combines a mono-type compressor and a four-band parametric equalizer. You can change the order of the effect connection.

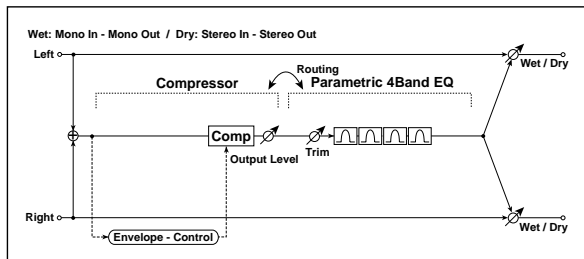

a	[C] Sensitivity Sets the sensitivity	1...100 Fx:002
	[C] Attack Sets the attack level	1...100 Fx:002
b	Output Level Sets the compressor output level	0...100 Fx:002
	[E] Trim Sets the parametric EQ input level	0...100
d	[E] Band1 Cutoff [Hz] Sets the center frequency of Band 1	20...1.00kHz
	Q Sets the bandwidth of Band 1	0.5...10.0 Fx:006
	Gain [dB] Sets the gain of Band 1	-18...+18dB
e	[E] Band2 Cutoff [Hz] Sets the center frequency of Band 2	50...5.00kHz
	Q Sets the bandwidth of Band 2	0.5...10.0 Fx:006
	Gain [dB] Sets the gain of Band 2	-18...+18dB

f	[E] Band3 Cutoff [Hz] Sets the center frequency for Band 3	300...10.00kHz
	Q Sets the bandwidth of Band 3	0.5...10.0 Fx:006
	Gain [dB] Sets the gain of Band 3	-18...+18dB
g	[E] Band4 Cutoff [Hz] Sets the center frequency for Band 4	500...20.00kHz
	Q Sets the bandwidth of Band 4	0.5...10.0 Fx:006
	Gain [dB] Sets the gain of Band 4	-18...+18dB
h	Routing Switches the order of the compressor and parametric EQ connection	CMP → PEQ, PEQ → CMP
i	Wet/Dry Sets the balance between the effect and dry sounds	Dry, 1:99...99:1, Wet D <sup>mod</sup>
	Src Selects the modulation source of the effect balance	Off...Tempo
	Amt Sets the modulation amount of the effect balance	-100...+100

## 067: Comp – Cho/Flng (Compressor – Chorus/Flanger)

This effect combines a mono-type compressor and a chorus/flanger. You can change the order of the effect connection.

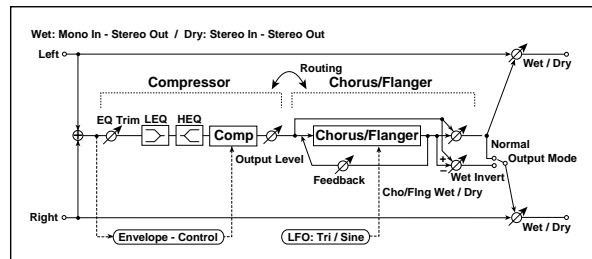

a	[C] Sensitivity Sets the sensitivity	1...100 Fx:002
	[C] Attack Sets the attack level	1...100 Fx:002
b	Output Level Sets the compressor output level	0...100 Fx:002
	[C] EQ Trim Sets the EQ input level	0...100
d	[C] Pre LEQ Gain [dB] Sets the gain of Low EQ	-15...+15dB
	Pre HEQ Gain [dB] Sets the gain of High EQ	-15...+15dB
e	[F] Delay Time [msec] Sets the delay time	0.0...50.0msec
f	[F] LFO Frequency [Hz] Sets the LFO speed	0.02...20.00Hz
	LFO Waveform Selects LFO Waveform	Triangle, Sine
g	[F] Depth Sets the depth of LFO modulation	0...100
	Feedback Sets the feedback amount	-100...+100 Fx:020
h	[F] Cho/Flng Wet/Dry Sets the effect balance of the chorus/flanger	-Wet...-2:98, Dry, 2:98...Wet Fx:010, 020
	Output Mode Selects the output mode for the chorus/flanger	Normal, Wet Invert Fx
i	Routing Switches the order of the compressor and chorus/flanger connection	CMP → FLNG, FLNG → CMP Fx



j	Wet/Dry Sets the balance between the effect and dry sounds	Dry, 1:99...99:1, Wet	
	Src Selects the modulation source of the effect balance	Off...Tempo	
	Amt Sets the modulation amount of the effect balance	-100...+100	

#### h: Output Mode, i: Routing

When **Wet Invert** is selected, the right channel phase of the chorus/flanger effect sound is inverted. This creates pseudo-stereo effects and adds spread.

However, if a mono-input type effect is connected after this effect, the left and right sounds may cancel each other, eliminating the chorus/flanger effects.

When "Routing" is set to **FLNG→CMP**, "Output Mode" will be set to **Normal**.

## 068: Comp - Phaser

### (Compressor - Phaser)

This effect combines a mono-type compressor and a phaser. You can change the order of the effect connection.

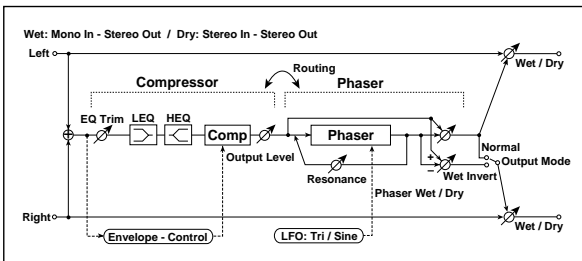

a	[C] Sensitivity Sets the sensitivity	1...100	Fx:002
	[C] Attack Sets the attack level	1...100	Fx:002
b	Output Level Sets the compressor output level	0...100	Fx:002
	[C] EQ Trim Sets the EQ input level	0...100	
d	[C] Pre LEQ Gain [dB] Sets the gain of Low EQ	-15...+15dB	
	Pre HEQ Gain [dB] Sets the gain of High EQ	-15...+15dB	
e	[P] LFO Frequency [Hz] Sets the LFO speed	0.02...20.00Hz	
	LFO Waveform Selects LFO Waveform	Triangle, Sine	
f	[P] Manual Sets the frequency to which the effect is applied	0...100	
g	[P] Depth Sets the depth of LFO modulation	0...100	
	Resonance Sets the resonance amount	-100...+100	Fx:023
h	[P] Phaser Wet/Dry Sets the phaser effect balance	-Wet...-2:98, Dry, 2:98...Wet	Fx:010, 023
	Output Mode Selects the phaser output mode	Normal, Wet Invert	Fx:067
i	Routing Switches the order of the compressor and phaser connection	CMP→PHS, PHS→CMP	Fx:067
j	Wet/Dry Sets the balance between the effect and dry sounds	Dry, 1:99...99:1, Wet	
	Src Selects the modulation source of the effect balance	Off...Tempo	
	Amt Sets the modulation amount of the effect balance	-100...+100	

## 069: Comp - Mt. Delay

### (Compressor - Multitap Delay)

This effect combines a mono-type compressor and a multitap delay. You can change the order of the effect connection.

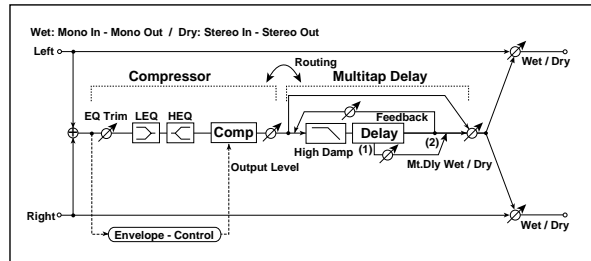

a	[C] Sensitivity Sets the sensitivity	1...100	Fx:002
	[C] Attack Sets the attack level	1...100	Fx:002
b	Output Level Sets the compressor output level	0...100	Fx:002
	[C] EQ Trim Sets the EQ input level	0...100	
d	[C] Pre LEQ Gain [dB] Sets the gain of Low EQ	-15...+15dB	
	Pre HEQ Gain [dB] Sets the gain of High EQ	-15...+15dB	
e	[D] Tap1 Time [msec] Sets the Tap1 delay time	0...680msec	
	Tap1 Level Sets the Tap1 output level	0...100	Fx:045
f	[D] Tap2 Time [msec] Sets the Tap2 delay time	0...680msec	
	Feedback (Tap2) Sets the Tap2 feedback amount	-100...+100	
g	[D] High Damp [%] Sets the damping amount in the high range	0...100%	Fx:043
h	[D] Mt.Delay Wet/Dry Sets the multitap delay effect balance	Dry, 1:99...99:1, Wet	
i	Routing Switches the order of the compressor and multitap delay connection	CMP→DLY, DLY→CMP	
j	Wet/Dry Sets the balance between the effect and dry sounds	Dry, 1:99...99:1, Wet	
	Src Selects the modulation source of the effect balance	Off...Tempo	
	Amt Sets the modulation amount of the effect balance	-100...+100	

## 070: Limiter – P4EQ

(Limiter – Parametric 4-Band EQ)

This effect combines a mono-type limiter and a four-band parametric equalizer. You can change the order of the effect connection.

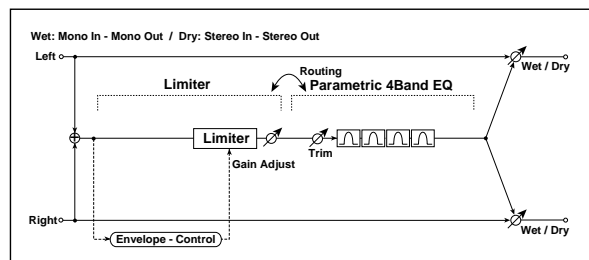

a	[L] Ratio Sets the signal compression ratio	1.0:1...50.0:1, Inf:1 Fx:003
	Threshold [dB] Sets the level above which the compressor is applied	-40...0dB Fx:003
b	[L] Attack Sets the attack time	1...100 Fx:003
	Release Sets the release time	1...100 Fx:003
c	[L] Gain Adjust [dB] Sets the limiter output gain	-Inf, -38...+24dB Fx:003
d	[E] Trim Sets the parametric EQ input level	0...100
e	[E] Band1 Cutoff [Hz] Sets the center frequency of Band 1	20...1.00kHz
	Q Sets the bandwidth of Band 1	0.5...10.0 Fx:006
	Gain [dB] Sets the gain of Band 1	-18...+18dB
f	[E] Band2 Cutoff [Hz] Sets the center frequency of Band 2	50...5.00kHz
	Q Sets the bandwidth of Band 2	0.5...10.0 Fx:006
	Gain [dB] Sets the gain of Band 2	-18...+18dB
g	[E] Band3 Cutoff [Hz] Sets the center frequency for Band 3	300...10.00kHz
	Q Sets the bandwidth of Band 3	0.5...10.0 Fx:006
	Gain [dB] Sets the gain of Band 3	-18...+18dB
h	[E] Band4 Cutoff [Hz] Sets the center frequency for Band 4	500...20.00kHz
	Q Sets the bandwidth of Band 4	0.5...10.0 Fx:006
	Gain [dB] Sets the gain of Band 4	-18...+18dB
i	Routing Switches the order of the limiter and parametric EQ connection	LMT→PEQ, PEQ→LMT
j	Wet/Dry Sets the balance between the effect and dry sounds	Dry, 1:99...99:1, Wet D <sup>mod</sup>
	Src Selects the modulation source of the effect balance	Off...Tempo
	Amt Sets the modulation amount of the effect balance	-100...+100

## 071: Limiter – Cho/Flng

(Limiter – Chorus/Flanger)

This effect combines a mono-type limiter and a chorus/flanger. You can change the order of the effect connection.

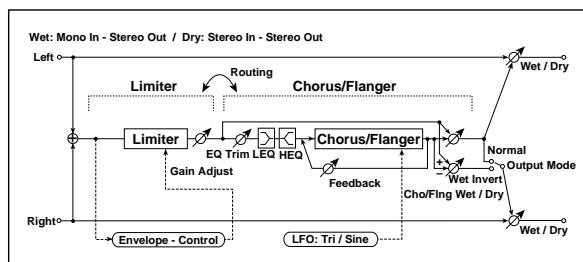

a	[L] Ratio Sets the signal compression ratio	1.0:1...50.0:1, Inf:1 Fx:003
	Threshold [dB] Sets the level above which the compressor is applied	-40...0dB Fx:003
b	[L] Attack Sets the attack time	1...100 Fx:003
	Release Sets the release time	1...100 Fx:003
c	[L] Gain Adjust [dB] Sets the limiter output gain	-Inf, -38...+24dB Fx:003
d	[F] LFO Frequency [Hz] Sets the LFO speed	0.02...20.00Hz
	LFO Waveform Selects LFO Waveform	Triangle, Sine
e	[F] Delay Time [msec] Sets the delay time	0.0...50.0msec
	Depth Sets the depth of LFO modulation	0...100
	Feedback Sets the feedback amount	-100...+100 Fx:020
f	[F] EQ Trim Sets the EQ input level	0...100
	[F] Pre LEQ Gain [dB] Sets the gain of Low EQ	-15...+15dB
g	Pre HEQ Gain [dB] Sets the gain of High EQ	-15...+15dB
	[F] Cho/Flng Wet/Dry Sets the effect balance of the chorus/flanger	-Wet...-2:98, Dry, 2:98...Wet Fx:010, 020
h	Output Mode Selects the output mode for the chorus/flanger	Normal, Wet Invert Fx:067
	Routing Switches the order of the limiter and chorus/flanger connection	LMT→FLNG, FLNG→LMT Fx:067
j	Wet/Dry Sets the balance between the effect and dry sounds	Dry, 1:99...99:1, Wet D <sup>mod</sup>
	Src Selects the modulation source of the effect balance	Off...Tempo
	Amt Sets the modulation amount of the effect balance	-100...+100

## 072: Limiter – Phaser

This effect combines a mono-type limiter and a phaser. You can change the order of the effect connection.

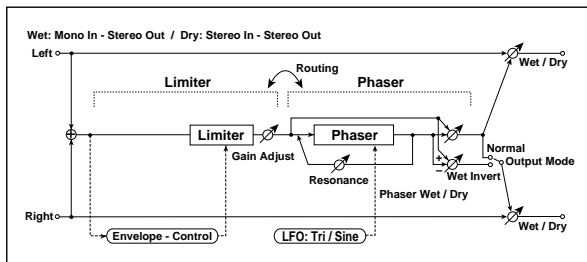

a	[L] Ratio Sets the signal compression ratio	1.0:1...50.0:1, Inf:1 Fx:003
	Threshold [dB] Sets the level above which the compressor is applied	-40...0dB Fx:003
b	[L] Attack Sets the attack time	1...100 Fx:003
	Release Sets the release time	1...100 Fx:003
c	[L] Gain Adjust [dB] Sets the limiter output gain	-Inf, -38...+24dB Fx:003
d	[P] LFO Frequency [Hz] Sets the LFO speed	0.02...20.00Hz
	LFO Waveform Selects LFO Waveform	Triangle, Sine
e	[P] Manual Sets the frequency to which the effect is applied	0...100
f	[P] Depth Sets the depth of LFO modulation	0...100
	Resonance Sets the resonance amount	-100...+100 Fx:023
g	[P] Phaser Wet/Dry Sets the phaser effect balance	-Wet...-2:98, Dry, 2:98...Wet Fx:010, 023
	Output Mode Selects the phaser output mode	Normal, Wet Invert Fx:067
h	Routing Switches the order of the limiter and phaser connection	LMT→PHS, PHS→LMT Fx:067
i	Wet/Dry Sets the balance between the effect and dry sounds	Dry, 1:99...99:1, Wet D-mod
	Src Selects the modulation source of the effect balance	Off...Tempo
	Amt Sets the modulation amount of the effect balance	-100...+100

## 073: Limiter – Mt. Delay (Limiter – Multitap Delay)

This effect combines a mono-type limiter and a multitap delay. You can change the order of the effect connection.

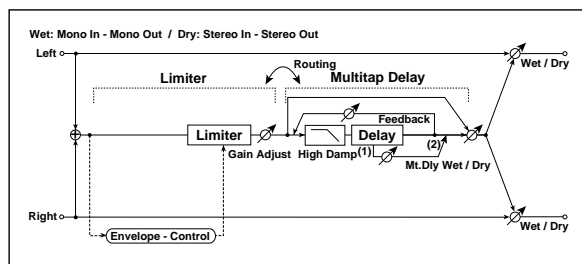

a	[L] Ratio Sets the signal compression ratio	1.0:1...50.0:1, Inf:1 Fx:003
	Threshold [dB] Sets the level above which the compressor is applied	-40...0dB Fx:003
b	[L] Attack Sets the attack time	1...100 Fx:003
	Release Sets the release time	1...100 Fx:003
c	[L] Gain Adjust [dB] Sets the limiter output gain	-Inf, -38...+24dB Fx:003
d	[D] Tap1 Time [msec] Sets the Tap1 delay time	0...680msec
	Tap1 Level Sets the Tap1 output level	0...100 Fx:045
e	[D] Tap2 Time [msec] Sets the Tap2 delay time	0...680msec
	Feedback (Tap2) Sets the Tap2 feedback amount	-100...+100
f	[D] Mt.Delay Wet/Dry Sets the multitap delay effect balance	Dry, 1:99...99:1, Wet
	High Damp [%] Sets the damping amount in the high range	0...100% Fx:043
g	Routing Switches the order of the limiter and multitap delay connection	LMT→DLY, DLY→LMT
h	Wet/Dry Sets the balance between the effect and dry sounds	Dry, 1:99...99:1, Wet D-mod
	Src Selects the modulation source of the effect balance	Off...Tempo
	Amt Sets the modulation amount of the effect balance	-100...+100

## 074: Exciter – Comp (Exciter – Compressor)

This effect combines a mono-type exciter and a compressor. You can change the order of the effect connection.

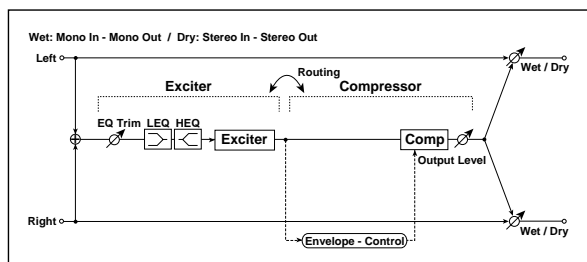

a	[X] Exciter Blend Sets the intensity (depth) of the Exciter effect	-100...+100 Fx:011
b	[X] Emphatic Point Sets the frequency range to be emphasized	0...70 Fx:011
c	[X] EQ Trim Sets the EQ input level	0...100
d	[X] Pre LEQ Gain [dB] Sets the gain of Low EQ	-15...+15dB
	Pre HEQ Gain [dB] Sets the gain of High EQ	-15...+15dB
e	[C] Sensitivity Sets the sensitivity	1...100 Fx:002
f	[C] Attack Sets the attack level	1...100 Fx:002
	Output Level Sets the compressor output level	0...100 Fx:002
g	Routing Switches the order of the exciter and compressor connection	XCT→CMP, CMP→XCT
h	Wet/Dry Sets the balance between the effect and dry sounds	Dry, 1:99...99:1, Wet D <sup>mod</sup>
	Src Selects the modulation source of the effect balance	Off...Tempo
	Amt Sets the modulation amount of the effect balance	-100...+100

## 075: Exciter – Limiter

This effect combines a mono-type exciter and a limiter. You can change the order of the effect connection.

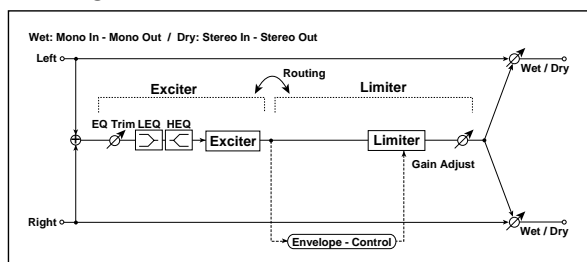

a	[X] Exciter Blend Sets the intensity (depth) of the Exciter effect	-100...+100 Fx:011
b	[X] Emphatic Point Sets the frequency range to be emphasized	0...70 Fx:011
c	[X] EQ Trim Sets the EQ input level	0...100
d	[X] Pre LEQ Gain [dB] Sets the gain of Low EQ	-15...+15dB
	Pre HEQ Gain [dB] Sets the gain of High EQ	-15...+15dB
e	[L] Ratio Sets the signal compression ratio	1.0:1...50.0:1, Inf:1 Fx:003

f	[L] Threshold [dB] Sets the level above which the compressor is applied	-40...0dB Fx:003
	[L] Attack Sets the attack time	1...100 Fx:003
g	Release Sets the release time	1...100 Fx:003
	[L] Gain Adjust [dB] Sets the limiter output gain	-Inf, -38...+24dB Fx:003
i	Routin Switches the order of the exciter and limiter connection	XCT→LMT, LMT→XCT
j	Wet/Dry Sets the balance between the effect and dry sounds	Dry, 1:99...99:1, Wet D <sup>mod</sup>
	Src Selects the modulation source of the effect balance	Off...Tempo
	Amt Sets the modulation amount of the effect balance	-100...+100

## 076: Exciter – Cho/Flng (Exciter – Chorus/Flanger)

This effect combines a mono-type limiter and a chorus/flanger.

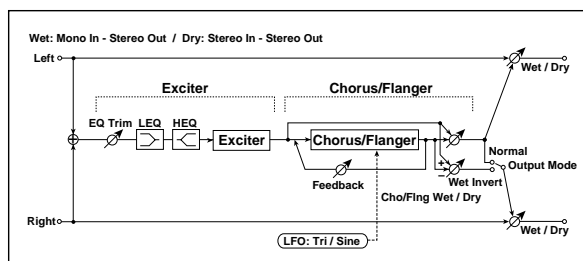

a	[X] Exciter Blend Sets the intensity (depth) of the Exciter effect	-100...+100 Fx:011
b	[X] Emphatic Point Sets the frequency range to be emphasized	0...70 Fx:011
c	[X] EQ Trim Sets the EQ input level	0...100
d	[X] Pre LEQ Gain [dB] Sets the gain of Low EQ	-15...+15dB
	Pre HEQ Gain [dB] Sets the gain of High EQ	-15...+15dB
e	[F] Delay Time [msec] Sets the delay time	0.0...50.0msec
f	[F] LFO Frequency [Hz] Sets the LFO speed	0.02...20.00Hz
	LFO Waveform Selects LFO Waveform	Triangle, Sine
g	[F] Depth Sets the depth of LFO modulation	0...100
	Feedback Sets the feedback amount	-100...+100 Fx:020
h	[F] Cho/Flng Wet/Dry Sets the effect balance of the chorus/flanger	-Wet...-2:98, Dry, 2:98...Wet Fx:010, 020
	Output Mode Selects the output mode for the chorus/flanger	Normal, Wet Invert Fx:060
i	Wet/Dry Sets the balance between the effect and dry sounds	Dry, 1:99...99:1, Wet D <sup>mod</sup>
	Src Selects the modulation source of the effect balance	Off...Tempo
	Amt Sets the modulation amount of the effect balance	-100...+100

## 077: Exciter – Phaser

This effect combines a mono-type limiter and a phaser.

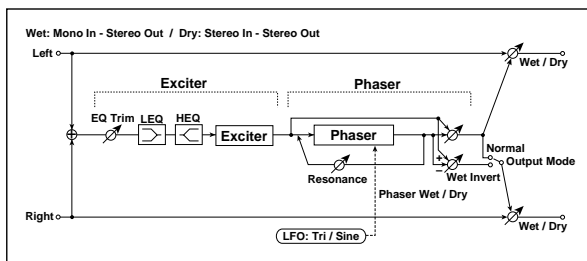

a	[X] Exciter Blend Sets the intensity (depth) of the Exciter effect	-100...+100 Fx:011
b	[X] Emphatic Point Sets the frequency range to be emphasized	0...70 Fx:011
c	[X] EQ Trim Sets the EQ input level	0...100
d	[X] Pre LEQ Gain [dB] Sets the gain of Low EQ	-15...+15dB
	Pre HEQ Gain [dB] Sets the gain of High EQ	-15...+15dB
e	[P] LFO Frequency [Hz] Sets the LFO speed	0.02...20.00Hz
	LFO Waveform Selects LFO Waveform	Triangle, Sine
f	[P] Manual Sets the frequency to which the effect is applied	0...100
g	[P] Depth Sets the depth of LFO modulation	0...100
	Resonance Sets the resonance amount	-100...+100 Fx:023
h	[P] Phaser Wet/Dry Sets the phaser effect balance	-Wet...-2:98, Dry, 2:98...Wet Fx:010, 023
	Output Mode Selects the phaser output mode	Normal, Wet Invert Fx:060
i	Wet/Dry Sets the balance between the effect and dry sounds	Dry, 1:99...99:1, Wet D-mod
	Src Selects the modulation source of the effect balance	Off...Tempo
	Amt Sets the modulation amount of the effect balance	-100...+100

## 078: Exciter – Mt. Delay (Exciter – Multitap Delay)

This effect combines a mono-type exciter and a multitap delay.

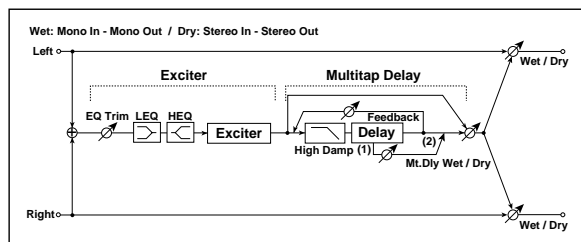

a	[X] Exciter Blend Sets the intensity (depth) of the Exciter effect	-100...+100 Fx:011
b	[X] Emphatic Point Sets the frequency range to be emphasized	0...70 Fx:011
c	[X] EQ Trim Sets the EQ input level	0...100
d	[X] Pre LEQ Gain [dB] Sets the gain of Low EQ	-15...+15dB
	Pre HEQ Gain [dB] Sets the gain of High EQ	-15...+15dB
e	[D] Tap1 Time [msec] Sets the Tap1 delay time	0...680msec
	Tap1 Level Sets the Tap1 output level	0...100 Fx:045
f	[D] Tap2 Time [msec] Sets the Tap2 delay time	0...680msec
	Feedback (Tap2) Sets the Tap2 feedback amount	-100...+100
g	[D] High Damp [%] Sets the damping amount in the high range	0...100% Fx:043
h	[D] Mt.Delay Wet/Dry Sets the multitap delay effect balance	Dry, 1:99...99:1, Wet
i	Wet/Dry Sets the balance between the effect and dry sounds	Dry, 1:99...99:1, Wet D-mod
	Src Selects the modulation source of the effect balance	Off...Tempo
	Amt Sets the modulation amount of the effect balance	-100...+100

## 079: OD/HG – Amp Sim (Overdrive/Hi.Gain – Amp Simulation)

This effect combines a mono-type overdrive/high-gain distortion and an amp simulation. You can change the order of the effect connection.

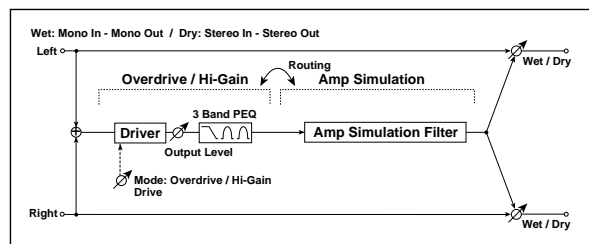

a	[O] Drive Mode	Overdrive, Hi-Gain
	Switches between overdrive and high-gain distortion	
b	Drive	1...100
	Sets the degree of distortion <small>Fx:006</small>	
c	[O] Output Level	0...50
	Sets the overdrive output level <small>Fx:006, D<sup>mod</sup></small>	
	Src	Off...Tempo
d	Amt	-50...+50
	Sets the modulation amount of the overdrive output level	
e	[O] Low Cutoff [Hz]	20...1.00kHz
	Sets the center frequency for Low EQ (shelving type)	
	Gain [dB]	-18...+18dB
f	[O] Mid1 Cutoff [Hz]	300...10.00kHz
	Sets the center frequency for Mid/High EQ 1 (peaking type)	
	Q	0.5...10.0
g	Gain [dB]	-18...+18dB
	Sets the gain of Mid/High EQ 1	
	[O] Mid2 Cutoff [Hz]	500...20.00kHz
h	Q	0.5...10.0
	Sets the band width of Mid/High EQ 2 <small>Fx:006</small>	
	Gain [dB]	-18...+18dB
i	Sets the gain of Mid/High EQ 2	
	[A] Amplifier Type	SS, EL84, 6L6
j	Routing	OD→AMP, AMP→OD
	Switches the order of the overdrive and amp simulation connection	
k	Wet/Dry	Dry, 1:99...99:1, Wet
	Sets the balance between the effect and dry sounds <small>D<sup>mod</sup></small>	
	Src	Off...Tempo
	Amt	-100...+100
Sets the modulation amount of the effect balance		

## 080: OD/HG – Cho/Flng (Overdrive/Hi.Gain – Chorus/Flanger)

This effect combines a mono-type overdrive/high-gain distortion and a chorus/flanger. You can change the order of the effect connection.

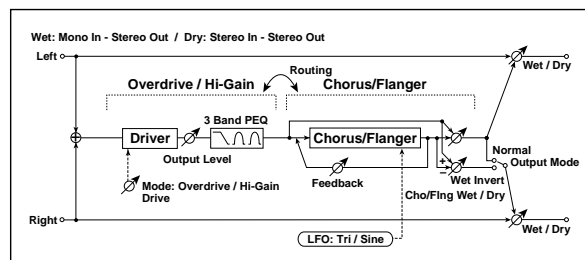

a	[O] Drive Mode	Overdrive, Hi-Gain
	Switches between overdrive and high-gain distortion	
b	Drive	1...100
	Sets the degree of distortion <small>Fx:006</small>	
c	[O] Output Level	0...50
	Sets the overdrive output level <small>Fx:006, D<sup>mod</sup></small>	
	Src	Off...Tempo
d	Amt	-50...+50
	Sets the modulation amount of the overdrive output level	
e	[O] Low Cutoff [Hz]	20...1.00kHz
	Sets the center frequency for Low EQ (shelving type)	
	Gain [dB]	-18...+18dB
f	[O] Mid1 Cutoff [Hz]	300...10.00kHz
	Sets the center frequency for Mid/High EQ 1 (peaking type)	
	Q	0.5...10.0
g	Gain [dB]	-18...+18dB
	Sets the gain of Mid/High EQ 1	
	[O] Mid2 Cutoff [Hz]	500...20.00kHz
h	Q	0.5...10.0
	Sets the band width of Mid/High EQ 2 <small>Fx:006</small>	
	Gain [dB]	-18...+18dB
i	Sets the gain of Mid/High EQ 2	
	[F] LFO Frequency [Hz]	0.02...20.00Hz
j	Sets the LFO speed	
	LFO Waveform	Triangle, Sine
	Selects LFO Waveform	
	[F] Delay Time [msec]	0.0...50.0msec
k	Sets the delay time	
	Depth	0...100
	Feedback	-100...+100
Sets the feedback amount <small>Fx:020</small>		
l	[F] Cho/Flng Wet/Dry	-Wet...-2:98, Dry, 2:98...Wet
	Sets the effect balance of the chorus/flanger <small>Fx:010, 020</small>	
m	Output Mode	Normal, Wet Invert
	Selects the output mode for the chorus/flanger <small>Fx:067</small>	
n	Routing	OD → FLNG, FLNG → OD
	Switches the order of the overdrive and chorus/flanger connection <small>Fx:067</small>	
o	Wet/Dry	Dry, 1:99...99:1, Wet
	Sets the balance between the effect and dry sounds <small>D<sup>mod</sup></small>	
	Src	Off...Tempo
	Amt	-100...+100
Sets the modulation amount of the effect balance		

Effect

## 081: OD/HG – Phaser (Overdrive/Hi.Gain – Phaser)

This effect combines a mono-type overdrive/high-gain distortion and a phaser. You can change the order of the effect connection.

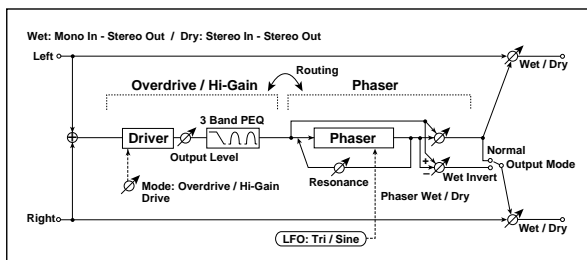

a	[O] Drive Mode	Overdrive, Hi-Gain
	Switches between overdrive and high-gain distortion	
b	Drive	1...100
	Sets the degree of distortion <span style="float:right">Fx:006</span>	
c	[O] Output Level	0...50
	Sets the overdrive output level <span style="float:right">Fx:006, </span>	
	Src	Off...Tempo
d	Amt	-50...+50
	Sets the modulation amount of the overdrive output level	
e	[O] Low Cutoff [Hz]	20...1.00kHz
	Sets the center frequency for Low EQ (shelving type)	
	Gain [dB]	-18...+18dB
f	[O] Mid1 Cutoff [Hz]	300...10.00kHz
	Sets the center frequency for Mid/High EQ 1 (peaking type)	
	Q	0.5...10.0
g	Sets the band width of Mid/High EQ 1 <span style="float:right">Fx:006</span>	
	Gain [dB]	-18...+18dB
	[O] Mid2 Cutoff [Hz]	500...20.00kHz
h	Sets the center frequency for Mid/High EQ 2 (peaking type)	
	Q	0.5...10.0
	Sets the band width of Mid/High EQ 2 <span style="float:right">Fx:006</span>	
i	Gain [dB]	-18...+18dB
	[P] LFO Frequency [Hz]	0.02...20.00Hz
	Sets the LFO speed	
j	LFO Waveform	Triangle, Sine
	[P] Manual	0...100
	Sets the frequency to which the effect is applied	
k	Depth	0...100
	Sets the depth of LFO modulation	
	Resonance	-100...+100
l	Sets the resonance amount <span style="float:right">Fx:023</span>	
	[P] Phaser Wet/Dry	-Wet...-2:98, Dry, 2:98...Wet
	Sets the phaser effect balance <span style="float:right">Fx:010, 023</span>	
m	Output Mode	Normal, Wet Invert
	Selects the phaser output mode <span style="float:right">Fx:067</span>	
n	Routing	OD → PHS, PHS → OD
	Switches the order of the overdrive and phaser connection <span style="float:right">Fx:067</span>	
o	Wet/Dry	Dry, 1:99...99:1, Wet
	Sets the balance between the effect and dry sounds <span style="float:right"></span>	
	Src	Off...Tempo
p	Selects the modulation source of the effect balance	
	Amt	-100...+100
Sets the modulation amount of the effect balance		

## 082: OD/HG – Mt. Delay (Overdrive/Hi.Gain – Multitap Delay)

This effect combines a mono-type overdrive/high-gain distortion and a multitap delay.

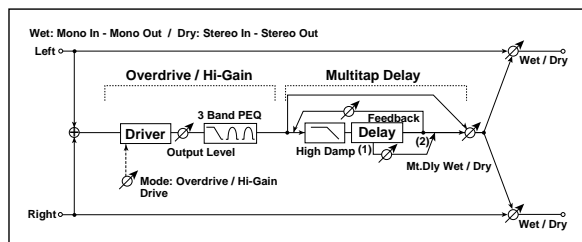

a	[O] Drive Mode	Overdrive, Hi-Gain
	Switches between overdrive and high-gain distortion	
b	Drive	1...100
	Sets the degree of distortion <span style="float:right">Fx:006</span>	
c	[O] Output Level	0...50
	Sets the overdrive output level <span style="float:right">Fx:006, </span>	
	Src	Off...Tempo
d	Amt	-50...+50
	Sets the modulation amount of the overdrive output level	
e	[O] Low Cutoff [Hz]	20...1.00kHz
	Sets the center frequency for Low EQ (shelving type)	
f	Gain [dB]	-18...+18dB
	[O] Mid1 Cutoff [Hz]	300...10.00kHz
	Sets the center frequency for Mid/High EQ 1 (peaking type)	
g	Q	0.5...10.0
	Sets the band width of Mid/High EQ 1 <span style="float:right">Fx:006</span>	
	Gain [dB]	-18...+18dB
h	[O] Mid2 Cutoff [Hz]	500...20.00kHz
	Sets the center frequency for Mid/High EQ 2 (peaking type)	
	Q	0.5...10.0
i	Sets the band width of Mid/High EQ 2 <span style="float:right">Fx:006</span>	
	Gain [dB]	-18...+18dB
	[D] Tap1 Time [msec]	0...680msec
j	Sets the Tap1 delay time	
	Tap1 Level	0...100
k	Sets the Tap1 output level <span style="float:right">Fx:045</span>	
	[D] Tap2 Time [msec]	0...680msec
l	Sets the Tap2 delay time	
	Feedback	-100...+100
m	Sets the Tap2 feedback amount	
	[D] Mt.Delay Wet/Dry	Dry, 2:98...98:2, Wet
n	Sets the multitap delay effect balance	
	High Damp [%]	0...100%
o	Sets the damping amount in the high range <span style="float:right">Fx:043</span>	
	Wet/Dry	Dry, 1:99...99:1, Wet
	Sets the balance between the effect and dry sounds <span style="float:right"></span>	
p	Src	Off...Tempo
	Selects the modulation source of the effect balance	
q	Amt	-100...+100
	Sets the modulation amount of the effect balance	

## 083: Wah – Amp Sim

### (Wah/Auto Wah – Amp Simulation)

This effect combines a mono-type wah and an amp simulation. You can change the order of the effect connection.

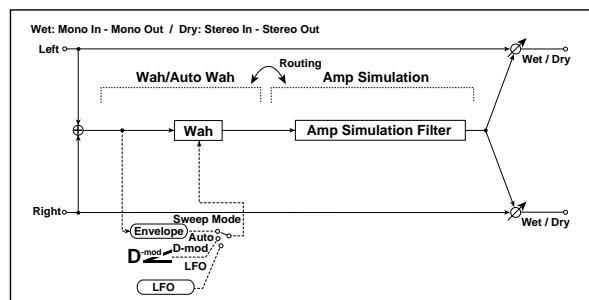

a	[W] Frequency Bottom Sets the lower limit of the wah center frequency	0...100 Fx:009
	Frequency Top Sets the upper limit of the wah center frequency	0...100 Fx:009
b	[W] Sweep Mode Selects the control from auto-wah, modulation source, and LFO	Auto, D-mod, LFO Fx:009, D-mod
	Src Selects the modulation source for the wah when Sweep Mode=D-mod	Off...Tempo
c	[W] LFO Frequency [Hz] Sets the LFO speed	0.02...20.00Hz
d	[W] Resonance Sets the resonance amount	0...100
	Low Pass Filter Switches the wah low pass filter on and off	Off, On
e	[A] Amplifier Type Selects the type of guitar amplifier	SS, EL84, 6L6
f	Routing Switches the order of the wah and amp simulation connection	WAH → AMP, AMP → WAH
g	Wet/Dry Sets the balance between the effect and dry sounds	Dry, 1:99...99:1, Wet D-mod
	Src Selects the modulation source of the effect balance	Off...Tempo
	Amt Sets the modulation amount of the effect balance	-100...+100

## 084: Decimator – Amp

### (Decimator – Amp Simulation)

This effect combines a mono-type decimator and an amp simulation. You can change the order of the effect connection.

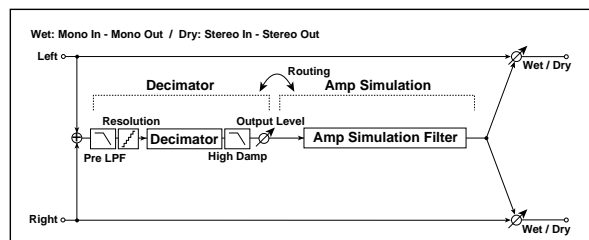

a	[D] Pre LPF Turn the harmonic noise caused by lowered sampling on and off	Off, On Fx:014
	High Damp [%] Sets the ratio of high-range damping	0...100%

b	[D] Sampling Freq (Frequency) [Hz] Sets the sampling frequency	1.00k...48.00kHz
	Resolution Sets the data bit length	4...24 Fx:014
c	[D] Output Level Sets the decimator output level	0...100 Fx:014
d	[A] Amplifier Type Selects the type of guitar amplifier	SS, EL84, 6L6
e	Routing Switches the order of the wah and amp simulation connection	DECI → AMP, AMP → DECI
f	Wet/Dry Sets the balance between the effect and dry sounds	Dry, 1:99...99:1, Wet D-mod
	Src Selects the modulation source of the effect balance	Off...Tempo
	Amt Sets the modulation amount of the effect balance	-100...+100

## 085: Decimator – Comp

### (Decimator – Compressor)

This effect combines a mono-type decimator and a compressor. You can change the order of the effect connection.

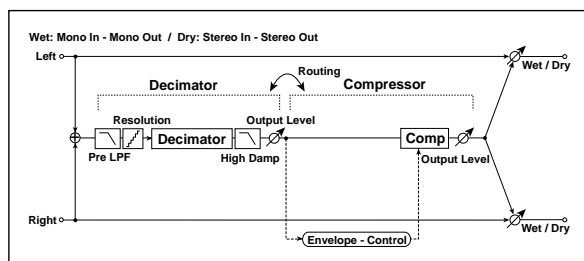

a	[D] Pre LPF Turn the harmonic noise caused by lowered sampling on and off	Off, On Fx:014
	High Damp [%] Sets the ratio of high-range damping	0...100%
b	[D] Sampling Freq (Frequency)[Hz] Sets the sampling frequency	1.00k...48.00kHz
	Resolution Sets the data bit length	4...24 Fx:014
c	[D] Output Level Sets the decimator output level	0...100 Fx:014
d	[C] Sensitivity Sets the sensitivity	1...100 Fx:002
e	[C] Attack Sets the attack level	1...100 Fx:002
	Output Level Sets the compressor output level	0...100 Fx:002
f	Routing Switches the order of the decimator and compressor connection	DECI → CMP, CMP → DECI
g	Wet/Dry Sets the balance between the effect and dry sounds	Dry, 1:99...99:1, Wet D-mod
	Src Selects the modulation source of the effect balance	Off...Tempo
	Amt Sets the modulation amount of the effect balance	-100...+100



## 086: Amp Sim – Tremolo (Amp Simulation – Tremolo)

This effect combines a mono-type amp simulation and a tremolo.

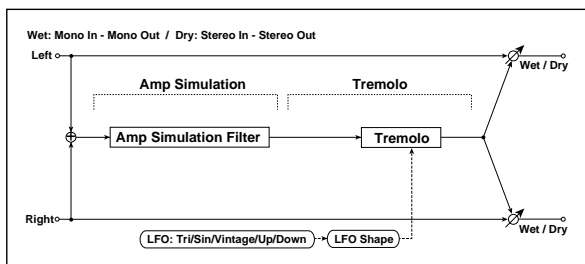

a	[A] Amplifier Type Selects the type of guitar amplifier	SS, EL84, 6L6
b	[T] LFO Waveform Selects LFO Waveform	Triangle, Sine, Vintage, Up, Down Fx:032
	LFO Shape Determines how much the LFO waveform is changed	-100...+100 Fx:020
c	[T] LFO Frequency [Hz] Sets the LFO speed	0.02...20.00Hz
d	[T] Depth Sets the depth of LFO modulation	0...100
e	Wet/Dry Sets the balance between the effect and dry sounds	Dry, 1:99...99:1, Wet D-mod
	Src Selects the modulation source of the effect balance	Off...Tempo
	Amt Sets the modulation amount of the effect balance	-100...+100

## 087: Cho/Fng – Mt. Dly (Chorus/Flanger – Multitap Delay)

This effect combines a mono-type chorus/flanger and a multitap delay.

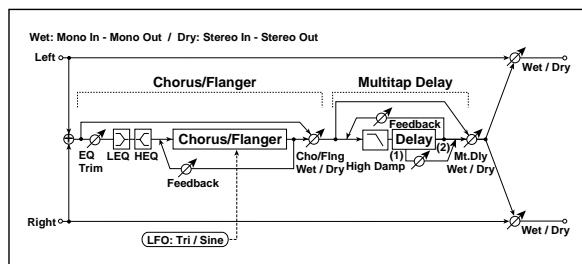

a	[F] Delay Time [msec] Sets the delay time	0.0...50.0msec
b	[F] LFO Frequency [Hz] Sets the LFO speed	0.02...20.00Hz
	LFO Waveform Selects LFO Waveform	Triangle, Sine
c	[F] Depth Sets the depth of LFO modulation	0...100
	Feedback Sets the feedback amount	-100...+100 Fx:020
d	[F] EQ Trim Sets the EQ input level	0...100
e	[F] Pre LEQ Gain [dB] Sets the gain of Low EQ	-15...+15dB
	Pre HEQ Gain [dB] Sets the gain of High EQ	-15...+15dB
f	[F] Cho/Fng Wet/Dry Sets the effect balance of the chorus/flanger	-Wet...-2:98, Dry, 2:98...Wet Fx:010, 020
g	[D] Tap1 Time [msec] Sets the Tap1 delay time	0...680msec
	Tap1 Level Sets the Tap1 output level	0...100 Fx:045
h	[D] Tap2 Time [msec] Sets the Tap2 delay time	0...680msec
	Feedback (Tap2) Sets the Tap2 feedback amount	-100...+100
i	[D] Mt.Delay Wet/Dry Sets the multitap delay effect balance	Dry, 1:99...99:1, Wet
	High Damp [%] Sets the damping amount in the high range	0...100% Fx:043
j	Wet/Dry Sets the balance between the effect and dry sounds	Dry, 1:99...99:1, Wet D-mod
	Src Selects the modulation source of the effect balance	Off...Tempo
	Amt Sets the modulation amount of the effect balance	-100...+100

## 088: Phaser – Cho/Flng

(Phaser – Chorus/Flanger)

This effect combines a mono-type phaser and a chorus/flanger.

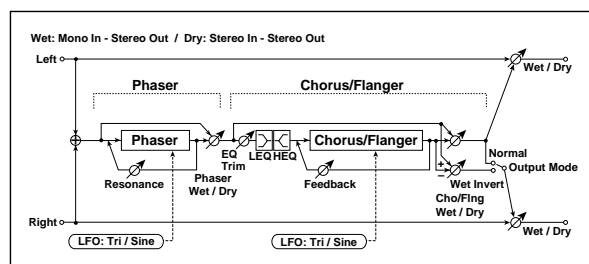

a	[P] LFO Frequency [Hz] Sets the LFO speed	0.02...20.00Hz
	LFO Waveform Selects LFO Waveform	Triangle, Sine
b	[P] Manual Sets the frequency to which the effect is applied	0...100
	Depth Sets the depth of LFO modulation	0...100
	Resonance Sets the resonance amount	-100...+100 Fx:023
c	[P] Phaser Wet/Dry Sets the phaser effect balance	-Wet...-2:98, Dry, 2:98...Wet Fx:010, 023
d	[F] LFO Frequency [Hz] Sets the LFO speed	0.02...20.00Hz
	LFO Waveform Selects LFO Waveform	Triangle, Sine
e	[F] Delay Time [msec] Sets the delay time	0.0...50.0msec
	Depth Sets the depth of LFO modulation	0...100
	Feedback Sets the feedback amount	-100...+100 Fx:020
f	[F] EQ Trim Sets the EQ input level	0...100
g	[F] Pre LEQ Gain [dB] Sets the gain of Low EQ	-15...+15dB
	Pre HEQ Gain [dB] Sets the gain of High EQ	-15...+15dB
h	[F] Cho/Flng Wet/Dry Sets the effect balance of the chorus/flanger	-Wet...-2:98, Dry, 2:98...Wet Fx:010, 020
	Output Mode Selects the output mode for the chorus/flanger	Normal, Wet Invert Fx:060
i	Wet/Dry Sets the balance between the effect and dry sounds	Dry, 1:99...99:1, Wet D <sup>mod</sup>
	Src Selects the modulation source of the effect balance	Off...Tempo
	Amt Sets the modulation amount of the effect balance	-100...+100

## 089: Reverb – Gate

This effect combines a mono-type reverb and a gate.

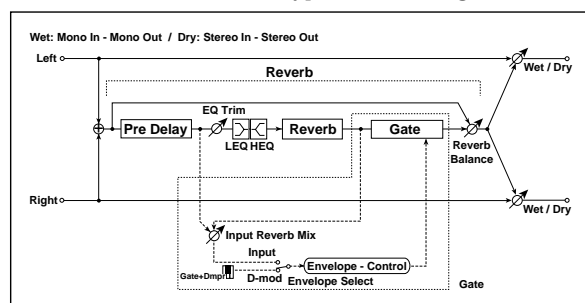

a	[R] Reverb Time [sec] Sets the reverberation time	0.1...10.0sec
	High Damp [%] Sets the damping amount in the high range	0...100%
b	[R] Pre Delay [msec] Sets the delay time of the reverb sound and gate control signal	0...200msec
c	[R] EQ Trim Sets the EQ input level	0...100
d	[R] Pre LEQ Gain [dB] Sets the gain of Low EQ	-15...+15dB
	Pre HEQ Gain [dB] Sets the gain of High EQ	-15...+15dB
e	[R] Reverb Balance Sets the reverb effect balance	Dry, 1:99...99:1, Wet
f	[G] Envelope Select Switches between modulation source control and input signal control	D-mod, Input Fx:005
	Src Selects the modulation source that controls the gate when Envelope Select is set to D-mod	Off...Gate2+Dmpr Fx:005
g	[G] Input Reverb Mix Sets the balance between the dry and reverb sounds of the gate control signal.	Dry, 1:99...99:1, Wet Fx:005
	Threshold Sets the gate threshold level	0...100 Fx:005
h	[G] Polarity Switches between non-invert and invert of the gate on/off state	+, - Fx:005
i	[G] Attack Sets the attack time	1...100 Fx:005
	Release Sets the release time	1...100 Fx:005
j	Wet/Dry Sets the balance between the effect and dry sounds	Dry, 1:99...99:1, Wet D <sup>mod</sup>
	Src Selects the modulation source of the effect balance	Off...Tempo
	Amt Sets the modulation amount of the effect balance	-100...+100

**f: Envelope Select, f: Src, g: Input Reverb Mix, g: Threshold**

The “Envelope Select” parameter enables you to select whether turning the gate on and off is triggered by the input signal level or controlled directly by the modulation source. You can select from **Off** to **Gate2+Dmpr** for the Src parameter to specify the modulation source.

When “Envelope Select” is set to **Input**, the gate is controlled by the level of signals that are the combination of the dry sound and the reverb sound. When the signal level exceeds the threshold, the gate opens and the reverb sound is output.

Normally, set “Input Reverb Mix” to **Dry** (the gate is controlled only by the dry sound). If you wish to extend the gate time, set the “Input Reverb Mix” value higher and adjust the “Threshold” value.

## Double Size

Double-size effects  
(Available for Insert Effects IFX2, 3, and 4)

### 090: Piano Body/Damper (Piano Body/Damper Simulation)

This effect simulates the resonance of the piano sound board caused by the string vibration, and also simulates the resonance of other strings that are not being played when you press the damper pedal. It will create a very realistic sound when applied to acoustic piano sounds.

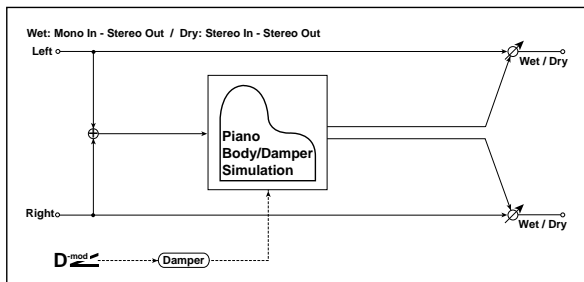

a	Sound Board Depth Sets the intensity of resonance of the sound board	0...100 FX
b	Damper Depth Sets the intensity of the string resonance created when the damper pedal is pressed	0...100 FX, D-mod
	Src Selects the modulation source of damper effect	Off...Tempo FX
c	Tone Sets tonal quality of effect sound	1...100 FX
d	Mid Shape Sets the mid range of tonal quality	0...36 FX
e	Tune Fine tuning	-50...+50 FX
f	Wet/Dry Sets the balance between the effect and dry sounds	Dry, 1:99...99:1, Wet D-mod
	Src Selects the modulation source of the effect balance	Off...Tempo
	Amt Sets the modulation amount of the effect balance	-100...+100

#### a: Sound Board Depth

This parameter sets the intensity of resonance of the piano sound board.

#### b: Damper Depth, b: Src

This parameter sets the resonance intensity of the other strings created when the damper pedal is pressed. The "Src" parameter selects the modulation source from which the damper effect is applied. Usually, select **Damper #64 Pdl** (Damper pedal).

**MIDI** The effect is off when a value for the modulation source specified for the "Src" parameter is 63 or smaller, and the effect is on when the value is 64 or higher.

#### c: Tone, d: Mid Shape

These parameters control the tonal quality of the effect sound.

#### e: Tune

Since this effect simulates the resonance of the strings, the sound varies depending on the pitch. If you have changed tuning using the "Master Tune" (Global P0: 0-1a), adjust this parameter value.

### 091: St. Mltband Limiter (Stereo Multiband Limiter)

This is a stereo multiband limiter.

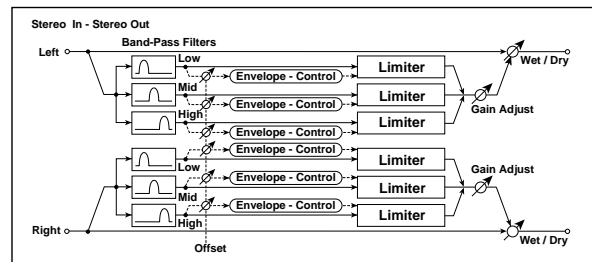

a	Ratio Sets the signal compression ratio	1.0:1...50.0:1, Inf:1 FX:003
b	Threshold [dB] Sets the level above which the compressor is applied	-40...0dB FX:003
c	Attack Sets the attack time	1...100 FX:003
d	Release Sets the release time	1...100 FX:003
e	Low Offset [dB] Sets the low range gain of trigger signal	-40...0dB FX:004
f	Mid Offset [dB] Sets the mid range gain of trigger signal	-40...0dB FX:004
g	High Offset [dB] Sets the high range gain of trigger signal	-40...0dB FX:004
h	Gain Adjust [dB] Sets the output gain	-Inf, -38...+24dB FX:003, D-mod
	Src Selects the modulation source for the output gain	Off...Tempo
i	Amt Sets the modulation amount of the output gain	-63...+63
	Wet/Dry Sets the balance between the effect and dry sounds	Dry, 1:99...99:1, Wet D-mod
j	Src Selects the modulation source of the effect balance	Off...Tempo
	Amt Sets the modulation amount of the effect balance	-100...+100

### 092: OD/HyperGain Wah (Overdrive/Hyper Gain Wah)

This distortion effect has two modes: overdrive and hyper-gain that produces a strong distortion. A higher high-gain setting is required for this effect relative to a normal-size effect.

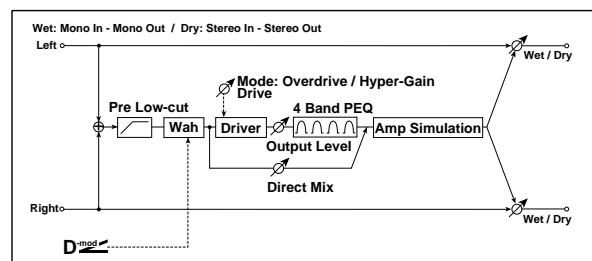

a	Wah Switches Wah on/off	Off, On FX:006, D-mod
	Src Selects the modulation source that switches the Wah on and off	Off...Tempo FX:006
	Sw Selects the switching mode for the modulation source that switches the Wah on and off	Toggle, Moment FX:006

b	Wah Sweep Range Sets the range of Wah	-10...+10 Fx:006, D <sup>mod</sup>
	Wah Sweep Src Selects the modulation source that controls the Wah	Off...Tempo
c	Drive Mode Switching between overdrive and hyper-gain mode	Overdrive, Hyper-Gain
d	Drive Sets the degree of distortion	1...120 Fx:006
	Pre Low-cut Sets the low range cut amount of the distortion input	0...10 Fx:006
e	Output Level Sets the output level	0...50 Fx:006, D <sup>mod</sup>
	Src Selects the modulation source for the output level	Off...Tempo
	Amt Sets the modulation amount of the output level	-50...+50
f	Low Cutoff [Hz] Sets the center frequency for Low EQ (shelving type)	20...1.00kHz
	Gain [dB] Sets the gain of Low EQ	-18...+18dB
g	Mid1 Cutoff [Hz] Sets the center frequency for Mid/High EQ 1 (peaking type)	300...10.00kHz
	Q Sets the band width of Mid/High EQ 1	0.5...10.0 Fx:006
	Gain [dB] Sets the gain of Mid/High EQ 1	-18...+18dB
h	Mid2 Cutoff [Hz] Sets the center frequency for Mid/High EQ 2 (peaking type)	500...20.00kHz
	Q Sets the band width of Mid/High EQ 2	0.5...10.0 Fx:006
	Gain [dB] Sets the gain of Mid/High EQ 2	-18...+18dB
i	Direct Mix Amount of the dry sound mixed to the distortion	0...50
	Speaker Simulation Speaker simulation on/off	Off, On
j	Wet/Dry Sets the balance between the effect and dry sounds	Dry, 1:99...99:1, Wet D <sup>mod</sup>
	Src Selects the modulation source of the effect balance	Off...Tempo
	Amt Sets the modulation amount of the effect balance	-100...+100

## 093: Vocoder

This effect applies the character of the right channel signal (Modulator) to the left channel signal input (Carrier). A common use of this effect is to produce the sound of various instruments by inputting a voice to the Modulator via a microphone. A special effect is also achieved by using rhythm or effect sounds. Strings or distortion guitar sounds with a lot of harmonics are suitable as a Carrier.

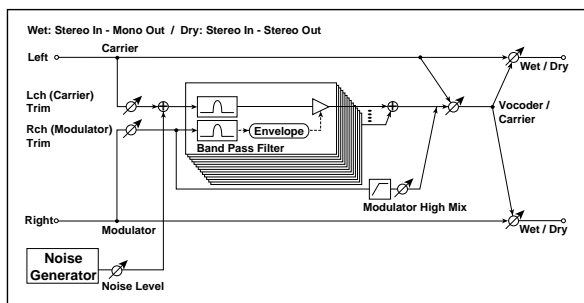

a	L (Carrier) Trim Sets the input level of left channel (Carrier)	0...100
b	R (Modulator) Trim Sets the input level of right channel (Modulator)	0...100

c	Formant Shift Sets the height of the frequency for the vocoder effect	-2...+2 Fx
d	Response Sets the speed of the response to the modulator input	0...100
e	Noise Level Sets the noise mix level to the Carrier	0...100 Fx, D <sup>mod</sup>
	Src Selects the modulation source for the noise mix level	Off...Tempo
	Amt Sets the modulation amount for the noise mix level	-100...+100
f	Modulator High Mix Sets the high-range output level of the modulator	0...100 Fx
g	Low Gain [dB] Sets the low-range output level of the vocoder	-12...+12
	High Gain [dB] Sets the high-range output level of the vocoder	-12...+12
h	Vocoder/Carrier Sets the balance between the vocoder output and the Carrier	Carrier, 1:99...99:1, Vocoder Fx, D <sup>mod</sup>
	Src Selects the modulation source for the balance between the vocoder output and the carrier	Off...Tempo
	Amt Sets the modulation amount of the balance between the vocoder output and the carrier	-100...+100
i	Wet/Dry Sets the balance between the effect and dry sounds	Dry, 1:99...99:1, Wet Fx, D <sup>mod</sup>
	Src Selects the modulation source of the effect balance	Off...Tempo
	Amt Sets the modulation amount of the effect balance	-100...+100

### c: Formant Shift

By offsetting the Carrier filter, you can adjust the height of the frequency range to which the vocoder effect is applied. The tonal quality will change significantly.

### e: Noise Level

This parameter enables you to mix white noise with the Carrier.

### f: Modulator High Mix

This parameter sets the high-range output level of the right channel sound (Modulator). If the modulator is a human voice, it will make the words more clear.

### h: Vocoder/Carrier, i: Wet/Dry

The "Vocoder/Carrier" parameter sets the balance between the vocoder sound and the left channel sound (Carrier). The "Wet/Dry" parameter sets the balance between the effect and dry sound.

If you wish to change the intensity of the vocoder effect, select **Wet** for "Wet/Dry", and adjust the balance using the "Vocoder/Carrier" parameter.

### Using a voice from a microphone as a modulator (Vocoder is selected for IFX2 in Program mode)

- Set "Pan" (Program P4: 4-1b) to **L001** for Amp1 Level/Pan so that the Carrier sound will be input only to the left channel. When Oscillator Mode (Program P1: 1-1a) is set to **Double**, set Pan for Amp2 Level/Pan to **L001**.
- To set up the input, use the "Audio Input" parameter (Global P0: 0-3a). Connect a microphone to AUDIO INPUT1 or INPUT 2 connector, and set the [LEVEL] switch to **MIC**. While talking into the microphone, adjust the [LEVEL] knob so that the level is high enough, but the sound will not be distorted. For the Audio Input parameters for the microphone, set Pan to **R127** and BUS (IFX/Indiv.) Select to **IFX2**. Now the voice from the microphone is input to the modulator channel. You can create the sound of a "talking" instrument when you talk into the microphone while playing.



h	Input Level Dmod [%] Sets the modulation amount of the input level	-100...+100 Fx:037, <b>D<sup>mod</sup></b>
	Src Selects the modulation source for the input level	Off...Tempo Fx:037
i	Spread Sets the width of the stereo image of the effect sound	-100...+100 Fx:043
j	Wet/Dry Sets the balance between the effect and dry sounds	Dry, 1:99...99:1, Wet <b>D<sup>mod</sup></b>
	Src Selects the modulation source of the effect balance	Off...Tempo
	Amt Sets the modulation amount of the effect balance	-100...+100

#### b: L/R Pitch

When you select **Up/Down** for this parameter, the pitch shift amount for the right channel will be reversed. If the pitch shift amount is positive, the pitch of the left channel is raised, and the pitch of the right channel is lowered.

## 096: Rotary Speaker OD (Rotary Speaker Overdrive)

This is a stereo rotary speaker effect. It has an internal speaker simulator that simulates overdrive (recreating the amp distortion) and characteristics of the rotary speaker, producing a very realistic rotary speaker sound.

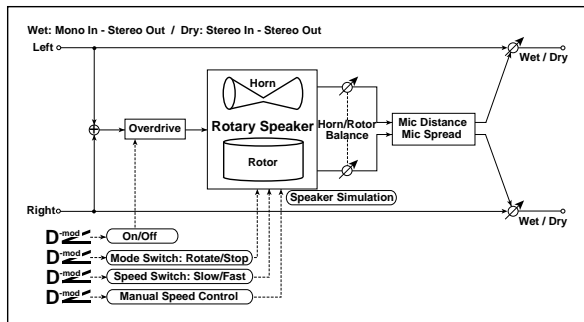

a	Overdrive Switches overdrive on/off.	Off, On <b>D<sup>mod</sup></b>
	Src Selects the modulation source that switches overdrive on/off	Off...Tempo
	Sw Selects the switching mode of the modulation source that switches overdrive on/off	Toggle, Moment Fx:040
b	Overdrive Gain Determines the degree of distortion	0...100
	Overdrive Level Sets the overdrive output level	0...100
c	Overdrive Tone Sets the tonal quality of overdrive	0...15
	Speaker Simulator Switches speaker simulation on/off	Off, On
d	Mode Switch Switches between speaker rotation and stop	Rotate, Stop <b>D<sup>mod</sup></b>
	Src Selects the modulation source that toggles between rotation and stop	Off...Tempo
	Sw Selects the switching mode of the modulation source that toggles between rotation and stop	Toggle, Moment Fx:040
e	Speed Switch Switches the speaker rotation speed between slow and fast.	Slow, Fast <b>D<sup>mod</sup></b>
	Src Selects the modulation source that toggles between slow and fast	Off...Tempo
	Sw Selects the switching mode of the modulation source that toggles between slow and fast	Toggle, Moment Fx:040

f	Horn/Rotor Balance Sets the volume level balance between the high-range horn and low-range rotor	Rotor, 1...99, Horn
	ManualSpeedCtrl Sets the modulation source in case the rotation speed is changed directly	Off...Tempo Fx:040, <b>D<sup>mod</sup></b>
g	Horn Acceleration How quickly the horn rotation speed in the high range is switched	0...100 Fx:040
	Horn Ratio Adjusts the (high-range side) horn rotation speed. Standard value is 1.0. Selecting "Stop" will stop the rotation	Stop, 0.50...2.00
h	Rotor Acceleration Determines how quickly the rotor rotation speed in the low range is switched	0...100 Fx:040
	Rotor Ratio Adjusts the (low-range side) rotor rotation speed. Standard value is 1.0. Selecting "Stop" will stop the rotation	Stop, 0.50...2.00
i	Mic Distance Distance between the microphone and rotary speaker	0...100 Fx:040
	Mic Spread Angle of left and right microphones	0...100 Fx:040
j	Wet/Dry Sets the balance between the effect and dry sounds	Dry, 1:99...99:1, Wet <b>D<sup>mod</sup></b>
	Src Selects the modulation source of the effect balance	Off...Tempo
	Amt Sets the modulation amount of the effect balance	-100...+100

#### a: Sw

This parameter determines how to switch on/off the overdrive via a modulation source.

When "Sw" = **Toggle**, overdrive is turned on/off each time the pedal or joystick is operated.

**MIDI** Overdrive will be switched on/off each time the value of the modulation source exceeds 64.

When "Sw" = **Moment**, overdrive is applied only when you press the pedal or operate the joystick.

**MIDI** Only when the value for the modulation source is 64 or higher, the overdrive effect is applied.

## 097: Early Reflections

This early reflection effect has more precise early reflections with twice the maximum length of a normal-size effect (Fx:041). You can create a very smooth and dense sound.

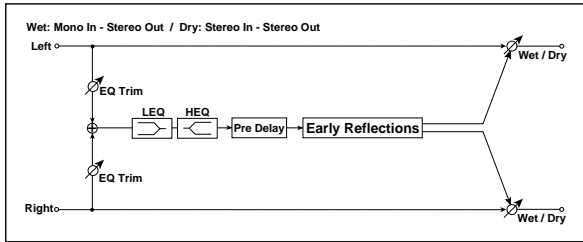

a	Type Selects the decay curve for the early reflection	Sharp, Loose, Modulated, Reverse Fx:041
b	ER Time [msec] Sets the time length of early reflection	10...1600msec
c	Pre Delay [msec] Sets the time taken from the original sound to the first early reflection	0...200msec
d	EQ Trim Sets the input level of EQ applied to the effect sound	0...100
e	Pre LEQ Gain [dB] Sets the gain of Low EQ	-15.0...+15.0dB
	Pre HEQ Gain [dB] Sets the gain of High EQ	-15.0...+15.0dB
f	Wet/Dry Sets the balance between the effect and dry sounds	Dry, 1:99...99:1, Wet D-mod
	Src Selects the modulation source of the effect balance	Off...Tempo
	Amt Sets the modulation amount of the effect balance	-100...+100

## 098: L/C/R Long Delay

This multitap delay outputs three Tap signals to left, right and center respectively. You can set a maximum of 2,730msec for the delay time.

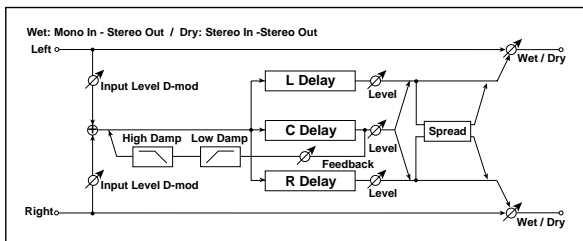

a	L Delay Time [msec] Sets the delay time of TapL	0...2730msec
	Level Sets the output level of TapL	0...50
b	C Delay Time [msec] Sets the delay time of TapC	0...2730msec
	Level Sets the output level of TapC	0...50
c	R Delay Time [msec] Sets the delay time of TapR	0...2730msec
	Level Sets the output level of TapR	0...50
d	Feedback (C Delay) Sets the feedback amount of TapC	-100...+100 D-mod
	Src Selects the modulation source of the TapC feedback amount	Off...Tempo
	Amt Sets the modulation amount of the TapC feedback amount	-100...+100

e	High Damp [%] Sets the damping amount in the high range	0...100% Fx:043
	Low Damp [%] Sets the damping amount in the low range	0...100% Fx:043
f	Input Level Dmod [%] Sets the modulation amount of the input level	-100...+100 Fx:037, D-mod
	Src Selects the modulation source for the input level	Off...Tempo Fx:037
g	Spread Sets the width of the stereo image of the effect sound	0...50 Fx:043
h	Wet/Dry Sets the balance between the effect and dry sounds	Dry, 1:99...99:1, Wet D-mod
	Src Selects the modulation source of the effect balance	Off...Tempo
	Amt Sets the modulation amount of the effect balance	-100...+100

## 099: St/Cross Long Dly (Stereo/Cross Long Delay)

This is a stereo delay, and can be used as a cross-feedback delay effect in which the delay sounds cross over between left and right by changing the feedback routing. You can set a maximum of 1,360msec for the delay time.

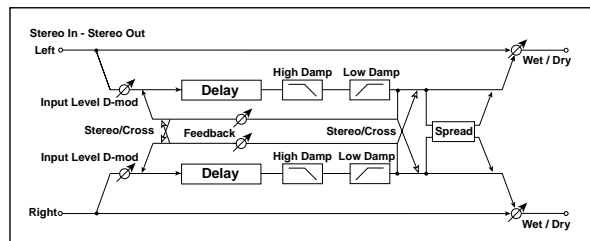

a	Stereo/Cross Switches between stereo delay and cross-feedback delay	Stereo, Cross
b	L Delay Time [msec] Sets the delay time for the left channel	0.0...1360.0msec
c	R Delay Time [msec] Sets the delay time for the right channel	0.0...1360.0msec
d	L Feedback Sets the feedback amount for the left channel	-100...+100 D-mod
	Src Selects the modulation source of feedback amount	Off...Tempo
	Amt L Sets the modulation amount of the left channel feedback	-100...+100
e	R Feedback Sets the feedback amount for the right channel	-100...+100 D-mod
	Amt R Sets the modulation amount of the right channel feedback	-100...+100
f	High Damp [%] Sets the damping amount in the high range	0...100% Fx:043
g	Low Damp [%] Sets the damping amount in the low range	0...100% Fx:043
h	Input Level Dmod [%] Sets the modulation amount of the input level	-100...+100 Fx:037, D-mod
	Src Selects the modulation source for the input level	Off...Tempo Fx:037
i	Spread Sets the width of the stereo image of the effect sound	-50...+50 Fx:043
j	Wet/Dry Sets the balance between the effect and dry sounds	Dry, 1:99...99:1, Wet D-mod
	Src Selects the modulation source of the effect balance	Off...Tempo
	Amt Sets the modulation amount of the effect balance	-100...+100





i	Wet/Dry Sets the balance between the effect and dry sounds	Dry, 1:99...99:1, Wet	
	Src Selects the modulation source of the effect balance	Off...Tempo	
	Amt Sets the modulation amount of the effect balance	-100...+100	

**a: Time Over? L >, a: R >**

You can set the delay time up to 1365msec. If the delay time exceeds this limit, the error message "OVER!!" appears on the display. Set the delay time parameters so that this message will not appear. "Time Over?>" is only a display parameter.

## 102: Hold Delay

This effect records the input signal and plays it back repeatedly. You can control the start of recording and reset via a modulation source. Easy to use for real-time performances.

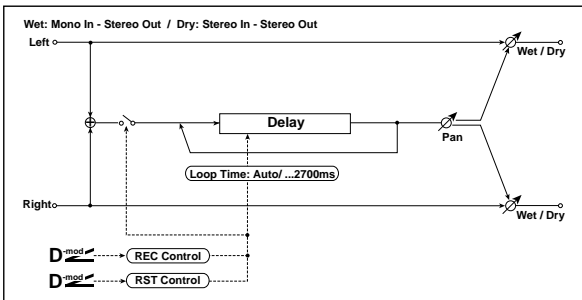

a	Loop Time [msec] Sets Automatic loop time setup mode or specifies loop time	Auto, 1...2700msec	
b	REC Control Src Selects control source for recording	Off...Tempo	
c	RST Control Src Selects control source for reset	Off...Tempo	
d	Manual REC Control Sets the recording switch	REC Off, REC On	
e	Manual RST Control Sets the reset switch	Off, RESET	
f	Pan Sets the stereo image of the effect	L100...L1, C, R1...R100	
	Src Selects the modulation source of stereo image of the effect	Off...Tempo	
	Amt Sets the modulation amount of stereo image of the effect	-100...+100	
g	Wet/Dry Sets the balance between the effect and dry sounds	Dry, 1:99...99:1, Wet	
	Src Selects the modulation source of the effect balance	Off...Tempo	
	Amt Sets the modulation amount of the effect balance	-100...+100	

**a: Loop Time [msec]**

With **Auto**, the loop time is automatically set. Otherwise, you can specify the loop time.

When **Auto** is selected, the Loop Time is automatically set to the time it takes for a performance recorded while the Modulation Source or "Manual REC Control" is on. However, if the time length exceeds 2,700msec, the loop time will be automatically set to 2,700msec.

**b: REC Control Src, d: Manual REC Control**

"REC Control Src" selects the modulation source that controls recording.

If this modulation is on, or if "Manual REC Control" is set to **REC On**, you can record the input signal. If a recording has already been carried out, additional signals will be overdubbed.

**MIDI** The effect is off when a value for the modulation source specified for the "REC Control Src" parameter is 63 or smaller, and the effect is on when the value is 64 or higher.

**c: RST Control Src, e: Manual RST Control**

The "RST Control Src" parameter specifies the modulation source that controls the reset operation.

When you set this modulation source to On, or "Manual RST Control" to **RESET**, you can erase what you recorded. If the Loop Time parameter has been set to Auto, the loop time is also reset.

**MIDI** The effect is off when a value for the modulation source specified for the "RST Control Src" parameter is 63 or smaller, and the effect is on when the value is 64 or higher.

**"Hold" procedure (when Loop Time = Auto)**



Select the following options for each parameter:

- ① "Loop Time [msec]"=**Auto**  
 "REC Control Src"=**JS +Y: CC#01**  
 "RST Control Src"=**JS -Y: CC#02**  
 "Manual REC Control"=**REC Off**  
 "Manual RST Control"=**RESET**  
 It should be noted that all recordings will be deleted while Reset is On.
- ② "Manual RST Control"=**Off**  
 Reset is cancelled and the unit enters Rec ready mode.
- ③ Push the joystick in the +Y direction (forward) and play a phrase you wish to hold. When you pull the joystick to its original position, the recording will be finished and the phrase you just played will be held.  
 Loop Time is automatically set only for the first recording after resetting. If the time length exceeds 2,700msec, Loop Time will be automatically set to 2,700msec. (If you have set "Loop Time" to **1-2,700msec**, the specified loop time will be used regardless of the time taken from pushing the joystick forward until it is pulled back. However, the recording method remains the same. The phrase being played while the joystick is pushed forward will be held.)
- ④ If you made a mistake during recording, pull the joystick in the -Y direction (back) to reset. In this way, the recording will be erased. Repeat step ③ again.
- ⑤ The recorded phrase will be repeated again and again. You can use this to create an accompaniment.
- ⑥ By pushing the joystick in the +Y direction (forward), you can also overdub performances over the phrase that is being held.



# Master EQ

## Master EQ

Use P9: Master EQ in Program, Combination, Sequencer, and Song Play modes.

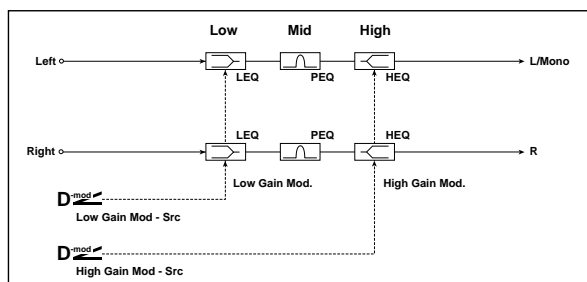
-  You cannot use the Master EQ in Sampling mode.
-  You cannot use the Master EQ for the Insert Effects or Master Effects.



a	Low Cutoff [Hz] Sets the cutoff frequency of Low EQ (shelving type)	20...1.00K
	Gain[dB] Sets the gain of Low EQ	-18.0...+18.0 (0.5step) 
b	Mid Cutoff [Hz] Sets the cutoff frequency of Mid EQ (peaking type)	300...10.00K
	Q Sets the band width of Mid EQ. With a higher value, the band become narrower.	0.5...10.0 (0.1step)
	Gain [dB] Sets the gain of Mid EQ	-18.0...+18.0 (0.5step)
c	High Cutoff [Hz] Sets the cutoff frequency of High EQ (shelving type)	500...20.00K
	Gain [dB] Sets the gain of High EQ	-18.0...+18.0 (0.5step) 
d	Low Gain Mod-Src Selects the modulation source for Low Gain	Off...Tempo
e	High Gain Mod-Src Selects the modulation source for High Gain	Off...Tempo

### a: Gain[dB], b: Gain[dB], c: Gain[dB]

These parameters are linked with the “Master EQ Gain [dB]” (9-1d) parameter of the Master FX page.

### d: Low Gain Mod-Src

For example, when this parameter is set to **KnobM1: #17**, you can control the EQ gain in the range from -18dB to +18dB during performance using the [Realtime Control] knob. At this time, set Knob 1-B to **Knob Mod1 (CC#17)** for Realtime Control Knob B-Assign (Program P1: 1-4b, Combination P4: 4-4b, Sequencer P4: 4-7b, Song Play P2: 2-1b). The 12 o'clock position of the knob corresponds to the “Low Gain” value here.

### e: High Gain Mod-Src

For example, when this parameter is set to **KnobM2: #19**, you can control the EQ gain in the range from -18dB to +18dB during performance using the [Realtime Control] knob. At this time, set Knob 2-B to **Knob Mod2 (CC#19)** for Realtime Control Knob B-Assign (Program P1: 1-4b, Combination P4: 4-4b, Sequencer P4: 4-7b, Song Play P2: 2-1b). The 12 o'clock position of the knob corresponds to the High Gain value here.



# 9. Appendices

## Alternate Modulation Source (AMS)

### About Alternate Modulation

Alternate Modulation can be specified for the following 29 types, in total, 55 alternate modulation destinations shown in the diagram below. (Pitch EG is common to OSC 1 and 2.) AMS (Alternate Modulation Source) can be selected independently for each of these to apply modulation.

### About Alternate Modulation Sources

There are 42 Alternate Modulation sources (AMS) that can control Alternate Modulation destinations. If you select two or more Alternate Modulation destinations for control by the same AMS, a single source will apply modulation to each of the specified destinations.

Frequently used assignments such as using the joystick (X) to control pitch are provided as special parameters, so it is not necessary to use Alternate Modulation to accomplish this.

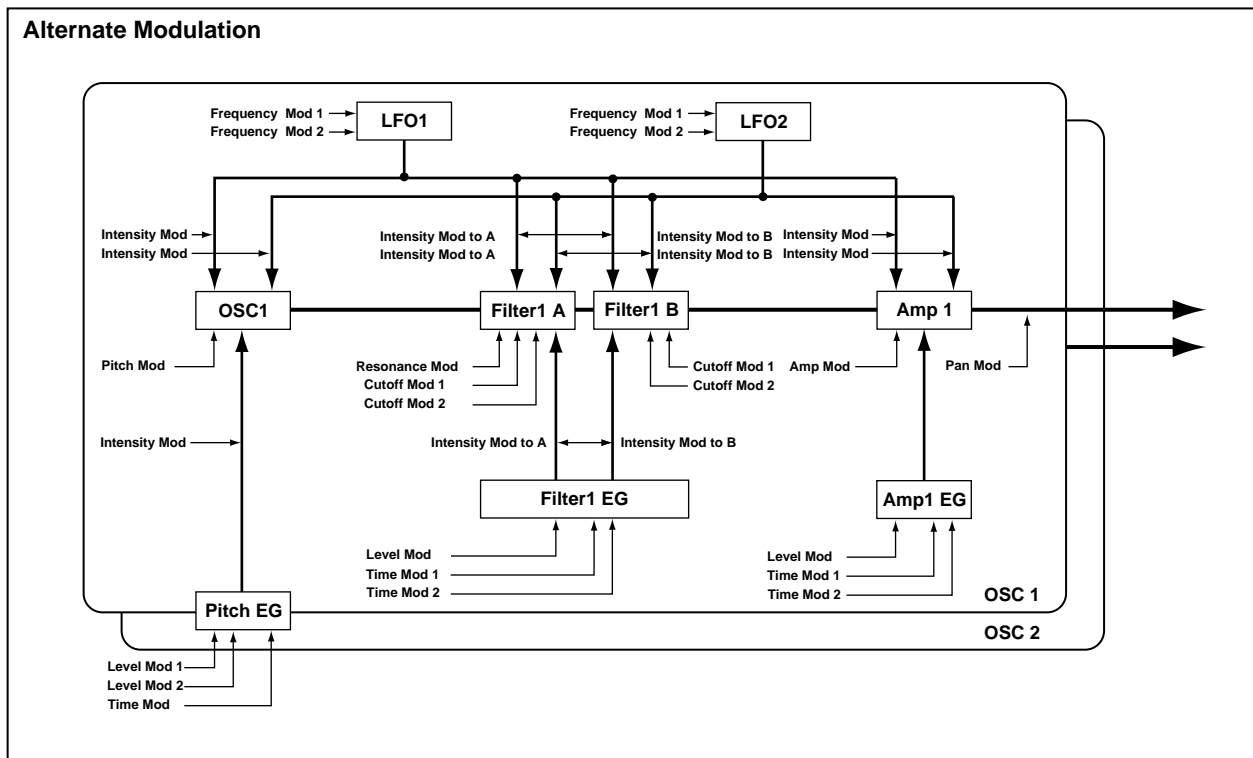

Different types of Alternate Modulation are used to control the bank I-F programs (which can be used when the EXB-MOSS option is installed). (EXB-MOSS owner's manual)

## AMS (Alternate Modulation Source) List

Off	do not use Alternate Modulation
(PEG) Pitch EG	pitch EG
(FEG) Filter EG	filter EG within the same oscillator
(AEG) Amp EG	amp EG within the same oscillator
(LFO) LFO1	LFO1 within the same oscillator
(LFO) LFO2	LFO2 within the same oscillator
(KT) Flt KTrk +/- (Filter Keyboard Track +/-)	filter keyboard tracking within the same oscillator (p.243)
(KT) Flt KTrk +/- (Filter Keyboard Track +/-)	filter keyboard tracking within the same oscillator (p.243)
(KT) Flt KTrk 0/+ (Filter Keyboard Track 0/+)	filter keyboard tracking within the same oscillator (p.243)
(KT) Flt KTrk +/0 (Filter Keyboard Track +/0)	filter keyboard tracking within the same oscillator (p.243)
(KT) Amp KTrk +/- (Amp Keyboard Track +/-)	amp keyboard tracking within the same oscillator (p.243)
(KT) Amp KTrk +/- (Amp Keyboard Track +/-)	amp keyboard tracking within the same oscillator (p.243)
(KT) Amp KTrk 0/+ (Amp Keyboard Track 0/+)	amp keyboard tracking within the same oscillator (p.243)
(KT) Amp KTrk +/0 (Amp Keyboard Track +/0)	amp keyboard tracking within the same oscillator (p.243)
(KT) Note Number	note number
(EXT) Velocity	velocity
(EXT) Poly After (Poly After Touch)	polyphonic after touch (transmitted from the TRITON STUDIO only as sequence data)
(EXT) After Touch	after touch (channel after touch)
(EXT) JS X (Joy Stick X)	joystick X (horizontal) axis
(EXT) JS+Y:CC#01 (Joy Stick +Y: CC#01)	joystick +Y (Vertical upward) direction (CC#01)
(EXT) JS-Y:CC#02 (Joy Stick -Y: CC#02)	joystick -Y (Vertical downward) direction (CC#02)
(EXT) JS+Y & AT/2 (Joy Stick +Y & After Touch/2)	joystick +Y (Vertical upward) direction and after touch (p.243)
(EXT) JS-Y & AT/2 (Joy Stick -Y & After Touch/2)	joystick -Y (Vertical downward) direction and after touch (p.243)
(EXT) Pedal:CC#04 (Foot Pedal: CC#04)	assignable foot pedal (CC#04) (p.243)
(EXT) Ribbon:CC#16	ribbon controller (CC#16)
(EXT) Slider:CC#18 (Value Slider: CC#18)	value slider (CC#18) (p.243)
(EXT) KnobMod1:#17 (Knob Mod1: CC#17)	realtime control knob 1 in B-mode (knob modulation 1 CC#17) (p.243)
(EXT) KnobMod2:#19 (Knob Mod2: CC#19)	realtime control knob 2 in B-mode (knob modulation 2 CC#19) (p.243)
(EXT) KnobMod3:#20 (Knob Mod3: CC#20)	realtime control knob 3 in B-mode (knob modulation 3 CC#20) (p.243)
(EXT) KnobMod4:#21 (Knob Mod4: CC#21)	realtime control knob 4 in B-mode (knob modulation 4 CC#21) (p.243)
(EXT) KnobMod1 [+] (Knob Mod1: CC#17 [+])	realtime control knob 1 in B-mode [+] (p.243)
(EXT) KnobMod2 [+] (Knob Mod2: CC#19 [+])	realtime control knob 2 in B-mode [+] (p.243)
(EXT) KnobMod3 [+] (Knob Mod3: CC#20 [+])	realtime control knob 3 in B-mode [+] (p.243)
(EXT) KnobMod4 [+] (Knob Mod4: CC#21 [+])	realtime control knob 4 in B-mode [+] (p.243)
(EXT) Damper:#64 (Damper: CC#64)	damper pedal (CC#64)
(EXT) Porta.SW:#65 (Portamento Switch: CC#65)	portamento switch (CC#65)
(EXT) Sostenuto:#66 (Sostenuto: CC#66)	sostenuto pedal (CC#66)
(EXT) Soft:CC#67 (Soft Pedal: CC#67)	soft pedal (CC#67)
(EXT) SW 1:CC#80 (SW1 Mod.: CC#80)	assignable panel switch 1 (SW1 modulation CC#80) (p.243)
(EXT) SW 2:CC#81 (SW2 Mod.: CC#81)	assignable panel switch 2 (SW2 modulation CC#81) (p.243)
(EXT) Foot SW:#82 (Foot Switch: CC#82)	assignable foot switch (CC#82) (p.243)
(EXT) MIDI:CC#83	MIDI control change (CC#83)
(EXT) Tempo	tempo (tempo data from internal clock or external MIDI clock)

In the above table, the parentheses ( ) indicate the type of source that can be used for each AMS. For example, the "AMS (Pitch AMS)" value for OSC1 Pitch (Program P2: 2-1a) can be [Off, (FEG, AEG, EXT)] (p.13). This means that you can select Off, and (FEG), (AEG), or (EXT) sources.

CC#: This is the control change number.

Flt KTrk +/- (Filter Keyboard Track +/-)

Flt KTrk +/- (Filter Keyboard Track +/-)

Flt KTrk 0/+ (Filter Keyboard Track 0/+)

Flt KTrk +/-0 (Filter Keyboard Track +/-0)

Amp KTrk +/- (Amp Keyboard Track +/-)

Amp KTrk +/- (Amp Keyboard Track +/-)

Amp KTrk 0/+ (Amp Keyboard Track 0/+)

Amp KTrk +/-0 (Amp Keyboard Track +/-0)

+/-: The direction of the effect will be determined by the sign (positive or negative) of the "Ramp Low" or "Ramp High" setting.

+/-: The direction of the effect will be determined by the sign of the "Ramp Low" setting, and by the opposite sign of the "Ramp High" setting (-50 for a setting of +50, and +50 for a setting of -50).

0/+: "Ramp Low" will have no AMS effect. The sign of the "Ramp High" setting will determine the direction of its effect.

+0: The sign of the "Ramp Low" setting will determine the direction of its effect. "Ramp High" will have no AMS effect.

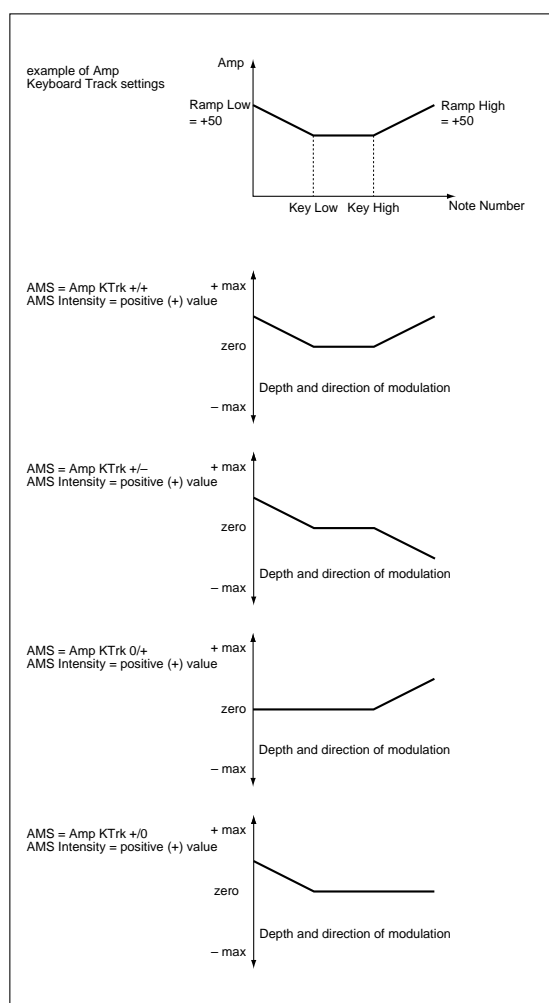

JS +Y & AT/2 (Joy Stick +Y & After Touch/2)

The effect will be controlled by the joystick +Y (Vertical upward) and by after touch. In this case, the effect of after touch will be only half of the specified intensity.

JS -Y & AT/2 (Joy Stick -Y & After Touch/2)

The effect will be controlled by the joystick -Y (Vertical downward) and by after touch. In this case, the effect of after touch will be only half of the specified intensity.

Pedal:CC#04 (Foot Pedal: CC#04)

If you wish to use the assignable foot pedal as an AMS, set "Foot Pedal Assign" (Global P2: Controller 2-1a) to **Foot Pedal (CC#04)** (≡"Foot Pedal Assign").

A foot controller etc. connected to the ASSIGNABLE PEDAL jack will control the effect.

Slider:CC#18 (Value Slider: CC#18)

When Program mode P0: "Program Select" or Combination mode P0: "Combination Select" are selected, the [VALUE] slider will function as a controller corresponding to CC#18.

KnobMod1:#17 (Knob Mod1: CC#17)

KnobMod2:#19 (Knob Mod2: CC#19)

KnobMod3:#20 (Knob Mod3: CC#20)

KnobMod4:#21 (Knob Mod4: CC#21)

If you want to use REALTIME CONTROLS knobs [1]-[4] as AMS, set the Controller page "Realtime Control Knobs B-Assign" parameters to assign "Knob1-B" to **KnobMod1 (CC#17)**, "Knob2-B" to **KnobMod2 (CC#19)**, "Knob3-B" to **KnobMod3 (CC#20)**, and "Knob4-B" to **KnobMod4 (CC#21)** (≡"Knob1...4-B Assign") for each program, combination, song, or for Song Play mode.

When you set REALTIME CONTROLS to B-mode and operate knobs [1]-[4], the specified modulation will apply.

If AMS intensity is set to a **positive (+)** value, moving the knob to the 12 o'clock position will produce an AMS effect of **0**. Rotating the knob toward the right will produce a positive change in the effect, and rotating it toward the left will produce a negative change. (With **negative (-)** settings, the opposite effect will result.)

KnobMod1 [+] (Knob Mod1: CC#17 [+])

KnobMod2 [+] (Knob Mod2: CC#19 [+])

KnobMod3 [+] (Knob Mod3: CC#20 [+])

KnobMod4 [+] (Knob Mod4: CC#21 [+])

These differ from **KnobMod1:#17-KnobMod4:#21** in the knob position and direction of the effect. If AMS intensity is set to a **positive (+)** value, rotating the knob to the far left will produce an AMS effect of **0**. Rotating the knob toward the right will apply an effect only in the positive direction. (With **negative (-)** settings, the opposite effect will result.)

SW 1:CC#80 (SW1 Mod.: CC#80)

SW 2:CC#81 (SW2 Mod.: CC#81)

If you want to use the [SW1] and [SW2] keys as AMS, set the Controller page "Panel Switch Assign" parameters to assign "SW1" to **SW1 Mod1 (CC#80)** and "SW2" to **SW2 Mod2 (CC#81)** for each program, combination, song, or for Song Play mode. (≡"SW1/SW2 Assign")

The will be controlled when you operate the [SW1] or [SW2] key.

Foot SW:#82 (Foot Switch: CC#82)

If you wish to use an assignable foot switch as an AMS, set "Foot Switch Assign" (Global P2: Controller 2-1a) to **Foot SW (CC#82)** (≡"Foot Switch Assign").

The effect will be controlled when you operate a foot switch etc. connected to the ASSIGNABLE SWITCH jack.

## Alternate Modulation settings

When you operate an AMS (Alternate Modulation Source), the modulation destination will be affected as shown in the table below.

By using alternate modulation, you can create complex systems of modulation in which EG, LFO, keyboard tracks, and controllers work together.

- You can apply complex change to an LFO or EG, for example by using the pitch/filter/amp EG to control the frequency or intensity of an LFO that modulates the pitch/filter/amp, or by using LFO2 to control the frequency of LFO1.
- The tone, EG, and LFO etc. can be controlled not only by velocity or joystick, but also from a switch, knob, or pedal etc.
- Panning can be controlled in realtime from a controller, EG, or LFO etc.
- Controllers etc. can be used to control EG levels or times. This lets you shape the EG in realtime.
- Filter/amp keyboard tracking or note number can be used to control the EG or LFO according to the keyboard pitch that is played.
- Pitch, tone, EG or LFO can be controlled by the tempo of the arpeggiator or sequencer.

### Notes for the table

- \*1 If **Note Number** is selected as an AMS, the base value will be **C4**.
- \*2 EXT(+): Velocity, Poly After, After Touch, JS+Y:CC#01, JS(-Y):CC#02, JS+Y & AT/2, JS -Y & AT/2, Pedal:CC#04, Slider:CC#18, KnobMod1[+], KnobMod2[+], KnobMod3[+], KnobMod4[+], Damper:#64, Porta:SW:#65, Sostenuito:#66, Soft:CC#67, SW1:CC#80, SW2:CC#81, MIDI:CC#83
- \*3 EXT(+/-): KnobMod1:#17, KnobMod1:#19, KnobMod1:#20, KnobMod1:#21
- \*4 If **Tempo** is selected as an AMS, the base value will be  $\downarrow = 120$ . For example if the AMS for "Pitch" is set to **Tempo**, and "Intensity" is set to **12.00**, doubling the tempo value ( $\downarrow = 120 \rightarrow 240$ ) will raise the pitch one octave, and halving the tempo ( $\downarrow = 120 \rightarrow 60$ ) will lower the pitch one octave.
- \*5 A dedicated parameter is also provided.
- \*6 This will be added to the "Filter Frequency" value. As the "Frequency" value increases by **10**, the cutoff frequency will double (rise one octave).
- \*7 This will be added to the "Pan" setting.
- \*8 It is possible to control LFO "Frequency" by using **Tempo** "AMS" and "Intensity." However if you use the *Frequency MIDI/Tempo Sync* function (Program P5: 5-1c), the LFO frequency can be synchronized to the tempo and note value.

## The effect of alternate modulation on various parameters, and example applications

### Pitch (Program P2: 2-1a)

Pitch can be controlled by the filter/amp EG, controllers, or tempo etc.

- If you select **Filter EG** or **Amp EG** as the "AMS" and set "Intensity" to **+12.00**, the pitch will change up to  $\pm 1$  octave in synchronization with the EG.
- If you select **Tempo** as the "AMS" and set "Intensity" to **+12.00**, doubling the tempo (based on  $\downarrow = 120$ ) will raise the pitch one octave, and halving the tempo will lower the pitch one octave.

### Pitch EG Intensity (Program P2: 2-1b)

Pitch EG intensity can be controlled by keyboard tracking, controllers, or tempo.

- If you select **JS +Y:CC#01** as the "AMS" and set "Intensity" to **+12.00**, moving the joystick in the +Y direction will gradually increase the effect of the Pitch EG to a maximum of  $\pm 1$  octave. If "Intensity" has a **negative value**, the effect of the Pitch EG will be inverted.

### Pitch LFO 1/2 Intensity (Program P2: 2-1d)

Pitch modulation intensity of the LFO1/2 can be controlled by an EG, keyboard tracking, controllers, or tempo etc.

- If you select **EG** as the "AMS", the pitch change width of LFO modulation etc. can be controlled in synchronization with the level changes of the EG. With **positive (+)** settings of "Intensity," the vibrato effect will gradually deepen as the EG level rises, or gradually lessen as the EG level decreases. With **negative (-)** settings of "Intensity," the LFO phase will be inverted.
- If you select a controller such as **SW1** or **2** as the "AMS", you can press the [SW1] or [SW2] key when desired to turn on the vibrato effect.

### Filter (Cutoff) Frequency (Program P3: 3-2c)

The cutoff frequency of filter A/B can be controlled by the pitch/amp EG, controllers, or tempo. Set "AMS" and "Intensity" for Filter A or B.

- If you select **JS X** or **Ribbon:CC#16** as the "AMS" and set "Intensity" to a **positive (+)** value, moving the joystick or ribbon controller toward the right will raise the cutoff frequency, and moving it toward the left will lower the cutoff frequency. **Negative (-)** settings will have the opposite effect.

Parameter	AMS → AMS Value → AMS Intensity	PEG/FEG -99...0...+99	AEG 0...+99
Pitch	(+12.00)	-1...0...+1[Octave]	0...+1[Octave]
Pitch EG Int.	(+12.00)	-	-
Pitch LFO1/2 Int.	(+12.00)	-1...0...+1[Octave]	0...+1[Octave]
Filter Frequency *6	(+99)	-99...0...+99	0...+99
Resonance	(+99)	-99...0...+99	0...+99
Filter EG Int.	(+99)	-	-
Filter LFO1/2 Int.	(+99)	-99...0...+99	0...+99
Amp	(+99)	value x(0...1...8)	-
Amp LFO1/2 Int.	(+99)	-99...0...+99	0...+99
Pan *7	(+50)	-63...0...+63	0...+63
EG Level	(+66)	-	-
EG Time	(+49)	-	-
LFO Frequency	(+99)	value x(1/64...1...64)	value x(1...64)

- If you select the same controller as an “AMS” and set separate intensities for Filter A (Low Pass Filter) “Intensity” and Filter B (High Pass Filter) “Intensity,” you can operate a single controller to simultaneously control the cutoff frequencies of both filters.

### Resonance (Program P3: 3–1b)

This can be used when the “Filter Type” is **Low Pass Resonance**. The resonance level can be controlled by EG, LFO, keyboard tracking, controllers or tempo etc.

- If you select **Filter KTrk** or **Amp KTrk** as the “AMS”, you can use the filter or amp keyboard tracking settings to control the resonance level. For example if the amp keyboard tracking parameters “Ramp Low” and “Ramp High” are set to **positive (+)** values, **Amp KTrk [+/-]** is selected as the “AMS”, and “Intensity” it set to a **positive (+)** value, playing toward either end of the keyboard will cause amp keyboard tracking to increase the volume, and “AMS” to raise the resonance level.
- You can select a controller as the “AMS”, and apply resonance when desired by operating the controller.
- You can select LFO1 or 2 as the “AMS”, and use the LFO to modulate the resonance level.

### Filter EG Intensity (Program P3: 3–2b)

Filter EG intensity can be controlled by a controller or tempo etc. You can use “Intensity to A” and “Intensity to B” to independently specify the intensity for Filter A and B.

- If you select **JS -Y:CC#02** as the “AMS” and set “Int to A” and “Int to B” to a **positive (+)** value, moving the joystick in the -Y direction will gradually increase the effect of the Filter EG. If you set “Int to A” and “Int to B” to a **negative (-)** value, the effect of the Filter EG will be inverted.
- If you select **Ribbon:CC#16** as the “AMS” and set “Int to A” and “Int to B” to a **positive (+)** value, operating the ribbon controller toward the right will gradually increase the effect of the Filter EG. Operating the ribbon controller toward the left will gradually increase the effect of the Filter EG with an inverted phase.

### Filter LFO 1/2 Intensity (Program P3: 3–3a, 3–3b)

The LFO 1/2 filter modulation intensity can be controlled by EG, keyboard tracking, controller, or tempo. You can use “Intensity to A” and “Intensity to B” to independently specify the intensity for Filter A and B.

- If you select **EG** as the “AMS”, the auto-wah effect produced by LFO modulation will be controlled by the changes in EG level. If you set “Intensity to A” and “Intensity to B” to a **positive (+)** value, the wah effect will deepen as the EG level rises, and will lessen as the EG level falls. With **negative (-)** values of “Intensity to A” and “Intensity to B,” the phase of the LFO will be inverted.

- If you use a controller such as **SW1** or **2** as the “AMS”, you can apply the auto-wah effect when desired by pressing the [SW1] or [SW2] key.

### Amp (Program P4: 4–2b)

The volume can be controlled by the pitch/filter EG, controllers, or tempo etc.

- If an EG or controller that changes with a **positive (+)** value (**Amp EG, EXT(+), EXT(SW)**) is selected as the “AMS”, setting the “Intensity” to **+99** will allow you to increase the volume to a maximum of eight times that of the current volume.
- If an EG, LFO, or controller that changes with a **± value (Pitch EG, Filter EG, LFO, KT, EXT(+/-))** is selected as the “AMS”, setting the “Intensity” to **+99** will allow you to increase the volume to a maximum of eight times that of the current volume (for positive (+) changes of the “AMS”), or to decrease the volume to zero (for negative (-) changes of the “AMS”).
- In addition to the time-variant changes in volume produced by the amp EG, you can also make the volume change in synchronization with the pitch/filter EG. Select **PitchEG** or **FilterEG** as the “AMS”, and adjust “Intensity.” If you wish to cancel the effect of the AmpEG and use the pitch/filter EG to control the volume, set all levels of the AmpEG to **+99**.

### Amp LFO 1/2 Intensity (Program P4: 4–2c)

The amp modulation intensity of LFO 1/2 can be controlled by EG, keyboard tracking, controllers, or tempo etc.

- If you select **EG** as the “AMS”, the depth of the tremolo effect produced by LFO modulation will change in synchronization with the changes in EG level. If you set “Intensity” to a **positive (+)** value, the tremolo effect will deepen as the EG level rises, and lessen as the EG level falls. If “Intensity” is set to a **negative (-)** value, the phase of the LFO will be inverted.
- If select a controller such as **SW1** or **2** as the “AMS”, you can apply the tremolo effect by pressing the [SW1] or [SW2] key when desired.

### Pan (Program P4: 4–1b)

The oscillator pan can be controlled by EG, LFO, keyboard tracking, controllers, or tempo etc.

- If you select **Note Number** as the “AMS” and set “Intensity” to **+50**, panning will be controlled by the keyboard position: center at the C4 note, far right at C6 or above, and far left at C2 or below.
- If EG is selected as the “AMS”, the oscillator pan will be controlled in synchronization with the changes in **EG** level. If “Intensity” is set to a **positive (+)** value, the pan will move toward the right as the EG level increases, and toward the left as the EG level decreases. If “Intensity” is set to a **negative (-)** value, the opposite effect will occur.

LFO1/2 -99...0...+99	KT(Fit KTrk, Amp KTrk) -99...0...+99	KT(Note Number) *1 ...36(C2)...60(C4)...84(C6)...	JS X/Ribbon:CC#16 -Max...0...+Max	EXT(+)*2 0...127	EXT(+/-)*3 -Max...0...+Max	EXT(Tempo)*4 (↓) = ...60...120...240...
dedicated parameter - -	-1...0...+1[Octave] -1...0...+1[Octave] -1...0...+1[Octave]	dedicated parameter ...-1...0...+1...[Octave] ...-1...0...+1...[Octave]	-1...0...+1[Octave]*5 -1...0...+1[Octave] -1...0...+1[Octave]	0...+1[Octave] 0...+1[Octave] 0...+1[Octave]	-1...0...+1[Octave] -1...0...+1[Octave] -1...0...+1[Octave]	...-1...0...+1...[Octave] ...-1...0...+1...[Octave] ...-1...0...+1...[Octave]
dedicated parameter -99x2...0...+99x2 - -	- -99...0...+99 - -99...0...+99	- ...-99...0...+99... - ...-99...0...+99...	-99...0...+99 -99...0...+99 -99...0...+99 -99...0...+99	0...+99 0...+99 0...+99 0...+99	-99...0...+99 -99...0...+99 -99...0...+99 -99...0...+99	...-99...0...+99... ...-99...0...+99... ...-99...0...+99... ...-99...0...+99...
dedicated parameter - -127...0...+127	- -99...0...+99 -63...0...+63	- ...-99...0...+99... ...-63...0...+63...	value x(0...1...8) -99...0...+99 -63...0...+63	value x(1...8) 0...+99 0...+63	value x(0...1...8) -99...0...+99 -63...0...+63	value x(0...1...8...) ...-99...0...+99... ...-63...0...+63...
- - value x(1/128...1...128)	-99...0...+99 value x(1/64...1...64) value x(1/64...1...64)	-99...0...+99 value x(...1/64...1...64...) value x(...1/64...1...64...)	-99...0...+99 value x(1/64...1...64) value x(1/64...1...64)	0...+99 value x(1...64) value x(1...64)	-99...0...+99 value x(1/64...1...64) value x(1/64...1...64)	-99...0...+99 value x(...1/64...1...64...) value x(...1/64...1...64...)*8



## EG Level - Pitch EG (Program P2: 2–3b)

### Filter EG (Program P3: 3–4b)

### Amp EG (Program P4: 4–3b)

EG levels can be controlled by keyboard tracking, controllers, or tempo etc.

Set the “Intensity” value, and select +/-/0 for each EG segment (“St” start, “At” attack, “Br” break) to specify the direction of the effect (if any) on that segment.

+: AMS will function according to the Intensity setting.

-: The sign of the Intensity setting will be inverted.

0: AMS will have no effect.

If “Intensity” is set to +66, the various EG levels can be controlled over a maximum range of ±99.

- Set “AMS” to **Velocity** for Amp EG Level Modulation, “Intensity” to +66, “St” to 0, “At” to +, and “Br” to -. Set all Amp EG levels to +00. As you play with increasing velocity, the EG levels will change more greatly. At the maximum velocity, the Start Level will stay at +00, but the Attack Level will change to +99 and the Break Level will change to -99.

## EG Time - Pitch EG (Program P2: 2–3c)

### Filter EG (Program P3: 3–4c)

### Amp EG (Program P4: 4–3c)

EG times can be controlled by keyboard tracking, controllers, or tempo etc. Set the “Intensity” value, and select +/-/0 for each EG segment (“At” attack, “Dc” decay, “Sl” slope, “Rl” release) to specify the direction of the effect (if any) on that segment.

+: AMS will function according to the Intensity setting.

-: The sign of the Intensity setting will be inverted.

0: AMS will have no effect.

Each EG time is determined by the Alternate Modulation value at the moment that the corresponding EG point is reached. For example, the Alternate Modulation value at the moment that the Attack Level is reached will determine the Decay Time.

If “Intensity” is set to a value of **8, 17, 25, 33, 41, or 49**, the corresponding time can be multiplied by a maximum of 2, 4, 8, 16, 32, or 64 times (or divided by 1/2, 1/4, 1/8, 1/16, 1/32, 1/64).

- Select **JS +Y:CC#01** for “AMS,” and set “AMS Intensity” to +8, “At” to +, “Dc” to -, and “Sl” and “Rl” to 0. When you move the joystick in the +Y direction, the Attack Time will be lengthened by a maximum of 2 times. The Decay Time will be shortened by a maximum of 1/2. The Slope and Release times will not change.

## LFO Frequency (Program P5: 5–1b)

The frequency of LFO 1 or 2 can be controlled by EG, keyboard tracking, controllers, or tempo etc., You can even use the LFO2 frequency to modulate the LFO1 frequency.

If “Intensity” is set to a value of **16, 33, 49, 66, 82, or 99**, the corresponding frequency can be multiplied by a maximum of 2, 4, 8, 16, 32, or 64 times (or divided by 1/2, 1/4, 1/8, 1/16, 1/32, 1/64).

- Select **JS +Y:CC#01** for “AMS,” and set “Intensity” to +16. When you move the joystick in the +Y direction, the LFO frequency will be increased by a maximum of 2 times. If you set “Intensity” to -16 and move the joystick in the +Y direction, the LFO frequency will be decreased by up to 1/2.

## Dynamic Modulation Source (Dmod)

You can control certain effect parameters using the joystick, ribbon controller, etc. “on the fly.” Controlling effects in this way is referred to as **Dynamic Modulation**. For example, you can use After Touch to speed up the LFO of the chorus and flanger, or you can use the ribbon controller to activate the wah effect. In this way, you will be able to take full advantage of the effects as part of the expressive potential of your instrument.

Most of the parameters for dynamic modulation consist of parameter values for “Src” (source) and “Amt” (amount). The Src field selects the modulation source, and “Amt” sets the amount of dynamic modulation effect. When the modulation source is set to the maximum value, the actual degree of the effect will be the parameter value plus the “Amt” value.

**MIDI** In Program and Sampling modes, dynamic modulation of the insertion effects and master effects is controlled via the global MIDI Channel. (In Sampling mode, only the insertion effects can be used.)

In Combination, Sequencer, and Song Play modes, dynamic modulation for the insertion effects and master effects is controlled on the MIDI channel independently specified by the “Ctrl Ch” for IFX1–5, MFX1, and MFX2.

**Example: “Wet/Dry” 10:90, “Src” After Touch, “Amt” +50**

In this case, the effect balance is 10:90. As you apply After Touch, the percentage of the effect sound will increase. When After Touch is at its maximum, the effect balance will be 60:40.

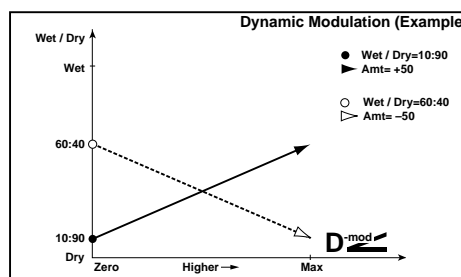

**⚠** The dynamic modulation effect will not be affected if you modify the “Amt” value while dynamic modulation is being applied. The change will become effective when you operate the dynamic modulation source again.

Refer to the corresponding effect section for an explanation of other dynamic modulation parameters.

In the table of parameters for each effect, dynamic modulation parameters are marked by a **D<sup>mod</sup>** symbol at the right of the parameter.

## Dynamic Modulation Source List

Source name	Explanation
Off	dynamic modulation is not used
Gate1	note on/off (p.247)
Gate1+Dmpr (Gate1+Damper)	note on + damper on/off (p.247)
Gate2	note on/off (retrigger) (p.247)
Gate2+Dmpr (Gate2+Damper)	note on + damper on/off (retrigger) (p.247)
Note Number	note number
Velocity	Velocity
After Touch	after touch (Channel After Touch)
JS X (Joy Stick X)	joystick X (horizontal) direction
JS+Y: CC#01 (Joy Stick +Y: CC#01)	joystick +Y (Vertical upward) direction (CC#01)
JS-Y: CC#02 (Joy Stick -Y: CC#02)	joystick Y (Vertical downward) direction (CC#02)
Pedal: CC#04 (Foot Pedal: CC#04)	assignable foot pedal (CC#04) (p.247)
FXCtrl1: #12 (FX Control1: CC#12)	MIDI effect control 1(CC#12)
FXCtrl2: #13 (FX Control2: CC#13)	MIDI effect control 2(CC#13)
Ribbon: #16 (Ribbon: CC#16)	ribbon controller (CC#16)
Slider: #18 (Value Slider: CC#18)	value slider (CC#18) (p.247)
KnobM1: #17 (Knob Mod1: CC#17)	realtime control knob 1 in B-mode (knob modulation 1 CC#17) (p.247)
KnobM2: #19 (Knob Mod2: CC#19)	realtime control knob 2 in B-mode (knob modulation 2 CC#19) (p.247)
KnobM3: #20 (Knob Mod3: CC#20)	realtime control knob 3 in B-mode (knob modulation 3 CC#20) (p.247)
KnobM4: #21 (Knob Mod4: CC#21)	realtime control knob 4 in B-mode (knob modulation 4 CC#21) (p.247)
KnobM1 [+] (Knob Mod1: CC#17 [+])	realtime control knob 1 in B-mode [+] (p.248)
KnobM2 [+] (Knob Mod2: CC#19 [+])	realtime control knob 2 in B-mode [+] (p.248)
KnobM3 [+] (Knob Mod3: CC#20 [+])	realtime control knob 3 in B-mode [+] (p.248)
KnobM4 [+] (Knob Mod4: CC#21 [+])	realtime control knob 4 in B-mode [+] (p.248)
Damper: #64 (Damper: CC#64)	damper pedal (CC#64)
Prta.SW: #65 (Portamento Switch: CC#65)	portamento switch (CC#65)
Sostenu: #66 (Sostenuto: CC#66)	sostenuto pedal (CC#66)
SW 1: CC#80 (SW1 Mod.: CC#80)	assignable panel switch 1 (SW1 modulation CC#80) (p.248)
SW 2: CC#81 (SW2 Mod.: CC#81)	assignable panel switch 2 (SW2 modulation CC#81) (p.248)
Foot SW: #82 (Foot Switch: CC#82)	assignable foot switch (CC#82) (p.248)
MIDI: CC#83	MIDI Control Change (CC#83)
Tempo	tempo (internal clock or external MIDI clock tempo data) (p.248)

### Gate1, Gate1+Dmpr (Gate1+Damper)

The effect is at maximum during note-on, and will stop when all keys are released. With **Gate1 + Dmpr**, the effect will remain at maximum even after the keys are released, as long as the damper (sustain) pedal is pressed.

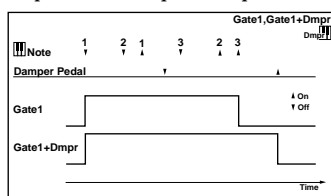

### Gate2, Gate2+Dmpr (Gate2+Damper)

This is essentially the same as for Gate 1 or Gate 1 + Dmpr. However when **Gate 2** or **Gate 2 + Dmpr** are used as a dynamic modulation source for the EG of 022: St. Envelope Flanger etc. or the AUTOFADE of 027: Stereo Vibrato, a trigger will occur at each note-on. (In the case of Gate 1 and Gate 1 + Dmpr, the trigger occurs only for the first note-on.)

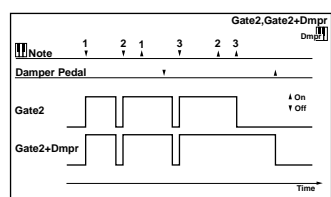

### Pedal: CC#04 (Foot Pedal: CC#04)

If you wish to use the assignable foot pedal as a dynamic modulation source, set "Foot Pedal Assign" (Global P2: Controller 2-1a) to **Foot Pedal (CC#04)**. ("Foot Pedal Assign.") A foot controller etc. connected to the ASSIGNABLE PEDAL jack can be used to control an effect.

### Slider: #18 (Value Slider: CC#18)

When the "Program No.: name" or "Combination No.: name" edit cell is selected in Program mode or Combination mode, the [VALUE] slider will function as a controller corresponding to CC#18.

### KnobM1: #17 (Knob Mod1: CC#17)

### KnobM2: #19 (Knob Mod2: CC#19)

### KnobM3: #20 (Knob Mod3: CC#20)

### KnobM4: #21 (Knob Mod4: CC#21)

If you wish to use a REALTIME CONTROLS knob [1]-[4] as a dynamic modulation source, make settings in Program, Combination, Song, Song Play, or Sampling modes to set the Controller page parameter "Realtime Control Knobs B-Assign" to the following settings respectively: "Knob1-B" to **KnobMod1 (CC#17)**, "Knob2-B" to **KnobMod2 (CC#19)**, "Knob3-B" to **KnobMod3 (CC#20)**, or "Knob4-B" to **KnobMod4 (CC#21)**. ("Knob1...4-B Assign")

When you set REALTIME CONTROLS to B-mode and operate knobs [1]-[4], the effect will be controlled.

Moving the knob to the 12 o'clock position will produce an effect of 0 as the dynamic modulation source. If "Amt" is a positive (+) value, rotating the knob toward the right will produce a positive change in the effect, and rotating it toward the left will produce a negative change. (With negative (-) values, the opposite effect will result.)

KnobM1 [+] (Knob Mod1: CC#17 [+])

KnobM2 [+] (Knob Mod2: CC#19 [+])

KnobM3 [+] (Knob Mod3: CC#20 [+])

KnobM4 [+] (Knob Mod4: CC#21 [+])

These differ from KnobMod1:CC#17-KnobMod4:CC#21 in the knob position and direction of the effect. If "Amt" is set to a positive (+) value, rotating the knob to the far right will produce an effect of 0 as the dynamic modulation source. Rotating the knob toward the right will apply an effect only in the positive direction. (With negative (-) settings, the opposite effect will result.)

SW 1: CC#80 (SW1 Mod.: CC#80)

SW 2: CC#81 (SW2 Mod.: CC#81)

If you wish to use the [SW1] or [SW2] key as a dynamic modulation source, make settings in Program, Song, Song Play, or Sampling modes to set the Controller page parameter "Panel Switch Assign" to the following values respectively: "SW1" to SW1 Mod1 (CC#80), or "SW2" to SW2 Mod2 (CC#81) (≡ "SW1/2 Assign").

The effect will be controlled when you operate the [SW1] or [SW2] key.

Foot SW: #82 (Foot Switch: CC#82)

If you wish to use an assignable foot switch as a dynamic modulation source, set "Foot Switch Assign" (Global P2: Controller 2-1a) to Foot SW (CC#82) (≡ "Foot Switch Assign").

The effect will be controlled when you operate a foot switch etc. connected to the ASSIGNABLE SWITCH jack.

### Tempo

Modulation sources other than **Tempo** are internally processed as a value of 0-127 (-128 - +127). In contrast, **Tempo** uses the tempo data (BPM value) of the internal clock or the external MIDI clock. This means that when "♪" is 127 (BPM), it will have the same result as the maximum value (+127) of other modulation sources.

## About the BPM/MIDI SYNC function

BPM/MIDI SYNC can be used for most effects that have an LFO, such as **009:St. Wah/Auto Wah**, and for some delay-type effects such as **049:L/C/R BPM Delay**. You can apply modulation that is synchronized to the tempo, or specify the delay time in terms of a note value so that the effect will synchronize to the tempo of the arpeggiator or sequencer during a live performance even if you change the tempo.

Parameters that allow BPM/MIDI SYNC to be used are marked by a  symbol at their right in the list of parameters for each effect.

### Example 1. LFO

"BPM/MIDI Sync" On

"Base Note" ♩

"Times" x1

In this case, each cycle of the LFO will be as long as one quarter note.

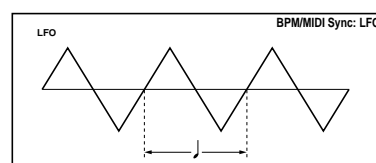

If "BPM" is set to **MIDI**, the effect will synchronize to the tempo of the arpeggiator or sequencer (or to an external MIDI clock). If "BPM" is in the range of **40-240**, the specified value will be used.

### Example 2. Delay Time

"L Delay Base Note" ♩

"Times" x1

"R Delay Base Note" ♪

"Times" x3

In this case, the delay time of the left channel will be the duration of an eighth note, and the delay time of the right channel will be the duration of a sixteenth note triplet.

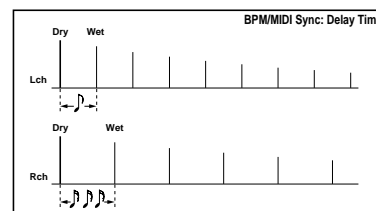

When "BPM" is set to **MIDI**, the effect will synchronize to the tempo of the arpeggiator or sequencer (or to an external MIDI clock). If "BPM" is in the range of **40-240**, the specified value will be used.

If the tempo, "Base Note," and "Times" settings in conjunction would cause the maximum delay time to be exceeded, a warning such as "Time Over? >OVER!!" will appear in the display. Please modify your settings so that this setting does not appear. (The maximum delay time will depend on the effect type.)

## SW1/2 Assign

The following functions can be assigned to the [SW1] or [SW2] keys.

Set the “Panel Switch Assign” parameters in each mode to make these assignments.

- Program P1: Controller page (1–4a).
- For a combination, assignments are set by Combination P4: Controller page (4–4a).
- For songs in Sequencer mode, assignments are set by Sequencer P4: Controller page (4–7a).
- Song Play P2: Controller page (2–1a).
- Sampling P4: Controller page (4–1a).

**note** These settings can be made in Program mode for each program, in Combination mode for each combination, and in Sequencer mode for each song. In Song Play mode and Sampling mode, these settings are made for the entire mode.

## SW1, SW2 Assign List

Off	no function
SW1 Mod.:CC#80 (SW1 Modulation:CC#80) SW2 Mod.:CC#81 (SW2 Modulation:CC#81)	Select this when using the switch as an Alternate Modulation or Effect Dynamic Modulation source. In this case, you must first specify the control destination. Each time the switch is turned On/Off, a CC#80 (or CC#81) message will be transmitted (Off: 0, On: 127). (p.249)
Porta.SW:CC#65 (Portamento Switch:CC#65)	When you press SW1 (or SW2) to turn it on (LED lit), portamento will be applied. Each time this is turned On/Off, CC#65 will be transmitted (Off: 0, On: 127). (p.249)
Octave Down	Each time you press SW1 (or SW2), the pitch will alternate between 1 octave lower and the original octave setting (1 octave down when the LED is lit).
Octave Up	Each time you press SW1 (or SW2), the pitch will alternate between 1 octave higher and the original octave setting (1 octave up when the LED is lit).
JS X Lock	Lock the effect of the joystick X direction. (p.249)
JS+Y Lock	Lock the effect of the joystick +Y direction. (p.249)
JS-Y Lock	Lock the effect of the joystick -Y direction. (p.249)
Ribbon Lock	Lock the effect of the ribbon controller. (p.249)
JS X & Ribbon Lock	Simultaneously lock the effects of the joystick X direction and the ribbon controller. (p.249)
JS+Y & Ribbon Lock	Simultaneously lock the effects of the joystick +Y direction and the ribbon controller. (p.249)
JS-Y & Ribbon Lock	Simultaneously lock the effects of the joystick -Y direction and the ribbon controller. (p.249)
After Touch Lock	Lock the effect of after touch. (p.249)

**SW1 Mod.:CC#80 (SW1 Modulation:CC#80)**

**SW2 Mod.:CC#81 (SW2 Modulation:CC#81)**

This effect differs between SW1 and SW2. SW1 is handled as CC#80, and SW2 is handled as CC#81.

**Porta.SW:CC#65 (Portamento Switch:CC#65)**

When Program P1: Edit-Basic “Oscillator Mode” (Program P1: 1–1a) is **Single**, turning the switch on (LED lit) will apply portamento regardless of the P2: Edit-Pitch “Enable” (Program P2: 2–1c) setting, and turning the switch off will not apply portamento.

If “Oscillator Mode” (1–1a) is **Double**, and if the P2: Edit-Pitch “Enable” (2–1c) setting is the same for OSC1 and 2 (i.e., Enable or Disable for both OSC1 and 2), then portamento will be applied to OSC1 and 2 when the switch is turned **on** (LED lit), and portamento will not be applied to OSC1 and 2 when the switch is turned **off** (LED dark). If the P2: Edit-Pitch “Enable” (Program P2: 2–1c) setting is different for OSC1 and 2 (i.e., OSC1 is Enable and OSC2 is Disable, or OSC1 is Disable and OSC2 is Enable), then portamento will be applied to the OSC whose setting is Enable when the switch is turned **on** (LED lit), and portamento will be applied to neither OSC when the switch is turned **off** (LED dark).

**JS X Lock, JS+Y Lock, JS-Y Lock, Ribbon Lock, JS X & Ribbon Lock, JS+Y & Ribbon Lock, JS-Y & Ribbon Lock, After Touch Lock**

The state of the selected controller (joystick, ribbon controller, after touch) will alternate between Lock and Unlock (Lock when the LED is lit).

While the joystick or after touch is being operated, turning Lock on will lock (fix) the effect at the current position of that controller. If Lock is turned on for the ribbon controller, the effect at that time will be held even after you release your finger from the ribbon controller. If Lock is off, releasing your finger from the ribbon controller will reset the effect to the center position.

For example if you select JS (+Y) Lock, move the joystick away from yourself, and then turn Lock on, the operation produced by the joystick (+Y) will be locked (held) at that position. Even if you return the joystick to its original position, the modulation will continue to apply. At this time you can even move the joystick in the -Y direction to apply both types of modulation (joystick +Y and -Y) simultaneously.

**MIDI** When you Lock the joystick or after touch, MIDI transmission of the corresponding controller will be halted, but reception will still occur. BG p.26

## Knob 1...4 B-Assign

The following functions can be assigned to the REALTIME CONTROLS [1]-[4] knobs in B-mode.

Set the "Realtime Control Knobs B-Assign" parameters in each mode to make these assignments.

- Program P1: Controller page (1-4b).
- Combination P4: Controller page (4-4b).
- Sequencer P4: Controller page (4-7b).

- Song Play P2: Controller page (2-1b).
- Sampling P4: Controller page (4-1b).

**MIDI** These settings can be made in Program mode for each program, in Combination mode for each combination, and in Sequencer mode for each song. In Song Play mode and Sampling mode, these settings are made for the entire mode.

## Realtime Control Knobs B-Assign List

Off	No function
Knob Mod. 1 (CC#17)	General purpose controller. Alternate Modulation or Effect Dynamic Modulation can be controlled. To use this, select <b>KnobMod1:#17</b> for "AMS," or <b>KnobM1:#17</b> for "Dmod Src." Simultaneously, CC#17 will be transmitted.
Knob Mod. 2 (CC#19)	General purpose controller. Alternate Modulation or Effect Dynamic Modulation can be controlled. To use this, select <b>KnobMod2:#19</b> for "AMS," or <b>KnobM2:#19</b> for "Dmod Src." Simultaneously, CC#19 will be transmitted.
Knob Mod. 3 (CC#20)	General purpose controller. Alternate Modulation or Effect Dynamic Modulation can be controlled. To use this, select <b>KnobMod3:#20</b> for "AMS," or <b>KnobM3:#20</b> for "Dmod Src." Simultaneously, CC#20 will be transmitted.
Knob Mod. 4 (CC#21)	General purpose controller. Alternate Modulation or Effect Dynamic Modulation can be controlled. To use this, select <b>KnobMod4:#21</b> for "AMS," or <b>KnobM4:#21</b> for "Dmod Src." Simultaneously, CC#21 will be transmitted.
Master Volume	Control the volume. Simultaneously, the universal system exclusive message Master Volume [F0H, 7FH, nn, 04, 01, vv, mm, F7H] will be transmitted to adjust the volume of all tracks or timbres (while preserving the volume balance between tracks or timbres).
Portamento Time (CC#05)	Control the portamento time. Simultaneously, CC#5 will be transmitted.
Volume (CC#07)	Control the volume. Simultaneously, CC#7 will be transmitted.
Post IFX Pan (CC#08)	Control the panning after the insertion effect. Simultaneously, CC#8 will be transmitted.
Pan (CC#10)	Control the oscillator panning. Simultaneously, CC#10 will be transmitted.
Expression (CC#11)	Control the expression. Simultaneously, CC#11 will be transmitted.
FX Control 1 (CC#12)	Control Effect Dynamic Modulation. When controlling this, set "Dmod Src" to <b>FXCtrl1:#12</b> . Simultaneously, CC#12 will be transmitted.
FX Control 2 (CC#13)	Control Effect Dynamic Modulation. When controlling this, set "Dmod Src" to <b>FXCtrl2:#13</b> . Simultaneously, CC#13 will be transmitted.
LFP Cutoff (CC#74)	Control the cutoff frequency of the filter (low pass filter). Simultaneously, CC#74 will be transmitted.
Resonance/HPF (CC#71)	Control the resonance of the filter, or the cutoff frequency of the high pass filter. If the program's "Filter Type" is <b>Low Pass Resonance</b> , the resonance level will be controlled. If it is <b>Low Pass &amp; High Pass</b> , the cutoff frequency of the high pass filter will be controlled. Simultaneously, CC#71 will be transmitted.
Filter EG Int. (CC#79)	Control the EG intensity of the filter. Simultaneously, CC#79 will be transmitted.
F/A Attack (CC#73)	Control the EG attack of the filter and amplifier. Simultaneously, CC#73 will be transmitted.
F/A Decay (CC#75)	Control the EG decay time and slope time of the filter and amplifier. Simultaneously, CC#75 will be transmitted.
F/A Sustain (CC#70)	Control the EG sustain level of the filter and amplifier. Simultaneously, CC#70 will be transmitted.
F/A Release (CC#72)	Control the EG release time of the filter and amplifier. Simultaneously, CC#72 will be transmitted.
Pitch LFO1 Spd (CC#76)	Control the frequency of LFO1. Simultaneously, CC#76 will be transmitted.
Pitch LFO1 Dep (CC#77)	Control the LFO1 intensity of the pitch. Simultaneously, CC#77 will be transmitted.
Pitch LFO1 Dly (CC#78)	Control the delay of LFO1. Simultaneously, CC#78 will be transmitted.
SW 1 Mod. (CC#80)	General-purpose controller. Alternate Modulation or Effect Dynamic Modulation can be controlled. To control these, set "AMS" or "Dmod Src" to <b>SW1:CC#80</b> . Simultaneously, CC#80 will be transmitted.
SW 2 Mod. (CC#81)	General-purpose controller. Alternate Modulation or Effect Dynamic Modulation can be controlled. To control these, set "AMS" or "Dmod Src" to <b>SW2:CC#81</b> . Simultaneously, CC#81 will be transmitted.
Foot Switch (CC#82)	General-purpose controller. Alternate Modulation or Effect Dynamic Modulation can be controlled. To control these, set "AMS" or "Dmod Src" to <b>FootSW:#82</b> . Simultaneously, CC#82 will be transmitted.
MIDI CC#83 (CC#83)	General-purpose controller. Alternate Modulation or Effect Dynamic Modulation can be controlled. To control these, set "AMS" or "Dmod Src" to <b>MIDI:CC#83</b> . Simultaneously, CC#83 will be transmitted.
MFX Send 1 (CC#93)	Control the send level to Master Effect1. Simultaneously, CC#93 will be transmitted.
MFX Send 2 (CC#91)	Control the send level to Master Effect2. Simultaneously, CC#91 will be transmitted.
MIDI CC#00...CC#95	The specified MIDI control change (CC#) will be transmitted. If the TRITON STUDIO is set so as to be controlled by the control change message, the corresponding control will occur.

 The A-mode functions of the REALTIME CONTROLS are fixed.

**Knob1-A: LPF CUTOFF (Filter LPF Cutoff: CC#74)**

Control the low pass filter cutoff frequency of the filter. Simultaneously, CC#74 will be transmitted.

**Knob2-A: RESONANCE/HPF (Filter Resonance/HPF Cutoff: CC#71)**

Control the resonance level or the cutoff frequency of the high pass filter. If the program "Filter Type" is **Low Pass Resonance**, the resonance level will be controlled. If "Filter Type" is **Low Pass & High Pass**, the cutoff frequency of the high pass filter will be controlled. Simultaneously, CC#71 will be transmitted.

**Knob3-A: EG-Intensity (Filter EG Intensity: CC#79)**

Control the filter EG intensity. Simultaneously, CC#79 will be transmitted.

**Knob4-A: EG-Release (Filter, Amplifier EG Release: CC#72)**

Control the release time of the filter and amplifier EG. Simultaneously, CC#72 will be transmitted.

## Foot Switch Assign

You can assign the function of an assignable switch (Korg PS-1 option) connected to the ASSIGNABLE SWITCH jack.

- This setting is made in Global P2: Controller "Foot Switch Assign" (2-1a).

 If you select a function that includes a CC#, that MIDI control change message will be transmitted each time the switch is turned on/off. (Off: 0, On: 127)  
If you select Knob1...4, SW1, or 2, the MIDI control change message specified by the Knob1...4 B-Assign and SW1/2 Assign settings will be transmitted each time the foot switch is turned on or off. (Off: 0, On: 127)

**Portamento SW (CC#65)**

When the "Oscillator Mode" (Program P1: 1-1a) is **Single**, turning the switch **on** will apply portamento regardless of the P2: Edit-Pitch "Enable" (Program P2: 2-1c) setting, and turning the switch **off** will not apply portamento.

If "Oscillator Mode" is **Double**, and if the P2: Edit-Pitch "Enable" setting is the same for OSC1 and 2 (i.e., Enable or Disable for both OSC1 and 2), then portamento will be applied to OSC1 and 2 when the switch is turned **on**, and portamento will not be applied to OSC1 and 2 when the switch is turned **off**.

If the P2: Edit-Pitch "Enable" setting is different for OSC1 and 2 (i.e., OSC1 is Enable and OSC2 is Disable, or OSC1 is Disable and OSC2 is Enable), then portamento will be applied to the OSC whose setting is Enable when the switch is turned **on**, and portamento will be applied to neither OSC when the switch is turned **off**.

## Foot Switch Assign List

Off	The connected foot switch will not function.
Foot SW (CC#82)	Alternate Modulation or Effect Dynamic Modulation can be controlled. To control these, set "AMS" or "Dmod Src" to <b>Foot SW:#82</b> .
Portamento SW (CC#65)	Control portamento on/off.
Sostenuto (CC#66)	Control the sostenuto effect (which holds only the keys (Note No.) that were being held at the moment that the pedal switch was turned on).
Soft (CC#67)	Turn the soft pedal effect on/off.
Arpeggio SW	Turn the arpeggiator on/off. The NRPN message [Bn 63 00 Bn 62 02 Bn 06 00 (off) or 7F (on)] will be transmitted each time this is turned on/off.
Program Up	The switch can be used to select programs or combinations. When in Program P0: Play, the program that follows the currently selected program will be selected. When in Combination P0: Play, the combination that follows the currently selected combination will be selected. Simultaneously, a Bank Select message and Program Change message will be transmitted.
Program Down	The switch can be used to select programs or combinations. When in Program P0: Play, the program that precedes the currently selected program will be selected. When in Combination P0: Play, the combination that precedes the currently selected combination will be selected. Simultaneously, a Bank Select message and Program Change message will be transmitted.
Song Start/Stop	The switch can be used to start/stop the sequencer. Simultaneously, a MIDI Start or Stop message will be transmitted.
Song Punch In/Out	If Sequencer P0: Preference "Recording Setup" (0-7a) is set to <b>Manual Punch In</b> , the switch can be used to punch-in and punch-out when recording on the sequencer.
Cue Repeat Control	This can be used if in Sequencer P1: Cue List, the "Repeat" (1-1d) setting of each step has been set to <b>FS</b> . Turning the pedal switch on while that step is repeating will be the trigger for advancing to the next step. When the end of the song is reached, this will advance to the next step (song).
JS+Y (CC#01)	The switch will control the effect produced by joystick movement in the +Y direction (Vertical upward).
JS-Y (CC#02)	The switch will control the effect produced by joystick movement in the -Y direction (Vertical downward).
Ribbon (CC#16)	The switch will control the effect of the ribbon controller.
Slider (CC#18)	The switch will control the effect of the [VALUE] slider.
Knob 1...4	The switch will control the effect of REALTIME CONTROLS knobs [1]-[4]. (On produces the same effect as when the knob is rotated fully right, and Off as when it is rotated fully left.)
SW1, 2	The switch will control the effect of the [SW1] and [SW2] keys.

## Foot Pedal Assign

You can assign the function that will be controlled by an assignable pedal (Korg XVP-10 or EXP-2 option) connected to the ASSIGNABLE PEDAL jack.

- This setting is made in Global P2: Controller “Foot Pedal Assign” (2-1a).

**MIDI** If you select a function that includes a CC#, that MIDI control change message will be transmitted each time the switch is turned on/off. (Off: 0, On: 127)  
 If you select Knob1...4, the MIDI control change message specified by the Knob1...4 B-Assign settings will be transmitted each time the foot switch is turned on or off. (Off: 0, On: 127)

### Foot Pedal Assign List

Off	The connected pedal will not function.
Master Volume	Control the volume. Simultaneously, the universal exclusive message Master Volume [F0H, 7FH, nn, 04, 01, vv, mm, F7H] will be transmitted to control the volume of all timbres or tracks (while preserving the volume balance between timbres or tracks).
Foot Pedal (CC#04)	Alternate Modulation or Effect Dynamic Modulation can be controlled. To control these, set “AMS” or “Dmod Src” to <b>Pedal:CC#04</b> .
Portamento Time (CC#05)	Control the speed at which portamento will change the pitch.
Volume (CC#07)	Control the volume of a Program, of a timbre in a Combination, or of a track in Sequencer/Song Play modes.
Post IFX Pan (CC#08)	Control the pan after passing through the insertion effect.
Pan (CC#10)	Control the pan of a Program, of a timbre in a Combination, or of a track in Sequencer/Song Play modes.
Expression (CC#11)	Control the volume of a Program, of a timbre in a Combination, or of a track in Sequencer/Song Play modes. Expression is multiplied with the Volume value to determine the actual volume level.
FX Control 1 (CC#12)	Control Effect Dynamic Modulation. To control this, set Dmod Src to FXCtrl1:#12.
FX Control 2 (CC#13)	Control Effect Dynamic Modulation. To control this, set Dmod Src to FXCtrl2:#13.
MFx Send 1 (CC#93)	Control the send level to master effect 1 (MFx1) from a Program, a timbre in a Combination, or a track in Sequencer/Song Play modes. Simultaneously, this will also control the send level to master effect 1 (MFx1) from after the insertion effect of the matching MIDI channel.
MFx Send 2 (CC#91)	Control the send level to master effect 2 (MFx2) from a Program, a timbre in a Combination, or a track in Sequencer/Song Play modes. Simultaneously, this will also control the send level to master effect 2 (MFx2) from after the insertion effect of the matching MIDI channel.
JS+Y (CC#01)	Pedal operation will control the effect produced by joystick movement in the +Y direction (Vertical upward).
JS-Y (CC#02)	Pedal operation will control the effect produced by joystick movement in the -Y direction (Vertical downward).
Ribbon (CC#16)	Pedal operation will control the effect of the ribbon controller.
Slider (CC#18)	Pedal operation will control the effect of the [VALUE] slider.
Knob 1...4	Pedal operation will control the effect of REALTIME CONTROLS knobs [1]–[4].

## MIDI transmission when the TRITON STUDIO's controllers are operated

The following table shows the relation between the MIDI messages that are transmitted when the TRITON STUDIO's controllers are operated, and the AMS (alternate modulation source) or DMS (dynamic modulation source) that correspond to each MIDI message. # indicates a fixed function, and \* indicates an assignable function.

When one of the TRITON STUDIO's controllers is operated, the corresponding or the assigned control change will be transmitted. Pitch Bend messages will be transmitted only when the joystick is moved in the X (horizontal) direction. When Knob1...4 or SW1, 2 are selected for Assignable Switch or Assignable Pedal, the corresponding MIDI control change message will be transmitted according to the Knob1...4 B-Assign and SW1/2 Assign settings of each mode. The following page describes operation in each mode. (Only control changes are explained here, but the same applies to pitch bend.)

	TRITON STUDIO controller												Available for AMS	Available for DMOD				
	Joy Stick	Ribbon	Value Slider	Realtime Controls A	Realtime Controls B	Gate Knob	Velocity Knob	SW1,2	ARP On/Off	Damper	Assign-able Switch	Assign-able Pedal						
MIDI channel messages																		
	Note-off																	
	Note-on (note number)																*	*
	Note-on (velocity)																*	*
	Poly after touch																*	*
CC#	0 Bank select (MSB)					*												
	1 Modulation 1	# (+Y)				*					*	*				*	*	
	2 Modulation 2	# (-Y)				*					*	*				*	*	
	3 -					*												
	4 Foot controller					*											*	*
	5 Portamento time					*											*	*
	6 Data entry (MSB)					*											*	*
	7 Volume					*											*	*
	8 Post insertion effect panpot					*											*	*
	9 -					*												
	10 Panpot					*											*	*
	11 Expression					*											*	*
	12 Effect control 1					*											*	*
	13 Effect control 2					*											*	*
	14...15 -					*											*	*
	16 Ribbon controller	#				*					*	*				*	*	
	17 Knob modulation 1					*					*	*				*	*	
	18 Controller (CC#18)		#			*					*	*				*	*	
	19 Knob modulation 2					*					*	*				*	*	
	20 Knob modulation 3					*					*	*				*	*	
	21 Knob modulation 4					*					*	*				*	*	
	22...31 -					*											*	*
	32 Bank select (LSB)					*											*	*
	33...37 -					*											*	*
	38 Data entry (LSB)					*											*	*
	39...63 -					*											*	*
	64 Damper					*					#						*	*
	65 Portamento On/Off					*			*			*	*				*	*
	66 Sostenuito On/Off					*					*	*					*	*
	67 Soft					*					*	*					*	*
	68...69 -					*											*	*
	70 Sustain level					*											*	*
	71 Filter resonance level/High pass filter cutoff frequency				*	(Knob2)	*										*	*
	72 Release time				*	(Knob4)	*										*	*
	73 Attack time				*		*										*	*
	74 Low pass filter cutoff frequency				*	(Knob1)	*										*	*
	75 Decay time				*		*										*	*
	76 LFO1 speed				*		*										*	*
	77 LFO1 depth (pitch)				*		*										*	*
	78 LFO1 delay				*		*										*	*
	79 Filter EG intensity				*	(Knob3)	*										*	*
	80 SW1 modulation On/Off				*		*		*	(SW1)							*	*
	81 SW2 modulation On/Off				*		*		*	(SW2)							*	*
	82 Foot switch On/Off				*		*				*	*					*	*
	83 Controller (CC#83)				*		*										*	*
	84...90 -				*		*										*	*
	91 Effect depth 1 (send 2 level)				*		*										*	*
	92 Effect depth 2 (insertion effect 1,2,3,4,5 On/Off)				*		*										*	*
	93 Effect depth 3 (send 1 level)				*		*										*	*
	94 Effect depth 4 (master effect 1 On/Off)				*		*										*	*
	95 Effect depth 5 (master effect 2 On/Off)				*		*										*	*
	96 Data increment				*		*										*	*
	97 Data decrement				*		*										*	*
	98 NRPN(LSB)				*		*										*	*
	2: Arpeggiator on/off switch									#		*						
	10: Arpeggiator gate control								#									
	11: Arpeggiator velocity control								#									
	99 NRPN(MSB) 0				*		*		#		*						*	*
	100 RPN(LSB)				*		*		#		*						*	*
	0: Bend range				*		*										*	*
	1: Fine tune				*		*										*	*
	2: Coarse tune				*		*										*	*
	101 RPN(MSB) 0				*		*		#		*						*	*
	102...127 -				*		*		#		*						*	*
	Program change				*		*										*	*
	Channel after touch				*		*										*	*
	Bender change	# (X)															*	*
	Universal exclusive				*		*										*	*
	Master volume				*		*										*	*
	Master balance				*		*										*	*
	Master fine tune				*		*										*	*
	Master coarse tune				*		*										*	*



### Program mode

When one of the TRITON STUDIO's controllers is operated, a control change message will be transmitted on the global MIDI channel ("MIDI Channel" Global P1: 1-1a).

- 🔧 If the B-mode of a REALTIME CONTROLS [1]-[4] knob or the assignable pedal has been set to **Master Volume**, the universal system exclusive message Master Volume will be transmitted.

### Combination mode

When one of the TRITON STUDIO's controllers is operated, a control change message will be transmitted on the global MIDI channel ("MIDI Channel" Global P1: 1-1a).

Simultaneously, the message will also be transmitted on the MIDI channel ("MIDI Channel" Combination P2: 2-1a) of any timbre whose "Status" (Combination P0: 0-1f, P2: 2-1a) is **EXT** or **EX2**.

When one of the TRITON STUDIO's controllers is operated, its effect will apply to any timbre whose "Status" is **INT** and whose "MIDI Channel" setting is either **Gch** or the same as the global MIDI channel.

- 🔧 In the case of **Master Volume**, the universal exclusive message Master Volume will be transmitted only on the global MIDI channel.
- 🔧 You can make settings for MIDI Filter (Combination P3) to **enable** or **disable** control changes and controllers for each timbre. When **checked**, the above operations will be enabled.

Effect dynamic modulation can be controlled when the "Ctrl Ch" (Combination P8: 8-3a, P9: 9-2a, 9-4a) setting for IFX1-5, MFX1, 2, or MEQ is either set to **Gch** or to the same channel as the global MIDI channel. (In the case of **All Routed**, control is possible on the MIDI channel of any routed timbre.)

### Sequencer mode

When one of the TRITON STUDIO's controllers is operated, its effect will apply to the track 1-16 that is selected by "Track Select" (Sequencer P0: 0-1e).

If the "Status" (Sequencer P2: 2-1a/2-2a) of the track selected by "Track Select" is **EXT**, **EX2**, or **BTH**, a control change message will be transmitted on the MIDI channel specified by "MIDI Channel" (Sequencer P2: 2-1a/2a).

If the "Status" is **INT** or **BTH**, operating one of the TRITON STUDIO's controllers will affect only that track. Simultaneously, the same effect will also apply to any track with the same "MIDI Channel" setting.

- 🔧 In the case of **Master Volume**, the universal exclusive message Master Volume will be transmitted.
- 🔧 You can make settings for MIDI Filter (Sequencer P3) to **enable** or **disable** control changes and controllers for each track. When checked, the operations effective for a "Status" of **INT** or **BTH** will be enabled. Tracks whose "Status" is **EXT**, **EX2**, or **BTH** will transmit control changes regardless of this setting.

Effect dynamic modulation can be controlled when the "Ctrl Ch" (Sequencer P8: 8-4a, P9: 9-2a, 9-4a) setting for IFX1-5, MFX1, 2, or MEQ matches the MIDI channel of the track selected by "Track Select." (In the case of **All Routed**, control is possible on the MIDI channel of all routed tracks.)

If one of the TRITON STUDIO's controllers is operated during realtime recording, the corresponding or assigned control change will be recorded.

### Song Play mode

When one of the TRITON STUDIO's controllers is operated, the effect will apply to the track 1-16 that is selected by "Play (Track Select)" (Song Play P0: 0-1g).

If the "Status" (Song Play P1: 1-1a, 1-2a) of the track selected by "Play (Track Select)" is either **EXT** or **BTH**, control change messages will be transmitted on the MIDI channel of the track (or in the case of Song Play mode, on MIDI channels 1-16 for tracks 1-16).

If the "Status" is **INT** or **BTH**, operating one of the TRITON STUDIO's controllers will affect that track.

- 🔧 In the case of **Master Volume**, the universal exclusive message Master Volume will be transmitted.

Effect dynamic modulation can be controlled when the "Ctrl Ch" (Song Play P8: 8-4a, P9: 9-2a, 9-4a) setting for IFX1-5, MFX1, 2, or MEQ matches the MIDI channel of the track selected by "Track Select." (In the case of **All Routed**, control is possible on the MIDI channel of all routed tracks.)

### Sampling mode

When one of the TRITON STUDIO's controllers is operated, a control change message will be transmitted on the global MIDI channel ("MIDI Channel" Global P1: 1-1a).

- 🔧 In the case of **Master Volume**, the universal exclusive message Master Volume will be transmitted.
- 🔧 It is not possible to make AMS settings in Sampling mode.

## TRITON STUDIO operations when control changes are trans- mitted/received

The following table shows the operations that the TRITON STUDIO will perform when control change messages are received, and the relation between settings and controller movements on the TRITON STUDIO

CC#	Control	Value	Function
0	Bank select (MSB)	0...127	bank select message MSB *1
1	Modulation 1	0...127	corresponds to joystick movement in the +Y direction (Vertical upward)
2	Modulation 2	0...127	corresponds to joystick movement in the -Y direction (Vertical downward)
4	Foot controller	0...127	corresponds to when the assignable pedal function is set to <b>Foot Pedal</b>
5	Portamento time	0...127	portamento time
6	Data entry (MSB)	0...127	MSB of RPN and NRPN data *2
7	Volume	0...127	volume *3
8	Post insertion effect panpot	0...127	pan after the insertion effect
10	Panpot	0...127	pan
11	Expression	0...127	volume *3
12	Effect control 1	0...127	corresponds to effect dynamic control source FXCtrl1
13	Effect control 2	0...127	corresponds to effect dynamic control source FXCtrl2
16	Ribbon controller	0...127	corresponds to ribbon controller operation
17	Knob modulation 1	0...127	corresponds to when Knob Mod.1 is assigned as the B-mode function of a REALTIME CONTROLS knob
18	Controller (CC#18)	0...127	for control of Alternate Modulation or Effect Dynamic Modulation *8
19	Knob modulation 2	0...127	corresponds to when Knob Mod.2 is assigned as the B-mode function of a REALTIME CONTROLS knob
20	Knob modulation 3	0...127	corresponds to when Knob Mod.3 is assigned as the B-mode function of a REALTIME CONTROLS knob
21	Knob modulation 4	0...127	corresponds to when Knob Mod.4 is assigned as the B-mode function of a REALTIME CONTROLS knob
32	Bank select (LSB)	0...127	LSB of bank select message *1
38	Data entry (LSB)	0...127	LSB of RPN or NRPN data *2
64	Damper	0...127	damper effect
65	Portamento On/Off	0...63(Off), 64...127(On)	turn the portamento effect on/off
66	Sostenuto On/Off	0...63(Off), 64...127(On)	turn the sostenuto effect on/off
67	Soft	0...127	soft pedal effect
70	Sustain level	0...127	sustain levels of the filter EG and amp EG *4
71	Filter resonance level	0...127	resonance level of the filter *5
	High pass filter cutoff frequency	0...127	cutoff frequency of the high pass filter *4
72	Release time	0...127	release times of the filter EG and amp EG *4
73	Attack time	0...127	attack times of the filter EG and amp EG *4
74	Low pass filter cutoff frequency	0...127	cutoff frequency of the low pass filter *4
75	Decay time	0...127	decay times/slope times of the filter EG and amp EG *4
76	LFO1 speed	0...127	LFO1 speed *4
77	LFO1 depth	0...127	pitch LFO1 intensity *4
78	LFO1 delay	0...127	LFO1 delay *4
79	Filter EG intensity	0...127	filter EG intensity *4
80	Panel switch 1 On/Off	0...63(Off), 64...127(On)	corresponds to on/off when the SW1 function is set to SW1 Mod.
81	Panel switch 2 On/Off	0...63(Off), 64...127(On)	corresponds to on/off when the SW2 function is set to SW2 Mod.
82	Foot switch On/Off	0...63(Off), 64...127(On)	corresponds to on/off when the function of the assignable foot switch is set to Foot SW
83	Controller (CC#83)	0...127	for controlling Alternate Modulation or Effect Dynamic Modulation
91	Effect 1 depth	0...127	send 2 level
92	Effect 2 depth	0(Off), 1...127(On)	turn insertion effect 1, 2, 3, 4, 5 on/off *6
93	Effect 3 depth	0...127	send 1 level
94	Effect 4 depth	0(Off), 1...127(On)	master effect 1 on/off *6
95	Effect 5 depth	0(Off), 1...127(On)	master effect 2 on/off *6
96	Data increment	0	
97	Data decrement	0	
98	NRPN(LSB)	2 10 11	corresponds to the arpeggiator on/off switch *7 corresponds to the arpeggiator Gate control knob *7 corresponds to the arpeggiator Velocity control knob *7
99	NRPN(MSB)	0	MSB of NRPN
100	RPN(LSB)	0 1 2	select the pitch bend range *2 select Fine Tune *2 select Coarse Tune *2
101	RPN(MSB)	0	MSB of RPN

 Any control change number (CC#00-95) can be assigned as the B-mode function of a REALTIME CONTROLS knob. In this case, the transmitted values will all be 0-127.

\*1 On the TRITON STUDIO's sequencer, bank select messages are normally specified as a program change event ("Event Edit" Sequencer P5: 5-1B). However in some cases this will be insufficient when you wish to change banks on an external device. In such cases, you can use CC#00 and CC#32 to specify the banks.

For information on the relation between bank select numbers and the banks of your external device, refer to the owner's manual for your external device.

\*2 Unlike conventional control changes, pitch bend range, fine tune, and coarse tune settings are made using RPC (Registered Parameter Control) messages. In Program, Combination, Sequencer, and Song Play modes, you can use RPC messages to control the bend range and tuning for each program, combination (Combination), or track (Sequencer, Song Play). The procedure is to use an RPN (Registered Parameter Number) message to select the parameter that you wish to edit, and then use Data Entry to input a value for that parameter. To select the parameter, use CC#100 (with a value of 00-02) and CC#101 (with a value of 00). use CC#06 and CC#38 to enter the data. The data entry values for each parameter and the corresponding settings are as follows.

**RPN=0 (Pitch bend range)**

CC#06	CC#38	Parameter value (Semitone steps)
00	00	0
01	00	+ 1
⋮	⋮	⋮
12	0	+12

**RPN=1 (Fine tune)**

CC#06	CC#38	Parameter value (1 cent steps)
32	00	-50
⋮	⋮	⋮
48	00	-25
⋮	⋮	⋮
64	00	0
⋮	⋮	⋮
96	00	+50

**RPN=2 (Coarse tune)**

CC#06	CC#38	Parameter value (Semitone steps)
40	00	-24
⋮	⋮	⋮
52	00	-12
⋮	⋮	⋮
64	00	0
⋮	⋮	⋮
88	00	+24

For example, if in Sequencer mode you wish to set a track that is receiving channel 1 to a transpose (coarse tuning) value of -12, you would first transmit [B0, 64, 02] (64H=CC#100) and [B0, 65, 00] (65H=CC#101) to the TRITON STUDIO to select the RPN coarse tune. Then you would set this to -12 by transmitting [B0, 06, 34] (06H=CC#6), 34H=52 (corresponds to -12), and [B0, 26, 00] (26H=CC#38, 00H=0).

\*3 The volume of the TRITON STUDIO is determined by multiplying the Volume (CC#07) with the Expression (CC#11). In Sequencer and Song Play modes when you stop the song playback and return the location to the beginning of the track, the Volume will be set to the starting value, and the Expression will be set to the maximum value (127).

\*4 A value of 64 will correspond to the value specified by the program parameter. 0 will be the minimum, and 127 will be the maximum. Changing from 63-1 or from 65-126 will adjust the effect from the program parameter setting toward the minimum value or maximum value. The internal program parameters listed in (\*4, \*5) will be controlled.

\*5 If the filter type of the corresponding program is **Low Pass Resonance**, the filter resonance level will be controlled. If the filter type is **Low Pass & High Pass**, the cut-off frequency of the high pass filter will be controlled.

\*4, \*5

CC#70-79 correspond to the following program parameters of the TRITON STUDIO.

In Program mode, when CC#70-79 is received on the global MIDI channel ("MIDI Channel" Global P1: 1-1a), or when a REALTIME CONTROLS [1]-[4] knob is operated in A-mode or in B-mode when the function is assigned to CC#70-79, the corresponding program parameter will be edited temporarily. You can execute "Write Program" (Program 0-1A) to save that state (except for some parameters). When you execute "Write Program," the values of the corresponding program parameters will be rewritten.

In Sampling mode when playing the currently selected multisample on the keyboard, the same control changes or knob operations as in Program mode will temporarily edit the corresponding program parameters. You can use "Convert MS to Program" (Sampling 0-1G) to save that state as a program (except for some parameters).

▲ In Combination, Sequencer, and Song Play modes, the program parameters of the program for the timbre/track of the corresponding MIDI channel will change, but this state can not be saved directly in the program.

**CC#70: Sustain level**

Corresponds to "Filter/Amp EG Sustain Level" (Program P3: Filter 1/2 EG, P4: Amp 1/2 EG page).

**CC#71: Filter resonance level/High pass filter cutoff frequency**

Corresponds to "Filter A Resonance" (Program P3: Filter 1/2 page).

Corresponds to "Filter B Frequency" (Program P3: Filter 1/2 page).

**CC#72: Release time**

Corresponds to "Filter/Amp EG Release Time" (Program P3: Filter 1/2 EG page, P4: Amp 1/2 EG page).

**CC#73: Attack time**

Corresponds to Filter/Amp EG Attack Time" (Program P3: Filter 1/2 EG page, P4: Amp 1/2 EG page)

Corresponds to "Amp EG Start Level" (Program P4: Amp 1/2 EG page).

Corresponds to "Amp EG Attack Level" (Program P4: Amp 1/2 EG page).

Corresponds to "Amp EG Level Modulation St" (Program P4: Amp 1/2 EG page).

Corresponds to "Amp EG Time Modulation At" (Program P4: Amp 1/2 EG page).

**CC#74: Low pass filter cutoff frequency**

Corresponds to "Filter A Frequency" (Program P3: Filter 1/2 page).

Corresponds to "Filter B Frequency" (Program P3: Filter 1/2 page).

**CC#75: Decay time**

Corresponds to "Filter/Amp EG Decay Time" (Program P3: Filter 1/2 EG page, P4: Amp 1/2 EG page)

Corresponds to "Filter/Amp EG Slope Time" (Program P3: Filter 1/2 EG page, P4: Amp 1/2 EG page)

**CC#76: LFO1 speed**

Corresponds to "LFO 1 Frequency" (Program P5: OSC1/2 LFO1 page).

---

**CC#77: LFO1 depth (pitch LFO1 intensity)**

Corresponds to “Pitch LFO1 Intensity” (Program P2: OSC1/2 P.Mod page).

**CC#78: LFO1 delay**

Corresponds to “LFO1 Delay” (Program P5: OSC1/2 LFO1 page).

**CC#79: Filter EG intensity**

Corresponds to “Filter EG Intensity to A, B” (Program P3: Filter 1/2 Mod. page).

Different parameters are controlled for the bank I-F programs that are available when the EXB-MOSS option is installed. (☞EXB-MOSS owner’s manual)

\*6Controlled on the global MIDI channel.

\*7NRPN (Non Registered Parameter Number) and Data Entry can be used to control the following parameters.

**Arpeggiator on/off**

[Bn 63 00 Bn 62 02 Bn 06 nn] (nn:00–3F off, 40–7F on)

**Arpeggiator gate control**

[Bn 63 00 Bn 62 0A Bn 06 nn] (nn:00–7F)

**Arpeggiator velocity control**

[Bn 63 00 Bn 62 0B Bn 06 nn] (nn:00–7F)

\*8Corresponds to the operation of the [VALUE] slider as a controller in Program P0: “Program Select” or Combination P0: “Combination Select” is selected.

## MIDI applications

### About MIDI

MIDI stands for Musical Instrument Digital Interface, and is a world-wide standard for exchanging various types of musical data between electronic musical instruments and computers. When MIDI cables are used to connect two or more MIDI devices, performance data can be exchanged between the devices, even if they were made by different manufacturers.

### Connecting MIDI devices/computers (MIDI connectors)

**note** If the EXB-mLAN option is installed, the mLAN connector of the TRITON STUDIO can be connected to an external mLAN-compatible MIDI device or FireWire-capable Macintosh to receive and transmit MIDI. For details on connections, refer to the "EXB-mLAN owner's manual" included with the EXB-mLAN option.

When exchanging MIDI dumps with a computer via the EXB-mLAN option, it is not currently possible for an OMS-compatible application to store or play back TRITON STUDIO dump data (the same applies to the TRITON-Rack).

### Controlling an external MIDI tone generator from the TRITON STUDIO

When you wish to use the TRITON STUDIO's keyboard, controllers, and sequencer etc. to play an external MIDI tone generator, use a MIDI cable to connect the TRITON STUDIO's MIDI OUT connector to the MIDI IN connector of the external MIDI tone generator.

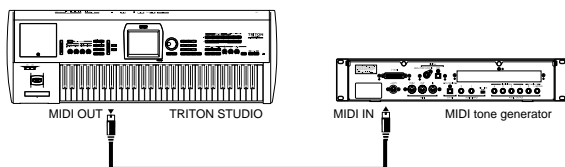

### Controlling the TRITON STUDIO's tone generator from an external MIDI device

When you wish to play or control the TRITON STUDIO's tone generator from an external MIDI keyboard or sequencer etc., use a MIDI cable to connect the MIDI OUT connector of the external MIDI device to the MIDI IN connector of the TRITON STUDIO.

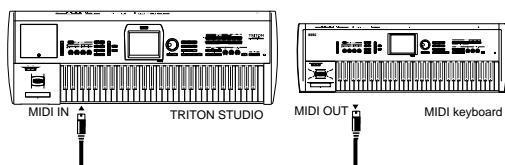

### Controlling two or more external MIDI tone generators from the TRITON STUDIO

You can use the MIDI THRU jack to simultaneously control multiple MIDI devices. (This type of connection should be used to connect no more than three devices. If you wish to connect a larger number of MIDI devices, we recommend that you use a MIDI patch bay as shown in the second diagram below.)

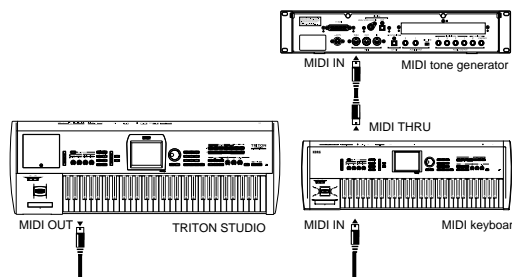

You can also use a MIDI patch bay to control multiple MIDI devices.

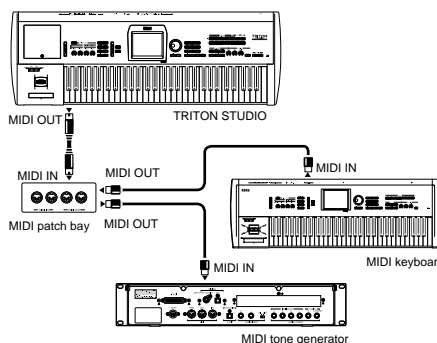

### The "Convert Position" setting

On the TRITON STUDIO, "Key Transpose," "Velocity Curve" and "After Touch Curve" (Global P0: 0-1a) allow you to transpose the pitch, adjust the velocity sensitivity, and adjust the after touch sensitivity.

The effect that these settings will have on the internal sequencer and on the MIDI data that is transmitted and received will depend on "Convert Position" (Global P1: 1-1a) setting.

- If you want to control an external MIDI tone generator from the TRITON STUDIO, set "Convert Position" to **PreMIDI**. The various settings listed above will be reflected in the MIDI data that is transmitted. These settings will also be reflected in the data that is recorded on the internal sequencer. Incoming MIDI data will be handled with settings equivalent to "Key Transpose" 0, "Velocity Curve" 4, and "After Touch Curve" 3.
- When controlling the TRITON STUDIO's tone generator from an external MIDI device, select **PostMIDI**. The above-listed settings will affect the MIDI data that is received. These settings will also affect the data that is played back from the internal sequencer. Outgoing MIDI data will be handled with settings equivalent to "Key Transpose" 0, "Velocity Curve" 4, and "After Touch Curve" 3.

## Connecting an external MIDI sequencer or computer etc.

You can play the TRITON STUDIO's keyboard and record your performance on an external MIDI sequencer/computer (connected via a MIDI interface), and then play back the recorded performance to sound the TRITON STUDIO's tone generator (i.e., using the TRITON STUDIO as an input keyboard and MIDI tone generator). To do this, connect the MIDI OUT and MIDI IN connectors of the TRITON STUDIO and your external MIDI sequencer/computer to each other.

 Some USB-MIDI interface devices may not be able to transmit/receive the TRITON STUDIO's MIDI exclusive messages.

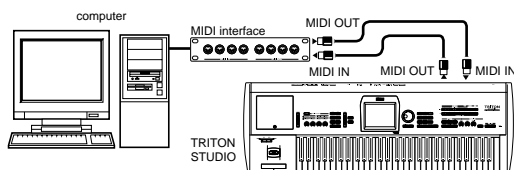

## Local Control On settings

When connections are made as shown above, turn on the Echo Back function of the external MIDI sequencer or computer (so that data received at MIDI IN will be re-transmitted from MIDI OUT), and turn **off** the TRITON STUDIO's **Local Control** setting (so that the TRITON STUDIO's keyboard and tone generator will be internally disconnected). When you play the keyboard of the TRITON STUDIO, the musical data will be transmitted to the external MIDI sequencer or computer, and then echoed back to play the TRITON STUDIO's tone generator. In other words, by turning Local Control **OFF**, you can prevent notes from being sounded in duplicate, as would otherwise occur if a note were sounded by the TRITON STUDIO's own keyboard and again by the data that was echoed-back.

If the arpeggiator function is on, playing the TRITON STUDIO's keyboard will not cause the arpeggiator to operate, and only the musical data produced by playing the keyboard will be transmitted. The arpeggiator will operate only in response to the notes that are echoed-back and received at MIDI IN. In this way, turning off Local Control prevents the arpeggiator from operating in duplicate.

Use this setting when you wish to record on the external MIDI sequencer or computer only the notes that trigger the arpeggiator, and to use the echoed-back notes to operate the arpeggiator while monitoring your recording or during playback.

**note** If you want the note data produced by the arpeggiator to be recorded on the external sequencer/computer, set Local Control on, and turn off the Echo Back setting of the external sequencer/computer.

To turn **off** Local Control, press the "Local Control On" (Global P1: 1-1a) check box to uncheck it.

When using the TRITON STUDIO by itself, leave Local Control turned **on**. (If this is off when the TRITON STUDIO is used by itself, playing the keyboard will not produce sound.)

## ■ Messages transmitted and received by the TRITON STUDIO

[...] indicates hexadecimal notation

### MIDI channels

MIDI messages can be exchanged when the transmitting and receiving devices are set to the same MIDI channel. MIDI uses sixteen channels, numbered 1-16. The way in which channels are handled will differ depending on the mode.

#### Program mode and Sampling mode

- Transmission/reception is performed on the global MIDI channel\*.

\* The global MIDI channel is the basic channel that the TRITON STUDIO uses for MIDI transmission/reception, and is set by "MIDI Channel" (Global P1: 1-1a).

#### Combination mode

- The global MIDI channel is used to transmit/receive messages for selecting a combination and turning effects on/off, and to transmit/receive exclusive data.
- Each timbre will transmit/receive MIDI data on the "MIDI Channel" (Combination P2: 2-1b) that is specified for that timbre.
- The "Ctrl Ch" MIDI channel specified for each effect ("Combination P8: 8-3a, P9: 9-2a, 9-4a) is used to control dynamic modulation of the insert/master effects, the pan following the insert effect, and send 1 and 2.
- When you operate the keyboard or controllers of the TRITON STUDIO, messages will be transmitted on the global MIDI channel, and will also be transmitted on the MIDI channel of any timbre whose "Status" (Combination P2: 2-1b) is set to **EXT** or **EX2**.
- Channel messages will be received if they match the MIDI channel of a timbre whose "Status" is set to **INT** (≡Combination P2: 2-1b).

#### Sequencer mode and Song Play mode

- The global MIDI channel is used to transmit/receive exclusive data and for messages that switch effects on/off.
- MIDI data transmission/reception for each track will occur on the MIDI channel specified for each track by "MIDI Channel" (Sequencer P2: 2-1a/2a).
- The "Ctrl Ch" MIDI channel specified for each effect ("Sequencer P8: 8-3a, P9: 9-2a, 9-4a) is used to control dynamic modulation of the insert/master effects, the pan following the insert effect, and send 1 and 2.
- When you operate the keyboard or controllers of the TRITON STUDIO, messages will be transmitted on the MIDI channel selected by "Track Select" (Sequencer P0: 0-1a) However, messages will be transmitted only if the track selected by "Track Select" has a "Status" of **BTH**, **EXT**, or **EX2**. ("Track Select" MIDI ≡p.50).
- When the sequencer is played back, musical data of tracks whose "Status" is **BTH**, **EXT**, or **EX2** will be transmitted on the specified MIDI channels.
- Tracks whose "Status" is **INT** or **BTH** will receive channel messages of the matching MIDI channel (≡"Status," "MIDI Channel" ≡p.62, 126).

### Note on/off

Note-on [9n, kk, vv]

Note-off [8n, kk, vv]

(n: channel, kk: note number, vv: velocity)

When you play a note on the TRITON STUDIO's keyboard, it will transmit note-on/off messages. When the arpeggiator

is running, note-on/off messages will be transmitted by the arpeggiator. (If Local Control is off, the arpeggiator will not transmit note-on/off data. "Local Control On settings" [p.259](#))

However, most instruments do not receive or transmit note-off velocity, and neither does the TRITON STUDIO.

## Program Change/Bank Select

### Changing the program/bank

#### Program change [Cn, pp]

(n: channel, pp: program number that allows 128 sounds to be selected)

- Programs 000–127 in banks I–A–I–F correspond to program changes [Cn, 00]–[Cn, 7F].
- Programs 001–128 in banks G, g(1), g(2), g(3), g(4), g(5), g(6), g(7), g(8), g(9), and g(d) correspond to program changes [Cn, 00]–[Cn, 7F].

#### Bank select MSB (CC#0) [Bn, 00, mm]

#### Bank select LSB (CC#32) [Bn, 20, bb]

(n: channel, mm: bank number upper byte, bb: bank number lower byte)

- The internal banks that correspond to each bank select number will depend on the "Bank Map" setting (Global P0: 0–2a). With the factory settings, this will be **GM(2)**. ("Bank Map" [p.137](#))

Simply receiving a Bank Select message will not cause the program or bank to change. The program or bank will actually change when a Program Change message is received.

#### Program mode

- In Program P0: Play, program change and bank select messages are transmitted and received on the global MIDI channel. These messages are not received in P1: Edit-Basic – P9: Edit-Master Effect.

#### Combination, Sequencer, and Song Play modes

- Program change and bank select messages can be received on the MIDI channel specified for each timbre/track to select programs on that timbre/track.
- When you select a combination, program change and bank select messages will be transmitted by timbres whose "Status" is **EXT** or **EX2**.  
In Sequencer and Song Play modes, program change or bank select messages will be transmitted by tracks whose "Status" is **BTH**, **EXT**, or **EX2** when you select the "Program Select" (P0: Program page), when you select a song, or when you return to the beginning of a measure. ("Program select" [MIDI p.51](#))
- In Combination and Sequencer modes, transmission/reception can be switched on/off for each timbre/track. ("Enable Program Change" [p.40, 65](#)).

### Selecting combinations

You can use program change and bank select messages to select combinations in the same way that you select programs.

- Combinations 000–127 in banks I–A–I–E and E–A–E–G correspond to program changes [Cn, 00]–[Cn, 7F].
- Similarly as for program banks, the internal banks that correspond to each bank select number will depend on the "Bank Map" setting (Global P0: 0–2a). ("Bank Map" [p.137](#))
- In Combination P0: Play, program change and bank select messages are transmitted/received on the global MIDI channel. They are not received in P1: Edit-Program/Mixer – P9: Edit-Master FX.

**note** All program changes can be turned off in *MIDI Filter* (Global P1: 1–1b)

As needed, you can independently turn all program changes on/off, specify whether or not incoming messages will be able to change combinations, and turn reception/transmission of bank select messages on/off.

- If "Enable Combination Change" (Global P1: 1–1b) is unchecked, the combination will not change even if a program change on the global MIDI channel is received in Combination P0: Play. In this case, the program of the timbre that matches the MIDI channel of the received message will change.
- If "Enable Bank Change" (Global P1: 1–1b) is unchecked, bank select messages will not be transmitted or received.

## After touch

Channel after touch [Dn, vv] (n: channel, vv: value)

When you apply pressure to the keyboard after playing a note, an after touch effect will be applied, and Channel After Touch messages will be transmitted. When these messages are received, an after touch effect will be applied.

- After touch for the entire instrument can be turned on/off in Global P1: 1–1b "Enable After Touch."
- In Combination and Sequencer modes, after touch can be switched on/off independently for each timbre/track ("Enable After Touch" Combination P3: 3–1a, Sequencer P3: 3–3a/4a).

#### Polyphonic key pressure [An, kk, vv]

(n: channel, kk: note number, vv: value)

There is another type of after touch called Polyphonic Key Pressure, which allows after touch to be applied independently for individual keys. This message can be used as an alternate modulation source, but cannot be transmitted by the TRITON STUDIO's keyboard. In order to use this message, it will have to be received from an external device, or recorded on your sequencer.

The after touch mentioned in this manual refers to Channel After Touch.

## Pitch bender

#### Pitch bender change [En, bb, mm]

(n: channel, bb: lower byte of the value, mm: upper byte of the value, together expressing a value of 16,384 steps where 8,192 [bb, mm = 00H, 40H] is the center value)

When the TRITON STUDIO's joystick is moved in the X axis (left/right), a pitch bend effect will be applied, and pitch bender messages will also be transmitted. When these messages are received, a pitch bend effect will be applied.

**note** The range of pitch change that is produced by pitch bend messages can also be adjusted via MIDI. ("Changing the pitch bend range" [p.264](#))

## Control change

[Bn, cc, vv]

Transmitted and received as (n: channel, cc: control change no., vv: value)

Refer to "MIDI transmission when the TRITON STUDIO's controllers are operated" ([p.253](#)) and "TRITON STUDIO operations when control changes are transmitted/received" ([p.255](#)).

- Control changes can be turned on/off as a whole in "Enable Control Change" (Global P1: 1–1b).

- In Combination and Sequencer modes, the P3: MIDI Filter settings allow transmission/reception of control changes to be individually turned on/off for each timbre/track. For the assignable controllers ([SW1], [SW2], REALTIME CONTROLS [1]–[4] knobs, Foot Pedal/Switch), MIDI filter settings will apply to the control change number to which each controller is assigned. “Other Control Change” applies to control changes that are not covered by the items of the other check boxes.

**note** MIDI CC#00–CC#95 can be selected for the B-mode of REALTIME CONTROLS [1]–[4] knobs.

## Selecting program/combination banks

### Bank select (CC#00, CC#32)

“Program Change/Bank Select” (ⓘp.260)

## Using the joystick to apply modulation

### Modulation 1 depth (CC#01) [Bn, 01, vv]

When you move the TRITON STUDIO’s joystick in the +Y direction (Vertical upward), Modulation 1 Depth messages will be transmitted. When these messages are received, the same effect will be applied as when the TRITON STUDIO’s joystick is operated. Normally this will apply a vibrato effect (pitch LFO).

- In Combination and Sequencer modes, transmission/reception can be switched on/off for each timbre/track (“Enable JS+Y” Combination P3: 3–1a, Sequencer P3: 3–3a/4a).

### Modulation 2 depth (CC#02) [Bn, 02, vv]

When you move the TRITON STUDIO’s joystick in the –Y direction (Vertical downward), Modulation 2 Depth messages will be transmitted. When these messages are received, the same effect will be applied as when the TRITON STUDIO’s joystick is operated. Normally this will apply a wah effect (filter LFO).

- In Combination and Sequencer modes, transmission/reception can be switched on/off for each timbre/track (“Enable JS–Y” Combination P3: 3–1a, Sequencer P3: 3–3a/4a).

**note** Other manufacturers use this message for other purposes (e.g., breath controller, etc.)

## Controlling the portamento effect

### Portamento time (CC#05) [Bn, 05, vv]

When the above CC# is assigned as a B-mode function for one of the REALTIME CONTROLS [1]–[4] knobs, rotating that knob will transmit Portamento Time messages, and will modify the speed at which the portamento pitch changes. When this message is received, the result will be the same as when the controller is operated.

### Portamento switch (CC#65) [Bn, 41, vv]

When the above CC# is assigned to [SW1], [SW2] or the ASSIGNABLE SWITCH, operating that switch will transmit vv=127 [7F] for ON or vv=0 [00] for OFF, and the portamento effect will be switched on/off. When this message is received, the result will be the same as when the controller is operated. (vv of 63 [3F] or less will be OFF, and 64 [40] or greater will be ON.) (“SW1, SW2 Assign List” ⓘp.249)

- In Combination and Sequencer modes, transmission/reception of this message can be turned on/off independently for each timbre/track (“Enable Portamento SW” Combination/Sequencer P3: 3–1a).

- In Sequencer mode, portamento time/switch messages will be transmitted by each track whose “Status” is **BTH**, **EXT**, or **EX2** when you set “Portamento” (P2: 2–3a/4a), re-select a song or SMF, or return to the beginning of a measure. (ⓘp.63)

## Controlling the volume

### Volume (CC#07) [Bn, 07, vv]

When the above CC# is assigned to the ASSIGNABLE PEDAL or as the B-mode function of a REALTIME CONTROL knob [1]–[4], operating that controller will transmit Volume messages, and the volume will change. When this message is received, the result will be the same as when the controller is operated.

### Expression (CC#11) [Bn, 0B, vv]

When the above CC# is assigned to the ASSIGNABLE PEDAL or as the B-mode function of a REALTIME CONTROL knob [1]–[4], operating that controller will transmit Expression messages, and the volume will change. When this message is received, the result will be the same as when the controller is operated.

The volume of the TRITON STUDIO is determined by multiplying the value of the **Volume message** with the value of the **Expression message**.

If adjusting the Volume message does not increase the volume as you expect, or if there is no sound, transmit MIDI messages from an external device to reset the value of the Expression message (set vv to 127). In Sequencer mode, this will be reset when the “Location” of the song is moved to **001:01.000**.

- In Combination mode, Volume messages will be transmitted by each timbre whose “Status” is **EXT** or **EX2** when you re-select the combination.
- When you change the “Volume” setting (Sequencer/Song Play P0: 0–3a/4a) in Sequencer mode or Song Play mode, or when you re-select the song or return to the beginning of the song in Sequencer mode, volume messages will be transmitted by each track whose “Status” is **BTH**, **EXT**, or **EX2**.

**note** Regardless of the “Status” settings, re-selecting a song, or returning to the beginning will reset the internal Volume value to the value specified by each track (the starting settings), and will reset the Expression value to the maximum.

**note** This message can be used to control the volume of each track. Normally, you will include a Volume message in the track setting data (the settings at the beginning of the track) to set the initial volume, and use Expression to create changes in dynamics as the song progresses.

By using the universal exclusive Master Volume message, you can adjust the overall volume without changing the volume balance between timbres or tracks. (“About system exclusive messages” ⓘp.264)

## Controlling panpot (stereo position)

### Panpot (CC#10) [Bn, 0A, vv]

(vv: value, where 00 is far left, 64 is center, and 127 is far right)

When the above CC# is assigned to the ASSIGNABLE PEDAL or as the B-mode function of a REALTIME CONTROL knob [1]–[4], operating that controller will transmit Panpot messages, and the panning will change. When this message is received, the result will be the same as when the controller is operated.



- When you set the “Pan” (Sequencer/Song Play P0: 0–3a/4a) in Sequencer mode or Song Play mode, or when you re-select the song or return to the beginning of the measure in Sequencer mode, Panpot messages (except for RND) will be transmitted by each track whose “Status” is **BTH**, **EXT**, or **EX2** (ⓘp.55, 125).

#### Post insert effect panpot (CC#08) [Bn, 08, vv]

(vv: value, where 00 is far left, 64 is center, and 127 is far right)

When the above CC# is assigned to the ASSIGNABLE PEDAL or as the B-mode function of a REALTIME CONTROL knob [1]–[4], operating that controller will transmit Post Insert Effect Panpot messages, and the panning of the sound following the insert effect will change. When this message is received, the result will be the same as when the controller is operated.

- In Program mode and Sampling mode, this message is transmitted/received on the global MIDI channel. In Combination, Sequencer, and Song Play modes, this message is transmitted/received on the MIDI channel specified for each insert effect.
- When you set “Pan (CC#8)” (Sequencer/Song Play P8: 8–3) in Sequencer mode or Song Play mode, or when you re-select the song or return to the beginning of the measure in Sequencer mode, Post Insert Effect Panpot messages will be transmitted by each track whose “Status” is **BTH**, **EXT**, or **EX2** (ⓘp.84, 132).

### Effect control

#### Effect control 1 (CC#12) [Bn, 0C, vv]

#### Effect control 2 (CC#13) [Bn, 0D, vv]

When the above CC# is assigned to the ASSIGNABLE PEDAL or as the B-mode function of a REALTIME CONTROL knob [1]–[4], operating that controller will transmit Effect Control 1/2 messages, and the specified dynamic modulation will be controlled. When this message is received, the result will be the same as when the controller is operated.

Although various types of control change can be selected as dynamic modulation sources, Effect Control 1 (CC#12) and 2 (CC#13) are dedicated for dynamic modulation.

#### Effect 1 depth (Send 2) (CC#91) [Bn, 5B, vv]

#### Effect 3 depth (Send 1) (CC#93) [Bn, 5D, vv]

When the above CC# is assigned to the ASSIGNABLE PEDAL or as the B-mode function of a REALTIME CONTROL knob [1]–[4], operating that controller will transmit Effect 1 Depth (Send 2) or Effect 3 Depth (Send 1) messages, and the send level 1 or 2 to the master effects **MFX1** or **MFX2** will be controlled respectively. When this message is received, the result will be the same as when the controller is operated.

On the corresponding MIDI channels, this will simultaneously control the timbre/track setting as well as the setting following the insertion effect.

- In Combination, Sequencer, and Song Play modes, the actual send level of the timbre/track is determined by multiplying this value with the send 1/2 settings for each oscillator (Program P8: 8–1d). (*OSC1* “Send 1 (to MFX1)”/*OSC2* “Send 2 (to MFX2)” ⓘp.28, “Send 1 (MFX1)”/“Send 2 (MFX2)” ⓘp.46, 84)
- When you adjust “Send 1 (MFX1)” or “Send 2 (MFX2)” (Sequencer, Song Play P8: 8–3) in Sequencer mode or Song Play mode, or when you re-select a song or return to the beginning of the measure in Sequencer mode, Send 1/2 will be transmitted by each track whose “Status” is **BTH**, **EXT**, or **EX2**. (ⓘp.84, 132).

#### Effect 2 depth (IFX1–5 on/off) (CC#92) [Bn, 5C, vv]

#### Effect 4 depth (MFX1 on/off) (CC#94) [Bn, 5E, vv]

#### Effect 5 depth (MFX2 on/off) (CC#95) [Bn, 5F, vv]

Separately from the effect on/off settings in each mode, “Effect Global SW” (Global P1: 0–1b) allows you to turn off insert effects IFX1–5 and master effects MFX1 and MFX2. If you check “IFX1–5 Off,” “MFX1 Off” or “MFX2 Off,” the corresponding message will be transmitted with vv=0 [00]. If you uncheck these settings, the corresponding message will be transmitted with vv=127 [7F]. If you check these settings, the corresponding effect(s) will be turned off as a group. If you uncheck these settings, the on/off settings of each mode will be used. The same applies to reception. (vv of 00 is off, and 01 or greater is the original setting.) These messages are transmitted/received on the global MIDI channel. (“IFX 1–5 on/off” - “MFX 1, 2 on/off” ⓘp.30, 31)

**note** These messages are defined simply for use in adjusting the effect levels, and may not have the same function on another instrument connected to the TRITON STUDIO.

### Using various controllers for control

#### Foot controller (CC#04) [Bn, 04, vv]

If the above CC# is assigned as the ASSIGNABLE PEDAL function, this message will be transmitted when the controller is operated.

- In Combination and Sequencer modes, transmission/reception of this message can be turned on/off independently for each timbre/track (“Enable Foot Pedal/Switch” Combination P3: 3–4a, Sequencer P3: 3–7a/8a).

#### Ribbon controller (CC#16) [Bn, 10, vv]

This message will be transmitted when the TRITON STUDIO’s ribbon controller is operated.

- In Combination and Sequencer modes, transmission/reception of this message can be turned on/off independently for each timbre/track (“Enable Ribbon” Combination P3: 3–2a, Sequencer P3: 3–3a/4a).

#### Controller (CC#18) [Bn, 12, vv]

This message will be transmitted when the TRITON STUDIO’s [VALUE] slider is operated.

This is valid in “Program Select” (Program P0: 0–1a) and “Combination Select” (Combination P0: 0–1a) when the program or combination number/name is selected (highlighted).

#### Knob modulation 1, 2, 3, 4 (CC#17, 19, 20, 21)

#### [Bn, 11, vv], [Bn, 13, vv], [Bn, 14, vv], [Bn, 15, vv]

If the above CC# are assigned to the B-mode of REALTIME CONTROLS [1]–[4] knobs, these messages will be transmitted when the knobs are operated.

- In Combination and Sequencer modes, transmission/reception of this message can be turned on/off independently for each timbre/track (“Enable Realtime Controls Knob 1, 2, 3, 4” Combination P3: 3–3a, Sequencer P3: 3–5a/6a).

#### Controller (CC#83) [Bn, 53, vv]

If the above CC# is assigned to the B-mode of REALTIME CONTROLS [1]–[4] knobs, this message will be transmitted when the knob is operated.

#### SW1 modulation (CC#80) [Bn, 50, vv]

#### SW2 modulation (CC#81) [Bn, 51, vv]

If the above CC# are assigned as the function of [SW1] or [SW2], operating the switch will transmit this message with vv=127 [7F] for ON, and vv=00 [00] for OFF. (These can also be set as the B-mode functions of the REALTIME CONTROL knobs [1]–[4].)

- In Combination and Sequencer modes, transmission/reception of these messages can be turned on/off independently for each timbre/track (☞“Enable SW1,” “Enable “SW2” Combination P3: 3–4a, Sequencer P3: 3–7a/8a)

#### Foot switch (CC#82) [Bn, 52, vv]

If the above CC# is assigned as the function of the ASSIGNABLE SWITCH, operating the switch will transmit this message with vv=127 [7F] for ON, and vv=00 [00] for OFF. (This can also be set as a B-mode function of the REALTIME CONTROL knobs [1]–[4].)

- In Combination and Sequencer modes, transmission/reception of this message can be turned on/off independently for each timbre/track (☞“Enable Foot Pedal/Switch” Combination P3: 3–4a, Sequencer P3: 3–7a/8a).

When “Foot controller (CC#04)”–“Foot switch (CC#82)” are operated on the TRITON STUDIO, the specified alternate modulation or dynamic modulation etc. will be controlled. When these messages are received, the result will be the same as if the controller had been operated. For “SW1 modulation (CC#80)”–“Foot switch (CC#82),” vv of 63 [3F] or less will be OFF, and 64 [3F] or greater will be ON.

#### Damper pedal (CC#64) [Bn, 40, vv]

This message is transmitted when you operate a damper pedal (Korg DS-1H etc.) connected to the DAMPER jack, and the damper effect will be turned on/off. If the DS-1H is used, a half-damper effect can be applied.

- In Combination and Sequencer modes, transmission/reception of this message can be turned on/off independently for each timbre/track (☞“Enable Damper” Combination P3: 3–1a, Sequencer P3: 3–7a/8a).

#### Sostenuto (CC#66) [Bn, 42, vv]

If the above CC# is assigned as the function of the ASSIGNABLE SWITCH, operating the switch will transmit this message with vv=127 [7F] for ON, and vv=00 [00] for OFF, and the sostenuto effect will be turned on/off. When this message is received, the result will be the same as when the controller is operated (OFF for vv=63 [3F] or below, and ON for vv=64 [40] or above).

#### Soft pedal (CC#67) [Bn, 43, vv]

If the above CC# is assigned as the function of the ASSIGNABLE SWITCH, operating the switch will transmit, and the soft pedal effect will be turned on. When this message is received, the result will be the same as when the controller is operated.

### Controlling the tone/envelope of a program

CC#70-78 control specific parameters of a program. For details on the program parameters that correspond to each control change, and how the TRITON STUDIO will respond in each mode when these are received, refer to “TRITON STUDIO operations when control changes are transmitted/received” (☞p.255).

#### Low pass filter cutoff (CC#74) [Bn, 4A, vv]

#### Resonance level/High pass filter cutoff (CC#71) [Bn, 47, vv]

#### Filter EG intensity (CC#79) [Bn, 4F, vv]

#### Release time (CC#72) [Bn, 48, vv]

These messages are transmitted when you operate the TRITON STUDIO’s REALTIME CONTROLS [1]–[4] knobs in A-mode. (They can also be set as B-mode functions.)

#### Sustain level (CC#70) [Bn, 46, vv]

#### Attack time (CC#73) [Bn, 49, vv]

#### Decay time (CC#75) [Bn, 4B, vv]

#### LFO 1 speed (CC#76) [Bn, 4C, vv]

#### LFO 1 depth (pitch) (CC#77) [Bn, 4D, vv]

#### LFO 1 delay (CC#78) [Bn, 4E, vv]

These messages are transmitted when assign the above CC# to the REALTIME CONTROLS [1]–[4] knobs and operate them.

When you operate these, the corresponding program parameters will be controlled, and the sound and envelope will change. When these messages are received, the result will be the same as when the controller is operated. (When the message has a value vv=64 [40], the setting will have the value that was set by the program parameter.)

- In Combination and Sequencer modes, transmission/reception can be turned on/off independently for each timbre/track (☞“Enable Realtime Controls Knob 1, 2, 3, 4” Combination P3: 3–4a, Sequencer P3: 3–5a/6a).

**note** In Program mode, the corresponding program parameters will be temporarily edited by these messages. You can Write the program to save the modified state (except for certain parameters). The Write operation can also be performed by a MIDI exclusive Program Write Request message, in addition to the usual method of using the TRITON STUDIO’s switches. When you write the data, the values of the corresponding program parameters will be rewritten.

**note** The results of receiving these messages will depend on the instrument. The operation may be different when a device other than the TRITON STUDIO is connected.

### Silencing all notes on a specific channel

#### All note off (CC#123) [Bn, 7B, 00] (value 00)

When this is received, all currently-sounding notes on that channel will be turned off (as though the keys had been released). However, the release portion of the notes will remain.

#### All sound off (CC#120) [Bn, 78, 00] (value 00)

When this is received, all currently-sounding notes on that channel will be silenced. While the All Note Off message allows the release portion of the notes to remain, the All Sound Off message will silence the notes immediately.

However, these messages are provided for emergency use, and are not something that you will use while performing.

### Resetting all controllers on a specific channel

#### Reset all controllers (CC#121) [Bn, 79, 00] (value 00)

When this is received, the value of all controllers on that channel will be reset.

### Using RPN to edit

RPN (Registered Parameter Number) is a type of message that allows settings to be made in a way that is common between instrument manufacturers. (NRPN (Non-registered Parameter Numbers) and exclusive messages can be freely used in non-compatible ways by different manufacturers and models of instrument.)

RPN messages can be used for editing with the following procedure.

- ① Use RPN MSB (CC#101) [Bn, 65, mm] and RPN LSB (CC#100) [Bn, 64, rr] (n: channel, mm, rr: upper and lower bytes of the parameter number) messages to select the parameter.

- ② Use data entry MSB (CC#6) [Bn, 06, mm] and data entry LSB (CC#38) [Bn, 26, vv] (n: channel, mm, vv: upper and lower bytes of the value, together expressing 16,384 levels) to specify the value.
- ③ You can use data increment (CC#96) [Bn, 60, 00] or data decrement (CC#97) [Bn, 61, 00] (n: channel, value is fixed at 00) to change the value in steps of one.

The TRITON STUDIO can receive the following three RPN messages (tuning, transpose, and pitch bend range).

### Tuning

**RPN fine tune** [Bn, 65, 00, 64, 01]

This RPN message can be used to adjust the detuning for a program or timbre (in Combination mode), or for a track (in Sequencer or Song Play modes).

The procedure is as follows.

- ① [Bn, 65, 00, 64, 01]: Select RPN parameter 01.
- ② [Bn, 06, mm, 26, vv]: Use data entry to set the value. A value of 8192 [mm, vv=40, 00] is center, 0 [mm, vv=00, 00] is -100 cents, and 16383 [mm, vv=7F, 7F] is +99 cents.

**note** You can use the universal exclusive Fine Tune message to adjust the overall tuning that corresponds to the “Master Tune” (Global P0: 0–1a) parameter. (“About system exclusive messages” [p.264](#))

### Transposing

**RPN coarse tune** [Bn, 65, 00, 64, 02]

This RPN message can be used to adjust the transposition for a program or timbre (in Combination mode), or for a track (in Sequencer or Song Play modes).

The procedure is as follows.

- ① [Bn, 65, 00, 64, 02]: Select RPN parameter 02.
- ② [Bn, 06, mm, 26, vv]: Use data entry to set the value. Normally only the upper byte is used.

A value of 8192 [mm, vv=40, 00] is center, 6656 [mm, vv=34, 00] is -12 semitones, and 9728 [mm, vv=4C, 00] is +12 semitones.

**note** You can use the universal exclusive Coarse Tune message to adjust the overall tuning that corresponds to the “Transpose” (Global P0: 0–1a) parameter. (“About system exclusive messages” [p.264](#))

### Changing the pitch bend range

**RPN pitch bend range** [Bn, 64, 00, 65, 00]

This RPN message can be used to adjust the pitch bend range for a program or timbre (in Combination mode) or for a track (in Sequencer or Song Play modes).

The procedure is as follows.

- ① [Bn, 65, 00, 64, 00]: Select RPN parameter 00.
- ② [Bn, 06, mm, 26, vv]: Use data entry to set the value. Normally only the upper byte is used.

A value of 0 [mm, vv=00, 00] is +00, and a value of 1536 [mm, vv=0C, 00] is +12 (one octave). Although it is possible to set a negative value for a timbre/track, only positive values can be set using RPN messages.

### Controlling the arpeggiator (NRPN)

Arpeggiator operations can be controlled using NRPN (Non Registered Parameter Number) messages. NRPN messages can be freely used in non-compatible ways by different manufacturers and models of instrument.

The procedure for using NRPN messages is the same as for RPN, but you will use NRPN MSB (CC#99) [Bn, 63, mm] and NRPN LSB (CC#98) [Bn, 62, rr] messages (n: channel, mm, rr: upper and lower bytes of the parameter number) to specify the parameter.

#### NRPN arpeggiator on/off

[Bn, 63, 00, Bn, 62, 02, Bn, 06, mm]

This message will be transmitted when you press the ARPEGGIATOR [ON/OFF] key. When the switch is turned ON the data will be mm=127 [7F], and when turned OFF the data will be mm=0 [00], and the arpeggiator will be turned on/off accordingly. (This can also be specified as a function of the ASSIGNABLE SWITCH.)

Similarly, the arpeggiator will be turned on/off when this message is received. (ON when mm is 64 [40] or greater, and OFF when 63 [3F] or less.)

#### NRPN arpeggiator gate control

[Bn, 63, 00, Bn, 62, 0A, Bn, 06, mm]

This message will be transmitted when you operate the ARPEGGIATOR [GATE] knob, and the arpeggiator gate will change. When this message is received, the result will be the same.

#### NRPN arpeggiator velocity control

[Bn, 63, 00, Bn, 62, 0B, Bn, 06, mm]

This message will be transmitted when you operate the ARPEGGIATOR [VELOCITY] knob, and the arpeggiator velocity will change. When this message is received, the result will be the same.

### About system exclusive messages

Since the way in which these messages are used is left up to each manufacturer, they are mainly used to transmit and receive sound data and editing data for parameters that are unique to a particular instrument. The TRITON STUDIO’s system exclusive message format is [F0, 42, 3n, 50, ff, ..... F7]

**F0:** exclusive status

**42:** Korg ID

**3n:** [n=0–F] global MIDI channel 1–16

**50:** Future model ID

**ff:** function ID (type of message)

– ...

**F7:** end of exclusive

**note** To obtain a copy of the “MIDI Implementation” which includes MIDI exclusive format information, please contact your Korg distributor.

 When exchanging MIDI dumps with a computer via the EXB-mLAN option, it is not currently possible for an OMS-compatible application to record or play back TRITON STUDIO dump data (the same applies to the TRITON-Rack).

 Some USB-MIDI interface devices may not be able to transmit/receive the TRITON STUDIO’s MIDI exclusive messages.

## Universal system exclusive

Certain of the system exclusive messages are publicly defined for a specific use, and these are called universal system exclusive messages.

The TRITON STUDIO uses the following six universal system exclusive messages.

**Inquiry message request** [F0, 7E, nn, 06, 01, F7]

**Inquiry message** [F0, 7E, nn, 06, 02, (nine bytes), F7]

When an inquiry message request is received, the TRITON STUDIO will respond by transmitting an inquiry message that means "I am a Korg TRITON STUDIO, with system version ..."

**GM system on** [F0, 7E, nn, 09, 01, F7]

When this message is received in Song Play mode, the TRITON STUDIO will be initialized for GM playback.

**Master volume** [F0, 7F, nn, 04, 01, vv, mm, F7]

(vv: lower byte of the value, mm: upper byte of the value, together indicating 16384 steps)

This message is transmitted if you assign **Master Volume** as the function of the ASSIGNABLE PEDAL or as a B-mode function of a REALTIME CONTROLS [1]–[4] knobs and operate the controller. This will adjust the overall volume balance without changing the relative volume balance between timbres/tracks. When this message is received, the result will be the same as when the controller is operated.

**Master balance** [F0, 7F, nn, 04, 02, vv, mm, F7]

(vv: lower byte of the value, mm: upper byte of the value, together indicating 16384 steps, where 8192 is the default position, and lower values will move the sound toward the left)

When this is received, the overall panning will be adjusted without changing the relative panning between timbres/tracks.

**Master fine tuning** [F0, 7F, nn, 04, 03, vv, mm, F7]

(A value of 8192 [mm, vv=40, 00] is center, 4096 [mm, vv=20, 00] is -50 cents, and 12288 [mm, vv=60, 00] is +50 cents.)

When this is received, the "Master Tune" (Global P0: 0–1a) parameter will be set.

**Master coarse tuning** [F0, 7F, nn, 04, 04, vv, mm, F7]

(Normally only the upper byte mm is used. A value of 8192 [mm, vv=40, 00] is center, 6656 [mm, vv=34, 00] is -12 semitones, and 9728 [mm, vv=4C, 00] is +12 semitones.)

When this is received, the "Transpose" (Global P0: 0–1a) parameter will be set.

## Transmitting sound settings data (Data Dump)

Data for programs, combinations, drum kits, user arpeggio patterns, global settings, and sequencer data can be transmitted as MIDI exclusive messages. The operation of sending this system exclusive data to an external device is called a "data dump."

By performing a data dump, you can store the TRITON STUDIO's sounds and settings on an external device, or rewrite the sounds and settings of another TRITON STUDIO.

There are the following three types of data dump.

- When you use the "Dump" (Global P1: 1–1) page menu command to dump data, various types of internal memory data will be transmitted. If this data is received by the TRITON STUDIO, the data will be written directly into internal memory, and it will not be necessary to perform the Write operation. ("Transmission," "Reception" ☞ p.145)

- If the "Enable Exclusive" (Global P1: 1–1b) setting is checked, selecting a combination in Combination P0: Play will transmit data for one combination. Selecting a program in Program Play P0: Play will transmit data for one program.

This data is the edit buffer data for the currently selected combination or program. If this data is received by the TRITON STUDIO, the data will be written into the edit buffer, so if you wish to save it to internal memory, you will need to perform the Write operation. The Write operation can also be performed by a MIDI exclusive Program Write Request or Combination Write Request message, in addition to the usual method of using the TRITON STUDIO's switches. ("Saving data" ☞ BG p.55)

- If the "Enable Exclusive" (Global P1: 1–1b) setting is checked, data will also be dumped in response to a Dump Request message. This data is transmitted and received on the global MIDI channel.

## Editing sounds etc.

By using various MIDI exclusive data dumps, you can rewrite all programs or an individual program. By using parameter change messages, you can edit individual parameters as follows.

### Parameter changes

- In Program mode, all parameters other than the program name can be edited. Performance editor parameters are included.
- In Combination mode, parameters other than the combination name can be edited.
- In Sequencer mode, parameter changes can be used to edit P0, 2, 3, 4 parameters other than "Location," "Meter," "♪ (Tempo)," "Tempo Mode," song name, "Track Select," "Reso," "RPPR On/Off," and P0: Sampling, Preference. Parameter changes can also be used to edit the P7: Arpeggiator, P8: Insert Effect, and P9: Master Effect parameters.

### Drum kit parameter change/User arpeggio pattern parameter change

- In Global mode, you can edit drum kits and user arpeggio patterns.

Since the other global parameters or Sequencer mode musical data cannot be edited, you will use data dumps to transfer this data. Data dumping of Sampling mode data is not supported.

The global MIDI channel is used to transmit and receive this data.

First check "Enable Exclusive" (Global P1: 1–1b), so that exclusive data can be transmitted and received. When you change modes on the TRITON STUDIO, a mode change message will be transmitted. When you change programs or combinations, the parameters for one program or one combination will be transmitted together with the program change. When you edit individual parameters, parameter change, drum kit parameter change, user arpeggio pattern parameter change messages or song parameter change message will be transmitted.

When these messages are received, the same editing operation will be performed as on the transmitted device. After MIDI exclusive data has been received and processed, a Data Load Completed message will be transmitted. The control master device must not transmit the next message until this message is received (or until a sufficient interval of time has elapsed).

When you change programs or combinations, or use parameter changes to edit, the changes will affect the data in the edit buffer and will not be stored in internal memory unless you Write, so that the changes will be lost if you re-select the program or combination. The Write operation can be performed by a MIDI exclusive Program Write Request or Combination Write Request message, in addition to the usual method of using the TRITON STUDIO's switches. ("Saving data" <sup>Ⓝ</sup>BG p.55)

It is not necessary to write a song, but it will not be backed up when the power is turned off. If you wish to keep the data, save it on external media before turning off the power. ("Saving on media" <sup>Ⓝ</sup>BG p.59)

### *If notes are "stuck"*

If for some reason, notes become "stuck" and will not stop sounding, you can usually stop the sound by changing the mode. If notes played via MIDI are stuck, you can disconnect the MIDI cable.

MIDI transmits a message called Active Sensing [FE] at regular intervals. A device that receives this message will be aware that an external MIDI device is transmitting to it. Subsequently, if no MIDI messages are received for a certain interval of time, the receiving device will decide that the connection has been broken, and will turn off any notes that had been sounded via MIDI and reset its controller values.

### *Playing the TRITON STUDIO multi-timbrally from an external device*

The TRITON STUDIO can be connected to an external device and played multi-timbrally in the following ways.

- MIDI messages from the external device can play a combination (8-part multi-timbral performance). You can change the overall settings (programs, levels, and effects) by using program change messages to switch combinations.
- MIDI messages from the external device can be used to play a song (16-part multi-timbral performance). Overall settings (programs, levels, effects etc.) can be changed by using a Song Select message to switch songs. (Song Select messages can be received if "MIDI Clock": Global P1: 1-1a is set to **External MIDI** or **External mLAN**.)
- MIDI Clock messages from the external device can be used to make the TRITON STUDIO playback a song (set "MIDI Clock" to **External MIDI** or **External mLAN**, and run the TRITON STUDIO's sequencer). (<sup>Ⓝ</sup>"Synchronizing the playback of the arpeggiator or sequencer") You can change the overall settings (programs, levels, effects) by using song select messages to switch songs.

### *Synchronizing the playback of the arpeggiator or sequencer*

The choice of whether the TRITON STUDIO will be the master (the controlling device) or the slave (the controlled device) is made by "MIDI Clock" (Global P1: 1-1a).

### **Using the TRITON STUDIO as master and the external MIDI device as slave**

Connect the TRITON STUDIO's MIDI OUT connector to the MIDI IN connector of the external MIDI device. (<sup>Ⓝ</sup>p.258) Alternatively, connect the mLAN connector of the EXB-mLAN option to an mLAN-compatible device.

- When you set "MIDI Clock" to **Internal**, the TRITON STUDIO will be the master device, and will transmit MIDI timing clock messages.

**Arpeggiator:** The tempo can be controlled from the TRITON STUDIO. Simultaneously, the performance of the arpeggiator will be transmitted via MIDI. (In Combination, Sequencer, and Song Play modes, data will be transmitted by timbres/tracks whose "Status" is **BTH**, **EXT**, or **EX2**.) An external tone generator connected to MIDI OUT will sound, and the tempo of an external sequencer can be controlled.

**Sequencer:** The musical data can be played back and controlled on the TRITON STUDIO. Simultaneously, the sequencer playback will be transmitted via MIDI from tracks whose "Status" is **BTH**, **EXT**, or **EX2**. An external tone generator connected to MIDI OUT will sound, and the tempo of an external sequencer can be controlled. However, since exclusive data cannot be recorded on the TRITON STUDIO's sequencer, you can use the "Dump Sequencer" (Global P1: 1-1F) page menu command if the slave device is the TRITON STUDIO. If the slave device is another model, you can use the TRITON STUDIO's Disk mode data filer function ("Receive and Save MIDI Exclusive," "Load and Transmit MIDI Exclusive Data"). (<sup>Ⓝ</sup>p.161, 168)

### **Using the external MIDI device as master and the TRITON STUDIO as slave**

Connect the TRITON STUDIO's MIDI IN connector to the MIDI OUT connector of the external MIDI device. (<sup>Ⓝ</sup>p.258) Alternatively, connect the mLAN connector of the EXB-mLAN option to an mLAN-compatible device.

- When you set "MIDI Clock" to **External MIDI** or **External mLAN**, the TRITON STUDIO will be the **slave** device.

**Arpeggiator:** The tempo will follow the MIDI timing clock. If you playback the external sequencer, the TRITON STUDIO's arpeggiator will synchronize to the external timing clock. (<sup>Ⓝ</sup>BG p.138)

Even if "MIDI Clock" is **External MIDI** or **External mLAN** and the TRITON STUDIO is being controlled from the external device, the performance of the arpeggiator will still be transmitted via MIDI. (In Combination and Sequencer modes, the arpeggiator performance will be transmitted from timbres/tracks whose "Status" is **BTH**, **EXT**, or **EX2**.)

**Sequencer:** It will not be possible to control the playback from the TRITON STUDIO; playback will be controlled by the external device connected to the TRITON STUDIO's MIDI IN. If you wish to playback the external sequencer to make the TRITON STUDIO's sequencer playback in synchronization to the external timing clock, you must first set the same time signature and starting measure locations on both devices.

Even if "MIDI Clock" is set to **External MIDI** or **External mLAN** and the TRITON STUDIO is being controlled from an external device, musical data will be transmitted by tracks whose "Status" is **BTH**, **EXT**, or **EX2**.

### *Recording musical data from an external device*

There are two ways in which you can play back an external sequencer and record its playback on the TRITON STUDIO.

- Set "MIDI Clock" (Global P1: 1-1a) to **Internal**, begin recording, and then start the external sequencer. With this method, the MIDI messages will be recorded without the two devices being synchronized. Since the

incoming musical data will simply be recorded, this method allows the performance to be reproduced faithfully, but since measure divisions etc. will not be kept track of, this method is not suitable if you intend to edit the data later.

- If you set "MIDI Clock" to **External MIDI** or **External mLAN**, the start of recording and the tempo etc. will all be under the control of the external sequencer. Since the two devices will be synchronized during the recording process, measure divisions etc. will be accurately preserved. (You will need to set the time signature before recording.) However, tempo changes during the performance will not be recorded, so you will have to insert any tempo changes later. For normal multi-track recording, you will use this method. ("Multi (multitrack recording)"  BG p.85)

### **Recording the MIDI output of the TRITON STUDIO's controllers, arpeggiator, and internal sequencer to an external sequencer/computer**

If you wish to record the MIDI output of the TRITON STUDIO's controllers, arpeggiator, and internal sequencer on an external sequencer or computer and use the TRITON STUDIO as the monitoring and playback tone generator while you record, you must turn off the TRITON STUDIO's Local Control setting ("Local Control On" Global P1: 1-1a), and set your external sequencer/computer for echo-back (a function by which the data received at MIDI IN is retransmitted without change from MIDI OUT) so that the data from the TRITON STUDIO's controllers, arpeggiator and internal sequencer will not be applied in duplicate to the tone generator.

### **Using the REALTIME CONTROLS [1]-[4] knobs to record MIDI control changes on an external MIDI sequencer/computer**

Set the TRITON STUDIO to Local Control Off. Set the external MIDI sequencer/computer to Echo Back On. With these settings, recording and playback will occur correctly, and the control changes will not be applied to the tone generator in duplicate.

### **Recording the arpeggiator or RPPR function on an external MIDI sequencer/computer**

When the arpeggiator is **on**, playing the keyboard or operating the controllers of the TRITON STUDIO will operate and control the arpeggiator. The arpeggiator will operate and be controlled in the same way in response to MIDI messages received at MIDI IN. The MIDI messages generated from the arpeggiator will be transmitted from MIDI OUT according to the Local Control setting ("Local Control On" Global P1: 1-1a) as described below.

In Sequencer mode, when the RPPR function is **on**, playing the keyboard will cause RPPR to operate. Similarly, the RPPR function will also operate in response to notes received on the MIDI channel of the track selected by "Track Select" (Sequencer P0: 0-1a). Notes will be transmitted by RPPR from MIDI OUT according to the local control setting ("Local Control On") as described below.

**Local Control On:** Notes from the arpeggiator or RPPR will be transmitted from MIDI OUT. Normally you will use this setting.

**Local Control Off:** Notes from the arpeggiator or RPPR will not be transmitted from MIDI OUT. The arpeggiator or RPPR will only sound the notes (on this instrument).

#### **Setting example 1**

**Record the note messages generated by the arpeggiator or RPPR function on the external MIDI sequencer/computer**  
Turn on this instrument's arpeggiator or RPPR function. Set this instrument to **Local Control On**.

Turn Local Control On for this instrument.

Turn **Echo Back Off** on your external sequencer/computer. By turning echo back off, you will prevent the arpeggiator or RPPR function from performing duplicate processing on the monitored notes during recording.

During playback, turn off the arpeggiator and RPPR functions of this instrument.

#### **Setting example 2**

**Use the external MIDI sequencer/computer to record only the notes that trigger the arpeggiator or RPPR function, and operate this instrument's arpeggiator or RPPR function for monitoring while recording, and during playback.**  
Turn on the TRITON STUDIO's arpeggiator or RPPR function. Set the TRITON STUDIO to **Local Control Off**. The note messages generated by the arpeggiator or RPPR function will not be output. On your external MIDI sequencer/computer, turn **echo back on**. With these settings, the data will be recorded and played correctly, and the arpeggiator or RPPR function will not be applied in duplicate.

### **About GM/GS/XG**

The TRITON STUDIO supports the GM standard. It also supports the GM2 sound map (including bank select) with 256 programs and 9 drum programs provided in ROM banks G, g(1)-g(9), and g(d). (Banks g(1)-g(9) are GM2 variation programs, and g(d) contains drum programs.)

GM is a standard that ensures basic compatibility of sounds etc. between different GM-compatible instruments made by different manufacturers, but you need to be aware of the following.

- GM System On is supported in Sequencer and Song Play modes. ("GM Initialize" Sequencer P0: 0-1K, Song Play P0: 0-1A)

Roland GS and Yamaha XG are specifications by which these respective manufacturers have extended the GM standard. The TRITON STUDIO automatically converts the GS/XG sound maps into the GM2 sound map, and also supports some of the GS/XG messages. This allows GS/XG music data to be played back in Song Play mode.

-  Since the TRITON STUDIO does not support all of the GS/XG sound maps or messages, some data may not be played back correctly.

When you wish to playback a music data conform to GM/GS/XG format or load it into a song, set "Bank Map" (Global P0: 0-2a) to **GM(2)**.

### **Converting the GS/XG bank/program maps to the GM2 bank/program map**

- When bank select/program change messages used by GS/XG are received, they will automatically be converted to the G, g(1)-g(9), g(d) bank/program map of the TRITON STUDIO.
- The same conversion is performed when a SMF is loaded into a song in Disk mode.

-  For banks that are used in common by GS/XG, GS Reset/XG System ON will be received to automatically convert to the optimal bank/program map for each.

### Support for GS/XG part mode exclusive messages

- In Song Play mode when GS/XG part mode exclusive messages Drum or MDrm 1–4 are received, bank g(d) (GM2 drum bank) will be selected for the specified track. Until this part mode state is defeated, bank select messages will no longer be received for the specified track.
- When an SMF is loaded into a song in Disk mode, any bank select messages in a track that is set to a part mode of Drum or MDrm 1–4 will be ignored, and will not be loaded.

### Support for NRPN messages used in GS/XG music data

The following NRPN messages can be received to modify the sound.

Vibrato Rate	[Bn, 63, 01, Bn, 62, 08, Bn, 06, mm]
Vibrato Depth	[Bn, 63, 01, Bn, 62, 09, Bn, 06, mm]
Vibrato Delay	[Bn, 63, 01, Bn, 62, 0A, Bn, 06, mm]
Filter Cutoff	[Bn, 63, 01, Bn, 62, 20, Bn, 06, mm]
Resonance	[Bn, 63, 01, Bn, 62, 21, Bn, 06, mm]
EG Attack Time	[Bn, 63, 01, Bn, 62, 63, Bn, 06, mm]
EG Decay Time	[Bn, 63, 01, Bn, 62, 64, Bn, 06, mm]
EG Release Time	[Bn, 63, 01, Bn, 62, 66, Bn, 06, mm]
Drum Filter Cutoff	[Bn, 63, 14, Bn, 62, kk, Bn, 06, mm]
Drum Filter Resonance	[Bn, 63, 15, Bn, 62, kk, Bn, 06, mm]
Drum EG Attack Time	[Bn, 63, 16, Bn, 62, kk, Bn, 06, mm]
Drum EG Decay Time	[Bn, 63, 17, Bn, 62, kk, Bn, 06, mm]
Drum Coarse Tune	[Bn, 63, 18, Bn, 62, kk, Bn, 06, mm]
Drum Fine Tune	[Bn, 63, 19, Bn, 62, kk, Bn, 06, mm]
Drum Volume	[Bn, 63, 1A, Bn, 62, kk, Bn, 06, mm]
Drum Panpot	[Bn, 63, 1C, Bn, 62, kk, Bn, 06, mm]*
Drum Rev Send(Send2)	[Bn, 63, 1D, Bn, 62, kk, Bn, 06, mm]
Drum Cho Send(Send1)	[Bn, 63, 1E, Bn, 62, kk, Bn, 06, mm]

kk: Drum Inst No. ([0C...6C] corresponds to C0...C8)

\* [00, 01...7f] corresponds to Random, L000...R127)

### □ About standard MIDI files

Standard MIDI files (SMF) make it possible for different computer programs or musical instruments made by different manufacturers to exchange time-based MIDI data. Each standard MIDI file contains one song. The TRITON STUDIO supports format 0 (type 0) in which all of the MIDI data is combined into one track, and format 1 (type 1) in which the data is separated by track.

When a SMF is played back in Song Play mode or loaded into a song in Disk mode, the program bank that is selected will differ depending on the “Bank Map” (Global P0: 0–2a) setting. When playing/loading SMF data that conforms to the GM/GS/XG specifications, set “Bank Map” to **GM(2)**.

#### Song Play mode

- In Song Play mode, the TRITON STUDIO can playback SMF data directly from a disk or external SCSI device; i.e., the data will be played back as it is being read, and does not need to be loaded into memory.
- If the SMF data contains a GM System On message, the TRITON STUDIO will be initialized for GM playback (☞ “GM Initialize” Song Play P0: 0–1A).

#### Sequencer mode

In Disk mode when you convert a song into a Standard MIDI File and save it, you can choose either format 0 or format 1.

- If TRITON STUDIO song data that was saved as a format 1 SMF file is loaded into another device, the track configuration may be different than it was before being saved. This is because tracks that contain no musical data are omitted, and the remaining tracks are moved into the unused tracks. This will not affect the playback itself.
- If song data that was saved by another device as a format 1 SMF file is loaded into the TRITON STUDIO, the track configuration may be different than it was before being saved. This is because tracks that contain no musical data are omitted, and the remaining tracks are moved into the unused tracks. This will not affect the playback itself.

When exchanging sequence data between two TRITON STUDIO, we recommend that you save the sequence data in the TRITON STUDIO’s native format (“Save SEQ”).

When sequence data is saved in the TRITON STUDIO’s native format, all of the settings and patterns unique to the TRITON STUDIO will be saved, which will ensure a higher level of reproducibility than when the data is saved as a Standard MIDI File (“Save to Std MIDI File”).

# TRITON STUDIO MIDI IMPLEMENTATION

Consult your local Korg dealer for more information on MIDI System Exclusive implementation.

12.OCT.2001

## 1-1 TRANSMITTED DATA

Status [Hex]	Second [H] [D]	Third [H]	Description (Transmitted by ...)	ENR
8n	kk (kk)	40 (64)	Note Off (Key Off)	*1 A
9n	kk (kk)	vv (vv)	Note On (Sequence data)	*1 A
An	kk (kk)	vv (vv)	Poly Key Pressure (Sequence data)	T, Q
Bn	00 (00)	mm (mm)	Bank Select (MIDI)	*2 PB
Bn	01 (01)	vv (vv)	Modulation1 (Joy Stick 'y')	C
Bn	02 (02)	vv (vv)	Modulation2 (Joy Stick 'y')	C
Bn	04 (04)	vv (vv)	Foot Pedal (A.Pd1 = Foot Pedal)	C
Bn	05 (05)	vv (vv)	Portamento time (A.Pd1/Knob-B = Porta.Time, S Chg)	C
Bn	06 (06)	vv (vv)	Data Entry (MSB) (A.Pd1/Off, GATE, VELOCITY)	*3 C
Bn	07 (07)	vv (vv)	Portamento (A.Pd1/Knob-B = Port, S Chg)	C
Bn	08 (08)	vv (vv)	Foot FX Panpot (A.Pd1/Knob-B = FX Pan, S Chg)	C
Bn	0A (10)	vv (vv)	panpot (A.Pd1/Knob-B = Pan, S Chg)	C
Bn	0B (11)	vv (vv)	Expression (A.Pd1/Knob-B = Expression)	C
Bn	0C (12)	vv (vv)	Effect Control 1 (A.Pd1/Knob-B = FX Control1)	C
Bn	0D (13)	vv (vv)	Effect Control 2 (A.Pd1/Knob-B = FX Control2)	C
Bn	10 (16)	vv (vv)	Ribbon Controller (Ribbon Controller)	C
Bn	11 (17)	vv (vv)	Multi Purpose Ctrl1 (Knob-B = Knob Mod1)	C
Bn	12 (18)	vv (vv)	Value Slider (Knob-B = Knob Mod2)	C
Bn	13 (19)	vv (vv)	Multi Purpose Ctrl3 (Knob-B = Knob Mod3)	C
Bn	14 (20)	vv (vv)	Multi Purpose Ctrl4 (Knob-B = Knob Mod4)	C
Bn	15 (21)	vv (vv)	Bank Select (LSB) (Knob-B = Knob Mod4)	*2 PB
Bn	20 (32)	bb (bb)	Hold (Damp)	C
Bn	40 (64)	vv (vv)	Portamento Off/On (SW1/SW2/A.SW = Porta.SW, S Chg)	C
Bn	41 (65)	00/7F (00/127)	Sostenuto Off/On (A.SW = Sostenuto)	C
Bn	42 (66)	00/7F (00/127)	Soft Pedal (A.SW = Soft)	C
Bn	43 (67)	vv (vv)	Sound Controller 1 (Knob-B = F/A Sustain)	C
Bn	44 (68)	vv (vv)	Sound Controller 2 (Knob-2A, Knob-B = Resonance/HF)	C
Bn	47 (71)	vv (vv)	Sound Controller 3 (Knob-4A, Knob-B = F/A Release)	C
Bn	48 (72)	vv (vv)	Sound Controller 4 (Knob-B = F/A Attack)	C
Bn	49 (73)	vv (vv)	Sound Controller 5 (Knob-1A, Knob-B = Lpf Cutoff)	C
Bn	4A (74)	vv (vv)	Sound Controller 6 (Knob-B = F/A Decay)	C
Bn	4B (75)	vv (vv)	Sound Controller 7 (Knob-B = Pitch LFO Spd)	C
Bn	4C (76)	vv (vv)	Sound Controller 8 (Knob-B = Pitch LFO Dep)	C
Bn	4D (77)	vv (vv)	Sound Controller 9 (Knob-B = Pitch LFO Dp)	C
Bn	4E (78)	vv (vv)	Sound Controller 10 (Knob-3A, Knob-B = Filter EG Int)	C
Bn	50 (80)	00/7F (00/127)	Multi Purpose Ctrl15 (SW1/Knob-B = SW1 Mod)	C
Bn	51 (81)	00/7F (00/127)	Multi Purpose Ctrl16 (SW2/Knob-B = SW2 Mod)	C
Bn	52 (82)	00/7F (00/127)	Multi Purpose Ctrl17 (A.SW/Knob-B = Foot SW)	C
Bn	53 (83)	vv (vv)	Multi Purpose Ctrl18 (Knob-B = MIDI CCH#3)	C
Bn	5B (91)	vv (vv)	Effect 1 Depth (A.Pd1/Knob-B = MFX Send2, S Chg)	C
Bn	5C (92)	00/7F (00/127)	Effect 2 Depth (All Inset FX Off/On)	C
Bn	5D (93)	vv (vv)	Effect 3 Depth (A.Pd1/Knob-B = MFX Send1, S Chg)	C
Bn	5E (94)	00/7F (00/127)	Effect 4 Depth (Master FX1 Off/On)	C
Bn	5F (95)	00/7F (00/127)	Effect 5 Depth (Master FX2 Off/On)	C
Bn	6C (cc)	vv (vv)	Control (cc)=0-95 (Knob-B = MIDI CCH#0-95)	C
Bn	62 (98)	ss (ss)	NRPN Param No. (LSB) (ARP ON/OFF, GATE, VELOCITY)	*3 C
Bn	63 (99)	tt (tt)	NRPN Param No. (MSB) (ARP ON/OFF, GATE, VELOCITY)	*3 C
Bn	6C (cc)	vv (vv)	Control (cc)=0-101 (Sequencer data)	Q
Bn	6P (EP)	-- --	Program Change (Prog/Combi change)	*2 P
Dn	vv (vv)	-- --	Channel Pressure (After Touch)	T
En	bb (bb)	bb (bb)	Bender Change (Joy Stick X)	C

A.Pd1 : Assignable Pedal  
A.SW : Assignable Switch  
S Chg : Transmitted when change a Song No. (Seq. mode), (Status = EXT, EX2, BTH)  
C/S Chg : Transmitted when change a Combination or Song No. (Seq. mode), (Status = EXT, EX2 or BTH)  
n : MIDI Channel No. (0 - 15) ..... Usually Global channel.  
g : Always Global Channel No. (0 - 15)  
ENR = A : Always Enabled.  
C : Enabled when Enable Control Change in Global mode is checked.  
P : Enabled when Enable Program Change in Global mode is checked.  
PB : Enabled when Enable Program and Bank Change in Global mode is checked.  
T : Enabled when Enable After Touch in Global mode is checked.  
Q : Enabled when Sequencer is playing(transmit), recording(receive)

\*1 : Kk = 24 - 108 : TRITON STUDIO 61keys (61keys + Transpose)  
= 16 - 115 : TRITON STUDIO 76keys (76keys + Transpose)  
= 09 - 120 : TRITON STUDIO 88keys (88keys + Transpose)  
= 00 - 127 : Sequencer and Arpeggiator

\*2 : Program Bank/INT-A MIDI Out[Hex] (Bank Map is KORSG) (Bank Map is GM(2))  
= 00, 00 - 7F = 00, 00 - 7F  
= 01, 00 - 7F = 01, 00 - 7F  
= 02, 00 - 7F = 02, 00 - 7F  
= 03, 00 - 7F = 03, 00 - 7F  
= 04, 00 - 7F = 04, 00 - 7F  
= 05, 00 - 7F = 05, 00 - 7F  
= 06, 00 - 7F = 06, 00 - 7F  
= 07, 00 - 7F = 07, 00 - 7F  
= 08, 00 - 7F = 08, 00 - 7F  
= 09, 00 - 7F = 09, 00 - 7F  
= 0A, 00 - 7F = 0A, 00 - 7F  
= 0B, 00 - 7F = 0B, 00 - 7F  
= 0C, 00 - 7F = 0C, 00 - 7F  
= 0D, 00 - 7F = 0D, 00 - 7F  
= 0E, 00 - 7F = 0E, 00 - 7F  
= 0F, 00 - 7F = 0F, 00 - 7F  
= 10, 00 - 7F = 10, 00 - 7F  
= 11, 00 - 7F = 11, 00 - 7F  
= 12, 00 - 7F = 12, 00 - 7F  
= 13, 00 - 7F = 13, 00 - 7F  
= 14, 00 - 7F = 14, 00 - 7F  
= 15, 00 - 7F = 15, 00 - 7F  
= 16, 00 - 7F = 16, 00 - 7F  
= 17, 00 - 7F = 17, 00 - 7F  
= 18, 00 - 7F = 18, 00 - 7F  
= 19, 00 - 7F = 19, 00 - 7F  
= 1A, 00 - 7F = 1A, 00 - 7F  
= 1B, 00 - 7F = 1B, 00 - 7F  
= 1C, 00 - 7F = 1C, 00 - 7F  
= 1D, 00 - 7F = 1D, 00 - 7F  
= 1E, 00 - 7F = 1E, 00 - 7F  
= 1F, 00 - 7F = 1F, 00 - 7F  
= 20, 00 - 7F = 20, 00 - 7F  
= 21, 00 - 7F = 21, 00 - 7F  
= 22, 00 - 7F = 22, 00 - 7F  
= 23, 00 - 7F = 23, 00 - 7F  
= 24, 00 - 7F = 24, 00 - 7F  
= 25, 00 - 7F = 25, 00 - 7F  
= 26, 00 - 7F = 26, 00 - 7F  
= 27, 00 - 7F = 27, 00 - 7F  
= 28, 00 - 7F = 28, 00 - 7F  
= 29, 00 - 7F = 29, 00 - 7F  
= 2A, 00 - 7F = 2A, 00 - 7F  
= 2B, 00 - 7F = 2B, 00 - 7F  
= 2C, 00 - 7F = 2C, 00 - 7F  
= 2D, 00 - 7F = 2D, 00 - 7F  
= 2E, 00 - 7F = 2E, 00 - 7F  
= 2F, 00 - 7F = 2F, 00 - 7F  
= 30, 00 - 7F = 30, 00 - 7F  
= 31, 00 - 7F = 31, 00 - 7F  
= 32, 00 - 7F = 32, 00 - 7F  
= 33, 00 - 7F = 33, 00 - 7F  
= 34, 00 - 7F = 34, 00 - 7F  
= 35, 00 - 7F = 35, 00 - 7F  
= 36, 00 - 7F = 36, 00 - 7F  
= 37, 00 - 7F = 37, 00 - 7F  
= 38, 00 - 7F = 38, 00 - 7F  
= 39, 00 - 7F = 39, 00 - 7F  
= 3A, 00 - 7F = 3A, 00 - 7F  
= 3B, 00 - 7F = 3B, 00 - 7F  
= 3C, 00 - 7F = 3C, 00 - 7F  
= 3D, 00 - 7F = 3D, 00 - 7F  
= 3E, 00 - 7F = 3E, 00 - 7F  
= 3F, 00 - 7F = 3F, 00 - 7F  
= 40, 00 - 7F = 40, 00 - 7F  
= 41, 00 - 7F = 41, 00 - 7F  
= 42, 00 - 7F = 42, 00 - 7F  
= 43, 00 - 7F = 43, 00 - 7F  
= 44, 00 - 7F = 44, 00 - 7F  
= 45, 00 - 7F = 45, 00 - 7F  
= 46, 00 - 7F = 46, 00 - 7F  
= 47, 00 - 7F = 47, 00 - 7F  
= 48, 00 - 7F = 48, 00 - 7F  
= 49, 00 - 7F = 49, 00 - 7F  
= 4A, 00 - 7F = 4A, 00 - 7F  
= 4B, 00 - 7F = 4B, 00 - 7F  
= 4C, 00 - 7F = 4C, 00 - 7F  
= 4D, 00 - 7F = 4D, 00 - 7F  
= 4E, 00 - 7F = 4E, 00 - 7F  
= 4F, 00 - 7F = 4F, 00 - 7F  
= 50, 00 - 7F = 50, 00 - 7F  
= 51, 00 - 7F = 51, 00 - 7F  
= 52, 00 - 7F = 52, 00 - 7F  
= 53, 00 - 7F = 53, 00 - 7F  
= 54, 00 - 7F = 54, 00 - 7F  
= 55, 00 - 7F = 55, 00 - 7F  
= 56, 00 - 7F = 56, 00 - 7F  
= 57, 00 - 7F = 57, 00 - 7F  
= 58, 00 - 7F = 58, 00 - 7F  
= 59, 00 - 7F = 59, 00 - 7F  
= 5A, 00 - 7F = 5A, 00 - 7F  
= 5B, 00 - 7F = 5B, 00 - 7F  
= 5C, 00 - 7F = 5C, 00 - 7F  
= 5D, 00 - 7F = 5D, 00 - 7F  
= 5E, 00 - 7F = 5E, 00 - 7F  
= 5F, 00 - 7F = 5F, 00 - 7F  
= 60, 00 - 7F = 60, 00 - 7F  
= 61, 00 - 7F = 61, 00 - 7F  
= 62, 00 - 7F = 62, 00 - 7F  
= 63, 00 - 7F = 63, 00 - 7F  
= 64, 00 - 7F = 64, 00 - 7F  
= 65, 00 - 7F = 65, 00 - 7F  
= 66, 00 - 7F = 66, 00 - 7F  
= 67, 00 - 7F = 67, 00 - 7F  
= 68, 00 - 7F = 68, 00 - 7F  
= 69, 00 - 7F = 69, 00 - 7F  
= 6A, 00 - 7F = 6A, 00 - 7F  
= 6B, 00 - 7F = 6B, 00 - 7F  
= 6C, 00 - 7F = 6C, 00 - 7F  
= 6D, 00 - 7F = 6D, 00 - 7F  
= 6E, 00 - 7F = 6E, 00 - 7F  
= 6F, 00 - 7F = 6F, 00 - 7F  
= 70, 00 - 7F = 70, 00 - 7F  
= 71, 00 - 7F = 71, 00 - 7F  
= 72, 00 - 7F = 72, 00 - 7F  
= 73, 00 - 7F = 73, 00 - 7F  
= 74, 00 - 7F = 74, 00 - 7F  
= 75, 00 - 7F = 75, 00 - 7F  
= 76, 00 - 7F = 76, 00 - 7F  
= 77, 00 - 7F = 77, 00 - 7F  
= 78, 00 - 7F = 78, 00 - 7F  
= 79, 00 - 7F = 79, 00 - 7F  
= 7A, 00 - 7F = 7A, 00 - 7F  
= 7B, 00 - 7F = 7B, 00 - 7F  
= 7C, 00 - 7F = 7C, 00 - 7F  
= 7D, 00 - 7F = 7D, 00 - 7F  
= 7E, 00 - 7F = 7E, 00 - 7F  
= 7F, 00 - 7F = 7F, 00 - 7F

\*3 : ARPEGGIATOR ON/OFF : [ Bn.63,00, Bn.62,02, Bn.06, mm ] mm = 00(off), 7F(on)  
ARPEGGIATOR GATE Knob : [ Bn.63,00, Bn.62,0A, Bn.06, mm ] mm = 00-7F  
ARPEGGIATOR VELOCITY Knob : [ Bn.63,00, Bn.62,0B, Bn.06, mm ] mm = 00-7F

When in Program/Combination mode, Global channel.  
When in Sequencer/Song Play mode, current selected track's channel.

## 1-2 SYSTEM COMMON MESSAGES

Status [Hex]	Second [H] [D]	Third [H]	Description (Transmitted when)
F2	ss (ss)	tt (tt)	Song Position Pointer ss : Least significant [LSB] tt : Most significant [MSB] Song Select (Song or Cue List is selected) ss : Song (0-127)/Cue List (0-19) No.
F3	ss (ss)		

Transmits Song Position Pointer message when in Sequencer and Song Play mode. (Internal Clock)  
Transmits Song Select message when in Sequencer mode. (Internal Clock)  
\*4 : For example, if time signature is 4/4 or 8/8, tt.ss = 00,10 means one measure.

## 1-3 SYSTEM REALTIME MESSAGES

Status [Hex]	Description (Transmitted when ...)
F8	Timing Clock (Always in Prog/Combi/Seq/Song Play mode)
F9	Start (START in Song Play mode)
FA	Continue (CONTINUE in Song Play mode)
FB	Stop (STOP in Song Play mode)
FC	Active Sensing (Always)
FE	

\* Transmits these messages when MIDI Clock in Global mode is Internal.

## 1-4 SYSTEM EXCLUSIVE

1-4-1 UNIVERSAL SYSTEM EXCLUSIVE MESSAGE (NON REALTIME)  
DEVICE INQUIRY REPLY (Transmits when received a INQUIRY MESSAGE REQUEST)  
[ F0, 7E, 09, 06, 02, 42, 63, 00, 01, 00, nn, 00, vv, 00, F7 ]  
3rd byte g : Global Channel  
6th byte 42 : KORSG ID  
9th byte mm : TRITON STUDIO 61keys member code mm = 25  
TRITON STUDIO 76keys member code mm = 28  
TRITON STUDIO 88keys member code mm = 37  
11th byte nn : System No. ( 01 - )  
13th byte vv : System Version ( 01 - )

## 1-4-2 UNIVERSAL SYSTEM EXCLUSIVE MESSAGES (REALTIME)

Master Volume  
[ F0, 7F, 09, 04, 01, vv, mm, F7 ]  
3rd byte g : Global Channel  
6th byte vv : Value (LSB)  
7th byte mm : Value (MSB)  
mm, vv = 00, 00 - 7F, 7F : Min - Max



2. RECOGNIZED RECEIVE DATA

2-1 CHANNEL MESSAGES

[H] :Hex, [D] :Decimal

Status [Hex]	Second [H] [D]	Third [H]	Description ( Use ..... )	ENA
Bn	kk (kk)	xx (xx)	Note Off	A
Bn	kk (kk)	00 (00)	Note On (vv)=1-127	A
Bn	kk (kk)	vv (vv)	Poly Key Pressure	T,Q
Bn	kk (kk)	vv (vv)	Bank Select (MSB)	*1
Bn	00 (00)	mm (mm)	Modulation2	C
Bn	01 (01)	vv (vv)	( as Joy Stick + Y )	P
Bn	02 (02)	vv (vv)	( as Joy Stick - Y )	C
Bn	04 (04)	vv (vv)	Foot Pedal	C
Bn	05 (05)	vv (vv)	Portamento Time	C
Bn	06 (06)	vv (vv)	Data Entry (MSB)	C
Bn	07 (07)	vv (vv)	Volume	C
Bn	08 (08)	vv (vv)	Balance Control	C
Bn	0A (10)	vv (vv)	Panpot	C
Bn	0B (11)	vv (vv)	Expression	C
Bn	0C (12)	vv (vv)	E effect Control 1 ( as FX Dmod Src = FXCtrl1 )	C
Bn	0D (13)	vv (vv)	Effect Control 2 ( as FX Dmod Src = FXCtrl2 )	C
Bn	10 (16)	vv (vv)	Multi Purpose Ctrl1 ( as Ribbon Controller )	C
Bn	11 (17)	vv (vv)	Multi Purpose Ctrl2 ( as AMS & FX Dmod Src = KnobMod1 )	C
Bn	12 (18)	vv (vv)	Multi Purpose Ctrl3 ( as Value Slider )	C
Bn	13 (19)	vv (vv)	Multi Purpose Ctrl4 ( as AMS & FX Dmod Src = KnobMod2 )	C
Bn	14 (20)	vv (vv)	( as AMS & FX Dmod Src = KnobMod3 )	C
Bn	15 (21)	vv (vv)	( as AMS & FX Dmod Src = KnobMod4 )	C
Bn	20 (32)	bb (bb)	Data Entry (LSB)	*1
Bn	26 (38)	vv (vv)	( for Prog/Combi change )	C
Bn	40 (64)	vv (vv)	( for RPC edit )	C
Bn	41 (65)	S3P/240 (S63/264)	Hold	C
Bn	42 (66)	S3P/240 (S63/264)	Portamento Off/On	C
Bn	43 (67)	vv (vv)	Soft Pedal	C
Bn	46 (70)	vv (vv)	Sound Controller 1 ( for Sustain Level control )	C
Bn	47 (71)	vv (vv)	Sound Controller 2 ( for Resonance/HPF Cutoff ctrl )	C
Bn	48 (72)	vv (vv)	Sound Controller 3 ( for Release Time control )	C
Bn	49 (73)	vv (vv)	Sound Controller 4 ( for Attack Time control )	C
Bn	4A (74)	vv (vv)	Sound Controller 5 ( for LFO Cutoff control )	C
Bn	4B (75)	vv (vv)	Sound Controller 6 ( for Decay Time control )	C
Bn	4C (76)	vv (vv)	Sound Controller 7 ( for LFO1 Speed control )	C
Bn	4D (77)	vv (vv)	Sound Controller 8 ( for LFO1 Pitch Depth control )	C
Bn	4E (78)	vv (vv)	Sound Controller 9 ( for LFO1 Delay control )	C
Bn	4F (79)	vv (vv)	Sound Controller 10 ( for Filter-BG Intensity ctrl )	C
Bn	50 (80)	vv (vv)	Multi Purpose Ctrl5 ( as AMS & FX Dmod Src = SW 1 )	C
Bn	51 (81)	vv (vv)	Multi Purpose Ctrl6 ( as AMS & FX Dmod Src = SW 2 )	C
Bn	52 (82)	vv (vv)	Multi Purpose Ctrl7 ( as AMS & FX Dmod Src = Foot SW )	C
Bn	53 (83)	vv (vv)	Multi Purpose Ctrl8 ( as AMS & FX Dmod Src = CCH83 )	C
Bn	58 (91)	vv (vv)	Effect 1 Depth	C
Bn	5C (92)	00/400 (00/400)	Effect 2 Depth	C
Bn	5D (93)	00/400 (00/400)	Effect 3 Depth	C
Bn	5E (94)	00/400 (00/400)	Effect 4 Depth	C
Bn	5F (95)	00/400 (00/400)	Effect 5 Depth	C
Bn	60 (96)	00 (00)	Data Increment	C
Bn	61 (97)	00 (00)	Data Decrement	C
Bn	62 (98)	ss (ss)	NRPN Param No. (LSB) ( for NRPN select )	*3
Bn	63 (99)	tt (tt)	NRPN Param No. (MSB) ( for NRPN select )	*3
Bn	64 (100)	0r (0r)	RPN Param No. (LSB) ( for RPN select )	*4
Bn	65 (101)	00 (00)	RPN Param No. (MSB) ( for RPN select )	*4
Bn	cc (cc)	vv (vv)	Control data	C
Bn	78 (120)	00 (00)	All Sound Off	C,Q
Bn	79 (121)	00 (00)	Reset All Controllers	C
Bn	7A (122)	00/7F (00/127)	Local Control Off/On	A
Bn	7B (123)	00 (00)	All Notes Off	A
Bn	7C (124)	00 (00)	Omi Mode Off	A
Bn	7D (125)	00 (00)	Omi Mode On	A
Bn	7E (126)	S10 (S16)	Mono Mode On	A
Bn	7F (127)	00 (00)	Poly mode On	A
Cn	FP (fp)	-- --	Program Change	*1
Cn	vv (vv)	-- --	Channel Pressure	C
Cn	bb (bb)	bb (bb)	Bender Change	T

AMS : Alternate Modulation Source  
FX Dmod Src : Effect Dynamic Modulation Source

n : MIDI Channel No. ( 0 - 15 ) \*\*\*\*\* Usually Global Channel.  
g : When in Combination/Sequencer/Song Play mode, each timbre is track's channel. (Status is INT or BTH)  
x : Always Global Channel No. ( 0 - 15 )  
x : Random  
ENA : Same as Transmitted data

\*1 : When Bank Map in Global mode is KORG/  
Program

MIDI In [Hex]	00,00	00 - 7F	: Bank INT-A	000 - 127	: Bank INT-A 000 - 127
mm,bb,pp	00,01	00 - 7F	: Bank INT-B	000 - 127	: Bank INT-B 000 - 127
	00,02	00 - 7F	: Bank INT-C	000 - 127	: Bank INT-C 000 - 127
	00,03	00 - 7F	: Bank INT-D	000 - 127	: Bank INT-D 000 - 127
	00,04	00 - 7F	: Bank INT-E	000 - 127	: Bank INT-E 000 - 127
	00,05	00 - 7F	: Bank INT-F	000 - 127	: Bank INT-F 000 - 127
	00,08	00 - 7F	: Bank EXB-A	000 - 127	: Bank EXB-A 000 - 127
	00,09	00 - 7F	: Bank EXB-B	000 - 127	: Bank EXB-B 000 - 127
	00,0A	00 - 7F	: Bank EXB-C	000 - 127	: Bank EXB-C 000 - 127
	00,0B	00 - 7F	: Bank EXB-D	000 - 127	: Bank EXB-D 000 - 127
	00,0C	00 - 7F	: Bank EXB-E	000 - 127	: Bank EXB-E 000 - 127
	00,0D	00 - 7F	: Bank EXB-F	000 - 127	: Bank EXB-F 000 - 127
	00,0E	00 - 7F	: Bank EXB-G	000 - 127	: Bank EXB-G 000 - 127
	79,00	00 - 7F	: G	001 - 128	
	79,01-09	00 - 7F	: g(1)-g(9)	001 - 128	
	78,00	00 - 7F	: g(d)	001 - 128	
	38,00	00 - 7F	: G	001 - 128	
	3E,00	00 - 7F	: G(d)	001 - 128	

When Bank Map in Global mode is GM(2);  
Program

MIDI In [Hex]	3F,00	00 - 7F	: Bank INT-A	000 - 127	: Bank INT-A 000 - 127
mm,bb,pp	3F,01	00 - 7F	: Bank INT-B	000 - 127	: Bank INT-B 000 - 127
	3F,02	00 - 7F	: Bank INT-C	000 - 127	: Bank INT-C 000 - 127
	3F,03	00 - 7F	: Bank INT-D	000 - 127	: Bank INT-D 000 - 127
	3F,04	00 - 7F	: Bank INT-E	000 - 127	: Bank INT-E 000 - 127
	3F,05	00 - 7F	: Bank INT-F	000 - 127	: Bank INT-F 000 - 127
	3F,08	00 - 7F	: Bank EXB-A	000 - 127	: Bank EXB-A 000 - 127
	3F,09	00 - 7F	: Bank EXB-B	000 - 127	: Bank EXB-B 000 - 127
	3F,0A	00 - 7F	: Bank EXB-C	000 - 127	: Bank EXB-C 000 - 127
	3F,0B	00 - 7F	: Bank EXB-D	000 - 127	: Bank EXB-D 000 - 127
	3F,0C	00 - 7F	: Bank EXB-E	000 - 127	: Bank EXB-E 000 - 127
	3F,0D	00 - 7F	: Bank EXB-F	000 - 127	: Bank EXB-F 000 - 127
	3F,0E	00 - 7F	: Bank EXB-G	000 - 127	: Bank EXB-G 000 - 127
	79,00	00 - 7F	: G	001 - 128	
	79,01-09	00 - 7F	: g(1)-g(9)	001 - 128	
	78,00	00 - 7F	: g(d)	001 - 128	
	00,00	00 - 7F	: G	001 - 128	
	38,00	00 - 7F	: G	001 - 128	
	3E,00	00 - 7F	: G(d)	001 - 128	
	3F,7F	00 - 7F	: Mute (KORG MUTE)		
	(XG) 00,01 -		: Assign correspond program in G, g(1) - g(9)		
	(GS) 01,00 -		: Assign correspond program in G, g(1) - g(9)		

\*2 : When in Program/Sampling mode, Global channel.  
When in Combination/Sequencer/Song Play mode, each IFX's channel.

\*3 : tt.ss = 00.02 : Arpeggiator Off/On  
= 00.0A : Arpeggiator Gate control  
= 00.0B : Arpeggiator Velocity control

When in Program/Combination mode, Global channel message is valid.  
Data Entry LSB value has no effect.

tt.ss = 01.08	: Vibrato Rate
tt.ss = 01.09	: Vibrato Depth
tt.ss = 01.0A	: Vibrato Delay
tt.ss = 01.20	: Filter Cutoff
tt.ss = 01.21	: Filter Resonance
tt.ss = 01.64	: EG Attack Time
tt.ss = 01.65	: EG Decay Time
tt.ss = 01.66	: EG Release Time
tt.ss = 14.kk	: Drum Filter Cutoff
tt.ss = 15.kk	: Drum Filter Resonance
tt.ss = 16.kk	: Drum EG Attack Time
tt.ss = 17.kk	: Drum EG Decay Time
tt.ss = 18.kk	: Drum Coarse Tune
tt.ss = 19.kk	: Drum Fine Tune
tt.ss = 1A.kk	: Drum Volume
tt.ss = 1C.kk	: Drum Panpot
tt.ss = 1D.kk	: Drum Rev Send(Send2)
tt.ss = 1E.kk	: Drum Cho Send(Send1)

\* Only valid when Part Mode is Drum, MDrm1 - MDrm4.  
kk: Drum Inst No. (0C - 6C = CO - C8)  
Data Entry LSB value has no effect.

\*4 : r = 0 : Pitch Bend Sensitivity ( Bend Range )  
 = 1 : Fine Tune ( Detune )  
 = 2 : Coarse Tune ( Transpose )

For drum program, both of Fine Tune and Coarse Tune affect to Detune.  
 Data Entry LSB value has no effect for Pitch Bend Sensitivity and Coarse Tune.

## 2-2 SYSTEM COMMON MESSAGES

Status [Hex]	Second [H]	Third [D]	Description ( Use for ..... )
F2	ss (ss)	tt (tt)	Song Position Pointer ( Location ) *6 ss : Least significant [LSB] tt : Most significant [MSB]
F3	ss (ss)		Song Select (Song or Cue List select) *5 ss : Song(0-127)/Cue List(0-19) No.

Receive when in Sequencer mode.  
 When in the Cue List page (Sequencer mode Pl), respond to location and No. of Cue List.

## 2-3 SYSTEM REALTIME MESSAGES

Status[Hex]	Description ( Use for..... )
F8	Timing Clock ( Tempo, RMS & FX Dmod Src ) *5
FA	Start ( Seq Start & Arpeggiator Control ) *6
FB	Sustain ( Seq Sustain Start & Arpeggiator Control ) *6
FC	Continue ( Seq Stop & Arpeggiator Control ) *6
FE	Active Sensing ( MIDI Connect check ) *6

\*5 Receive when MIDI Clock in Global mode is External MIDI or External MLAN.  
 \*6 Receive when MIDI Clock in Global mode is External MIDI or External MLAN and Receive Ext. Realtime Commands in Global mode is checked.

## 2-4 SYSTEM EXCLUSIVE

### 2-4-1 UNIVERSAL SYSTEM EXCLUSIVE MESSAGE ( NON REALTIME )

○ DEVICE INQUIRY ( When received this message, transmits INQUIRY MESSAGE REPLY )  
 [ F0,7E,rm,06,01,F7 ] 3rd byte mn : Channel = 0 - F : Global Channel  
 [ F0,7E,rm,09,01,F7 ] 3rd byte mn : Channel = 0 - F : Global Channel  
 = 7F : Any Channel

### 2-4-2 UNIVERSAL SYSTEM EXCLUSIVE MESSAGES ( REALTIME )

○ Master Volume  
 [ F0,7F,09,04,01,vv,mm,F7 ] 3rd byte g : Global Channel  
 6th byte vv : Value (LSB)  
 7th byte mm,vv = 00,00 - 7F,7F : Min - Max

○ Master Balance  
 [ F0,7F,09,04,02,vv,mm,F7 ] 3rd byte g : Global Channel  
 6th byte vv : Value (LSB)  
 7th byte mm,vv = 00,00:Left, 40,00:Center, 7F,7F:Right

○ Master Fine Tune ( Control Master Tune(cent) in Global )  
 [ F0,7F,09,04,03,vv,mm,F7 ] 3rd byte g : Global Channel  
 6th byte vv : Value (LSB)  
 7th byte mm,vv = 20,00:-50, 40,00:+00, 60,00:+50

○ Master Coarse Tune ( Control Transpose (chromatic step) in Global )  
 [ F0,7F,09,04,04,vv,mm,F7 ] 3rd byte g : Global Channel  
 6th byte vv : Value (LSB)  
 7th byte mm,vv = 34,00:-12, 40,00:+00, 4C,00:+12

## Various messages

### A

#### Already connected

Meaning: When you pressed the Connect button to execute a connection in the Global mode mLAN Output/Input page, a connection had already been set for the specified input plug.

Action: Check the connection data of the receiving mLAN device. If the plug and connection have already been specified on the receiving device, it is possible that the current display is out of date, so re-select the mLAN Output/Input page to re-display it. If a connection from another output plug was assigned to the input plug, break this connection and then re-execute it.

#### Are you sure ?

Meaning: This message asks you to confirm execution. To execute press the **OK button**. To cancel, press the **Cancel button**.

### B

#### Battery voltage for Calender IC is low

Meaning: The calendar backup battery has run down.

Action: Replace the battery as described in "Replacing the calendar backup battery" (p.286, 298).

#### Buffer overrun error occurred

Meaning: While sampling to the hard disk, the disk could not be written fast enough to keep up with sampling.

Action: Execute the Disk mode Utility page menu command "Check Medium." If this does not solve the problem, copy several files from the hard disk to other media, then erase those files and execute the operation again.

#### Buffer underrun error occurred

Meaning: While playing back a WAV file from the hard disk, the disk could not be read fast enough for playback processing.

Action: Copy the desired file to another folder etc., and then execute once again.

### C

#### Can't calibrate

Meaning: Calibration could not be performed correctly.

Action: Try again.

#### Can't copy/swap double size effect

Meaning: When copying or swapping an insertion effect, you attempted to place a double-size effect in IFX1 or IFX5.

Action: Modify your settings so that a double-size effect is not moved to IFX1 or 5, and execute again.

#### Can't open pattern

#### Continue ?

Meaning: When you finished recording or editing, it was not possible to allocate enough memory to open the pattern that was Put into the track. (When it must be opened automatically.) If you press the OK button, the pattern data will be deleted, and the recorded or edited content will be saved. If you press the Cancel button, the recorded or edited content will be discarded.

#### Completed

Meaning: Execution of the command ended normally.

#### Connection protected

Meaning: When you pressed the Cut button to break a connection in the Global mode mLAN Output/Input page, the specified connection was protected, and cannot be broken.

Action: Defeat the protect setting on the mLAN device from which protection was applied, and then press the Cut button once again.

### D

#### Destination and source are identical

Meaning: When copying or bouncing, the same cue list, song, track or pattern was selected for both the source and destination.

Action: Select a different cue list, song, track, or pattern for the source and destination.

#### Destination from-measure within the limits of source

Meaning: When executing the Move Measure command for all tracks or within the same track, the specified destination measure is within the source range.

Action: Set a destination measure that is outside of the source range.

#### Destination is empty

Meaning: When editing, the track or pattern that was specified as the destination contains no musical data.

Action: Select a track or pattern that contains musical data.

#### Destination measure is empty

Meaning: The measure that was specified as the destination contains no data.

Action: Specify a destination measure that contains data.

#### Destination multisample already exists

Meaning: A multisample already exists at the destination (save location) multisample.

Action: Either delete the multisample at the destination (save location), or change the save destination multisample number.

#### Destination multisample and source multisample are identical

Meaning: The same multisample is selected for the source and destination.

Action: Select different multisamples for the source and destination.

### Destination sample already exists

Meaning: A sample already exists at the destination (save location).

Action: Either delete the sample at the destination (save location), or change the save destination sample number.

### Destination sample data used in source sample Can't overwrite

Meaning: Since the sample data at the destination (save location) is also used by the source sample, it cannot be overwritten.

Action: Without using Overwrite, specify a different sample for the destination (save location).

### Destination sample is empty

Meaning: The sample for editing is empty.

### Destination song is empty

Meaning: The song that was specified as the copy destination or bounce destination does not exist.

Action: Execute the Create New Song command in the dialog box that appears when a new song is selected before copying or bouncing.

### Directory is not empty Cleanup directory Are you sure?

Meaning: When deleting a directory, files or directories exist within that directory.

Action: Press the OK button to delete all files and/or directories within that directory.

### Disc full

Meaning: When executing "Write to CD," there is insufficient space remaining on the CD-R/RW for the data to be written.

Action: Either write to other media, or remove unneeded tracks.

### Disk not formatted

Meaning: When you attempted to perform a high-level format (quick format) of media, the media had not been physically formatted yet.

Action: Execute the Disk mode Utility "Format" to physically format the media (full format).

## E

### Error in formatting medium

Meaning: An error occurred while performing a physical format (full format) or high-level format (quick format) of the media.

Action: Use other media.

Meaning: When executing the Disk mode utility command "Convert to ISO9660 Format," an error occurred while rewriting the UDF area.

Action: Use other media.

### Error in reading from medium

Meaning: An error occurred while reading data from a medium.

Action: Execute the reading operation once again. If the same error occurs, it is possible that the data on the disk has been damaged.

### Error in writing to medium

Meaning: An error occurred while writing data to a medium. (Verify error)

Action: It is possible that the media has been physically damaged. Try another media. Avoid using the media that produced the error.  
In the case of MS-DOS format media, execute the Disk mode Utility page command "Check Medium."

## F

### Failed in the initialization of EXB-mLAN

Meaning: Failed to initialize the mLAN connection settings, word clock synchronization settings, and other internal data of the EXB-mLAN (when the EXB-mLAN option is installed).

Action: Disconnect the IEEE 1394 cable from the mLAN connector of the EXB-mLAN, and execute initialization once again. If an error still occurs, please contact your Korg distributor.

### File already exists

Meaning: When executing a Create Directory or File Rename operation, a directory or file of the same name already exists on the disk.

Meaning: When executing the Disk mode Utility "Copy" command without using wild cards, the copy destination contained a file of the same name as the copy source.

Meaning: When you executed the Disk mode Utility "Save Sampling Data" for All, All Multisamples, All Samples, or One Multisample, a directory already existed on the disk with the same name as the directory that you attempted to create on the TRITON STUDIO.

Meaning: When sampling or saving to the hard disk, a file of the same name already exists.

Action: Either delete the existing directory or file, or specify a different filename.

### File contains unsupported data

Meaning: You attempted to load an AIFF, WAVE, or KSF file that was in a format not supported by the TRITON STUDIO.

Action: In the case of a AIFF or WAVE file, use a computer (if possible) to convert the file into a format that is supported on the TRITON STUDIO, and then load it.

### File is read-only protected

Meaning: You attempted to write to a file or to delete a file that had a read-only attribute.

Meaning: You attempted to save a file to media that contained a read-only file of the same name.

Action: Save the file with a different name.

### File unavailable

Meaning: You attempted to load or open a file whose format was incorrect.

### File/path not found

Meaning: When loading a sample file in Disk mode, the specified file does not exist. Alternatively, the specified filename does not exist in the location you selected in a dialog box for choosing another directory level or other media.

Meaning: When executing the "Delete" command in the Disk mode Utility page, the specified file did not exist.

Meaning: When executing the "Copy" command in the Disk mode Utility page, and you used a wild card to specify the copy file name, the specified file was not found. Alternatively, the length of the copy source path name exceeded 76 characters.

Meaning: In Disk mode or Song Play mode when you used the Open button to open a directory, the path length including the selected directory name exceeded 76 characters.

Meaning: When executing Insert in the Disk mode Make Audio CD page, you attempted to use the Insert All button to add a WAVE file, but no WAVE file with a sampling frequency of 44.1 kHz or 48 kHz exists in the selected directory.

Action: Check the file or directory.

Meaning: In Disk mode when loading a .KCD file, a WAVE file listed in the Audio Track List could not be found.

Action: The file whose Size is not shown in the Disk mode Make Audio CD page is the one that could not be found. Check the file or directory, or delete it from the Audio Track List.

### Front sample data used in rear sample

#### Can't overwrite

Meaning: When executing "Link" in the Sampling mode Sample Edit page, the sample data of the front sample is also being used by the rear sample, and therefore cannot be overwritten.

Action: Instead of using "Overwrite," specify a different sample as the save-destination.

## I

### Illegal file description

Meaning: The filename that you specified when saving a file or creating a directory contained invalid characters.

Action: Change the filename you are specifying. Filenames not permitted by MS-DOS cannot be used as a filename.

### Illegal mLAN message

Meaning: The EXB-mLAN received an invalid message (if the EXB-mLAN option is installed).

### Illegal SMF data

Meaning: You attempted to load a file that was not a Standard MIDI File.

### Illegal SMF division

Meaning: You attempted to load a Standard MIDI File that was timecode-based.

### Illegal SMF format

Meaning: You attempted to load a Standard MIDI File of a format other than 0 or 1.

### Inconvertible file exists

Meaning: A file that cannot be used with ISO9660 format exists on the media.

Action: Media that was formatted or written by a device other than the TRITON STUDIO may be impossible for the TRITON STUDIO to convert into ISO9660 format. To perform the conversion, use the packet writing software that was used to format or write the media.

### Index number over limit

Meaning: When sampling into RAM in Combination, Program, or Sequencer mode, there are too many indexes to be simultaneously converted into a multisample.

Action: Either convert the samples into a different program or multisample, or use Sampling mode to delete some of the indexes before you continue sampling.

## M

### Master Track can't be recorded alone

Meaning: When realtime-recording a single track, you attempted to begin recording with the master track as the current track.

Action: Begin recording with a track 1-16.

### Measure size over limit

Meaning: When loading a Standard MIDI File, the number of events in a measure exceeded the maximum (approximately 65,535 events).

Meaning: The attempted edit operation would cause the maximum number of events in a measure (approximately 65,535) to be exceeded.

Action: Use event editing etc. to delete unwanted data.

### Measure number over limit

Meaning: The attempted edit operation would cause the track length to exceed 999 measures.

Action: Delete unnecessary measures.

### Medium changed

Meaning: When executing the "Copy" command in the Disk mode Utility page, the media was exchanged or ejected, and it was not possible to copy between separate media on the same drive.

### Medium unavailable

Meaning: You selected a medium that does not allow writing.

### Medium write protected

Meaning: The floppy disk or other writing-destination media is write-protected.

Action: Turn off write protect on the floppy disk or other media, and execute the command once again.

### Memory full

**Meaning:** In Sequencer mode when editing a song, track or pattern, the total data of all songs has used up all of the sequence data memory, and further editing is not possible.

**Action:** Delete other song data etc. to increase the amount of free memory.

**Meaning:** While realtime recording in Sequencer mode, there is no more free memory to accommodate the recorded data, so recording has been forcibly halted.

**Action:** Delete other song data etc. to increase the amount of free memory.

### Memory overflow

**Meaning:** While receiving exclusive data in Disk mode "Save Exclusive," all remaining internal memory was used up.

**Action:** If you are receiving two or more sets of exclusive data, transmit them separately to the TRITON STUDIO.

**Meaning:** In Disk mode, you attempted to load more sample waveform data than there was free memory capacity.

**Action:** In Sampling mode, execute Delete sample to create free space in the sample waveform data area, and re-load the data.

### Memory protected

**Meaning:** The internal program, combination, song, drum kit, or user arpeggio pattern is protected.

**Action:** In Global mode, turn off write-protect, and execute the write or load operation once again.

### MIDI data receiving error

**Meaning:** While receiving MIDI exclusive data, the format of the received data was invalid, for example because the size of the data was incorrect.

### Multisample L and R are identical

**Meaning:** Since the destination (save location) L and R multisample numbers are the same, the editing operation could not be executed.

**Action:** Select a different multisample number for the L and R of the destination (save location).

## N

### No connection

**Meaning:** In the Global mode mLAN Output/Input page when you pressed the Cut button to break a connection, the specified connection had not been set. It is possible that the connection settings have been changed from another device.

**Action:** Check the connection settings of the connected mLAN device. If a connection has not been specified for the plug of the receiving device, or if it is connected to a different output plug, it is possible that the current display is out of date, so re-select the mLAN Output/Input page to re-display the page.

### No data

**Meaning:** When loading a Standard MIDI File, the file contained no events.

**Meaning:** When you executed Samples in One Multisample in "Export Smpl as AIFF/WAVE," there were no samples.

**Action:** Create sample data.

### No medium

**Meaning:** When executing a command in Disk mode, no media (floppy disk etc.) was inserted in the drive.

**Action:** Insert media such as a floppy disk, or mount the drive.

### No node

**Meaning:** When you pressed the Connect in the Global mode mLAN Output/Input page, no mLAN device existed on the bus.

**Action:** Check whether an mLAN device is connected to the EXB-mLAN. If it is connected correctly, check whether it supports mLAN. (When the EXB-mLAN option is installed)  
Also check that the connected mLAN device is operating correctly.

### No recording track specified

**Meaning:** When performing realtime multi-track recording, you attempted to begin recording with no tracks set to REC.

**Action:** Set the desired tracks for recording to REC.

### No space available on medium

**Meaning:** When you attempted to save or copy a file, or to create a directory, there was not enough free space on the floppy disk or other medium.

**Action:** Either delete an existing file, or exchange the medium with one that has sufficient free space.

### No space available on medium

#### Do you want to make a divided file?

**Meaning:** When saving a .PCG or .KSF file, there was insufficient free space on the media. Please specify whether you want to save the file in divided form.

**Action:** Press the OK button to save the file across multiple volumes of media, or press the Cancel button to cancel.

### Not enough memory

**Meaning:** When starting realtime recording in Sequencer mode, the minimum amount of free memory (such as memory for the BAR events up to the recording start location) could not be allocated.

**Action:** Delete other song data etc. to increase the amount of free memory.

**Meaning:** When executing "Load Exclusive," you attempted to load an .EXL file that required more than 1,048,576 bytes. Such a file cannot be loaded by the TRITON STUDIO.

### Not enough memory to load

Meaning: When you attempted to load a .SNG file or a standard MIDI file in Disk mode, there was insufficient free memory in the sequence memory.

Action: Delete other song data etc. to increase the amount of free memory.

### Not enough memory to open pattern

Meaning: There was insufficient sequencer memory to open the pattern, so editing is not possible.

Action: Either delete unwanted data such as a song, track, or pattern, or do not open the pattern.

### Not enough multisample memory

Meaning: There is insufficient multisample memory. (The number of multisamples would exceed the maximum of 1,000.)

Action: Delete multisamples to increase the amount of free memory.

### Not enough relative parameter memory

Meaning: There is insufficient memory for relative parameters. (The number of samples in the multisamples would exceed the maximum of 4,000.)

Action: Delete multisamples or indices of multisamples to increase the amount of free memory.

### Not enough sample memory

Meaning: There is insufficient sample memory (for sample parameters or sample waveform data).

Action: Delete samples to increase the amount of free memory.

### Not enough sample/multisample locations available

Meaning: The data you attempted to load would exceed the maximum number of multisamples or samples.

Action: In Sampling mode, execute "Delete Multisample" or "Delete Sample" to free a sufficient number, and reload the data.

### Not enough song locations available

Meaning: When loading a .SNG file with "Append" specified, you attempted to load more songs than can be loaded.

Action: In Sequencer mode, execute "Delete Song" to increase the number of multi's that can be used, and then load the song again.

### Not enough song memory

Meaning: When executing the Sampling mode "Time Slice" or "Save" commands, the total data for all songs occupies all of the sequence data memory area, so that saving is not possible.

Meaning: When sampling to RAM in Sequencer mode, it is not possible to create track data at the same time.

Action: Increase the amount of free memory, for example by deleting another song.

## O

### Obey Copyright Rules

Meaning: This will be displayed when you make settings for S/P DIF Input or mLAN input, when you execute the Disk mode Make Audio CD page "Write to CD" command, or when you execute "Destination" in the Sampling mode Audio CD page "Destination" command. Please read "About copyright" (BG p.iii) before you use this data.

### Oscillator Mode conflicts (check PROG P1)

Meaning: In Sampling mode when you executed "Convert MS To Program" with Use Destination Program Parameters checked, the conversion destination program "Oscillator Mode" setting did not match.

Action: In Program mode, set the "Oscillator Mode" of the conversion destination program. If converting a monaural multisample, select Single. If converting a stereo multisample, select Double.

## P

### Pattern conflicts with events

Meaning: It was not possible to execute the Bounce operation because one of the tracks contained a pattern, and the same measure of the other track contained events or a pattern.

Action: Open the pattern.

### Pattern exists across destination to-end-of-measure or source from-measure

Meaning: When moving a measure, the edit operation could not be executed because a pattern had been put in the destination end measure or the source start measure, and had not been opened.

Action: Open the pattern.

### Pattern exists in destination or source track

#### Open pattern ?

Meaning: A pattern has been placed in the track that you specified as a destination or source for editing. If you wish to open the pattern and execute (the events of the pattern will be copied), press the OK button. If you wish to execute without opening the pattern, press the Cancel button.

### Pattern used in song

#### Continue ?

Meaning: When editing, the specified pattern has been placed in a track. If you wish to execute, press the OK button. If you decide not to execute, press the Cancel button.

## R

### Rear sample is empty

Meaning: When you executed "Link" in the Sampling mode Sample Edit page, the sample that you specified as the rear sample is empty.

Action: Specify a sample that contains data as the rear sample, and execute once again.

### Request rejected

Meaning: In the Global mode mLAN Output/Input page, a request to mLAN was not accepted.

**Action:** Check that connections between mLAN devices are correct.

#### **Root directory is full**

**Meaning:** You attempted to create a file or directory in the root directory of the media, but this would exceed the maximum number of root directory entries.

**Action:** Either delete an existing file or directory, or Open a directory to move down one level before executing once again.

## **S**

#### **Sample data used in other sample(s)      Continue ?**

**Meaning:** Other sample(s) use the same sample data as the sample that you are editing. To continue editing, press the OK button.

#### **Sample L and R are identical**

**Meaning:** The edit operation could not be executed because the destination (save location) L and R sample numbers are identical.

**Action:** Select different sample numbers for L and R of the destination (save location).

#### **Sample length is shorter than minimum**

**Meaning:** You attempted to execute an editing operation that would make the sample data shorter than 8 samples.

**Action:** Change the editing range so that the sample data will be longer than 8 samples.

#### **Sample used in other multisample(s)      Continue ?**

**Meaning:** The sample you are editing is used by other multisamples. To continue editing, press the OK button.

#### **Selected banks are the same**

**Meaning:** This is a dialog box displayed when you load a TRITON STUDIO .PCG file that contains drum kit banks C/D/User or user arpeggio banks C/D, and indicates that the specified loading destination bank is the same bank.

**Action:** Press the OK button to acknowledge the error message, return to the dialog box where you specify the bank, and re-specify the loading destination bank.

#### **Selected file/path is not correct**

**Meaning:** When loading a divided .PCG file, you attempted to load a .PCG file of the same name that was not divided or had differing contents.

**Action:** Load the correct .PCG file.

**Meaning:** When loading a KSF file that was split across multiple media, the order in which you attempted to load the files was incorrect.

**Action:** Load the KSF file in the correct order. To view the file number order in which the KSF files were saved, you can check the "Translation" page menu command. (The sample name and number of the first KSF file will be displayed.)

#### **Slice point over limit**

#### **Can't divide**

**Meaning:** When using the Sampling mode "Time Slice" or "Time Stretch" commands, the Slice setting would divide the sample into more samples than the maximum possible number (1000), and thus "Divide" cannot be executed.

**Action:** Use "Link" to connect any "Index" that you do not require, and then execute "Divide."

#### **Source file is not 48000Hz**

#### **Can't convert**

**Meaning:** When executing the Disk mode Utility page menu command "Rate Convert," you selected a WAVE file of a sampling rate other than 48000 Hz.

**Action:** WAVE files of other than 48000 Hz cannot be converted to 44100 Hz.

#### **Source is empty**

**Meaning:** No data exists in the track or pattern that you specified as the source.

**Action:** Specify a track or pattern that contains musical data.

#### **Source sample is empty**

**Meaning:** When executing Insert, Mix, or Paste, the source sample is empty.

**Action:** Execute the Copy operation before executing Insert, Mix, or Paste.

#### **S/P DIF Clock Error !**

**Meaning:** When "System Clock" was set to S/P DIF, the clock could not be detected correctly.

**Action:** Check whether the digital output from the external device is being output correctly. Sampling frequencies of 48 kHz and 96 kHz can be input to the TRITON STUDIO. Also check whether there is a problem with the optical cable.

## **T**

#### **There is no node**

**Meaning:** The mLAN device specified in the Global mode mLAN Output/Input page does not exist.

**Action:** Check whether the specified mLAN device has been turned off, or whether the cable has been disconnected.



---

### **There is no plug**

Meaning: The plug specified in the Global mode mLAN Output/Input page does not exist.

Action: Execute the operation once again. If the same error occurs, check whether the mLAN device containing the specified plug is operating correctly.

### **There is no readable data**

Meaning: Either the file size is 0 or the file does not contain data that can be accessed by the load or open operation. Alternatively, the data is damaged etc., and cannot be loaded or accessed.

### **This file is already loaded**

Meaning: When loading a divided .PCG file, you attempted to load a file that had already been loaded.

Action: Load the .PCG files that have not yet been loaded.

### **Track is full**

Meaning: In the Disk mode Make Audio CD page, you attempted to insert a track that would make the total exceed 99 tracks.

Action: Cut unneeded tracks, and then execute the Insert operation once again.

## **U**

### **Unable to create directory**

Meaning: You attempted to create a directory that would exceed the maximum pathname length (76 characters for the full pathname).

### **Unable to save file**

Meaning: When executing the Disk mode Utility command "Copy," the copy destination path length exceeded 76 characters.

Meaning: When saving a file in Disk mode or Song Play mode, the save destination path exceeded 76 characters.

Meaning: When you executed the Disk mode Utility page menu command "Copy," the file management data exceeded the size of the management area.

## **W**

### **Word Clock Error !**

Meaning: When you set "System Clock" to Word Clock (if the EXB-DI is installed), the word clock was not being input correctly.

Action: Check whether there is a problem with the BNC cable.

## **Y**

### **You can't undo last operation                      Are you sure ?**

Meaning: Once you enter event editing (even if you leave event editing without actually editing an event), it will no longer be possible to execute a Compare of the previous edit. If you wish to enter event editing, press the OK button. To cancel, press the Cancel button.

### **You can't undo this operation**

### **Are you sure ?**

Meaning: When you exit recording or event editing in Sequencer mode, the memory area for Undo (Compare function) is not allocated. If you wish to keep the data that was just recorded or edited, press the OK button. If you wish to return to the previous data (i.e., to delete the data that was just recorded or edited), press the Cancel button.

Meaning: When editing in Sequencer mode, memory area for Undo (Compare function) cannot be allocated. If you wish to execute the edit, press the OK button. (It will not be possible to return to the state before editing.) If you decide not to execute the edit, press the Cancel button.

Action: In order to allocate memory area for Undo (Compare function), delete unneeded data such as songs, tracks, or patterns. We recommend that you save data to floppy disk before you execute the edit operation.

## Data compatibility

In its various data formats, the TRITON STUDIO maintains data compatibility with the TRITON/TRITON pro/TRITON proX and TRITON-Rack. Data can be exchanged by using a floppy disk or other external media to load/save, or by using MIDI exclusive data dump or parameter changes. However, you must be aware of the following points.

**note** In this section, the TRITON, TRITON pro, and TRITON proX are collectively referred to as the TRITON.

### [1] Parameters that are valid on the TRITON STUDIO but invalid on the TRITON-Rack and TRITON

#### 1-1. Arpeggio pattern settings in Program, Combination, and Sequencer modes

- **TRITON STUDIO → TRITON (.PCG file load/MIDI data dump/MIDI parameter change):**  
The TRITON does not have user arpeggio pattern numbers "U232 (E-C)–U506 (User)," and will not sound or operate correctly.
- **TRITON STUDIO → TRITON-Rack (.PCG file load/MIDI data dump/MIDI parameter change):**  
The TRITON-Rack does not have user arpeggio pattern numbers "U328 (User)–U506 (User)," and will not sound or operate correctly.

#### 1-2. Global mode parameters of the TRITON STUDIO

Input (COMBI, PROG, SEQ, S.PLAY, DISK)  
: S/P DIF In  
: mLAN In

- **TRITON STUDIO → TRITON-Rack or TRITON (.PCG file load/MIDI data dump):**  
Data other than this data will be loaded by the TRITON-Rack or TRITON.

System Clock

- **TRITON STUDIO → TRITON (.PCG file load/MIDI data dump):**  
The parameter setting will be saved by the TRITON as internal data, but this data will be ignored. When the TRITON saves a .PCG file or performs a MIDI data dump in this state, the setting that was loaded or received via MIDI data dump will be output.

System Clock "S/P DIF" setting

- **TRITON STUDIO → TRITON-Rack (.PCG file load):**  
The parameter setting will not be loaded by the TRITON-Rack.

Receive Ext. Realtime Command

- **TRITON STUDIO → TRITON-Rack or TRITON (.PCG file load):**  
The setting of this parameter is saved by the TRITON-Rack and TRITON as internal data, but the data itself will be ignored. If this state is saved by the TRITON-Rack or TRITON as a .PCG file, the file will be saved in the state that was loaded.

S/P DIF Sample Rate  
WAVE file Play Level  
Auto Optimize RAM

- **TRITON STUDIO → TRITON-Rack or TRITON (.PCG file load/MIDI data dump):**  
These parameter settings will be saved by the TRITON-Rack or TRITON as internal data, but this data will be ignored. When the TRITON-Rack or TRITON saves a .PCG file or performs a MIDI data dump in this state, the settings that were loaded or received via MIDI data dump will be output.
- **TRITON-Rack or TRITON → TRITON STUDIO (MIDI data dump):**  
These parameters will be set to "48 kHz," "Normal" and "Off" respectively.

Foot Switch Assign "JS+Y (CC#01)-SW2" setting  
Foot Pedal Assign "JS+Y (CC#01)-Knob4" setting

- **TRITON STUDIO → TRITON (.PCG file load/MIDI data dump):**  
These parameter settings will be saved within the TRITON as internal data, but will be ignored. If this state is saved by the TRITON-Rack or TRITON to a .PCG file or transmitted as a MIDI data dump, the settings that were loaded or received via MIDI data dump will be output.

Drumsample "0413-0416" settings

- **TRITON STUDIO → TRITON-Rack and TRITON (.PCG file load/MIDI data dump):**  
Since these multisamples do not exist on the TRITON-Rack or TRITON, they will not sound/operate correctly.

#### 1-3. Combination or Sequencer mode "Program Select" bank EXB-A, B, C, D, E, F, G settings

- **TRITON STUDIO → TRITON (.PCG file load/MIDI data dump):**  
Since these program banks do not exist on the TRITON, they will not sound/operate correctly.

#### 1-4. Program mode OSC1 Drum Kit "064 (E-D)-143 (User)" settings

- **TRITON STUDIO → TRITON (.PCG file load/MIDI data dump/MIDI parameter change):**  
Since these drum kit numbers do not exist on the TRITON, they will not sound/operate correctly.

#### 1-5. RAM sample parameter "+12 dB" setting

- **TRITON STUDIO → TRITON, TRITON-Rack (.KSF file load):**  
Since the TRITON and TRITON-Rack do not have this sample parameter, the "+12 dB" On setting will be ignored. (As of March 2002)

## [2] Parameters that are valid on the TRITON-Rack but invalid on the TRITON STUDIO and TRITON

### 2-1. Program mode Audition Riff and Transpose settings

- **TRITON-Rack → TRITON STUDIO or TRITON (.PCG file load/MIDI data dump/MIDI parameter change):**

The parameter settings will be saved by the TRITON STUDIO or TRITON as internal data, but will be ignored. When the TRITON STUDIO or TRITON saves this state as a .PCG file or performs a MIDI data dump, the settings will be output in the condition in which they were loaded or received via MIDI data dump.

- **TRITON STUDIO or TRITON → TRITON-Rack (.PCG file load/MIDI data dump):**  
These parameters will be set to "Off" and "+00" respectively.

### 2-2. Program, Combination, and Multi mode REAL-TIME CONTROLS [SELECT] C-mode settings

- **TRITON-Rack → TRITON STUDIO or TRITON (.PCG file load/MIDI data dump/MIDI parameter change):**

Parameter C settings will be saved by the TRITON STUDIO or TRITON as internal data, but this data will be ignored, and operation will use A or B. When the TRITON STUDIO or TRITON saves this state as a .PCG file or performs a MIDI data dump, the settings will be output in the condition in which they were loaded or received via MIDI data dump.

### 2-3. Combination and Multi mode "Program Select" bank EXB-A, B, C, D, E, F, G, H settings

- **TRITON-Rack → TRITON (.PCG/.SNG file load/MIDI data dump/MIDI parameter change):**  
Since the TRITON does not have these program banks, it will not sound/operate correctly.
- **TRITON-Rack → TRITON STUDIO (.PCG/.SNG file load/MIDI data dump/MIDI parameter change):**  
Since the TRITON STUDIO does not have program bank H, it will not sound/operate correctly.

### 2-4. Program mode OSC1 Drum Kit "064 (E-D)-143 (E-H)" settings

- **TRITON-Rack → TRITON (.PCG file load/MIDI data dump/MIDI parameter change):**  
Since the TRITON does not have these drum kit numbers, it will not sound/operate correctly.

### 2-5. Program, Combination, and Multi mode arpeggio patterns "U232 (E-C)-U327 (E-H)" settings

- **TRITON-Rack → TRITON (.PCG file load/MIDI data dump/MIDI parameter change):**  
Since the TRITON does not have these user arpeggio pattern numbers, it will not sound/operate correctly.

Note for 1-1, 1-3, 1-4, 2-3, 2-4, 2-5

The following table shows the bank/number structure for the programs, combinations, drum kits, and arpeggio patterns of the TRITON STUDIO, TRITON, and TRITON-Rack. If data for a bank/number that does not exist on a model is loaded into that model, it will not sound/operate correctly. Care must be taken when loading files, dumping MIDI data, or using MIDI parameter changes between the TRITON STUDIO, TRITON, and TRITON-Rack.

TRITON-Rack	TRITON	TRITON Studio
<b>Program</b>	<b>Program</b>	<b>Program</b>
INT-A	A	INT-A
INT-B	B	INT-B
INT-C	C	INT-C
INT-D	D	INT-D
INT-E	E	INT-E
INT-F	F	INT-F
G, g(1)...g(d)	G, g(1)...g(d)	G, g(1)...g(d)
EXT-A	-	EXT-A
EXT-B	-	EXT-B
EXT-C	-	EXT-C
EXT-D	-	EXT-D
EXT-E	-	EXT-E
EXT-F	-	EXT-F
EXT-G	-	EXT-G
EXT-H	-	-
<b>Combination</b>	<b>Combination</b>	<b>Combination</b>
INT-A	A	INT-A
INT-B	B	INT-B
INT-C	C	INT-C
INT-D	D	INT-D
INT-E	-	INT-E
EXT-A	-	EXT-A
EXT-B	-	EXT-B
EXT-C	-	EXT-C
EXT-D	-	EXT-D
EXT-E	-	EXT-E
EXT-F	-	EXT-F
EXT-G	-	EXT-G
EXT-H	-	-
<b>Drum Kit</b>	<b>Drum Kit</b>	<b>Drum Kit</b>
000-015(I-A/B)	00-15(A/B)	000-015(I-A/B)
016-031(E-A)	16-31(C)	016-031(E-A)
032-047(E-B)	32-47(D)	032-047(E-B)
048-063(E-C)	48-63(User)	048-063(E-C)
064-079(E-D)	-	064-079(E-D)
080-095(E-E)	-	080-095(E-E)
096-111(E-F)	-	096-111(E-F)
112-127(E-G)	-	112-127(E-G)
128-143(E-H)	-	128-143(User)
144-152(GM)	64-72(GM)	144-152(GM)
<b>Arpeggio Pattern</b>	<b>Arpeggio Pattern</b>	<b>Arpeggio Pattern</b>
P000-004(Preset)	P000-004(Preset)	P000-004(Preset)
U000-199(I-A/B)	U000-199(A/B)	U000-199(I-A/B)
U200-215(E-A)	U200-215(C)	U200-215(E-A)
U216-231(E-B)	U216-231(D)	U216-231(E-B)
U232-247(E-C)	-	U232-247(E-C)
U248-263(E-D)	-	U248-263(E-D)
U264-279(E-E)	-	U264-279(E-E)
U280-295(E-F)	-	U280-295(E-F)
U296-311(E-G)	-	U296-311(E-G)
U312-327(E-H)	-	U312-506(User)

## [3] Parameters that are valid on the TRITON STUDIO and TRITON but invalid on the TRITON-Rack

### 3-1. Global mode parameters of the TRITON STUDIO and TRITON

Beep  
Foot Switch Assign  
Foot Pedal Assign  
Damper Polarity  
Foot Switch Polarity

- **TRITON STUDIO or TRITON → TRITON-Rack (.PCG file load/MIDI data dump)**  
These parameter settings are saved by the TRITON-Rack as internal data, but are ignored. When the TRITON-Rack saves this state as a .PCG file or performs a MIDI data dump, the settings will be output in the condition in which they were loaded or received via MIDI data dump.
- **TRITON-Rack → TRITON STUDIO or TRITON (.PCG file load/MIDI data dump):**  
These parameters will be set to their default values.

Convert Position

- **TRITON STUDIO or TRITON → TRITON-Rack (.PCG file load/MIDI data dump):**  
The PreMIDI or PostMIDI setting of this parameter is saved by the TRITON-Rack as internal data, but is ignored, and the TRITON-Rack will operate as if the setting were PostMIDI. When the TRITON-Rack saves this state as a .PCG file or performs a MIDI data dump, the setting will be output in the condition in which it was loaded or received via MIDI data dump.
- **TRITON-Rack → TRITON STUDIO or TRITON (.PCG file load/MIDI data dump):**  
This parameter will be set to "PostMIDI."

MIDI Clock

- **TRITON STUDIO or TRITON → TRITON-Rack (.PCG file load/MIDI data dump):**  
The External PCI/F setting of this parameter is saved by the TRITON-Rack as internal data, but is ignored, and the TRITON-Rack will operate as if the setting were External. When the TRITON-Rack saves this state as a .PCG file or performs a MIDI data dump, the setting will be output in the condition in which it was loaded or received via MIDI data dump.

### 3-2. TRITON Combination and Sequencer mode MIDI Filter "Enable Foot Pedal/Switch" parameter

- **TRITON STUDIO or TRITON → TRITON-Rack (.PCG/.SNG file load/MIDI data dump):**  
The parameter setting is saved by the TRITON-Rack as internal data, but is ignored. When the TRITON-Rack saves this state as a .PCG/.SNG file or performs a MIDI data dump, the setting will be output in the condition in which it was loaded or received via MIDI data dump.
- **TRITON-Rack → TRITON STUDIO or TRITON (.PCG/.SNG file load/MIDI data dump):**  
This parameter will be set to "On."

### 3-3. TRITON STUDIO or TRITON Sequencer mode parameters and data

Sequencer mode data of the TRITON STUDIO and TRITON is compatible with the Multi mode data of the TRITON-Rack via .PCG file load or MIDI data dump. However, you must use caution regarding the following parameters and data.

Meter  
Tempo Mode  
Track1-16 PLAY/MUTE  
Track Play Loop  
Track Play Loop Start Measure  
Track Play Loop End Measure  
Play Intro

- **TRITON STUDIO or TRITON → TRITON-Rack (.SNG file load/MIDI data dump):**  
These parameter settings are maintained by the TRITON-Rack as internal data, but are ignored. When the TRITON-Rack saves this state as a .PCG/.SNG file or performs a MIDI data dump, the settings will be output in the condition in which they were loaded or received via MIDI data dump.
- **TRITON-Rack → TRITON STUDIO or TRITON (.SNG file load/MIDI data dump):**  
These parameters will be set to their default values.

Cue List data (Cue list setting data)

- **TRITON STUDIO or TRITON → TRITON-Rack (.SNG file load):**  
This data will not be loaded.
- **TRITON STUDIO or TRITON → TRITON-Rack: (MIDI data dump):**  
On the TRITON-Rack, this is saved as internal data of Multi mode, but is ignored. When the TRITON-Rack performs a MIDI data dump in this state, the settings will be output in the condition in which they were received via MIDI data dump.

Track data (Events of all song tracks)

- **TRITON STUDIO or TRITON → TRITON-Rack (.SNG file load):**  
This data will be loaded if you check Load track events? (☞ "Load selected 15, 16"). On the TRITON-Rack, this will be saved as internal data of Multi mode, but is not used in Multi mode. This data will be output when the TRITON-Rack saves a .SNG file.
- **TRITON STUDIO or TRITON → TRITON-Rack (MIDI data dump):**  
On the TRITON-Rack, this will be saved as internal data of Multi mode, but is not used in Multi mode. This data will be output when the TRITON-Rack transmits a MIDI data dump.

#### [4] Parameters that are valid on the TRITON but invalid on the TRITON STUDIO or TRITON-Rack

##### 4-1. Global mode parameters of the TRITON

PC I/F Baud Rate

- **TRITON → TRITON STUDIO or TRITON-Rack (PCG file load):**

The parameter setting is maintained as internal data by the TRITON STUDIO and TRITON-Rack, but is ignored. When this state is saved by the TRITON STUDIO or TRITON-Rack as a .PCG file or transmitted as a MIDI data dump, the settings that were loaded or received via MIDI data dump will be output.

- **TRITON STUDIO or TRITON-Rack → TRITON (PCG file load):**

This parameter will be set to its default value.

#### [5] Reception of MIDI data dumps between the TRITON STUDIO, TRITON, and TRITON-Rack

Limitations on reception of MIDI data dumps between the TRITON STUDIO, TRITON, and TRITON-Rack are described by the table below.

#### [6] Data compatibility with other devices

Due to differences in format, .PCG and .SNG files of the KARMA Music Workstation and TRITON Le series cannot be loaded. However, full compatibility has been maintained for .KSC, .KMP, .KSF, .MID, .EXL, .AIF, and .WAV files. These files can be loaded/saved via external media.

⚠ However, only the “+12 dB” (Sampling P2: 2-1c) setting of the .KSF file will be ignored. (As of March 2002)

Transmitting device		Receiving device		
		TRITON	TRITON STUDIO	TRITON-Rack
Dump Program	TRITON	●	●	×
[All Bank]	TRITON Studio	×	●	×
Dump Program	TRITON	●	●	●
[1Bank]	TRITON Studio	▲(X for EXT-A-EXT-G)	●	●
	TRITON-Rack	▲(X for EXT-A-EXT-H)	▲(X for EXT-H)	●
Dump Program	TRITON	●	●	●
[1Program]	TRITON Studio	▲(X for EXT-A-EXT-G)	●	●
	TRITON-Rack	▲(X for EXT-A-EXT-H)	▲(X for EXT-H)	●
Dump Combination	TRITON	●	●	×
[All Bank]	TRITON Studio	×	●	×
Dump Combination	TRITON	●	●	×
[1Bank]	TRITON Studio	▲(X for EXT-A-EXT-G)	●	●
	TRITON-Rack	▲(X for EXT-A-EXT-H)	▲(X for EXT-H)	●
Dump Combination	TRITON	●	●	●
[1Combination]	TRITON Studio	▲(X for EXT-A-EXT-G)	●	●
	TRITON-Rack	▲(X for EXT-A-EXT-H)	▲(X for EXT-H)	●
Dump Drum Kit	TRITON	●	●	●
[All Kit]	TRITON Studio	×	●	●
	TRITON-Rack	×	●	●
Dump Drum Kit	TRITON	●	●	●
[1Kit]	TRITON Studio	▲(X for Kit64-143)	●	●
	TRITON-Rack	▲(X for Kit64-143)	●	●
Dump Arpeggio Pattern	TRITON	●	●	●
[All Pattern]	TRITON Studio	×	●	×
	TRITON-Rack	×	●	×
Dump Arpeggio Pattern	TRITON	●	●	●
[1Pattern]	TRITON Studio	▲(X for Pat232-506)	●	▲(X for Pat328-506)
	TRITON-Rack	▲(X for Pat232-327)	●	●
Dump Global Setting	TRITON	●	●	●
	TRITON Studio	×	●	×
	TRITON-Rack	●	●	●
Dump Sequencer	TRITON	●	●	●
	TRITON Studio	●	●	●
	TRITON-Rack	●	●	●
Dump All	TRITON	●	●	×
	TRITON Studio	×	●	×

---

## Disk mode information

### Chunks that are supported

#### *When loading*

##### **AIFF files**

When data is loaded into the TRITON STUDIO, the following four chunks are referenced: Common chunk, Sound Data chunk, Marker chunk, and Instrument chunk. Other chunks are ignored.

Restrictions on the parameters in each chunk are described below.

##### **Common chunk**

Only one (mono) or two (stereo) channels are supported. Sample sizes of 1–16 bits are supported. If the sample data is 8 bits or less, it will be loaded as 16 bit data with the lower 8 bits always at 0.

##### **Sound Data chunk**

Offset and block size are ignored. (Block-Aligning Sound Data is not supported.)

##### **Marker chunk**

Up to eight markers are supported. The ninth and subsequent markers will be ignored.

##### **Instrument chunk**

If the loop play mode is ForwardBackwardLooping, this will be handled as ForwardLooping.

baseNote, detune, lowNote, highNote, lowVelocity, highVelocity, gain, and releaseLoop will be ignored.

##### **WAVE files**

When loading, the TRITON STUDIO references the Format Chunk, Sample Chunk, and Wave Data. Limitations are discussed below.

##### **Format chunk**

Standard PCM format is the only format category that is supported.

Only one (mono) or two (stereo) channels are supported. Sample sizes of 1–16 bits are supported. If the sample data is 8 bits or less, it will be loaded as 16 bit data with the lower 8 bits always at 0.

##### **Sample Chunk**

Only the loop data is referenced. If there is multiple loop data, the loop with the greatest number of loop playback times (Play Count) will be used. Even if the Type is Alternating or Backward, it will be handled as Forward Loop.

##### **Wave data**

The Wave List chunk is not supported.

#### *When exporting*

##### **AIFF files**

When exporting, the TRITON STUDIO will use the Common Chunk, Sound Data Chunk, Marker Chunk, and Instrument Chunk.

Limitations on the parameters within each chunk are discussed below.

##### **Common Chunk**

The number of channels is fixed at 1 (mono). The sample size is fixed at 16 bits.

##### **Marker Chunk**

Two markers are used as Loop Start Address and End Address respectively.

##### **Instrument Chunk**

The loop play mode is fixed at Forward Looping. Zone data of the multisamples will not be exported.

##### **WAVE files**

When exporting, the TRITON STUDIO will use the Format Chunk, Sample Chunk, and Wave Data. Restrictions are given below.

##### **Format Chunk**

The format category is fixed at standard PCM format. The number of channels is 1 (mono) or 2 (stereo), and is fixed at 1 (mono) for export. The sample size is fixed at 16 bits.

##### **Sample Chunk**

The Type is fixed at Forward Loop. Zone data of the multisamples will not be exported.

## About KORG format files

### KORG format file structure

There are three types of files: .KMP files for multisamples, .KSF files for samples, and .KSC files which handle the first two as a collection. Similar to the AIFF format, .KMP/.KSF files consist of chunks.

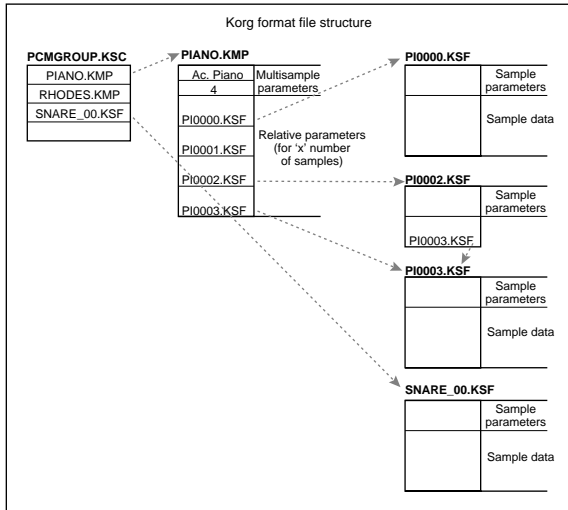

Unless stated otherwise, all data is Big Endian.

- When a Korg format file saved on the TRITON STUDIO is loaded by the TRINITY,
  - Of the parameters for each song, the following parameters are ignored (the chunk that includes the parameter is given in parentheses)
 

Filter cutoff	(RLP1 chunk)
Transpose	(RLP2 chunk)
Resonance	(RLP2 chunk)
Attack	(RLP2 chunk)
Decay	(RLP2 chunk)
  - Of the parameters for each sample, reverse playback and loop off settings (included in the attribute parameters of the SMD1 chunk) will be ignored, and will be handled respectively as forward playback and loop on. Only the twelve types of sampling frequency supported by the Trinity will be loaded correctly, and if the frequency is unsupported, the next lowest frequency will be selected.
  - Split sample files cannot be loaded.
- When a Korg format file saved on the TRINITY is loaded into the TRITON STUDIO,
  - Compressed sample files cannot be loaded.
  - Multisamples that use internal samples of the Trinity will be assigned identically-numbered RAM samples.

### KMP (KORG Multisample Parameter) files

These consist of the following chunks.

- Multisample parameter chunk
 

Chunk ID ('MSP1')	[4 bytes]
Chunk size (fixed at 18)	[4 bytes]
Multisample name	[16 bytes]
Number of samples in the multisample	[1 byte]
Attributes	[1 byte]

### Attributes

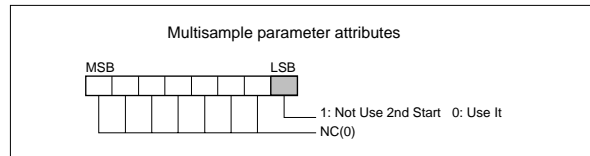

- Relative parameter chunk 1
 

Chunk ID ('RLP1')	[4 bytes]
Chunk size (18 × number of samples in the multisample)	[4 bytes]
Original key	[1 byte]
MSB 1: Non Transpose 0: Transpose	
bits 6-0 original key	
Top key (0-127)	[1 byte]
Tune (-99...+99 cents)	[1 byte]
Level (-99...+99 cents)	[1 byte]
Pan (0-127 currently unused)	[1 byte]
Filter cutoff (-99...+99 currently unused)	[1 byte]
KSF filename (including period and extension)	[12 bytes] × number of samples in the multisample

If the .KSF filename is "SKIPPEDSAMPL", it will be treated as a sample skipped during loading.  
If the .KSF filename is "INTERNALnnnn", internal samples will be used.

- Relative parameter chunk 2
 

Chunk ID ('RLP2')	[4 bytes]
Chunk size (4)	[4 bytes]
Transposing (-64...+63)	[1 byte]
Resonance (-99...+99)	[1 byte]
Attack (-99...+99)	[1 byte]
Decay (-99...+99)	[1 byte]
- Multisample number chunk
 

Chunk ID ('MNO1')	[4 bytes]
Chunk size (4)	[4 bytes]
Multisample number (0-)	[4 bytes]

### KSF (KORG Sample File) files

There are four types of structure for these files. One consists of a Sample Parameter chunk, Sample Data chunk, and Sample Number chunk (SMP1 + SMD1 + SNO1). Another consists of a Sample Parameter chunk, Sample Data chunk, Sample Filename chunk, and Sample Number chunk (SMP1 + SMD1 + SMF1 + SNO1). The latter structure is in the case where the sample data of the Sample chunk is empty, and uses the sample data of the .KSF file specified by the Sample Filename chunk (shared sample data).

When saving to a floppy disk and a single disk cannot accommodate all of the data, it is possible to automatically divide the file and continue the save operation.

When a .KSF file is created in this way, the first file will consist of the Sample Parameter chunk, Sample Number chunk, a divided Sample Parameter chunk, and a divided Sample Data chunk (SMP1 + SNO1 + SPD1 + SDD1), and the second and subsequent files will consist of a divided Sample Data chunk (SDD1).

- **Sample parameter chunk**

Chunk ID ('SMP1')	[4 bytes]
Chunk size (32)	[4 bytes]
Sample name	[16 bytes]
Default bank (0-3)	[1 bytes]
Start address	[3 bytes]
2nd start address	[4 bytes]
Loop start address	[4 bytes]
Loop end address	[4 bytes]

- **Sample data chunk**

Chunk ID ('SMD1')	[4 bytes]
Chunk size (12 + number of sample databytes)	[4 bytes]
Sampling frequency	[4 bytes]
The sampling frequencies supported by the TRITON STUDIO are 48000/47619/44100/32000/31746/31250/29400/24000/23810/22254/22050/21333/21164/20833/19600/16000/15873/15625/14836/14700/14222/14109/13889/13067/12000/11905/11127/11025/10667/10582/10417/9891/9800/9481/9406/9259/8711/8000/7937/7813/7418/7350/7111/7055/6945/6534/6000/5953/5564/5513/5333/5291/5208/4945/4900/4741/4703/4630/4356/4000/3968/3906/3709/3675/3556/3527/3472/3267/3000/2976/2782/2756/2667/2646/2604/2473/2450/2370/2352/2315/2178/2000/1984/1855/1838(Hz).	
Attributes	[1 byte]
Loop tune (-99...+99 cents)	[1 byte]
Number of channels (1)	[1 byte]
Sample size (8/16)	[1 byte]
Number of samples	[4 bytes]
Sample data	variable length

- **Attributes**

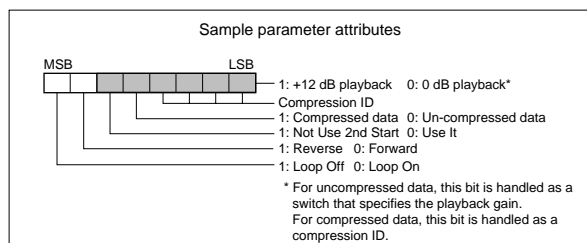

- **Sample number chunk**

Chunk ID ('SNO1')	[4 bytes]
Chunk size (4)	[4 bytes]
Sample number (0-)	[4 bytes]

- **Sample filename chunk**

Chunk ID ('SMF1')	[4 bytes]
Chunk size (12)	[4 bytes]
KSF filename	[12 bytes]

If the .KSF filename is "SKIPPEDSAMPL", it will be treated as a sample skipped during loading.  
 If the .KSF filename is "INTERNALnnnn", internal samples will be used.

- **Divided sample parameter chunk**

Chunk ID ('SPD1')	[4 bytes]
Chunk size (12)	[4 bytes]
The following up to the sample size is the same as in the SMD1 chunk	
Sampling frequency	[4 bytes]
Attributes	[1 byte]
Loop tune	[1 byte]
Number of channels	[1 byte]
Sample size	[1 byte]
Number of samples	[4 bytes]
Total number of samples in all divided files	

- **Divided sample data chunk**

Chunk ID ('SDD1')	[4 bytes]
-------------------	-----------

### KSC(Korg Script) file

These files are text files which contain a list of filenames for .KMP/.KSF files which are to be handled together. Lines beginning with # are ignored as comment lines. The first line of the file must begin with "#KORG Script Version 1.0" and subsequent lines (except for comment lines) consist only of filename. Only files with an extension of KMP/KSF are processed.

### Filename conventions

.KMP filename for "Save All" or "Save All Multisamples"

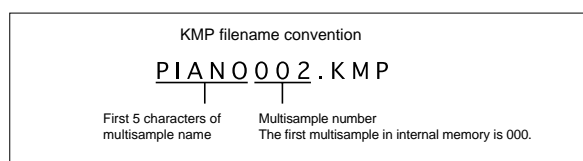

When data is saved using "Save All," "Save All Multisample" or "Save One Multisample," the individual .KSF files used by the Multisample (the .KMP file) are automatically given filenames according to the following convention.

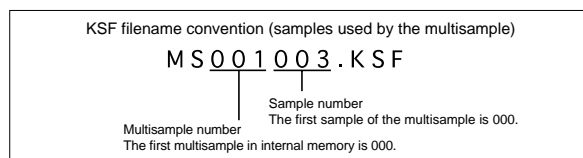

Likewise, when data is saved using "Save All" or "Save All Samples," the individual .KSF files are automatically given filenames according to the following convention.

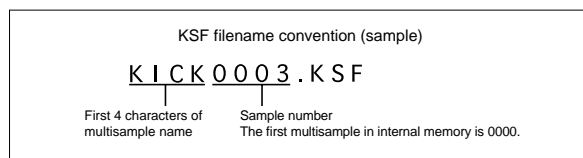



## Option boards/Memory/Calendar battery

Please read this before you begin installation

### Safety precautions

#### Warnings

- Before installing an option, be sure to disconnect the power supply cable and the connecting cables to any peripheral devices. Failure to do so could cause electrical shock or may damage the device.
- When installing, repairing, or replacing an option, you must perform only those actions that the owner's manual directs, and no other.
- Do not apply excessive force to the electronic components or connectors on the circuit board(s) of an option, or attempt to disassemble them. This could cause electric shock, fire, or malfunction.

#### Cautions

- Before touching the option, touch a metal component of the device into which it will be installed, to discharge any static electricity that may be present in your body. Static electricity may damage the electronic components.
- Be careful of any sharp edges or pointed metal parts on the option or the device into which the option is being installed. Sharp edges or points may cause injury.
- Danger of explosion if battery is incorrectly replaced. Replace only the same or equivalent type.
- When handling an option, never touch parts that are not related to the installation. Doing so may cause electrocution or malfunctions.
- When handling an option, be careful not to touch the leads on the back side of the circuit board (the side opposite that on which the components are mounted). The sharp points may cause injury.
- Do not allow the option or other device being installed to become wet, and do not allow objects to be placed on top of it. Doing so could cause malfunction.
- When installing an option, be careful that screws or other parts do not fall into the device into which it is being installed. Doing so could cause malfunction.

Korg Inc. takes no responsibility for any malfunctions or damage that may occur from improper use or modification of this product. Nor will Korg Inc. be responsible for any damages resulting from the loss or destruction of data.

### Please note when installing an option board/memory

- So that static electricity in your body does not damage the electronic components, touch the ground wire of a grounded device or an unpainted metallic component to discharge any static electricity in your body before installing an option board or memory. Internal components of the TRITON STUDIO and of the option/memory boards may be damaged by static electricity.
- Follow the installation procedure, and be sure that each part is installed correctly and in the correct orientation.
- Please use care in handling option boards/memory. Dropping them or applying pressure to them may damage the components.
- Avoid touching exposed metal edges of the circuit board, or portions that need not be handled during installation.
- Be careful not to lose the screws (and washers) that you remove.
- Do not use screws other than those that are installed in the option board/memory and the TRITON STUDIO. Using screws of a different shape or length may damage the unit or cause it to malfunction.
- Be sure to firmly tighten the screws used for attachment.
- Be sure that the option board/memory is inserted correctly into the connector or slot. After installation, be sure to check that the board is installed correctly. If the board is not inserted all the way, faulty contact or power supply shorts can occur, making the unit malfunction.
- Be careful not to drop parts or the option board/memory into the inside of the instrument. If you are unable to retrieve a screw or part that was dropped inside the instrument, please contact your local Korg distributor.

### Cautions when installing the calendar battery

- So that static electricity in your body does not damage the electronic components, touch the ground wire of a grounded device or an unpainted metallic component to discharge any static electricity in your body before installing an option board or memory. Internal components of the TRITON STUDIO and of the option/memory boards may be damaged by static electricity.
- Follow the installation instructions, being careful not to reverse the polarity of the battery.
- Avoid touching exposed metal edges of the circuit board, or portions that need not be handled during installation.
- All screws (and washers) that are removed will be used, so be careful not to misplace them.
- Do not use screws other than those that are installed in the TRITON STUDIO. Using screws of a different shape or length may damage the unit or cause it to malfunction.
- Be sure to firmly tighten the screws used for attachment.
- When installing the battery, do not use excessive force. Pressing the battery too hard or using excessive force may cause malfunctions or damage.
- Make sure that the battery is completely inserted into the battery holder. After installation, check to make sure that the battery is firmly in place.

- When installing the battery, be careful not to drop it inside the device.  
If you drop the battery inside the device and are unable to retrieve it, please contact your Korg distributor.

## About option boards/memory/calendar battery

By installing option boards or memory into your TRITON STUDIO, you can expand its functionality. The following six types of expansion are possible.

### ● EXB-MOSS (DSP synthesizer board)

This adds to the TRITON STUDIO a MOSS tone generator that provides thirteen oscillator algorithms, including Standard, Ring Modulation, VPM, Resonance, Organ Model, and Electric Piano Model. This lets you use the MOSS tone generator in program, combination, multi modes. The MOSS tone generator has six-note polyphony.

### ● EXB-DI (digital interface board)

The six channels of the TRITON STUDIO's AUDIO OUTPUT jacks (MAIN) L/MONO, R, (INDIVIDUAL) 1-4 (analog audio outputs) will be output as 24 bit 48 kHz digital signals on channels 1-6 of the ADAT optical format. By using the WORD CLOCK IN jack, digital audio signals can be synchronized between the TRITON STUDIO and a connected device.

### ● EXB-mLAN (mLAN Interface Board)

This is an option board for connecting the TRITON STUDIO to an mLAN system. Installing an EXB-mLAN allows the TRITON STUDIO to be connected easily via an IEEE 1394 cable to other mLAN-compatible electronic musical instruments and computers, enabling high-capacity transmission and reception of MIDI and audio data. (An EXB-mLAN installed in the TRITON STUDIO provides 2-in/6-out channels of digital audio at a sampling frequency of 48 kHz.) This is a great convenience when using recording software on your computer. Included software allows the connection status of connected devices to be flexibly programmed from your computer, and OMS/ASIO drivers for Macintosh are also included.

### ● CDRW-1 (CD-R/RW drive)

A song you create on the TRITON STUDIO can be sampled to the internal hard disk, and that data can be used to create an audio CD. You can also play back an audio CD inserted in the CDRW-1, or use the Ripping function to read it into the TRITON STUDIO. This drive can also be used to save/load data such as PCG files (packet writing is supported <sup>Ⓔ</sup>p.299).

### ● EXB-PCM series (PCM expansion boards)

Each of these boards adds 16 Mbytes of multisamples and drum samples to the TRITON STUDIO. (The details will differ according to the series.)

EXB-PCM01:	Piano/Classic Keyboards
EXB-PCM02:	Studio Essentials
EXB-PCM03:	Future Loop Construction
EXB-PCM04:	Dance Extreme
EXB-PCM05:	Vintage Archives
EXB-PCM06/07:	Orchestral Collection
EXB-PCM08:	Concert Grand Piano (Expected to go on sale in March 2002)

The multisamples of the EXB-PCM08 are built into the TRITON STUDIO.

\* As of March 2002

### ■ DRAM SIMM (sample data memory modules)

These can be used as sample data memory. Up to two 72-pin DRAM SIMM (either 16 Mbytes or 32 Mbytes) modules can be installed, providing a maximum of 64 Mbytes. (<sup>Ⓔ</sup>“Caution when purchasing DRAM SIMM modules”)

**note** DRAM SIMM boards are not a manufacturer option. Please purchase commercially-available boards that are sold for use in computers.

**note** In order to achieve the maximum 96 Mbytes capacity, you will need to remove the 16 Mbytes DRAM SIMM that is standard, and install three 32 Mbytes DRAM SIMM boards.

**note** The memory banks and sampling time will depend on the capacity of the DRAM SIMM boards you install, and on the slot locations. (<sup>Ⓔ</sup>p.90)

#### Caution when purchasing DRAM SIMM modules

 Some commercially available DRAM SIMM modules cannot be used on the TRITON STUDIO. Before you purchase memory modules, please check the following points.

#### Types of DRAM SIMM modules that can be used on the TRITON STUDIO

- 72-pin 16 Mbytes or 32 Mbytes
- Access time of 60 ns or less
- Address input 11 bit (A0-A10)
- Power supply voltage 5 V

DRAM SIMM modules that meet the above requirements can be used.

If you have any questions regarding the type of DRAM SIMM modules that can be used, please contact your local Korg distributor.

### ■ Calendar battery

This battery maintains the date and time that are recorded when data is saved. Use a CR2032 type battery.

#### CR2032 batteries that can be used in the TRITON STUDIO

- CR2032 batteries manufactured by Sony or Panasonic.

## Checking after installation

 When the TRITON STUDIO is turned on, the currently installed option boards/memory will be shown in the LCD screen.

After installing an option board/memory, be sure to turn on the power and make sure that the option board/memory that you installed is displayed in the LCD screen.

If it is not displayed, the installation may not have been performed correctly. Check once again that the board is installed correctly.

If the calendar battery is not installed correctly, or if the battery voltage has run low, the LCD screen will show a message of “Battery voltage for calendar IC is low” when the power is turned on. Please make sure that you are using a battery that has not run down, and that the battery is installed correctly.

If you have any questions regarding installation, please contact your local Korg distributor.



#### OPTIONS

- EXB-MOSS:** The EXB-MOSS option is installed.  
**EXB-DI:** The EXB-DI option is installed.  
**EXB-mLAN:** The EXB-mLAN option is installed.  
**CDRW-1:** The CDRW-1 option is installed.

#### SIMM

**Slot 1...3 (\*\* MB):** SIMM's are installed in SIMM slots 1-3. The capacity of each SIMM is shown in parentheses. When shipped from the factory, a 16 MB SIMM is already installed in SIMM slot 1.

#### EXB-PCM

**Slot 1...7 (\*\*\*\*):** PCM expansion boards are installed in EXB-PCM series slots 1-7. The type of each board is shown in parentheses.

If the calendar battery is not installed correctly, or if the battery voltage is too low



## Installing an EXB-PCM

Before you perform the installation, be sure to read the foregoing section "Safety precautions" and "Please note when installing an option board/memory."

- ⚡ A maximum of seven EXB-PCM boards can be installed simultaneously.  
If you are installing a single EXB-PCM, it will function correctly when installed in any slot. For easiest installation, you should use the furthest slot (EXB-PCM Slot 1) first.
- ⚡ While performing the installation, be careful that you do not cut your hands on any sharp or pointed edges of the TRITON STUDIO or the option board.
- ⚡ You must leave the AC power cable disconnected until you have completed all steps of installing the option board.

- ① Use a coin or similar object to turn the screw counter-clockwise until the EXB-PCM/sampling memory (RAM) slot cover (located at the upper left of the front panel) is released. (Turn the screw counter-clockwise to loosen it, or clockwise to tighten it.)

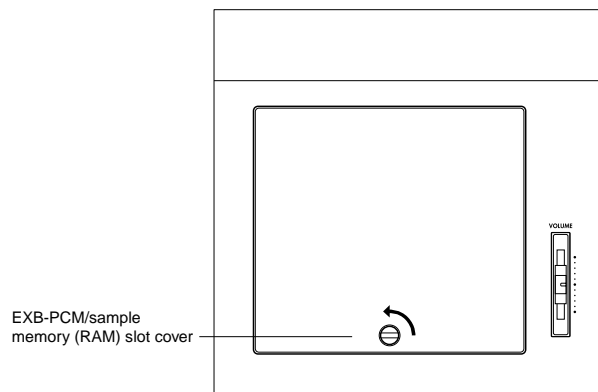

- ② Raise the EXB-PCM/sample memory (RAM) slot cover to the angle shown in the diagram, and remove it.

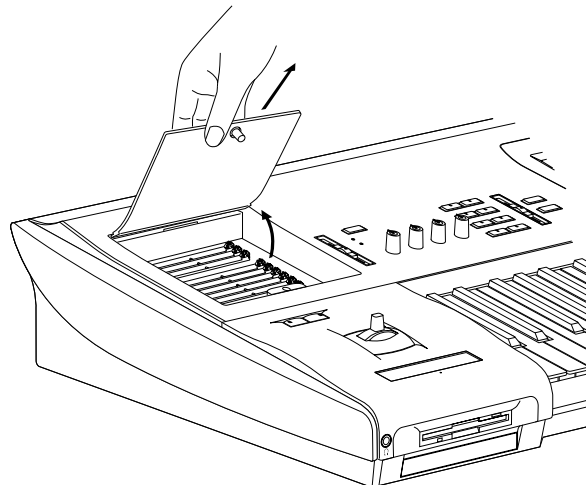

- ⚡ When you open the EXB-PCM/sample memory (RAM) slot cover, do not raise it too far toward the rear.
- ③ Remove the EXB-PCM from its packing pouch.

- ④ Verify the location of the slot into which you want to install the EXB-PCM.
- The seven slots closest to yourself are for EXB-PCM modules. (The three slots furthest from yourself are for DRAM SIMM modules.)

The notched side of the EXB-PCM is 1 PIN. Install the EXB-PCM with its 1 PIN side aligned with the 1 PIN mark ( - ) of the slot.

- ⚠ The EXB-PCM slots and the DRAM SIMM slots are shaped identically. Be careful not to install a memory module in the wrong slot.

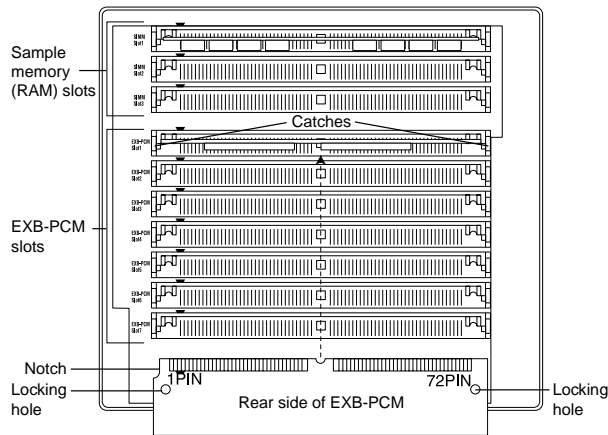

- ⑤ At a slant, press the EXB-PCM firmly all the way into the slot, and raise it to the vertical position until the catches of the slot click into the locking holes of the EXB-PCM. When doing so, pressing the catches of the slot apart to the left and right will help the board go in smoothly.

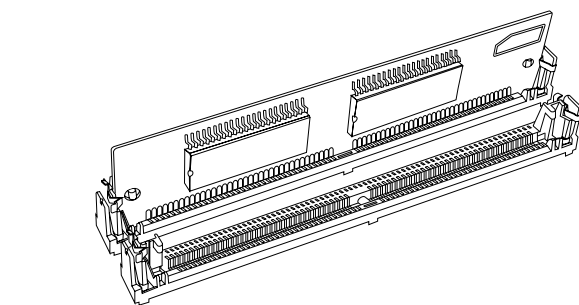
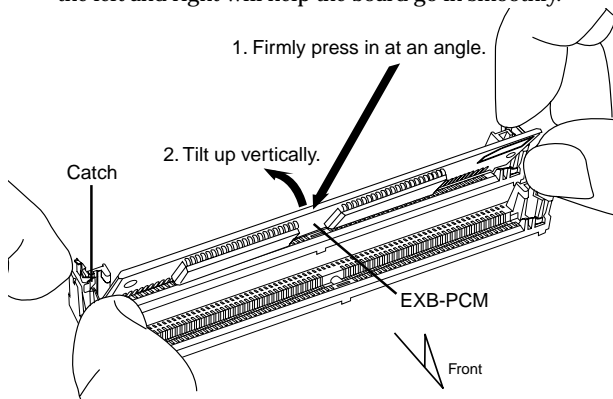

- ⑥ Reversing the procedure by which you opened the EXB-PCM/sample memory (RAM) slot cover, reattach the cover and fasten it with the screw.
- ⑦ When all steps have been completed, turn on the power and make sure that the EXB-PCM has been installed correctly. ("Checking after installation" [p.287](#))
- ⑧ After you have verified that the EXB-PCM module was installed correctly, load the data from the floppy disk included with the EXB-PCM. ([BG p.65](#))

### Removing an EXB-PCM

- Spread the catches of the slot apart to the left and right, and (after removing the stoppers from the catches) tilt the EXB-PCM and pull it out.

If you wish to remove the rear EXB-PCM board, you must first remove the forward EXB-PCM.

- ⚠ When you spread the catches of the slot apart, the EXB-PCM may pop out vigorously and fall into an opening (inside the instrument). Please be careful.

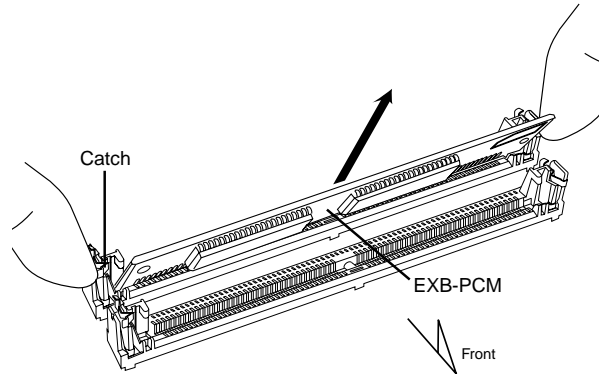

## Installing a DRAM SIMM

Before you perform the installation, be sure to read the foregoing section "Safety precautions" and "Please note when installing an option board/memory."

⚡ A maximum of three memory SIMMs can be installed. A DRAM SIMM will function correctly when installed in any slot.

For ease of installation, we recommend that you first use the slot that is furthest from yourself.

If you wish to use three 32 Mbytes DRAM SIMMs, you will need to remove the factory-installed 16 Mbytes DRAM SIMM as explained in "Removing a DRAM SIMM."

⚡ You must leave the AC power cable disconnected until you finish the entire process of removing the lid, installing the option board or memory, and reattaching the lid.

① Remove the EXB-PCM/sample memory (RAM) slot cover as described in "Installing an EXB-PCM board" steps ① and ②.

② Have the DRAM SIMM at hand.

③ Verify the location of the slot into which you will install the DRAM SIMM module.

The three slots furthest away from yourself are for DRAM SIMM modules. (The seven slots closest to yourself are for EXB-PCM modules.) When the TRITON STUDIO is shipped from the factory, a 16 Mbytes DRAM SIMM is installed in the furthest slot. If you want to add one or two additional memory modules, install them in the vacant slots. If you want to install three memory modules, remove the factory-installed DRAM SIMM as described in "Removing a DRAM SIMM," and use all three of the slots.

The end with the notch is 1 PIN. Align the 1 PIN mark (◀) of the slot with the 1 PIN marking on the EXB-PCM.

⚡ The DRAM SIMM slots and the EXB-PCM slots are shaped identically. Be careful not to install a board in the wrong slot.

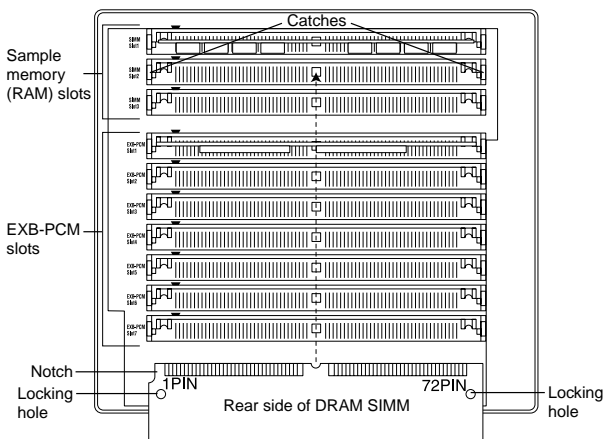

④ At a slant, press the DRAM SIMM firmly all the way into the slot, and raise it to the vertical position until the catches of the slot click into the locking holes of the DRAM SIMM. When doing so, pressing the catches of the slot apart to the left and right will help the board go in smoothly.

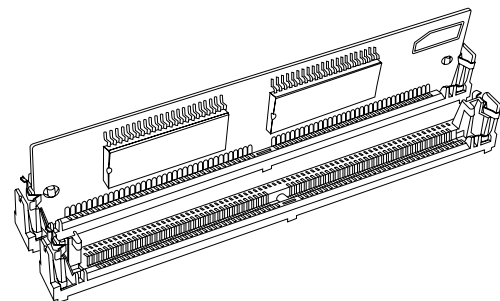
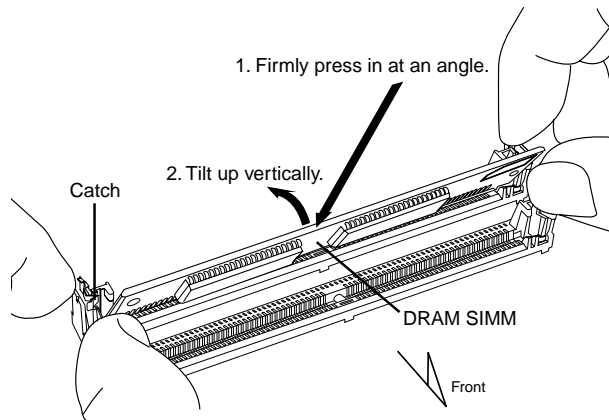

⑤ Reversing the procedure by which you opened the EXB-PCM/sample memory (RAM) slot cover, reattach the cover and fasten it with the screw.

⑥ When all steps have been completed, turn on the power and make sure that the DRAM SIMM has been installed correctly. ("Checking after installation" p.287)

### Removing a DRAM SIMM

- Spread the catches of the slot apart to the left and right, and (after removing the stoppers from the catches) tilt the DRAM SIMM and pull it out.

If you wish to remove the rear DRAM SIMM board, you must first remove the forward DRAM SIMM.

⚡ When you spread the catches of the slot apart, the DRAM SIMM may pop out vigorously and fall into an opening (inside the instrument). Please be careful.

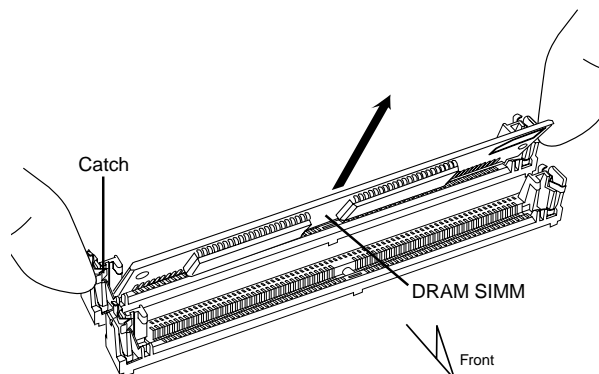

## Installing the EXB-MOSS

Before you perform the installation, be sure to read the foregoing section "Safety precautions" and "Please note when installing an option board/memory."

- ⚠ While performing the installation, be careful of any sharp or pointed edges of the TRITON STUDIO or the option board.
- ⚠ You must leave the AC power cable disconnected until you have completed all steps of installing the option board.

- ① You will need a "+" (plus) screwdriver, and some magazines or other material (to prevent damage to the joystick and knobs etc.: see diagram below).
- ② Turn off this instrument, and disconnect the AC power cable and any other cables by which other devices are connected.
- ③ Make sure that the EXB-PCM/sample memory (RAM) slot cover is closed, and that the screw has been tightened.
- ④ As shown below, place four books or magazines on your work surface to prevent damage to the joystick or knobs, and place the instrument upside down on top of them.

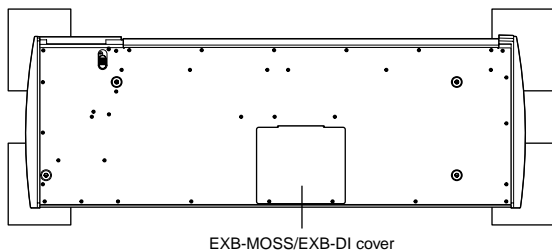
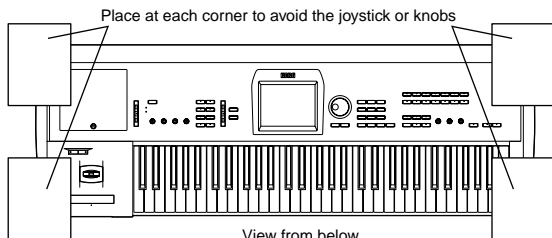

- ⚠ When you turn over the instrument, be careful not to lose your balance and drop the instrument.
- ⑤ Using a screwdriver, remove two screws from the EXB-MOSS/EXB-DI cover, raise the cover, and pull it out of the slit.
- ⚠ When raising the cover, pull it out without forcibly pushing it backward.

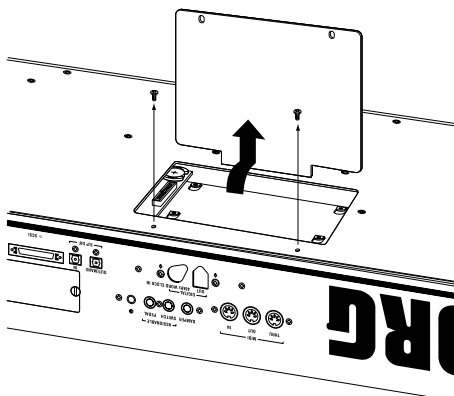

- ⑥ Verify the installation location.

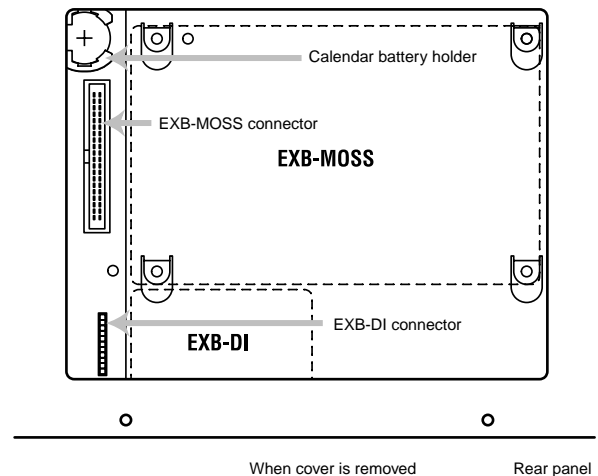

- ⑦ Remove the EXB-MOSS from its packing pouch.
- ⑧ Note that screws and washers are attached to the four corners of the board.

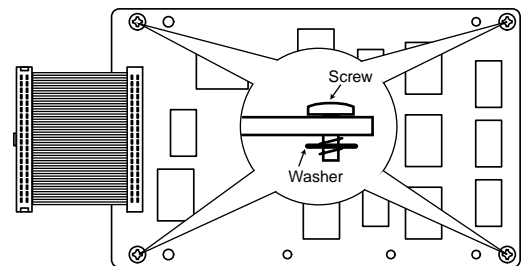

- ⑨ Use the four screws to attach the EXB-MOSS to the corresponding brackets inside the TRITON STUDIO.

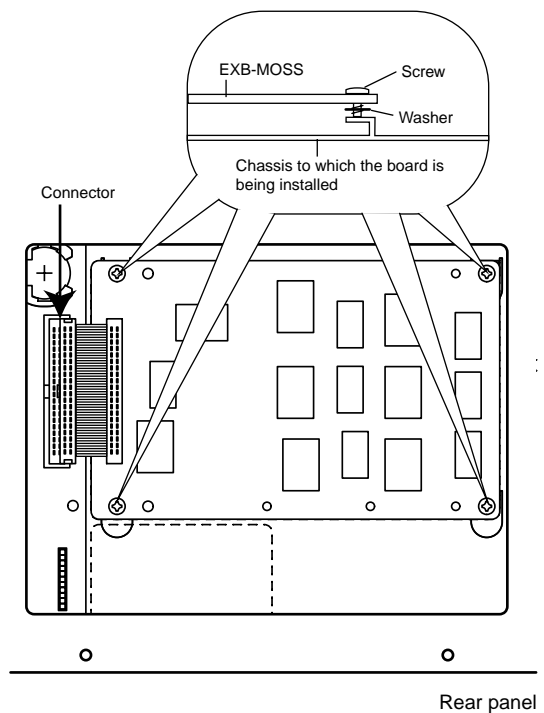

- ⚠ Before the screws are tightened, the EXB-MOSS will float slightly above the brackets. If at this time you apply excessive force to the EXB-MOSS, the screws or washers may come out.

- ⑩ Plug the cable into the connector as shown in the diagram. Press the cable firmly in until it stops.

⚠ Do not touch any part of the circuit board other than the connector in which the cable is being inserted.

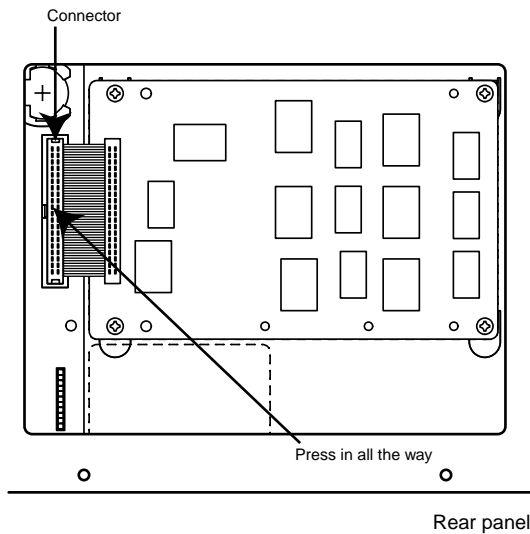

- ⑪ Reversing the procedure by which you removed the EXB-MOSS/EXB-DI cover, reattach the cover.
- ⑫ When all steps have been completed, turn on the power and make sure that the EXB-MOSS has been installed correctly. ("Checking after installation" p.287)
- ⑬ After you have verified that the EXB-MOSS was installed correctly, load the data from the floppy disk included with the EXB-MOSS. (BG p.65)

## Installing the EXB-DI

Before you perform the installation, be sure to read the foregoing section "Safety precautions" and "Please note when installing an option board/memory."

⚠ While performing the installation, be careful of any sharp or pointed edges of the TRITON STUDIO or the option board.

⚠ You must leave the AC power cable disconnected until you have completed all steps of installing the option board.

① Remove the EXB-MOSS/EXB-DI cover as described in steps ①-⑤ of "Installing the EXB-MOSS."

② Verify the location where the EXB-DI will be installed. ("Installing the EXB-MOSS" step ⑥)

③ Remove the EXB-DI from its bag.

④ Remove the two screws and washers from the two corners of the board

⚠ Be careful to save the screws that you remove. Some models that can use the EXB-DI, will require these two screws.

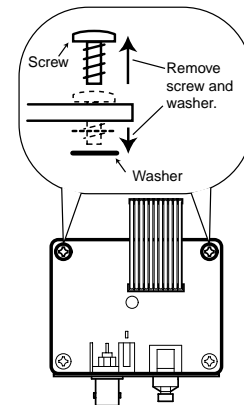

⑤ Remove the two screws holding the (DI) cover that blocks the installation opening of the EXB-DI, and remove the (DI) cover. The two screws you removed will be used to fasten the EXB-DI.

⚠ The (DI) cover you removed will not be used. Take it out so that it is not left inside the TRITON-Rack. The cover you removed should be kept in a safe place, since it will be needed if you later decide to remove the EXB-DI.

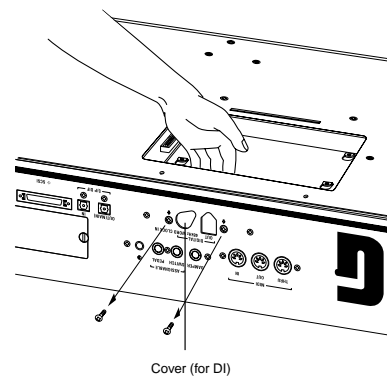

- ⑥ Attach the cable as shown in the diagram. Firmly press the cable all the way into the connector.

**⚠** Do not touch any part of the circuit board other than the connector to which you are connecting the cable.

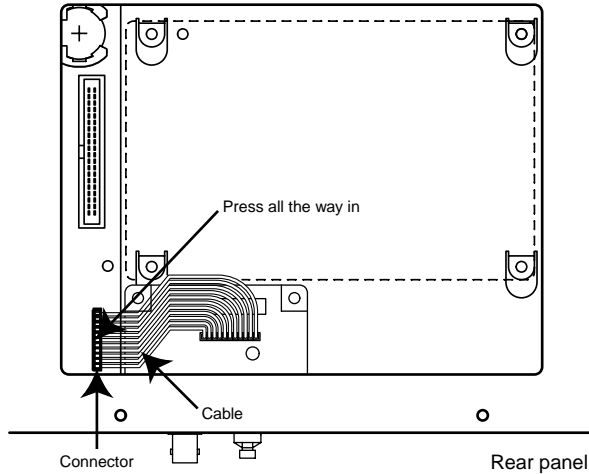

- ⑦ With the connectors of the EXB-DI protruding from the rear panel of the TRITON-Rack, support the EXB-DI with one hand and use the two screws you removed to fasten the EXB-DI from the rear of the TRITON-Rack.

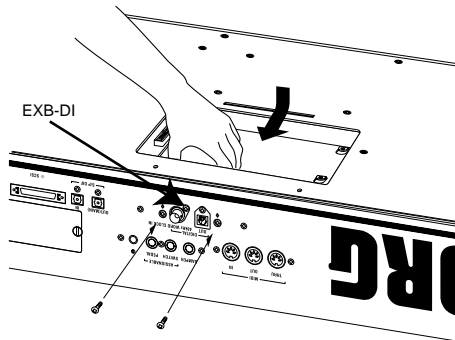

- ⑧ Reversing the procedure described in steps ①–⑤ of “Installing the EXB-MOSS,” reattach the EXB-MOSS/ EXB-DI cover.
- ⑨ After you have completed all the above steps, turn on the power and verify that the EXB-DI has been installed correctly. (“Checking after installation” p.287)

## Installing the EXB-mLAN

Before you perform the installation, be sure to read the foregoing section “Safety precautions” and “Please note when installing an option board/memory.”

**⚠** While performing the installation, be careful of any sharp or pointed edges of the TRITON STUDIO or the option board.

**⚠** You must leave the AC power cable disconnected until you have completed all steps of installing the option board.

- ① Remove two screws from the mLAN cover plate that covers the EXB-mLAN installation slot on the rear panel, and remove the mLAN cover plate.

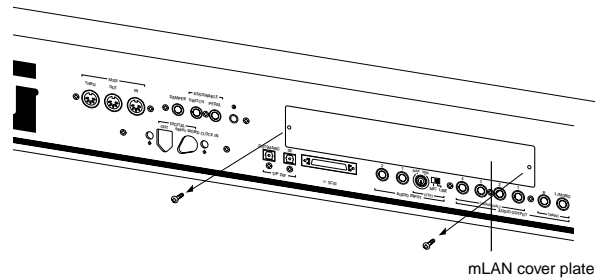

**⚠** The two screws you removed will be used to fasten the EXB-mLAN in place. The cover you removed should be kept in a safe place, since it will be needed if you later decide to remove the EXB-mLAN.

- ② From the TRITON STUDIO, pull out the cable that will be connected to the EXB-mLAN.

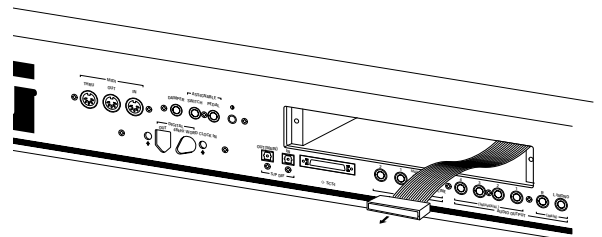

- ③ Remove the EXB-mLAN from its bag.
- ④ Disconnect the cable from the EXB-mLAN connector.

**⚠** The cable you disconnected should be kept in a safe place. This cable may be required for connection if the EXB-mLAN is installed in another device that can use it.

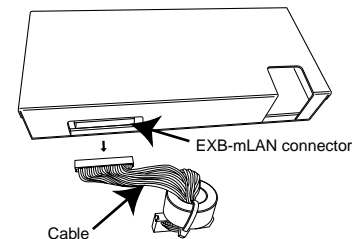



- ⑤ Using the three mLAN installation screws (included with the TRITON STUDIO), attach the mLAN installation plate (also included with the TRITON STUDIO) to the EXB-mLAN.

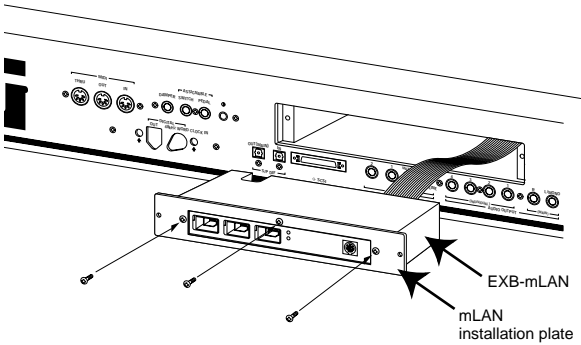

- ⑥ Connect the cable you pulled out in step ② to the EXB-mLAN connector. Firmly press the cable all the way into the connector.

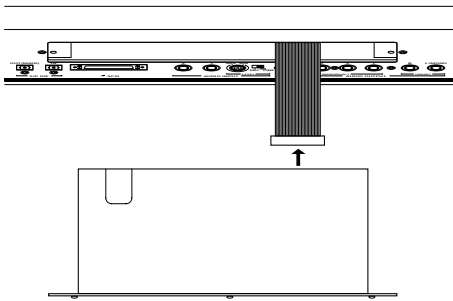

- ⑦ Using the two screws you removed in step ①, attach the EXB-mLAN to the TRITON STUDIO.

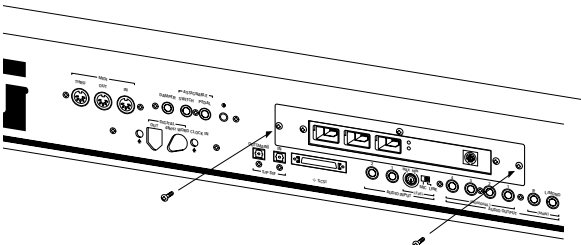

- ⑧ When all steps have been completed, turn on the power and verify that the EXB-mLAN has been installed correctly. ("Checking after installation" p.287)

- ⚠ If you have installed the EXB-mLAN into the TRITON STUDIO for the first time, you must perform the Initial-ize operation. (p.141)

**note** For details on connections between the EXB-mLAN and external devices, refer to the "EXB-mLAN owner's manual."

## Installing the CDRW-1

Before you perform the installation, be sure to read the foregoing section "Safety precautions" and "Please note when installing an option board/memory."

- ⚠ Never attempt to install an internal CD-R/RW drive other than the CDRW-1.
- ⚠ While performing the installation, be careful not to cut your hands on any sharp or pointed metal edges of the TRITON STUDIO or the CDRW-1.
- ⚠ You must leave the AC power cable disconnected until you have completed all steps of the installation.

- ① Push off the CDRW-1 cover. Slide the [EJECT] switch (located on the bottom of the TRITON STUDIO) in the direction of the arrow, and the drive bay cover on the side of the TRITON STUDIO will be pushed out.

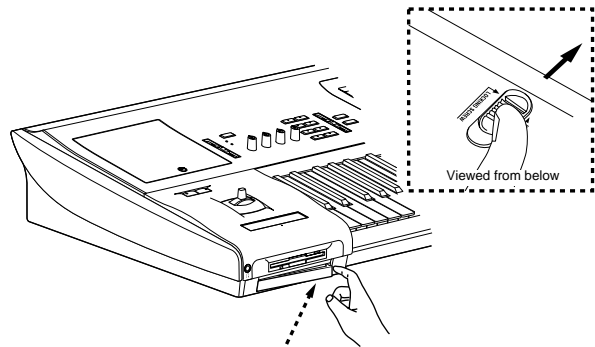

- ② Remove the CDRW-1 cover. Hook your fingertip on the edge of the cover that was pushed out, and remove it in the direction of the arrow shown in the diagram.

- ⚠ Forcefully pulling the cover toward yourself may damage the cover.

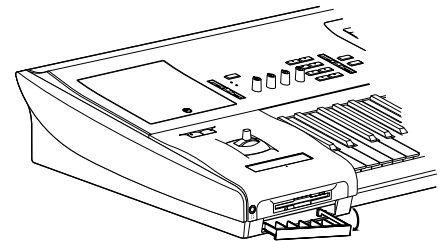

- ⚠ Keep the cover you removed, since it will be needed if you remove the CDRW-1.

- ③ Insert the CDRW-1. Be sure that the drive is oriented in the correct direction.

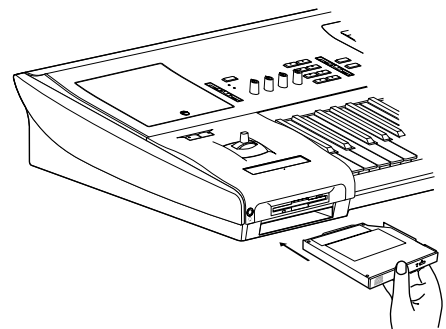

- Press the locations indicated by the arrows until the unit clicks into place, so that the internal connector is securely connected.

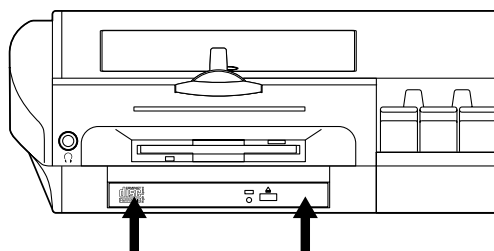

Apply equal pressure to both points.

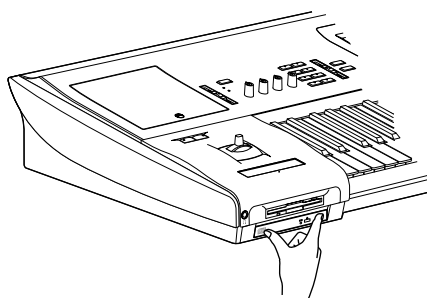

- When you have completed all of the above steps, turn on the power and verify that the CDRW-1 has been installed correctly. ("Checking after installation" p.287)  
If the TRITON STUDIO did not recognize the CDRW-1, you can either press strongly once again on the arrows in step ③, or try reinstalling the CDRW-1.

#### Removing the CDRW-1

When you slide the [EJECT] switch located on the bottom of the TRITON STUDIO, the CDRW-1 will be pushed out of the TRITON STUDIO. Gently remove the CDRW-1.

#### Fastening the CDRW-1 firmly in place

By using the screw included with the option, you can lock the [EJECT] switch of the TRITON STUDIO to prevent the CDRW-1 from coming out accidentally.

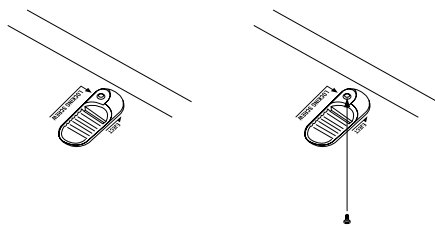

#### Note when transporting/moving/shipping the CDRW-1

- The CDRW-1 is a precision device that is vulnerable to shock and vibration. It may be damaged if it is left in the TRITON STUDIO during transport or shipping. Before you transport or ship the TRITON STUDIO, please remove the CDRW-1 and transport it in its own packaging.

#### Cautions for handling

- Make sure that the unit is level when operating.
- Do not use in extremely cold or hot locations.
- Do not use in locations of high humidity.
- Do not use this unit in locations of excessive dust or smoke.
- Do not apply strong physical shock to the unit. In particular, the unit is highly sensitive to physical shock during operation (either reading or writing), and must not be jarred.
- Normally, the drive uses software ejection. Although the CD tray can be opened by pressing the eject button, you can also make the tray open by inserting a pointed object (such as straightened paper clip) into the emergency eject hole.
- Do not store the unit in high temperature or high humidity.
- Never touch the focussing lens.
- Do not use commercially available lens cleaners.
- Do not transport the unit with a disc left in the drive.
- Do not leave the unit with the tray left open.

#### CD-R/RW disc handling

Please observe the following points when handling discs. Failure to observe these points may cause problems such as data not being written correctly, loss of recorded data, or drive malfunction.

- Do not place discs in direct sunlight or in locations of high temperature or high humidity.
- Do not touch the surface of the disc. Hold the disc by its edges.
- Remove dust or dirt from the surface of the disc. Use an air duster or cleaner to remove dust.
- Do not affix labels to the disc, or write on the disc in locations other than specified.
- Do not use chemicals or detergent to wipe the disc.
- Do not bend or drop the disc.

#### Responsibility for loss of data

Korg Corporation will accept no responsibility for any damages (direct or indirect, whether sustained by the customer or by a third party) resulting from loss of or damage to data written on a CD-R or CD-RW disc.

#### Inserting a disc

Make sure that the power of the TRITON STUDIO is turned on.

- Open the disc tray  
Press the eject button of the CDRW-1, and the disc tray will open.  
At this time, the tray will open only halfway. Pull it out manually until a disc can be placed in the tray.

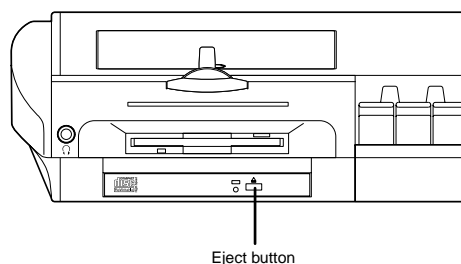

- Before using the CDRW-1 for the first time, you must remove the pickup stopper from the disc tray.

② Insert the disc

▲ Place the disc on the disc tray with its label facing upward, and centered correctly.

③ Close the disc tray.

Manually press the disc tray in until it is completely closed.

If the TRITON STUDIO does not recognize the disc, re-install the CDRW-1 as described in "Installing the CDRW-1."

### Removing a disc

① Press the eject button, and the disc tray will open.

② Gently remove the disc from the disc tray.

③ Manually press the disc tray in until it is completely closed.

### Emergency removal of the disc

Normally you can use the above procedure to remove and insert the disc. However if a problem (such as power failure) occurs and the disc cannot be removed, you can use the following method to remove the disc.

**note** To use this method, you will need a pin-like object of less than 2 mm diameter, such as a straightened paper clip. Insert this "pin" straight into the manual eject hole, and press. The disc tray will be forced open.

▲ Please be aware that excessive use of this method may cause the CDRW-1 to malfunction.

▲ This procedure must be performed with the power off.

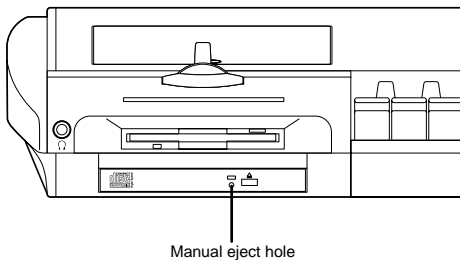

### Formatting a disc

Blank media (indicated in the "drive select" area as Blank Disc) must be formatted before it can be used for packet writing of data. (☞p.299)

Formatting is not necessary if you will be using the disc to create an audio CD.

### Using the CDRW-1

▲ When using the CDRW-1, you must be sure that the TRITON STUDIO is placed on a level surface that does not vibrate.

▲ Please observe the following points when writing data to the CDRW-1 (and while formatting a disc). If you fail to observe these points, it may become impossible to create an audio CD successfully, or it may no longer be possible to read data.

- Do not write or format a disc in a location where there is high-volume sound.
- Do not touch the TRITON STUDIO while a disc is being written or formatted. (Even slight vibration or shock may cause an error.)

▲ You must carefully read "About copyright" (☞BG p.iii) and observe the terms of use.

### Saving/loading on the CDRW-1

- Disk mode P0-2: Save, P0-1: Load

Saving/loading on the CDRW-1 is the same as saving/loading on an external drive. However, a disc must be formatted before it can be used for packet writing. ("Packet writing support on the TRITON STUDIO" ☞p.299)

### Creating an audio CD

- Disk mode P0-4: Make Audio CD

If you want to use the CDRW-1 to create an audio CD, refer to "Creating an audio CD from WAVE files sampled to hard disk" (☞BG p.118)

### Playing back an audio CD

- Sampling mode P5: Audio CD
- Disk mode P0-5: Play Audio CD

If you want to use the CDRW-1 to play an audio CD, use the various SEQUENCER keys in the pages listed above.

**note** In the same way as for external audio sources from AUDIO INPUT 1 and 2, set "Input" to Analog, and set Input1 (L channel) and Input2 (R channel). (☞BG p.102)

### Sampling from an audio CD

- Sampling mode P5: Audio CD (analog/digital)
- Program, Combination, Sequencer modes P0 page, Sampling mode (analog)

**note** In the same way as for external analog audio sources from AUDIO INPUT 1 and 2, set "Input" to Analog, and set Input1 and Input2. (☞BG p.104)

If you want to use the Ripping function to sample digital audio from an audio CD inserted in the CDRW-1, you can do so in the Sampling mode P5: Audio CD page. (☞BG p.108)

## Replacing the calendar battery

Before you replace the battery, you must read “Safety precautions” and “Cautions when installing the calendar battery.”

- ⚠ While performing this procedure, be careful of any sharp edge or corner of the TRITON STUDIO or an option board.
  - ⚠ You must leave the AC power cable disconnected until you have finished all steps of replacing the calendar battery.
- ① Remove the EXB-MOSS/EXB-DI cover as described in steps ①–⑤ of “Installing the EXB-MOSS.”
  - ② Verify the location in which the calendar battery is installed. (See Step ⑥ of “Installing the EXB-MOSS”)

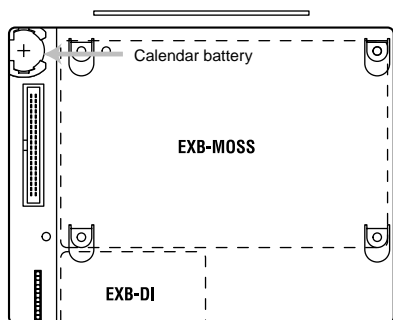

With the cover removed

Rear panel

- ③ Remove the calendar battery that has run down.  
Press the part of the battery indicated in the diagram below to release the catch of the battery holder, and then lift up and remove the battery.
- ⚠ Be careful not to drop the battery into the interior of the TRITON STUDIO.

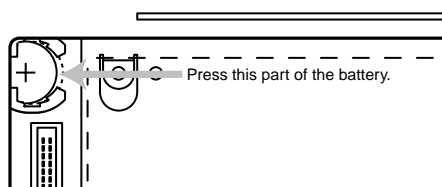

- ④ Install the new battery.  
With the “+” side of the calendar battery facing upward, insert it into the battery holder at an angle, and press it into place.

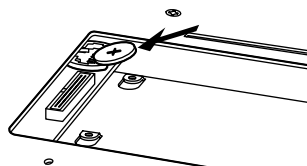

- ⑤ Reversing the procedure described in steps ①–⑤ of “Installing the EXB-MOSS,” reattach the EXB-MOSS/EXB-DI cover.
- ⑥ When all of the above steps have been completed, turn on the power, and verify that the “Battery voltage for calendar IC is low” is no longer displayed.
- ⑦ After you have verified that the above message did not appear, use the page menu command “Set Date/Time” (Disk, Utility) to reset the calendar.

## Connecting external SCSI devices

External SCSI devices (hard disks, removable media, etc.) can be connected to the SCSI connector of the TRITON STUDIO.

Data can be saved to a connected hard disk, removable media, or CD-R/RW etc. in the same way as to a floppy disk, and data can be loaded from a connected CD-ROM.

### External SCSI device connections and settings

- Maximum capacity of external drive: 2 TB (2,000 Gbytes) per drive
- SCSI connector: D-sub half-pitch 50 pin
- Number of units that can be connected: up to 7 units

⚠ Please use the recommended drives for external connection. For a list of recommended drives, please contact your Korg distributor.

⚠ Since the external SCSI device to be connected may have a different shape of connector, refer to the owner's manual for your external SCSI device to verify the type of connector before you purchase a SCSI cable.

#### 1. Turn off the power of the TRITON STUDIO and of your external SCSI device.

Be sure to turn off the power of the TRITON STUDIO and the external SCSI device before you connect or disconnect SCSI cables or change the ID number of the external SCSI device.

⚠ If the power of the TRITON STUDIO or the external SCSI device is on when you connect or disconnect SCSI cables or change the ID number of the external SCSI device, the TRITON STUDIO or the external SCSI device may malfunction, or data may be lost.

#### 2. On the external SCSI device, set the ID number (0-6).

If you are connecting two or more external SCSI devices (in a "daisy-chain"), set each external SCSI device to a different ID number so that they can be distinguished. For details on setting the ID number, refer to the owner's manual for your external SCSI device.

⚠ If you set two or more external SCSI devices to the same ID number, malfunctions or loss of data may result.

#### 3. Connect the SCSI connector of the TRITON STUDIO to the SCSI connector of the external SCSI device.

Pay attention to the orientation of the cable connector, and make connections correctly. If the cable connector has a lock (thumb-screw or page), be sure it is fastened securely.

⚠ If you connect two or more external SCSI devices (in a "daisy-chain"), be sure that the total length of the connection cables does not exceed 3 meters.

#### 4. Attach a terminator (terminating resistor) to the external SCSI device so that the connection is terminated.

If two or more external SCSI devices are connected (in a "daisy-chain"), terminate the device that is furthest from the TRITON STUDIO.

Even if only one external SCSI device is connected, it must be terminated.

Some external SCSI devices require an externally attached terminator, while others contain an internal terminator. Refer to the owner's manual for your SCSI device.

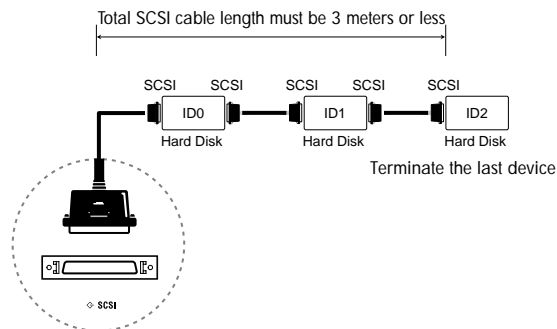

#### 5. Turn on the power of the external SCSI device(s), and then turn on the power of the TRITON STUDIO.

When you turn on the power, first turn on the power of the external SCSI device, and after waiting at least ten seconds, turn on the power of the TRITON STUDIO.

The power must be turned off in the order of TRITON STUDIO fi external SCSI device.

Never turn off the power while the external SCSI device is being accessed (e.g., while the LED of the external SCSI device is lit).

⚠ When the power of the TRITON STUDIO is turned on, it will check the SCSI device connection status, and if the TRITON STUDIO is turned off during this checking process, the SCSI device may stay in an inoperable state. If the power of the TRITON STUDIO is once again turned on in this state, the system cannot be started up. You must turn the power of the SCSI device off and then on again, and then turn on the power of the TRITON STUDIO.

#### 6. Make sure that the TRITON STUDIO has recognized the external SCSI device.

Use the drive select command of the TRITON STUDIO's Disk mode etc. to make sure that the connected external SCSI device has been recognized.

If it has not been recognized, immediately turn off the power of the TRITON STUDIO and of the external SCSI device, check the connections between the TRITON STUDIO and the external SCSI device.

### Using an external SCSI device

For details on formatting an external SCSI hard disk or similar device, and using it to load or save data, refer to p.155, BG p.59.

## Packet writing support on the TRITON STUDIO

The TRITON STUDIO can use packet writing to write to a CD-R/RW. After formatting the media, you can use it in the same way as a floppy disk or hard disk.

### ■ About packet writing

Packet writing is a method of dividing data into small units called "packets" so that the data can be written efficiently, and is suitable for adding or updating data.

As its packet writing format, the TRITON STUDIO uses UDF (Universal Disk Format), the format that is also used on DVD discs. This means that formatted CD-R/RW media can also be read by packet writing software that supports UDF.

The TRITON STUDIO supports UDF version 1.5.

### ■ Usable media

 To save data, please use media that has been formatted by the TRITON STUDIO.

- 650 MB and 700 MB CD-R media that supports up to 16x writing
- 650 MB and 700 MB CD-RW media that supports up to 4x/10x writing

### ■ Formatting

In the same way as when formatting a floppy disk, insert blank or previously-formatted media into the drive, and execute the page menu command "Format" (Disk Utility 0-3F).

 When writing to the CDRW-1 option, do not subject the TRITON STUDIO to vibration or physical shock, since this may cause errors.

### □ Cautions when formatting

#### [1] For a CD-R

- Data that has been written to CD-R cannot be erased as it can on a floppy disk. This means that re-formatting previously-formatted media will not increase the free area. (Approximately 20 MB of space will be used to add a new session.)
- Only **Quick Format** can be selected. Quick Format requires less than a minute to execute.

**note** It is not necessary to apply Full Format to CD-R media.

#### [2] For a CD-RW

- In the same way as a floppy disk, a CD-RW can be formatted to erase the previously-written contents. This means that re-formatting the disc will increase the free area.
- **Quick Format**: Select this if the media has already been formatted in UDF format.  
**Full Format**: Select this if the media is blank or if it has not been formatted in UDF format. You should also execute this type of formatting if frequent writing errors occur when writing to the media.

The time required for formatting will be approximately 2 minutes for Quick Format, and approximately 50 minutes for Full Format.

- After formatting, the usable area for 650 MB/700 MB media will be approximately 530 MB/570 MB respectively

### ■ Cautions when using packet writing

#### [1] For a CD-R

- Deleting a file merely makes the file appear as if it had been deleted, and will not increase the free area. Also, each time a file is updated, a new file is added, and processing is performed to make it appear as though the file had been overwritten.

#### [2] For a CD-RW

- In the same way as on a floppy disk, deleting a file will increase the free area. Also, updating a file will overwrite the file over the previous location.

#### [3] About writing data

- Using packet writing to save data on a CD-R/RW will take a longer time because writing to CD-R/RW is slower than writing to hard disk. The time will also depend on the CD-R/RW drive you use, and on the writing speed supported by the media you use.

### ■ Loading into an external device other than the TRITON STUDIO

#### [1] For a CD-R

- The disc can be read by a computer on which packet writing software is installed.
- By converting it into ISO9660 format, you can make it possible for the data to be read by an external MIDI device that supports ISO9660 format, or by a computer on which packet writing software has not been installed. For details on the conversion, refer to page menu command "Convert to ISO9660 Format" (Disk Utility 0-3G).

#### [2] For a CD-RW

- The disc can be read by a computer on which UDF reader or packet writing software has been installed.
- This disc cannot be converted into ISO9660 format, and therefore cannot be read by external MIDI devices that support ISO9660 format.

**note** Since the conversion to ISO9660 format adds ISO9660 session data, it consumes approximately 20 MB of space.

**External MIDI devices that support ISO9660 format (\*1) (manufactured by Korg Corporation)**

- TRITON/TRITON pro/TRITON proX/TRITON-Rack (\*2)
- D1600/D12/D16

\* As of February 2002

\*1: Supports ISO9660 level 1.

\*2: Only the first session can be read.

If reading on an external device other than the TRITON Studio

 When you copy a file larger than 1.9 Mbytes from CD-R/RW (or other media with a slow access speed) to CD-R, the file may not be copied in a continuous state.

Also, when you execute "Rate Convert" (Global 0-3G), "Save to Std MIDI File" (Disk 0-2F) or similar command to save to CD-R, the file may not be written in a continuous state even if it is copied from media with a fast access speed such as hard disk. If data in this state is converted into ISO9660 format, it will be in the divided file format supported by ISO9660 level 3. Such data cannot be read by devices that do not support loading of divided files, such as the TRITON and some computers. In the case of a computer, this CD-R data can be read if you can install ISO9660 level 3 compatible reader software or packet writing software.

## EXB-DI option

The EXB-DI option provides an ADAT™ Compatible Optical Output which digitally outputs the audio signal from the TRITON STUDIO, and also allows the digital signal to be synchronized with another digital audio device.

For an explanation of the DIGITAL OUT connector and WORD CLOCK IN connector, refer to BG p.7.

In this owner's manual, "ADAT" is used as a general designation for ADAT compatible multi-track recorders such as the Alesis ADAT.

### Example connections

#### Digitally recording the sound of the TRITON STUDIO to an ADAT

- ① Use an ADAT-Optical cable (sold separately) to connect the TRITON STUDIO's Digital OUT connector to the ADAT's Digital INPUT.  
For connections, use an ADAT-Optical cable manufactured by Alesis Corporation or an optical cable for CD/DAT (both sold separately).
- ② Set the TRITON STUDIO's "System Clock" (Global P0: 0-2a) to **Internal**.
- ③ Set the word clock source of the ADAT to "DIG 48 K."  
For details refer to the manual for the connected ADAT.

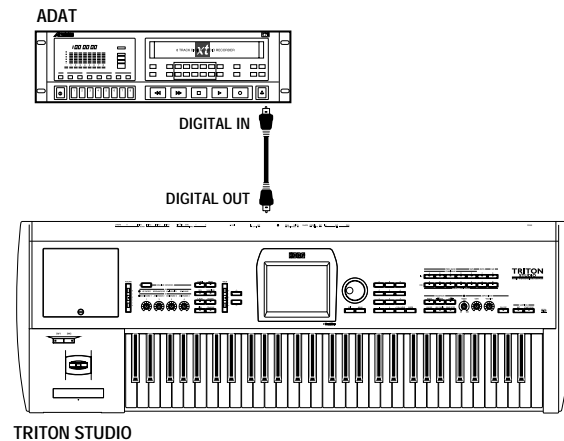

## Digitally recording the sound of the TRITON STUDIO that has been mixed on a digital mixer to the ADAT

- ① Use an ADAT-OPTICAL cable to connect the TRITON STUDIO's DIGITAL OUT connector to the ADAT OPTICAL IN connector of the ADAT Optical format-compatible mixer.
- ② Use ADAT-OPTICAL cables to connect the respective IN and OUT connectors of the ADAT Optical format-compatible mixer and the ADAT.
- ③ Make connections as shown in the following diagram so that an Alesis BRC Remote Controller or other ADAT optical format compatible mixer or remote controller can be used as the master for digital signal synchronization, and connect the WORD CLOCK OUT connector of the mixer to the WORD CLOCK IN connector of the TRITON STUDIO.

For connections, use a BNC Coax cable made by Alesis Corporation or a BNC cable made for video (both sold separately).

- ④ Set the TRITON STUDIO's "System Clock" (Global P0: 0-2a) to **Word Clock**.  
The digital audio signal that is output from the DIGITAL OUT connector is output in synchronization with the clock signal received at the WORD CLOCK IN jack, allowing the digital signals of the two devices to be synchronized.

**note** If you wish to store the "System Clock" setting, use the "Write Global Setting" utility to write it.

- ⑤ Set the word clock source of the ADAT to "DIG 48 K."  
For details refer to the manual for the connected ADAT.

**!** If the clock cannot be detected correctly due to a disconnected BNC cable or for some other reason, an error message "Word Clock Error!" will appear in the LCD. If this occurs, check whether a problem has occurred with the BNC cable.

If "System Clock" has been written as **Word Clock**, the same error message will be displayed when the TRITON STUDIO is powered-on if the correct clock is not being input.

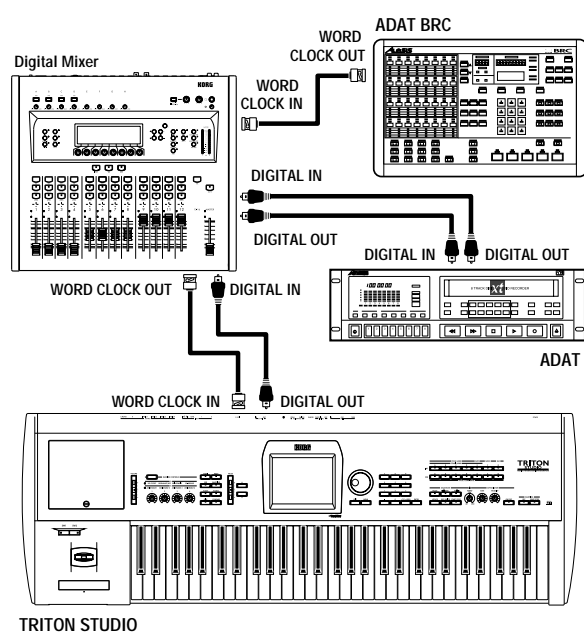



# Index

## Numerics

- 000: No Effect **178, 187**
- 10's Hold
  - Combination **33**
  - Program **2**
- 12 dB **5, 6, 37, 56, 57, 99, 108, 138**
- ♪  Tempo

## A

- ADC OVERLOAD !! **5, 37, 56, 98**
- After Touch
  - After Touch Curve **136**
  - AMS **242**
  - Convert Position **143**
  - MIDI Filter **144**
    - Combination **40**
    - Sequencer **65**
- AIFF file (.AIF) **163, 168, 283**
- AKAI S1000/S3000 format **164**
- All Routed **47, 85, 132, 182**
- Alternate modulation **14, 18, 20, 25, 241**
  - Alternate modulation source **50, 241**
- Amp **22**
  - AMS **242**
  - Drum Kit
    - Attack (Amp-Attack) **149**
    - Decay (Amp-Decay) **149**
  - Program **21**
    - Amp EG **23, 246**
    - Amp Level **2, 21**
    - Keyboard Track, Amp Mod. **22**
    - LFO, Amp Mod. **22**
    - Realtime Control Knobs **250**
- AMS (Alternate Modulation Source) **241**
- Arpeggiator **3, 26, 36, 44, 81, 129**
- Arpeggiator Assign **44, 81, 129**
- Arpeggio
  - Arpeggio Tone Mode **152**
  - Fixed Note Mode **152**
  - Pattern **3, 27, 36, 45, 82, 130, 152**
  - Preset arpeggio pattern **27, 152**
  - User arpeggio pattern **27, 152**
    - Load **160**
    - Save **166**
    - Write **153**
- Attack Time
  - Amp EG **23**
  - Drum Kit **149**
  - Filter EG **19**
  - Filter EG + Amp EG **2**
  - Pitch EG **14**

- Realtime Control Knobs B-Assign **250**
- Sample **11**
- Audio CD **120**
  - Audio CD Track List **169**
- AUDIO OUTPUT (INDIVIDUAL) **185**
- Auto
  - Auto +12 dB On **6, 57, 99**
  - Auto Arpeggiator **136**
  - Auto Loop On **99**
  - Auto Optimize RAM **140**
  - Auto Punch In **58**

## B

- Bank
  - Combination
    - Bank (Bank Select) **33**
    - Bank Select (When Status=EX2) **38**
    - Bank/Combination Select **33**
    - Bank/Program (Program Select) **34, 37**
    - Load Combination Bank **159**
    - Select Bank & Smpl No. **37**
  - Global
    - Bank Map **137**
    - Change all bank references **137**
    - Enable Bank Change **144**
    - High Drumsample Bank **148**
    - Low Drumsample Bank **149**
  - Program
    - Bank (Bank Select) **1**
    - Bank/Program Select **1**
    - High MS Bank **9**
    - Load Program Bank **159**
    - Low MS Bank **10**
    - Select Bank & Smpl No. **6**
  - Sampling
    - Bank (RAM Bank) **90**
  - Sequencer
    - Bank Select (When Status=EX2) **63**
    - Bank/Track Program Select **51**
    - Pattern (Pattern Bank) **76, 79**
    - Program Select (Bank/Program) **51**
  - Song Play
    - Program Select (Bank/Program) **124**
- Bank select **260**
- Base key **89**
- Beep Enable **139**
- Bend Range
  - Combination **39**
  - Sequencer **63**
- Bounce
  - Bounce Pattern **77**
  - Bounce Track **70**

## BPM

- BPM/MIDI SYNC function **248**
- Detune (BPM Adj. in Page Menu)
  - Combination **39**
  - Sequencer **63**
- Detune BPM Adjust
  - Combination **39**
  - Sequencer **64**
- Grid **100, 105, 108**
- MIDI/Tempo Sync., LFO **26**
- Pitch BPM Adjust **118**
- Time Slice **109**
- Time Stretch **113**

## BUS Select

- Combination **179, 183**
  - BUS Sel. (BUS Select) **47**
  - BUS Select (IFX/Indiv.Out BUS Select) **46**
  - BUS(IFX/Indiv.) Select **36**
- Drum Kit
  - BUS Select (IFX/Indiv.Out Assign) **151**
- Input/Sampling (Audio Input) **181, 184**
  - BUS (IFX/Indiv.) Select **140**
- Play Audio CD
  - BUS (IFX/Indiv.) Select **175**
- Program **179, 183**
  - BUS (IFX/Indiv.) Select **4**
  - BUS Sel. (BUS Select) **30**
  - BUS Select (All OSCs to) **28**
- Sampling **180**
  - BUS (IFX/Indiv.) Select **97**
  - BUS (Output) Select (BUS Select) **125**
  - BUS(IFX) Select **122**
  - BUS(Output) Select **99**
- Sequencer **179, 183**
  - BUS (IFX/Indiv.) Select **56**
  - BUS (Output) Select **58**
  - BUS Sel. (BUS Select) **84**
  - BUS Select (IFX/Indiv.Out BUS Select) **83**
- Song Play **179, 183**
  - IFX/Indiv.Out BUS Select (BUS Select) **131**

## C

- Calendar battery **286, 297**
- Calibration **137**
- Category
  - Combination **33, 34, 35**
  - Drumsample **149**
  - IFX Select **30**
  - MFX Select **31**
  - Program **1, 3, 9**
  - Rename **147**
  - Sequencer **51**
  - Song Play **123, 125**
- CDRW-1 **287, 294**

- Chain
    - IFX **30, 47, 84, 179**
    - MFx **31, 48, 184**
      - Chain Direction **31, 48, 185**
      - Chain Level **31, 48, 185**
      - Chain Signal **31, 48, 185**
  - Chain to next file **125**
  - Chords strummed on a guitar **154**
  - Clear/Erase
    - Clear, Audio track list **172**
    - Clear, Load **158, 160, 163**
    - Clear, Sample data **102**
    - Erase Control Data **73**
    - Erase Measure **70**
    - Erase Pattern **77**
    - Erase Track **70**
    - Remove Data **58, 76**
    - Shift/Erase Note **74**
  - Combination **33**
    - Auto Arpeggiator **136**
    - Bank Map **137**
    - Copy From Combi **52**
    - Load **157, 159**
    - Memory Protect **139**
    - MIDI Filter **144**
    - Save **166, 167**
    - Write **35**
  - Condition at power-on **138**
  - Control change **255, 260**
  - Controller **253**
  - Convert
    - Convert MS To Program **93**
    - Convert Position **143**
    - Convert to ISO9660 Format **171**
    - Convert to Song **61**
    - Rate Convert **105**
    - Select Bank & Smpl No. **6, 56**
    - Time Slice **112**
  - Convert Position **143**
  - Copy
    - Copy Arpeggiator **27, 45, 82, 130**
    - Copy Arpeggio Pattern **153**
    - Copy Cue List **60**
    - Copy Drum Kit **150**
    - Copy From Combi **52**
    - Copy From Song **52**
    - Copy Insert Effect **29, 46, 84, 122, 132**
    - Copy Key Setup, Drum Kit **150**
    - Copy Master Effect **32, 48, 85, 133**
    - Copy Measure **72**
    - Copy MS (Copy Multisample) **93**
    - Copy Oscillator **8**
    - Copy Pattern **77**
    - Copy Pattern to Track too? **53**
    - Copy Sample **92**
    - Copy Scale **147**
    - Copy Song **62**
    - Copy Step **154**
    - Copy To Track **78**
    - Copy Track **70**
    - Copy, File, Directory **169**
    - Copy, Index **118**
    - Copy, Sample data **102**
    - Copy, Step, Cue List **60**
    - Event **70**
    - Revert, RPPR **79**
  - Count-down
    - Metronome Precount **5**
    - Metronome Precount, Sampling **98**
    - Sound, Sequencer **58**
  - Create
    - Create Control Data **73**
    - Create Directory **170**
    - Create, Index **89, 118**
  - Ctrl Ch **47, 48, 85, 86, 132, 133, 182, 185, 246, 254**
  - Cue List **59**
    - Convert **61**
    - Load **158, 160**
    - Save **166, 167**
  - Current directory **128, 156**
  - Cut
    - Cut, Audio track **173**
    - Cut, Cue List **60**
    - Cut, Event **70**
    - Cut, Event Edit **69**
    - Cut, Index **118**
    - Cut, mLAN **141, 142**
    - Cut, Multisample **118**
    - Cut, Sample **102**
    - Cut, Sample data **102**
    - Cut, Step, Cue List **60**
  - Cutoff frequency **16**
    - Alternate Modulation **244**
    - Cutoff, Drumsample **149**
    - Cutoff, Sample Parameters **10**
    - Realtime Control Knobs B-Assign **250**
- ## D
- Damper pedal **232**
    - AMS **242**
    - Damper Polarity **146**
    - Half Damper Calibration **137**
    - MIDI Filter **144**
      - Combination **40**
      - Sequencer **65**
  - Decay Time
    - Amp EG **23**
    - Drum Kit **148**
    - Filter EG **19**
    - Filter EG + Amp EG **2**
    - Pitch EG **14**
    - Realtime Control Knobs B-Assign **250**
    - Sample **11**
  - Delay Time
    - Combination **40**
    - Drum Kit **10**
    - OSC **10**
    - Sequencer **64**
  - Delete
    - Delete button, Jukebox **128**
    - Delete Cue List **60**
    - Delete Measure **71**
    - Delete MS **93**
    - Delete Sample **92**
    - Delete Song **52**
    - Delete Step **154**
    - Delete, file, directory **170**
    - StepBack, note, rest **69**
    - Truncate **101, 109**
  - Detune
    - Detune (BPM Adj. in Page Menu) **ⓂBPM**
    - Detune BPM Adjust **ⓂBPM**
  - DKit **21, 28, 46, 83, 131, 179, 180, 183, 184**
  - Dmod (Dynamic Modulation Source) **30, 32, 47, 48, 84, 85, 122, 132, 133, 177, 182, 185, 246**
  - Double-size effect **178**
  - DRAM SIMM **287, 290**
  - Drive select **7, 96, 121, 128, 156, 173, 175**
  - Drum Kit **10, 46, 84, 95, 132, 139, 148, 150, 159, 180**
    - DrumKit IFX Patch **46, 84, 132, 180**
    - Load **157, 159**
    - Oscillator Mode **7**
    - Protect **139**
    - Save **166, 167**
    - Use DKit Setting **21, 28, 179, 183**
    - Write **150**
  - Drums **7, 9, 21, 28, 39, 46, 63, 179, 180, 183**
  - Drumsample **148, 149**
  - Dump **144**
    - Reception **145**
    - Transmission **145**
  - Dynamic modulation **ⓂDmod**
- ## E
- Effect Global Switch **136**
  - Erase **ⓂClear/Erase**
  - Event Edit **69, 77**
  - EXB-DI **287, 292, 300**
  - EXB-mLAN **287, 293**
  - EXB-MOSS **287, 291**
  - EXB-PCM series **287, 288**
  - Exclusive **264**
    - Exclusive Data **161, 168**
    - MIDI Filter **144**
  - Exclusive Group **150**
  - .EXL file **155, 161, 168**

## F

- FF/REW Speed 54
- Filter 16
  - AMS 242
  - Drum Kit
    - Cutoff 149
    - Resonance 149
  - Program
    - Filter A/B Modulation, Filter Mod. 18
    - Filter EG 19
    - Filter EG, Filter Mod. 17
    - Filter Type 16
    - Keyboard Track, Filter Mod. 17
    - LFO, Filter1 LFO Mod. 18
    - Performance Editor 2
    - Sample Parameter 11
  - Realtime Control Knobs 250
- Fixed Note Mode 152
- Flam 154
- Foot Pedal/Foot Switch
  - AMS 242
  - Foot Pedal Assign 146, 252
  - Foot Pedal/Switch
    - MIDI Filter, Combination 41
    - MIDI Filter, Sequencer 66
  - Foot Switch Assign 146, 251
  - Foot Switch Polarity 146
- Force OSC Mode 38, 63
- Format 170
- Full Format 171

## G

- Gain
  - MEQ 31, 185, 239
- Gate, Arpeggiator 27, 45, 82, 130, 153
- Get
  - Get From Track 78
- Global MIDI Channel 142
- Global setting
  - Load 157, 160
  - Save 166, 167
  - Write 136
- GM 1, 10, 137
  - GM Initialize 54, 124
  - GM system on 265
  - GM/GS/XG 267
- Grid 100, 105, 108

## H

- Half Damper 137
- Hard disk 155, 156, 298
  - Check Medium 171
  - Destination 121
  - Save to 5, 37, 56, 90
  - Select Directory 7, 37, 56, 96
- Hide unknown files 157

- Hold 8
- Hold Balance 36

## I

- Icon 155
- Index
  - Audio CD 120, 174
  - Sampling 11, 88, 100, 107, 110, 114, 117
  - Sequencer 69
- Index, Multisample 11, 57, 88, 89, 100, 107, 110, 117
- Initialize Steps 154
- Input
  - (COMBI, PROG, SEQ, S.PLAY, DISK) 4, 36, 56, 139, 175
  - (SAMPLING) 96
- Inputting a tie 69
- Inputting notes 69
- Inputting rests 69
- Insert
  - Insert Measure 71
  - Insert Step, Arpeggio 154
  - Insert Zero 103
  - Insert, Audio track 172
  - Insert, Event 69
  - Insert, Index 118
  - Insert, Sample 102
  - Insert, Step, Cue List 60
- Insert Effect (IFX) 28, 46, 83, 122, 131
  - Effect Global Sw, IFX1-5 Off 136
  - IFX Balance 3
- ISO9660 155, 171

## J

- .JKB file 129, 155
- Joystick 260, 261
  - AMS 242
  - AMS, Cutoff frequency 18
  - Dmod 246
  - Effect 190, 210, 235, 238
  - Joystick lock 249
  - LFO speed 25
  - LFO, Cutoff frequency 19
  - MIDI Filter 41, 65
  - Pitch 12, 14
  - Pitch modulation 14
- Jukebox 129

## K

- .KCD file 155, 165, 169
- KEY
  - Drum Kit 148
  - Resampling 98
  - RPPR 79
- Key Split 42

## Key Sync.

- Arpeggiator 3, 27, 36, 45, 82, 130, 152
- LFO 25
- Key Transpose 135
- Key Zone 42, 66
- Keyboard & Index 89
- Keyboard Display 95
- Keyboard Track
  - Amp 22
  - AMS 242, 244
  - Filter 17
- .KMP, .KSC, .KSF file 155, 162, 163, 285
- Translation 157
- Korg format 162, 167, 284

## L

- Layer 42
- Legato 7
  - Fingered 13
- Length
  - Arpeggio Pattern 152
  - Cue List 59
- Level 178
- LFO 25
  - Amp 22, 245
  - AMS 241
  - Filter 19, 245
  - Frequency 25, 246
  - Pan 21
  - Pitch 14, 244
  - Resonance 16
  - Swap 26
  - Tempo 26
  - Waveform 25
- Load
  - Load FX? 60
  - Load Jukebox List 129
  - Load selected 157
  - Load Template Song 53, 124
  - Loading multiple files 162
- Local Control 142
- Location 49, 59, 123
  - Set Location 54, 125
- Loop
  - Auto Loop On 99
  - Loop All Track 58
  - Loop Lock 108
  - Loop On 108
  - Loop Start Address 108
  - Loop Start Measure/Loop End Measure 55
  - Loop Tune 108
  - Track Play Loop 55
- Low Pass & High Pass 16
- Low Pass Resonance 16

## M

Master Effect (MFX) **182**  
MFX Balance **3**  
MFX1 Off/MFX2 Off **136**  
MFX1, 2  
Combination **48**  
Program **31**  
Sequencer **85**  
Song Play **133**  
Master EQ (MEQ) **185, 239**  
Combination **48**  
Program **32**  
Sequencer **86**  
Song Play **133**  
Master Track **49, 50**  
Master Tune **135**  
Media **155**  
Check Medium **171**  
Total Size **175**  
Type **156, 175**  
Memory Protect **139**  
Memory Status  
Sample **99**  
Sequencer **52**  
Metronome  
Metronome Precount **5, 37, 98**  
Metronome Setup **6, 37, 58, 99, 125**  
Metronome Sound **76**  
.MID file **123, 155, 161, 167**  
MIDI **65, 142, 258**  
MIDI Channel **259**  
Combination **38, 47, 48**  
Global MIDI Channel **142**  
Program **1**  
Sampling **259**  
Sequencer **62, 65, 85, 86**  
Song Play **123, 132, 133**  
MIDI Clock **143**  
MIDI Filter **40, 65, 144**  
Mixer **181, 184**  
mLAN **4, 36, 56, 96, 138, 139, 140, 141, 143, 175, 287, 293**  
Mono  
Drum Kit **150**  
Multisample **94**  
Program **7, 38, 63**  
Sample **5, 91, 94**  
MOSS **287, 291**  
Mount **176**  
Move  
Move Measure **72**  
Moving an event **70**  
Shift/Eraser Note **74**  
Multi REC **58**  
Multisample **9, 87, 88, 117**  
Load **162**  
Save **167**  
Multi-track recording **58, 267**

## Mute

PLAY/MUTE, Song Play **124**  
PLAY/MUTE/REC, Sequencer **51**

## N

Normalize **104**  
Note  
Note On/Off Receive **150**  
Note Receive Filter **143**  
Note Number  
AMS **242**  
Number of measures  
Pattern **77**  
Song **75**

## O

Octave  
Octave Motion, Arpeggiator **152**  
Octave, Arpeggiator **3, 27, 36, 45, 130, 152**  
Octave, Drum Kit **10**  
Octave, OSC **10**  
Octave, Performance Editor **2**  
Offset  
Offset, LFO **25**  
Offset, Sequencer **74**  
S.Offset (Start Offset)  
Drum Kit **149**  
Program **9**  
Optimize **6, 96, 140**  
Original Key **89, 117**  
Original Key Position **99**  
Oscillator (OSC) **7, 9, 10, 12, 38, 63**  
Force OSC Mode **38, 63**  
OSC Balance **2**  
OSC Select  
Combination **38**  
Sequencer **63**  
Oscillator Mode **7**  
Over Dub **57**  
Over Write  
Over Write, Sequencer **57**  
Overwrite, Sampling **101**

## P

Packet writ **299**  
Pan  
Pan **252, 261**  
Combination **35, 37**  
Drum Kit **151**  
Play Audio CD **174**  
Program **21, 24, 245, 250**  
Sequencer **55**  
Song Play **125**  
Use DKit Setting **21**  
Pan (CC#8), IFX **181, 250, 252**  
Combination **47**  
Program **30, 179**

Sampling **122**  
Sequencer **84**  
Song Play **132**

## Pan, INPUT

Combination **36**  
Global **140**  
Program **4**  
Sampling **97**  
Sequencer **56**

Paste, Sample **103**

## Pattern 76

Pattern Edit **76**  
Preset pattern **53, 76**  
User pattern **76**  
Load **161**  
Save **166**

.PCG file **155, 157, 166**

Performance Editor **2**

## Pitch

Arpeggio Pattern  
Pitch Offset **153**  
Combination  
Bend Range **39**  
Detune **39**  
Transpose **39**  
Drum Kit  
Transpose **149**  
Tune **149**  
Global  
Convert Position **143**  
Key Transpose **135**  
Master Tune **135**  
Program  
AMS **244**  
JS (+X), OSC Pitch Mod. **13**  
JS (-X), OSC Pitch Mod. **13**  
LFO1/2, OSC Pitch Mod. **13**  
Pitch EG **14**  
Pitch EG, OSC Pitch Mod. **13**  
Pitch Slope, OSC Pitch Mod. **12**  
Pitch Stretch **2**  
Pitch, Sample **11**  
Ribbon, OSC Pitch Mod. **12**

## Sampling

Constant Pitch **117**  
Pitch **118**

## Sequencer

Bend Range **63**  
Create Ctrl Data **73**  
Detune **63**  
Transpose **63**

Pitch Bend **39, 63, 73, 260**

Poly/Mono **7**

## Portamento 261

Combination **38**  
MIDI Filter  
Combination **40**  
Sequencer **65**  
Portamento Switch **242, 247, 251**  
Portamento Time **13, 250, 252**  
Program **13**  
Sequencer **65**

Positional Cross-fade **42**  
 Power On Mode **138**  
 Priority **8**  
 Priority to play notes **8**  
 Program **1**  
   Auto Arpeggiator **136**  
   Bank Map **137**  
   Combination **34, 37, 38**  
   Convert MS To Program **93**  
   Load **157**  
   Memory Protect **139**  
   MIDI Filter **144**  
   Save **166, 167**  
   Sequencer **51**  
   Song Play **123**  
   Write **3**  
 Program Change  
   MIDI Filter **144**  
   Combination **40**  
   Sequencer **65**  
 Punch In  
   Auto Punch In **58**  
   Manual Punch In **57, 251**  
 Put To Track **78**

## Q

Quantize  
 Pattern  
   Reso (Realtime Quantize Resolution) **76**  
 Song  
   Quantize **73**  
   Reso (Realtime Quantize Resolution) **51**  
 Quick Format **171**

## R

Rate Convert **105, 171**  
 Realtime Control Knobs B-Assign  
**12, 43, 67, 119, 127, 250**  
 AMS **241**  
 MIDI Filter  
   Combination **41**  
   Sequencer **66**  
 Recording Level **5, 37, 56, 91, 98**  
 Recording Mode **57**  
 Rename  
   Combination **35**  
   File, Directory **169**  
   Pattern Name **78**  
   Program **3**  
   Program/Combination Cat. **147**  
   Rename Arpeggio Pattern **153**  
   Rename Cue List **60**  
   Rename Drum Kit **150**  
   Rename Multisample **93**  
   Rename Sample **93**  
   Rename Song **52**  
   Track Name **75**

Repeat  
   Repeat Measure **72**  
   Repeat, Cue List **60**  
 Resampling **4, 6, 36, 56, 57, 98, 99**  
 Resolution (Reso)  
   Arpeggiator **3, 27, 36, 45, 82, 130, 152**  
   Sequencer **51, 74, 76**  
 Resonance **16**  
   AMS **245**  
   Drum Kit **149**  
   Realtime Control Knobs **250**  
   Sample **11**  
 Reverse  
   Drum Kit **149**  
   Program **9**  
   Sampling **105, 108**  
 Ribbon controller  
   AMS **242**  
   Dmod **247**  
   MIDI Filter  
     Combination **41**  
     Sequencer **65**  
   Pitch **12**  
   Ribbon Lock **249**  
 Ripping **121**  
 Rotate  
   Rotate Step **154**  
 Routing **179, 183**  
   Combination **46**  
   Program **28**  
   Sequencer **83**  
   Song Play **131**  
 RPPR (Realtime Pattern Play/  
 Recording) **79**  
 RPPR On/Off **51**

## S

S/P DIF Sample Rate **138**  
 Sample **88, 89, 100**  
   Free Sample Memory **99**  
   Load **162**  
   Sample Parameters **10**  
   Sample Time **5, 56, 91**  
   Sample waveform display **100, 107**  
   Save **166, 167**  
   Select Bank & Smpl No. **6, 37, 56**  
 Sample Edit **100**  
 Sample memory (RAM) **5, 90**  
   Optimize RAM **6, 37, 96, 140**  
 Sampling **4, 36, 56, 87, 139**  
 Save **167**  
   No space available on medium **166**  
   Save Jukebox List **129**  
   Save Template Song **54, 125**  
   Save to **5, 37, 56, 90**  
 Scale  
   Combination **40**

Program **8**  
 Sequencer **64**  
 Song Play **126**  
   User All Notes Scale **147**  
   User Octave Scale **146**  
 Scan Zone **28, 45, 82, 130**  
 SCSI **298**  
   SCSI ID **298**  
 Select Bank & Smpl No. **6, 56**  
 Send **179, 181, 182**  
   Combination **36, 46, 47, 179, 183**  
   Play Audio CD **174**  
   Program **4, 29, 30, 179, 183**  
   Sequencer **56, 84, 179, 183**  
   Song Play **132, 179, 183**  
 Single Trigger **7, 150**  
 SMF (Standard MIDI File) **123, 268**  
   Load **161**  
   Save **167**  
 .SNG file **155, 163, 166, 167**  
 Solo  
   SOLO ON/OFF **51, 124**  
   Solo Selected Timbre **35**  
   Solo Selected Track **52, 124**  
 Song **50, 52, 60**  
   Convert, Cue List to Song **61**  
   Load **158, 161**  
   Save **166, 167**  
   Set Song Length **75**  
 Sort **3, 27, 36, 45, 82, 130, 152**  
 Status **34, 38, 62, 126**  
 Step  
   Cue List **59**  
   Current Step, Cue List **60**  
   Step No., Arpeggio Pattern **153**  
 Step Recording **68, 77**  
 Stereo multisample **90, 94**  
 Stereo sample **90, 94, 101**  
 SW1, SW2 **12, 43, 67, 119, 127**  
 AMS **243**  
 Assign **249**  
   Combination **43**  
   Program **12**  
   Sampling **119**  
   Sequencer **67**  
   Song Play **127**  
 MIDI Filter **144**  
   Combination **41**  
   Sequencer **66**  
 Swap  
   Swap Insert Effect **29, 46, 84, 122, 132**  
   Swap LFO 1&2 **26**  
   Swap Master Effect **32, 48, 85, 133**  
   Swap Oscillator **8**  
   Swap Track **173**  
 Swing **27, 45, 82, 130**

- Sync.
    - BPM/MIDI Sync. **177, 248**
    - Key Sync.
      - Arpeggiator **152**
      - Arpeggio, Combination **36, 45**
      - Arpeggio, Program **3, 27**
      - Arpeggio, Sequencer **82**
      - Arpeggio, Song Play **130**
    - Key Sync., LFO **25**
    - MIDI/Tempo Sync., LFO **26**
    - Sync Both EGs **20, 24**
    - Sync, RPPR **80**
  - Synchronize **266**
  - System Clock **138**
  - System Exclusive **264**
    - Load **161**
    - MIDI Filter **144**
    - Save **168**
- T**
- Template song
    - Load Template Song **53, 124**
    - Preset Template Song **53**
    - Save Template Song **54, 125**
    - User Template Song **53**
  - Tempo **2, 26, 33, 44, 50, 59, 98, 109, 113, 118, 123, 129**
    - AMS **242**
    - Edit **68, 73**
    - Tempo Mode **50, 59**
  - Terminator (terminating resistor) **298**
  - Timbre **34**
    - Timbre assign **36**
  - Timbre Assign, Arpeggiator **36**
  - Time signature
    - Sequencer
      - Meter **49**
      - Step Recording **68**
    - Song Play
      - Meter **123**
  - Time Slice **109**
  - Tone, Arpeggiator **153**
  - TopKey (Top Key), Sampling **89, 118**
  - Touch Panel **137**
  - Track
    - Load **161**
    - Loop All Track **58**
    - Play (Track Select) **123**
    - RPPR **79**
    - Track Edit **68**
    - Track Name **75**
    - Track Play Loop **55**
    - Track Select
      - Cue List **59**
      - Sequencer **50**
  - Transpose
    - Combination **39**
    - Convert Position **143**
    - Drum Kit **10, 149**
    - Global **135**
    - OSC **10**
    - Sequencer **63**
  - Trigger **4, 37, 56, 97**
    - Pre Trigger REC **98**
  - Truncate **101, 109**
  - Tune
    - Pitch Stretch **2**
    - Tune, Drum Kit **10**
    - Tune, Program **10**
    - User All Notes Scale **147**
    - User Octave Scale **146**
- U**
- Use DKit Setting **21, 28, 179, 183**
  - Use Zero **100, 108**
  - User All Notes Scale **147**
  - User Arpeggio **151**
  - User arpeggio pattern **27, 151**
  - User drum kit **10, 148**
  - User Octave Scale **146**
  - User pattern **76**
  - User Scale **146**
  - User template song **53, 54, 124, 125**
- V**
- [VALUE] slider
    - AMS **243**
  - Velocity
    - AMS **242**
    - Convert Position **143, 258**
    - Scan Zone, Arpeggiator **28, 45, 83, 131**
    - Velocity Cross-fade **42**
    - Velocity Curve **135**
    - Velocity Intensity, Amp Mod. **22**
    - Velocity M.Sample SW Lo → Hi **10**
    - Velocity Sample SW Lo→Hi **148**
    - Velocity Switch **42**
    - Velocity Zone
      - Combination **42**
      - Program **11**
      - Sequencer **67**
    - Velocity, Arpeggiator **27, 45, 82, 130, 154**
    - Velocity, Filter EG **17**
  - Vocoder **233**
  - Volume
    - Foot Pedal Assign **252**
    - Hold Balance **36**
    - Realtime Control Knobs **250**
    - Volume Ramp, Sampling **104**
    - Volume, Audio CD **120, 174**
    - Volume, Combination **36, 37**
    - Volume, Sequencer **55**
    - Volume, Song Play **125**
  - Volume label **156, 170, 175**
- W**
- WAVE file (.WAV) **7, 96, 121, 155, 163, 168, 172, 283**
  - WAVE File Play Level **138**
  - Write
    - Write Arpeggio Patterns **153**
    - Write Combination **35**
    - Write Drum Kits **150**
    - Write Global Setting **136**
    - Write Program **3**
- Z**
- Zone Map
    - Arpeggiator **28, 45, 82, 130**
    - Combination **42**
    - Sequencer **66**
  - Zone Range **99**
  - ZOOM **100, 108**









### **IMPORTANT NOTICE TO CONSUMERS**

This product has been manufactured according to strict specifications and voltage requirements that are applicable in the country in which it is intended that this product should be used. If you have purchased this product via the internet, through mail order, and/or via a telephone sale, you must verify that this product is intended to be used in the country in which you reside.

**WARNING:** Use of this product in any country other than that for which it is intended could be dangerous and could invalidate the manufacturer's or distributor's warranty.

Please also retain your receipt as proof of purchase otherwise your product may be disqualified from the manufacturer's or distributor's warranty.

**KORG** KORG INC.

15 - 12, Shimotakaido 1 - chome, Suginami-ku, Tokyo, Japan.

## Free Manuals Download Website

<http://myh66.com>

<http://usermanuals.us>

<http://www.somanuals.com>

<http://www.4manuals.cc>

<http://www.manual-lib.com>

<http://www.404manual.com>

<http://www.luxmanual.com>

<http://aubethermostatmanual.com>

Golf course search by state

<http://golfingnear.com>

Email search by domain

<http://emailbydomain.com>

Auto manuals search

<http://auto.somanuals.com>

TV manuals search

<http://tv.somanuals.com>