

Kramer Electronics, Ltd.



USER MANUAL

Models:

TP-45, Component/XGA – Audio Transmitter

TP-45RC, Component/UXGA – Audio Transmitter

TP-46, Component/XGA – Audio Receiver

Contents

1	Introduction	1
2	Getting Started	1
2.1	Quick Start	2
3	Overview	3
3.1	About the Power Connect Feature	4
3.2	Shielded Twisted Pair (STP) / Unshielded Twisted Pair (UTP)	5
3.3	Recommendations for Achieving the Best Performance	5
4	Your Component/XGA – Audio Transmitter and Receiver	6
4.1	Your TP-45 Component – S/PDIF Line Transmitter	6
4.2	Your TP-45RC Component – S/PDIF Line Transmitter	7
4.3	Your TP-46 Component/XGA – Audio Receiver	8
5	Connecting a Component/XGA – Audio Distribution System	10
5.1	Connecting the System in XGA Mode	11
5.2	Connecting the System in Component Video Mode	13
5.3	Connecting the TP-45RC Remote Control	16
5.4	Wiring the Twisted Pair LINE IN / LINE OUT RJ-45 Connectors	17
6	Technical Specifications	18

Figures

Figure 1:	TP-45 Component/XGA – Audio Transmitter	6
Figure 2:	TP-45 Component/XGA – Audio Transmitter (Underside)	7
Figure 3:	TP-45RC Component/XGA – Audio Transmitter	8
Figure 4:	TP-46 Component/XGA – Audio Receiver	9
Figure 5:	TP-46 Component/XGA – Audio Receiver (Underside)	10
Figure 6:	Component/XGA – Audio Distribution System, XGA Mode	13
Figure 7:	Component/XGA – Audio Distribution System, Component Video Mode	16
Figure 8:	The TP-45RC Remote Control Connection	16
Figure 9:	Twisted Pair PINOUT	17

Tables

Table 1:	TP-45 Component/XGA – Audio Transmitter Features	6
Table 2:	TP-45 Component/XGA – Audio Transmitter (Underside) Features	7
Table 3:	TP-45RC Component/XGA – Audio Transmitter Features	8
Table 4:	TP-46 Component/XGA – Audio Receiver Features	9
Table 5:	TP-46 Component/XGA – Audio Receiver (Underside) Features	10
Table 6:	Twisted Pair PINOUT	17
Table 7:	Technical Specifications of the TP-45/TP-45RC/TP-46	18

1 Introduction

Welcome to Kramer Electronics! Since 1981, Kramer Electronics has been providing a world of unique, creative, and affordable solutions to the vast range of problems that confront the video, audio, presentation, and broadcasting professional on a daily basis. In recent years, we have redesigned and upgraded most of our line, making the best even better! Our 1,000-plus different models now appear in 11 groups¹ that are clearly defined by function.

Thank you for purchasing the Kramer TOOLS **TP-45** *Component/XGA – Audio Transmitter*, Kramer TOOLS **TP-45RC**² *Component/UXGA – Audio Transmitter*, and Kramer TOOLS **TP-46** *Component/XGA – Audio Receiver*, that use existing twisted pair³ cabling to create an efficient, fast and uncluttered environment for:

- Presentation and multimedia applications
- Long-range graphics distribution for schools, hospitals, security, and stores
- Security and military applications

The package includes the following items:

- **TP-45** or **TP-45RC** and/or **TP-46**
- Power supply (12V DC)
- This user manual⁴

2 Getting Started

We recommend that you:

- Unpack the equipment carefully and save the original box and packaging materials for possible future shipment
- Review the contents of this user manual
- Use Kramer high performance high-resolution cables⁵

1 GROUP 1: Distribution Amplifiers; GROUP 2: Switchers and Matrix Switchers; GROUP 3: Control Systems; GROUP 4: Format/Standards Converters; GROUP 5: Range Extenders and Repeaters; GROUP 6: Specialty AV Products; GROUP 7: Scan Converters and Scalars; GROUP 8: Cables and Connectors; GROUP 9: Room Connectivity; GROUP 10: Accessories and Rack Adapters; GROUP 11: Sierra Products

2 On some products “R” may be printed instead of “RC” (that is, TP-45R instead of TP-45RC)

3 To determine which twisted pair cable is best for your application, see section [3.2](#)

4 Download up-to-date Kramer user manuals from our Web site at <http://www.kramerelectronics.com>

5 The complete list of Kramer cables is on our Web site at <http://www.kramerelectronics.com>



2.1 Quick Start

This quick start chart summarizes the basic setup and operation steps.

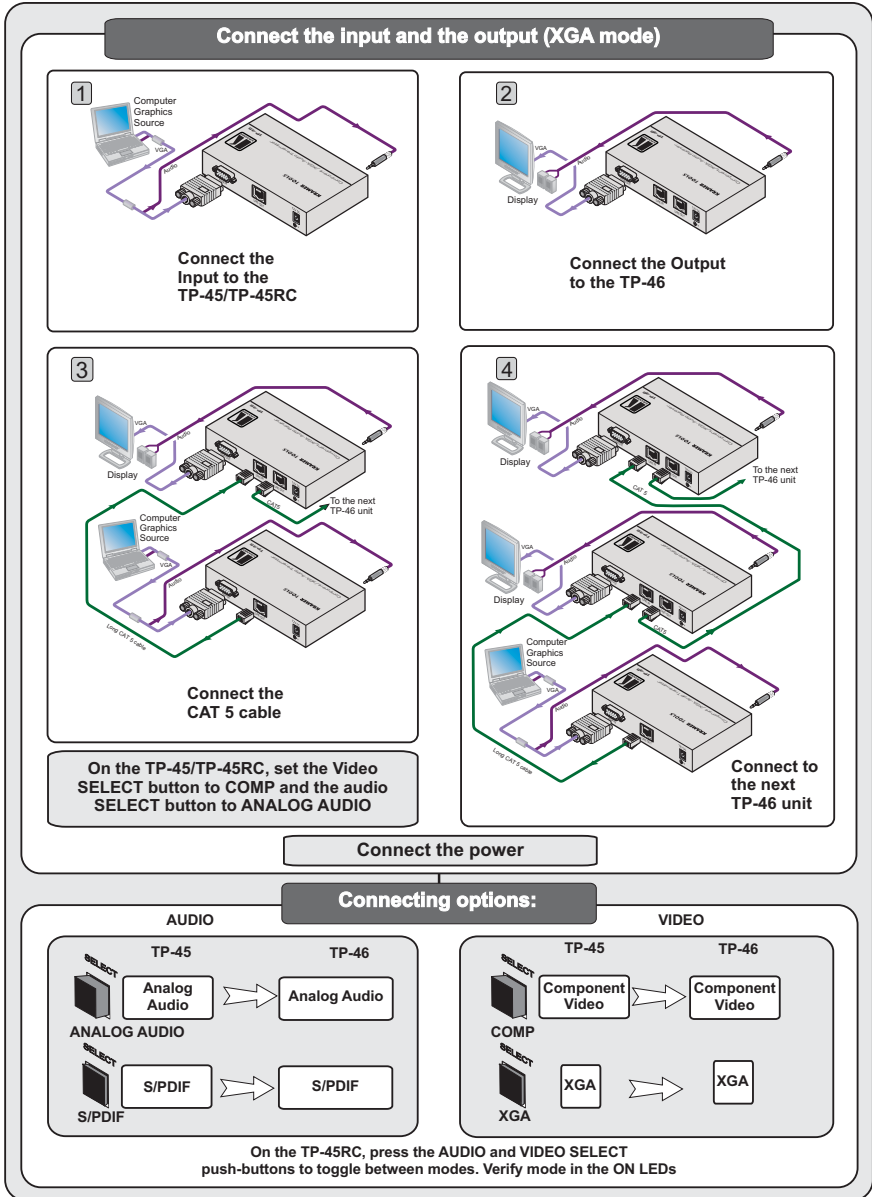

3 Overview

The **TP-45/TP-45RC** and **TP-46** are a twisted pair transmitter and receiver for component video (YUV) or computer graphics video and unbalanced stereo audio or S/PDIF audio signals. The **TP-45/TP-45RC** transmitter converts audio and video to a twisted pair signal and the **TP-46** converts the twisted pair signal back into audio and video signals.

The **TP-45** and **TP-45RC** have two SELECT buttons that let you choose the video signal input (XGA¹ or component) as well as the audio input (digital or analog signal). By selecting the required video input signal, the **TP-45** or **TP-45RC** with the **TP-46** can constitute either a component video (Y, CB/PB, CR/PR) or an XGA video – audio transmitter / receiver system²:

- If XGA is selected, the **TP-45** or **TP-45RC** receives an XGA signal³ and transmits it over the twisted pair cable to the XGA output on the **TP-46** receiver
- If component video is selected, the component video signal³ is transmitted over the twisted pair cable to the COMP outputs on the **TP-46** receiver
- The analog audio or S/PDIF (digital audio)—as selected via the audio SELECT button—is transmitted together with the video signal over the twisted pair cable to the **TP-46** receiver
- The **TP-45RC** can execute these control functions also remotely using simple pushbuttons

The audio signal is distributed simultaneously to the analog or digital audio outputs.

Additional **TP-46** units can be connected via the **TP-46** LINE OUT twisted pair connector, to extend the range of the output signals⁴.

The **TP-45** *Component/XGA – Audio Transmitter* features:

- Transmission range of more than 300ft (more than 100m)
- YUV⁵ input on 3 RCA connectors and a computer graphics input on a 15-pin HD (F) connector

¹ The term XGA used throughout this manual implies resolutions exceeding UXGA

² The TP-45/TP-45RC and TP-46 do not convert the video signal format. Thus computer graphics sources must be routed to computer graphics outputs. Similarly, component video sources must be routed to component video outputs

³ And audio signal

⁴ You can connect up to three additional TP-46 units, adding a total cable length of up to 300 meters. The video quality may be reduced if further units are connected

⁵ Also known as Y, Cb, Cr, or Y, B-Y, R-Y, or Y, Pb, Pr

- Digital audio input (S/PDIF) on an RCA connector and a stereo analog input on a 3.5mm mini jack
- The Power Connect feature where one unit can power the other over the same twisted pair cable (see section [3.1](#))
- 12V DC power

The **TP-45RC Component/UXGA – Audio Transmitter** features the same functions as the **TP-45** with the addition of:

- Toggling push-button selector switches and status LEDs connected by a remote selector input terminal block

The **TP-46 Component/XGA – Audio Receiver** features:

- YUV⁵ output on 3 RCA connectors and a computer graphics output on a 15-pin HD (F) connector
- Digital audio output (S/PDIF) on an RCA connector and a stereo analog output on a 3.5mm mini jack
- The Power Connect feature where one unit can power the other over the same twisted pair cable (see section [3.1](#))
- H and V Sync polarity switches for computer graphics
- EQ, and LEVEL controls
- A twisted pair output for transmitting the signal to an additional receiver
- 12V DC power

3.1 About the Power Connect Feature

The Power Connect feature applies as long as the cable can carry power. This feature is available when using STP cable and the distance does not exceed 50m on standard twisted pair cable. For longer distances, heavy gauge cable should be used¹. For units which are connected via RJ-45 connectors, make sure that the shield of the STP cable is connected to the metal casing of the connectors on both ends of the cable. For units which are connected via terminal block connectors, the shield of the STP cable must be connected to a ground terminal on the units at both ends (use the ground terminal of the power supply connection if necessary).

For a twisted pair cable exceeding a distance of 50m, separate power supplies should be connected to the transmitter and to the receiver simultaneously.

¹ CAT 5 cable is still suitable for the video/audio transmission, but not for feeding the power at these distances

3.2 Shielded Twisted Pair (STP) / Unshielded Twisted Pair (UTP)

We recommend that you use Shielded Twisted Pair (STP) cable. There are different levels of STP cable available, and we advise you to use the best quality STP cable that you can afford. Our non-skew-free cable, Kramer **BC-STP** is intended for analog signals where skewing is not an issue. For cases where there is skewing, our UTP skew-free cable, Kramer **BC-XTP**, may be used. Bear in mind, though, that we advise using STP cables where possible, since the compliance to electromagnetic interference was tested using those cables.

Although Unshielded Twisted Pair (UTP) cable might be preferred for long range applications, the UTP cable should be installed far away from electric cables, motors and so on, which are prone to create electrical interference. However, since the use of UTP cable might cause inconformity to electromagnetic standards, Kramer does not commit to meeting the standard with UTP cable.

3.3 Recommendations for Achieving the Best Performance

To achieve the best performance:

- Use only good quality connection cables¹ to avoid interference, deterioration in signal quality due to poor matching, and elevated noise levels (often associated with low quality cables).
- Avoid interference from neighboring electrical appliances that may adversely influence signal quality and position your Kramer products away from moisture, excessive sunlight and dust

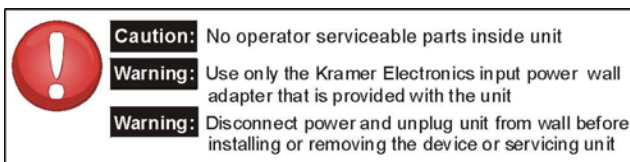

¹ Available from Kramer Electronics on our Web site at <http://www.kramerelectronics.com>

4 Your Component/XGA – Audio Transmitter and Receiver

This section describes the:

- **TP-45** *Component/XGA – Audio Transmitter*, see section [4.1](#)
- **TP-45RC** *Component/UXGA – Audio Transmitter*, see section [4.2](#)
- **TP-46** *Component/XGA – Audio Receiver*, see section [4.3](#)

4.1 Your TP-45 Component – S/PDIF Line Transmitter

[Figure 1](#) and [Table 1](#) define the **TP-45**:

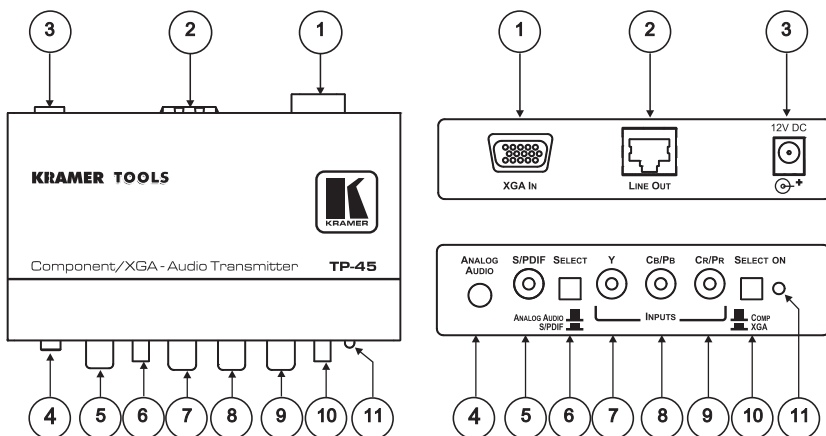

Figure 1: TP-45 Component/XGA – Audio Transmitter

Table 1: TP-45 Component/XGA – Audio Transmitter Features

#	Feature	Function	
1	XGA IN 15-pin HD (F) Connector	Connect to the XGA source	
2	LINE OUT RJ-45 Connector	Connect to the <i>LINE IN</i> connector on the TP-46 ¹	
3	12V DC	+12V DC connector for powering the unit	
4	ANALOG AUDIO 3.5mm Mini Connector	Connect to the stereo analog audio source	
5	S/PDIF RCA Connector	Connect to the digital audio source	
6	SELECT Audio Input Selector Button	ANALOG AUDIO	Release to transmit analog audio
		S/PDIF	Press to transmit digital audio
7	INPUTS	Y RCA Connector	Connect to the component video source
		Cb/Pb RCA Connector	
		Cr/Pr RCA Connector	
10	SELECT Video Input Selector Button	COMP	Release to transmit component video
		XGA	Press to transmit XGA
11	ON LED	Lights when receiving power	

¹ Using a straight pin to pin UTP cable with RJ-45 connectors at both ends (the PINOUT is defined in [Table 6](#) and [Figure 9](#))

[Figure 2](#) and [Table 2](#) define the underside of the **TP-45**:

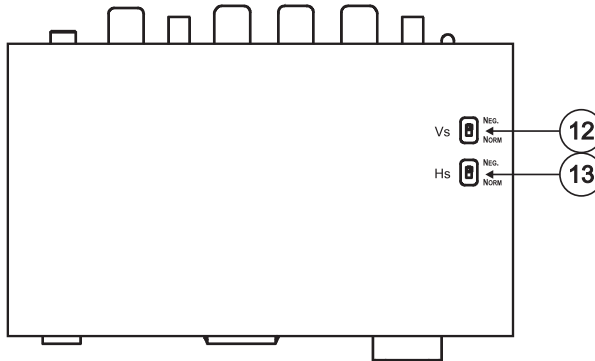

Figure 2: TP-45 Component/XGA – Audio Transmitter (Underside)

Table 2: TP-45 Component/XGA – Audio Transmitter (Underside) Features

#	Feature	Function
12	VS Switch	Slide the switch up ¹ (to NEG.) to change the VS polarity to negative polarity; slide the switch down (to NORM) to retain the polarity
13	HS Switch	Slide the switch up ¹ (to NEG.) to change the HS polarity to negative polarity; slide the switch down (to NORM) to retain the polarity

4.2 Your TP-45RC Component – S/PDIF Line Transmitter

[Figure 3](#) and [Table 3](#) define the **TP-45RC**:

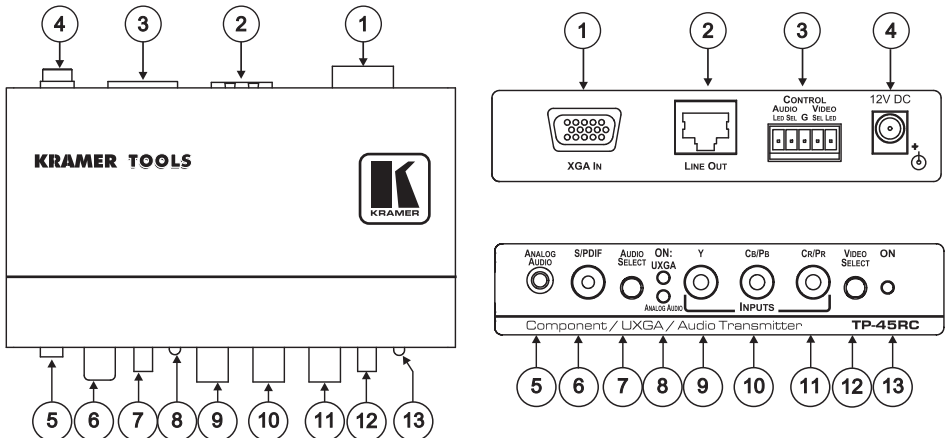

Figure 3: TP-45RC Component/XGA – Audio Transmitter

¹ By default, both switches are set to NORM

Table 3: TP-45RC Component/XGA – Audio Transmitter Features

#	Feature		Function
1	XGA IN 15-pin HD (F) Connector		Connect to the XGA source
2	LINE OUT RJ-45 Connector		Connect to the LINE IN connector on the TP-46 ¹
3	CONTROL AUDIO/VIDEO Terminal Block		Connect to remote push-button switches and status LEDs
4	12V DC		+12V DC connector for powering the unit
5	ANALOG AUDIO 3.5mm Mini Connector		Connect to the stereo analog audio source
6	S/PDIF RCA Connector		Connect to the digital audio source
7	AUDIO SELECT Input Selector Button	ANALOG AUDIO	Press to toggle between analog audio and digital S/PDIF audio
		S/PDIF	
8	ON LEDs	UXGA	Lights when computer graphics video is selected
		ANALOG AUDIO	Lights when analog audio is selected
9	INPUTS	Y RCA Connector	Connect to the component video source
10		Cb/Pb RCA Connector	
11		Cr/Pr RCA Connector	
12	VIDEO SELECT Input Button	COMP	Press to toggle between component video and computer graphics video
		XGA	
13	ON LED		Lights when receiving power

4.3 Your TP-46 Component/XGA – Audio Receiver

Figure 4 and Table 4 define the TP-46:

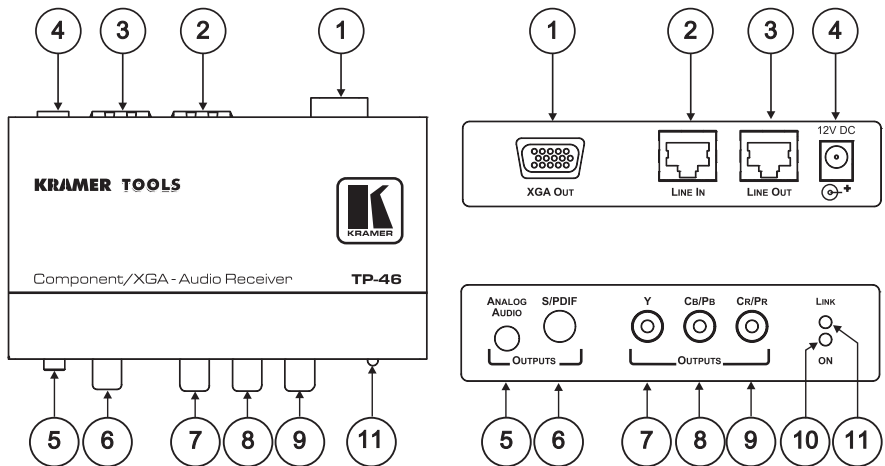

Figure 4: TP-46 Component/XGA – Audio Receiver

¹ Using a straight pin to pin UTP cable with RJ-45 connectors at both ends (the PINOUT is defined in Table 6 and Figure 9)

Table 4: TP-46 Component/XGA – Audio Receiver Features

#	Feature	Function
1	XGA OUT 15-pin HD (F) Connector	Connect to the XGA acceptor
2	LINE IN RJ-45 Connector	Connect to the <i>LINE OUT</i> RJ-45 connector on the TP-45 ¹
3	LINE OUT RJ-45 Connector	Connect to the <i>LINE IN</i> connector on an additional TP-46 ¹
4	12V DC	+12V DC connector for powering the unit
5	OUTPUTS	ANALOG AUDIO 3.5mm Mini Connector
6		S/PDIF RCA Connector
7		Y RCA Connector
8		CB/PB RCA Connector
9		CR/PR RCA Connector
10	LINK LED	Lights when receiving the correct input signal
11	ON LED	Lights when receiving power

Figure 5 and Table 5 define the underside of the **TP-46**:

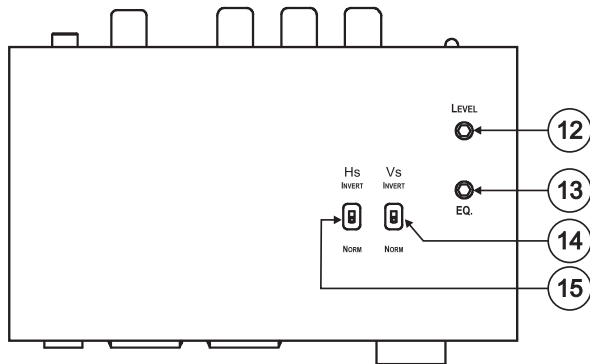

Figure 5: TP-46 Component/XGA – Audio Receiver (Underside)

Table 5: TP-46 Component/XGA – Audio Receiver (Underside) Features

#	Feature	Function
12	LEVEL Trimmer	Adjusts ² the output signal level
13	EQ. ³ Trimmer	Adjusts ¹ the cable compensation equalization level
14	VS Switch	Slide the switch down (to NORM) to retain the polarity Slide the switch up ⁴ (to INVERT) to invert the VS polarity
15	HS Switch	Slide the switch down (to NORM) to retain the polarity Slide the switch up ¹ (to INVERT) to invert the HS polarity

1 Using a UTP cable with CAT 5 connectors at both ends (the PINOUT is defined in Table 6 and Figure 9)

2 Use a screwdriver to carefully rotate the trimmer, adjusting the appropriate level

3 Degradation and VGA/XGA signal loss can result from using long cables (due to the effects of stray capacitance, for example), sometimes leading to a loss of sharpness in high-resolution signals

4 By default, both switches are set to NORM

5 Connecting a Component/XGA – Audio Distribution System

The Component/XGA – Audio Distribution System can be configured to operate in one of two **video** modes:

- In the XGA mode, a computer graphics source is connected to the input and transmitted to a display connected to the receiver (see section [5.1](#))
- In the component video mode, a component video source is connected to the input and transmitted to a TV set connected to the receiver (see section [5.2](#))

The Component/XGA – Audio Distribution System can be configured to operate in one of two **audio** modes:

- In the analog mode, an analog audio source is connected to the input and transmitted to an acceptor connected to the receiver (see section [5.1](#))
- In the digital audio mode, an S/PDIF audio source is connected to the input and transmitted to a digital acceptor connected to the receiver (see section [5.2](#))

Thus, there are four possible system configurations: computer graphics/analog audio, computer graphics/digital audio, component video/analog audio, and component video/digital audio.

The modes of the system are determined by setting the VIDEO SELECT and AUDIO SELECT switches on the **TP-45** or **TP-45RC**. Whatever modes are set at the transmitter the video and audio signals are sent to the receiver and any additional cascaded receivers¹.

¹ There is no signal conversion; a component input cannot be sent to a computer graphics output, nor can a digital audio input be sent to an analog audio output

5.1 Connecting the System in XGA Mode

To configure a **TP-45/TP-45RC** and **TP-46** Component/XGA – Audio distribution system¹ in the XGA mode, as illustrated in the example in [Figure 6](#), do the following:

1. On the **TP-45** or **TP-45RC**, connect the following:
 - An XGA source (for example, the graphics card on a laptop) to the XGA 15-pin HD (F) connector
 - An analog audio source to the ANALOG AUDIO 3.5mm mini jack², for example, using a Kramer C-GMA/GMA cable (VGA 15-pin HD (M) with audio jack to VGA 15-pin HD (M) with audio jack)³
2. If necessary, set the HS and VS switches on the **TP-45** underside⁴.
3. On the **TP-45**, use the SELECT buttons as follows:
 - Press the video SELECT button to choose the XGA input
 - Press the audio SELECT button to choose S/PDIF
 - Release the audio SELECT button to choose analog audio
4. On the **TP-45RC**, use the SELECT buttons as follows:
 - Momentarily press the video SELECT button. The UXGA LED lights when the UXGA input is selected
 - Momentarily press the AUDIO SELECT button to toggle between the S/PDIF⁵ and analog audio inputs
5. On the **TP-46**, connect the following:
 - The XGA OUT 15-pin HD (F) connector to the XGA acceptor (for example, a display)
 - The ANALOG AUDIO 3.5mm mini jack⁶ to the analog audio acceptor (for example, speakers)
6. Connect the LINE OUTPUT RJ-45 connector on the **TP-45** to the LINE IN RJ-45 connector on the **TP-46**, via twisted pair cabling, see section [5.4](#).

1 Using up to 300ft (100m) of UTP cabling

2 Or you can connect a digital audio source to the S/PDIF RCA connector

3 Not supplied. The complete list of Kramer cables is on our Web site at <http://www.kramerelectronics.com>

4 By default, both switches are set down (for normal V SYNC and H SYNC polarity)

5 The analog audio LED lights when analog audio is selected

6 Alternatively, you can connect a digital audio acceptor to the S/PDIF RCA connector, or you can connect both

7. Connect the 12V DC power adapter to the power socket and connect the adapter to the mains electricity on both¹ the **TP-45** and the **TP-46** (not shown in [Figure 6](#)).
The signal from the XGA source is transmitted via twisted pair cable, decoded and converted at the XGA OUT 15-pin HD (F) connector to the XGA acceptor.
8. If required, connect the LINE OUT RJ-45 connector on the **TP-46** to an additional **TP-46**.
9. On the **TP-46** underside:
 - Adjust² the video output signal level and/or cable compensation equalization level, if required
 - If necessary, set the HS and VS switches³ on the underside

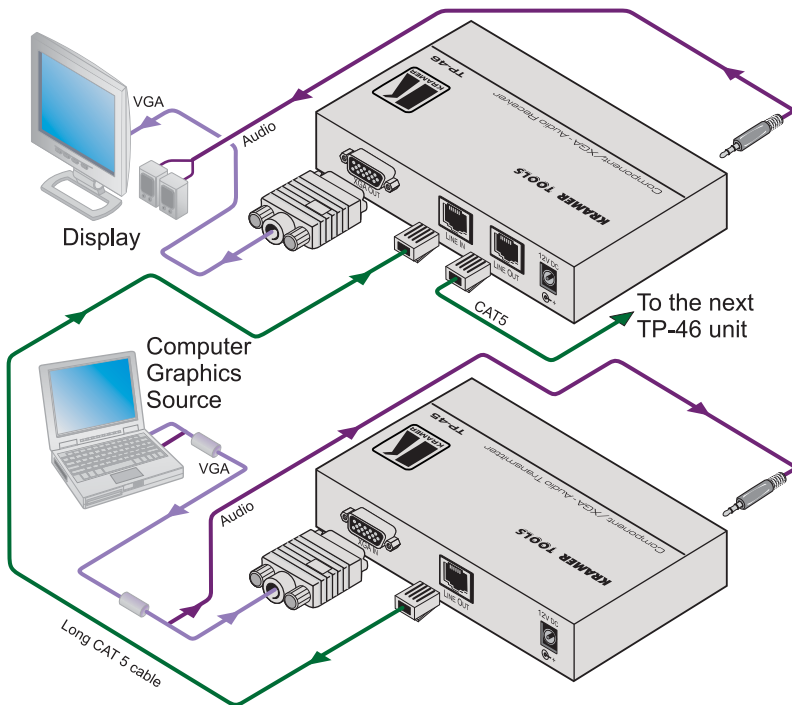

Figure 6: Component/XGA – Audio Distribution System, XGA Mode

1 If you cannot connect the power to both the TP-45 and TP-46, you can just connect the power to the TP-46

2 Use a screwdriver to carefully rotate the trimmer, adjusting the appropriate level

3 By default, both switches are set down (for normal V SYNC and H SYNC polarity)

5.2 Connecting the System in Component Video Mode

To configure a **TP-45/ TP-45RC/TP-46** Component/XGA – Audio distribution system¹ in the component video mode, as the example in [Figure 7](#) illustrates, do the following:

1. On the **TP-45** or **TP-45RC**, connect the following:
 - A component video source (for example, a DVD player) to the Y, Cb/Pb, Cr/Pr RCA connectors
 - A digital audio source to the S/PDIF RCA connector²
2. If necessary, set the HS and VS switches³, on the **TP-45** underside.
3. On the **TP-45**, use the SELECT buttons as follows:
 - Release the video SELECT button to choose the component video input
 - Press the audio SELECT button to choose S/PDIF
 - Release the audio SELECT button to choose analog audio
4. On the **TP-45RC**, use the SELECT buttons as follows:
 - Momentarily press the VIDEO SELECT button. The UXGA LED turns off when the component video input is selected
 - Momentarily press the AUDIO SELECT button to toggle between the S/PDIF⁴ and analog audio inputs
5. On the **TP-46**, connect the following:
 - The Y, CB/PB, CR/PR RCA connectors to a component video acceptor (for example, a plasma display)
 - The S/PDIF RCA connector⁵ to the digital audio acceptor (for example, the audio input on the plasma display)
6. Connect the LINE OUTPUT RJ-45 connector on the **TP-45/TP-45RC** to the LINE IN RJ-45 connector on the **TP-46**, via twisted pair cabling, see section [5.4](#).
7. Connect the 12V DC power adapter to the power socket and connect the adapter to the mains electricity on both⁶ the **TP-45/TP-45RC** and the

1 Using up to 300ft (100m) of UTP cabling

2 Alternatively, you can connect an analog audio source

3 By default, both switches are set down (for normal V SYNC and H SYNC polarity)

4 The analog audio LED lights when analog audio is selected

5 Alternatively, you can connect an analog audio acceptor, or you can connect both

6 If you cannot connect the power to both the TP-45 and TP-46, connect it to the TP-46 only. If more than one TP-46 is connected, connect the power to each TP-46 unit

TP-46 (not shown in [Figure 7](#)).

The signal from the component video source is transmitted via the twisted pair cable; decoded and converted to component video and outputted on the Y, CB/PB, CR/PR OUTPUTS RCA connectors to the component video acceptor.

8. Connect the LINE OUT RJ-45 connector on the **TP-46** to a second **TP-46** unit¹ (optional).
9. Similarly, you can connect the LINE OUT RJ-45 connector on the **TP-46** to additional **TP-46** units.
10. On the **TP-46** underside:
 - If required, adjust² the video output signal level and/or cable compensation equalization level³
 - If necessary, set the HS and VS switches⁴, on the underside

1 Connect the required outputs to the second TP-46

2 Use a screwdriver to carefully rotate the trimmer, adjusting the appropriate level

3 If more than one TP-46 unit is connected, adjust the level and cable compensation in sequence from the first TP-46 unit (that is connected directly to the TP-45) to the next and so on

4 By default, both switches are set down (for normal V SYNC and H SYNC polarity)

Connecting a Component/XGA – Audio Distribution System

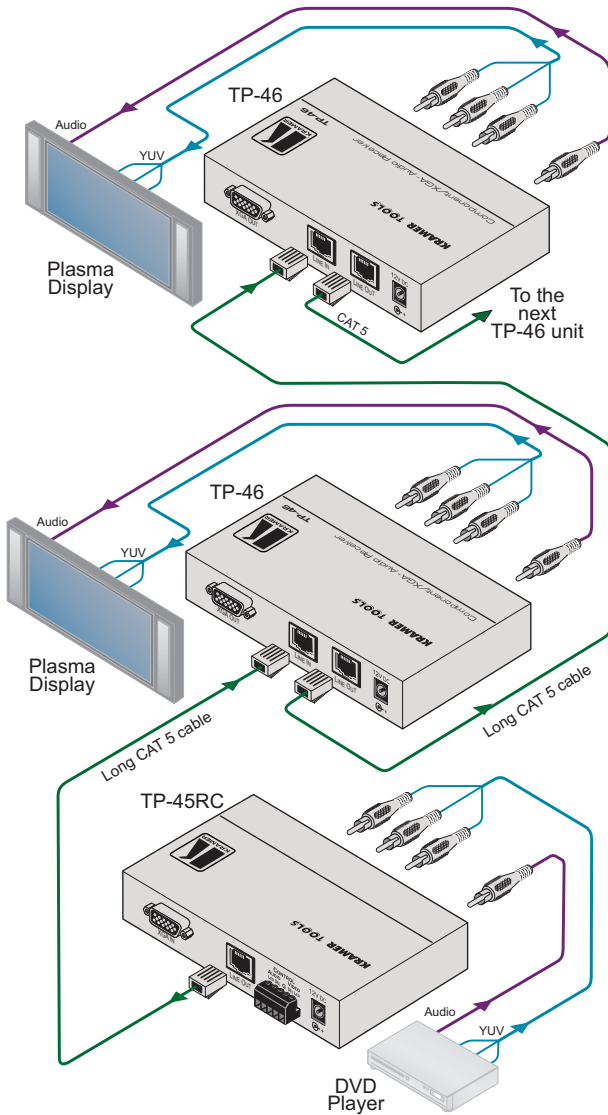

Figure 7: Component/XGA – Audio Distribution System, Component Video Mode

5.3 Connecting the TP-45RC Remote Control

Connect momentary push-buttons and LEDs¹ to a cable and attach the cable to a 5-pin terminal block for connection to the **TP-45RC** control port as shown in [Figure 8](#).

Each press of the selector button toggles the audio or video system mode and turns on or off the remote and panel status LEDs according to the active mode.

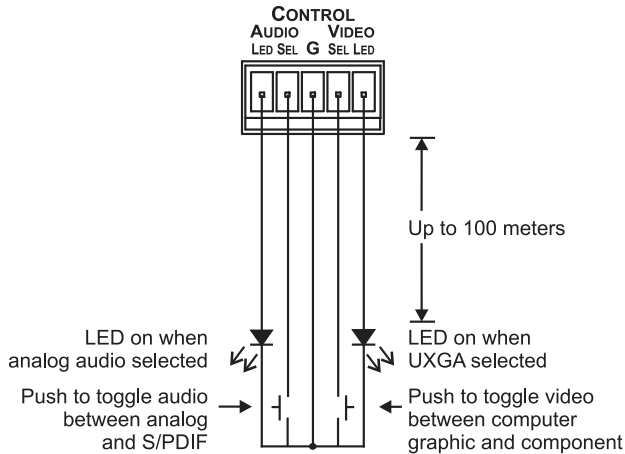

Figure 8: The TP-45RC Remote Control Connection

¹ Each LED is driven by a 5V source and a 392Ω series resistor

5.4 Wiring the Twisted Pair LINE IN / LINE OUT RJ-45 Connectors

[Table 6](#) and [Figure 9](#) define the twisted pair pinout, using a straight pin-to-pin cable with RJ-45 connectors:

Table 6: Twisted Pair PINOUT

EIA /TIA 568A		EIA /TIA 568B	
PIN	Wire Color	PIN	Wire Color
1	Green / White	1	Orange / White
2	Green	2	Orange
3	Orange / White	3	Green / White
4	Blue	4	Blue
5	Blue / White	5	Blue / White
6	Orange	6	Green
7	Brown / White	7	Brown / White
8	Brown	8	Brown
Pair 1		Pair 1	
Pair 1	4 and 5	Pair 1	4 and 5
Pair 2		Pair 2	
Pair 2	3 and 6	Pair 2	1 and 2
Pair 3		Pair 3	
Pair 3	1 and 2	Pair 3	3 and 6
Pair 4		Pair 4	
Pair 4	7 and 8	Pair 4	7 and 8

Figure 9: Twisted Pair PINOUT

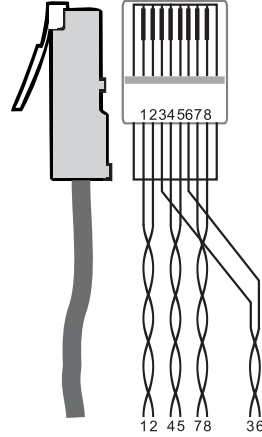

6 Technical Specifications

Table 7 defines the technical specifications¹:

Table 7: Technical Specifications² of the TP-45/TP-45RC/TP-46

VIDEO Specifications	
INPUTS:	TP-45/RC 1 VGA/UXGA 1Vpp/75Ω on a 15-pin HD connector 1 component 1Vpp/75Ω (YPbPr) on 3 RCA connectors TP-46 1 twisted pair line In on an RJ-45 connector (video/audio)
OUTPUTS:	TP-45/RC 1 twisted pair line Out on an RJ-45 connector (video/audio) TP-46 1 twisted pair line Extension on an RJ-45 connector (video/audio) 1 VGA/UXGA 1Vpp/75Ω on a 15-pin HD connector 1 component 1Vpp/75Ω (YPbPr) on 3 RCA connectors
MAX. INPUT LEVEL:	VGA: 1.2Vpp on 75Ω, DC coupling YPbPr: 1.05Vpp on 75Ω, AC coupling
RETURN LOSS:	-18dB
MAX. OUTPUT LEVEL:	VGA: 1.5Vpp on 75Ω, DC coupling YPbPr: 1.25Vpp on 75Ω, DC coupling
VIDEO RESOLUTION:	Up to UXGA; 1080p
S/N RATIO:	61dB RMS unweighted
K-FACTOR:	0.2%
ISOLATION (CROSSTALK):	-43dB @ 5MHz
AUDIO Specifications	
INPUTS:	TP-45/RC 1 Stereo analog audio, 0dBu/50kΩ, 0.5V/75Ω, on a 3.5mm jack 1 digital S/PDIF audio on an RCA connector
OUTPUTS:	TP-46 1 Stereo analog audio, 0dBu/1kΩ, 0.5V/75Ω, on a 3.5mm jack 1 digital S/PDIF audio on an RCA connector
MAX. AUDIO INPUT LEVEL ANALOG:	4dBu on 50kΩ, AC coupling
MAX. AUDIO OUTPUT LEVEL ANALOG:	4dBu on 1kΩ, DC coupling
AUDIO BANDWIDTH:	20Hz to 20kHz, @0dBu
TND+NOISE:	0.33% @0dBu @1kHz
SAMPLE RATE CONVERSION:	48kHz
RESOLUTION CONVERSION:	24 bits
POWER SOURCE:	TP-45/RC 12V DC, 140mA TP-46: 12V DC, 280mA
DIMENSIONS:	12 cm x 7.15 cm x 2.76 cm (4.7" x 2.81" 1.09", W, D, H)
WEIGHT:	0.3 kg (0.67 lbs.) approx
ACCESSORIES:	Power supply
OPTIONS:	RK-3T 19" rack adapter

1 Specifications for 100m of CAT 5 UTP cable, unless otherwise specified

2 Specifications are subject to change without notice

LIMITED WARRANTY

Kramer Electronics (hereafter *Kramer*) warrants this product free from defects in material and workmanship under the following terms.

HOW LONG IS THE WARRANTY

Labor and parts are warranted for seven years from the date of the first customer purchase.

WHO IS PROTECTED?

Only the first purchase customer may enforce this warranty.

WHAT IS COVERED AND WHAT IS NOT COVERED

Except as below, this warranty covers all defects in material or workmanship in this product. The following are not covered by the warranty:

1. Any product which is not distributed by Kramer, or which is not purchased from an authorized Kramer dealer. If you are uncertain as to whether a dealer is authorized, please contact Kramer at one of the agents listed in the Web site www.kramerelectronics.com.
2. Any product, on which the serial number has been defaced, modified or removed, or on which the WARRANTY VOID IF TAMPERED sticker has been torn, reattached, removed or otherwise interfered with.
3. Damage, deterioration or malfunction resulting from:
 - i) Accident, misuse, abuse, neglect, fire, water, lightning or other acts of nature
 - ii) Product modification, or failure to follow instructions supplied with the product
 - iii) Repair or attempted repair by anyone not authorized by Kramer
 - iv) Any shipment of the product (claims must be presented to the carrier)
 - v) Removal or installation of the product
 - vi) Any other cause, which does not relate to a product defect
 - vii) Cartons, equipment enclosures, cables or accessories used in conjunction with the product

WHAT WE WILL PAY FOR AND WHAT WE WILL NOT PAY FOR

We will pay labor and material expenses for covered items. We will not pay for the following:

1. Removal or installations charges.
2. Costs of initial technical adjustments (set-up), including adjustment of user controls or programming. These costs are the responsibility of the Kramer dealer from whom the product was purchased.
3. Shipping charges.

HOW YOU CAN GET WARRANTY SERVICE

1. To obtain service on you product, you must take or ship it prepaid to any authorized Kramer service center.
2. Whenever warranty service is required, the original dated invoice (or a copy) must be presented as proof of warranty coverage, and should be included in any shipment of the product. Please also include in any mailing a contact name, company, address, and a description of the problem(s).
3. For the name of the nearest Kramer authorized service center, consult your authorized dealer.

LIMITATION OF IMPLIED WARRANTIES

All implied warranties, including warranties of merchantability and fitness for a particular purpose, are limited in duration to the length of this warranty.

EXCLUSION OF DAMAGES

The liability of Kramer for any effective products is limited to the repair or replacement of the product at our option. Kramer shall not be liable for:

1. Damage to other property caused by defects in this product, damages based upon inconvenience, loss of use of the product, loss of time, commercial loss; or:
2. Any other damages, whether incidental, consequential or otherwise. Some countries may not allow limitations on how long an implied warranty lasts and/or do not allow the exclusion or limitation of incidental or consequential damages, so the above limitations and exclusions may not apply to you.

This warranty gives you specific legal rights, and you may also have other rights, which vary from place to place.

NOTE: All products returned to Kramer for service must have prior approval. This may be obtained from your dealer.

This equipment has been tested to determine compliance with the requirements of:

- EN-50081: "Electromagnetic compatibility (EMC);
generic emission standard.
Part 1: Residential, commercial and light industry"
- EN-50082: "Electromagnetic compatibility (EMC) generic immunity standard.
Part 1: Residential, commercial and light industry environment".
- CFR-47: FCC* Rules and Regulations:
Part 15: "Radio frequency devices
Subpart B Unintentional radiators"

CAUTION!

- Servicing the machines can only be done by an authorized Kramer technician. Any user who makes changes or modifications to the unit without the expressed approval of the manufacturer will void user authority to operate the equipment.
- Use the supplied DC power supply to feed power to the machine.
- Please use recommended interconnection cables to connect the machine to other components.
* FCC and CE approved using STP cable (for twisted pair products)



For the latest information on our products and a list of Kramer distributors, visit our Web site: www.kramerelectronics.com, where updates to this user manual may be found. We welcome your questions, comments and feedback.



Caution

Safety Warning:

Disconnect the unit from the power supply before opening/servicing.



PN:



2900-000424

Rev:



3

Kramer Electronics, Ltd.

Web site: www.kramerelectronics.com

E-mail: info@kramerelect.com

P/N: 2900-000424 REV 3

Free Manuals Download Website

<http://myh66.com>

<http://usermanuals.us>

<http://www.somanuals.com>

<http://www.4manuals.cc>

<http://www.manual-lib.com>

<http://www.404manual.com>

<http://www.luxmanual.com>

<http://aubethermostatmanual.com>

Golf course search by state

<http://golfingnear.com>

Email search by domain

<http://emailbydomain.com>

Auto manuals search

<http://auto.somanuals.com>

TV manuals search

<http://tv.somanuals.com>