

Kramer Electronics, Ltd.



USER MANUAL

Models:

VP-720DS, *Seamless Switcher / Scaler*

VP-723DS, *Seamless Switcher / Scaler*

Contents

1	Introduction	1
2	Getting Started	1
3	Overview	1
4	Your Seamless Switcher / Scaler	3
5	Connecting the Seamless Switcher / Scaler	8
5.1	Connecting a PC	9
6	Understanding the Seamless Switcher / Scaler	11
6.1	Understanding the OUT Button Functionality	11
6.2	Understanding the PIP Button Feature	13
6.2.1	Activating the PIP Feature	13
6.2.2	PIP Characteristics	14
6.2.3	Toggleing between the PIP and the Screen Source (SWAP)	14
6.2.4	Resizing the PIP	15
6.2.5	Moving the Position of the PIP	15
6.3	Locking and Unlocking the Front Panel	15
7	Operating the Seamless Switcher / Scaler	16
7.1	Switching and Scaling	16
7.1.1	Switching an Input	16
7.1.2	Choosing the Output Resolution	17
7.2	Controlling the Seamless Switcher / Scaler	17
7.3	Operating via the OSD MENU Screen	17
7.3.1	Controlling the Brightness and Contrast	18
7.3.2	Controlling the Gamma and Color	19
7.3.3	Selecting the Source	20
7.3.4	Controlling the Scale Geometry	20
7.3.5	Adjusting the Zoom Ratio and Position	22
7.3.5.1	Adjusting the Zoom Ratio	23
7.3.5.2	Adjusting the Zoom Position	24
7.3.6	Configuring via the Utility Screens	25
7.3.6.1	Choosing the Graphic Utility Settings	25
7.3.6.2	Choosing the Video Utility Settings	26
7.3.6.3	Choosing the Audio Utility Settings	27
7.3.6.4	Choosing the PIP Utility Settings	28
7.3.6.5	Choosing the Seamless Switch Utility Settings	29
7.3.6.6	Choosing the OSD Utility Settings	30
7.3.6.7	Choosing the Output Utility Settings	31
7.3.6.8	Choosing Factory Reset	32
7.3.7	Verifying Configuration Details via the Information Screen	33

7.3.8	Operating via the Infra-red Remote Control Transmitter	33
7.4	Upgrading Firmware	36
8	Technical Specifications	36
9	Communication Protocol	37

Figures

Figure 1:	Front Panels of the VP-720DS and VP-723DS, and their Rear Panel	4
Figure 2:	Connecting the PC	9
Figure 3:	Connecting the VP-720DS / VP-723DS Rear Panel	10
Figure 4:	OUT LED Sequence	12
Figure 5:	OSD PIP Status	14
Figure 6:	OSD SWAP Status	14
Figure 7:	Locking / Unlocking the Front Panel	15
Figure 8:	OSD Input Status	16
Figure 9:	OSD Output Status	17
Figure 10:	MENU Screen	18
Figure 11:	Menu Screen Icons	18
Figure 12:	Brightness and Contrast Screen	18
Figure 13:	Gamma and Color Screen	19
Figure 14:	Gamma, Color Temperature/Manager User 1/2 Screen	19
Figure 15:	Source Selection Screen	20
Figure 16:	Geometry (Scale and Zoom) Screen	20
Figure 17:	Geometry (Scale: Aspect Ratio and Nonlinear) Screen	21
Figure 18:	Geometry (Scale: Aspect Ratio) Screen	21
Figure 19:	Geometry (Zoom) Screen	22
Figure 20:	OSD Enlarge Status	22
Figure 21:	Zoom Ratio Adjustment Example	23
Figure 22:	Zoom Position Adjustment Example	23
Figure 23:	Geometry (Zoom Ratio) Screen	23
Figure 24:	Preset Position Control Keys	24
Figure 25:	Navigation Control Keys	24
Figure 26:	Geometry (Zoom Position Adjustment) Screen	24
Figure 27:	Utility Screen	25
Figure 28:	Graphic Setting Utility Screen	25
Figure 29:	Graphic Setting Color Format Utility Screen	26
Figure 30:	Video Setting Utility Screen	26
Figure 31:	Video Setting Standard Utility Screen	27
Figure 32:	Audio Setting Utility Screen	27
Figure 33:	Audio Setting Stereo Utility Screen	27
Figure 34:	PIP Utility Screen	28
Figure 35:	PIP Activation Utility Screen	28
Figure 36:	PIP Source Utility Screen	28
Figure 37:	PIP Size Utility Screen	29

Figure 38: Seamless Switch Utility Screen	29
Figure 39: OSD Setting Utility Screen	30
Figure 40: OSD Size Utility Screen	30
Figure 41: OSD Source Prompt Activation Utility Screen	30
Figure 42: OSD Blank Color Utility Screen	31
Figure 43: Output Setting Utility Screen	31
Figure 44: Output Setting Resolution Utility Screen	31
Figure 45: Output Setting Refresh Rate Utility Screen	32
Figure 46: Output Setting User Mode Setting Utility Screen	32
Figure 47: Factory Reset Utility Screen	33
Figure 48: Information Screen	33
Figure 49: Infra-red Remote Control Transmitter	34

Tables

Table 1: Front Panel VP-720DS and VP-723DS, Seamless Switcher / Scaler Features	5
Table 2: Rear Panel VP-720DS and VP-723DS, Seamless Switcher / Scaler Features	7
Table 3: Selecting the Output Resolution	11
Table 4: User Mode Setting Definitions	32
Table 5: Infra-red Remote Control Transmitter Functions	35
Table 6: Technical Specifications of the VP-720DS/VP-723DS	36
Table 7: RS-232 Protocol	37
Table 8: RS-232 Communication Code	37
Table 9: RS-232 Read Command	39

1 Introduction

Dedication by Kramer Electronics since 1981, to the development and manufacture of high quality video/audio equipment, makes the Kramer line an integral part of the finest production and presentation facilities in the world. In recent years, Kramer has redesigned and upgraded most of the line, making the best even better! The Kramer line of professional video/audio electronics is one of the most versatile and complete available, and is a true leader in terms of quality, workmanship, price/performance ratio and innovation. In addition to our high quality Kramer seamless switcher / scaler, we also offer excellent switchers and matrices, as well as distribution amplifiers, remote controllers, processors, interfaces and computer-related products.

Congratulations on purchasing your Kramer **VP-720DS** *Seamless Switcher / Scaler* and/or **VP-723DS** *Seamless Switcher / Scaler*, which are ideal for the following typical applications:

- Presentation and conference room systems
- Production studios, rental and staging

The **VP-720DS** and/or the **VP-723DS** package includes the following items:

- Seamless Switcher / Scaler
- Power cord, Infra-red remote control transmitter and Null-modem adapter
- This user manual¹ and the Kramer concise product catalog/CD

2 Getting Started

We recommend that you:

- Unpack the equipment carefully and save the original box and packaging materials for possible future shipment
- Review the contents of this user manual
- Use Kramer high performance high resolution cables²

3 Overview

The **VP-720DS** and **VP-723DS** are *Seamless Switchers / Scalers* designed for a wide variety of presentation and multimedia applications. They are true multi-standard video to RGBHV (pixel) scalars that convert composite video,

¹ Download up-to-date Kramer user manuals from the Internet at this URL: <http://www.kramerelectronics.com/manuals.html>

² The complete list of Kramer cables is on our Web site at <http://www.kramerelectronics.com> (click "Cables and Connectors" in the Products section)

s-Video, component video, VGA/SVGA/XGA/UXGA, and DVI signals to the following user-selectable pixel rates:

- VGA (640x480)
- SVGA (800x600)
- XGA (1024x768)
- SXGA (1280x1024)
- UXGA (1600x1200)
- 852x1024
- 1024x1024
- 1366x768
- 1365x1024¹
- 1280x720¹
- 720x483¹
- 852x480¹
- 1400x1050¹
- A user definable output mode²

The **VP-723DS** has 3 additional output modes used for high definition television (HDTV): 480p, 720p, and 1080i. Both the **VP-720DS** and **VP-723DS** are 7-input seamless presentation switchers, that:

- Digitally reprocess the signal to correct mastering errors, and regenerate the video at a chosen line and pixel rate format, providing, for example, native-resolution video for LCD, DLP and Plasma displays
- Facilitate scaling of any graphics resolution to any other resolution³
- Incorporate a unique graphics-scaling engine with image enhancement algorithms, which are built into the firmware
- Are specifically designed to improve video quality by reducing chroma noise
- Include a built-in Picture-in-Picture inserter⁴, letting you insert a video source into a graphics background or vice versa, allowing the user to size and position the shrunken inserted image anywhere on the screen
- Scale and zoom (to up to 400% of the original size)

In addition, both the **VP-720DS** and **VP-723DS**:

- Switch in true audio-follow-video mode

¹ Not shown on the front panel

² Recommended for advanced users only – non-standard settings may not be recognized by the display device

³ For example, scaling a VGA input to an UXGA output, or an SXGA input to an SVGA output

⁴ See section 6.2

- Include an OSD (on-screen display) for making the adjustments that can be located anywhere on the screen, and can be doubled in size. The OSD can be used to deactivate the source prompt, choose the color of the blank screen, and choose from three seamless switching image transition speeds
- Include seven multi-functional input buttons that cycle between selecting a source, freezing that source, or deactivating that source (and displaying a blank screen)
- Include a front panel lock
- Incorporate full ProcAmp¹ processing for video and audio correction
- Offer high quality de-interlacing 3:2/2:2 pull down²
- Can provide non-linear scaling for 4:3, 16:9 transformation³
- Support firmware upgrade via RS-232
- Include non-volatile memory that retains the last setting, after switching the power off and then on again

Control the **VP-720DS** and/or **VP-723DS**:

- From the front panel OSD control buttons
- Remotely, from the infra-red remote control transmitter
- Remotely, via RS-232

Achieving the best performance means:

- Connecting only good quality connection cables, thus avoiding interference, deterioration in signal quality due to poor matching, and elevated noise levels (often associated with low quality cables)
- Avoiding interference from neighboring electrical appliances that may adversely influence signal quality and positioning your Kramer **VP-720DS** and/or **VP-723DS** away from moisture, excessive sunlight and dust

4 Your Seamless Switcher / Scaler

Figure 1 illustrates the front panels of the **VP-720DS** and **VP-723DS**, as well as the rear panel. The latter is identical on both the **VP-720DS** and **VP-723DS**. Table 1 and Table 2 define the front and rear panels of the **VP-720DS** and **VP-723DS**, respectively.

¹ Processing amplification enables adjustment of different video and audio signal parameters

² Accommodates the frame-rate of a converted movie (24 frames per second) to video frequencies (25 frames per second (PAL); 30 frames per second (NTSC))

³ See Figure 18

Your Seamless Switcher / Scaler

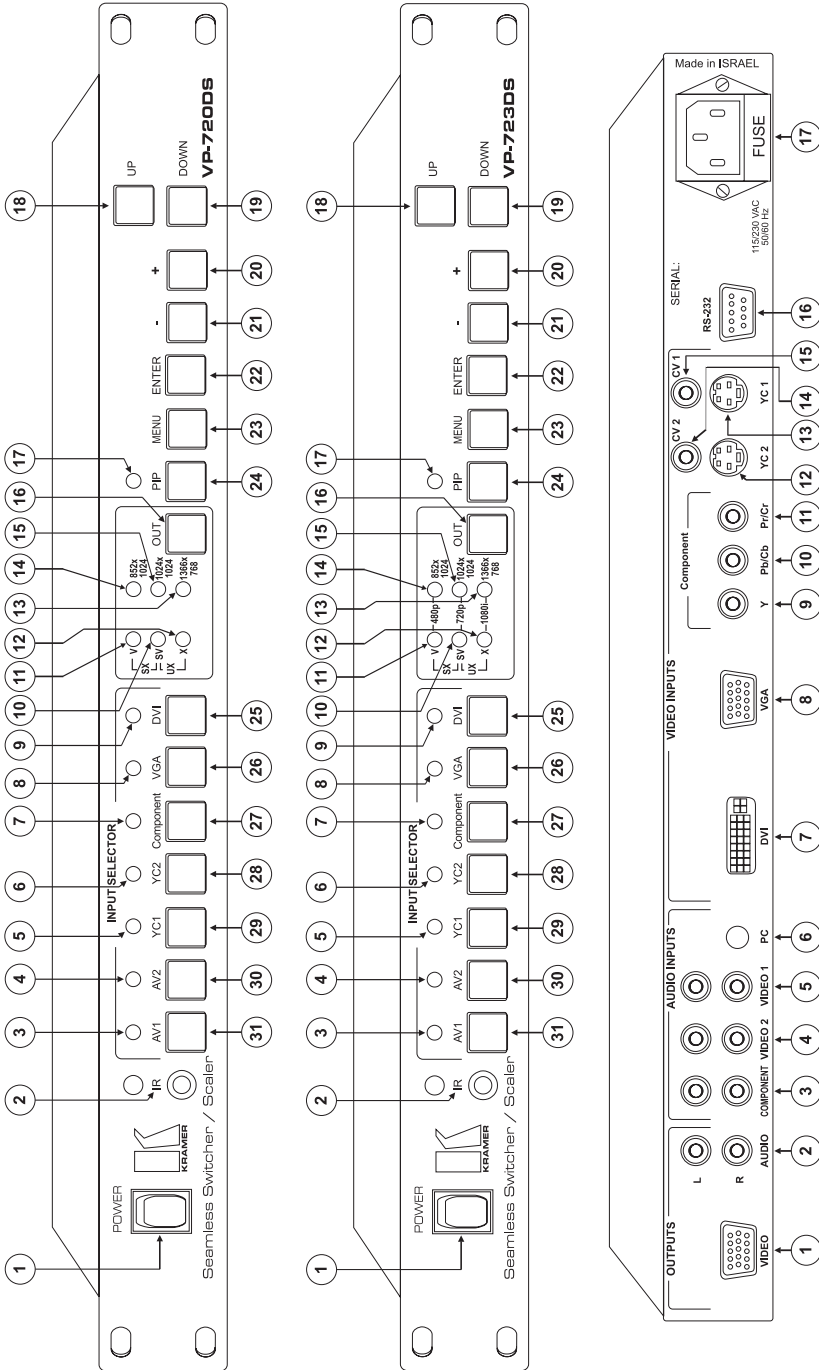

Figure 1: Front Panels of the VP-720DS and VP-723DS, and their Rear Panel

Table 1: Front Panel VP-720DS and VP-723DS, Seamless Switcher / Scaler Features

#	Feature	Function		
1	POWER Switch	Illuminated switch supplying power to the unit		
2	IR Receiver / LED	Green when the unit will accept IR remote commands		
3	INPUT SELECTOR LEDS	AV1	Illuminates ¹ when the composite video / audio source 1 is selected	
4		AV2	Illuminates ¹ when the composite video / audio source 2 is selected	
5		YC1	Illuminates ¹ when the s-Video (Y/C) / audio source 1 is selected	
6		YC2	Illuminates ¹ when the s-Video (Y/C) / audio source 2 is selected	
7		Component	Illuminates ¹ when the component video / audio source is selected	
8		VGA	Illuminates ¹ when the VGA / audio source is selected	
9		DVI	Illuminates ¹ when the DVI / audio source is selected	
10		OUT LEDS	SV	Illuminates when the SVGA resolution is selected ²
11			V	Illuminates when the VGA resolution is selected ³
12	X		Illuminates when the XGA resolution is selected ⁴	
13	1366x768		Illuminates when the 1366x768 resolution is selected ⁵	
14	852x1024		Illuminates when the 852x1024 resolution is selected ⁶	
15	1024x1024		Illuminates when the 1024x1024 resolution is selected ⁷	
16	OUT Button	Selects the output resolution and illuminates the appropriate LED ⁸		

1 Flashes WHEN the image is frozen, and flashes more slowly when a blank screen is displayed

2 Illuminates with the V LED when the SXGA resolution is selected, with the X LED when the UXGA resolution is selected, with the 852x1024, 1024x1024 and 1366x768 LEDs when the 852x480 resolution is selected, with the 1024x1024 LED when 720p is selected (VP-723DS only), and with all the other LEDs when UserDefine is selected

3 Illuminates with the SV LED when the SXGA resolution is selected, with the 852x1024, 1024x1024 and 1366x768 LEDs when the 720x483 resolution is selected, with the 852x1024 LED when 480p is selected (VP-723DS only), and with all the other LEDs when UserDefine is selected

4 Illuminates with the SV LED when the UXGA resolution is selected, with the 852x1024, 1024x1024 and 1366x768 LEDs when the 1400x1050 resolution is selected, with the 1366x768 LED when 1080i is selected (VP-723DS only), and with all the other LEDs when UserDefine is selected

5 Illuminates with the 1024x1024 LED when the 1280x720 (not shown on the front panel) resolution is selected, with the V, 852x1024, and 1024x1024 LEDs when the 720x483 resolution is selected, with the SV, 852x1024, and 1024x1024 LEDs when the 852x480 resolution is selected, with the X, 852x1024, and 1024x1024 LEDs when the 1400x1050 resolution is selected, with the X LED when 1080i is selected (VP-723DS only), and with all the other LEDs when UserDefine is selected

6 Illuminates with the 1024x1024 LED when the 1365x1024 (not shown on the front panel) resolution is selected, with the V, 1024x1024, and 1366x768 LEDs when the 720x483 resolution is selected, with the SV, 1024x1024, and 1366x768 LEDs when the 852x480 resolution is selected, with the X, 1024x1024, and 1366x768 LEDs when the 1400x1050 resolution is selected, with the V LED when 480p is selected (VP-723DS only), and with all the other LEDs when UserDefine is selected

7 Illuminates with the 852x1024 LED when 1365x1024 (not shown on the front panel) resolution is selected, with the 1366x768 LED when the 1280x720 (not shown on the front panel) resolution is selected, with the V, 852x1024, and 1366x768 LEDs when the 720x483 resolution is selected, with the SV, 852x1024, and 1366x768 LEDs when the 852x480 resolution is selected, with the X, 852x1024, and 1366x768 LEDs when the 1400x1050 resolution is selected, with the SV LED when the 720p is selected (VP-723DS only), and with all the other LEDs when UserDefine is selected

8 See section 6.1

Your Seamless Switcher / Scaler

#	Feature	Function	
17	PIP LED	Illuminates when the picture-in-picture function is selected	
18	UP Button	Moves up one step (in the same level) in the OSD screen	
19	DOWN Button	Moves down one step (in the same level) in the OSD screen	
20	+ Button	Increases the range by one step in the OSD screen	
21	- Button	Decreases the range by one step in the OSD screen	
22	ENTER Button	Moves to the next level in the OSD screen	
23	MENU Button	Displays the OSD Menu screen ¹ and locks/unlocks the front panel ²	
24	PIP Button	Selects the picture-in-picture function and illuminates the PIP LED ³	
25	INPUT SELECTOR Buttons	DVI	Press ⁴ to select the DVI / audio source and illuminate the DVI LED
26		VGA	Press ⁴ to select the VGA / audio source and illuminates the VGA LED
27		Component	Press ⁴ to select the component video/audio source and illuminate the component LED
28		YC2	Press ⁴ to select the s-Video (Y/C) / audio source 2 and illuminate the YC2 LED
29		YC1	Press ⁴ to select the s-Video (Y/C) / audio source 1 and illuminate the YC1 LED
30		AV2	Press ⁴ to select the composite video / audio source 2 and illuminate the AV2 LED
31		AV1	Press ⁴ to select the composite video / audio source 1 and illuminate the AV1 LED

1 Or moves to the previous level in the OSD screen

2 See section 6.3

3 See section 6.2

4 Press again (when the LED illuminates) to freeze the image; the LED flashes. Press once again (when the LED flashes), to display a blank screen; the LED flashes more slowly. Alternatively, to freeze the image, press the FREEZE key on the infra-red remote control transmitter (see Figure 49)

Table 2: Rear Panel VP-720DS and VP-723DS, Seamless Switcher / Scaler Features

#	Feature		Function	
1	OUTPUTS	VIDEO HD15 Connector	Connects to the video acceptor (for example, Plasma display, projector or monitor) that displays the scaled output (with the OSD superimposed over it) In the HDTV mode (VP-723DS), the signal goes out via 3 PINS: PIN 1 is Y, PIN 2 is P _b , and PIN 3 is P _r	
2		AUDIO L and R RCA Connectors	Connects to the left and right stereo audio acceptors	
3	AUDIO INPUTS	COMPONENT L and R RCA Connectors	Connects to the left and right stereo audio inputs from the COMPONENT video source	
4		VIDEO 2 L and R RCA Connectors	Connects to the left and right stereo audio inputs from one of the composite or s-Video sources ¹	
5		VIDEO 1 L and R RCA Connectors	Connects to the left and right stereo audio inputs from one of the composite or s-Video sources ²	
6		PC 3.5 mm Socket	Connects to the audio input from either the DVI (digital video interface) graphics source or the VGA analog graphics source	
7	VIDEO INPUTS	DVI Connector	Connects to the DVI (digital video interface) graphics source	
8		VGA HD15 Connector	Connects to the VGA (analog interface) graphics source ³	
9		Component RCA Connectors	Y	Connect to the component video source ⁴
10			Pb/Cb	
11			Pr/Cr	
12		YC 2 4p Connector	Connects to the s-Video source 2	
13		YC 1 4p Connector	Connects to the s-Video source 1	
14		CV 2 RCA Connector	Connects to the composite video source 2	
15		CV 1 RCA Connector	Connects to the composite video source 1	
16	RS-232 DB 9 Connector	Connects to PC or Serial Controller		
17	Power Connector with FUSE	AC connector enabling power supply to the unit		

1 Either CV 2 or YC 2

2 Either CV 1 or YC 1

3 Or to a YUV signal; connect the “Y” connector to PIN 1, the “Pb/Cb” connector to PIN 2, and the “Pr/Cr” connector to PIN 3

4 Or to an RGB signal; connect RED to the “Y” connector, GREEN to the “Pb/Cb” connector, and BLUE to the “Pr/Cr” connector

5 Connecting the Seamless Switcher / Scaler

Using the **VP-720DS** or **VP-723DS** you can select any one of the 7 inputs and scale that input to the output at the set¹ resolution.

To connect the **VP-720DS** or **VP-723DS**, connect the following² to the rear panel, as the example in Figure 3 illustrates:

1. Connect one or more of the following video sources:
 - 2 composite video sources, “Composite Video Source 1” and “Composite Video Source 2”, to the RCA connectors CV 1 and CV2, respectively³
 - 2 s-Video sources: “s-Video Source 1” and “s-Video Source 2”, to the 4p connectors, YC 1 and YC 2, respectively
 - A component video⁴ source, for example, a Betacam VCR (as illustrated in Figure 3), to the 3 RCA connectors, Y, P_b/C_b, and P_r/C_r⁵
 - A VGA graphics source, for example, a PC with an analog graphics output, to the VGA HD15F connector⁶
 - A DVI graphics source, for example, a PC with a digital graphics output, to the DVI connector
2. Connect the stereo audio sources, as illustrated in Figure 3. In particular:
 - The audio of the “Composite Video Source 1” to the AUDIO INPUT VIDEO 1 pair of RCA connectors⁷
 - The audio of the “s-Video Source 2” to the AUDIO INPUT VIDEO 2 pair of RCA connectors⁸
 - The audio of the Component video source, the Betacam VCR, to the AUDIO INPUT COMPONENT pair of RCA connectors

1 For details of how to set the output resolution on the VP-720DS and VP-723DS, refer to section 6.1

2 Switch OFF the power on each device before connecting it to your Seamless Switcher / Scaler. After connecting your Seamless Switcher / Scaler, switch on its power and then switch on the power on each device

3 Connection to CV 2 is not shown in the example in Figure 3

4 Sometimes called YUV, or Y, B-Y, R-Y, or Y, Pb, Pr

5 Alternatively, you can connect an RGB signal (not shown in Figure 3), as follows: RED to the “Y” connector, GREEN to the “Pb/Cb” connector, and BLUE to the “Pr/Cr” connector

6 Alternatively, you can connect a YUV signal to the HD15 connector (not shown in Figure 3), by connecting the “Y” connector to PIN 1, the “Pb/Cb” connector to PIN 2, and the “Pr/Cr” connector to PIN 3

7 The VIDEO 1 connectors are common to CV 1 and YC 1

8 The VIDEO 2 connectors are common to CV 2 and YC 2

- The audio of the DVI Graphics Source to the AUDIO INPUT PC 3.5mm socket¹. Alternatively, connect the audio from the VGA Graphics Source (not illustrated in Figure 3)
3. Connect the VIDEO OUTPUT HD15F connector² to the video acceptor, for example, a projector or a Plasma monitor (as shown in Figure 3), and connect the AUDIO OUTPUT pair of RCA connectors to the audio acceptor, for example, a power amplifier.
 4. The power cord (the power connector is not illustrated in Figure 3).
 5. A PC (optional), as section 5.1 describes.

5.1 Connecting a PC

You can connect a PC (or other controller) to the **VP-720DS** or **VP-723DS** via the RS-232 port for remote control, and for upgrading the firmware, as section 7.4 describes.

To connect a PC to the **VP-720DS** or **VP-723DS** unit, using the Null-modem adapter provided with the machine (recommended):

- Connect the RS-232 DB9 rear panel port on the **VP-720DS** or **VP-723DS** unit to the Null-modem adapter and connect the Null-modem adapter with a 9 wire flat cable to the RS-232 DB9 port on your PC

To connect a PC to a **VP-720DS** or **VP-723DS** unit, without using a Null-modem adapter:

- Connect the RS-232 DB9 port on your PC to the RS-232 DB9 rear panel port on the **VP-720DS** or **VP-723DS** unit, forming a cross-connection³, as Figure 2 illustrates

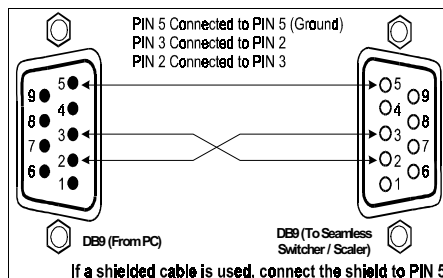

Figure 2: Connecting the PC

¹ The PC connector is common to DVI and VGA

² In the HDTV mode, the signal goes out via 3 PINS: PIN 1 is Y, PIN 2 is Pb, and PIN 3 is Pr

³ Also known as a Null-modem connection

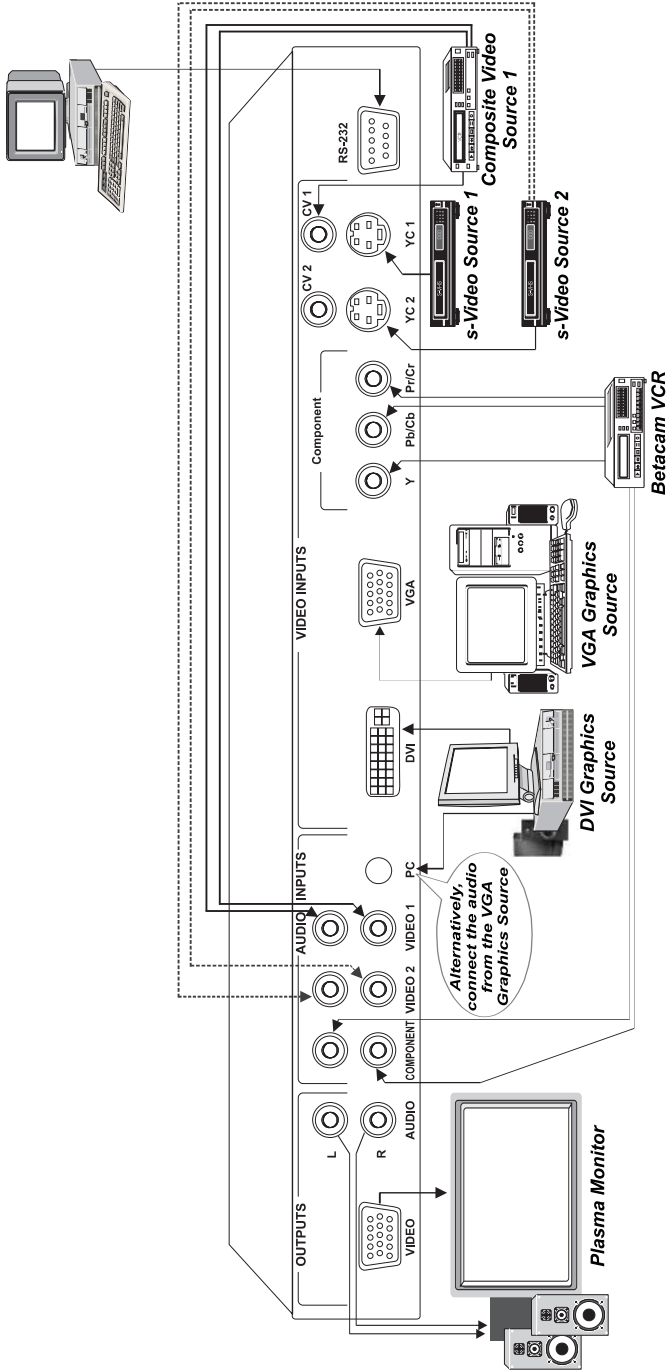

Figure 3: Connecting the VP-720DS / VP-723DS Rear Panel

6 Understanding the Seamless Switcher / Scaler

The **VP-720DS** and **VP-723DS** include the following front panel buttons:

- A set of 7 INPUT SELECTOR buttons (*AV1, AV2, YC1, YC2, Component, VGA, and DVI*)
- An OUT button (see section 6.1)
- A PIP button (see section 6.2)
- A set of 6 OSD buttons, which are described in Table 1: *MENU, ENTER, -, +, UP, and DOWN*

6.1 Understanding the OUT Button Functionality

Press the OUT button¹ to choose the desired output resolution. Table 3 and Figure 4 define how to select the output resolution:

Table 3: Selecting the Output Resolution

To scale to this pixel resolution rate (VP-720DS and VP-723DS):	Press the OUT button to illuminate this LED sequence:
VGA (640x480)	V
SVGA (800x600)	SV
XGA (1024x768)	X
SXGA (1280x1024)	V and SV
UXGA (1600x1200)	SV and X
852x1024i	852x1024
1024x1024i	1024x1024
1366x768	1366x768
1365x1024 ²	852x1024 and 1024x1024
1280x720 ²	1024x1024 and 1366x768
720x483 ²	V and 852x1024 and 1024x1024 and 1366x768
852x480 ²	SV and 852x1024 and 1024x1024 and 1366x768
1400x1050 ²	X and 852x1024 and 1024x1024 and 1366x768

To output to this high definition television (HDTV) mode (VP-723DS):	Press the OUT button to illuminate this LED sequence:
480p	V and 852x1024
720p	SV and 1024x1024
1080i	X and 1366x768

To scale to this pixel resolution rate:	Press the OUT button to illuminate this LED sequence:
UserDefine ²	All LEDs ³

¹ Item 16 in Figure 1

² Not shown on the front panel

³ Recommended for advanced users only – non-standard settings may not be recognized by the display device

Understanding the Seamless Switcher / Scaler

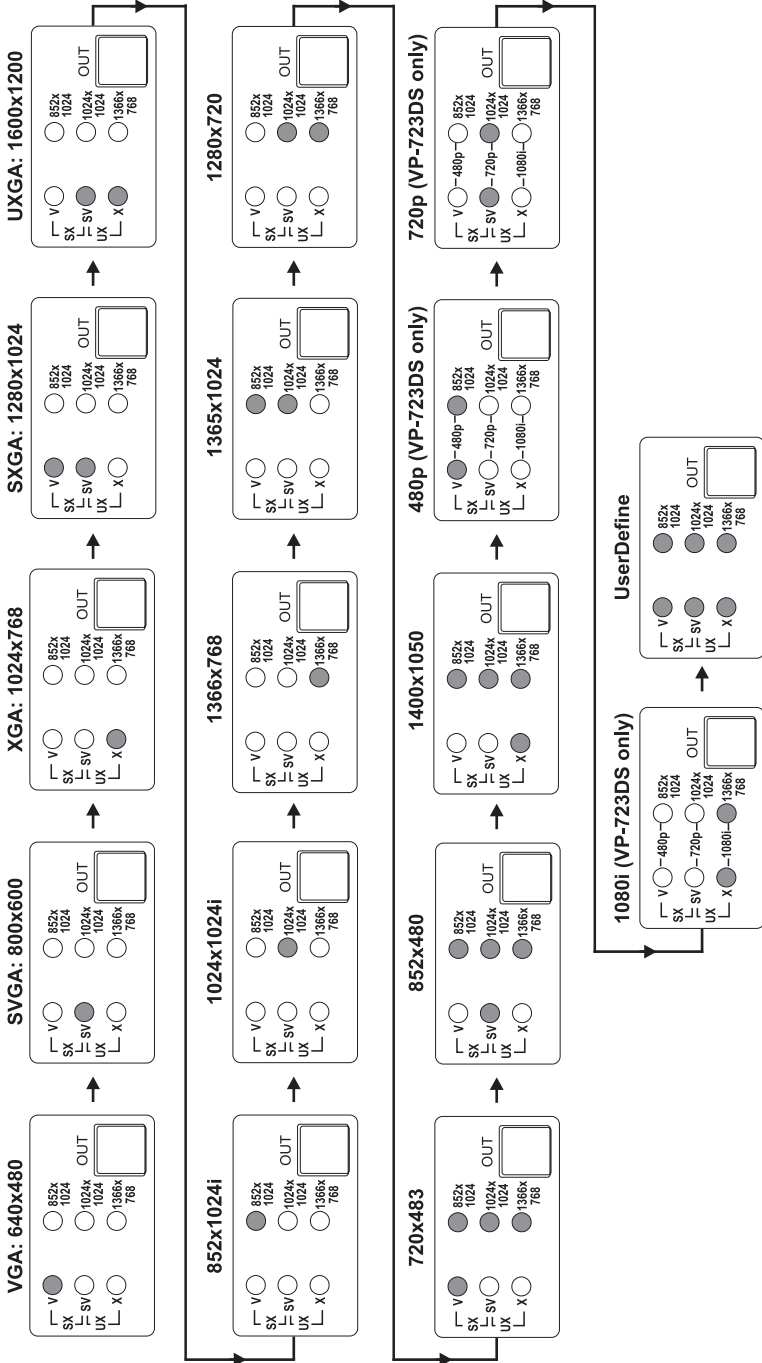

Figure 4: OUT LED Sequence

6.2 Understanding the PIP Button Feature

The Picture-in-Picture inserter (PIP) is used for the simultaneous display of video and graphic sources, and lets you display:

- An inserted video source¹ PIP over a graphic source² display
- An inserted graphic source² PIP over a video source¹ display

Your Seamless Switcher / Scaler automatically recognizes and displays only the relevant sources, as the following 2 examples illustrate:

- Choosing the AV 1 PIP source when the VGA input is selected, will insert the composite video source over the VGA graphic displayed on the screen. You can choose a component, YC 1, YC 2 or AV 2 PIP source³ (instead of the AV 1). You cannot choose VGA 1, VGA 2 or DVI⁴
- Choosing the VGA 1 PIP source when the AV 1 input is selected, will insert the VGA graphic source over the composite video displayed on the screen. You can choose a DVI PIP source³ (instead of the VGA 1). You cannot choose AV 2, YC 1, YC 2 or component⁵

6.2.1 Activating the PIP Feature

To activate the PIP (which illuminates the PIP LED), do one of the following:

- Press the PIP button⁶
- Switch on the PIP functionality via the OSD Menu (see Figure 35)
- Press the PIP key on the infra-red remote control transmitter (see Figure 49)

When the Source Prompt is ON (see Figure 41), the PIP is enclosed by an orange frame, and the OSD PIP status appears superimposed over the top right corner of the screen for a few seconds, as Figure 5 illustrates. After a few seconds⁷, the orange frame and the OSD PIP status automatically disappear⁸.

Activating the PIP subsequently cycles between the PIP with the orange frame and no PIP.

1 That is, composite, s-Video or component

2 That is, DVI or VGA

3 As long as it is connected and switched on. Otherwise, choosing it will display a blank screen

4 As these are graphics sources and you cannot insert a graphics PIP over a graphics source

5 As these are video sources and you cannot insert a video PIP over a video source

6 Item 24 in Figure 1

7 By default, 20 seconds. But you can reset the timeout (from 3 to 60 seconds), see section 7.3.6.6

8 Trying to activate the PIP again while the PIP is still enclosed by an orange frame deactivates the PIP

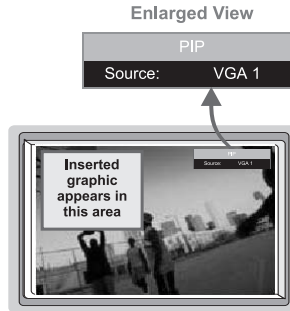

Figure 5: OSD PIP Status

When the Source Prompt is OFF (see Figure 41), activating the PIP toggles between the PIP (with no frame and no OSD PIP status) and no PIP.

6.2.2 PIP Characteristics

You can determine the following PIP characteristics:

- PIP Source
- PIP Size (1/4, 1/9, 1/16, 1/25 or split screen)
- Horizontal and Vertical position, placing it anywhere on the screen

6.2.3 Toggling between the PIP and the Screen Source (SWAP)

To toggle back and forth between the PIP content and the screen source content, do the following:

- Press the SWAP key on the Infra-red remote control transmitter (see Figure 49)

The OSD SWAP status appears superimposed over the top right corner of the screen for a few seconds¹, as Figure 6 illustrates



Figure 6: OSD SWAP Status

¹ By default, 20 seconds. But you can reset the timeout (from 3 to 60 seconds), see section 7.3.6.6

6.2.4 Resizing the PIP

To resize the PIP (1/4, 1/9, 1/16, 1/25 or split screen):

- When the Source Prompt is ON and the PIP is enclosed by an orange frame, use the Up and/or Down navigation control keys on the infra-red remote control transmitter (see Figure 49) or the *UP* and/or *DOWN* front panel OSD buttons
- Use the OSD Menu buttons (see Figure 37)

6.2.5 Moving the Position of the PIP

To move the location of the PIP:

- When the Source Prompt is OFF, use the four navigation control keys (see Figure 25) on the infra-red remote control transmitter (see Figure 49)
- When the Source Prompt is ON and the PIP is enclosed by an orange frame, use the preset position control keys (see Figure 24) on the infra-red remote control transmitter (see Figure 49), to instantly move the position of the PIP window to up to nine preset fixed locations¹. When the Source Prompt is OFF, the preset position control keys have no effect

6.3 Locking and Unlocking the Front Panel

You can lock the front panel² and control from the infra-red remote control transmitter to safeguard the settings on the **VP-720DS** or **VP-723DS**.

To lock the front panel:

- Press and hold the *MENU* front panel OSD button³ or the MENU key on the infra-red remote control transmitter (see Figure 49) for a few seconds, until the Key Lock On OSD status appears superimposed over the top right corner of the screen for a few seconds⁴, as Figure 7 illustrates



Figure 7: Locking / Unlocking the Front Panel

1 For example, to move to the lower right corner of the image, press the  button

2 However, operation via RS-232 serial commands (remote controller or PC) is still available

3 Item 23 in Figure 1

4 By default, 20 seconds. But you can reset the timeout (from 3 to 60 seconds), see section 7.3.6.6

To unlock the front panel (releasing the protection mechanism):

- Press and hold the *MENU* front panel OSD button¹ or the MENU key on the infra-red remote control transmitter (see Figure 49) for a few seconds, until the Key Lock Off OSD status appears superimposed over the top right corner of the screen for a few seconds²

7 Operating the Seamless Switcher / Scaler

Section 7.1 describes how to switch and scale an input. Section 7.2 describes the methods of controlling the Seamless Switcher / Scaler.

7.1 Switching and Scaling

Section 7.1.1 describes how to switch an input. Section 7.1.2 describes how to select the output resolution.

7.1.1 Switching an Input

You can switch seamlessly³ between each input⁴ that is connected to a source, by pressing the appropriate INPUT SELECTOR button. The OSD status appears superimposed over the top right corner of the screen for a few seconds², as Figure 8 illustrates:

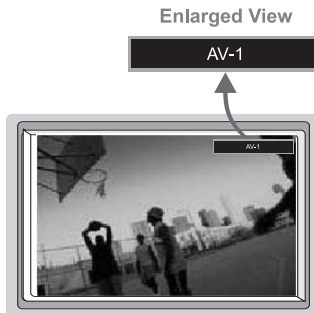

Figure 8: OSD Input Status

You can also use the INPUT SELECTOR button to freeze⁵ the image or to display a blank screen⁶.

1 Item 24 in Figure 1

2 By default, 20 seconds. But you can reset the timeout (from 3 to 60 seconds), see section 7.3.6.6

3 For glitchless transitions between inputs

4 To set the image transition speed (fast, safe or moderate), see section 7.3.6.5

5 By pressing the INPUT SELECTOR button again when the appropriate LED illuminates

6 By pressing the INPUT SELECTOR button once again when the appropriate LED flashes

7.1.2 Choosing the Output Resolution

You can select the output resolution (choosing the pixel resolution, as section 6.1 describes), by pressing the OUT button¹ on the front panel or the OUT key on the infra-red remote control transmitter (see Figure 49). The OSD status appears superimposed over the top right corner of the screen for a few seconds², as Figure 9 illustrates³:



Figure 9: OSD Output Status

7.2 Controlling the Seamless Switcher / Scaler

You can control the Seamless Switcher / Scaler via:

- The front panel OSD control buttons (see section 7.3)
- The infra-red remote control transmitter (see section 7.3.8)
- RS-232 remote control

7.3 Operating via the OSD MENU Screen

The OSD superimposes a menu on the screen from which you can control your the **VP-720DS** or **VP-723DS**, using the *MENU*, *ENTER*, *-*, *+*, *UP* and *DOWN* front panel OSD buttons.

Pressing the *MENU* front panel OSD button or the *MENU* key on the infra-red remote control transmitter (see Figure 49) displays the first OSD screen, the “Menu screen” (see Figure 10), which displays six interactive icons⁴ (defined in Figure 11).

1 Item 16 in Figure 1

2 By default, 20 seconds. But you can reset the timeout (from 3 to 60 seconds), see section 7.3.6.6

3 Adjusting the output resolution results in a corresponding adjustment to the size of the OSD status window

4 Each icon represents a Level 1 function. In addition to Level 1, the OSD structure includes Level 2 (a subset of level 1), Level 3 (a subset of level 2), Level 4 (a subset of level 3) and Range

After initially pressing the *MENU* front panel OSD button or the MENU key on the infra-red remote control transmitter, each subsequent press moves to the previous level in the OSD screen (Esc.).



Figure 10: MENU Screen

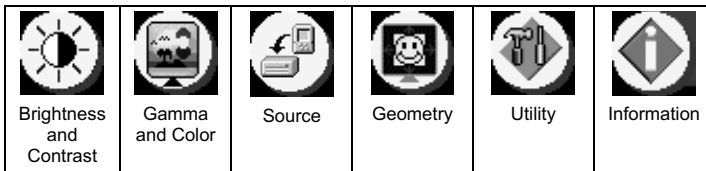

Figure 11: Menu Screen Icons

7.3.1 Controlling the Brightness and Contrast

Figure 12 illustrates the Brightness and Contrast Screen:

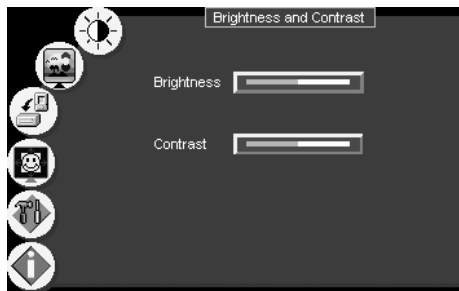

Figure 12: Brightness and Contrast Screen

7.3.2 Controlling the Gamma and Color

Figure 13 illustrates the Gamma and Color Screen. You can choose Normal (average setting), Presentation (higher black level), Cinema (higher white balance), Nature (higher green level), User 1 or User 2.

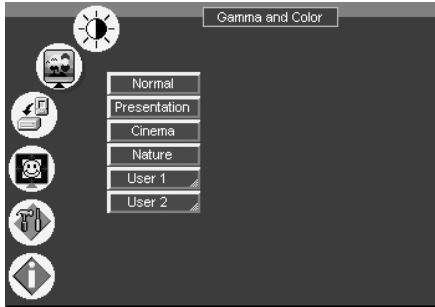

Figure 13: Gamma and Color Screen

Choosing User 1 or User 2 from the Gamma and Color Screen illustrated in Figure 13, displays the Gamma, Color Temperature and Color Manager Screen in Figure 14. Each user setting is customized to the applicable environment. The user sets the parameters and saves them for recall later.

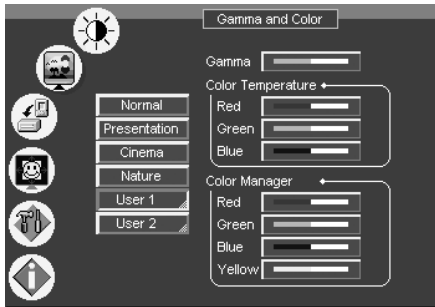

Figure 14: Gamma, Color Temperature/Manager User 1/2 Screen

7.3.3 Selecting the Source

Figure 15 illustrates the Source Screen, displaying the active source, as well as facilitating changing of the source.

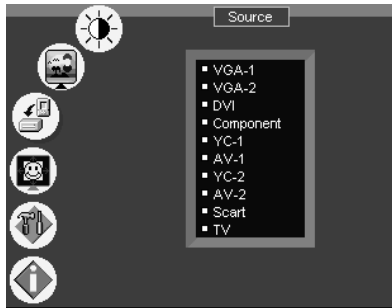

Figure 15: Source Selection Screen

7.3.4 Controlling the Scale Geometry

Figure 16 illustrates the main Geometry Screen, from which you can scale and zoom.

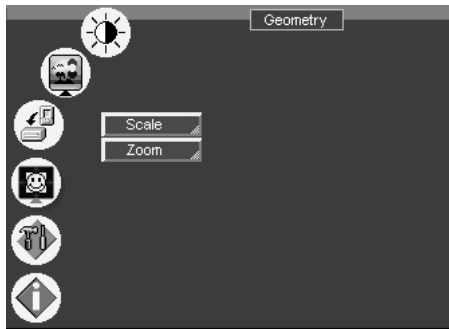

Figure 16: Geometry (Scale and Zoom) Screen

Figure 17 illustrates the Geometry (Scale) Screen, from which you can scale (Aspect Ratio and Nonlinear):

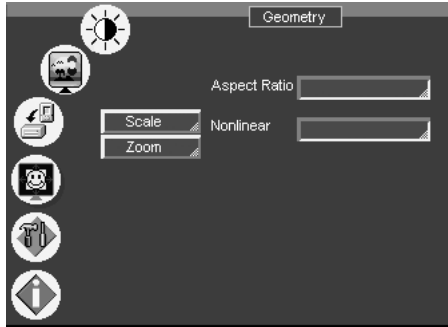

Figure 17: Geometry (Scale: Aspect Ratio and Nonlinear) Screen

Set the aspect ratio according to your specific requirements—the native resolution—that is, depending on the specifications of the Plasma screen or projector.

When using a VGA, DVI and/or component video¹ source, you can choose an aspect ratio from the following: Full Screen, Native, 4:3 Output², and 16:9 Output³.

When using a composite video source and/or an s-Video source and/or component video¹ source, you can choose an aspect ratio from the following: Normal, Wide Screen, Pan⁴ & Scan, 4:3 Output², and 16:9 Output³, as Figure 18 illustrates:

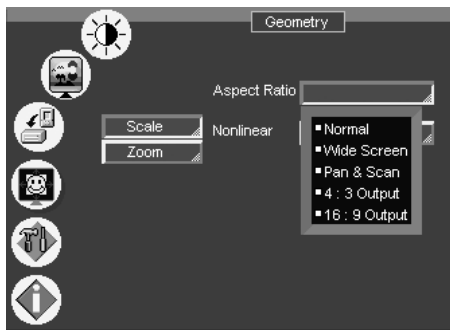

Figure 18: Geometry (Scale: Aspect Ratio) Screen

1 Depending on the resolution of the component source

2 In this standard, the ratio between the length and height is 4:3

3 In this standard (a Cinema mode standard used for movies and DVDs), the ratio between the length and height is 16:9 (or sometimes 1:2.35)

4 Panning the picture refers to resizing and cropping it

7.3.5 Adjusting the Zoom Ratio and Position

Figure 19 illustrates the Geometry (Zoom) Screen:

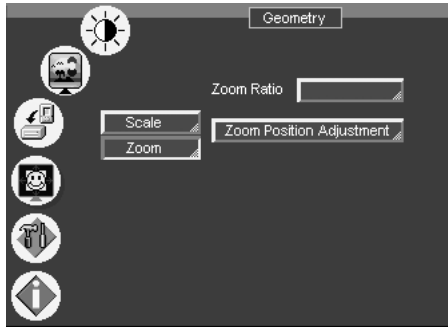

Figure 19: Geometry (Zoom) Screen

The zoom ratio and the zoom position are illustrated by a small rectangle inside a transparent pop-up OSD Enlarge status box that appears at the top right corner of the screen, as the example in Figure 20 illustrates:

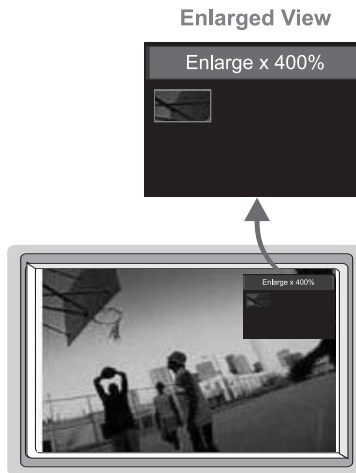

Figure 20: OSD Enlarge Status

When you change the zoom ratio or zoom position, the screen image is adjusted correspondingly, and the change is reflected in the pop-up OSD Enlarge status box. For example, Figure 21 illustrates a zoom ratio increase from 200% (Image A) to 400% (Image B):

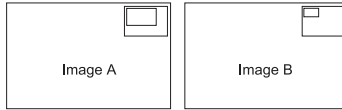

Figure 21: Zoom Ratio Adjustment Example

Figure 22 illustrates how the pop-up OSD Enlarge status box shows a zoom position adjustment from the top left corner (Image C) to the lower right corner (Image D):

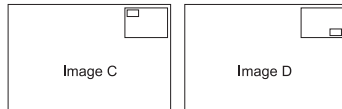

Figure 22: Zoom Position Adjustment Example

7.3.5.1 Adjusting the Zoom Ratio

You can adjust the zoom ratio to up to 400% via one or both of these methods:

- Using the Zoom + and/or the Zoom - control keys¹ on the infra-red remote control transmitter (see Figure 49). The pop-up OSD Enlarge status box continuously displays the zoom ratio and position, as Figure 20 illustrates
- Using the OSD Menu buttons, as Figure 23 illustrates

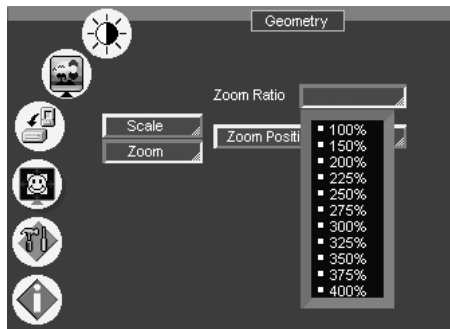



Figure 23: Geometry (Zoom Ratio) Screen

¹ The  and the  buttons

7.3.5.2 Adjusting the Zoom Position

You can adjust the zoom position (see the example in Figure 22) via one or more of the following methods:

- Using the preset position control keys¹ (see Figure 24) on the infra-red remote control transmitter (see Figure 49), which instantly move the position of the zoom to up to nine preset fixed locations²

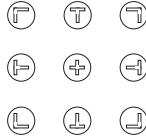

Figure 24: Preset Position Control Keys

- Using the navigation control keys on the infra-red remote control transmitter (see Figure 49), to fine tune the zoom position (that is, to slowly zoom-in at any location on the screen)³, as Figure 25 illustrates

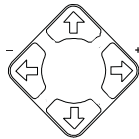

Figure 25: Navigation Control Keys

- Using the OSD Menu buttons (see Figure 26)⁴

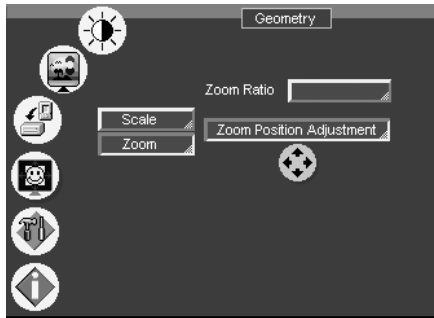





Figure 26: Geometry (Zoom Position Adjustment) Screen

1 Which also set the position for the PIP window location (when the Source Prompt is ON)

2 For example, to zoom-in to the lower right corner of the image, press the  button

3 For example, to zoom-in toward the lower right of the image, press the  and the  buttons separately, as required

4 For example, to zoom-in to the lower right part of the image instead of the top left part, press the + and DOWN OSD Menu buttons (items 20 and 19, respectively, in Figure 1) separately, as required

7.3.6 Configuring via the Utility Screens

You can determine how your **VP-720DS** or **VP-723DS** will function either generally or on a specific occasion, via the Utility screen settings (see Figure 27):

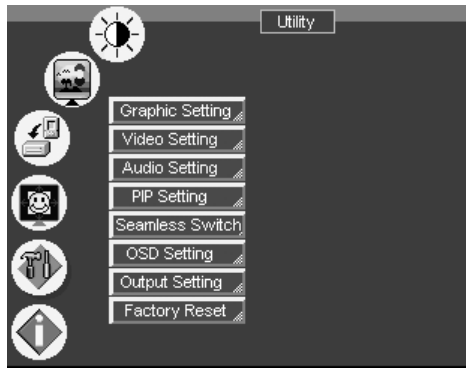

Figure 27: Utility Screen

7.3.6.1 Choosing the Graphic Utility Settings

From the Graphic¹ Setting Utility screen (see Figure 28), you can set the color format (see Figure 29), position, saturation, hue, sharpness, frequency and phase, as well as auto image² and auto gain³.

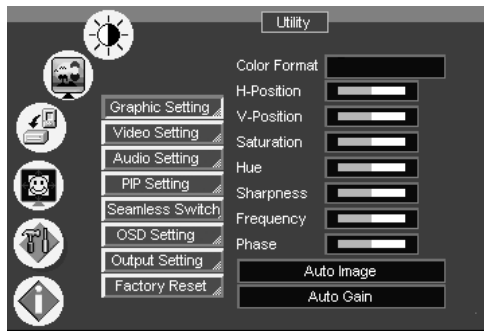

Figure 28: Graphic Setting Utility Screen

1 When a VGA source is selected, "Graphic Setting" will be shown (or "PC Data Setting" in earlier versions). "HDTV Setting" (illustrated in Figure 46) will appear when an HDTV source is selected

2 Assesses the image and improves the quality accordingly, by automatically adjusting the phase, frequency and position

3 Automatically adjusts the brightness and contrast

Selecting the color format (see Figure 29) lets you select RGB or YUV¹ colorspace. When the Default setting is chosen, the colorspace is set according to the detected input resolution.

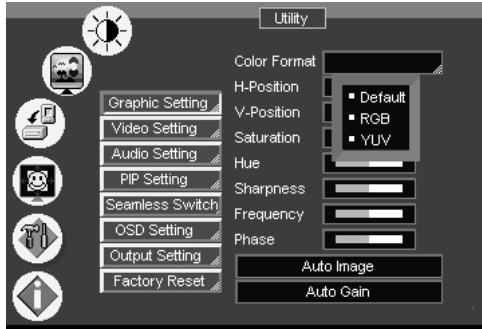

Figure 29: Graphic Setting Color Format Utility Screen

7.3.6.2 Choosing the Video Utility Settings

From the Video Setting Utility screen (see Figure 30), you can set the Standard (see Figure 31), color, hue, sharpness, and position.

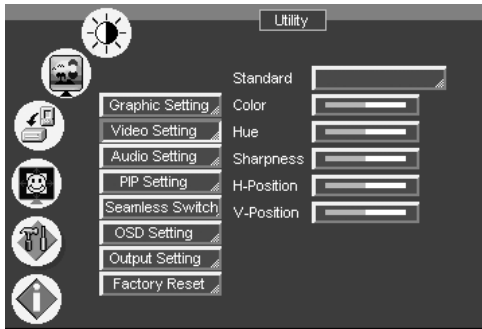

Figure 30: Video Setting Utility Screen

¹ That is Y, B-Y, R-Y colorspace, also known as Y, C_b, C_r or Y, P_b, P_r

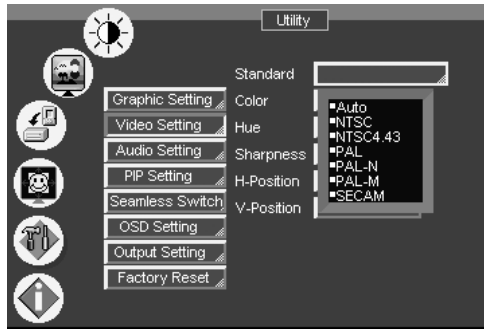

Figure 31: Video Setting Standard Utility Screen

7.3.6.3 Choosing the Audio Utility Settings

From the Audio Setting Utility screen (see Figure 32), you can set the volume, treble, bass, and choose between stereo and mono (see Figure 33).

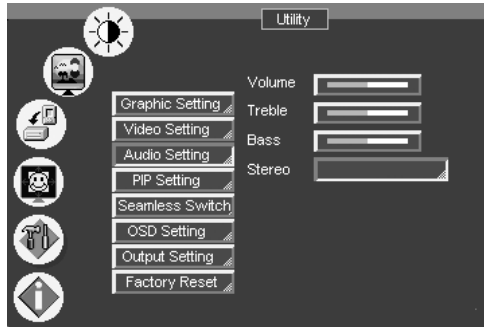

Figure 32: Audio Setting Utility Screen

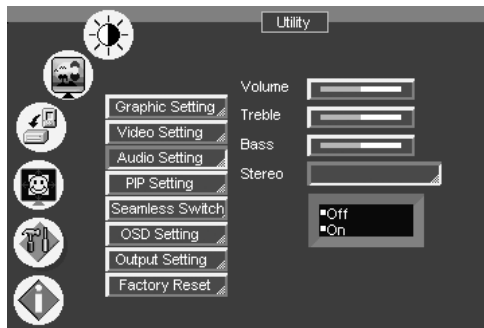

Figure 33: Audio Setting Stereo Utility Screen

7.3.6.4 Choosing the PIP Utility Settings

From the PIP Setting Utility screen (see Figure 34), you can activate the PIP (see Figure 35), and choose the source (see Figure 36), the size (see Figure 37) and the position of the PIP.

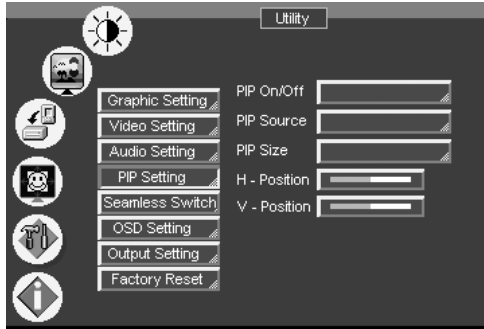

Figure 34: PIP Utility Screen

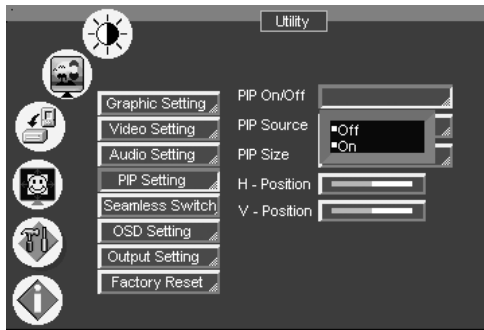

Figure 35: PIP Activation Utility Screen

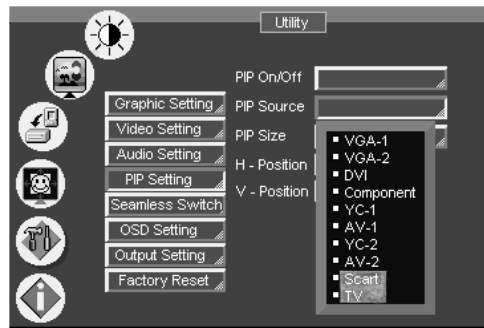

Figure 36: PIP Source Utility Screen

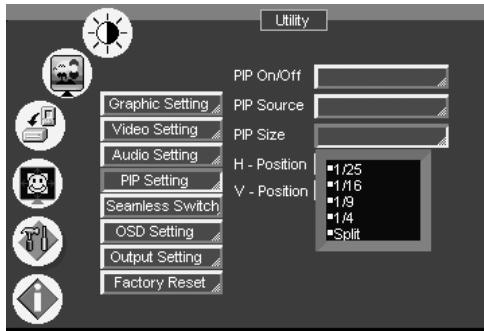

Figure 37: PIP Size Utility Screen

7.3.6.5 Choosing the Seamless Switch Utility Settings

From the Seamless Switch Utility screen (see Figure 38), you can choose a fast¹, safe² (takes longer than fast) or moderate (between fast and safe) image transition speed:

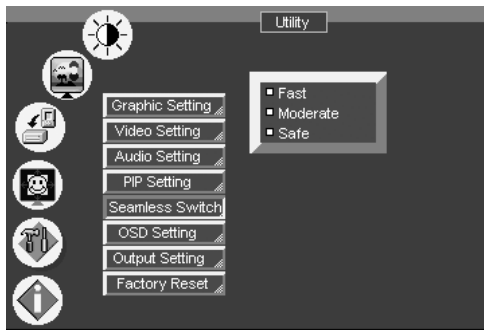

Figure 38: Seamless Switch Utility Screen

1 An immediate switch, without checking the resolution. However, the image transition may appear unstable

2 A smooth image transition (the input resolution at the input is checked and outputted after a few seconds delay)

7.3.6.6 Choosing the OSD Utility Settings

From the OSD Setting Utility screen (see Figure 39), you can set the OSD position, time out, size (see Figure 40), source prompt¹ (see Figure 41), and choose the blank color (blue or black - see Figure 42).

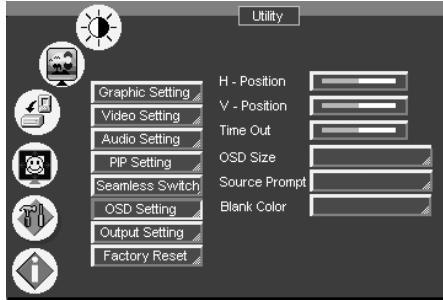

Figure 39: OSD Setting Utility Screen

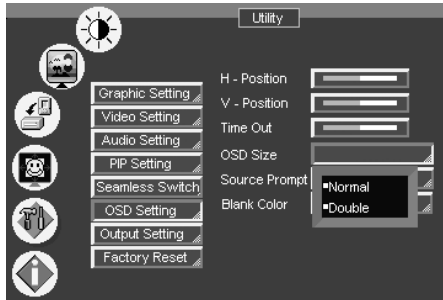

Figure 40: OSD Size Utility Screen

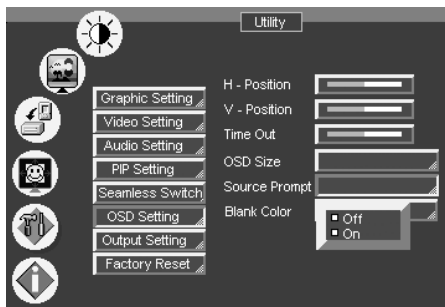

Figure 41: OSD Source Prompt Activation Utility Screen

¹ We recommend that you set the source prompt ON, when adjusting the system. During a presentation, set the source prompt OFF to avoid the appearance of OSD screen labels

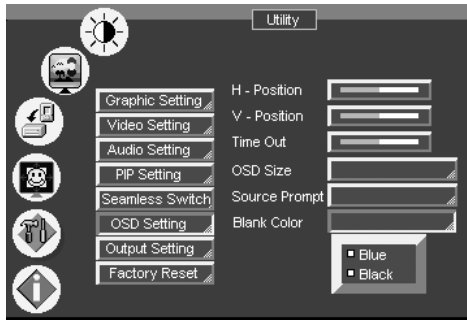

Figure 42: OSD Blank Color Utility Screen

7.3.6.7 Choosing the Output Utility Settings

From the Output Setting Utility screen (see Figure 43), you can set the resolution (see Figure 44), refresh rate (see Figure 45), and a user definable output mode¹ (see Figure 46 and Table 4).

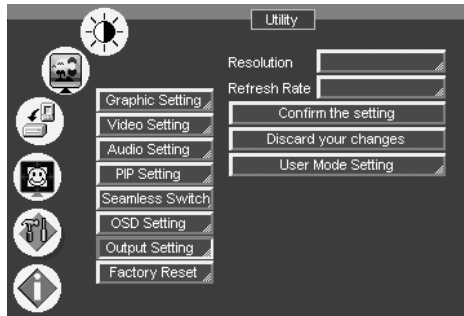

Figure 43: Output Setting Utility Screen

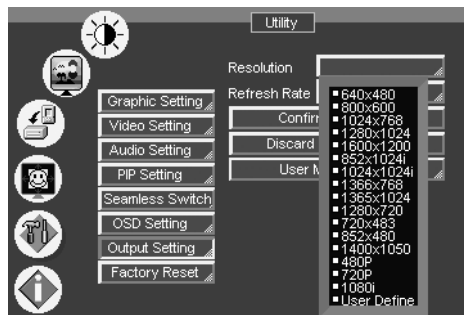

Figure 44: Output Setting Resolution Utility Screen

¹ Recommended for advanced users only – non-standard settings may not be recognized by the display device

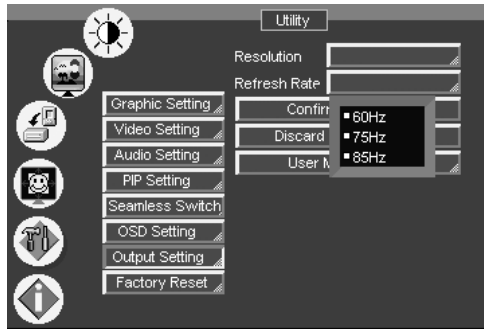

Figure 45: Output Setting Refresh Rate Utility Screen

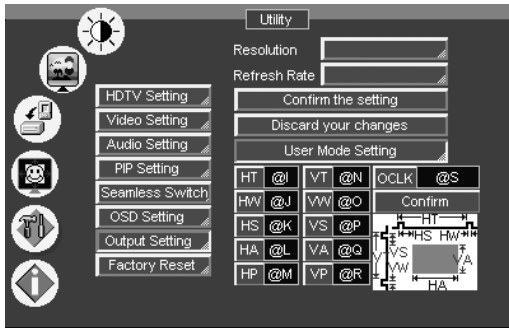

Figure 46: Output Setting User Mode Setting Utility Screen

Table 4: User Mode Setting Definitions

User Mode Setting Definitions	
HT:	Horizontal total
HW:	Horizontal sync pulse width
HS:	Horizontal active start point
HA:	Horizontal active region
HP:	Horizontal polarity
VT:	Vertical total
VW:	Vertical sync pulse width
VS:	Vertical active start point
VA:	Vertical active region
VP:	Vertical polarity
OCLK:	Output clock

7.3.6.8 Choosing Factory Reset

From the Factory Reset Utility screen (see Figure 47), you can reset your **VP-720DS** or **VP-723DS** to its preset default setting:

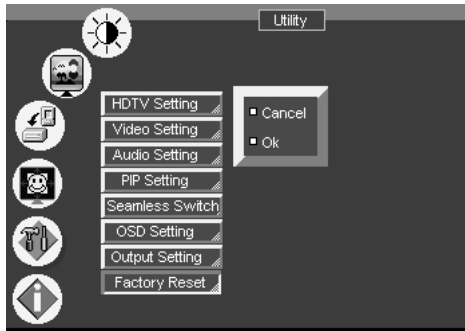

Figure 47: Factory Reset Utility Screen

7.3.7 Verifying Configuration Details via the Information Screen

From the Information screen (see Figure 48), you can verify the main source, PIP source, whether mute is activated, output mode, as well as the firmware version number:

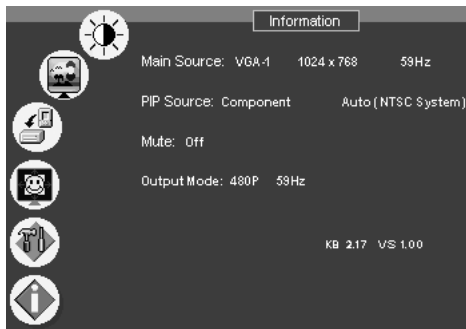

Figure 48: Information Screen

7.3.8 Operating via the Infra-red Remote Control Transmitter

You can control the Seamless Switcher / Scaler remotely, from the Infra-red remote control transmitter, which:

- Is a hand held wireless instrument with a convenient keypad
- Receives its power from 2 AAA size 1.5V DC batteries
- Has a range of up to 15 meters
- Delivers instantaneous results

Figure 49 and Table 5 define¹ the Infra-red Remote Control Transmitter:

¹ The illustration in Figure 49 shows an enlarged view of 3 separate parts of the Infra-red remote control transmitter

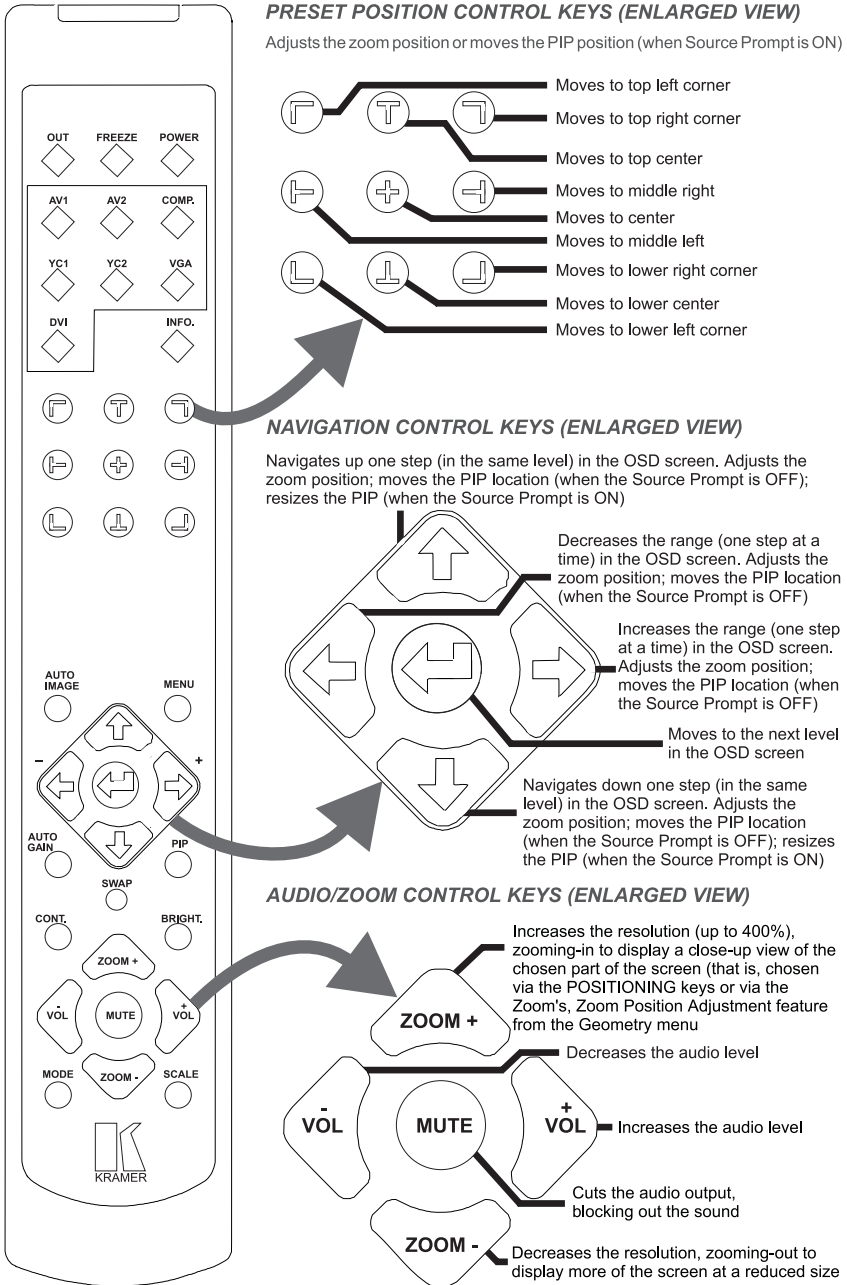

Figure 49: Infra-red Remote Control Transmitter

Table 5: *Infra-red Remote Control Transmitter Functions*

Keys	Function
OUT	Selects the output resolution and illuminates the appropriate LED
FREEZE	Pauses the output video
POWER	Cycles power
INPUT SELECTOR ¹	7 separate keys for selecting each of the following sources: AV1, AV2, COMP. (Component) YC1, YC2, VGA, and DVI
INFO.	Defines the main source, PIP source, whether mute is activated, output mode, as well as the firmware version number
PRESET POSITION CONTROL ²	Adjusts the zoom ³ position ⁴ or moves the PIP position when the Source Prompt is ON
AUTO IMAGE	Assesses the image and improves the quality accordingly, by automatically adjusting the phase, frequency and position
MENU	Displays the OSD Menu screen ⁵ and locks/unlocks the front panel ⁶
NAVIGATION CONTROL ⁷	Allow maneuvering within an OSD screen (all keys); adjusts the zoom position (4 keys); moves the PIP location when the Source Prompt is OFF (4 keys); resizes the PIP when the Source Prompt is ON (2 keys)
AUTO GAIN	Automatically adjusts the brightness and contrast
SWAP ⁸	Toggles between the PIP content and the screen source content
PIP ⁹	Selects the picture-in-picture function and illuminates the PIP LED
CONT.	Displays the contrast status ¹⁰
BRIGHT.	Displays the brightness status ¹⁰
AUDIO/ZOOM CONTROL ⁷	Allow volume and zoom control
MODE	Toggles between each of the following modes: Normal, Presentation, Cinema, Nature, User 1 and User 2
SCALE	Toggles between each of the following Aspect Ratios: Normal, Wide Screen, Pan & Scan, 4:3 Output, and 16:9 Output ¹¹

1 Press to select the source; the LED illuminates. Press again to freeze the image; the LED flashes. Press once again to display a blank screen; the LED flashes more slowly

2 Consists of a set of 9 separate keys. See the illustration in Figure 49 which shows an enlarged view of this part of the Infra-red remote control transmitter

3 A small rectangle inside a transparent pop-up OSD Enlarge status box appears at the top right corner of the screen showing the position of the zoom within a picture

4 For example, when enlarging the display, press this button:  to go to the lower right corner of the display area

5 As Figure 10 illustrates

6 See section 6.3

7 Consists of a set of 5 separate keys. See the illustration in Figure 49 which shows an enlarged view of this part of the Infra-red remote control transmitter

8 See section 6.2.3

9 See section 6.2

10 Adjust using the +/- keys

11 See Figure 18

7.4 Upgrading Firmware

To install the latest Kramer firmware version on a **VP-720DS** or **VP-723DS** unit, connect the COM port on your PC to the RS-232 port on the **VP-720DS** or **VP-723DS** unit, as section 5.1 describes, and go to the Kramer Web site at this URL: <http://www.kramerelectronics.com> for the latest information.

8 Technical Specifications

Table 6 includes the technical specifications:

Table 6: Technical Specifications¹ of the VP-720DS/VP-723DS

Inputs:	VIDEO: 2 x composite video 1 Vpp/75 Ω on RCA connectors; 2 x Y/C (s-Video) 1 Vpp (Y), 0.3Vpp (C) / 75 Ω on 4 pin connectors; 1 x Component (Y, Pb/Cb, Pr/Cr) on RCA connectors; 1x VGA (VGA/SVGA/XGA/UXGA) on an HD15F connector; and 1x DVI connector AUDIO: 3 x stereo audio on RCA connectors (for VIDEO 1, VIDEO 2 and COMPONENT) and 1x PC audio on a 3.5mm mini socket
Outputs:	VIDEO: 1 x VGA/SVGA/XGA/UXGA (additional modes: 480p, 720, 1080i with the VP-723DS) on an HD15F connector AUDIO: 1 x stereo audio on RCA connectors
Output Resolutions:	VGA (640x480), SVGA (800x600), XGA (1024x768), SXGA (1280x1024), UXGA (1600x1200), 1024x852, 1024x1024, 1366x768, 1365x1024, 1280x720, 720x483, 852x480, 1400x1050, as well as a user definable output mode. The VP-723DS also supports 480p, 720p, and 1080i
Control:	Front panel buttons/ OSD, IR remote control, RS-232 on a DB-9 connector
Additional Controls:	Different vertical refresh rates, ProcAmp control, output image scaling and aspect ratio change
Firmware:	Frame freeze, digital zoom 4X, PIP (video-in-graphics or graphics-in-video, in sizes of up to half a screen, located anywhere on the screen), Flesh tone (special color processing), Gamma setting
H Frequency:	15.63~90kHz
V Frequency:	50~100Hz
Computer Resizing:	Auto-resizing to panel pixel number
RGB Video Signal:	RGB, 1.0 Vpp, 75 Ω
RGB Sync Signal:	Separate H/V/TTL, composite sync, analog
Audio Input Voltage:	0~0.5 Vrms
Audio Output Voltage:	0~0.5 Vrms
Plug and Play:	DDC1 / DDC2B
De-interlacing:	Adaptive and pixel based
Film mode detection:	2:2 / 3:2 pull down reverse
Power Source:	100-240 VAC, 50/60 Hz, 30VA automatic power supply
Dimensions:	19 " (W), 9.3" (D) 1U (H)
Accessories:	IR remote control, power cord
Weight:	3 kg (6.6 lbs.) approx.

¹ Specifications are subject to change without notice

9 Communication Protocol¹

The Com port setting details are: Baud Rate: 9600/115200, Parity: none, Data Bits: 8 bits, Stop Bits: 1 bit, Set CTS Mode: Off, and Set XON/XOFF: Off.

Table 7: RS-232 Protocol

Field 1	Field 2	Field 3	Field 4	Field 5
"L"	" "	"Code"	"~Code"	0x0d
"L" ASCII Code, 1 byte	" " ASCII space, 1 byte	"xx" Code Str, 2 byte	"xx" is 1's complement of Code str, 2 byte	0x0d, 1 byte

Example: Menu On Command is "L 12ED" + Enter

Table 8: RS-232 Communication Code

Item	Code	Code(Hex)	~Code(Hex)	Function	Command
1	18	0x12	0xED	Menu	L 12ED
2	19	0x13	0xEC	Volume +	L 13EC
3	20	0x14	0xEB	Volume -	L 14EB
4	21	0x15	0xEA	Source	L 15EA
5	22	0x16	0xE9	VGA1	L 16E9
6	23	0x17	0xE8	VGA2	L 17E8
7	24	0x18	0xE7	DVI	L 18E7
8	25	0x19	0xE6	Component	L 19E6
9	26	0x1A	0xE5	Video 1	L 1AE5
10	27	0x1B	0xE4	Video 2	L 1BE4
11	28	0x1C	0xE3	Freeze	L 1CE3
12	29	0x1D	0xE2	PIP	L 1DE2
13	30	0x1E	0xE1	Auto Image	L 1EE1
14	31	0x1F	0xE0	Auto Gain	L 1FE0
15	32	0x20	0xDF	Zoom +	L 20DF
16	33	0x21	0xDE	Zoom -	L 21DE
17	34	0x22	0xDD	Mute	L 22DD
18	35	0x23	0xDC	Brightness	L 23DC
19	36	0x24	0xDB	Contrast	L 24DB
20	37	0x25	0xDA	Mode	L 25DA
21	38	0x26	0xD9	Normal	L 26D9
23	40	0x27	0xD8	Presentation	L 27D8
22	39	0x28	0xD7	Cinema	L 28D7
24	41	0x29	0xD6	Nature	L 29D6
25	42	0x2A	0xD5	USER 1	L 2AD5
26	43	0x2B	0xD4	USER 2	L 2BD4
27	44	0x2C	0xD3	SWAP	L 2CD3
28	45	0x2D	0xD2	Scale	L 2DD2
29	46	0x2E	0xD1	Normal	L 2ED1
30	47	0x2F	0xD0	WideScreen	L 2FD0
31	48	0x30	0xCF	Pan & Scan	L 30CF
32	49	0x31	0xCE	4:3	L 31CE
33	50	0x32	0xCD	Up	L 32CD
34	51	0x33	0xCC	Down	L 33CC
35	52	0x34	0xCB	Left	L 34CB
36	53	0x35	0xCA	Right	L 35CA
37	54	0x36	0xC9	Enter	L 36C9

¹ This Communication Protocol also applies to the VP-719DS, as well as to the VP-720DS and VP-723DS

Communication Protocol

Item	Code	Code(Hex)	~Code(Hex)	Function	Command
38	55	0x37	0xC8	Status	L 37C8
39	56	0x38	0xC7	Enter+UP	L 38C7
40	57	0x39	0xC6	C-Video 1	L 39C6
41	58	0x3A	0xC5	C-Video2	L 3AC5
42	59	0x3B	0xC4	S-Video 1	L 3BC4
43	60	0x3C	0xC3	S-Video 2	L 3CC3
44	61	0x3D	0xC2	OUT	L 3DC2
45	62	0x3E	0xC1	Blank	L 3EC1
46	70	0x46	0xB9	Factory Reset	L 46B9
47	71	0x47	0xB8	Key Lock	L 47B8
48	176	0xB0	0x4F	PIP On	L B04F
49	177	0xB1	0x4E	PIP Off	L B14E
50	178	0xB2	0x4D	Freeze On	L B24D
51	179	0xB3	0x4C	Freeze Off	L B34C
52	180	0xB4	0x4B	Mute On	L B44B
53	181	0xB5	0x4A	Mute Off	L B54A
54	182	0xB6	0x49	Blank On	L B649
55	183	0xB7	0x48	Blank Off	L B748
56	184	0xB8	0x47	Key Lock On	L B847
57	185	0xB9	0x46	Key Lock Off	L B946
58	186	0xBA	0x45	Output Resolution	L BA45 **
59	227	0xE3	0x1C	PIP Size	L E31C **
				** is Resolution index	
				** is PIP size index	

Table 9: RS-232 Read Command

Command Sent		Return	
Source	K 15EA	VGA1	K 16E9
		VGA2	K 17E8
		DVI	K 18E7
		Component	K 19E6
		C-Video 1	K 39C6
		C-Video 2	K 3AC5
		S-Video 1	K 3BC4
		S-Video 2	K 3CC3
Freeze	K 1CE3	Freeze On	K B24D
		Freeze Off	K B34C
PIP	K 1DE2	PIP On	K B04F
		PIP Off	K B14E
Mute	K 22DD	Mute On	K B44B
		Mute Off	K B54A
Blank	K 3EC1	Blank On	K B649
		Blank Off	K B748
Key Lock	K 47B8	Key Lock On	K B847
		Key Lock Off	K B946
Output Resolution	K BA45	640x480	K 00FF
		800x600	K 01FE
		1024x768	K 02FD
		1280x1024	K 03FC
		1600x1200	K 04FB
		852x1024i	K 05FA
		1024x1024i	K 06F9
		1366x768	K 07F8
		1366x1024	K 08F7
		1280x720	K 09F6
		720x483	K 0AF5
		480P	K 0BF4
		720P	K 0CF3
		1080i	K 0DF2
VGA/DVI Resolution	K E01F	640x480	K 00FF
		NTSC 60	K 01FE
		PAL 50	K 02FD
		720x400	K 03FC
		800x600	K 04FB
		832x624	K 05FA
		1024x768	K 06F9
		1024x800	K 07F8
		1152x870	K 08F7
		1280x960	K 09F6
		1280x1024	K 0AF5
		1600x1200	K 0BF4
		1280x720P	K 0CF3
		853x480P	K 0DF2
		1920x1080i	K 0EF1
		720x576P	K 0FF0
		1152x900	K 10EF
		1400x1050	K 11EE
		No Signal	K FF00
VGA/DVI Refresh rate	K E11E	Refresh rate(Hex)	K ###&&
		No Signal	K FF00
Video Standard	K E21D	NTSC	K 01FE
		NTSC 4.43	K 02FD
		PAL	K 03FC
		PAL N	K 04FB
		PAL M	K 05FA
		SECAM	K 06F9
		PAL 60	K 07F8
		NTSC 4.43 50	K 08F7
		No Signal	K FF00
PIP Size	K E31C	1/25	K 00FF
		1/16	K 01FE
		1/9	K 02FD
		1/4	K 03FC
		Split	K 04FB
PIP H position	K E41B	H position(Hex)	K ###&&
PIP V position	K E51A	V position(Hex)	K ###&&

is Value,&& is ## invert

is Value,&& is ## invert



LIMITED WARRANTY

Kramer Electronics (hereafter *Kramer*) warrants this product free from defects in material and workmanship under the following terms.

HOW LONG IS THE WARRANTY

Labor and parts are warranted for three years from the date of the first customer purchase.

WHO IS PROTECTED?

Only the first purchase customer may enforce this warranty.

WHAT IS COVERED AND WHAT IS NOT COVERED

Except as below, this warranty covers all defects in material or workmanship in this product. The following are not covered by the warranty:

1. Any product which is not distributed by Kramer, or which is not purchased from an authorized Kramer dealer. If you are uncertain as to whether a dealer is authorized, please contact Kramer at one of the agents listed in the web site www.kramerelectronics.com.
2. Any product, on which the serial number has been defaced, modified or removed.
3. Damage, deterioration or malfunction resulting from:
 - i) Accident, misuse, abuse, neglect, fire, water, lightning or other acts of nature
 - ii) Product modification, or failure to follow instructions supplied with the product
 - iii) Repair or attempted repair by anyone not authorized by Kramer
 - iv) Any shipment of the product (claims must be presented to the carrier)
 - v) Removal or installation of the product
 - vi) Any other cause, which does not relate to a product defect
 - vii) Cartons, equipment enclosures, cables or accessories used in conjunction with the product

WHAT WE WILL PAY FOR AND WHAT WE WILL NOT PAY FOR

We will pay labor and material expenses for covered items. We will not pay for the following:

1. Removal or installations charges.
2. Costs of initial technical adjustments (set-up), including adjustment of user controls or programming. These costs are the responsibility of the Kramer dealer from whom the product was purchased.
3. Shipping charges.

HOW YOU CAN GET WARRANTY SERVICE

1. To obtain service on you product, you must take or ship it prepaid to any authorized Kramer service center.
2. Whenever warranty service is required, the original dated invoice (or a copy) must be presented as proof of warranty coverage, and should be included in any shipment of the product. Please also include in any mailing a contact name, company, address, and a description of the problem(s).
3. For the name of the nearest Kramer authorized service center, consult your authorized dealer.

LIMITATION OF IMPLIED WARRANTIES

All implied warranties, including warranties of merchantability and fitness for a particular purpose, are limited in duration to the length of this warranty.

EXCLUSION OF DAMAGES

The liability of Kramer for any effective products is limited to the repair or replacement of the product at our option. Kramer shall not be liable for:

1. Damage to other property caused by defects in this product, damages based upon inconvenience, loss of use of the product, loss of time, commercial loss; or
2. Any other damages, whether incidental, consequential or otherwise. Some countries may not allow limitations on how long an implied warranty lasts and/or do not allow the exclusion or limitation of incidental or consequential damages, so the above limitations and exclusions may not apply to you.

This warranty gives you specific legal rights, and you may also have other rights, which vary from place to place.

NOTE: All products returned to Kramer for service must have prior approval. This may be obtained from your dealer.

This equipment has been tested to determine compliance with the requirements of:

- EN-50081: "Electromagnetic compatibility (EMC);
generic emission standard.
Part 1: Residential, commercial and light industry"
- EN-50082: "Electromagnetic compatibility (EMC) generic immunity standard.
Part 1: Residential, commercial and light industry environment".
- CFR-47: FCC Rules and Regulations:
Part 15: "Radio frequency devices
Subpart B – Unintentional radiators"

CAUTION!

- ☒ Servicing the machines can only be done by an authorized Kramer technician. Any user who makes changes or modifications to the unit without the expressed approval of the manufacturer will void user authority to operate the equipment.
- ☒ Use the supplied DC power supply to feed power to the machine.
- ☒ Please use recommended interconnection cables to connect the machine to other components.



**For the latest information on our products and a list of Kramer distributors, visit our Web site: www.kramerelectronics.com.
Updates to this user manual may be found at
<http://www.kramerelectronics.com/manuals.html>.
We welcome your questions, comments and feedback.**

Kramer Electronics, Ltd.

3 Am VeOlamo Street. Jerusalem 95463, Israel Tel: (+972-2)-654-4000

Fax: (+972-2)-653-5369, E-mail: info@kramerel.com

P/N: 2900 – 007004 REV 3

Free Manuals Download Website

<http://myh66.com>

<http://usermanuals.us>

<http://www.somanuals.com>

<http://www.4manuals.cc>

<http://www.manual-lib.com>

<http://www.404manual.com>

<http://www.luxmanual.com>

<http://aubethermostatmanual.com>

Golf course search by state

<http://golfingnear.com>

Email search by domain

<http://emailbydomain.com>

Auto manuals search

<http://auto.somanuals.com>

TV manuals search

<http://tv.somanuals.com>