



KRAMER ELECTRONICS, Ltd.

USER MANUAL

Vertical Interval Switchers

MODELS: VS-1211, VS-1011, VS-811, VS-611, VS-411

With Balanced Audio

VS-1201xl, VS-1001xlm, VS-801xlm, VS-601xlm, VS-401xlm

With Unbalanced Audio

**IMPORTANT: Before proceeding, please read paragraph entitled
"Unpacking and Contents"**



Table of Contents

Section	Name	Page
1	INTRODUCTION	4
1.1	A Word On Video/Audio Switchers	4
1.2	Factors Affecting Quality of Results	5
2	SPECIFICATIONS	6
3	HOW DO I GET STARTED?	7
4	UNPACKING AND CONTENTS	7
4.1	Optional Accessories	7
5	KRAMER "VS" SERIES SWITCHERS	8
5.1	Getting to Know Your Switcher	9
6	INSTALLATION	11
6.1	Rackmounting	11
7	CONNECTING TO VIDEO DEVICES	11
7.1	Connecting to the VS-1211/1201xl/1001xlm	11
8	CONNECTING TO AUDIO DEVICES	11
8.1	Connecting to the VS-1211	11
8.2	Connecting to the VS-1201xl	11
9	DIP SWITCHES, JUMPERS AND TRIMMERS	11
9.1	DIP Switches	11
9.2	Jumpers, their Uses and Set-up Requirements	12
9.3	The Internal Trimmers	14
10	CONTROLLING THE SWITCHER	14
10.1	The VS-2000 System	14
10.2	The VS-1N/VS-1P System	14
11	CONNECTING TO A PC	16
11.1	New Protocol 2000	16
11.1.1	Changing Communication Protocols	16
11.1.2	Additional Software Options	16
12	USING THE SWITCHER	16
12.1	Powering on the Switcher	16
12.2	Operating an Individual Switcher	16
12.2.1	Selecting an Input on the Switchers	17
12.2.2	Selecting the Proper Sync Format	17
12.2.3	Using the VS-2000	17
12.3	Using the PC Control Software	17
12.4	Adding Outputs	17
12.5	Adding Inputs	18
12.6	Video Component and YC Switching	19
12.7	Controlling Several Independent Switchers via a Single PC Port	19
13	TAKING CARE OF YOUR SWITCHER	19
14	TROUBLESHOOTING	19
14.1	Power and Indicators	20
14.2	Video Signal	20
14.3	Audio Signal	21
14.4	Software	22
14.5	Control	22
14.6	Switching Malfunctions	22
14.7	Vertical Interval	23
15	PROTOCOL USED FOR VS-1211/1201xl COMMUNICATION	23
	Limited Warranty	24



Table of Contents (Continued)

List of Illustrations

Figure		Page
1	RS-232 Control Connector Wiring	8
2	VS-1211/1201 Front/Rear Panel Features	9
3	Location of Internal Jumpers	13
4	VS-Series Remote Connector Socket and Balanced Audio Pinout	15
5	Connecting Two Switchers to add Outputs	18

List of Tables

Table		
1	VS-1211/1201 Front Panel Features	10
2	VS-1211/1201 Rear Panel Features	10
3	DIP Switch Settings	12



1. INTRODUCTION

Congratulations on your purchase of this Kramer Electronics switcher.

Since 1981 Kramer has been dedicated to the development and manufacture of high quality video/audio equipment.

The Kramer industrial line has become an integral part of many of the best video/audio production and presentation facilities around the world. In recent years, Kramer has redesigned and upgraded most of the industrial line, making the best even better. Kramer's line of professional video electronics is one of the most versatile and complete available, and is a true leader in terms of quality, workmanship, price/performance ratio and innovation. In addition to the Kramer line of high quality video switchers, such as the one you have just purchased, Kramer also offers a full line of high quality industrial and broadcast distribution amplifiers, processors, interfaces, controllers and computer-related products. Kramer welcomes your inquiries for Kramer equipment or custom-manufactured products, engineering, private labeling and OEM manufacturing per your specifications.

This manual includes configuration, operation and option information for the following products from the Kramer VS line of video switchers. These VS switchers are similar in operation and features and differ in their audio input and output type.

Balanced Audio Family:

- **VS-1211-** 12x1 composite/single component video & balanced audio switcher.
- **VS-1011-** 10x1 composite/single component video & balanced audio switcher.
- **VS-811-** 8x1 composite/single component video & balanced audio switcher.
- **VS-611-** 6x1 composite/single component video & balanced audio switcher.
- **VS-411-** 4x1 composite/single component video & balanced audio switcher.

Unbalanced Audio Family:

- **VS-1201xl-** 12x1 composite/single component video & unbalanced audio switcher.
- **VS-1001xlm-** 10x1 composite/single component video +DA & unbalanced audio switcher.
- **VS-801xlm-** 8x1 composite/single component video +DA & unbalanced audio switcher.
- **VS-601xlm-** 6x1 composite/single component video +DA & unbalanced audio switcher.
- **VS-401xlm-** 4x1 composite/single component video +DA & unbalanced audio switcher.

1.1 A Word on Video/Audio Switchers

A video/audio switcher usually switches between several sources (inputs) and one or more acceptors (outputs). A switcher that allows several inputs to be connected to several outputs simultaneously is called a Matrix Switcher. Switchers may be of the electronic or mechanical type. Most matrices are of the active electronic type, with many crosspoints. Vertical Interval Switching, frequently used in video, ensures that the transition from one video source to another (such as switching between two genlocked cameras) is smooth and without interference. The switching and changeover is done during the blanked vertical interval period, when the transition is hidden.

Genlocked means synchronized so that the color and phase information from each source is identical. Thus switching is done with no interference, no rolling, no color loss and no jumping on the screen. Since the Syncs come with the same timing, all the information is identical and the transition between one source and the other is smooth.

Vertical Interval Switching is needed when recording or transmitting a video program involving several video sources, as in live broadcast, to ensure clean, undisturbed picture transitions.

Matrices and switchers may sometimes be RS-232 or RS-485/422 controlled. Each of these options is a way of remotely controlling a video/audio device (switcher, SEG, etc.) using a PC with a serial port, or another device that uses a similar communication protocol.

The range consists of a number of models, having between twelve and four inputs, as indicated by the model name. The audio output is either balanced or unbalanced. Switching is effortless and is performed during the vertical interval of source #1, or of the video available at the external Sync socket. The switchers can be controlled by touch buttons on the front panel, by a PC, via the switcher's built-in RS-232 and/or RS-485/422 communication ports, or by contact closure via a remote socket on the back panel.

All the models can be interconnected in a variety of ways. For example, two VS-1211 units become 24x1 or 12x2, etc. Three or four VS-1211 units, depending on whether the system is RGB or RGBS, become a 12x1 video component switcher. Finally, the video signal bandwidth is 225MHz (typical), which permits the switchers to be used in the most demanding applications.

1.2 Factors Affecting Quality of Results

There are many factors affecting the quality of results when signals are transmitted from a source to an acceptor:

- **Connection cables** - Low quality cables are susceptible to interference, they degrade signal quality due to poor matching and cause elevated noise levels. They should therefore be of the best quality.
- **Sockets and connectors of the sources and acceptors** - So often ignored, they should be of highest quality, since "Zero Ohm" connection resistance is the target. Sockets and connectors also must match the required impedance (75ohms in video). Cheap, low quality connectors tend to rust, thus causing breaks in the signal path.
- **Amplifying circuitry** - Must have quality performance when the desired end result is high linearity, low distortion and low noise operation.
- **Distance between sources and acceptors** - Plays a major role in the final result. For long distances (over 15 meters) between sources and acceptors, special measures should be taken in order to avoid cable losses. These include using higher quality cables or adding line amplifiers.
- **Interference from neighboring electrical appliances** - These can have an adverse effect on signal quality. Balanced audio lines are less prone to interference, but unbalanced audio and video lines should be installed far from any mains power cables, electric motors, transmitters, etc. even when the cables are shielded.



2. SPECIFICATIONS

Models	VS-1211, VS-1011, VS-811, VS-611, VS-411, VS-1201xl, VS-1001xlm, VS-801xlm, VS-601xlm, VS-401xlm									
Inputs	<p>12, 10, 8, 6, 4 video - composite/single component, 1Vpp/75ohm on BNC connectors.</p> <p>12, 10, 8, 6, 4 balanced/unbalanced audio, +4dBm/10kohm, on 2-part, snap fit terminal blocks (for the "11" group only), or RCA connectors (for the "01xl/m" group only).</p> <p>One external sync input (or composite video) 1Vpp/75ohm, on BNC connector.</p> <p>One RS-232 DB-9 control socket, DB-9 socket ("to next"), RS-485 terminal block, DB-15 for remote connector.</p>									
Outputs	<p>One video - composite/single component, 1Vpp/75ohm on BNC connector (VS-1211, VS-1201xl), Three video 1Vpp/75ohm on BNCs (VS-1001xlm, 801xlm,601xlm, 401xlm.)</p> <p>One audio – balanced/unbalanced audio, up to +28Vpp/50ohm (24dBm), on snap fit terminal blocks (for the "11" group only) or RCA connector (for the 1201xl only), 3 sets of stereo audio on RCAs (VS-1001xlm, VS-801xlm, VS-601xlm, VS-401xlm.)</p>									
Bandwidth (Video)	<p>250 MHz -3dB for VS-1211, VS-1011, VS-811, VS-611, VS-411, VS-1201xl.</p> <p>400 MHz -3dB for VS-1001xlm, VS-801xlm, VS-601xlm, VS-401xlm.</p>									
Non-linearity	<0.1%.									
S/N Ratio	>77dB.									
Diff. Phase	0.03°									
Diff. Gain	0.04%									
K-Factor	<0.05%									
Bandwidth (Audio)	55kHz, -0.1dB.									
Audio S/N Ratio	>95dB (unweighted)									
2nd Harmonic	<0.003% (1kHz)									
Audio THD + Noise	0.013%									
Audio Crosstalk	-79dB									
Video Controls	Bottom accessible trimmers for video gain (-1.2 to 1.8dB Luma), cable EQ. (0 to 1.3dB)									
Dimensions (W, D, H)	19" x 7" x 1U rack mountable									
Weight	VS-1211 3.1kg (~7lbs)	VS-1011 2.9kg (~6.6lbs)	VS-811 2.9kg (~6.5lbs)	VS-611 2.88kg (~6.4lbs)	VS-411 2.68kg (~5.9lbs)	VS-1201xl 3.1kg (~7lbs)	VS-1001xlm 2.9kg (~6.6lbs)	VS-801xlm 2.9kg (~6.5lbs)	VS-601xl m 2.88kg (~6.4lbs)	VS-401xl m 2.68kg (~5.9lbs)
Power consumption	16VA	15VA	16.1VA	18.4VA	19.5VA	16VA	15VA	16.1VA	18.4VA	19.5VA
Power Source	230VAC, 50/60 Hz (115VAC U.S.A.)									



3. HOW DO I GET STARTED?

The fastest way to get started is to take your time and do everything right the first time. Taking 15 minutes to read this manual may save you a few hours later. You don't even have to read the whole manual. At the beginning of each section, you'll find an overview of the section. So if the section doesn't apply to you, you don't have to spend your time reading it.

4. UNPACKING AND CONTENTS

The items contained in your Kramer VS switcher package are listed below. Please save the original box and packaging materials for possible future transportation and shipment of the video switcher.

- This User Manual
- Your KRAMER Switcher
- A Power Cord
- KRAMER K-Switch Software for Windows 95/98® (A CD plus Booklet or download from the web)
- KRAMER Null Modem Adapter Connector
- A Concise Directory of KRAMER Products

4.1 Optional Accessories

The following accessories, which are available from Kramer, can enhance implementation of your amplifier. For information regarding cables and additional accessories, contact your Kramer dealer.

- **BNC "Y" Connector** - Used for looping purposes and splits the incoming signal to enable connection of an additional machine.
- **SP-11** - (Video/Audio Processor) can be serially connected between the video/audio source and the switcher for video and audio control/correction. The machine provides camera control and luminance/white balance correction. The SP-11 is also capable of performing composite to Y/C conversion and bi-directional transcoding. The machine allows full control over the video signal: video gain down to full fade, log or linear definition control, log or linear contrast control, color saturation control, black level control, red, green and blue controls and a screen splitter control for "before-after" comparison. The Input switch control is "audio-follow-video".
- **VM-1411** (Video/Balanced Stereo Audio Distribution Amplifier) can be serially connected between the switcher and the acceptors for video and audio distribution. It is a full broadcast, state-of-the-art machine, designed for studio and other applications. The VM-1411 has two inputs, video and audio, each splitting to 5 outputs. The user may select 2 x 1:5 or 1:10 operation via front panel control switches. Several VM-1411 units may be chained through the looping inputs. Output signals are (user selectable) DC or AC coupled for highest flexibility. Audio outputs are buffered and isolated from each other, allowing Hi-Fi Balanced audio distribution.
- **VIDEO TESTER** - A new, unique, patented, indispensable tool for the video professional, the video Tester is used to test a video path leading to/from an amplifier. By pressing only one touch switch it can trace missing signals, distinguish between good and jittery (VCR sourced) signals, and identify the presence of good signals. Whenever a video signal is missing, because of bad connections, cable breaks or faulty sources, the video Tester is all you need.

5. KRAMER “VS” SERIES SWITCHERS

This section shows you all of the controls and connections of your switcher. Understanding all of the controls and connections helps you realize its full power. All the switchers described in this manual are equipped with RS-232 Connectors (for PC control) and the connector wiring is described in Figure 1. The Kramer **VS-1211**, **VS-1201xl**, **VS-1011**, **VS-1001xlm**, **VS-811**, **VS-801xlm**, **VS-611**, **VS-601xlm**, **VS-411** and **VS-401xlm** Vertical Interval Switchers provide truly effortless switching between twelve, ten, eight, six or four video and balanced/unbalanced audio inputs to one output (video and audio). Switching is done during vertical interval, either of source no. 1 or of the video connected to the external sync socket. The switchers may be controlled in three ways: touch buttons, RS-232/RS-485 and contact closure via a remote socket on the back of the machines. All the units in this line can be interconnected and cascaded, (two **VS-1211** machines become 24x1, etc.) The machines may also be operated in parallel (three **VS-1211** machines become a 12x3 video component switcher). Video signal bandwidth is 250MHz (typical), allowing the machines to be used in the most demanding applications.

RS-232 Null Modem Connection

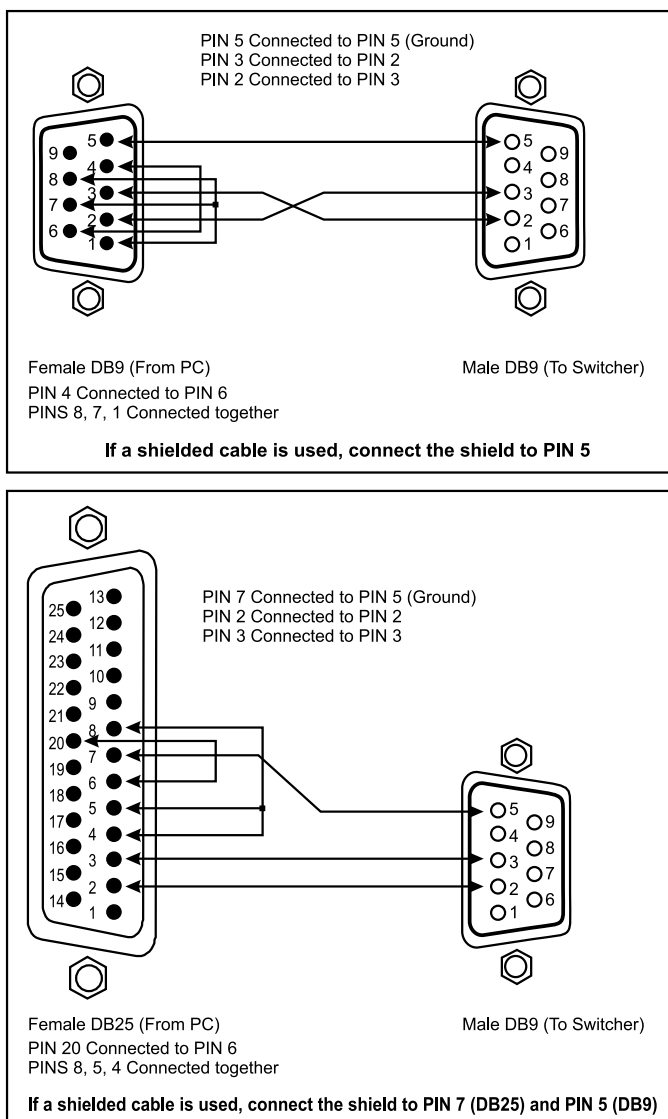
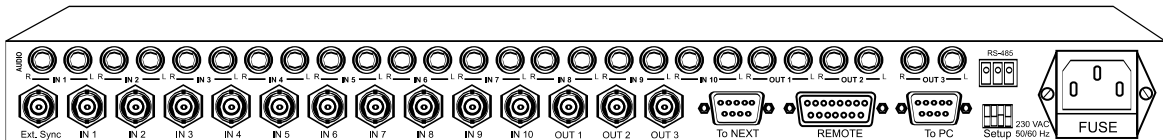
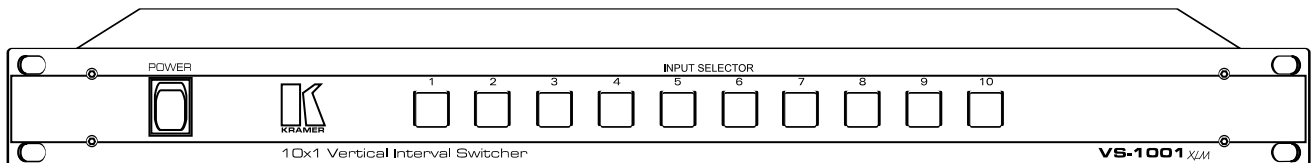
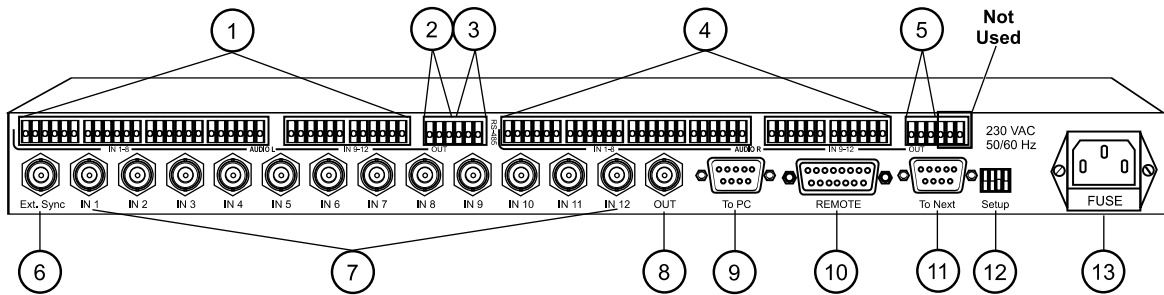
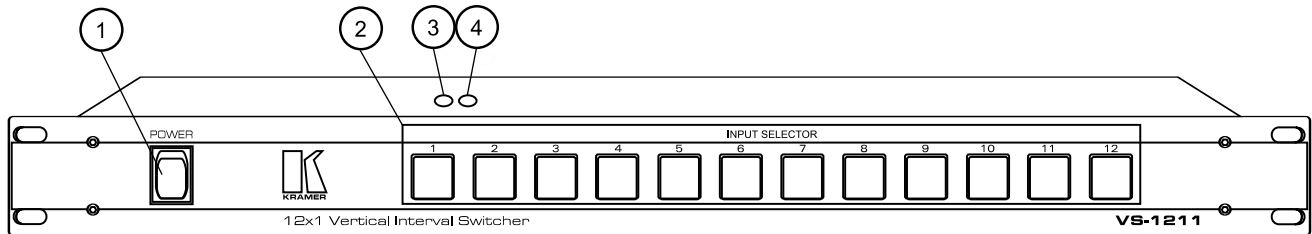

Figure 1: RS-232 Control Connector Wiring

5.1 Getting to Know Your Switcher

Most front/rear panel features of the switchers described in this manual are very similar. Therefore, only the VS-1211 and the VS-1201xl are described and they represent the rest of the switchers. The main difference is that the “11” group has snap fit terminal block connectors for balanced audio and the “01xl” group has RCA connectors for unbalanced audio.

Front/rear panel features of the VS-1211 and VS-1201xl/VS-1001xm switchers are described in Figure 2, Table 1 and Table 2.



VS-1001xlm Front and Back panel

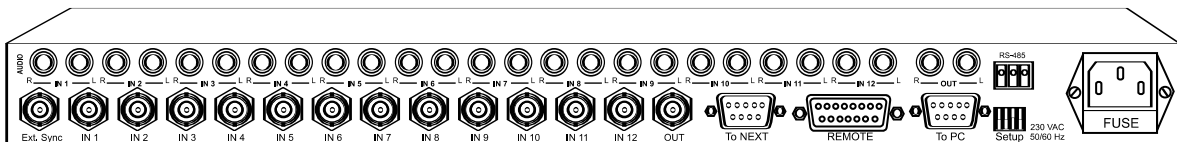

VS-1201xl Front and Back panel

Figure 2: VS-1011xlm/VS-1201xl Front/Rear Panel Features



Table 1: VS-1211/1201/1001xlm Front Panel Features

No.	Feature	Function
1.	POWER Switch	Illuminated switch: Supplies power to the unit.
2.	INPUT SELECTOR pushbuttons	Each input may be selected by the corresponding input select button. The buttons illuminate when pressed and the illuminated input select button identifies the active input.
3.	Internal cable EQ. trimmer	Internally located and accessed through hole in the switcher base. It allows, if necessary, to control cable equalization.
4.	Internal LEVEL trimmer	Internally located and accessed through hole in the switcher base. It allows, if necessary, to adjust switcher output signal level.

Table 2: VS-1211/1201/1001xlm Rear Panel Features

No.	Feature	Function
1.	AUDIO L snap fit terminal blocks for the "11" group or RCA connectors for the "01xP" group.	12, 10, 8, 6 or 4 left channel inputs used to connect the appropriate number of stereo audio input sources 1-12. (see Figure 4).
2.	OUT L snap fit terminal blocks for the "11" group or RCA connector for the "01xP" group.	Left channel audio output (3 outputs for "xlm" series).
3.	RS-485 Two-part, snap fit terminal block	Used for bi-directional communication with another switcher or PC through RS-485 interface.
4.	AUDIO R snap fit terminal blocks for the "11" group or RCA connectors for the "01xP" group.	12, 10, 8, 6 or 4 right channel inputs used to connect the appropriate number of stereo audio input sources 1-12.
5.	OUT R snap fit terminal blocks for the "11" group or RCA connector for the "01xP" group.	Right channel audio output (3 outputs for "xlm" series).
6.	Ext. Sync BNC connector	Connection of an external sync/composite video input.
7.	IN1-IN12 BNC connectors	12, 10, 8, 6 or 4 video inputs used to connect the appropriate number of composite or single video input sources, including cameras, VCRs. Supported formats: composite/single component video.
8.	OUT BNC connector (s)	Video output having same connector and formats as the input (3 outputs for "xlm" series).
9.	DB-9 female To PC connector	Used for control of the switcher from a PC or remote control panel, through RS-232 interface. NOTE <i>Operation of the switcher from a remote PC may be performed by the K-Switch Software provided with the switcher.</i>
10.	REMOTE DB-15 connector	Used for remote contact closure control (see Figure 4).
11.	To Next DB-9 connector	Used for looping to the next switcher.
12.	SETUP DIP switches	Allow proper configuration of the control signals received and transmitted through the RS-232 (or RS-485) control port, master/slave configurations, and device ID numbers.
13.	Power Connector	A 3-prong AC connector allows power to be supplied to the unit. Directly underneath this connector, a fuse holder houses the appropriate fuse.



6. INSTALLATION

6.1 Rackmounting

Each of the amplifiers included in this manual may be rackmounted in a standard 19" (1U) EIA rack assembly and includes rack "ears" at the ends of the front panel. (The optional VS-2000 controller requires 2U of rack height, at 3.5".) These devices do not require any specific spacing above or below the unit for ventilation. To rack mount any of the switchers, simply place the unit's rack ears against the rack rails of the rack, and insert standard screws through each of the four corner holes in the rack ears.

7. CONNECTING TO VIDEO DEVICES

Video sources and output devices (such as monitors, projectors or recorders) may be connected to the switchers through the BNC type connectors located on the back of the unit. Please keep in mind that the input signal format must match that of the output signal format. (Example: If input is Composite video, then output is Composite video.) All signal connections that use more than one cable interconnecting between devices should be of equal length. (Example: R, G, B cables between a camera and the switcher should be equal in length).

NOTE

The switchers described in this manual are very similar. The connections of the VS-1211 and the VS-1201xl are described and may be applied accordingly to the others.

7.1 Connecting To the VS-1211/1201xl/1001xlm

Video sources and output devices connected to the VS-1211/1201xl/1001xlm models support composite/single component video signal types, via BNC connectors.

8. CONNECTING TO AUDIO DEVICES

8.1 Connecting To the VS-1211

Audio sources and output devices (such as amplifiers or recorders) may be connected to the VS-1211 switcher through the snap fit terminal blocks located on the back of the unit.

8.2 Connecting To the VS-1201xl/1001xlm

Audio sources and output devices (such as amplifiers or recorders) may be connected to the VS-1201xl switcher through the RCA type connectors located on the back of the unit.

9. DIP SWITCHES, JUMPERS AND TRIMMERS

Consider the VS-1211 as an example of all the switchers in the family. It switches video and balanced stereo audio simultaneously. As mentioned previously, there are three options for operating the switcher. All are available without removing the switcher cover.

- It can be operated by touching one of the front panel switches.
- It can be operated by a remote PC via the RS-232 or RS-485/422 connectors on its rear panel.
- It can be operated using the contact closure option.

9.1 DIP Switches

The DIP switch (see Table 3) on the rear panel should be set when the switcher is operated via the RS-232 or RS-485/422 connector, or when it is interconnected with other switchers. These switches allow proper configuration of the control signals received and transmitted through the RS-232 control port. Each of the "VS" switchers allows master/slave configurations. This allows the switchers to operate independently, or in conjunction with each other.

Table 3: DIP Switch Settings

Switcher #	DIP Switch #			
	1 (Reply)	2	3	4
Machine 1 (Master)	ON	ON	ON	ON
Machine 2 (Slave)	ON or OFF	ON	ON	OFF
Machine 3 (Slave)	ON or OFF	ON	OFF	ON
Machine 4 (Slave)	ON or OFF	ON	OFF	OFF
Machine 5 (Slave)	ON or OFF	OFF	ON	ON
Machine 6 (Slave)	ON or OFF	OFF	ON	OFF
Machine 7 (Slave)	ON or OFF	OFF	OFF	ON
Machine 8 (Slave)	ON or OFF	OFF	OFF	OFF

NOTE

The Slave "Reply" settings are all ON or all OFF, depending on the requirements of the system (see detailed configuration in section 12.4-12.6). The Master "Reply" setting is always ON.

9.2 Jumpers, their Uses and Set-up Requirements

The switcher has additional adjustments and settings. These include the internal jumpers.

WARNING!

Mains voltage is accessible inside the switcher, so always turn off the switcher and remove its power cable from the mains socket before removing its cover.

The jumper locations are illustrated in Figure 3, and their functional operation is described below:

- Each switcher input has its own internal jumper. In the VS-1211, these jumpers are numbered J21 to J33 and they are factory located in the position that provides a 75ohm input termination. If the 75ohm termination is not required, the jumper must be relocated to its alternate position (floating on the pin remote from the input socket and not connected in any circuit). The particular input is now "High-Z" (not 75ohm terminated) and may be used for looping.
- When two VS-1211 switchers are to be interconnected to provide a 12 input, 2 output (12x2) configuration by looping Input #1 of switcher #1 to Input #1 of switcher #2, etc., J35 must be located in its alternate position in all of the switchers. This is also the case for configurations 12x3, 12x4, etc., using 3, 4, or more switchers.
- When two VS-1211 switchers are to be interconnected to provide a 24 input, 1 output (24x1) configuration, J35 must be located in its factory set position in all of the switchers. This is also the case for configurations 36x1, 48x1, etc., using 3, 4, or more switchers.
- Jumper J20 is used to define the Sync video source for all the switcher inputs, so that Vertical Interval Switching can be assured. The jumpers are factory located for an External Sync source. If the sync of the video source on Input #1 is preferred, then J20 must be relocated to its alternate position in any one of the switchers.
- When switchers are to be interconnected, the switcher that contains the active video sync source must be identified to all the switchers so that it can be sensed by all of them and thus ensure Vertical Interval Switching throughout. J34 is the jumper to be used for this task. It is factory located to identify the switcher in which it sits. Thus, in the switcher to which the active sync source will be connected, the jumper must be left in the factory located position. In all the other switchers in the interconnected complex, J34 must be relocated in its alternate position.

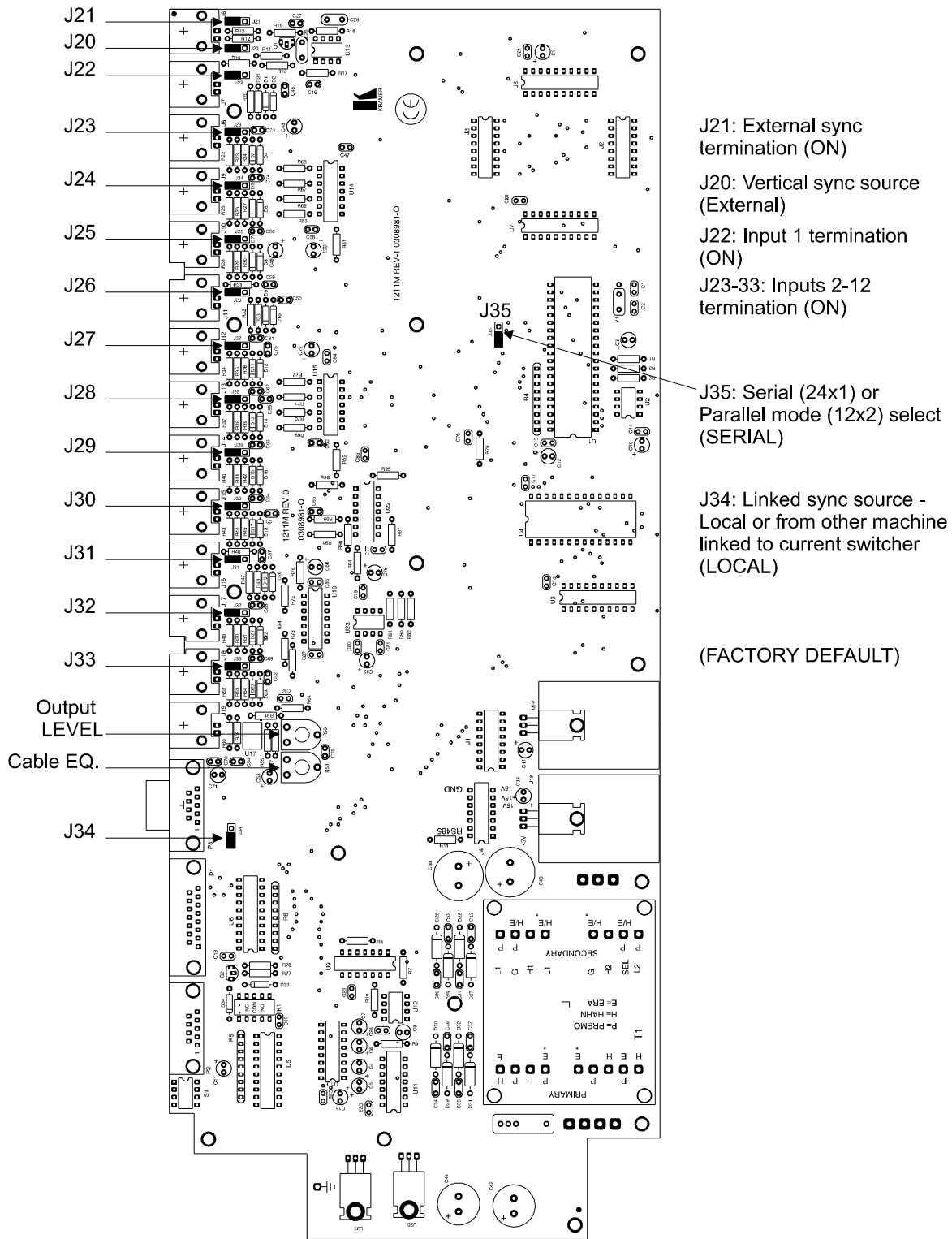

Figure 3 : Location of Internal Jumpers



9.3 The Internal Trimmers

The trimmers are internally located and are accessed through holes in the switcher base (see section 14.2 "Weak Switcher Video Signals"). These allow you, if necessary, to adjust the switcher output signal level and cable compensation.

10. CONTROLLING THE SWITCHER

The VS-1211/411 and VS-1201xl/401xlm switcher families can be controlled by the following methods:

- By touch buttons on the front panel (see section 12.2 "Operating an Individual Switcher").
- By direct remote contact closure via the DB-15 socket (a switch panel that the customer rigs up).
- By PC or other remote control via the switcher's RS-232 or RS-485/422 connector.

There are three different options for the RS-232 or RS-485/422 remote control:

1. A PC that communicates with the switcher directly.
2. A Serial remote control unit such as the KRAMER VS-2000 or VS-3000 (see section 10.1) or the VS-1N/P (see section 10.2) combination.
3. Any RS-232 or RS-485/422 controller, which is programmed according to the protocol of the switcher (see section 15 "Protocol Used for VS-1211 Communication").

10.1 The VS-2000 System

The KRAMER VS-2000 is a Programmable Remote Control Unit, designed for use in video production and duplication studios and in live broadcasting and editing configurations. It provides access to and control of up to six groups of KRAMER switchers from a single point. A group can comprise several interconnected switchers which, in turn, permit access to various pieces of equipment (monitors, mixers, editors, VCRs, etc). The VS-2000 can be controlled by pressing its front panel touch buttons, or via a PC using the RS-232 control port. KRAMER PC control software is provided with the BC-2000. Since new switcher types are constantly being added and older types upgraded, KRAMER provides a small door marked "EPROM" on the VS-2000 rear panel for easy replacement of the existing chip with an updated chip. This will contain the appropriate information for the new and modified switchers. KRAMER will make updated chips available periodically. The VS-2000 can store and recall preferred configurations for convenience in studio control.

10.2 The VS-1N/VS-1P System

The VS-1N RS-232 Remote Controller interfaces between any KRAMER RS-232 controlled switcher of the VS-1211/411 series, and a remotely located simple switching assembly. By pressing one of the remote switches, a connection command is sent to the switcher via the VS-1N and the RS-232 link. The VS-1N permits remote control of a KRAMER switcher, without interfering with local control by the built-in touch buttons on the switcher itself, and without using a PC. In fact, the VS-1N is a translator, simulating a computer to the switcher via its RS-232 port. It accepts mechanical contact switching from the remote point using a KRAMER VS-1P satellite unit or a switch panel that the customer rigs up himself. The VS-1P is an optional, 24-switch assembly connected to the VS-1N via a 25 wire flat cable, equipped with the appropriate connectors, and may be purchased separately as a small single unit. An alternative option is the VS-1P2, a dual VS-1P unit, in a 19-inch rack configuration. The VS-1N/VS-1P set-up is an ideal remote control for use in video production studios, in live broadcasting configurations, in CCTV and in security applications. The remote connector socket pinout and functional description are shown in Figure 4.



11. CONNECTING TO A PC

To connect directly to a PC without using the KRAMER Null-Modem Adapter, make connections as in Figure 1. To use the KRAMER Adapter instead (recommended), plug one end into the PC's serial port, then connect from the other end to the switcher using a 9-pin flat-cable. Alternatively, connect only pins 2, 3, and 5 from the Adapter to the switcher (one-to-one connection).

11.1 New Protocol 2000

All the switcher described in this manual have built-in a dual communication protocol option. The standard protocol described in this manual allows simple and fast control of a single switcher or several machines connected together. The new communication protocol named PROTOCOL 2000, allows the user to control several different switchers or switchers/matrix groups from one screen. The PC software backing up the new protocol is called K-ontrol, allowing viewing and monitoring four different machines, which have protocol 2000 built-in from one screen. The new protocol allows more control over the switchers, but is more complicated than the current protocol supported by the K-Switch software.

The full set of software and documentation is available on the software CD and on Kramer's website free for download. The new software package allows the user to install all versions of software suitable for the machine used. For the machines described in this manual, both the K-Switch and the K-ontrol software may be installed.

11.1.1 Changing communication protocols

You can work with one of 2 protocols. To work with PROTOCOL 2000, simultaneously press buttons 1 and 4 on the front panel and turn the machine off for at least 5 seconds. When you turn on the machine, it will use PROTOCOL 2000. Alternatively, you can work with the old protocol. To do so, simultaneously press buttons 1 and 3 on the front panel and turn the machine off for at least 5 seconds. When you turn on the machine, it will use the old protocol.

11.1.2 Additional software options

The latest version of the K-switch program allows the user to convert any of the switchers described in this manual to a very sophisticated sequential switcher with no extra cost. The program allows full control on the switching sequence, dwell time for each input etc. The latest software upgrades are available at Kramer's web site: www.kramerelectronics.com at the technical support section.

12. USING THE SWITCHER

12.1 Powering on the Switcher

The switcher should only be powered on after all connections are completed and all source devices have been powered on. Do not attempt to connect or disconnect any video, audio or control signals to the switcher while it is powered on. The switcher may be powered on by pressing the toggle switch on the far-left front panel to the up position. In the up position, the toggle switch glows, and the active input button illuminates as well.

12.2 Operating an Individual Switcher

NOTE

The operation of all the switchers described in this manual is similar. The VS-1211 operation is described and may be applied accordingly to the others.

Operation of the VS-1211 switcher units by local control is as follows:

1. Connect up to twelve video/audio-stereo sources to the input sockets of the switcher.
2. Connect a video/audio-stereo acceptor to the output socket of the switcher.



12.2.1 Selecting an Input on the Switchers

Input selection on the switchers described in this manual is simply made by pressing buttons marked "1", "2" etc. on the front panel, or by operating your preferred remote device (see "KRAMER Switcher Remote Control Options"). These buttons correspond to the input connections as marked on the back panel.

12.2.2 Selecting the Proper Sync Format

The Sync will be provided from an external video source. If you wish, instead, to use the sync of the video source connected to Input #1, you must make an internal jumper adjustment as described previously (see section 9.2).

12.2.3 Using the VS-2000

Connect, as required, each of the VS -2000 ports to each of the switcher groups. Perform the preset procedure to identify the switchers to the VS -2000 before you activate the system. You can control the switcher groups from the panel touch buttons. You can also control the VS -2000 by a remote computer connected to the "To PC" connector on the VS -2000. You will see on the screen a complex of switchers covering all the switcher groups connected to the VS -2000. You can address and control each of them from the PC.

12.3 Using the PC Control Software

The switcher comes with K-Switch control software for Windows 95 and a booklet describing its operation. To operate interconnected switchers via RS-232 and the KRAMER K-Switch software, perform the following steps, in order, before connecting the power cables:

1. Set up the Dipswitch on each switcher in accordance with "Table of DIP Switch Settings" (Table 3, Section 9) and mark them accordingly for future reference.
2. Set up the jumpers as described in "Jumpers, Their Uses and Set-up Requirements" (Section 9.2).
3. Connect the first switcher to the second switcher via their RS-485 communication ports (connect "A" to "A", and "B" to "B"). Similarly, continue the connection from the second to the third, and so on.
4. Connect the first switcher to the PC's COM port, via the null-modem adapter provided (see Note below and Figure 1.
5. Make sure that the RS-232 cable is not more than 30 feet long.
6. If several machines are looped, interconnect as described in the relevant section below (12.4, 12.5, 12.6, or 12.7)
7. Connect the power cable of each switcher to the mains and turn them ON.
8. Activate the computer and the KRAMER K-Switch software. Then click the mouse button at the appropriate location on the monitor display to operate all the switchers simultaneously.

NOTE

The KRAMER null-modem adapter is a small plug with two connectors: a DB-9 on one side and a DB-25 or DB-9 on the other. We provide it with all switchers that have RS-232 ports. It interfaces between the DB-9 connector on the switcher and the connector on the PC. Its function is to convert the PC output to a null-modem output and permit two way communication between the switcher and the PC. This is effected by the interconnections within the plug.

12.4 Adding Outputs

Two VS-1211 switchers may be interconnected to function as a 12x2 switcher by connecting the same numbered sources to the same numbered inputs of both switchers. However, before doing so, each switcher input has an internal jumper that must be properly set up to avoid double loading.

Proceed as follows:

1. After disconnecting the switcher from the mains voltage, carefully remove the cover of the first switcher that is to receive the source signals, remove jumpers J21 to J33 (for VS-1211) and relocate them in their alternate positions (floating on the pin remote from the input socket and not connected in any circuit).
2. The input impedance of each input is now "High-Z" (not 75ohm terminated) and is therefore suitable for this application. In the second switcher, the terminating jumpers stay in place, providing 75ohm terminations. Thus, you do not have to open the second switcher. Carefully close the first switcher.

3. Connect the output from video source #1 to the first switcher input #1, then to the second switcher input #1 using a T or Y connector. Repeat for source #2 and input #2, etc.
4. Connect one acceptor to the output of one switcher and another acceptor to the output of the other switcher. You now have a twelve input switcher complex with two outputs.
5. You can continue to expand the number of outputs by adding a third switcher, etc., to obtain a 12x3 switcher, etc. In such cases, relocate to their alternate position, all input jumpers in all switchers except the last, so that all the lines are properly terminated by 75ohm. Audio can be connected in a similar manner, but you do not have to open switchers and remove jumpers, just connect the wires from audio input to audio input. There is no need for special termination since the input impedance is high.
6. For RS-232 control of the system, connect the PC to the Master switcher via the null modem adapter.
7. Each switcher in the configuration should be allocated a unique machine number and the "Reply" option should be set to ON (see Table 3: DIP Switch Settings). Jumper J35 should be relocated to its alternate position.
8. The system may also be be controlled via its RS-485 port (see section 12.3 above).

A typical switchers setup where additional outputs are added is described in Figure 5.

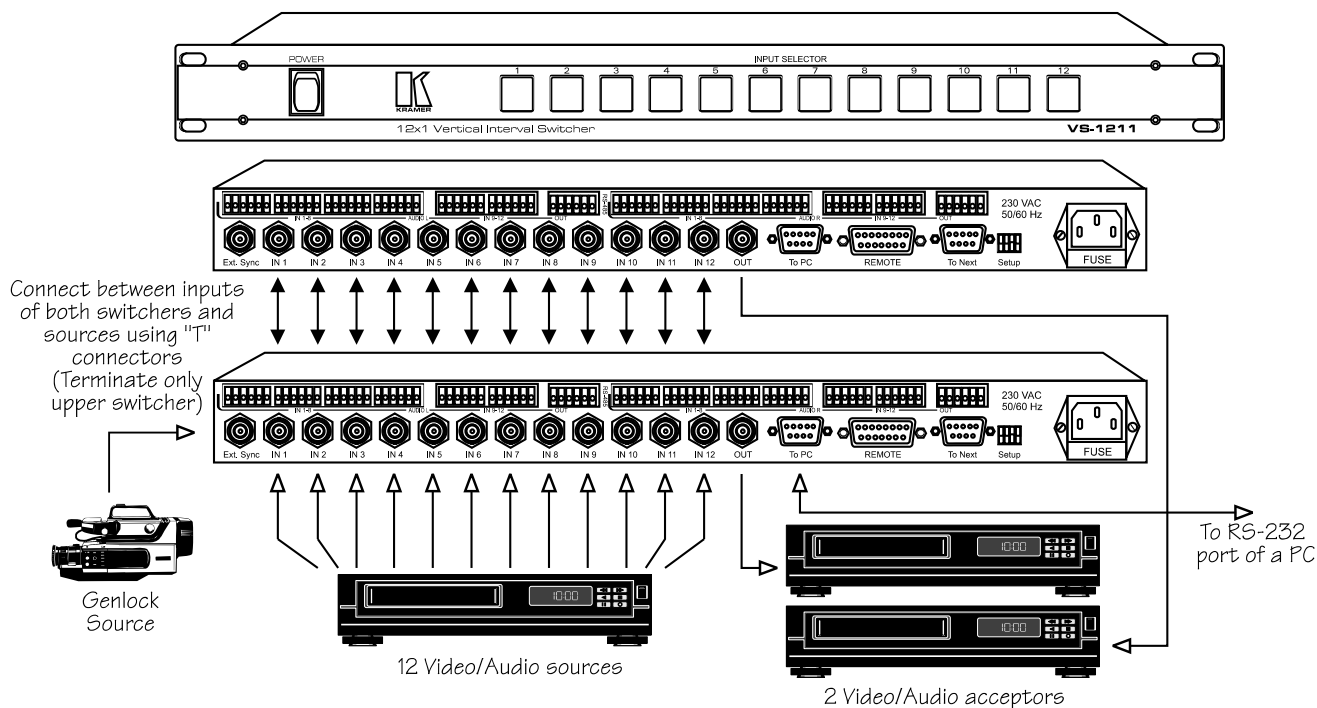

Figure 5: Connecting Two Switchers for adding More Outputs

12.5 Adding Inputs

Two or more VS-1211 switchers can be interconnected to function as a 24x1 or a 36x1 etc., switcher as follows:

1. Make sure that jumper J35 in at least one of the switchers is in its factory located position (See Figure 3). If necessary, carefully remove the covers of the switchers to do so.
2. Connect a straight, 9 wire flat cable from the "To Next" DB-9 connector on the first switcher to the "To Next" DB-9 connector on the second switcher, from the second to the third and so on, until all the required switchers are interconnected. Make sure that the interconnecting lengths of cable are as short as possible.
3. Interconnect the switchers via their RS-485 ports ("A" to "A", "B" to "B", etc.).
4. Assign a unique machine number to each of the switchers. Set DIP switches as in "Table of DIP Switch Settings" (see section 9).
5. On all the units, set the Dipswitch "Reply" option to ON.
6. In order to feed the sync information from one of the units to all the others, interconnect the units via their "To Next" connectors using a flat cable. In this case, jumper J34 must be set in its factory located position in the unit with the Sync source, but in its alternate position in the others.



7. For RS-232 control of the system, connect the PC to the Master switcher via the null modem adapter. Each switcher in the configuration should be allocated a unique machine number and the "Reply" option should be to "ON" (see Table 3, "Table of DIP Switch Settings"). The system may also be controlled via RS-485.
8. Connect the sources to the appropriate switcher inputs.
9. Connect the power cable of each switcher to the mains supply and turn ON each switcher.
10. You now have a 24 or 36, etc. input switcher complex, with one output.

12.6 Video Component and YC Switching

A most important application for interconnected switchers is in professional component video switching, where smooth switching is required, free from transient effects. Four switchers of the same type are required for RGBS systems, three for RGB or YUV systems and two for YC systems. The following describes how to set up the RGB video component application with five professional video sources, each with Red, Green and Blue (RGB) outputs (Sync on Green).

NOTE

In the following description, "R", "G", "B" refers to three different switchers required for the RGB implementation.

1. Interconnect three, same model switchers of the VS-1211 family via their RS-485 ports ("A" to "A", "B" to "B", etc.).
2. On all the units except one, set the Dipswitch "Reply" option to OFF.
3. Set all the switchers to the same Machine number (Dipswitch).
4. If RS-232 control is required, connect the PC via the null modem adapter to the unit in which the "Reply" option is set to ON (the system may also be controlled via RS-485).
5. To synchronize the machines (for vertical interval switching) to input#1 of the G unit, daisy-chain from G's input #1 to the ext. sync input of R and continue to the ext. sync input of B (using "T" connectors). Place the following jumpers in their alternate positions: J22 and J20 in the G unit and J21 in the R unit. Also, ensure that the following jumpers are in their factory default positions: J34 in all the units; J20 in the R and the B units; and J21 in the B unit. To synchronize using an external sync signal, configure R and B as described above, but this time daisy chaining from G's ext. sync. Connect the external sync to G and set G's jumper J20 and J22 to their factory default positions and J21 to its alternate position.
6. Now connect the R, G and B outputs of camera #1 to input #1 on each of the switchers respectively, those of camera #2 to input #2 on each of the switchers respectively, and continue until all five camera R, G and B outputs have been connected to the appropriate switcher inputs, in the same order. Let us call them switchers R, G and B.
7. Connect the single outputs of switchers R, G and B to the R, G and B inputs, respectively, of a professional acceptor, such as a monitor or VCR.
8. Turn the power ON and select the input number to be switched to the acceptor.

12.7 Controlling Several Independent Switchers Via a Single PC Port

1. Assign unique machine numbers to each switcher.
2. Connect via the null modem cable from the PC to the "Master" machine.
3. Interconnect the switchers via their RS-485 ports ("A" to "A", "B" to "B", etc.).

13. TAKING CARE OF YOUR SWITCHER

Do not locate your switcher in an environment where it is susceptible to dust or moisture. These may damage the electronics, and cause erratic operation or failure. Do not locate your switcher where temperature and humidity may be excessive. Do not clean your switcher with abrasives or strong cleaners. Doing so may remove or damage the finish, or may allow moisture to build up. Take care not to allow dust or particles to build up inside unused or open connectors.

14. TROUBLESHOOTING

NOTES:

1. Please note that if the output signal is disturbed or interrupted by very strong external electromagnetic interference, it should return and stabilize when such interference ends. If not, turn the power switch off and on again to reset the machine.
2. If the recommended actions still do not result in satisfactory operation, please consult your KRAMER Dealer.



14.1 Power and Indicators

Problem	Remedy
No Power	<ol style="list-style-type: none">1. Confirm that the rocker switch is in the "ON" position, and that the lamp is illuminated.2. Confirm that power connections are secured at the amplifier and at the receptacle. Make sure the receptacle is active, outputting the proper mains voltage.3. If there is still no power, check the fuse. Remove power cord from the AC outlet and from the machine and then, using a flat head screwdriver, remove the fuse holder located directly below the power connector. Confirm that the fuse is good by looking at the wire connected to the ends of the fuse. If the wire is broken, replace the fuse with another, with the same value.

14.2 Video Signal

Problem	Remedy
No video at the output device, regardless of input selected.	<ol style="list-style-type: none">1. Confirm that your sources and output device are powered on and connected properly. Video signals connected to the input of your switcher should be of an identical signal format at the output of your source. Video signals at the output of your switcher should be of an identical signal format as at the input of your display or recorder.2. Confirm that any other switchers in the signal path have the proper input and/or output selected.3. Use the Video Tester to test the video path leading to/from your switcher (see section 4.1 " Video Tester")
Video level is too high or too dim.	<ol style="list-style-type: none">1. Verify that the video line is well interfaced through 75ohm impedance, otherwise it results in a video level that is too high or too dim when looping is performed and the termination switches are not in proper position.2. Confirm that the connecting cables are of high quality, properly built and terminated with 75ohm BNC connectors. Check level controls located on your source input device or output display or recorder.
Weak switcher input signals	<p>The switcher contains two internal trimmers, accessed via two holes in the base of the switcher. These allow, if necessary, to adjust switcher output signal level. For example, if you are using a long cable with heavy losses, you can compensate for it by fine tuning the signal using the two trimmers. One trimmer adjusts the gain of the whole video signal and the other adjusts only the high frequencies of the video which have been degraded by a low quality cable. The hole closer to the power socket controls the cable compensation the other controls the video level.</p> <p>WARNING! Do <u>not</u> use the trimmers except in cases where the cable losses result in poor resolution of detail or when the whole signal level crashes.</p> <p>Once they have been touched, the accurate signal transparencies that have been fine-tuned in the factory are lost. To readjust to the original signal status you need a stable signal generator and a good quality signal analyzer.</p>



Problem	Remedy
<p>Noise bars are “rolling” up or down in the output image or: Low frequency hum in the output signal</p>	<p>Hum bars (ground loop) are caused by a difference in the ground potential of any two or more devices connected to your signal path. This difference is compensated by passing that voltage difference through any available interconnection, including your video cables.</p> <p style="text-align: center;">WARNING! <i>Do not disconnect the ground from any piece of video equipment in your signal path!</i></p> <p>Check the following to remove hum bars:</p> <ol style="list-style-type: none"> 1. Confirm that all interconnected equipment is connected to the same phase of power, if possible. 2. Remove equipment connected to that phase that may introduce noise, such as motors, generators, etc. 3. Disconnect all interconnect cables and reconnect them one at a time until ground loop reappears. Disconnect the affected cable and replace, or insert an isolation transformer in the signal path.

14.3 Audio Signal

Problem	Remedy
<p>No audio at the output device, regardless of input selected</p>	<ol style="list-style-type: none"> 1. Confirm that your sources and output device are powered on and connected properly. Audio signals connected to the input of your switcher should be properly wired to the output of your source. Audio signals connected to output of your switcher should be properly wired to the input of your switcher or recorder. 2. Confirm that any other switchers in the signal path have the proper input and/or output selected. Pay special attention to input switchers that may be built into your switcher or recording device.
<p>Audio level is too low</p>	<ol style="list-style-type: none"> 1. Confirm that the connecting cables are of high quality and properly built. Take special care in noting the wiring configuration of balanced to unbalanced cables. 2. Check level controls located on your source input device or output display or recorder.
<p>The switcher switches the video but does not switch the audio.</p>	<p>One of the audio cables leading to the main board is disconnected and cannot transfer the switch command to the video.</p>
<p>The switcher will not switch via the RS-485 control</p>	<p>The RS-485 control is fed by a flat cable from the upper audio board to a socket on the main board. One of its connectors may be disconnected.</p> <p>Turn OFF the mains switch, remove the power cord from the mains socket and carefully remove the cover of the switcher. Verify that all the flat cables from the main board to the control board, from the audio board to the main board and from the switchboard to the main board are undamaged and properly connected.</p> <p style="text-align: center;">NOTE <i>Sometimes connectors work loose and have to be reinserted. (Perform this firmly but with care).</i></p>



14.4 Software

Problem	Remedy
Software version is not updated	Carefully remove the switcher cover and identify the EPROM chip that is located in the middle of the main board, marked by a white sticker. Remove the chip with the proper tools and insert the new EPROM carefully, observing proper polarity.

14.5 Control

Problem	Remedy
No control of switcher from VS-2000 control panel	<ol style="list-style-type: none">3. Confirm that the connecting cable is wired for pins 1-9 straight through.4. Confirm that all DIP switches on the switcher have been set properly. Keep in mind that if you are only controlling one switcher on a specific port, that switcher must be assigned the ID of "1".5. If controlling more than one switcher on a single port, all switchers must be of the same type and power to all switchers must be on.6. Confirm that you have the proper machine number and control port selected on the VS-2000. For instance, if you are controlling a single machine on port 1, then both of these should be set to "1".7. Confirm that you have the proper switcher type selected on the VS-2000. If not, go back to Section 12.2.3 of this manual "Using the VS-2000 Remote Control Panel".
No control of switcher from PC software	<ol style="list-style-type: none">1. Confirm the wiring of the connecting cable. This pin configuration may be found in Section 11 "Connecting to a PC or Compatible System". Cable length should not exceed 25 feet.2. Confirm that all DIP switches on the switcher have been set properly. Keep in mind that if you are only controlling one switcher on a specific port, that switcher must be assigned the ID of "1".3. If controlling more than one switcher on a single port, all switchers must be of the same type and power to all switchers must be on.4. Confirm that the baud rate of your computer COM port is set to the same as that of your switcher (9600-Baud). Confirm that the proper COM port is selected in the control software.5. Confirm that bi-directional communication is enabled on all switchers. Please refer to Section 9 "The Configuration Switches jumpers and trimmers" for proper configuration for your switcher.6. With custom software, do not send multiple commands at the same time. The switcher must complete one command before receiving another.7. Confirm that the computer you are using supports true RS-232C protocol. Computers, such as the Apple Macintosh do not!

14.6 Switching Malfunctions

Problem	Remedy
The switcher succeeds in switching a number of sources then fails to switch one	<p>Malfunction in the particular source or cable assembly.</p> <p>NOTE: <i>The most common failure mode in transferring the signal of an audio source is a break in the connecting wire.</i></p> <p>Disconnect the source from a channel that is switching successfully and connect the suspect source to it. If the channel continues to switch successfully, then there is something wrong with the switcher or the suspect source was not connected properly. If it does not continue to switch successfully, then there is something wrong with the source or cable assembly. Check them.</p>
The switcher turns ON but will not switch at all	One of the two flat cables leading from the main board to the control board may be disconnected and the switch command is not being transferred to the switcher.

14.7 Vertical Interval

Problem	Remedy
The switcher is switching, but there are transitional effects when using genlocked sources. The picture jumps and rolls, and the color is lost until the acceptor (a VCR, for example) has readjusted itself to the new color information.	<p>There is no vertical interval Sync source for switching. It should be available either on video input #1 or on an external genlocked source as a live video or a live black burst signal. Which one, will depend on certain jumper settings.</p> <p>Turn OFF the power switch, remove the power cable from the mains socket and carefully remove the cover of the switcher. Carefully remove the audio board by unscrewing the four upper board screws. The upper board can now be raised with ease. Find jumper J20 (also J34 in an interconnected configuration) and set up the Sync source in accordance with "Jumpers, Their Uses and Set-up Requirements" (see section 9.2).</p>

15. PROTOCOL USED FOR VS-1211/1201xl COMMUNICATION

The protocol used for communication between the PC and the Master VS-1211/1201xl is defined as follows:

MSB							LSB
N7	N6	N5	N4	N3	N2	N1	N0

Where:

N7 is used for communication between the Slave and the Master only and is always 0 for communication with the PC.

N6N5N4 is the binary value of the Machine we are addressing minus one, e.g., if we wish to address the Master (Machine 1 by definition), then N6N5N4 = 000, if we wish to address Machine 6, then N6N5N4 = 101.

N3N2N1N0 is the binary value of the input to be selected, i.e. N3N2N1N0 = 0111 is equivalent to pressing switch 7 on the front panel.

Several special codes are also valid:

N3N2N1N0 = 1101 requests that the Machine being addressed sends its present status to the PC, i.e. which input is selected on its front panel.

N3N2N1N0 = 1110 is an "OK" handshake, i.e. confirmation that the instruction was received by the addressed Machine. (If the addressed Machine is not present, then this confirmation is not sent to the PC).

Information sent from the Master to the PC is done using the same format, i.e.:

0	Machine Number -1	New Switch Status
N7	N6N5N4	N3N2N1N0

The rate of data transfer is always 9600 baud, with no parity, 8 data bits and 1 stop bit.



LIMITED WARRANTY

Kramer Electronics (hereafter Kramer) warrants this product to be free from defects in material and workmanship under the following terms.

HOW LONG IS THE WARRANTY

Labor and parts are warranted for three year from the date of the first customer purchase.

WHO IS PROTECTED

Only the first purchase customer may enforce this warranty.

WHAT IS COVERED AND WHAT IS NOT COVERED

Except as below, this warranty covers all defects in material or workmanship in this product. The following are not covered by the warranty:

1. Any product which is not distributed by Kramer or which is not purchased from an authorized Kramer dealer. If you are uncertain as to whether a dealer is authorized, please contact Kramer at one of the agents listed in the web site **www.kramerelectronics.com**.
2. Any product, on which the serial number has been defaced, modified or removed.
3. Damage, deterioration or malfunction resulting from:
 - a) Accident, misuse, abuse, neglect, fire, water, lightning or other acts of nature, unauthorized product modification, or failure to follow instructions supplied with the product.
 - b) Repair or attempted repair by anyone not authorized by Kramer.
 - c) Any shipment of the product (claims must be presented to the carrier).
 - d) Removal or installation of the product.
 - e) Any other cause, which does not relate to a product defect.
 - f) Cartons, equipment enclosures, cables or accessories used in conjunction with the product.

WHAT WE WILL PAY FOR AND WHAT WE WILL NOT PAY FOR

We will pay labor and material expenses for covered items. We will not pay for the following:

1. Removal or installations charges.
2. Costs of initial technical adjustments (set-up), including adjustment of user controls or programming. These costs are the responsibility of the Kramer dealer from whom the product was purchased.
3. Shipping charges.

HOW YOU CAN GET WARRANTY SERVICE

1. To obtain service on you product, you must take or ship it prepaid to any authorized Kramer service center.
2. Whenever warranty service is required, the original dated invoice (or a copy) must be presented as proof of warranty coverage, and should be included in any shipment of the product. Please also include in any mailing a contact name, company, address, and a description of the problem(s).
3. For the name of the nearest Kramer authorized service center, consult your authorized dealer.



LIMITATION OF IMPLIED WARRANTIES

All implied warranties, including warranties of merchantability and fitness for a particular purpose, are limited in duration to the length of this warranty.

EXCLUSION OF DAMAGES

Kramer's liability for any defective products is limited to the repair or replacement of the product at our option. Kramer shall not be liable for:

1. Damage to other property caused by defects in this product, damages based upon inconvenience, loss of use of the product, loss of time, commercial loss; or:
2. Any other damages, whether incidental, consequential or otherwise. Some countries may not allow limitations on how long an implied warranty lasts and/or do not allow the exclusion or limitation of incidental or consequential damages, so the above limitations and exclusions may not apply to you.

This warranty gives you specific legal rights, and you may also have other rights, which vary from place to place.

NOTE: All products returned to Kramer for service must have prior approval. This may be obtained from your dealer.

NOTICE

This equipment has been tested to determine compliance with the requirements of:

- EN-50081:** "Electromagnetic compatibility (EMC);
generic emission standard.
Part 1: Residential, commercial and light industry"
- EN-50082:** "Electromagnetic compatibility (EMC) generic immunity standard. Part 1:
Residential, commercial and light industry environment".
- CFR-47** FCC Rules and Regulations:
Part 15- "Radio frequency devices:
Subpart B- Unintentional radiators

CAUTION

- ⊗ Servicing the machines can only be done by an authorized Kramer technician. Any user who makes changes or modifications to the unit without the expressed approval of the manufacturer will void user authority to operate the equipment.
- ⊗ Use the supplied power cord to feed power to the machine.
- ⊗ Please use recommended interconnection cables to connect the machine to other components.



For the latest information on our products and a list of Kramer distributors, visit our Web site: www.kramerelectronics.com.

**Updates to this user manual may be found at
<http://www.kramerelectronics.com/manuals.html>.
We welcome your questions, comments and feedback.**



Kramer Electronics, Ltd.

Web site: www.kramerelectronics.com

E-mail: info@kramerel.com

P/N: 2900-002002 REV 2

Download from [Www.Somanuals.com](http://www.Somanuals.com). All Manuals Search And Download.

Free Manuals Download Website

<http://myh66.com>

<http://usermanuals.us>

<http://www.somanuals.com>

<http://www.4manuals.cc>

<http://www.manual-lib.com>

<http://www.404manual.com>

<http://www.luxmanual.com>

<http://aubethermostatmanual.com>

Golf course search by state

<http://golfingnear.com>

Email search by domain

<http://emailbydomain.com>

Auto manuals search

<http://auto.somanuals.com>

TV manuals search

<http://tv.somanuals.com>