

Kramer Electronics, Ltd.

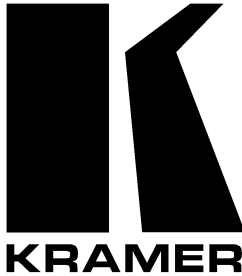

USER MANUAL

Model:

VS-66FW

6 Port FireWire Switcher

Contents

1	Introduction	1
2	Getting Started	1
3	Overview	1
3.1	Understanding FireWire	2
3.2	FireWire Compliance	2
3.3	Your VS-66FW 6 Port FireWire Switcher	3
3.3.1	Achieving the Best Performance	3
3.3.2	Signal Terminology	3
3.3.3	Configuring as a FireWire Hub	4
4	Defining the VS-66FW 6 Port FireWire Switcher	5
5	Connecting the VS-66FW	8
5.1	Connecting the VS-66FW Rear Panel	8
5.2	Controlling via RS-232 (for example, using a PC)	9
5.3	Controlling via RS-485	10
5.4	Setting the Dipswitches	10
5.4.1	Setting the MACHINE #	11
5.5	Connecting the REMOTE Connector	11
6	Operating the VS-66FW	12
6.1	Displaying Unit Characteristics	12
6.2	Switching LEAF- BRANCH Combinations	13
6.3	Confirming Settings	13
6.3.1	Toggling between the AT ONCE and CONFIRM Modes	14
6.3.2	Confirming a Switching Action	14
6.4	Storing/Recalling Input/Output Configurations	14
6.4.1	Storing an Input/Output Configuration	15
6.4.2	Recalling an Input/Output Configuration	15
6.5	Locking the Front Panel	15
7	Flash Memory Upgrade	16
7.1	Downloading from the Internet	16
7.2	Connecting the PC to the RS-232 Port	16
7.3	Upgrading Firmware	16
8	Technical Specifications	21
9	Table of Hex Codes for Serial Communication	21
10	Kramer Protocol 2000	22

Figures

Figure 1: Configuring the VS-66FW as a 2x2 Port FireWire Hub	4
Figure 2: Configuring the VS-66FW as a 6 Port FireWire Hub	5
Figure 3: VS-66FW 6 Port FireWire Switcher	6
Figure 4: Connecting the VS-66FW 6 Port FireWire Switcher	9
Figure 5: Connecting a PC without using a Null-modem Adapter	9
Figure 6: Dipswitch Settings	10
Figure 7: REMOTE Connector	11
Figure 8: VS-66FW Unit Characteristics	12
Figure 9: Storing and Recalling using the LEAF Buttons	14
Figure 10: Splash Screen	17
Figure 11: Atmel – Flip Window	17
Figure 12: Open Configuration File Select Window	18
Figure 13: Atmel – Flip Window (RS-232 Communication)	18
Figure 14: RS-232 Window	19
Figure 15: Atmel – Flip Window (Connected)	19
Figure 16: Atmel – Flip Window (Operation Completed)	20

Tables

Table 1: Front Panel VS-66FW 6 Port FireWire Switcher Features	7
Table 2: Rear Panel VS-66FW 6 Port FireWire Switcher Features	7
Table 3: Dipswitch Settings	10
Table 4: Machine # Dipswitch Settings	11
Table 5: Technical Specifications of the VS-66FW 6 Port FireWire Switcher	21
Table 6: Hex Table for the VS-66FW	21
Table 7: Protocol Definitions	22
Table 8: Instruction Codes for Protocol 2000 (Relevant to the VS-66FW)	23

This addendum updates the **VS-66FW** user manual, as follows:

Page 6 (item 3 on the rear panel in Figure 3, in section 4): the REMOTE connector PINOUT is altered.

The seventh PIN (leaf) is now labeled **LF**, and the eighth PIN (branch) is now labeled **BR**.

Page 11 (Figure 7 in section 5.5): the REMOTE connector PINOUT is replaced:

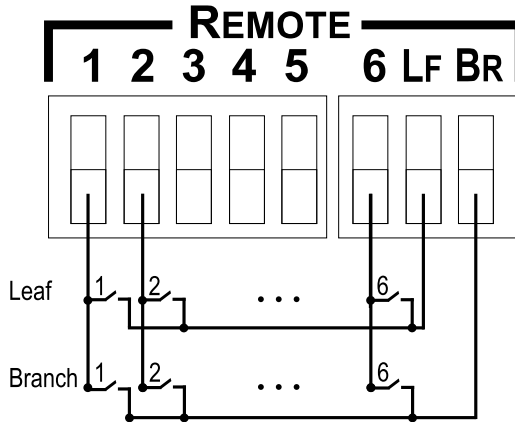

Figure A1: REMOTE Connector (Revised Graphic)

Page 21 (Table 5 in section 8): the POWER SOURCE spec is replaced with this text: 100-240 VAC, 50/60 Hz; 30VA.

1 Introduction

Welcome to Kramer Electronics (since 1981): a world of unique, creative and affordable solutions to the infinite range of problems that confront the video, audio and presentation professional on a daily basis. In recent years, we have redesigned and upgraded most of our line, making the best even better! Our 350-plus different models now appear in 8 Groups¹, which are clearly defined by function.

Congratulations on purchasing your **VS-66FW 6 Port FireWire Switcher**, which is ideal for video broadcast studios for high quality signal routing, and video production studios with Non-Linear editing systems. The package includes the following items:

- **VS-66FW 6 Port FireWire Switcher**
- Power cord, Null-modem adapter, Windows®-based Kramer control software², infra-red remote control transmitter (including the required battery and a separate user manual³), and this user manual³

2 Getting Started

We recommend that you:

- Unpack the equipment carefully and save the original box and packaging materials for possible future shipment
- Review the contents of this user manual
- Use Kramer high performance high resolution cables⁴

3 Overview

This section describes:

- Understanding FireWire (see section 3.1)
- FireWire Compliance (see section 3.2)
- Your **VS-66FW 6 Port FireWire Switcher** (see section 3.3)

1 GROUP 1: Distribution Amplifiers; GROUP 2: Video and Audio Switchers, Matrix Switchers and Controllers; GROUP 3: Video, Audio, VGA/XGA Processors; GROUP 4: Interfaces and Sync Processors; GROUP 5: Twisted Pair Interfaces; GROUP 6: Accessories and Rack Adapters; GROUP 7: Scan Converters and Scalers; and GROUP 8: Cables and Connectors

2 Downloadable from our Web site at <http://www.kramerelectronics.com> (click "DOS and Windows®-based software drivers for Kramer machines" in the Technical Support section)

3 Download up-to-date Kramer user manuals from the Internet at this URL: <http://www.kramerelectronics.com/manuals.html>

4 The complete list of Kramer cables is on our Web site at <http://www.kramerelectronics.com> (click "Cables and Connectors" in the Products section)

3.1 Understanding FireWire

FireWire is a serial bus standard that enables quick universal interfacing between video and computer hardware items. FireWire is simple to use and operates independently of the host system. In addition, FireWire supports Plug and Play¹ and hot swapping².

Many computers today come with one or more FireWire ports on the rear panel. These ports let you attach many devices to your computer quickly and easily. The operating system also supports FireWire, so the installation of the device drivers is also quick and easy. Compared to other ways of connecting devices to your computer (including parallel ports, serial ports and special cards that you install inside the computer's case), FireWire devices are simple. Many peripheral devices (including: DV Camcorders, Digital still cameras, Storage devices such as External Hard Drives and Arrays, and Network connections) now come in a FireWire version.

3.2 FireWire Compliance

The **VS-66FW**:

- Fully supports the provisions of the IEEE 1394-1995 Standard for High Performance Serial Bus and the P1394a Supplement
- Is fully interoperable with FireWire™ and i.LINK™ implementation of IEEE Std 1394
- Is fully compliant with OpenHCI requirements
- Provides P1394a Fully Compliant Cable Ports at 100/200/400 Megabits per Second (Mbits/s)
- Includes full P1394a support, that is, Connection Debounce, Arbitrated Short Reset, Multispeed Concatenation, Arbitration Acceleration, Fly-By Concatenation, Port Disable/Suspend/Resume
- Includes Extended Resume Signaling for Compatibility with Legacy DV Devices
- Includes built-in protection from electrostatic discharge (ESD)³, by suppressing all transient high voltages down to the allowed level. In particular, ESD protection for high-speed data lines to IEC 61000-4-2 (ESD) 15kV (air), 8kV (contact), IEC 61000-4-5 (Lightning) 12A (8/20us), and IEC 61000-4-4 (EFT) 40A (5/50ns)

1 Configures automatically without any driver. Whenever a device is added or removed the 1394 bus re-enumerates.

2 You can connect and disconnect inputs and outputs dynamically, without having to restart the PC or cycle power

3 When connecting a "live" DV source to a receptor, an electrical potential difference or any other element creating a high voltage (such as ESD or a live chassis) may permanently damage one or both of the connected devices. This high voltage may be seen as a spark occurring at the instant of connection, or may not be seen at all, but nevertheless can result in costly damage

3.3 Your VS-66FW 6 Port FireWire Switcher

The Kramer **VS-66FW** is a high quality 6-port matrix switcher for routing 1394/FireWire interface signals. In particular, the **VS-66FW**:

- Offers simple-to-connect automatic branch/leaf configuration that operates bi-directionally
- Can be operated with FireWire™/i.Link™ implementation of the IEEE 1394-1995 and the IEEE 1394A standards at data rates of up to 400Mbits/sec
- Supports isochronous¹ and asynchronous transfers, as well as all the features of the 1394/FireWire interface, including hot insertion and removal
- Can source the power to all ports
- Stores and retrieves 15 setups in the built-in non-volatile memory
- Includes a large, bright LED display on the front panel that shows the current status of the matrix, as well as PORT STATUS LEDs that indicate the status of each port
- Includes a “Take” button for precise switch control, and a “Lock” button to prevent tampering with the front panel
- Is housed in a 19" 1U rack-mountable enclosure

You can control the **VS-66FW** via the:

- Front panel buttons
- Infra-red remote control transmitter
- Remote contact-closure switches
- Remotely by RS-485 or RS-232 serial commands transmitted by a touch screen system, PC, or other serial controller

3.3.1 Achieving the Best Performance

To achieve the best performance:

- Connect only good quality connection cables, thus avoiding interference, deterioration in signal quality due to poor matching, and elevated noise levels (often associated with low quality cables)
- Avoid interference from neighboring electrical appliances that may adversely influence signal quality and position your Kramer **VS-66FW** away from moisture, excessive sunlight and dust

3.3.2 Signal Terminology

With regard to the signal technology used in the **VS-66FW**, note that:

- Connections are between Branch and Leaf FireWire devices, rather than the regular In and Out, or Source and Destination devices. The difference is

¹ Video / audio applications require constant transfer rates, which the serial bus provides by supporting isochronous transfers

not merely one of semantics but a vital distinction when understanding the concept of FireWire Branch/Leaf technology

- With a regular In and Out switcher, not only does the front panel have separate In and Out buttons but the rear panel also has separate ports for input and output connectors
- With a Branch and Leaf control switcher, the front panel has separate Branch and Leaf buttons but the rear panel has shared Branch/Leaf connectors: FireWire ports

3.3.3 Configuring as a FireWire Hub

The **VS-66FW** is a *6 Port FireWire Switcher*, which—due to its Branch/Leaf design—can also be configured as a FireWire hub.

3.3.3.1 Configuring as a 2x2 Port FireWire Hub

The example in Figure 1 illustrates a 2x2 FireWire hub in which the bi-directional signals flow separately between Port 1 and Port 4, and Port 5 and Port 6, simultaneously.

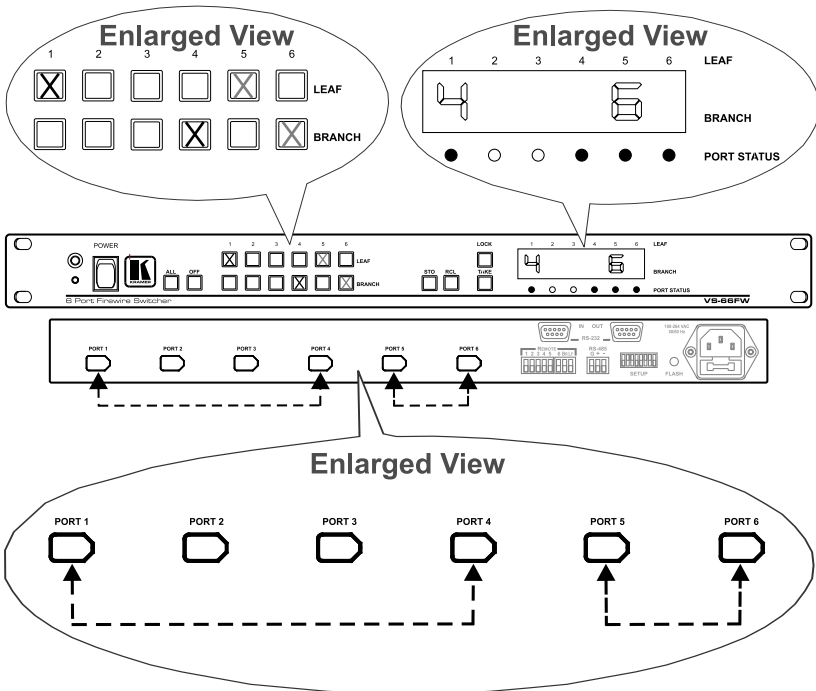

Figure 1: Configuring the VS-66FW as a 2x2 Port FireWire Hub

3.3.3.2 Configuring as a 6 Port FireWire Hub

The example in Figure 2 illustrates how the **VS-66FW** can be configured¹ as a 6 port FireWire hub in which the bi-directional signals flow between Port 4 and all the other ports:

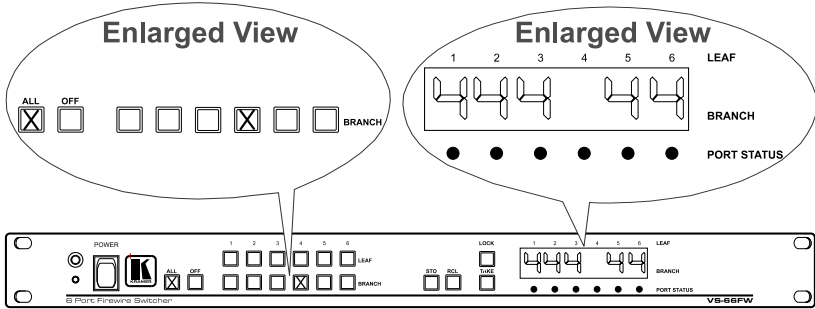

Figure 2: Configuring the VS-66FW as a 6 Port FireWire Hub

4 Defining the VS-66FW 6 Port FireWire Switcher

Figure 3, Table 1 and Table 2 define the **VS-66FW 6 Port FireWire Switcher**:

¹ By pressing the ALL button and Branch button 4

Defining the VS-66FW 6 Port FireWire Switcher

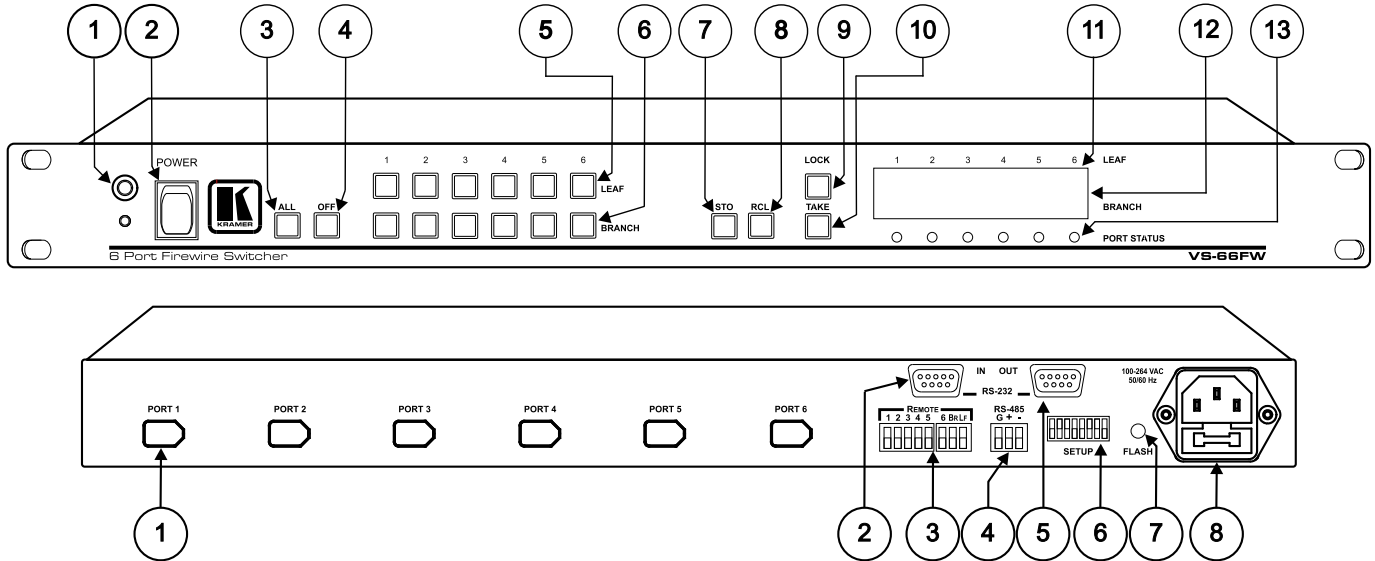

Figure 3: VS-66FW 6 Port FireWire Switcher

Table 1: Front Panel VS-66FW 6 Port FireWire Switcher Features

#	Feature	Function
1	IR Receiver	The red LED is illuminated when receiving signals from the Infra-red remote control transmitter
2	Power Switch	Illuminated switch for turning the unit ON or OFF
3	ALL Button	Pressing ALL followed by an BRANCH button, connects that BRANCH to all LEAF devices ¹
4	OFF Button	An OFF-LEAF combination disconnects that LEAF from the BRANCH devices; an OFF-ALL combination disconnects all the LEAF devices
5	LEAF Buttons	Select 1 - 6 to connect between a BRANCH device and a LEAF device
6	BRANCH Buttons	Select 1 - 6 to connect between a LEAF device and a BRANCH device
7	STO (STORE) Button	Pressing STO followed by a LEAF button stores the current setting ²
8	RCL (RECALL) Button	Pressing the RCL button and the corresponding LEAF button recalls a setup from the non-volatile memory. The stored status blinks. Pressing a different LEAF button lets you view ³ another setup. After making your choice, pressing the RCL button again implements the new status
9	LOCK Button	Toggles engaging/disengaging the front panel switches. The button is lit when the switches are locked (disengaged)
10	TAKE Button	Pressing TAKE toggles the mode between the CONFIRM mode ⁴ and the AT ONCE mode (user confirmation per action is unnecessary)
11	LEAF	Labels identify a cross point between each LEAF to which the BRANCH displayed below it is connected
12	BRANCH	7-segment Display ⁵ shows the selected BRANCH switched to the LEAF (under the corresponding LEAF label)
13	PORT STATUS LEDs	Lights when data from an external device is detected on that port

Table 2: Rear Panel VS-66FW 6 Port FireWire Switcher Features

#	Feature	Function
1	PORT	Connects to the FireWire device(s) (from 1 to 6)
2	RS-232 IN DB 9F Port	Connects to the PC or the RS-232 Remote Controller
3	REMOTE Terminal Block Connector	Connects to the Remote contact-closure switches
4	RS-485 Terminal Block Port	Pin G is for Ground connection; Pins + and - are for RS-485
5	RS-232 OUT DB 9F Port	Connects to the RS-232 IN DB 9F port of the next unit in a daisy-chain
6	SETUP Dipswitches	Dipswitches for setup of the unit (1, 2, 3 and 4 are for setting the Machine #; 8 is for RS-485 Termination)
7	FLASH Program Button	Push in ⁶ for "Program" to upgrade to the latest Kramer firmware (see section 7), or release for Normal (the factory default) ⁷
8	Power Connector with Fuse	AC connector enabling power supply to the unit

1 For example, press ALL and then BRANCH button # 2 to connect BRANCH # 2 to all the LEAF devices

2 For example, press STO and then the LEAF button # 3 to store in Setup # 3

3 Only view, nothing is implemented at this stage

4 When in Confirm mode, the TAKE button illuminates

5 Also displays the firmware version number. Refer to section 6.1

6 Using a screwdriver if required

7 Note that the FLASH PROG "Reset" button is located on the underside of the unit. Push in for "Reset", or release for Normal (see section 7)

5 Connecting the VS-66FW

This section describes how to connect the **VS-66FW**. In particular, how to:

- Connect the **VS-66FW** rear panel (see section 5.1)
- Control via RS-232, for example, using a PC (see section 5.2)
- Control via RS-485 (see section 5.3)
- Set the dipswitches (see section 5.4)
- Connect the REMOTE Connector (see section 5.5)

5.1 Connecting the VS-66FW Rear Panel

You can connect the **VS-66FW** to up to 6 devices, using IEEE-1394 cables with 6 pin connectors. The example in Figure 4 illustrates how you can use the **VS-66FW** to capture and edit real-time video and audio from one video camcorder to a computer, and from another video camcorder to a laptop. The data from the computer is stored on an external hard drive.

To connect the **VS-66FW**, as the example in Figure 4 illustrates, do the following:

1. Connect the two FireWire ports of a computer, as follows:
 - Connect the first FireWire port to PORT 1
 - Connect the second FireWire port to PORT 2
2. Connect a FireWire device (for example, a video camcorder) to PORT 3.
3. Connect a FireWire device (for example, another video camcorder) to PORT 4.
4. Connect a FireWire device (for example, a laptop) to PORT 5.
5. Connect a FireWire device (for example, a hard disk) to PORT 6.
6. Set the dipswitches (see section 5.4).
7. Connect a PC (if required) to the RS-232 IN port (see section 5.2).
8. Connect the power cord¹.

¹ We recommend that you use only the power cord that is supplied with this machine

Connecting the VS-66FW

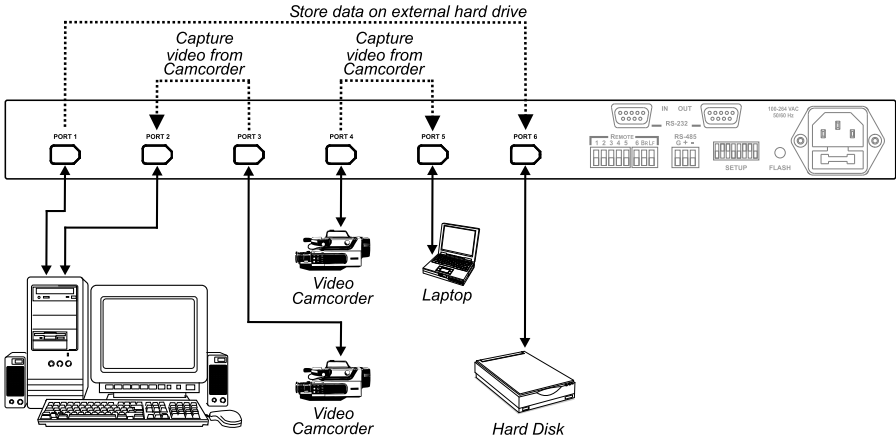

Figure 4: Connecting the VS-66FW 6 Port FireWire Switcher

5.2 Controlling via RS-232 (for example, using a PC)

To connect a PC to the **VS-66FW** unit, using the Null-modem adapter provided *with* the machine (recommended):

- Connect the RS-232 DB9 rear panel port on the **VS-66FW** unit to the Null-modem adapter and connect the Null-modem adapter with a 9 wire flat cable to the RS-232 DB9 port on your PC

To connect a PC to the **VS-66FW** unit, *without* using a Null-modem adapter:

- Connect the RS-232 DB9 port on your PC to the RS-232 DB9 rear panel port on the **VS-66FW** unit, as Figure 5 illustrates (depending on whether the PC has a 9-pin or 25-pin connector)

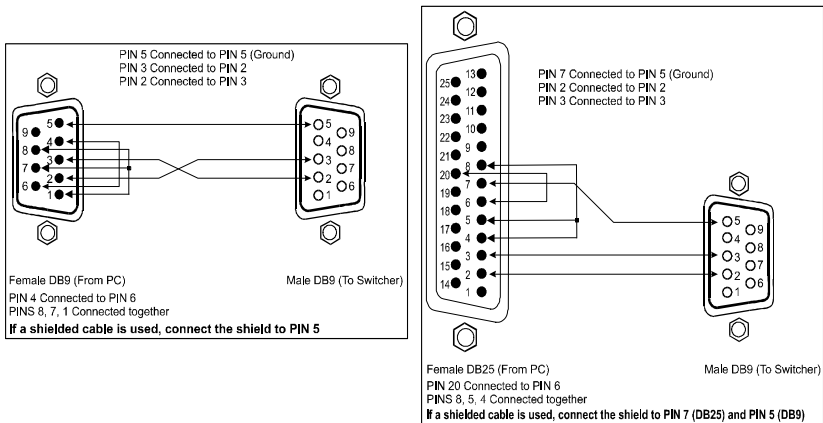

Figure 5: Connecting a PC without using a Null-modem Adapter

5.3 Controlling via RS-485

You can control a **VS-66FW** unit via any RS-485 remote controller or a PC (equipped with an RS-485 interface).

To connect an RS-485 remote controller to a **VS-66FW**:

1. Connect the RS-485 port on the RS-485 remote controller to the RS-485 ports on the **VS-66FW** unit, as follows:
 - Connect the “A” (+) PIN on the RS-485 remote controller to the “+” (A) PIN on the RS-485 port of the **VS-66FW** unit
 - Connect the “B” (-) PIN on the RS-485 remote controller to the “B” (-) PIN on the RS-485 port of the **VS-66FW** unit
 - If shielded twisted pair cable is used, the shield may be connected to the “G” (Ground) PIN on one of the units (for example, on the RS-485 remote controller)
2. Set the SETUP dipswitches on the **VS-66FW** unit as follows:
 - Set the first **VS-66FW** unit to MACHINE # 1¹
 - Set the second **VS-66FW** unit to MACHINE # 2¹ and set DIP 8 to ON, terminating the RS-485 line²

5.4 Setting the Dipswitches

Figure 6 illustrates the factory default dipswitches:

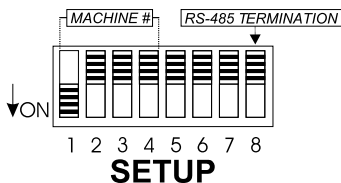

Figure 6: Dipswitch Settings

Table 3: Dipswitch Settings

Function	DIPS	Description
Machine #	1, 2, 3, 4	Determines the position of a unit in the sequence (see section 5.4.1)
Reserved	5	OFF
Reserved	6	OFF
Reserved	7	OFF
RS-485 Termination	8	ON for RS-485 Line Termination with 120Ω; OFF for no RS-485 Line Termination

¹ See Table 3

² The RS-485 line must also be terminated at the remote controller. Refer to the remote controller’s user manual for details of how to terminate the RS-485 line on the remote controller

5.4.1 Setting the MACHINE

The *MACHINE #* determines the position of a **VS-66FW** unit, specifying which **VS-66FW** unit is being controlled when several **VS-66FW** units connect to a PC or serial controller. Set the *MACHINE #* on a **VS-66FW** unit via DIPS 1, 2, 3 and 4, according to Table 4.

When using a stand-alone **VS-66FW** unit, set the *MACHINE #* to 1. When connecting more than one **VS-66FW** unit, set the first machine that is closest to the PC, as *MACHINE #* 1.

Table 4: Machine # Dipswitch Settings

MACHINE #	DIPSWITCH				MACHINE #	DIPSWITCH			
	1	2	3	4		1	2	3	4
1	ON	OFF	OFF	OFF	9	ON	OFF	OFF	ON
2	OFF	ON	OFF	OFF	10	OFF	ON	OFF	ON
3	ON	ON	OFF	OFF	11	ON	ON	OFF	ON
4	OFF	OFF	ON	OFF	12	OFF	OFF	ON	ON
5	ON	OFF	ON	OFF	13	ON	OFF	ON	ON
6	OFF	ON	ON	OFF	14	OFF	ON	ON	ON
7	ON	ON	ON	OFF	15	ON	ON	ON	ON
8	OFF	OFF	OFF	ON					

5.5 Connecting the REMOTE Connector

Connecting dry contact-closure switches to the REMOTE connector lets you duplicate the actions of the front panel LEAF-BRANCH buttons when switching a BRANCH FireWire device to a LEAF FireWire device, from a distance of up to 1000 meters. Figure 7 illustrates how to connect the remote push buttons:

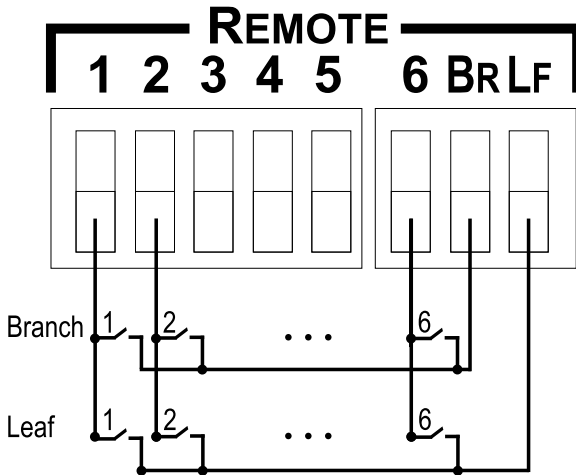

Figure 7: REMOTE Connector

6 Operating the VS-66FW

You can operate your **VS-66FW** via:

- The front panel buttons
- Infra-red remote control transmitter
- Remote contact-closure switches
- RS-232/RS-485 serial commands transmitted by a touch screen system, PC, or other serial controller

6.1 Displaying Unit Characteristics

Switching on the **VS-66FW** unit, momentarily displays the following test¹ in the front panel 7-segment Display, in consecutive cycles (before recalling the last configuration from the non-volatile memory):

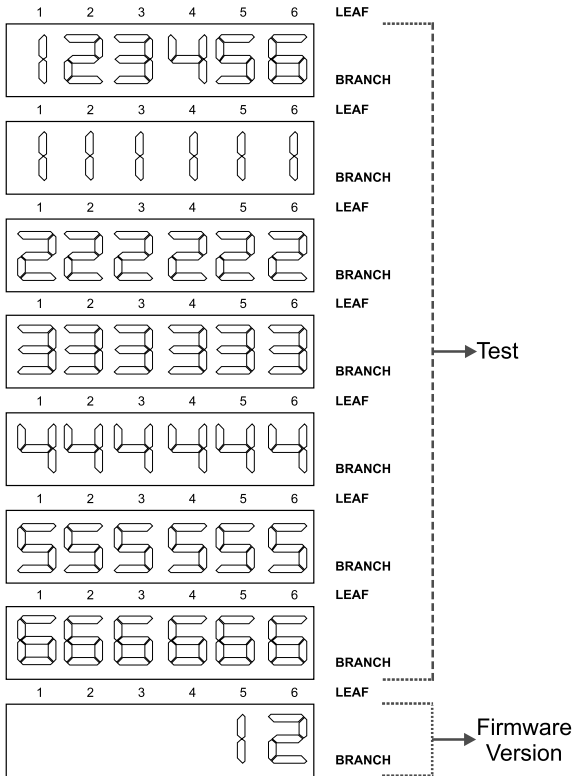

Figure 8: VS-66FW Unit Characteristics

¹ In the case shown here, the firmware version is 1.2

6.2 Switching LEAF- BRANCH Combinations

To switch a BRANCH FireWire device to a LEAF FireWire device (a bi-directional connection), do the following:

1. Press a LEAF button (either 1, 2, 3, 4, 5, 6 or ALL).
The corresponding item in the 7-segment Display blinks.
2. Press a BRANCH button (either 1, 2, 3, 4, 5, 6 or OFF).
The selected BRANCH switches to the selected LEAF.

Note that, pressing a LEAF button and a BRANCH button, when the # is the same¹ will not display a digit in the 7-segment Display. You cannot connect the same BRANCH # and LEAF # because the (bi-directional) FireWire Port is shared (see also² the illustration in Figure 2).

For details of how to use the **VS-66FW 6 Port FireWire Switcher** as a FireWire hub, see section 3.3.3.

6.3 Confirming Settings

Choose to work in the AT ONCE or the CONFIRM mode, as section 6.3.1 describes. When the **VS-66FW** operates in the AT ONCE mode, pressing a LEAF-BRANCH combination implements the switch immediately. In the CONFIRM mode, the TAKE button must be pressed to authorize the switch.

In the AT ONCE mode, you save time as execution is immediate and actions require no user confirmation. However, no protection is offered against changing an action in error.

In the CONFIRM mode:

- You can key-in several actions and then confirm them by pressing the “TAKE” button, to simultaneously activate the multiple switches
- Every action requires user confirmation, protecting against erroneous switching
- Execution is delayed until the user confirms the action³

¹ For example, LEAF button # 3 and a BRANCH button # 3

² Illustrating that the digit “4” does not appear in the BRANCH status 7-segment Display when the VS-66FW is configured as a 6 port FireWire hub in which the bi-directional signals flow between Port 4 and all the other ports

³ Failure to press the TAKE button within 30 seconds (the Timeout) will abort the action

6.3.1 Toggling between the AT ONCE and CONFIRM Modes

To toggle between the AT ONCE and CONFIRM modes, do the following:

1. Press the unlit TAKE button to toggle from the AT ONCE mode (in which the TAKE button is not illuminated) to the CONFIRM mode (in which the TAKE button illuminates).
Actions now require user confirmation and the TAKE button illuminates.
2. Press the illuminated TAKE button to toggle from the CONFIRM mode back to the AT ONCE mode.
Actions no longer require user confirmation and the TAKE button no longer illuminates.

6.3.2 Confirming a Switching Action

To confirm a switching action (in CONFIRM mode), do the following:

LEAF-BRANCH

1. Press a LEAF-BRANCH combination.
The corresponding digits in the 7-segment Display blink. The TAKE button also blinks.
2. Press the blinking TAKE button to confirm the action.
The corresponding digits in the 7-segment Display no longer blink. The TAKE button illuminates.

6.4 Storing/Recalling Input/Output Configurations

You can store and recall up to 6 configurations using the 6 LEAF buttons and/or up to 15 configurations via RS-232, as Figure 9 illustrates:



Figure 9: Storing and Recalling using the LEAF Buttons¹

¹ The gray numbers (1 to 6) in Figure 9 that illustrate the corresponding store/recall configuration numbers, are for the purpose of illustration only and do not appear on the buttons

6.4.1 Storing an Input/Output Configuration

To store¹ the current status in memory, do the following:

1. Press the STO button.
The STO button blinks.
2. Press one of the 6 LEAF buttons (this will be the setup # in which the current status is stored). If in the CONFIRM mode, press the blinking TAKE button to confirm the action.
That setup # flashes brightly in the 7-segment Display and the memory stores the data at that reference.

6.4.2 Recalling an Input/Output Configuration

To recall a configuration, do the following:

1. Press the RCL button.
The RCL button blinks.
2. Press the appropriate LEAF button (the button # corresponding to the setup #). If in the CONFIRM mode, that setup configuration will blink in the 7-segment Display, together with the RCL button and the TAKE button, and will only be implemented after pressing the TAKE button.
The memory recalls the stored data from that reference.

Tip: If you cannot remember which of the 6 configurations is the one that you want, set the **VS-66FW** to the CONFIRM mode and manually scan all the configurations until you locate it.

6.5 Locking the Front Panel

To prevent changing the settings accidentally or tampering with the unit via the front panel buttons, lock² your **VS-66FW**. Unlocking releases the protection mechanism.

To lock the **VS-66FW**:

- Press and hold the LOCK button until the LOCK button is illuminated
The front panel is locked. Pressing a button will have no effect.

To unlock the **VS-66FW**:

- Press and hold the illuminated LOCK button, until the LOCK button is no longer illuminated
The front panel unlocks

¹ Storing a new configuration over a previous configuration (without deleting it first) replaces the previous configuration

² Nevertheless, even though the front panel is locked you can still operate via RS-232 or RS-485, as well as via the Kramer IR Remote Control Transmitter

7 Flash Memory Upgrade

The **VS-66FW** firmware is located in FLASH memory, which lets you upgrade to the latest Kramer firmware version in minutes! The process involves:

- Downloading from the Internet (see section 7.1)
- Connecting the PC to the RS-232 port (see section 7.2)
- Upgrading Firmware (see section 7.3)

7.1 Downloading from the Internet

You can download the up-to-date file from the Internet. To do so:

1. Go to our Web site at <http://www.kramerelectronics.com> and download the file: “*FLIP_VS_66FW_12.zip*” from the Technical Support section. The program automatically recognizes the size of the switcher.
2. Extract the file: “*FLIP_VS_66FW_12.zip*” to a folder (for example, C:\Program Files\Kramer Flash).

7.2 Connecting the PC to the RS-232 Port

Before installing the latest Kramer firmware version on a **VS-66FW** unit, do the following:

1. Connect the RS-232 DB9 rear panel port on the **VS-66FW** unit to the Null-modem adapter and connect the Null-modem adapter with a 9 wire flat cable to the RS-232 DB9 COM port on your PC. It is recommended that you use COM port¹ 2. However, if your computer has only one COM port, open the file: “*VS_66FW_12.cfg*” (located at C:\Program Files\Kramer Flash\ *VS_66FW_12.cfg*) in **Notepad**, and change “*set port COM2*” to “*set port COM1*”.
2. On the rear panel, push in the FLASH button² (to **Program**), using a screwdriver.
3. Connect the power cord and turn the *POWER* switch on the **VS-66FW ON**. The front panel buttons may illuminate erratically. This should be ignored.

7.3 Upgrading Firmware

Follow these steps to upgrade the firmware:

1. Double click the desktop icon: “*Shortcut to FLIP.EXE*”. The Splash screen appears as follows:

¹ The software is preset for use with COM port 2

² Item 7 in Table 2



Figure 10: Splash Screen

2. After a few seconds, the Splash screen is replaced by the “Atmel – Flip” window:

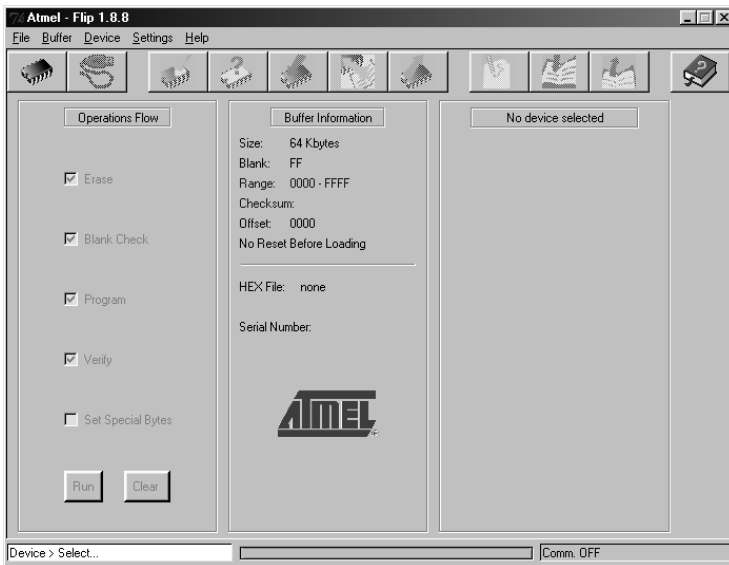

Figure 11: Atmel – Flip Window

3. Press the keyboard shortcut key *F4* (or select the “Read Configuration File” command from the *File* menu, or press the keys: *Alt FR*). The “Open Configuration File” window appears:

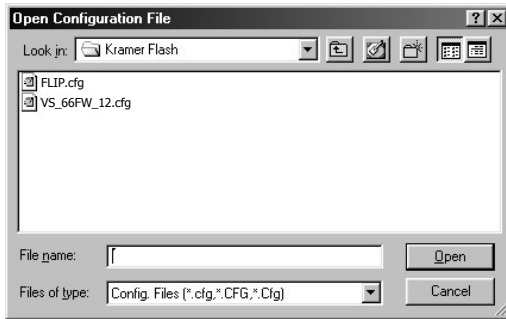

Figure 12: Open Configuration File Select Window

4. Choose the file: *VS_66FW_12.cfg* (by double-clicking it). If COM 2 was not selected, an RS-232 error message appears. In the “Atmel – Flip” window, the *Operations Flow* column is disabled, and crosses appear in the third column.

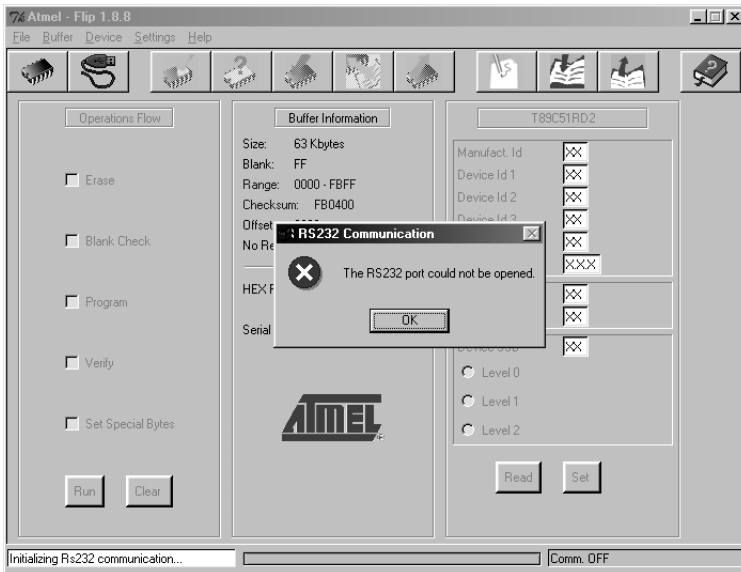

Figure 13: Atmel – Flip Window (RS-232 Communication)

5. Click OK and press the keyboard shortcut key *F3* (or select the “Communication / RS232” command from the *Settings* menu, or press the keys: *Alt SCR*). The “RS232” window appears. Change the COM port:

Flash Memory Upgrade

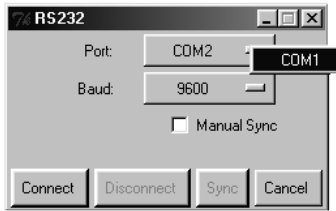

Figure 14: RS-232 Window

6. Click Connect.

In the “Atmel – Flip” window, in the *Operations Flow* column, the *Run* button is active, and the name of the chip appears as the name of the third column: *T89C51RD2*.

Verify that in the *Buffer Information* column, the “*HEX File: VS_66FW_12.hex*” appears.

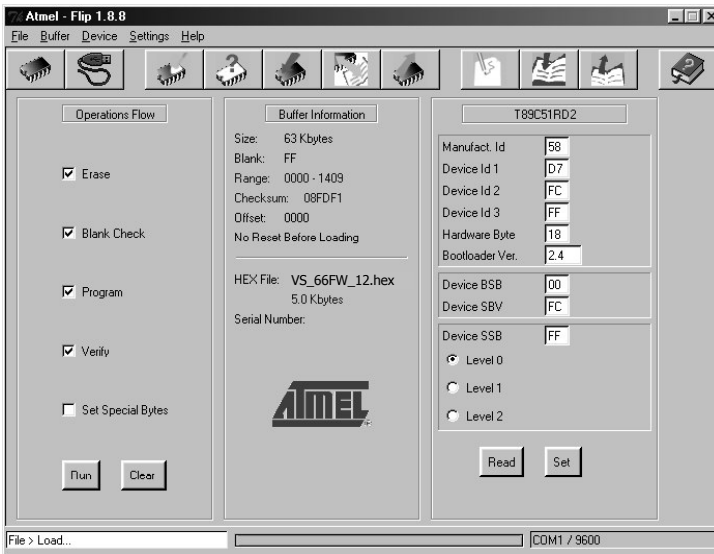

Figure 15: Atmel – Flip Window (Connected)

7. Click Run.

After each stage in the operation is completed, the check-box for that stage becomes colored green¹.

When the operation is completed, all 4 check-boxes will be colored green and the status bar message: *Memory Verify Pass* appears²:

¹ See also the blue progress indicator on the status bar

² If an error message: “Not Finished” shows, click Run again

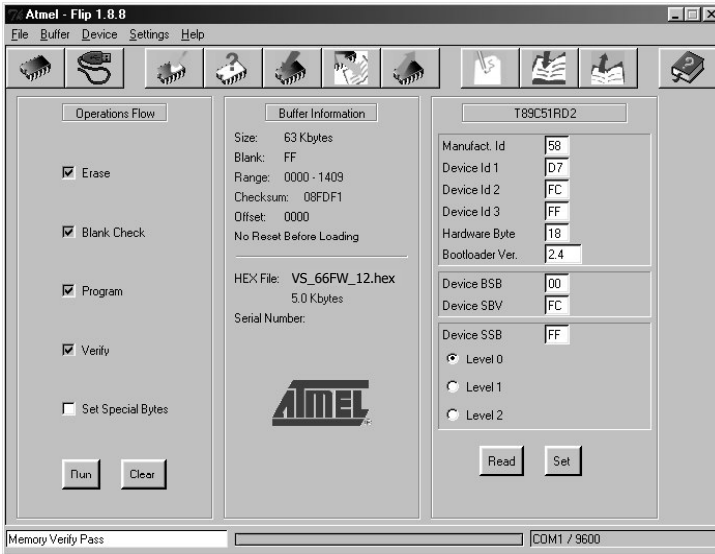

Figure 16: Atmel – Flip Window (Operation Completed)

8. Close the “Atmel – Flip” window.
9. **Turn the POWER switch on the VS-66FW OFF.**
10. Disconnect the RS-232 DB9 rear panel port on the **VS-66FW** unit from the Null-modem adapter.
11. On the rear panel, release the FLASH button¹ (to **Normal**), using a screwdriver.
12. Turn the **POWER** switch on the **VS-66FW ON**.
Upon initialization, the **VS-66FW** will work with the new firmware version.

¹ Item 7 in Table 2

8 Technical Specifications

Table 5 includes the technical specifications:

Table 5: Technical Specifications¹ of the VS-66FW 6 Port FireWire Switcher

INPUTS/OUTPUTS:	6 ports on 6 pin IEEE-1394A connectors
STANDARDS:	Compliant with IEEE 1394 – 1995 and 1394A-2000 standards
BUS TRANSFER RATE:	Up to 400Mb/s signaling rates for high performance serial bus
SOURCED POWER:	12V 1.5A total for any one or all ports
COMPATIBILITY:	PC and MAC
CONTROL:	18 front panel pushbuttons and Kramer IR remote receiver on front; RS-232 IN/OUT on a DB-9F/M and RS-485 on a detachable terminal block, remote dry-contacts on a terminal block
POWER SOURCE:	100-240 VAC, 50/60 Hz; 90VA
DIMENSIONS:	19-inch (W), 7-inch (D) 1U (H) rack-mountable
WEIGHT:	2.2 kg (4.9 lbs.) approx.
ACCESSORIES:	Power cord, Null modem adapter, Windows®-based Kramer control software, Infra-red remote control transmitter

9 Table of Hex Codes for Serial Communication

Table 6 includes the Protocol 2000 hexadecimal codes² to make a connection between ports.

Table 6: Hex Table for the VS-66FW

	LEAF 1	LEAF 2	LEAF 3	LEAF 4	LEAF 5	LEAF 6
BRANCH 1		01	01	01	01	01
		81	81	81	81	81
		82	83	84	85	86
		81	81	81	81	81
BRANCH 2	01			01	01	01
	82		82	82	82	82
	81		83	84	85	86
	81		81	81	81	81
BRANCH 3	01	01		01	01	01
	83	83		83	83	83
	81	82		84	85	86
	81	81		81	81	81
BRANCH 4	01	01	01		01	01
	84	84	84		84	84
	81	82	83		85	86
	81	81	81		81	81
BRANCH 5	01	01	01	01		01
	85	85	85	85		85
	81	82	83	84		86
	81	81	81	81		81
BRANCH 6	01	01	01	01	01	
	86	86	86	86	86	
	81	82	83	84	85	
	81	81	81	81	81	

For example, to connect branch 4 to leaf 3, send hex codes 01, 84, 83, 81.

¹ Specifications are subject to change without notice

² This example assumes MACHINE # 1, and node 0



10 Kramer Protocol 2000¹

The **VS-66FW** is compatible with Kramer's Protocol 2000 (version 0.42) (below). This RS-232 / RS-485 communication protocol uses four bytes of information as defined below. For RS-232, a null-modem connection between the machine and controller is used. The default data rate is 9600 baud, with no parity, 8 data bits and 1 stop bit.

Table 7: Protocol Definitions

MSB								LSB
		DESTINATION	INSTRUCTION					
0	D	N5	N4	N3	N2	N1	N0	
7	6	5	4	3	2	1	0	
1st byte								
		INPUT						
1	I6	I5	I4	I3	I2	I1	I0	
7	6	5	4	3	2	1	0	
2nd byte								
		OUTPUT						
1	O6	O5	O4	O3	O2	O1	O0	
7	6	5	4	3	2	1	0	
3rd byte								
		MACHINE NUMBER						
1	OVR	X	M4	M3	M2	M1	M0	
7	6	5	4	3	2	1	0	
4th byte								

1st BYTE: Bit 7 – Defined as 0.

D – “DESTINATION”: 0 - for sending information to the switchers (from the PC);

1 - for sending to the PC (from the switcher).

N5...N0 – “INSTRUCTION”

The function that is to be performed by the switcher(s) is defined by the INSTRUCTION (6 bits). Similarly, if a function is performed via the machine's keyboard, then these bits are set with the INSTRUCTION NO., which was performed. The instruction codes are defined according to the table below (INSTRUCTION NO. is the value to be set for N5...N0).

2nd BYTE: Bit 7 – Defined as 1.

I6...I0 – “INPUT”.

When switching (ie. instruction codes 1 and 2), the INPUT (7 bits) is set as the input number which is to be switched. Similarly, if switching is done via the machine's front-panel, then these bits are set with the INPUT NUMBER which was switched. For other operations, these bits are defined according to the table.

3rd BYTE: Bit 7 – Defined as 1.

O6...O0 – “OUTPUT”.

When switching (ie. instruction codes 1 and 2), the OUTPUT (7 bits) is set as the output number which is to be switched. Similarly, if switching is done via the machine's front-panel, then these bits are set with the OUTPUT NUMBER which was switched. For other operations, these bits are defined according to the table.

4th BYTE: Bit 7 – Defined as 1.

Bit 5 – Don't care.

OVR – Machine number override.

M4...M0 – MACHINE NUMBER.

Used to address machines in a system via their machine numbers. When several machines are controlled from a single serial port, they are usually configured together with each machine having an individual machine number.

If the OVR bit is set, then all machine numbers will accept (implement) the command, and the addressed machine will reply.

¹ You can download our user-friendly “Software for Calculating Hex Codes for Protocol 2000” at this URL: <http://www.kramerelectronics.com/support/bottom2.htm>

For a single machine controlled via the serial port, always set M4...M0 = 1, and make sure that the machine itself is configured as MACHINE NUMBER = 1.

Table 8: Instruction Codes for Protocol 2000 (Relevant to the VS-66FW)

Note: All values in the table are decimal, unless otherwise stated.

INSTRUCTION		DEFINITION FOR SPECIFIC INSTRUCTION		NOTE
#	DESCRIPTION	INPUT	OUTPUT	
0, 18	RESET	0	0	1
1	SWITCH VIDEO	Set equal to video input which is to be switched (0 = disconnect)	Set equal to video output which is to be switched (0 = to all the outputs)	2, 15
3	STORE VIDEO and AUDIO STATUS	Set as SETUP #	0 - to store 1 - to delete	2, 3, 15
4	RECALL VIDEO STATUS	Set as SETUP #	0	2, 3, 15
5	REQUEST STATUS OF A VIDEO OUTPUT	Set as SETUP #	Equal to output number whose status is reqd	4, 3
15	REQUEST WHETHER SETUP IS DEFINED	Set as SETUP #	0	8
16	ERROR / BUSY	0	0 - error 1 - invalid instruction 2 - out of range	9
30	LOCK FRONT PANEL	0 - Panel unlocked 1 - Panel locked	0	2
31	REQUEST WHETHER PANEL IS LOCKED	0	0	16
61	IDENTIFY MACHINE	1 - video machine name 2 - audio machine name 3 - video software version 4 - audio software version	0 - Request first 4 digits	13
62	DEFINE MACHINE	1 - number of inputs 2 - number of outputs 3 - number of setups	1 - for video 2 - for audio	14

NOTES on the above table:

NOTE 1 - When the master switcher is reset, (e.g. when it is turned on), the reset code is sent to the PC. If this code is sent to the switchers, it will reset according to the present power-down settings.

NOTE 2 - These are bi-directional definitions. That is, if the switcher receives the code, it will perform the instruction; and if the instruction is performed (due to a keystroke operation on the front panel), then these codes are sent. For example, if the HEX code

01 85 88 83

was sent from the PC, then the switcher (machine 3) will switch input 5 to output 8. If the user switched input 1 to output 7 via the front panel keypad, then the switcher will send HEX codes:

41 81 87 83

to the PC.

When the PC sends one of the commands in this group to the switcher, then, if the instruction is valid, the switcher replies by sending to the PC the same four bytes that it was sent (except for the first byte, where the DESTINATION bit is set high).

NOTE 3 - SETUP # 0 is the present setting. SETUP # 1 and higher are the settings saved in the switcher's memory, (i.e. those used for Store and Recall).

NOTE 4 - The reply to a "REQUEST" instruction is as follows: the same instruction and INPUT codes as were sent are returned, and the OUTPUT is assigned the value of the requested parameter. The replies to instructions 10 and 11 are as per the definitions in instructions 7 and 8 respectively. For example, if the present status of machine number 5 is breakaway setting, then the reply to the HEX code

0B 80 80 85

would be HEX codes

4B 80 81 85

NOTE 5 - For the OUTPUT byte set as 6, the VIS source is the input selected using the OUTPUT byte. Similarly, for the OUTPUT byte set as 7, the VIS source is the output selected using the OUTPUT byte. Note also, that on some machines the sync source is not software selectable, but is selected using switches, jumpers, etc!

NOTE 6 – If INPUT is set to 127 for these instructions, then, if the function is defined on this machine, it replies with OUTPUT=1. If the function is not defined, then the machine replies with OUTPUT=0, or with an error (invalid instruction code).

If the INPUT is set to 126 for these instructions, then, if possible, the machine will return the current setting of this function, even for the case that the function is not defined. For example, for a video switcher which always switches during the VIS of input #1, (and its VIS setting cannot be programmed otherwise), the reply to the HEX code

0A	FE	80	81 (i.e. request VIS setting, with INPUT set as 126dec)
would be HEX codes			
4A	FE	81	81 (i.e. VIS setting = 1, which is defined as VIS from input #1).

NOTE 7 – Setting OUTPUT to 0 will return the VIS source setting as defined in instruction #7. Setting to 1 will return the input # or output # of the sync source (for the case where the VIS source is set as 6 or as 7 in instruction #7). Setting to 2 returns the vertical sync frequency (0 for no input sync, 50 for PAL, 60 for NTSC, 127 for error).

NOTE 8 - The reply to the "REQUEST WHETHER SETUP IS DEFINED" is as in TYPE 3 above, except that here the OUTPUT is assigned with the value 0 if the setup is not defined; or 1 if it is defined.

NOTE 9 - An error code is returned to the PC if an invalid instruction code was sent to the switcher, or if a parameter associated with the instruction is out of range (e.g. trying to save to a setup greater than the highest one, or trying to switch an input or output greater than the highest one defined). This code is also returned to the PC if an RS-232 instruction is sent while the machine is being programmed via the front panel. Reception of this code by the switcher is not valid.

NOTE 10 – This code is reserved for internal use.

NOTE 11 – For machines where the video and / or audio gain is programmable.

NOTE 12 - Under normal conditions, the machine's present status is saved each time a change is made. The "power-down" save (auto-save) may be disabled using this code. Note that whenever the machine is turned on, the auto-save function is set.

NOTE 13 - This is a request to identify the switcher/s in the system. If the OUTPUT is set as 0, and the INPUT is set as 1, 2, 5 or 7, the machine will send its name. The reply is the decimal value of the INPUT and OUTPUT. For example, for a 2216, the reply to the request to send the audio machine name would be (HEX codes):

7D	96	90	81 (i.e. 128dec+ 22dec for 2nd byte, and 128dec+ 16dec for 3rd byte).
----	----	----	---

If the request for identification is sent with the INPUT set as 3 or 4, the appropriate machine will send its software version number. Again, the reply would be the decimal value of the INPUT and OUTPUT - the INPUT representing the number in front of the decimal point, and the OUTPUT representing the number after it. For example, for version 3.5, the reply to the request to send the version number would be (HEX codes):

7D	83	85	81 (i.e. 128dec+ 3dec for 2nd byte, 128dec+ 5dec for 3rd byte).
----	----	----	---

If the OUTPUT is set as 1, then the ASCII coding of the lettering following the machine's name is sent. For example, for the VS-7588YC, the reply to the request to send the first suffix would be (HEX codes):

7D	D9	C3	81 (i.e. 128dec+ ASCII for "Y"; 128dec+ ASCII for "C").
----	----	----	---

NOTE 14 - The number of inputs and outputs refers to the specific machine, which is being addressed, not to the system. For example, if six 16X16 matrices are configured to make a 48X32 system (48 inputs, 32 outputs), the reply to the HEX code

3E	82	81	82 (ie. request the number of outputs)
would be HEX codes			
7E	82	90	82

i.e. 16 outputs

NOTE 15 – When the OVR bit (4th byte) is set, then the "video" commands have universal meaning. For example, instruction 1 (SWITCH VIDEO) will cause all units (including audio, data, etc.) to switch. Similarly, if a machine is in "FOLLOW" mode, it will perform any "video" instruction.

NOTE 16 - The reply to the "REQUEST WHETHER PANEL IS LOCKED" is as in NOTE 4 above, except that here the OUTPUT is assigned with the value 0 if the panel is unlocked, or 1 if it is locked.

NOTE 17 – Delayed execution allows switching after a delay dictated by RS-232. To do this, the user sends instruction 7 with the "Set for delayed switch" option (64dec) before sending the switch command (instruction 1) or pressing via front panel. The switch is not executed (unless timed-out) until the "Execute delayed switch" code is sent, or the ""Set for delayed switch" code is sent again. (The mode is automatically cancelled after implementation of the switch if the "execute" command is used).

For example, to connect input 4 to output 3 after a delay, send HEX codes

07	80	C0	81 (set for delayed switch)
01	84	83	81 (switch code)

then, after the required delay, send HEX codes
07 80 C1 81 (execute delayed switch)
to implement the switch.

NOTE 18 – After this instruction is sent, the unit will respond to the ASCII command set. The ASCII command to operate with the HEX command set must be sent in order to return to working with HEX codes.

NOTE 19 – When data (ie. the INPUT and/or OUTPUT bytes) of more than 7 bits is required, this instruction is sent before sending the instruction needing the additional bits. The data in this instruction then becomes the Most Significant Bits of that next instruction. For example, to set the audio gain (instruction 22) of output 3 to 681dec (2A9hex), you would first send HEX codes

3F 80 85 81
and then send HEX codes
16 83 A9 81

To set the audio gain of output 6 to 10013dec (271Dhex), first send HEX codes

3F 80 CE 81
followed by HEX codes
16 86 9D 81

NOTE 20 – To store data in the non-volatile memory of the unit, e.g. the EEPROM for saving SETUPS. The EEPROM address is sent using the INPUT byte, and the data to be stored is sent using the OUTPUT byte. To use this instruction, it is necessary to understand the memory map, and memory structure of the particular machine.

NOTE 21 – Instruction 59 and instruction 60 load data for sending to the crosspoint switcher (or for storing in a SETUP), i.e. the data is “lined-up” to be executed later. Instruction 58 executes the loaded data.

NOTE 22 – If the INPUT byte is set as 127dec, then the data stored in a SETUP is loaded. The SETUP # is in the OUTPUT byte.

NOTE 23 – Further information needed in instructions 21, 22, 25 and 26, is sent using instruction 42 – which is sent prior to the instruction. For example, to request the audio gain value of right input # 9, send hex codes

2A 84 80 81
and then send HEX codes
19 89 81 81

LIMITED WARRANTY

Kramer Electronics (hereafter *Kramer*) warrants this product free from defects in material and workmanship under the following terms.

HOW LONG IS THE WARRANTY

Labor and parts are warranted for three years from the date of the first customer purchase.

WHO IS PROTECTED?

Only the first purchase customer may enforce this warranty.

WHAT IS COVERED AND WHAT IS NOT COVERED

Except as below, this warranty covers all defects in material or workmanship in this product. The following are not covered by the warranty:

1. Any product which is not distributed by Kramer, or which is not purchased from an authorized Kramer dealer. If you are uncertain as to whether a dealer is authorized, please contact Kramer at one of the agents listed in the web site www.kramerelectronics.com.
2. Any product, on which the serial number has been defaced, modified or removed.
3. Damage, deterioration or malfunction resulting from:
 - i) Accident, misuse, abuse, neglect, fire, water, lightning or other acts of nature
 - ii) Product modification, or failure to follow instructions supplied with the product
 - iii) Repair or attempted repair by anyone not authorized by Kramer
 - iv) Any shipment of the product (claims must be presented to the carrier)
 - v) Removal or installation of the product
 - vi) Any other cause, which does not relate to a product defect
 - vii) Cartons, equipment enclosures, cables or accessories used in conjunction with the product

WHAT WE WILL PAY FOR AND WHAT WE WILL NOT PAY FOR

We will pay labor and material expenses for covered items. We will not pay for the following:

1. Removal or installations charges.
2. Costs of initial technical adjustments (set-up), including adjustment of user controls or programming. These costs are the responsibility of the Kramer dealer from whom the product was purchased.
3. Shipping charges.

HOW YOU CAN GET WARRANTY SERVICE

1. To obtain service on your product, you must take or ship it prepaid to any authorized Kramer service center.
2. Whenever warranty service is required, the original dated invoice (or a copy) must be presented as proof of warranty coverage, and should be included in any shipment of the product. Please also include in any mailing a contact name, company, address, and a description of the problem(s).
3. For the name of the nearest Kramer authorized service center, consult your authorized dealer.

LIMITATION OF IMPLIED WARRANTIES

All implied warranties, including warranties of merchantability and fitness for a particular purpose, are limited in duration to the length of this warranty.

EXCLUSION OF DAMAGES

The liability of Kramer for any effective products is limited to the repair or replacement of the product at our option. Kramer shall not be liable for:

1. Damage to other property caused by defects in this product, damages based upon inconvenience, loss of use of the product, loss of time, commercial loss; or
2. Any other damages, whether incidental, consequential or otherwise. Some countries may not allow limitations on how long an implied warranty lasts and/or do not allow the exclusion or limitation of incidental or consequential damages, so the above limitations and exclusions may not apply to you.

This warranty gives you specific legal rights, and you may also have other rights, which vary from place to place.

NOTE: All products returned to Kramer for service must have prior approval. This may be obtained from your dealer.

This equipment has been tested to determine compliance with the requirements of:

- EN-50081: "Electromagnetic compatibility (EMC);
generic emission standard.
Part 1: Residential, commercial and light industry"
- EN-50082: "Electromagnetic compatibility (EMC) generic immunity standard.
Part 1: Residential, commercial and light industry environment".
- CFR-47:
FCC Rules and Regulations:
Part 15: "Radio frequency devices
Subpart B – Unintentional radiators"

CAUTION!

- ☒ Servicing the machines can only be done by an authorized Kramer technician. Any user who makes changes or modifications to the unit without the expressed approval of the manufacturer will void user authority to operate the equipment.
- ☒ Use the supplied DC power supply to feed power to the machine.
- ☒ Please use recommended interconnection cables to connect the machine to other components.



For the latest information on our products and a list of Kramer distributors, visit our Web site: www.kramerelectronics.com.

Updates to this user manual may be found at <http://www.kramerelectronics.com/manuals.html>.

We welcome your questions, comments and feedback.



Kramer Electronics, Ltd.

Web site: www.kramerelectronics.com

E-mail: info@kramerel.com

P/N: 2900-00066 REV 1

Free Manuals Download Website

<http://myh66.com>

<http://usermanuals.us>

<http://www.somanuals.com>

<http://www.4manuals.cc>

<http://www.manual-lib.com>

<http://www.404manual.com>

<http://www.luxmanual.com>

<http://aubethermostatmanual.com>

Golf course search by state

<http://golfingnear.com>

Email search by domain

<http://emailbydomain.com>

Auto manuals search

<http://auto.somanuals.com>

TV manuals search

<http://tv.somanuals.com>