

# User Guide

The Insignia logo features the word "INSIGNIA" in a bold, metallic, 3D-style font. The letter "I" has a small starburst above it. The letter "G" is stylized with a green, glowing ring around it, and a small starburst is positioned above the top of the "G". A small "TM" trademark symbol is located to the right of the letter "A".

INSIGNIA™

Digital to Analog Converter Box

**NS-DXA2**

Before using your new product, please read these instructions to prevent any damage.

Download from [www.Somaterials.com](http://www.Somaterials.com). All Manuals Search & Download by: [www.Somaterials.com](http://www.Somaterials.com)

# Insignia NS-DXA2

## Digital to Analog Converter Box

### Contents

Welcome .....	1
Safety information .....	1
Features .....	4
Package contents .....	4
Front and Back .....	4
Remote control .....	5
Setting up your converter box .....	6
Connecting with an AV cable (best) .....	6
Connecting with an RF (coaxial) cable (good) .....	7
Using the analog pass-through .....	7
Setting initial setup options .....	8
Using your converter box .....	10
Turning your converter box on or off .....	10
Changing channels .....	10
Adjusting the volume .....	10
Displaying the program list .....	11
Changing the AV settings .....	11
Changing the sound setting .....	12
Changing the video aspect ratio .....	13
Changing the RF output channel .....	14
Changing the Ratings settings .....	15
Turning Parental Control on or off .....	16
Setting the Parental Control rating limits .....	17
Changing your password .....	19
Changing the Closed Captioning settings .....	21
Changing the general settings .....	21
Troubleshooting .....	22
Specifications .....	23
Legal notices .....	24
90-day limited warranty - Insignia .....	25

## Welcome

Congratulations on your purchase of a high-quality Insignia product. Your NS-DXA2 represents the state of the art in digital to analog converter box design and is designed for reliable and trouble-free performance.

## Safety information



CAUTION  
RISK OF ELECTRIC SHOCK  
DO NOT OPEN



**CAUTION:** TO REDUCE THE RISK OF ELECTRIC SHOCK DO NOT REMOVE THE COVER (OR BACK). NO USER-SERVICEABLE PARTS INSIDE. REFER SERVICING TO QUALIFIED SERVICE PERSONNEL.



The lightning flash with arrowhead symbol within a triangle is intended to alert you to the presence of uninsulated dangerous voltage within your converter box's enclosure that may be of sufficient magnitude to constitute risk of electric shock to persons.



The exclamation point within a triangle is intended to alert you to the presence of important operating and maintenance (servicing) instructions in the literature accompanying your converter box.

**WARNING:** To prevent fire or electric shock hazard, do not expose your converter box to rain or moisture.

**WARNING:** Do not install your converter box in a confined space such a bookcase or similar unit.

**WARNING:** Do not block any ventilation openings. Install in accordance with the manufacturer's instructions. Slots and openings in the cabinet are provided for ventilation and to ensure reliable operation of your converter box and to protect it from overheating.

The openings should never be blocked by placing your converter box on a bed, sofa, rug, or other similar surface. Your converter box should not be placed in a built-in installation such as a bookcase or rack unless proper ventilation is provided or the manufacturer's instructions have been adhered to.

**CAUTION:** Your converter box should not be exposed to water (dripping or splashing) and no objects filled with liquids, such as vases, should be placed on it.

**POWER ADAPTER WARNING:** The manufacturers of most appliances recommend that their appliance be placed on a dedicated circuit—a single outlet circuit which powers only that appliance and has no additional outlets or branch circuits. Overloaded power outlets, loose or damaged wall outlets, extension cords, frayed power cords, or damaged or cracked wire insulation are dangerous. Any of these conditions could result in electric shock or fire. Periodically examine the power adapter of your converter box, and if its appearance indicates damage or deterioration, unplug it, discontinue use of your converter box, and have the power adapter replaced with an exact replacement part by an authorized service personnel. Protect the power adapter from physical or mechanical abuse, such as being twisted, kinked, pinched, closed in a door, or walked upon. Pay particular attention to plugs, wall outlets, and the point where the power adapter cord exits your converter box.

To disconnect the main power from your converter box, unplug the power adapter from the power outlet. When installing your converter box, make sure that the plug is easily accessible.

## Important safety instructions

- 1 Read these instructions.
- 2 Keep these instructions.
- 3 Heed all warnings.
- 4 Follow all instructions.
- 5 Do not use your converter box near water.
- 6 Clean only with a dry cloth.
- 7 Do not block any ventilation openings. Install in accordance with the manufacturer's instructions.
- 8 Do not install near any heat sources such as radiators, heat registers, stoves, or other apparatus (including amplifiers) that produces heat.
- 9 Protect the power cord from being walked on or pinched particularly at plugs, convenience receptacles, and the point where it exits from the apparatus.
- 10 Only use attachments or accessories specified by the manufacturer.
- 11 Unplug your converter box during lightning storms or when unused for long periods of time.
- 12 Refer all servicing to qualified service personnel. Servicing is required when your converter box has been damaged in any way, such as when the power cord or plug is damaged, liquid has been spilled or objects have fallen into your converter box, your converter box has been exposed to rain or moisture, does not operate normally, or has been dropped.

## WARNING

### ***Electric shock hazard***

To reduce the risk of fire or electric shock, do not remove any cover or expose the device to rain or moisture. No user-serviceable parts are inside. Refer servicing to qualified service technicians.

### ***Lightning***

For added protection for your device during a lightning storm, or when it is left unattended and unused for long periods of time, unplug it from the power outlet and disconnect any antenna or cable system. This helps prevent property damage and personal injury from lightning and power line surges.

### ***Power lines***

An outside antenna system should not be located in the vicinity of overhead power lines or other electric light or power circuits, or where it can fall into such power lines or circuits. When installing an outside antenna system, extreme care should be taken to keep from touching such power lines or circuits as contact with them might be fatal.

## Servicing

These servicing instructions are for use by qualified service personnel only. To reduce the risk of electric shock, do not perform any servicing other than that contained in the operating instructions unless you are qualified to do so.

## CAUTION

### Damage requiring service

Unplug this converter box from the power outlet and refer servicing to qualified service personnel under the following conditions:

- When the power supply cord or plug is damaged or frayed.
- If liquid has been spilled or objects have fallen into your converter box.
- If your converter box has been exposed to rain or water.
- If your converter box does not operate normally by following the operating instructions. Adjust only those controls that are covered by the operating instructions because incorrect adjustment of other controls may result in damage and will often require extensive work by a qualified technician to restore your TV/DVD combo to its normal operation.
- If your converter box has been dropped or damaged in any way.
- When your converter box exhibits a distinct change in performance.

### Outdoor antenna grounding

If an outside antenna or cable system is connected to your converter box, make sure that the antenna or cable system is grounded to provide some protection against voltage surges and built-up static charges. Article 810 of the National Electrical Code, ANSI/NFPA No. 70, provides information with respect to correct grounding of the mast and supporting structure, grounding of the lead-in wire to an antenna discharge unit, size of grounding conductors, location of the antenna-discharge unit, connection to grounding electrodes, and requirements for the grounding electrode.

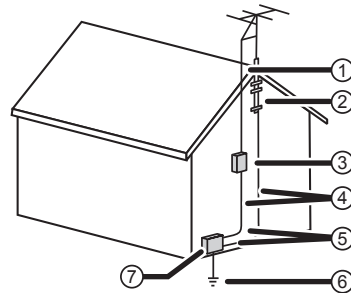

- ① Antenna lead-in wire
- ② Grounding clamp
- ③ Antenna discharge unit
- ④ Grounding conductors
- ⑤ Ground clamps
- ⑥ Power service grounding electrode system
- ⑦ Electric service equipment

### Note to CATV system installer

Article 820 of the National Electrical Code, ANSI/NFPA No. 40 provides guidance for correct grounding. Specifically, it states that the cable ground must be connected to the grounding system of the building as close to the point of cable entry as practical.

## Features

### Package contents

- Converter box
- Remote control and batteries (2)
- RF cable
- AC adapter
- *Quick Setup Guide*

### Front and Back

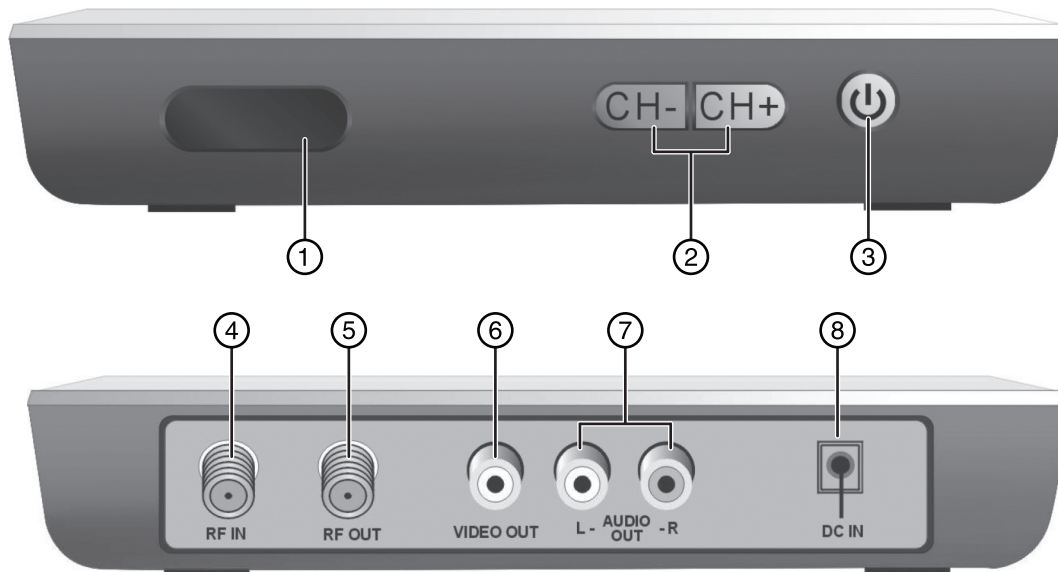

No.	Component	Description
1	Power indicator	Lights when your converter box is turned on. Red—Standby mode Green—On mode
2	<b>CH-/CH+</b>	Press to scan through memorized channels.
3	⏻ (power)	Press to turn your converter box on or off.
4	<b>RF IN</b>	Connect this jack to your antenna.
5	<b>RF OUT</b>	If your TV does not have A/V jacks, connect this jack to the <b>Antenna IN</b> jack on your TV.
6	<b>VIDEO OUT</b>	Connect a yellow AV cable from this jack to the <b>AV IN</b> jack (yellow) on your TV. This jack provides the best video. <b>Note:</b> If your TV does not have AV jacks, connect your TV to the <b>RF OUT</b> jack.
7	<b>AUDIO OUT L/R</b>	Connect these jacks to the corresponding <b>AUDIO IN L/R</b> jacks on your TV. These jacks provide the best audio. <b>Note:</b> If your TV does not have AV jacks, connect your TV to the <b>RF OUT</b> jack.
8	<b>DC IN</b>	Connect the DC output from the AC power adapter to this jack.

## Remote control

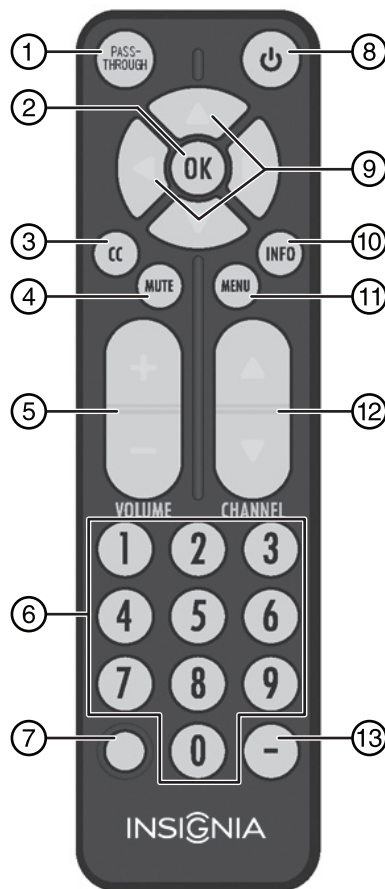

No.	Button	Description
1	<b>PASS-THROUGH</b>	Press to by-pass the converter box so that your TV will function as it did without the converter box (receiving analog channels only).
2	<b>OK</b>	Press to select a highlighted menu item.
3	<b>CC</b>	Press to turn on closed captioning.
4	<b>MUTE</b>	Press to turn off the sound. Press again to restore the sound.
5	<b>VOLUME+/-</b>	Press to increase or decrease the volume.
6	Numbers	Press to enter a channel number or parental control password.
7	N/A	Not used.
8	⏻ (power)	Press to turn the converter box on or off.
9	▲ ▼ ◀ ▶	Press to navigate through the on-screen menus.
10	<b>INFO</b>	Press to display information about the current program.
11	<b>MENU</b>	Press to open the on-screen menus.
12	<b>CHANNEL ▲ ▼</b>	Press to change channels.
13	—	Press to enter a sub-channel number. For example, to enter sub-channel 1 for the main channel 2, press <b>2</b> , press this button, then press <b>1</b> .

## Installing the remote control batteries

### To install the remote control batteries:

- 1 Remove the battery compartment cover on the back of the remote control.
- 2 Insert two AAA batteries (included) into the battery compartment. Make sure that the + and – on the battery align with the + and – in the battery compartment.
- 3 Replace the battery compartment cover.

## Setting up your converter box

### Connecting with an AV cable (best)

If your TV has Video (yellow) and Audio Left/Right (white/red) AV ports, use this procedure.

### To connect your converter box with AV cables:

- 1 Connect your existing antenna cable to the **RF IN** jack on the converter box. You may need to remove the antenna cable from the back of your TV and connect it to the converter box.
- 2 Connect one end of a yellow video cable (not included) to the **VIDEO OUT** jack on the converter box. Connect the other end to the **VIDEO IN** jack on the TV.

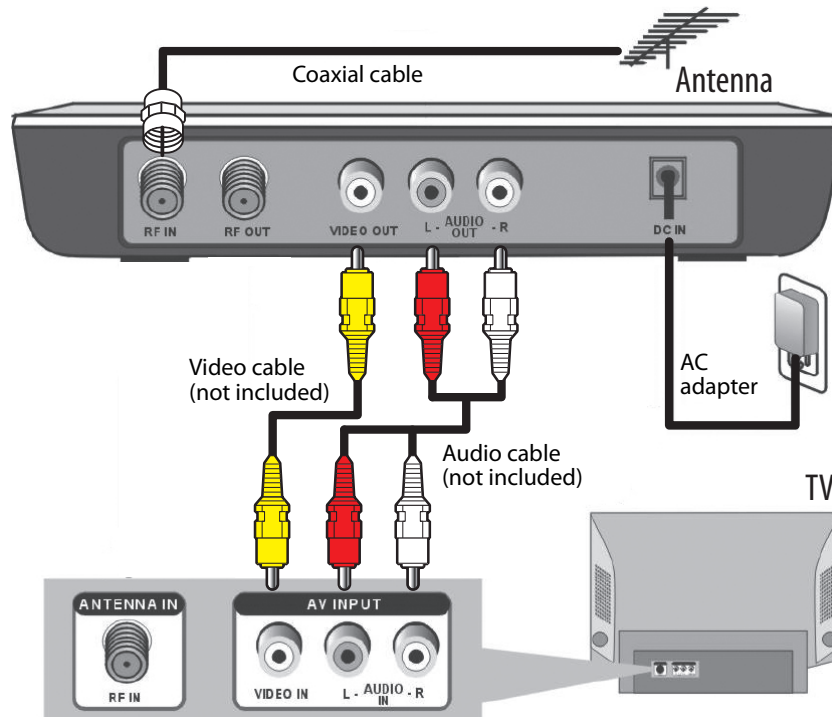

- 3 Connect one end of the red and white audio cable (not included) to the **AUDIO OUT L/R** jack on the converter box. Connect the other end to the **AUDIO IN L/R** jack on the TV.
- 4 Plug the AC adapter into a power outlet or surge protector, then plug the end of the cable into the **DC IN** jack on the converter box.
- 5 Turn on the converter box and TV and select the **AV IN** signal source on the TV.

## Connecting with an RF (coaxial) cable (good)

The resolution of the video signal output is 480i for both RF and AV connections, but AV gives better sound and signal quality.

### To connect your converter box with RF (coaxial) cable:

- 1 Connect your existing antenna cable to the **RF IN** jack on the converter box. You may need to remove the antenna cable from the back of your TV and connect it to the converter box.
- 2 Connect a coaxial cable (included) to the **RF OUT** jack on the back of your converter box, then connect the other end of the cable to the **ANTENNA IN** jack on the back of the TV. For best performance with this connection, change the **Audio Output** option to **Mono** from **Stereo** (refer to your TV's user guide).

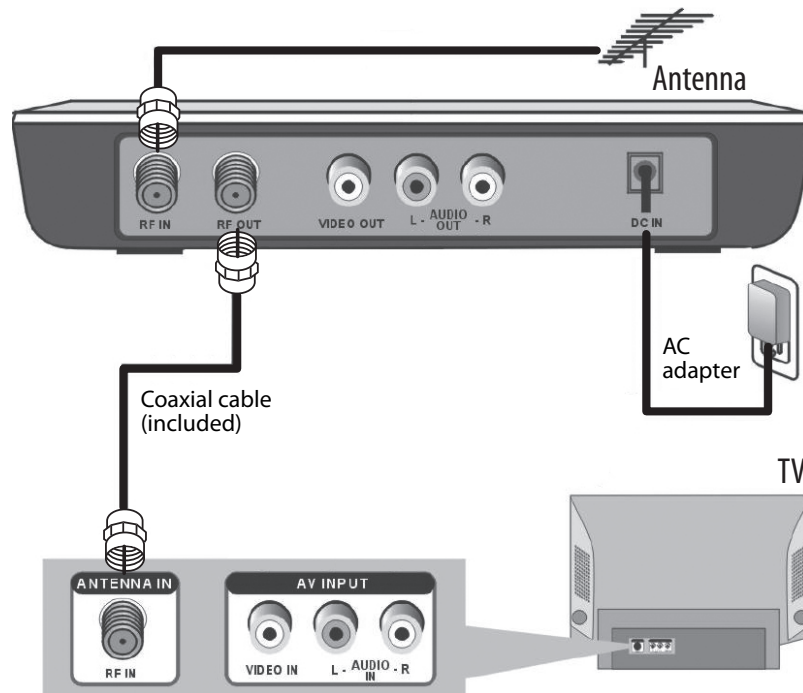

- 3 Plug the AC adapter into a power outlet or surge protector, then plug the end of the cable into the **DC IN** jack on the converter box.
- 4 Turn on your TV and converter box.
- 5 Tune the TV to channel **3** and follow the Easy Install wizard on the screen when you turn it on for the first time.  
If channel **3** is used as a broadcast station in your area, you need to switch the converter box's RF Output to channel **4** after the Easy Install wizard is finished. To change the RF Output, press **MENU** on the remote control, select **AV Settings** > **RFM**. Press **▲ ▼** to switch between **RF CH-3** and **RF CH-4**.

## Using the analog pass-through

If you live in an area where some TV stations (such as low-power stations, translator stations, Class A stations, etc.) are still broadcasting analog signals, your TV can receive these signals by using the analog pass-through feature of your converter box.

### To use the analog pass-through:

- 1 Use the included RF cable to connect the Converter Box to your TV following the instructions above.

#### Note

Analog pass-through will not work if you connect the converter box using the optional AV cable. However, you can connect both cable types at the same time.

- 2 Press the **PASS-THROUGH** button on the remote control to activate the analog pass-through function.
- 3 Change the channels on your TV set using the TV's remote control to tune to the desired analog channel.



## Setting initial setup options

When you turn on your converter box for the first time, the Easy Install wizard opens where you can:

- Select the menu language
- Search for and memorize channels

### To set basic options:

- 1 Turn on your converter box and TV. The *WELCOME* screen opens.

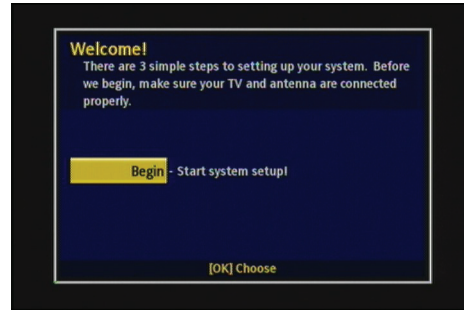

- 2 Press **OK**. The *Language* screen opens.

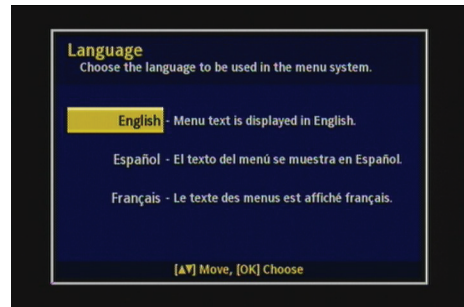

- 3 Press **▲** or **▼** to select the menu language (**English, Spanish, or French**), then press **OK**. The *Time Zone* screen opens.

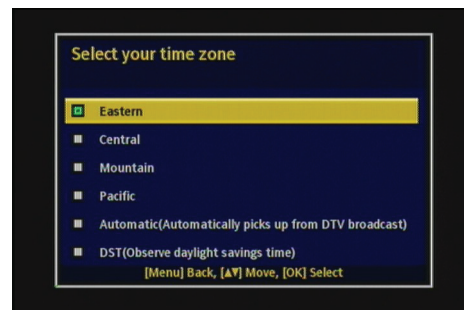

- 4 Press ▲ or ▼ to select your time zone (**Eastern, Central, Mountain, Pacific, Automatic, or DST** [Daylight Savings Time]), then press **OK**. The *Channel Scan* screen opens.

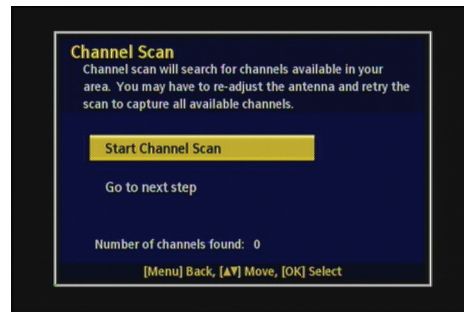

- 5 Press **OK** to start the channel scan. Your converter box searches for available channels in your area and stores them in memory. When the channel scan finishes, another *Signal Strength* screen opens.

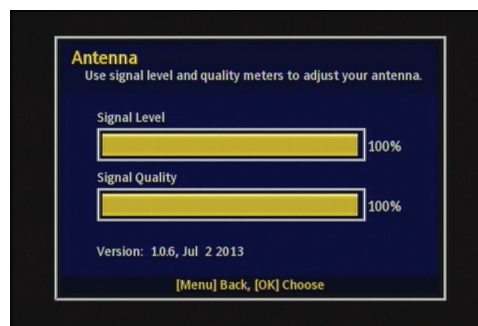

#### Note

The channel scan process may take 15 minutes or more.

- 6 Press **OK** to proceed. The *Setup Complete* screen opens.

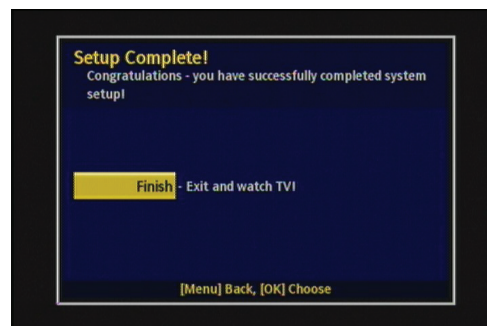

- 7 Press **OK** to exit. A *Program List* screen opens showing available channels.  
 8 Press **OK** to proceed.  
 9 Press ▲ or ▼ to select **Done** to complete the initial setup.

## Using your converter box

### Turning your converter box on or off

**To turn your converter box on or off:**

- 1 Make sure that the TV is connected to your converter box and that the TV and your converter box are plugged into power outlets.
- 2 Press **⏻** (power). The power LED lights.
  - Red—Standby mode
  - Green—On mode
- 3 If this is the first time you have turned on your converter box, follow the on-screen prompts to set basic options. For more information, see “Setting initial setup options” on page 8.
- 4 To turn off your converter box, press **⏻** (power) again.

### Changing channels

**To change channels:**

- Press **CH ▲** or **CH ▼** to select a channel in the memorized channel list.
- Press the number buttons for the channel you want. If you want a digital sub-channel, press the number buttons for the main channel, press **-**, then press the number for the sub-channel.

### Adjusting the volume

**To adjust the volume:**

- Press **VOL +** or **VOL -** to increase or decrease the volume.
- Press **MUTE** to turn off the sound. Press **MUTE** again to restore the sound.

## Using the Setup Menu

**To open the Setup Menu:**

- 1 Press **MENU** on the remote control. The *Main Menu* opens.

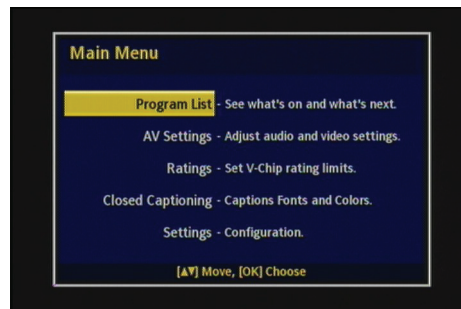

- 2 Press **▲** or **▼** to select the menu item you want to review, then press **OK** to access.

## Displaying the program list

You can open the program list to display a list of what program is currently on and what program is next.

### To open the *Program List*:

- 1 Press **MENU** on the remote control. The *Main Menu* opens.

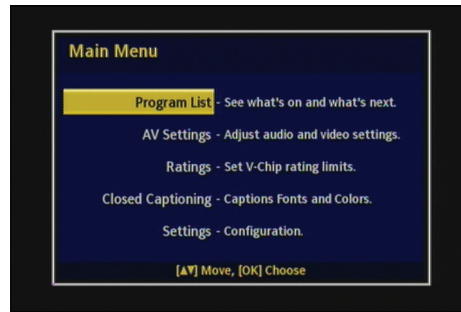

- 2 Press **▲** or **▼** to select **Program List**, then press **OK**. The *Program List* opens.

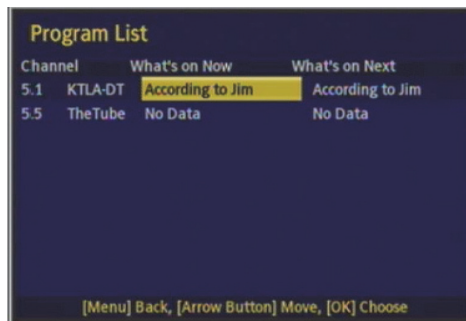

- 3 Press **▲** or **▼** to select the program you want, then press **OK** to go to that program.
- 4 Press **MENU** to exit the on-screen menu.

## Changing the AV settings

### To change the AV settings:

- 1 Press **MENU** on the remote control. The *Main Menu* opens.

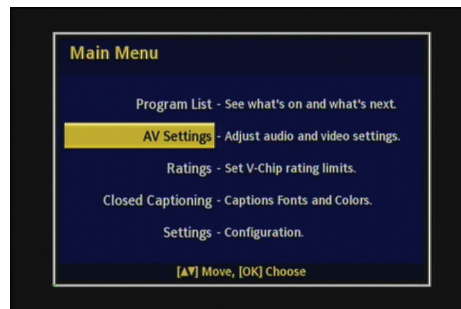

- Press **▲** or **▼** to select **AV Settings**, then press **OK**. The *AV Settings* menu opens.

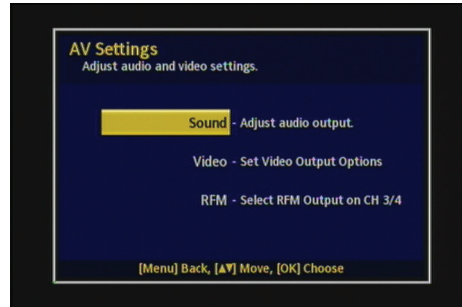

- Press **▲** or **▼** to select the AV setting you want, then press **OK** to go to that menu.

- Press **MENU** to exit the on-screen menu.

## Changing the sound setting

### To change the sound setting:

- Press **MENU** on the remote control. The *Main Menu* opens.

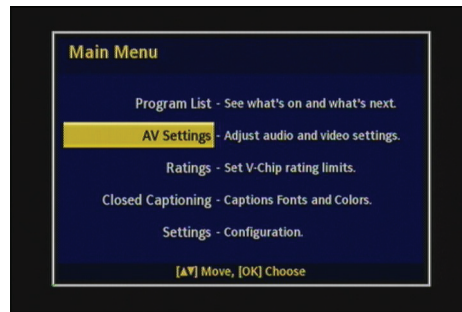

- Press **▲** or **▼** to select **AV Settings**, then press **OK**. The *AV Settings* menu opens.

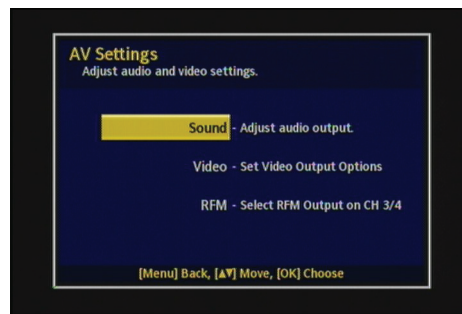

- Press **▲** or **▼** to select **Sound**, then press **OK**. The *Sound* menu opens.

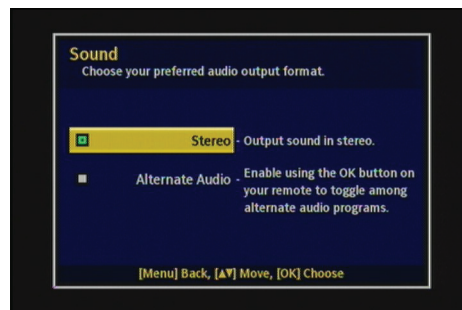

- 4 Press **▲** or **▼** to select the type of sound output you want, then press **OK**. You can select:
  - **Stereo**—For 2-channel, stereophonic sound.
  - **Alternate Audio**—Press **OK** to switch between language options while watching a TV program, if alternate languages are available.
- 5 Press **MENU** to exit the on-screen menu.

### Changing the video aspect ratio

#### To change the video aspect ratio:

- 1 Press **MENU** on the remote control. The *Main Menu* opens.

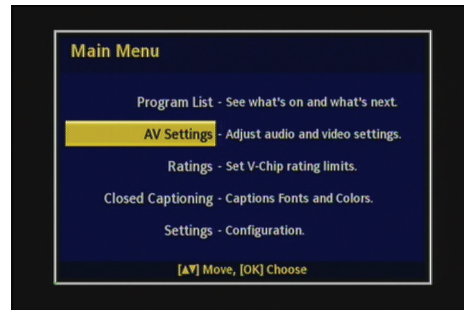

- 2 Press **▲** or **▼** to select **AV Settings**, then press **OK**. The *AV Settings* menu opens.

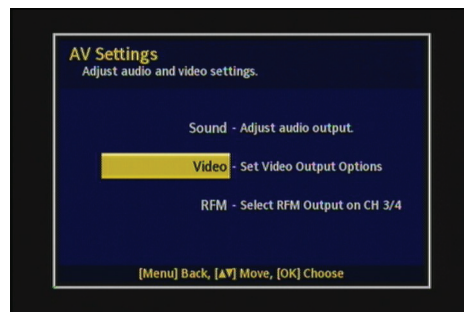

- 3 Press **▲** or **▼** to select **Video**, then press **OK**. The *Video* menu opens.

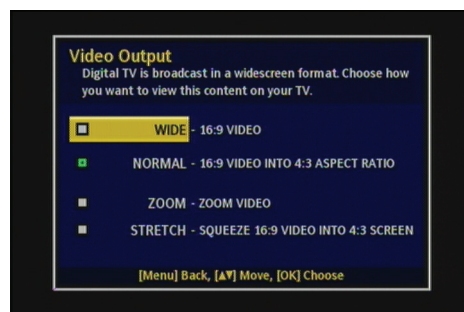

- 4 Press **▲** or **▼** to select the aspect ratio you want, then press **OK**. Options include:
  - **Widescreen**—Use this option to view content recorded in a 16:9 (wide-screen) aspect ratio.
  - **Full**—Displays the original 4:3 aspect ratio with vertical black bars on the left and right of the image.
  - **Auto**—Automatically adjusts the image based on the screen size and the TV program.
- 5 Press **MENU** to exit the on-screen menu.

## Changing the RF output channel

### To change the RF output:

- 1 Press **MENU** on the remote control. The *Main Menu* opens.

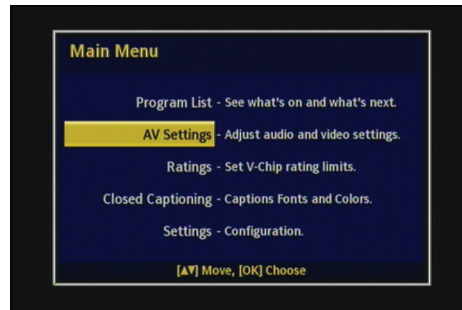

- 2 Press **▲** or **▼** to select **AV Settings**, then press **OK**. The *AV Settings* menu opens.

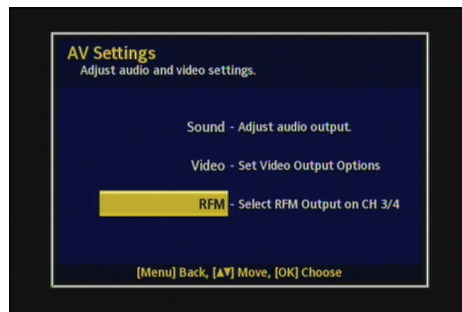

- 3 Press **▲** or **▼** to select **RFM**, then press **OK**. The *RFM output* menu opens.

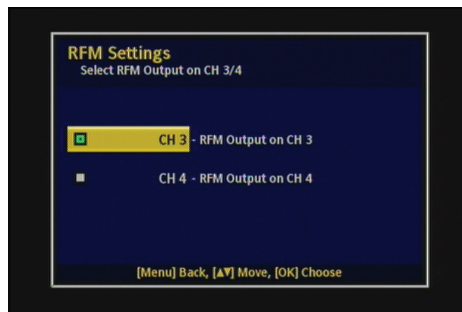

- 4 Press **▲** or **▼** to select the RF channel you want (**CH-3** or **CH-4**), then press **OK**.
- 5 Press **MENU** to exit the on-screen menu.

## Changing the Ratings settings

### To change the Ratings settings:

- 1 Press **MENU** on the remote control. The *Main Menu* opens.

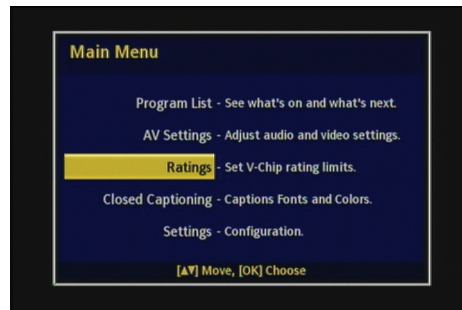

- 2 Press **▲** or **▼** to select **Ratings**, then press **OK**. The *Enter PIN* screen opens.

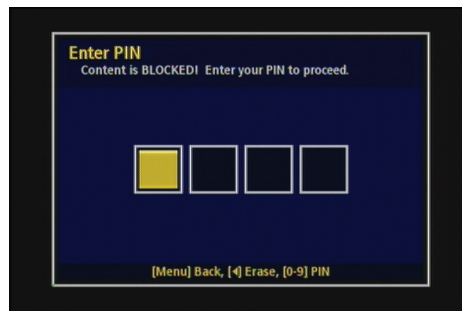

- 3 Using the number keys, enter your PIN number (the default number is **1234**), then press **OK**. The *Ratings* menu opens.

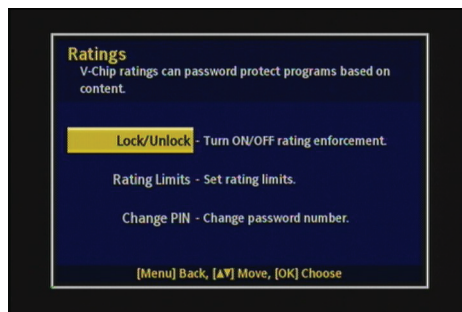

- 4 Press **▲** or **▼** to select the Ratings setting you want, then press **OK** to go to that menu.
- 5 Press **MENU** to exit the on-screen menu.



## Turning Parental Control on or off

To turn Parental Control on or off:

- 1 Press **MENU** on the remote control. The *Main Menu* opens.

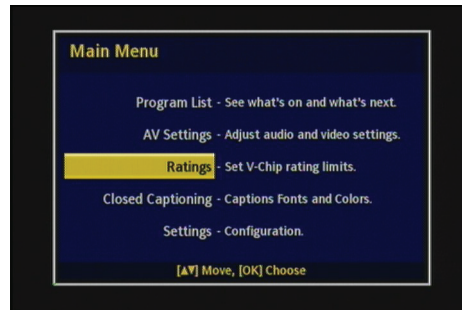

- 2 Press **▲** or **▼** to select **Ratings**, then press **OK**. The *Enter PIN* screen opens.

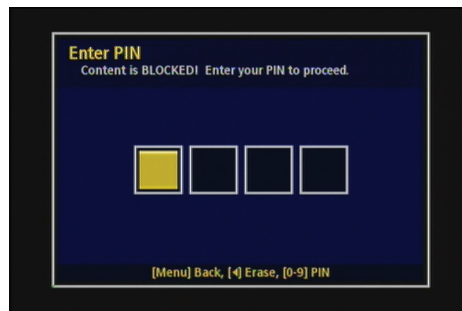

- 3 Using the number keys, enter your PIN number (the default number is **1234**), then press **OK**. The *Ratings* menu opens.

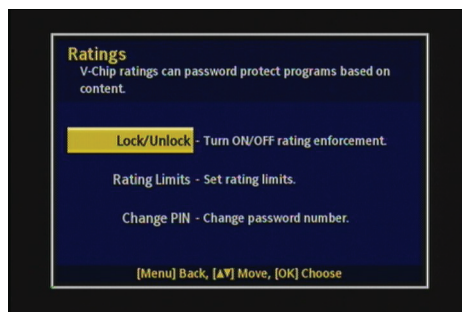

- 4 Press **▲** or **▼** to select **Lock/Unlock**, then press **OK**. The *Ratings Lock/Unlock* menu opens.

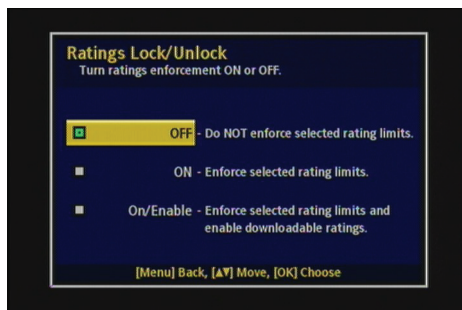

- 5 Press ▲ or ▼ to select one of the following:
  - **On**—To turn on Parental Controls.
  - **Off**—To turn off Parental Controls.
  - **On/Enable**—To enforce selected rating limits and enable downloadable ratings.
- 6 Press **MENU** to exit the on-screen menu.

### Setting the Parental Control rating limits

If you turn on the Parental Control lock, you need to set the Parental Control rating limits. The rating you select will be locked and all of the age-based ratings within that particular group will also be locked. For example, if you lock the TV-PG rating and all of its contents (V, S, L, and D), the more restrictive ratings (TV-14, and TV-MA) and all of their contents (V, S, L, and D) are also locked.

#### To set the Parental Control rating limits:

- 1 Press **MENU** on the remote control. The *Main Menu* opens.

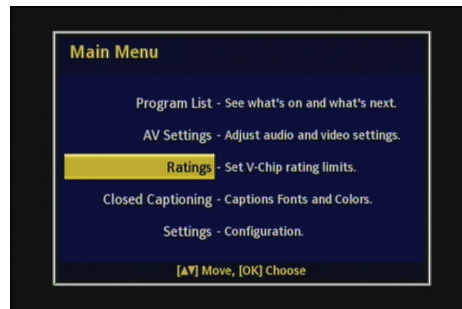

- 2 Press ▲ or ▼ to select **Ratings**, then press **OK**. The *Enter PIN* screen opens.

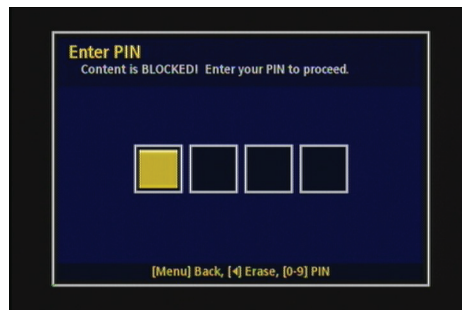

- 3 Using the number keys, enter your PIN number (the default number is **1234**), then press **OK**. The *Ratings* menu opens.

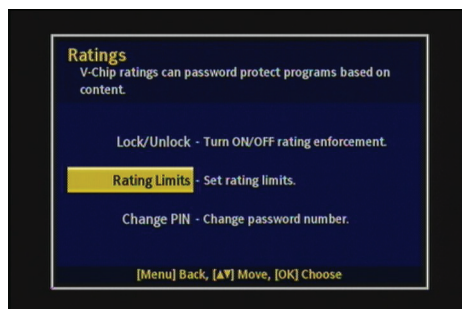

- 4 Press **▲** or **▼** to select **Rating Limits**, then press **OK**. The *Rating Limits* menu opens.

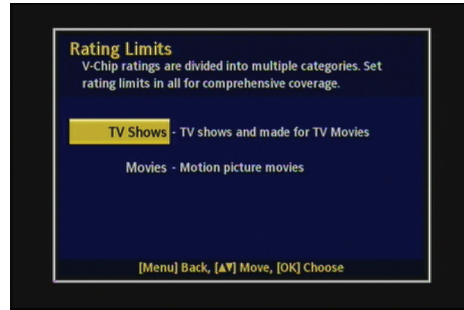

- 5 Press **▲** or **▼** to select **TV Shows** or **Movies**, then press **OK**. The selected menu opens.  
 a. If you selected **TV Shows**, the *TV Rating Limits* menu opens.

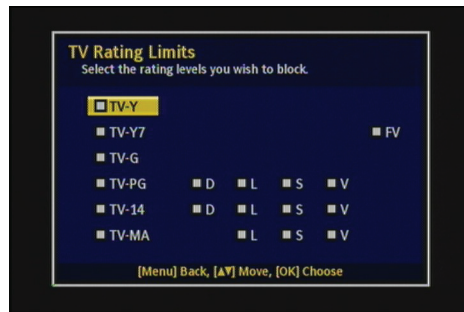

- Press **▲** or **▼** to select the TV rating you want, then press **OK**.

The TV Ratings (FCC) based on age are as follows:

Rating	Criteria
<b>TV-Y</b>	Suitable for all children. The themes and elements in this program are specifically designed for a very young audience, including children from ages two to six.
<b>TV-Y7</b>	Suitable for older children. Themes and elements may include mild physical or comedic violence, or may frighten children under the age of seven.
<b>TV-G</b>	General audience. The program contains little or no violence, no strong language, and little or no sexual dialogue or situations.
<b>TV-PG</b>	Parental guidance suggested. The program may contain infrequent coarse language, limited violence, and some suggestive sexual dialogue or situations.
<b>TV-14</b>	Parents strongly cautioned. May contain sophisticated themes, sexual content, strong language, and more intense violence.
<b>TV-MA</b>	Mature audiences only. May contain mature themes, profane language, graphic violence, and sexually explicit material.

The TV Ratings (FCC) Content Category are as follows:

Rating	Contains
<b>V</b>	Violence
<b>L</b>	Offensive language
<b>FV</b>	Fantasy or cartoon violence
<b>S</b>	Sexual content
<b>D</b>	Dialogue or sexual innuendo

-OR-

b. If you selected **Movies**, the *Movie Rating Limits* menu opens.

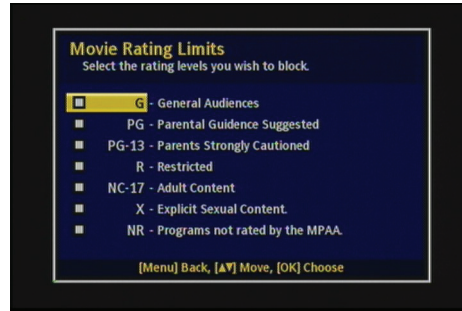

• Press ▲ or ▼ to select the Movie rating you want, then press **OK**.

The Movie Rating System (MPAA) is as follows:

Rating	Criteria
<b>G</b>	General audience. No restriction.
<b>PG</b>	Children under 13 years old should be accompanied by an adult.
<b>PG-13</b>	Parental guidance suggested. Children under 13 years old should be accompanied by an adult.
<b>R</b>	Restricted. Viewers should be 17 years old or older.
<b>NC-17</b>	Not classified. Viewers should be 17 years old or older.
<b>X</b>	Adults only.
<b>NR</b>	Not rated.

6 Press **MENU** to exit the on-screen menu.

## Changing your password

**To change your password:**

1 Press **MENU** on the remote control. The *Main Menu* opens.

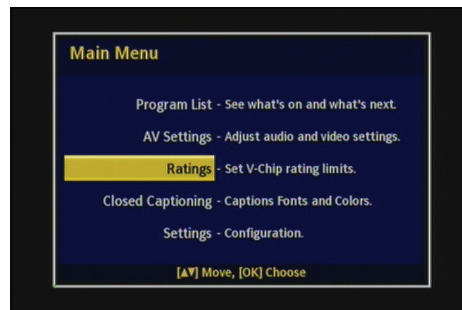

2 Press ▲ or ▼ to select **Ratings**, then press **OK**. The *Enter PIN* screen opens.

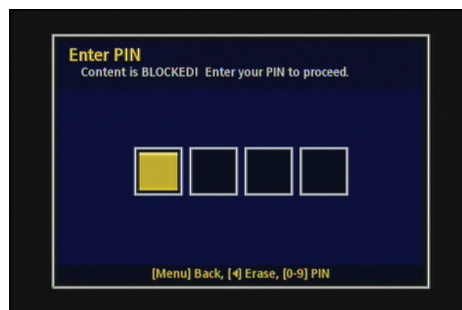

- Using the number keys, enter your PIN number (the default number is **1234**), then press **OK**. The *Ratings* menu opens.

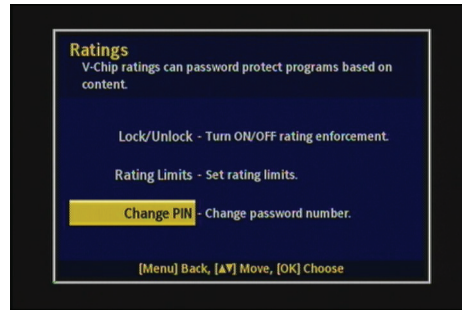

- Press **▲** or **▼** to select **Change PIN**, then press **OK**. The *Enter PIN* screen opens again.

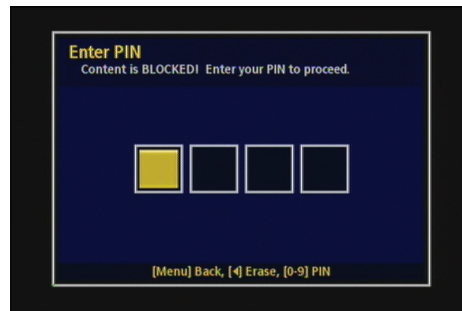

- Press the number keys to enter a new PIN. When the *Confirm New PIN* screen is displayed, enter the new PIN again.

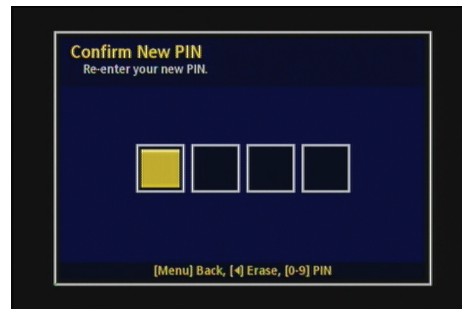

- Press **OK** to confirm and exit.

**Note**

If you forget your password, you can reset it to **1234** by selecting **System Reset** in the *Settings* menu. This will reset the device to its factory default settings and a new channel scan must be performed.

## Changing the Closed Captioning settings

### To change the Closed Captioning settings:

- 1 Press **MENU** on the remote control. The *Main Menu* opens.

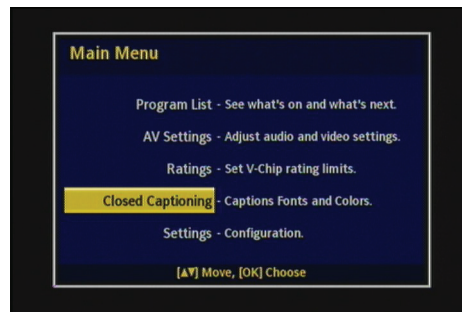

- 2 Press **▲** or **▼** to select **Closed Captioning**, then press **OK**. The *Closed Captioning* menu opens.

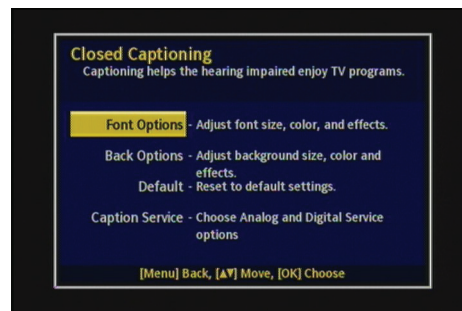

- 3 Press **▲** or **▼** to select the Captions setting you want to change, then press **OK** to go to that menu. You can select:
  - **Font Options - 1**—To choose the typeface, size, style, color, and effects.
  - **Back Options - 2**—To choose the background edge, type, color, and effects.
  - **Default - 3**—To reset the closed caption options to default.
  - **Caption Service - 4**—To choose the digital and analog caption service.
- 4 Press **▲** or **▼** to select the setting you want, then press **OK**.
- 5 Press **MENU** to exit the on-screen menu.

## Changing the general settings

### To change the general settings:

- 1 Press **MENU** on the remote control. The *Main Menu* opens.

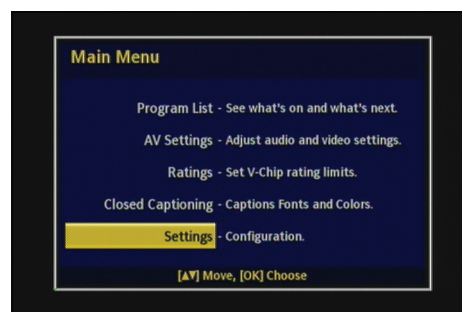

2 Press ▲ or ▼ to select **General Settings**, then press **OK**. The *Settings* menu opens.

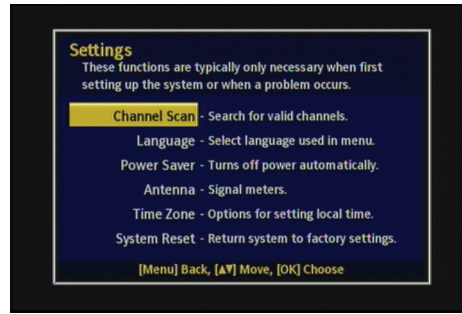

3 Press ▲ or ▼ to select the setting you want to change, then press **OK** to go to that menu. You can select:

- **Channel Scan**—To scan for available channels.
- **Language**—To choose the on-screen menu language.
- **Power Saver**—To set the sleep timer to turn off your TV after a specified period of time. The options are **4hr**, **8hr**, or **Program** (to turn off your TV when the current program is done), or **Off**. If no remote control button is press during the specified time period, you TV will turn off automatically. To cancel the sleep timer, select **Off**.
- **Antenna**—To open the signal meter to help adjust your antenna.
- **Time Zone**—To set your time zone and time.
- **System Reset**—To reset the converter box to factory default settings. Enter your password or the default password "1234."

4 Press ▲ or ▼ to select the setting you want, then press **OK**.

5 Press **MENU** to exit the on-screen menu.

## Troubleshooting

Insignia has detailed information about troubleshooting problems on its Web site at:  
[www.insignia-products.com/t-frequently\\_asked\\_questions.aspx](http://www.insignia-products.com/t-frequently_asked_questions.aspx)

Problem	Solution
The receiver power indicator (red LED) doesn't light up, and no message is displayed.	<ul style="list-style-type: none"> <li>• Make sure that the AC adapter is correctly inserted into a functioning power outlet and that the AC adapter cord is plugged into the back of the DTV converter box <b>DC IN</b> jack.</li> <li>• Press the ⏻ (power) button on the front panel to see if the red light (power indicator) is on.</li> </ul>
Poor picture quality.	<ul style="list-style-type: none"> <li>• Make sure that the antenna is pointing in the correct direction. Scan for available channels after moving the antenna. Press <b>MENU</b>, then select <b>General Settings</b>, then <b>Channel Scan</b>.</li> <li>• If you use a UHF/VHF amplifier to boost the signal level, check to verify that it is operating correctly.</li> </ul>
No audio.	<ul style="list-style-type: none"> <li>• Make sure that the TV's volume and the converter box's volume are properly set and not in "MUTE" mode.</li> <li>• Make sure that the audio cables are correctly connected.</li> <li>• Check with the local TV stations. Sometimes they are testing new services on their TV or radio channels.</li> <li>• Make sure that the AV setting on the converter box is set to <b>STEREO</b>, instead of <b>ALTERNATE AUDIO</b>. Some stations don't broadcast on the Alternate Audio channel. When in <b>Alternate Audio</b> mode, press <b>OK</b> to switch between the available languages, for example, English or Spanish audio selection.</li> </ul>
No video.	<ul style="list-style-type: none"> <li>• If using a coaxial cable between the TV and the converter box, make sure the TV is set to channel 3.</li> <li>• If using the AV cable, make sure the TV's input is selected to the correct Video input (AV, Video 1, etc.).</li> <li>• Make sure that the video cable between the TV and the converter box is correctly connected.</li> <li>• Scan for available channels. Press <b>MENU</b>, then select <b>General Settings</b>, then <b>Channel Scan</b>.</li> <li>• Check with the local TV stations. Sometimes they are testing new video services on their channels.</li> </ul>

Problem	Solution
Not all channels are available after performing an Auto Scan.	<ul style="list-style-type: none"> <li>Adjust your antenna and scan for available channels. Press <b>MENU</b>, then select <b>General Settings</b>, then <b>Channel Scan</b>.</li> </ul>
How do I find out what digital TV reception I get in my area?	<ul style="list-style-type: none"> <li>To determine which antenna you need for your area, visit <a href="http://www.antennaweb.org">www.antennaweb.org</a>. Type in your address and zip code to find an antenna that will continue giving you free local broadcast programming.</li> </ul>
No Closed Caption displayed.	<ul style="list-style-type: none"> <li>Make sure that the channel you are watching carries closed caption information.</li> <li>Press the <b>CC</b> button on the remote control to check for closed caption data output.</li> </ul>
Cannot use the converter box along with my cable box.	<ul style="list-style-type: none"> <li>The converter box works only with over-the-air broadcast television signals, not cable or any satellite service.</li> </ul>
I forgot my four digit parental control PIN.	<ul style="list-style-type: none"> <li>Press <b>Menu &gt; Settings &gt; System Reset</b> to reset the code to <b>1234</b>. Note that this will restore all settings back to their original factory settings and a new Channel Scan must be done.</li> </ul>

## Specifications

Design and specifications are subject to change without prior notice.

<b>RF Input</b>	
Demodulation	8VSB
Frequency Range	54 - 860 MHz
Connector Type	F-Type x 1
<b>RF Output</b>	
Signal Type	NTSC
Connector Type	F-Type x 1
<b>Video Output</b>	
Signal Type	NTSC
Impedance	75 Ohms
Output Level	1Vp-p
Connector	RCA x 1
<b>Audio Output</b>	
Output	Left and Right channel
Impedance	600 Ohms (min.)
Output Level	2Vrms±10%@0dBFS
Connector	RCA x 2
<b>Front Panel</b>	
	IR Receiver
	3 Key Function Control
	Status LED (power and standby)
<b>Remote Control</b>	
	27 keys
<b>Power Consumption (Product)</b>	
Operation	120VAC, 60Hz, 8W (max.)
Standby	<0.8W
<b>AC Adapter Specification</b>	
Input	100~240VAC, 50~60Hz
Output	5VDC/2.0A/10W
<b>Dimension (W x D x H)</b>	
	6.9 x 5.3 x 1.3 in. (175 x 135 x 33 mm)
<b>Weight</b>	
	8.8 oz. (250 g)



## Legal notices

### FCC Statement

This device complies with Part 15 of the FCC Rules. Operation is subject to the following two conditions: (1) this device may not cause harmful interference, and (2) this device must accept any interference received, including interference that may cause undesired operation.

This equipment has been tested and found to comply with the limits for a Class B digital device, pursuant to Part 15 of the FCC Rules. These limits are designed to provide reasonable protection against harmful interference in a residential installation. This equipment generates, uses and can radiate radio frequency energy and, if not installed and used in accordance with the instructions, may cause harmful interference to radio communications. However, there is no guarantee that interference will not occur in a particular installation. If this equipment does cause harmful interference to radio or television reception, which can be determined by turning the equipment off and on, the user is encouraged to try to correct the interference by one or more of the following measures:

- Reorient or relocate the receiving antenna.
- Increase the separation between the equipment and receiver.
- Connect the equipment into an outlet on a circuit different from that to which the receiver is connected.
- Consult the dealer or an experienced radio/TV technician for help.

**Warning:** Changes or modifications not expressly approved by the party responsible for compliance could void the user's authority to operate the equipment.

### Open Source Software Notice

This product includes the following:

zlib: Copyright © 1995-2005 Jean-loup Gailly and Mark Adler

THE SOFTWARE IS PROVIDED "AS IS" WITHOUT WARRANTY OF ANY KIND, EXPRESS OR IMPLIED, INCLUDING BUT NOT LIMITED TO THE WARRANTIES OF MERCHANTABILITY, FITNESS FOR A PARTICULAR PURPOSE AND NONINFRINGEMENT OF THIRD PARTY RIGHTS. IN NO EVENT SHALL THE AUTHORS OR COPYRIGHT HOLDERS BE LIABLE FOR ANY CLAIM, DAMAGES OR OTHER LIABILITY, WHETHER IN AN ACTION OF CONTRACT, TORT, OR OTHERWISE, ARISING FROM, OUT OF OR IN CONNECTION WITH THE SOFTWARE OR THE USE OR OTHER DEALINGS IN THE SOFTWARE.

### Dolby License Notice and Trademark Acknowledgement



Manufactured under license from Dolby Laboratories. Dolby and the double-D symbol are trademarks of Dolby Laboratories.

## 90-day limited warranty - Insignia

### Definitions:

Insignia Products ("Insignia") warrants to you, the original purchaser of this new Insignia-branded product ("Product"), that the Product shall be free of defects in the original manufacturer of the material or workmanship for a period of ninety (90) days from the date of your purchase of the Product ("Warranty Period"). For this warranty to apply, your Product must be purchased in the United States or Canada from a Best Buy or Future Shop authorized dealer of Insignia brand products only that are packaged with this warranty statement.

### How long does the coverage last?

The Warranty Period lasts for ninety (90) days from the date you purchased the Product. Your purchase date is printed on the receipt you received with the Product.

### What does this warranty cover?

During the Warranty Period, if the original manufacture of the material or workmanship of the Product is determined to be defective by an authorized Insignia repair center or store personnel, Insignia will (at its sole option): (1) repair the Product with new or rebuilt parts; or (2) replace the Product at no charge with new or rebuilt comparable products or parts. Products and parts replaced under this warranty become the property of Insignia and are not returned to you. If service of Products or parts are required after the Warranty Period expires, you must pay all labor and parts charges. This warranty lasts as long as you own your Insignia Product during the Warranty Period. Warranty coverage terminates if you sell or otherwise transfer the Product.

### How to obtain warranty service?

If you purchased the Product at a Best Buy or Future Shop retail store location, please take your original receipt and the Product to any Best Buy or Future Shop store. Make sure that you place the Product in its original packaging or packaging that provides the same amount of protection as the original packaging. If you purchased the Product from a Best Buy or Future Shop online web site, mail your original receipt and the Product to the address listed on the web site. Make sure that you put the Product in its original packaging or packaging that provides the same amount of protection as the original packaging.

To obtain warranty service, in the United States call 1-888-BESTBUY, Canada call 1-866-BESTBUY for Future Shop call 1-800-663-2275. Call agents may diagnose and correct the issue over the phone.

### Where is the warranty valid?

This warranty is valid only in the United States and Canada at Best Buy or Future Shop branded retail stores or websites to the original purchaser of the product in the county where the original purchase was made.

### What does the warranty not cover?

This warranty does not cover:

- Customer instruction/education
- Installation
- Set up adjustments
- Cosmetic damage
- Damage due to acts of God, such as power surges
- Accident(s)
- Misuse
- Abuse
- Negligence
- Commercial purposes/use, including but not limited to use in a place of business or in communal areas of a multiple dwelling condominium or apartment complex, or otherwise used in a place of other than a private home.
- Modification of any part of the Product, including the antenna
- Display panel damaged by static (non-moving) images applied for lengthy periods (burn-in).
- Damage due to incorrect operation or maintenance
- Connection to an incorrect voltage or power supply
- Attempted repair by any person not authorized by Insignia to service the Product
- Products sold "as is" or "with all faults"
- Consumables, including but not limited to batteries (i.e. AA, AAA, C etc.)
- Products where the factory applied serial number has been altered or removed
- Loss or Theft of this product or any part of the product
- Up to three (3) pixel failures (dots that are dark or incorrectly illuminated) grouped in an area smaller than one tenth (1/10) of the display size or up to five (5) pixel failures throughout the display. (Pixel based displays may contain a limited number of pixels that may not function normally.)
- Failures or Damage caused by any contact including but not limited to liquids, gels or pastes.

REPAIR REPLACEMENT AS PROVIDED UNDER THIS WARRANTY IS YOUR EXCLUSIVE REMEDY FOR BREACH OF WARRANTY. INSIGNIA SHALL NOT BE LIABLE FOR ANY INCIDENTAL OR CONSEQUENTIAL DAMAGES FOR THE BREACH OF ANY EXPRESS OR IMPLIED WARRANTY ON THIS PRODUCT, INCLUDING, BUT NOT LIMITED TO, LOST DATA, LOSS OF USE OF YOUR PRODUCT, LOST BUSINESS OR LOST PROFITS. INSIGNIA PRODUCTS MAKES NO OTHER EXPRESS WARRANTIES WITH RESPECT TO THE PRODUCT, ALL EXPRESS AND IMPLIED WARRANTIES FOR THE PRODUCT, INCLUDING, BUT NOT LIMITED TO, ANY IMPLIED WARRANTIES OF AND CONDITIONS OF MERCHANTABILITY AND FITNESS FOR A PARTICULAR PURPOSE, ARE LIMITED IN DURATION TO THE WARRANTY PERIOD SET FORTH ABOVE AND NO WARRANTIES, WHETHER EXPRESS OR IMPLIED, WILL APPLY AFTER THE WARRANTY PERIOD. SOME STATES, PROVINCES AND JURISDICTIONS DO NOT ALLOW LIMITATIONS ON HOW LONG AN IMPLIED WARRANTY LASTS, SO THE ABOVE LIMITATION MAY NOT APPLY TO YOU. THIS WARRANTY GIVES YOU SPECIFIC LEGAL RIGHTS, AND YOU MAY ALSO HAVE OTHER RIGHTS, WHICH VARY FROM STATE TO STATE OR PROVINCE TO PROVINCE.

Contact Insignia:

For customer service please call 1-877-467-4289 (U.S. and Canada) or 01-800-926-3000 (Mexico)

[www.insigniaproducts.com](http://www.insigniaproducts.com)

Distributed by Best Buy Purchasing, LLC

7601 Penn Avenue South, Richfield, Minnesota, U.S.A. 55423-3645

© 2013 BBY Solutions, Inc.

All rights reserved. INSIGNIA is a trademark of BBY Solutions, Inc. Registered in some countries. All other products and brand names are trademarks of their respective owners.



INSIGNIA is a registered trademark of BBY Solutions, Inc.

Registered in some countries.

Distributed by Best Buy Purchasing, LLC, 7601 Penn Ave South, Richfield, MN 55423 U.S.A.

©2013 BBY Solutions, Inc.

All Rights Reserved

For customer support, call 1-877-467-4289 (U.S. and Canada) or 01-800-926-3000 (Mexico)

## Free Manuals Download Website

<http://myh66.com>

<http://usermanuals.us>

<http://www.somanuals.com>

<http://www.4manuals.cc>

<http://www.manual-lib.com>

<http://www.404manual.com>

<http://www.luxmanual.com>

<http://aubethermostatmanual.com>

Golf course search by state

<http://golfingnear.com>

Email search by domain

<http://emailbydomain.com>

Auto manuals search

<http://auto.somanuals.com>

TV manuals search

<http://tv.somanuals.com>