

User Guide

32" LED TV

INSIGNIA™

NS-32D510NA15

Before using your new product, please read these instructions to prevent any damage.



Contents

CHILD SAFETY	1
Important Safety Instructions	2
WARNING	2
CAUTION	3
Introduction	4
MHL™	4
Roku Ready®	4
INlink	4
DTS Sound™	4
Game mode	4
Install the stand or wall-mount bracket	5
Install the stand	5
Install a wall-mount bracket.....	7
TV components	8
Package contents	8
Front	8
Right side buttons	8
Left side jacks	9
Back	10
Remote control	11
What connection should I use?	12
Connect a cable or satellite box	13
HDMI (best)	13
DVI (same as HDMI but requires an audio connection)	14
Component video (better)	15
AV (composite video) (good).....	16
Coaxial (good).....	17
Connect an antenna or cable TV (no box)	18
Connect a DVD or Blu-ray player	19
HDMI (best)	19
Component video (better)	20
AV (composite video) (good).....	21
Connect a Roku Streaming Stick	22
Connect an MHL-enabled device	23
Connect a game console	24
HDMI (best)	24
Component video (better)	25
AV (composite video) (good).....	26

- Connect a computer 27
 - HDMI (best) 27
 - DVI (same as HDMI but requires an audio connection) 28
 - VGA (good)..... 29
- Connect a USB flash drive 30
- Connect headphones 31
- Connect external speakers or a sound bar 32
 - Digital audio 32
 - Analog audio..... 33
- Connect a home theater system with multiple devices 34
- Connect power 35
- Use the remote control 36
 - Install remote control batteries 36
 - Aim the remote control 36
- Turn on your TV for the first time 37
- Understand the basics 39
 - Turn your TV on or off 39
 - Select the video input source 39
 - On-screen menu overview 40
 - Navigate the menus 40
 - Select a channel 41
 - Adjust the volume 41
 - View channel information 41
- Use a Roku Streaming Stick 42
 - Connect and use 42
 - Switch back to the Roku Streaming Stick 42
- Use an MHL-enabled device 43
 - Connect and use 43
 - Switch back to a connected device 43
- Use INlink 44
 - Turn INlink on or off 44
 - Turn Device Auto Power Off on or off 44
 - Turn TV Auto Power On on or off 45
 - Turn Audio Receiver on or off 45
 - Display a list of INlink-compatible devices 46
 - Select an INlink-compatible device 46
 - Open an INlink-compatible device’s root menu 47
- Use a USB flash drive 47
 - Switch to USB mode 47
 - Browse photos 48
 - View favorite photos 49
 - View photos in a slideshow 49
 - Customize slideshow settings 50

Adjust the picture	50
Adjust the TV picture	50
Automatically adjust the aspect ratio	52
Set the power on picture mode	52
Adjust the computer image	53
Adjust the sound	53
Adjust sound settings	53
Select the audio out mode	54
Play TV audio only	55
Change channel settings	55
Automatically scan for channels	55
Hide channels	57
Set up a favorite channel list	57
View a favorite channel	57
Add or change a channel label	58
Check the digital signal strength	58
Set parental controls	59
Set or change the password	59
Lock control buttons	60
Block unrated TV	60
Set parental control levels	61
Download rating information	62
Use closed captioning	63
Turn closed captioning on or off	63
Select the analog closed captioning mode	64
Select the digital closed captioning mode	64
Customize digital closed captioning settings	65
Adjust time settings	66
Set the clock	66
Set the sleep timer	67
Adjust menu settings	67
Select the menu language	67
Label an input source	68
Turn Input Sensor on or off	68
Maintenance	68
Clean the TV cabinet	68
Clean the TV screen	68
Troubleshoot	69
Restore settings to the defaults	69
View system information	69
Update the TV firmware	70
Video and audio	71
Remote control	73
General	74
Roku Streaming Stick	75
MHL-enabled device	75

INlink (CEC-compatible) device	77
Specifications	79
Program universal remote controls	80
Common universal remote control codes	80
Legal notices	81
One-year limited warranty - Insignia Televisions	82

CHILD SAFETY

It makes a difference how and where you use your flat panel display

As you enjoy your new product, keep these safety tips in mind

The issue

The home theater entertainment experience is a growing trend, and larger TVs are popular purchases. However, TVs are not always supported on the proper stands or installed according to the manufacturer's recommendations. We and the consumer electronics industry are committed to making home entertainment enjoyable and safe.

TVs that are inappropriately placed on dressers, bookcases, shelves, desks, speakers, chests, or carts may fall over and cause injury.

Tune into safety

- One size of TV stand does **not** fit all. Use only a TV stand rated for the weight of your TV.
- Carefully read and understand all enclosed instructions for proper use of this product.
- Don't let children climb on or play with entertainment system furniture and TVs.
- Don't place TVs on furniture that can easily be used as steps, such as a crate or chest of drawers.
- Remember that children can become excited while watching a program, especially on a "larger-than-life" TV. Make sure that you place or install the TV where it cannot be pushed, pulled over, or knocked down.
- Make sure that you route all cords and cables so that they cannot be pulled or grabbed by curious children.



Wall mounting

If you decide to wall mount your TV, always remember:

- One size of wall mount does **not** fit all. Use only a wall mount rated for the weight of your TV and that has been recommended by this TV manufacturer, listed in this manual, or otherwise listed by an independent laboratory as suitable for your TV.
- Follow all instructions supplied by the TV and wall mount manufacturers.
- If you have any doubts about your ability to safely wall mount your TV, get help from a professional installer.
- Make sure that the wall where you are mounting the TV is appropriate. Some wall mounts are not designed to be mounted to walls backed with steel studs or cinder blocks. If you are unsure, ask a professional installer.
- TVs can be heavy. At least two people are required for safe wall mount installation.



Important Safety Instructions



This symbol indicates that dangerous voltage constituting a risk of electric shock is present within your TV. This label is located on the back of your TV.



This symbol indicates that there are important operating and maintenance instructions in the literature accompanying your TV.

- 1 Read these instructions.
- 2 Keep these instructions.
- 3 Heed all warnings.
- 4 Follow all instructions.
- 5 Do not use this apparatus near water.
- 6 Clean only with dry cloth.
- 7 Do not block any ventilation openings. Install in accordance with the manufacturer's instructions.
- 8 Do not install near any heat sources such as radiators, heat registers, stoves, or other apparatus (including amplifiers) that produce heat.
- 9 Do not defeat the safety purpose of the polarized or grounding-type plug. A polarized plug has two blades with one wider than the other. A grounding type plug has two blades and a third grounding prong. The wide blade or the third prong are provided for your safety. If the provided plug does not fit into your outlet, consult an electrician for replacement of the obsolete outlet.
- 10 Protect the power cord from being walked on or pinched particularly at plugs, convenience receptacles, and the point where they exit from the apparatus.
- 11 Only use attachments/accessories specified by the manufacturer.
- 12 Use only with the cart, stand, tripod, bracket, or table specified by the manufacturer, or sold with the apparatus. When a cart is used, use caution when moving the cart/apparatus combination to avoid injury from tip-over.
- 13 Unplug this apparatus during lightning storms or when unused for long periods of time.



S3125A

- 14 Refer all servicing to qualified service personnel. Servicing is required when the apparatus has been damaged in any way, such as power-supply cord or plug is damaged, liquid has been spilled or objects have fallen into the apparatus, the apparatus has been exposed to rain or moisture, does not operate normally, or has been dropped.
- 15 The *wall plug* is the disconnecting device. The plug must remain readily operable.
- 16 Remote control batteries should not be exposed to excessive heat such as sunshine, fire, or the like.
- 17 The apparatus should not be exposed to dripping or splashing, and no objects filled with liquids, such as vases, should be placed on the apparatus.

WARNING

Electric shock hazard

To reduce the risk of fire or electric shock, do not remove any cover or expose the device to rain or moisture. No user-serviceable parts are inside. Refer servicing to qualified service technicians.

Lightning

For added protection for your device receiver during a lightning storm, or when it is left unattended and unused for long periods of time, unplug it from the power outlet and disconnect any antenna or cable system. This helps prevent property damage and personal injury from lightning and power line surges.

Power lines

An outside antenna system should not be located in the vicinity of overhead power lines or other electric light or power circuits, or where it can fall into such power lines or circuits. When installing an outside antenna system, take extreme care to keep from touching such power lines or circuits as contact with them might be fatal.

Handling the LCD panel

- Your TV's screen is made of glass. Do not drop your TV or hit, jolt, or press hard against the LCD panel. If the screen breaks, be careful of broken glass.
- If the LCD panel is broken, make absolutely sure that you do not touch the liquid in the panel. This may cause skin inflammation.
- If the liquid gets in your mouth, immediately gargle, rinse, and consult with your doctor. Also, if the liquid gets in your eyes or touches your skin, consult with your doctor after rinsing for at least 15 minutes or longer in clean water.

Replacement parts

When replacement parts are required, make sure that the service technician uses replacement parts specified by the manufacturer that have the same characteristics as the original part. Unauthorized substitutions may result in fire, electric shock, personal injury, or other hazards.

Safety check

After completing any service or repair to this device, ask the service technician to perform routine safety checks to determine that your TV is in correct operating condition.

Power source

Operate your TV only from the type of power source indicated on the marking label. If you are not sure of the type of power supplied to your home, consult an electrician or your local power company.

Servicing

These servicing instructions are for use by qualified service personnel only. To reduce the risk of electric shock, do not perform any servicing other than that contained in the operating instructions unless you are qualified to do so.

CAUTION

Damage requiring service

Unplug this TV from the power outlet and refer servicing to qualified service personnel under the following conditions:

- When the power supply cord or plug is damaged or frayed.
- If liquid has been spilled or objects have fallen into your TV.
- If your TV has been exposed to rain or water.
- If your TV does not operate normally by following the operating instructions. Adjust only those controls covered by the operating instructions because incorrect adjustment of other controls may result in damage and will often require extensive work by a qualified technician to restore your TV to its normal operation.
- If your TV has been dropped or damaged in any way.
- When your TV exhibits a distinct change in performance.

Outdoor antenna grounding

If an outside antenna or cable system is connected to your TV, make sure that the antenna or cable system is grounded to provide some protection against voltage surges and built-up static charges. Article 810 of the National Electrical Code, ANSI/NFPA No. 70, provides information with respect to correct grounding of the mast and supporting structure, grounding of the lead-in wire to an antenna discharge unit, size of grounding conductors, location of the antenna-discharge unit, connection to grounding electrodes, and requirements for the grounding electrode.

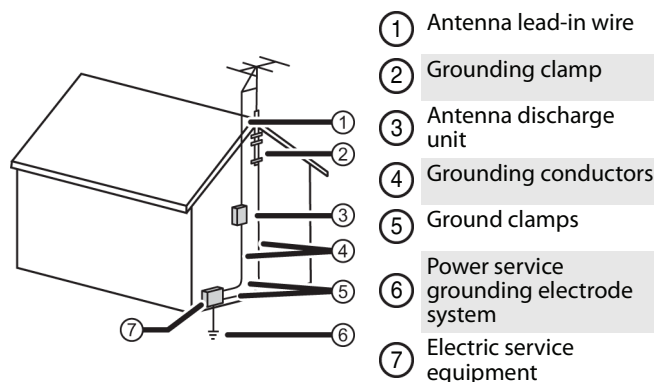

Note to CATV system installer

Article 820 of the National Electrical Code, ANSI/NFPA No. 40 provides guidance for correct grounding. Specifically, it states that the cable ground must be connected to the grounding system of the building as close to the point of cable entry as practical.

Condensation

Moisture will form on the TV if the TV is brought from cool surroundings into a warm room or if the temperature of the room rises suddenly. When this happens, the TV's performance may be impaired. To prevent this, let the TV stand in its new surroundings for about an hour before switching it on, or make sure that the room temperature rises gradually.

Condensation may also form during the summer if the TV is exposed to the breeze from an air conditioner. In such cases, change the location of the TV.

Mobile telephone warning

To avoid interference with your TV picture and sound, operating problems, or even damage, keep your cordless and cellular telephones away from the TV.

End of life directives

Your TV may contain materials that are regulated for environmental reasons. Your TV also contains materials that can be recycled and reused. To help protect the environment, contact your local authorities for information about disposal or recycling and about finding a recycler in your area before you dispose of your TV.

Non-active pixels

The LCD panel contains almost 3 million thin film transistors, which provide exceptionally sharp video quality. Occasionally, a few non-active pixels may appear on the screen as a fixed blue, green, or red point. These non-active pixels do not adversely affect the performance of your TV, and are not considered defects.

Insignia 32" LED TV

Introduction

Congratulations on your purchase of a high-quality Insignia product. Your NS-32D510NA15 represents the state of the art in LED TV design and is designed for reliable and trouble-free performance.

MHL™

Connect your MHL-enabled device, such as a cell phone or Roku Streaming Stick™, and view your device's screen on your TV. Supports 1080p HD video and 5.1 digital surround sound playback from your mobile device. (Requires an MHL-enabled phone or tablet and an MHL cable.) (See page 23 for connection instructions.)

Roku Ready®

Your Insignia TV is certified to work with the Roku Streaming Stick® (sold separately) to instantly stream 1000+ entertainment channels, including Netflix, M-GO, HBO GO, Hulu Plus, WatchESPN, Vudu, Amazon Instant Video, Pandora, PBS, and many more. Operate the Streaming Stick with your TV remote or a mobile device—it's that simple! Just plug the Streaming Stick into the purple MHL port on your TV and enjoy. Roku requires high-speed Internet and WiFi. (See page 22 for connection instructions.)

INlink

Enjoy the benefit of having HDMI CEC compatible products plug and play! No setup is needed! CEC technology lets different devices discover and communicate with each other. (See page 44 for instructions on how to use INlink.)

DTS Sound™

DTS Sound delivers clear, crisp, and natural sound while providing deep enveloping bass.

Game mode

Video games generally require adjustments to the television picture settings to get the maximum experience. By simply pressing a button on your remote control, your television settings will automatically adjust for video games. It couldn't be easier. (See the **Game** option in "Adjust the TV picture" on page 50 for instruction on how to select Game mode.)

Install the stand or wall-mount bracket

Notes

- If you plan to wall-mount your TV, do not install the stand.
- Store the stand and stand screws in case you decide to use the stand in the future.

Install the stand

- 1 Carefully place your TV face-down on a cushioned, clean surface to protect the screen from damages and scratches.

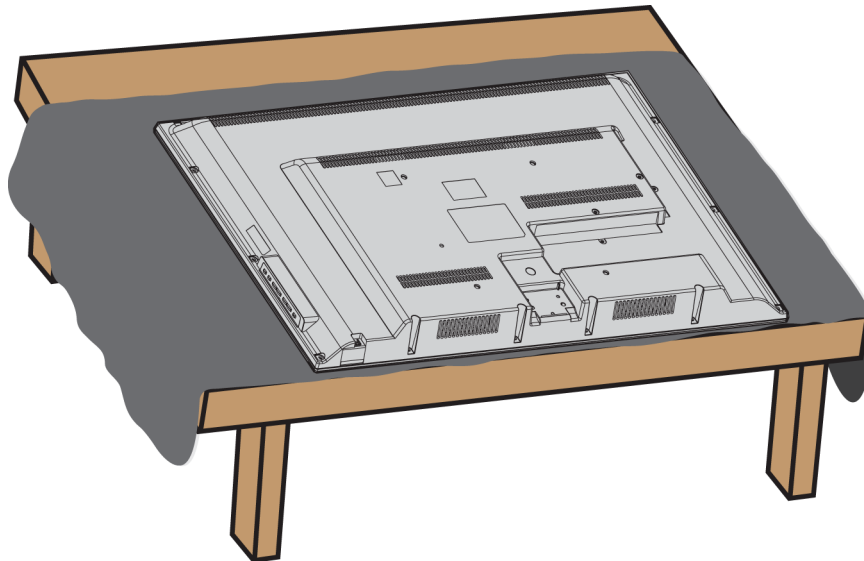

- 2 Align the stand column with the TV, then secure the stand column to the TV using the three provided T4 x 12 mm screws (the short screws).

Screw type	Screw length	# of screws
T4	12 mm	3

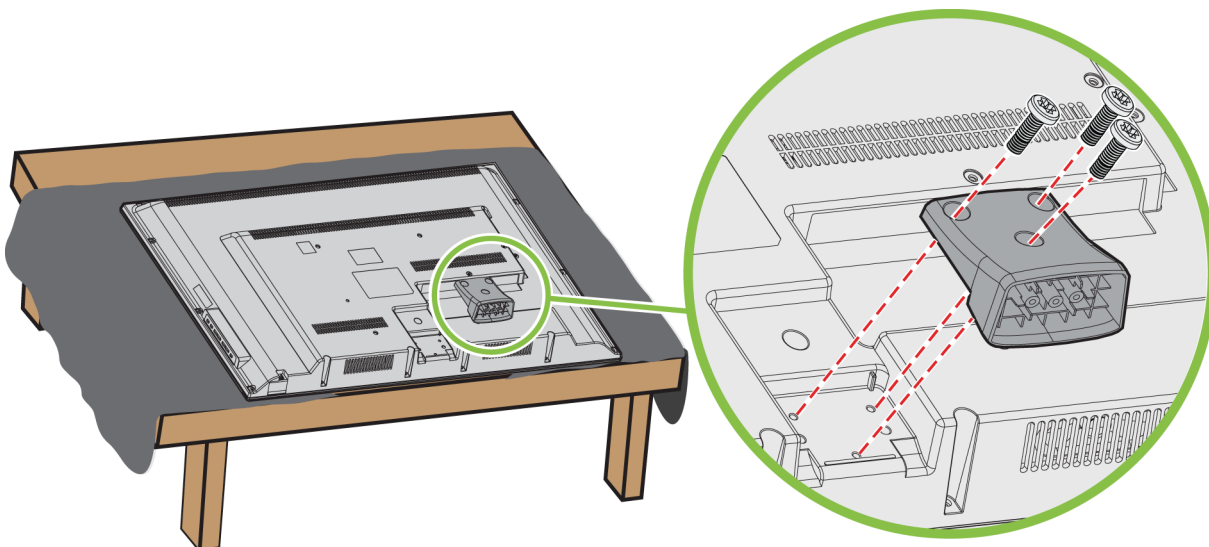

- 3 Align the TV stand with the stand column, then secure the TV stand to the stand column using the provided T4 × 14 mm screw (the long screw).

Screw type	Screw length	# of screws
T4	14 mm	1

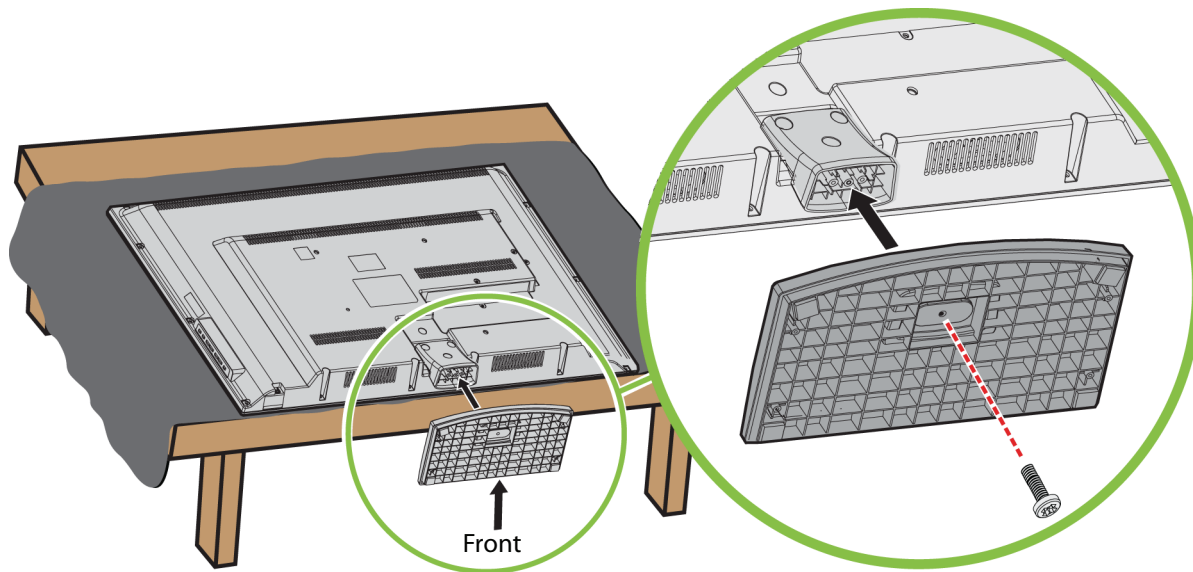

Install a wall-mount bracket

Warning

This TV is intended to be supported by a UL Listed wall mount bracket with suitable weight/load. (See "Miscellaneous" on page 79.)

- 1 Carefully place your TV face-down on a cushioned, clean surface to protect the screen from damages and scratches.
- 2 If the stand is attached, remove the three screws that secure the stand column to the TV, then remove the stand column.

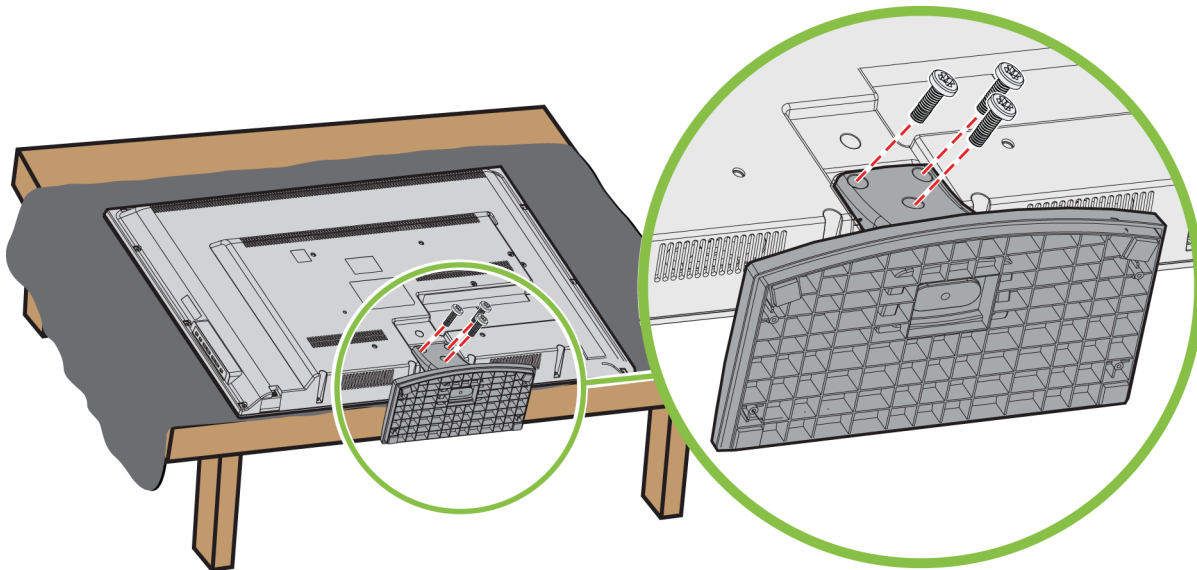

- 3 Attach the wall-mount bracket to your TV using the mounting holes on the back of your TV. See the instructions that came with the wall-mount bracket for information about how to correctly hang your TV.

Notes

- The length of the wall-mount screws vary depending on the wall-mount bracket you purchased. See the instructions that came with the wall-mount bracket for screw lengths.
- The mounting holes on the back of your TV take type M6 screws.

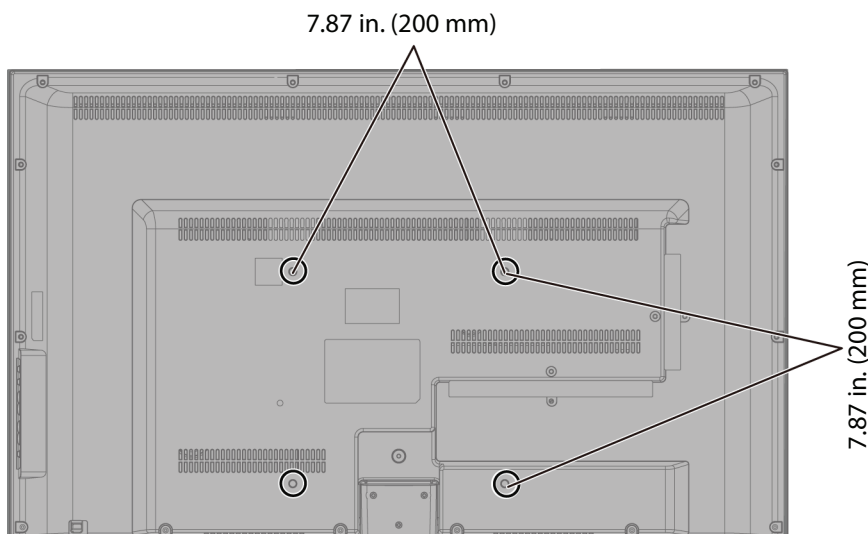

TV components

Package contents

- 32" LED TV
- Remote control and batteries (2 AAA)
- Stand column and screws (3)
- TV stand and screws (1)
- *Quick Setup Guide*
- *Important Information*

Front



#	Item	Description
1	Remote control sensor	Receives signals from the remote control. Do not block.
2	Power indicator	Turns off when your TV is on. Lights red when your TV is off (standby mode).

Right side buttons

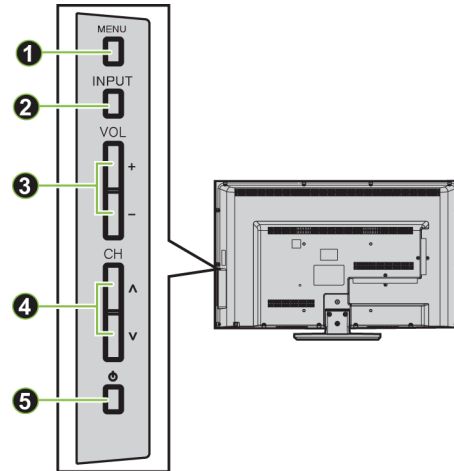

#	Item	Description
1	MENU	Press to open the on-screen menu. For more information, see "Navigate the menus" on page 40.
2	INPUT	Press one or more times to select the video input source you want, then wait a few seconds. Your TV switches to the source you selected. For more information, see "Select the video input source" on page 39. In menu mode, press to confirm selections.
3	VOL+/VOL-	Press to increase or decrease the volume.
4	CH ^/CH v	Press to go to the next or previous channel in the channel list. For more information, see "Select a channel" on page 41.
5	⏻ (power)	Press to turn your TV on or off (standby mode). Warning: When your TV is off, power still flows through it. To completely disconnect power, unplug the power cord.

Left side jacks

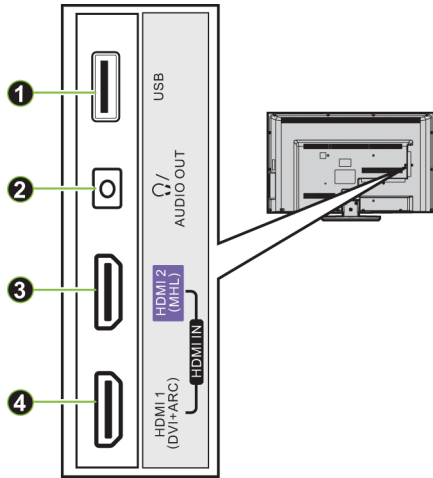

#	Item	Description
1	USB	Connect a USB flash drive to this jack to view compatible JPEG picture files. For more information, see "Connect a USB flash drive" on page 30 and "Use a USB flash drive" on page 47.
2	🎧/AUDIO OUT	Connect headphones, a sound bar, analog speaker system, or a home theater system to this jack to listen to TV audio through external speakers. For more information, see "Analog audio" on page 33.
3	HDMI 2 (MHL)	<p>Connect an HDMI device to this jack. For more information, see "HDMI (best)" on pages 13, 19, 24, or 27.</p> <p>OR</p> <p>Connect an MHL-enabled device, such as a cell phone or Roku Streaming Stick®, to this jack to view your device's screen on your TV. For more information about MHL, see "Connect an MHL-enabled device" on page 23 and "Use an MHL-enabled device" on page 43. For more information about Roku, see "Connect a Roku Streaming Stick" on page 22 and "Use a Roku Streaming Stick" on page 42.</p>
4	HDMI 1 (DVI+ARC)	<p>Connect an HDMI device to this jack. For more information, see "HDMI (best)" on pages 13, 19, 24, or 27.</p> <p>OR</p> <p>Connect the video for a DVI device to this jack. For more information, see "DVI (same as HDMI but requires an audio connection)" on pages 14 or 28.</p> <p>OR</p> <p>Connect an ARC-enabled home theater receiver to this jack.</p>

Back

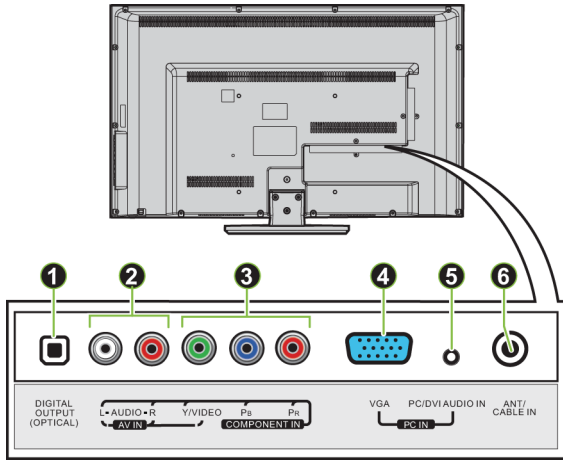

#	Item	Description
1	DIGITAL OUTPUT (OPTICAL)	Connect a sound bar, digital speaker system, or home theater system to this jack to listen to TV audio through external speakers. For more information, see "Digital audio" on page 32.
2	L and R AUDIO	<p>Connect the audio for a component video device to these jacks. For more information, see "Component video (better)" on page 15, 20, or 25.</p> <p>OR</p> <p>Connect the audio for an AV (composite video) device to these jacks. For more information, see "AV (composite video) (good)" on page 16, 21, or 26.</p> <p>The component video and AV (composite video) jacks are shared. You can connect only one component video or AV device at a time.</p>
3	Y/VIDEO, Pb, Pr OR Y/VIDEO	<p>Connect the video for a component video device to the Y/VIDEO, Pb, and Pr jacks. For more information, see "Component video (better)" on page 15, 20, or 25.</p> <p>OR</p> <p>Connect the video for an AV (composite video) device to the Y/VIDEO jack. For more information, see "AV (composite video) (good)" on page 16, 21, or 26.</p>
4	VGA	<p>Connect the video for a computer to this jack. For more information, see "VGA (good)" on page 29.</p> <p>Connect the audio for a computer to this jack. For more information see "VGA (good)" on page 29.</p>
5	PC/DVI AUDIO IN	<p>OR</p> <p>Connect the audio for a DVI device to this jack. For more information see, "DVI (same as HDMI but requires an audio connection)" on pages 14 or 28.</p>
6	ANT/CABLE IN	Connect an antenna or cable TV to this jack. For more information, see "Connect an antenna or cable TV (no box)" on page 18.

Remote control

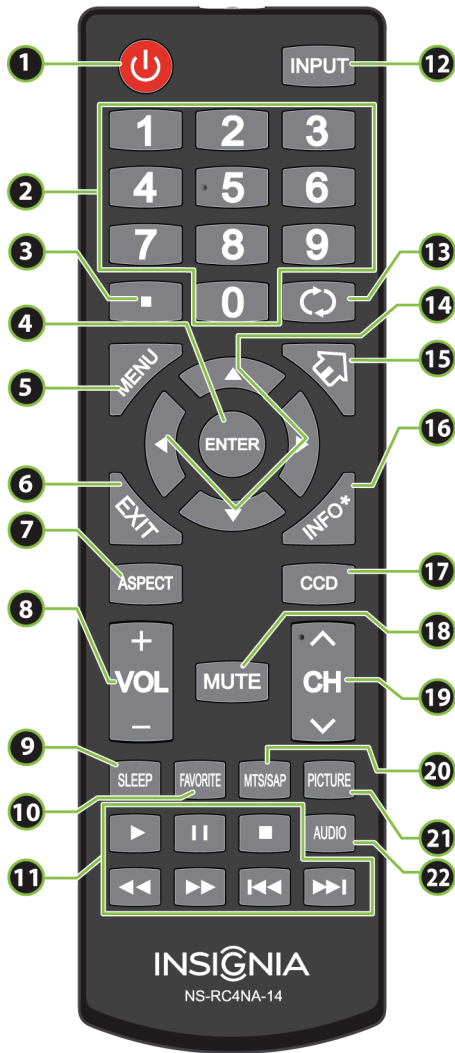

#	Button	Description
1	⏻ (power)	Press to turn your TV on or off (standby mode). Warning: When your TV is off, power still flows through it. To disconnect power, unplug the power cord.
2	Numbers	Press to enter channel numbers and the parental control password.
3	■	Press to enter a digital sub-channel number. See "Select a channel" on page 41.
4	ENTER	TV menus —Press to confirm selections or changes in on-screen TV menus. Roku —Press to confirm selections or changes on Roku screens.
5	MENU	Press to open the on-screen menu.
6	EXIT	TV —Press to close the on-screen TV menu. Roku —Press to close a Roku menu or video.
7	ASPECT	Press to change how the picture looks on the screen (aspect ratio). See the Aspect Ratio option in "Adjust the TV picture" on page 50.
8	VOL+/-	Press to increase or decrease the volume.
9	SLEEP	Press to set the sleep timer. You can select Off, 5, 10, 15, 30, 60, 90, 120, 180, or 240 minutes. See "Set the sleep timer" on page 67.

#	Button	Description
10	FAVORITE	Press to open the <i>Favorite</i> channel list. See "Set up a favorite channel list" on page 57 and "View a favorite channel" on page 57.
11	Media Controls	INlink —Press to control INlink-compatible (HDMI CEC) devices. See "Use INlink" on page 44. USB —Press to control a photo slideshow. See "View photos in a slideshow" on page 49. Roku —Press to control a movie or show that is streaming through a connected Roku Streaming Stick. See "Use a Roku Streaming Stick" on page 42.
12	INPUT	Press to open the <i>INPUT SOURCE</i> list, press ▲ or ▼ on the remote control to select the video input source, then press ENTER . See "Select the video input source" on page 39.
13	↶ (return)	TV —Press to return to the previous channel. Roku —Press to replay the last 10 seconds of video.
14	▲ ▼ ◀ ▶	TV menus —Press to navigate in on-screen TV menus and to adjust settings. Roku —Press to navigate in Roku screens.
15	🏠 (home)	MHL —Press to open a connected MHL device's home menu. Roku —Press return to a connected Roku Streaming Stick's home screen.
16	INFO*	TV —Press to display TV status information, such as the channel number, channel name (if available), or signal source. See "View channel information" on page 41. Roku —Press to access special Roku options when a Roku Streaming Stick is plugged in.
17	CCD	Press to turn closed captioning on or off. You can select CC Off, CC On, or CC On when mute . See "Turn closed captioning on or off" on page 63.
18	MUTE	TV —Press to mute the sound. Press again to restore the sound. Roku —Press to mute the sound. Press again to restore the sound.
19	CH ▲/CH ▼	Press to change TV channels. See "Select a channel" on page 41.
20	MTS/SAP	Analog programs —Press to select the audio mode for an analog program. You can select: <ul style="list-style-type: none"> Mono—Select this option if there is noise or static on weak stereo broadcasts. Stereo—Select this option for programs broadcast in stereo. SAP—Select this option to listen to a secondary audio program, if available. Digital programs —Press to select the audio language for a digital program, if alternate languages are available.
21	PICTURE	Press to select the picture mode. You can select Vivid, Standard, Energy Savings, Movie, Game, or Custom . See the Picture Mode option in "Adjust the TV picture" on page 50.
22	AUDIO	Press to select the sound mode. You can select Standard, Theater, Music, News, or Custom . See the Sound Mode option in "Adjust sound settings" on page 53.

What connection should I use?

Your TV has several connection types for connecting devices to your TV. For the best video quality, you should connect a device to the best available connection. Use the following tables to identify cables:

Video quality	Connection type and jack	Cable connector
Best (use this if your devices have HDMI)	HDMI video/audio	
Better than composite or coaxial	Component video (requires an audio connection)	
Better than coaxial	AV (composite video) (requires an audio connection)	
Good	Coaxial video/audio	

Connection type and jack Cable connectors

Optical digital audio output

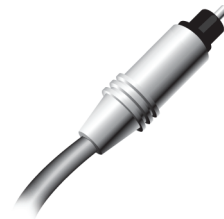

Analog audio input

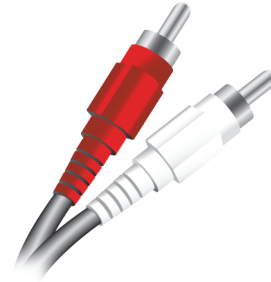

3.5mm analog audio output



VGA (computer) video and 3.5mm audio

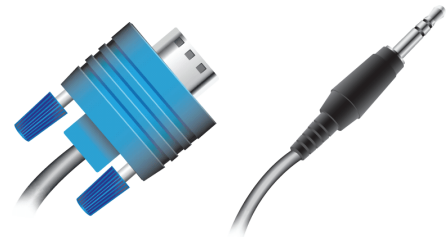

You can use the **HDMI 1 (DVI+ARC)** jack on your TV to connect a DVI device to your TV. For more information, see "DVI (same as HDMI but requires an audio connection)" on page 14 or 28.

Cautions

- Check the jacks for position and type before making any connections.
- Loose connections can result in image or color problems. Make sure that all connections are tight and secure.
- The external audio/video equipment shown may be different from your equipment. If you have questions, refer to the documentation that came with your equipment.
- Always unplug the power cord when connecting external equipment.

Connect a cable or satellite box

Many cable or satellite TV boxes have more than one connection type. To get the best video, you should use the best connection type available. For more information, see "What connection should I use?" on page 12.

HDMI (best)

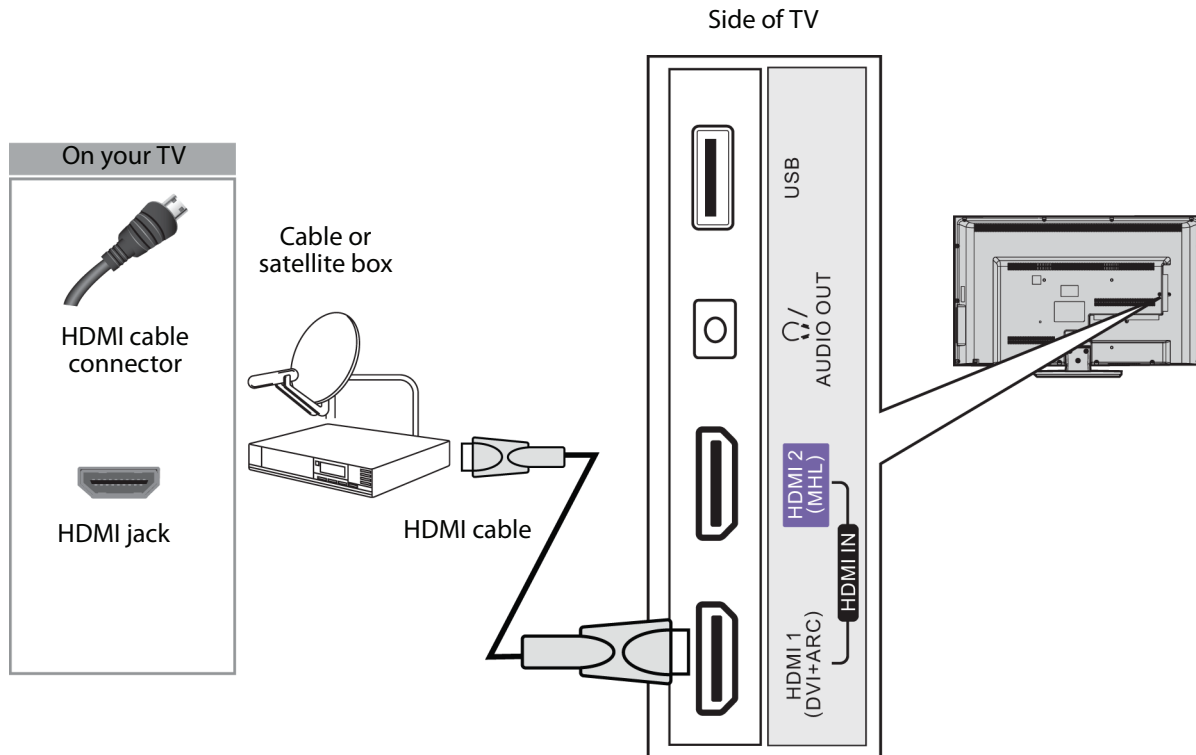

- 1 Make sure that your TV's power cord is unplugged and all connected equipment is turned off.
- 2 Connect the incoming cable from the cable wall jack to the cable-in jack on the cable or satellite box.
- 3 Connect an HDMI cable (not provided) to one of the **HDMI** jacks on the side of your TV and to the **HDMI OUT** jack on the cable or satellite box.
- 4 Plug your TV's power cord into a power outlet, turn on your TV, then turn on the cable or satellite box.
- 5 Press **INPUT** to open the *INPUT SOURCE* list.
- 6 Press **▲** or **▼** to highlight **HDMI 1** or **HDMI 2**, then press **ENTER**.

Note

An HDMI cable carries both audio and video. You do not need to use any audio cables.

DVI (same as HDMI but requires an audio connection)

Note

You must use the **HDMI 1 (DVI+ARC)** jack to connect a cable or satellite box using DVI. If you use another HDMI jack, you will not hear sound from the TV speakers.

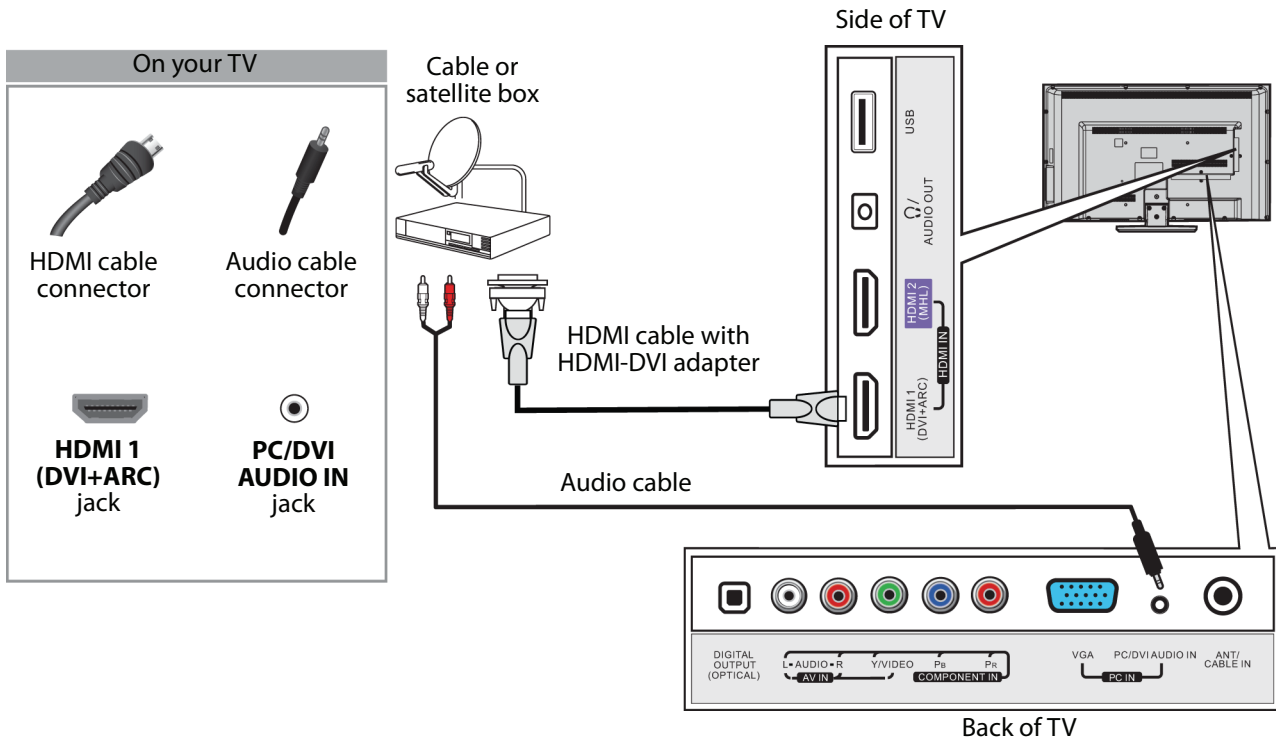

- 1 Make sure that your TV's power cord is unplugged and all connected equipment is turned off.
- 2 Connect the incoming cable from the cable wall jack to the cable-in jack on the cable or satellite box.
- 3 Connect an HDMI-DVI adapter (not provided) to one end of an HDMI cable (not provided), then connect the adapter to the **DVI OUT** jack on the cable or satellite box.
- 4 Connect the other end of the cable to the **HDMI 1 (DVI+ARC)** jack on the side of your TV.
- 5 Connect an audio cable (not provided) to the **PC/DVI AUDIO IN** jack on the back of your TV and to the **AUDIO OUT** jacks on the cable or satellite box.

Note

When you connect the audio using the **PC/DVI AUDIO IN** jack, the audio output is analog.

- 6 Plug your TV's power cord into a power outlet, turn on your TV, then turn on the cable or satellite box.
- 7 Press **INPUT** to open the **INPUT SOURCE** list.
- 8 Press **▲** or **▼** to highlight **HDMI 1**, then press **ENTER**.

Component video (better)

Note
Cables are often color-coded to match color-coded jacks.

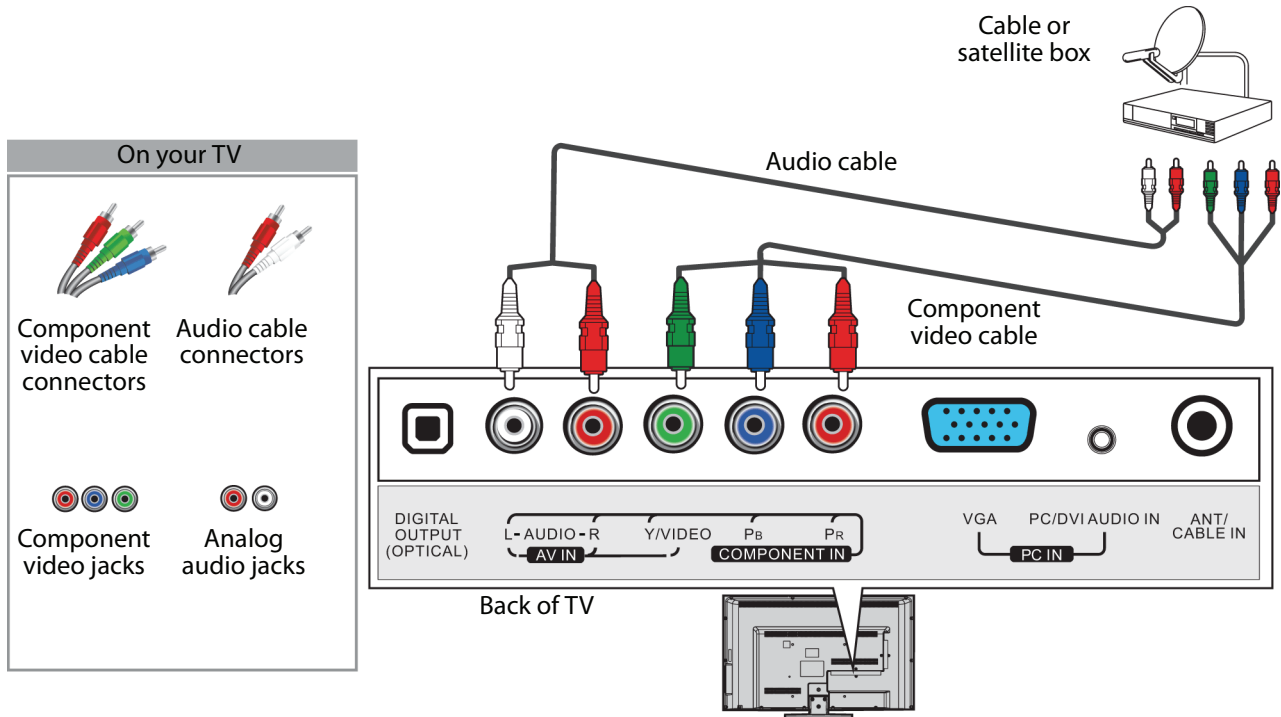

- 1 Make sure that your TV's power cord is unplugged and all connected equipment is turned off.
- 2 Connect the incoming cable from the cable wall jack to the cable-in jack on the cable or satellite box.
- 3 Connect a component video cable (not provided) to the **Y/VIDEO**, **Pb**, and **Pr** jacks on the back of your TV and the component video out jacks on the cable or satellite box.
- 4 Connect an audio cable (not provided) to the **L** and **R AUDIO** jacks on the back of your TV and to the audio out jacks on the cable or satellite TV box.

Notes

- The **Y/VIDEO**, **Pb**, and **Pr** video jacks (used to connect a component device) share the **L** and **R AUDIO** jacks with the **Y/VIDEO** jack (used to connect an AV (composite video) device).
- When you connect the audio using the **L** and **R AUDIO** jacks, the audio output is analog.

- 5 Plug your TV's power cord into a power outlet, turn on your TV, then turn on the cable or satellite box.
- 6 Press **INPUT** to open the **INPUT SOURCE** list.
- 7 Press **▲** or **▼** to highlight **Component/AV**, then press **ENTER**.

AV (composite video) (good)

Notes

- Cables are often color-coded to match color-coded jacks.
- The yellow video connector on the AV cable connects to the green **Y/VIDEO** jack.

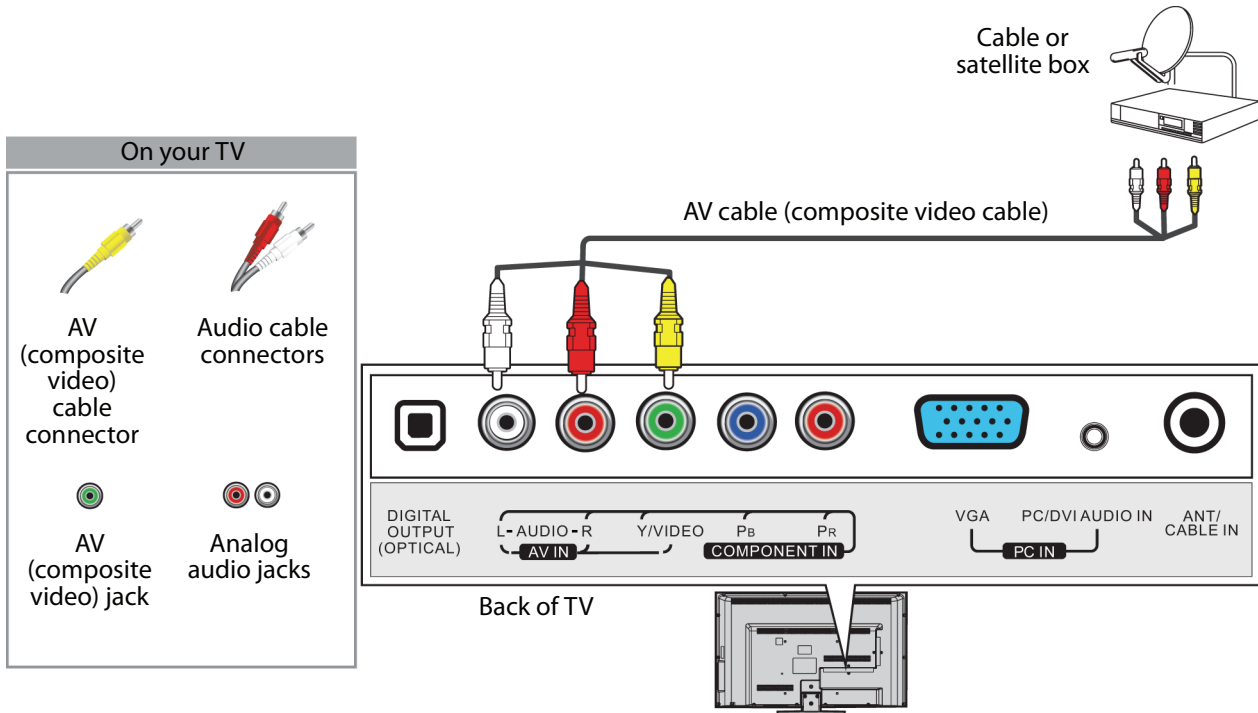

- 1 Make sure that your TV's power cord is unplugged and all connected equipment is turned off.
- 2 Connect the incoming cable from the cable wall jack to the cable-in jack on the cable or satellite box.
- 3 Connect an AV cable (not provided) to the green **Y/VIDEO** jack and **L** and **R AUDIO** jacks on the back of your TV and to the AV (composite video) and audio out jacks on the cable or satellite box.

Notes

- The **Y/VIDEO**, **PB**, and **PR** video jacks (used to connect a component device) share the **L** and **R AUDIO** jacks with the **Y/VIDEO** jack (used to connect an AV (composite video) device).
- When you connect the audio using the **L** and **R AUDIO** jacks, the audio output is analog.

- 4 Plug your TV's power cord into a power outlet, turn on your TV, then turn on the cable or satellite box.
- 5 Press **INPUT** to open the **INPUT SOURCE** list.
- 6 Press **▲** or **▼** to highlight **Component/AV**, then press **ENTER**.

Coaxial (good)

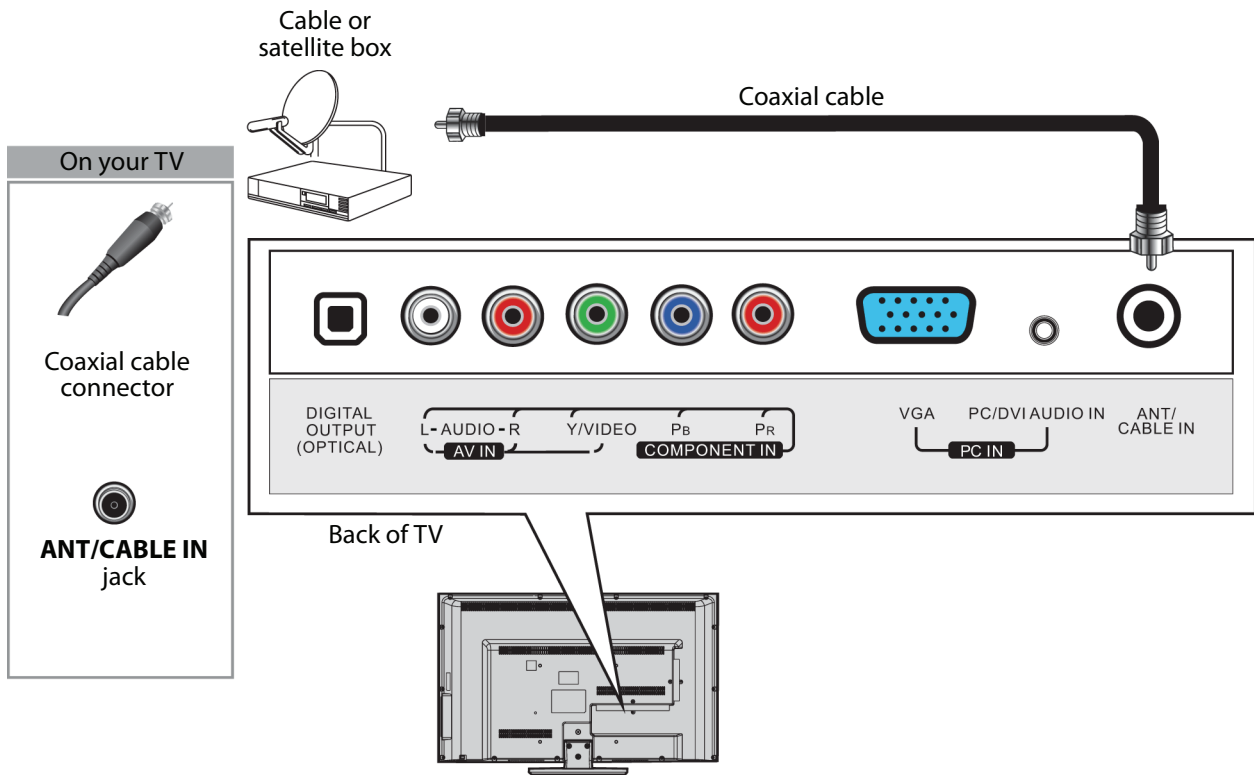

- 1 Make sure that your TV's power cord is unplugged and all connected equipment is turned off.
- 2 Connect the incoming cable from the cable wall jack to the cable-in jack on the cable or satellite box.
- 3 Connect a coaxial cable (not provided) to the **ANT/CABLE IN** jack on the back of your TV and to the coaxial out jack on the cable or satellite box.
- 4 Plug your TV's power cord into a power outlet, turn on your TV, then turn on the cable or satellite box.
- 5 Press **INPUT** to open the *INPUT SOURCE* list.
- 6 Press **▲** or **▼** to highlight **TV**, then press **ENTER**.
- 7 If you cannot tune to channels you know exist, scan for channels. See "[Automatically scan for channels](#)" on page 55.

Notes

- Use a coaxial cable to eliminate interference and noise from radio waves.
- Do not bundle the coaxial cable with the power cord or other cables.

Connect an antenna or cable TV (no box)

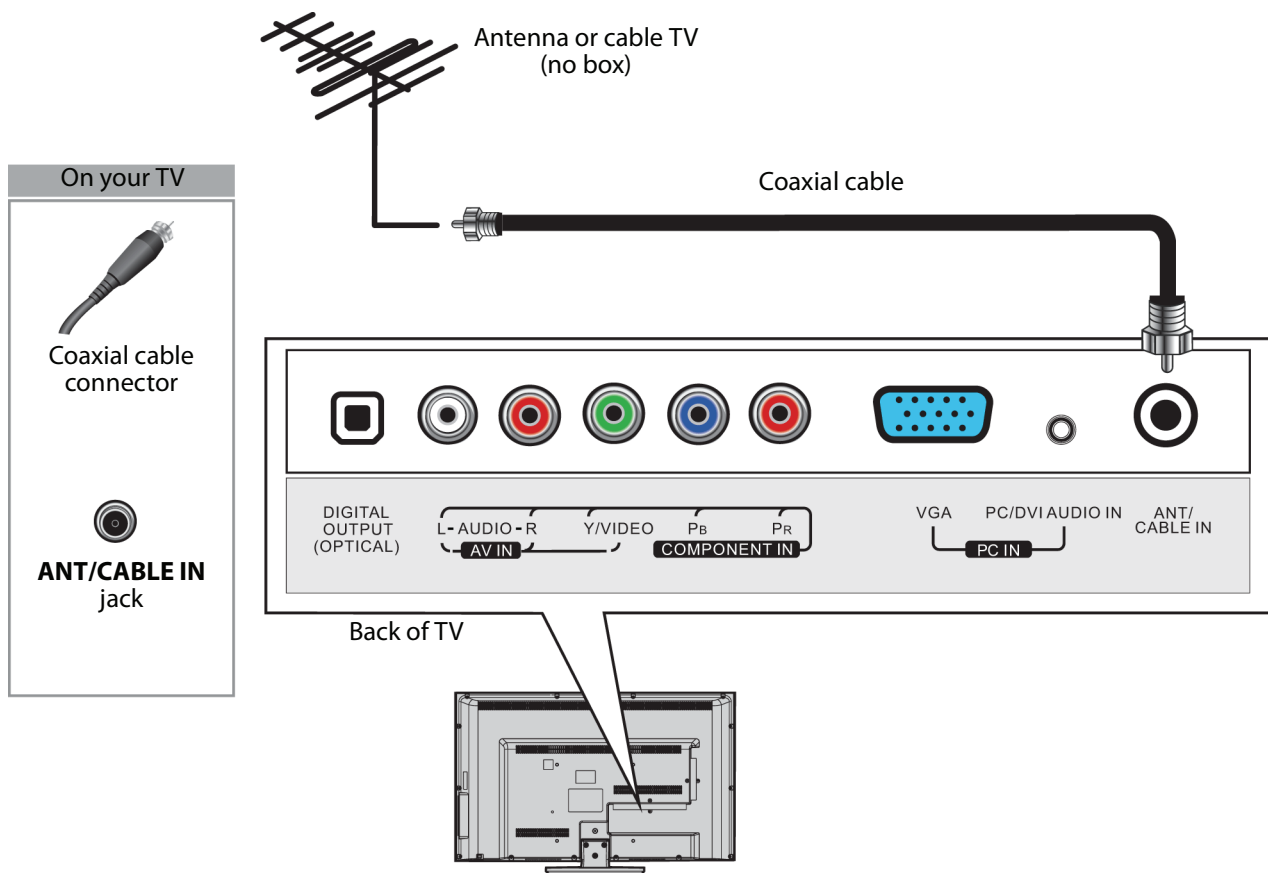

- 1 Make sure that your TV's power cord is unplugged and all connected equipment is turned off.
- 2 Connect a coaxial cable (not provided) to the **ANT/CABLE IN** jack on the back of your TV and to the antenna or cable TV wall jack.
- 3 Plug your TV's power cord into a power outlet, then turn on your TV.
- 4 Press **INPUT** to open the *INPUT SOURCE* list.
- 5 Press **▲** or **▼** to highlight **TV**, then press **ENTER**.
- 6 If you cannot tune to channels you know exist, scan for channels. See "[Automatically scan for channels](#)" on page 55.

Notes

- Use a coaxial cable to eliminate interference and noise from radio waves.
- Do not bundle the coaxial cable with the power cord or other cables.
- If the antenna is not installed correctly, contact qualified service personnel to correct the problem.
- If the signal level for a channel is weak, the picture may be distorted. Adjust the antenna or use a highly directional outdoor or set-top antenna with a built-in amplifier.
- If the picture quality is good on some channels and poor on others, the problem may be caused by a poor or weak signal from the broadcaster or cable TV provider.
- If you connect to cable TV without a set-top box and experience poor picture quality, you may need to install a set-top box to improve signal reception and picture quality. Contact your cable TV provider about upgrading to a set-top box.
- Many high-definition (HD) channels upscale standard-definition (SD) content. The picture displayed on your TV is still displayed as SD, thus the picture quality will not be as clear or crisp as it would be if the content was originally recorded in HD.

Connect a DVD or Blu-ray player

Many DVD or Blu-ray players have more than one connection type. To get the best video, you should use the best connection type available. For more information, see "What connection should I use?" on page 12.

HDMI (best)

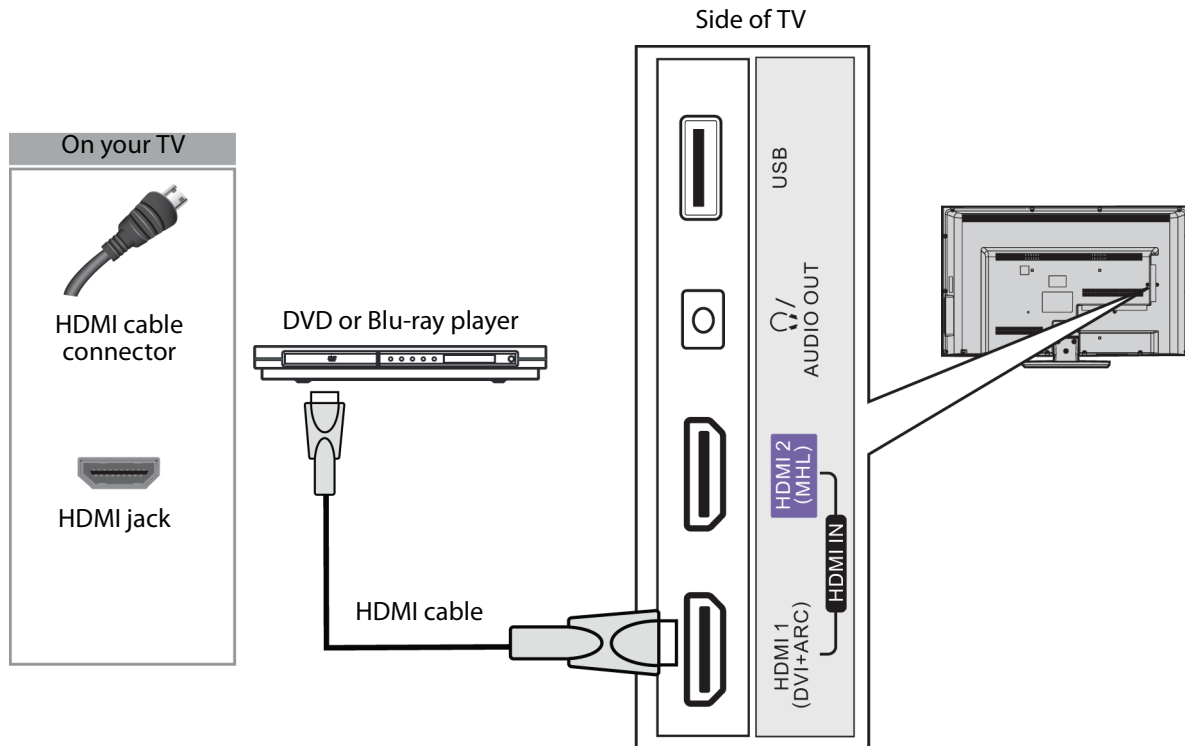

- 1 Make sure that your TV's power cord is unplugged and the DVD or Blu-ray player is turned off.
- 2 Connect an HDMI cable (not provided) to one of the **HDMI** jacks on the side of your TV and to the **HDMI OUT** jack on the DVD or Blu-ray player.
- 3 Plug your TV's power cord into a power outlet, then turn on your TV and DVD or Blu-ray player.
- 4 Press **INPUT** to open the *INPUT SOURCE* list.
- 5 Press **▲** or **▼** to highlight **HDMI 1** or **HDMI 2**, then press **ENTER**.

Note

An HDMI cable carries both audio and video. You do not need to use any audio cables.

Component video (better)

Note

Cables are often color-coded to match color-coded jacks.

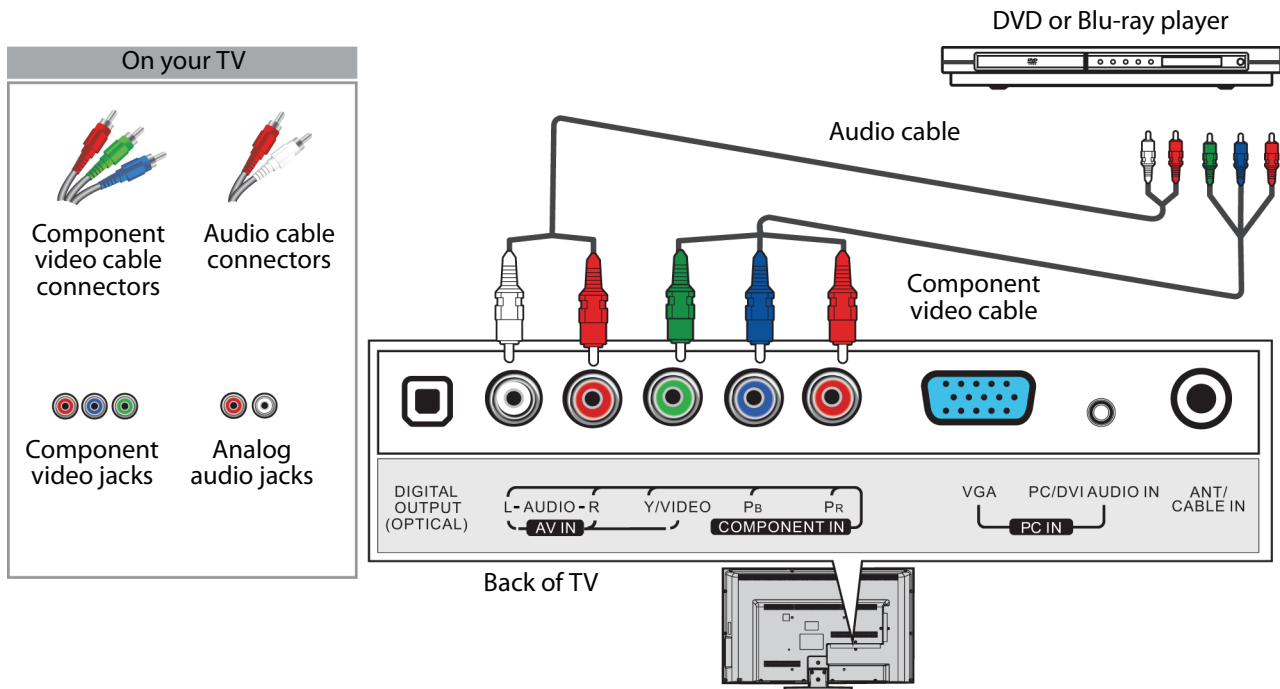

- 1 Make sure that your TV's power cord is unplugged and the DVD or Blu-ray player is turned off.
- 2 Connect a component video cable (not provided) to the **Y/VIDEO**, **Pb**, and **Pr** jacks on the back of your TV and to the **COMPONENT OUT** jacks on the DVD or Blu-ray player.
- 3 Connect an audio cable (not provided) to the **L** and **R AUDIO** jacks on the back of your TV and to the **L** and **R AUDIO OUT** jacks on the DVD or Blu-ray player.

Notes

- The **Y/VIDEO**, **Pb**, and **Pr** video jacks (used to connect a component device) share the **L** and **R AUDIO** jacks with the **Y/VIDEO** jack (used to connect an AV (composite video) device).
- When you connect the audio using the **L** and **R AUDIO** jacks, the audio output is analog.

- 4 Plug your TV's power cord into a power outlet, then turn on your TV and DVD or Blu-ray player.
- 5 Press **INPUT** to open the **INPUT SOURCE** list.
- 6 Press **▲** or **▼** to select **Component/AV**, then press **ENTER**.

AV (composite video) (good)

Notes

- Cables are often color-coded to match color-coded jacks.
- The yellow video connector on the AV cable connects to the green **Y/VIDEO** jack.

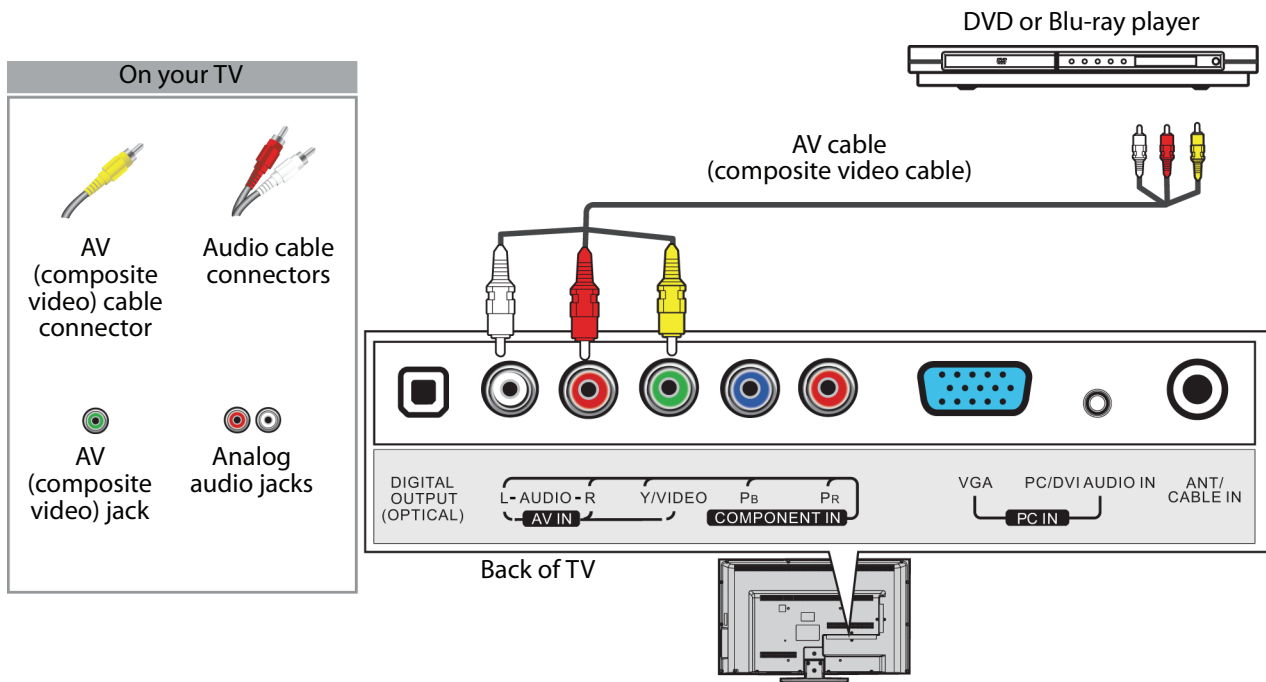

- 1 Make sure that your TV's power cord is unplugged and the DVD or Blu-ray player is turned off.
- 2 Connect an AV cable (not provided) to the green **Y/VIDEO** jack and **L** and **R AUDIO** jacks on the back of your TV and to the **AV OUT** jacks on the DVD or Blu-ray player.

Notes

- The **Y/VIDEO**, **PB**, and **PR** video jacks (used to connect a component device) share the **L** and **R AUDIO** jacks with the **Y/VIDEO** jack (used to connect an AV (composite video) device).
- When you connect the audio using the **L** and **R AUDIO** jacks, the audio output is analog.

- 3 Plug your TV's power cord into a power outlet, then turn on your TV.
- 4 Turn on the DVD or Blu-ray player, then set it to the correct output mode. For more information, see the documentation that came with the player.
- 5 Press **INPUT** to open the **INPUT SOURCE** list.
- 6 Press **▲** or **▼** to select **Component/AV**, then press **ENTER**.

Connect a Roku Streaming Stick

You can connect a Roku Streaming Stick® to your TV to enjoy streaming video and audio.

Note

You must use the purple **HDMI 2 (MHL)** jack to connect a Roku Streaming Stick.

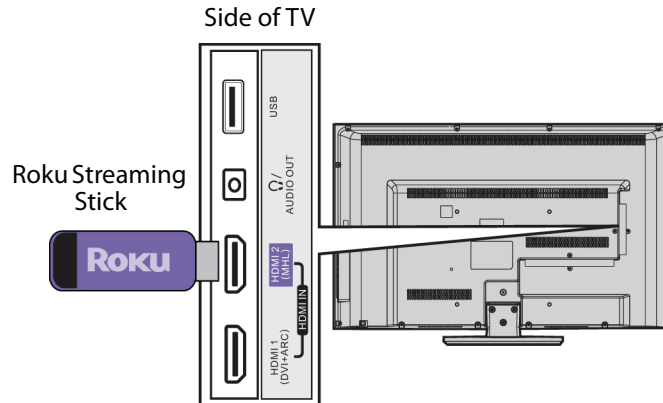

- 1 Plug the Roku Streaming Stick (not provided) into the purple **HDMI 2 (MHL)** jack on the side of your TV.
- 2 If your TV is turned on, press **ENTER** when a message appears. Your Roku Streaming Stick's menu opens. (The message may take about 20 seconds to appear.)

OR

If your TV is turned off, turn on your TV. Press  (home). Your Roku Streaming Stick's menu opens.

Notes

You can also switch to Roku mode by:

- Pressing **INPUT** and selecting **HDMI2 (Roku)**
- Pressing **MENU** and selecting **STREAMING**

For instructions on using your Roku Streaming Stick, see "Use a Roku Streaming Stick" on page 42.

Connect an MHL-enabled device

You can connect an MHL-enabled device, such as a cell phone, and view your device's screen on your TV.

Note

You must use the purple **HDMI 2 (MHL)** jack to connect an MHL-enabled device.

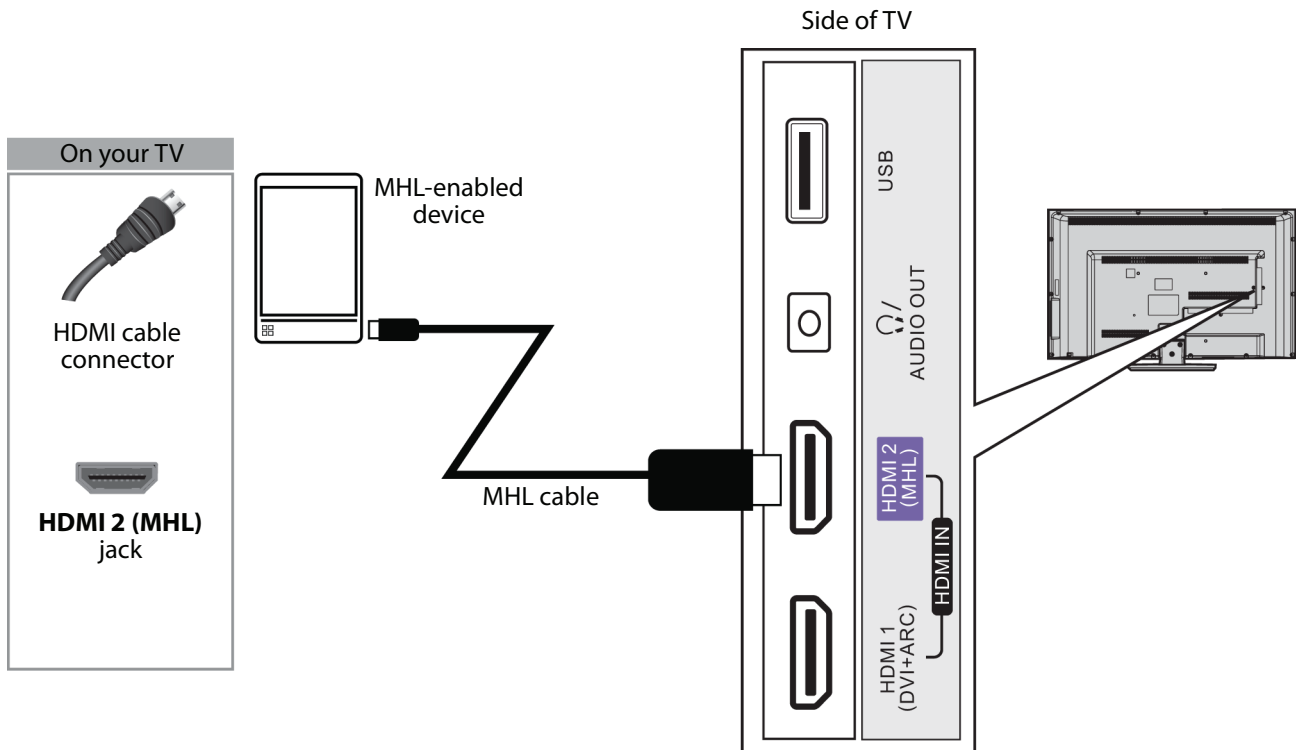

- 1 Connect the small connector on an MHL cable (not provided) to the micro USB port on the MHL-enabled device.
- 2 Connect the other end of the cable to the purple **HDMI 2 (MHL)** jack on the side of your TV.
- 3 Turn on the MHL-enabled device.
- 4 If your TV is turned on, press **ENTER** when a message appears. Your MHL-enabled device's menu opens.
OR
If your TV is turned off, turn on your TV. Press **⬆** (home). Your MHL-enabled device's menu opens.

Notes

You can also switch to MHL mode by:

- Pressing **INPUT** and selecting **HDMI2 (MHL/ACC)**
- Pressing **MENU** and selecting **MHL/ACC**

For instructions on using your MHL-enabled device, see "[Use an MHL-enabled device](#)" on page 43.

Connect a game console

HDMI (best)

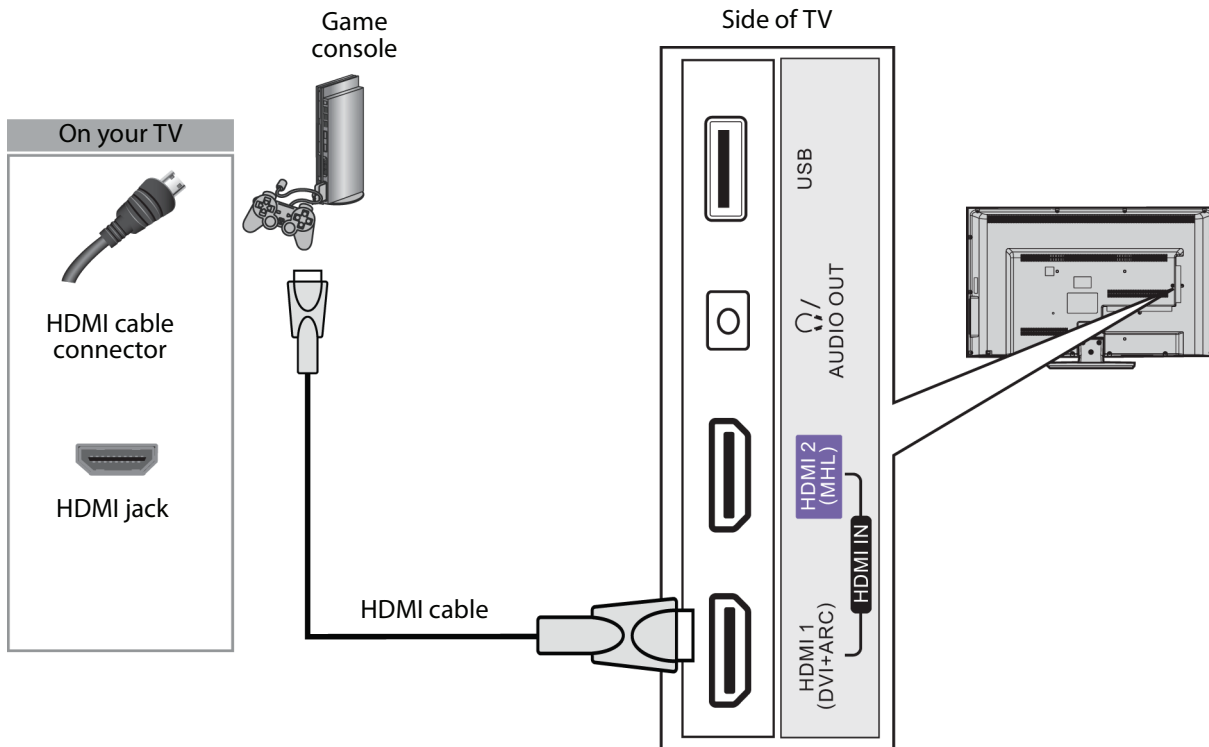

- 1 Make sure that your TV's power cord is unplugged and the game console is turned off.
- 2 Connect an HDMI cable (not provided) to one of the **HDMI** jacks on the side of your TV and to the **HDMI OUT** jack on the game console.
- 3 Plug your TV's power cord into a power outlet, then turn on your TV.
- 4 Turn on the game console, then set it to the correct output mode. For more information, see the documentation that came with the console.
- 5 Press **INPUT** to open the *INPUT SOURCE* list.
- 6 Press **▲** or **▼** to highlight **HDMI 1** or **HDMI 2**, then press **ENTER**.

Note

An HDMI cable carries both audio and video. You do not need to use any audio cables.

Component video (better)

Note
Cables are often color-coded to match color-coded jacks.

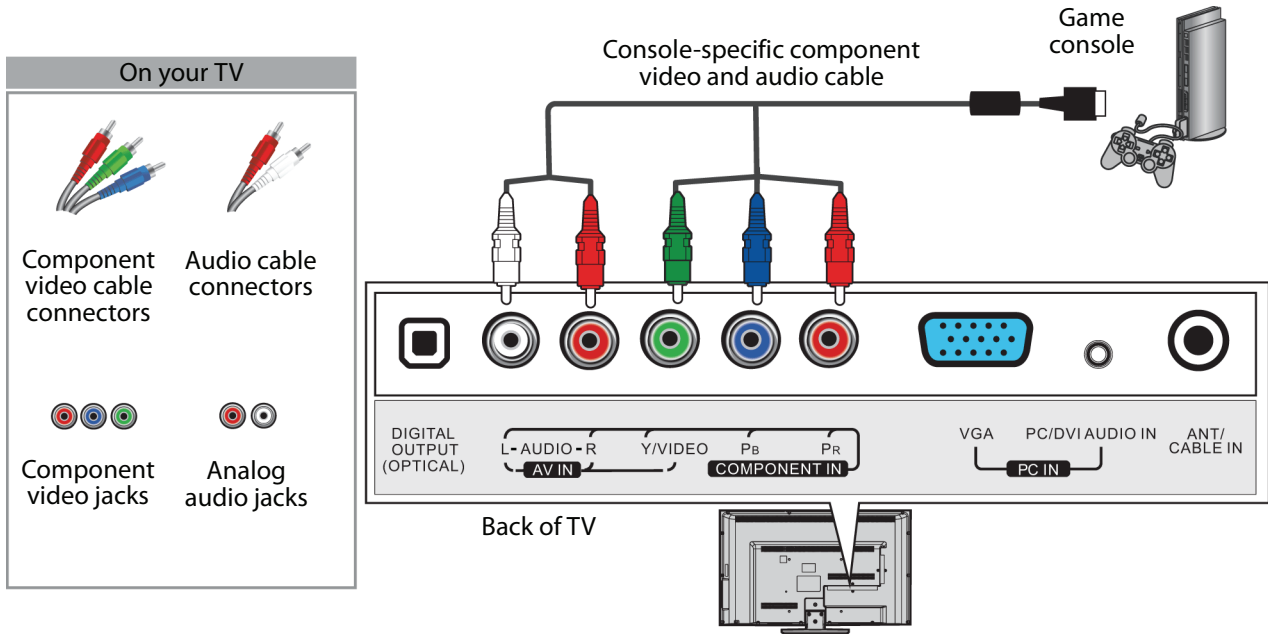

- 1 Make sure that your TV's power cord is unplugged and the game console is turned off.
- 2 Connect the video and audio connectors on the component video cable (not provided) to the **Y/VIDEO**, **PB**, and **PR** video jacks and **L** and **R AUDIO** jacks on the back of your TV and to the component jack(s) on the game console.

Note

- Your game console may require a special component video cable. See the documentation that came with your game console or check the manufacturer's website.
- The **Y/VIDEO**, **PB**, and **PR** video jacks (used to connect a component device) share the **L** and **R AUDIO** jacks with the **Y/VIDEO** jack (used to connect an AV (composite video) device).
- When you connect the audio using the **L** and **R AUDIO** jacks, the audio output is analog.

- 3 Plug your TV's power cord into a power outlet, then turn on your TV.
- 4 Turn on the game console, then set it to the correct output mode. For more information, see the documentation that came with the console.
- 5 Press **INPUT** to open the *INPUT SOURCE* list.
- 6 Press **▲** or **▼** to select **Component/AV**, then press **ENTER**.

AV (composite video) (good)

Notes

- Cables are often color-coded to match color-coded jacks.
- The yellow video connector on the AV cable connects to the green **Y/VIDEO** jack.

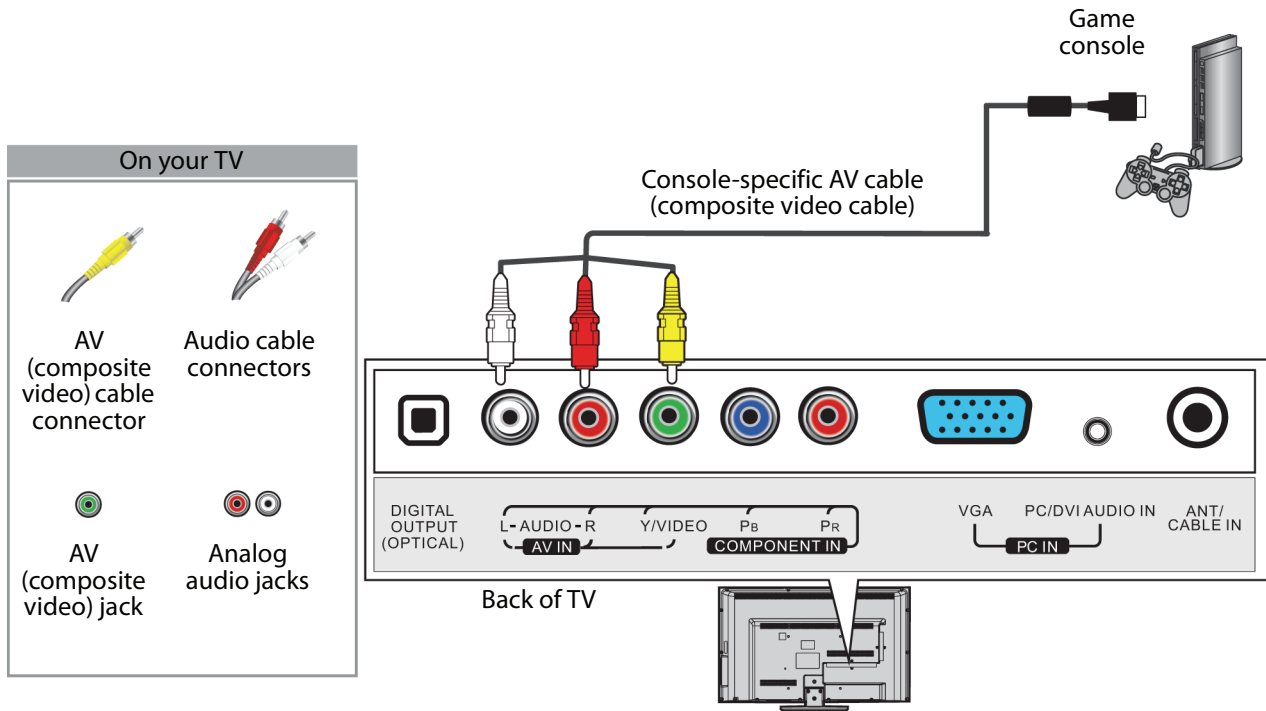

- 1 Make sure that your TV's power cord is unplugged and the game console is turned off.
- 2 Connect the video and audio connectors on the game console's AV cable (not provided) to the green **Y/VIDEO** jack and **L** and **R AUDIO** jacks on the back of your TV and to the composite jack(s) on the game console.

Note

- Most game consoles come with a special AV (composite video) cable. See the documentation that came with your game console or check the manufacturer's Web site.
- The **Y/VIDEO**, **Pb**, and **Pr** video jacks (used to connect a component device) share the **L** and **R AUDIO** jacks with the **Y/VIDEO** jack (used to connect an AV (composite video) device).
- When you connect the audio using the **L** and **R AUDIO** jacks, the audio output is analog.

- 3 Plug your TV's power cord into a power outlet, then turn on your TV.
- 4 Turn on the game console, then set it to the correct output mode. For more information, see the documentation that came with the console.
- 5 Press **INPUT** to open the **INPUT SOURCE** list.
- 6 Press **▲** or **▼** to select **Component/AV**, then press **ENTER**.

Connect a computer

HDMI (best)

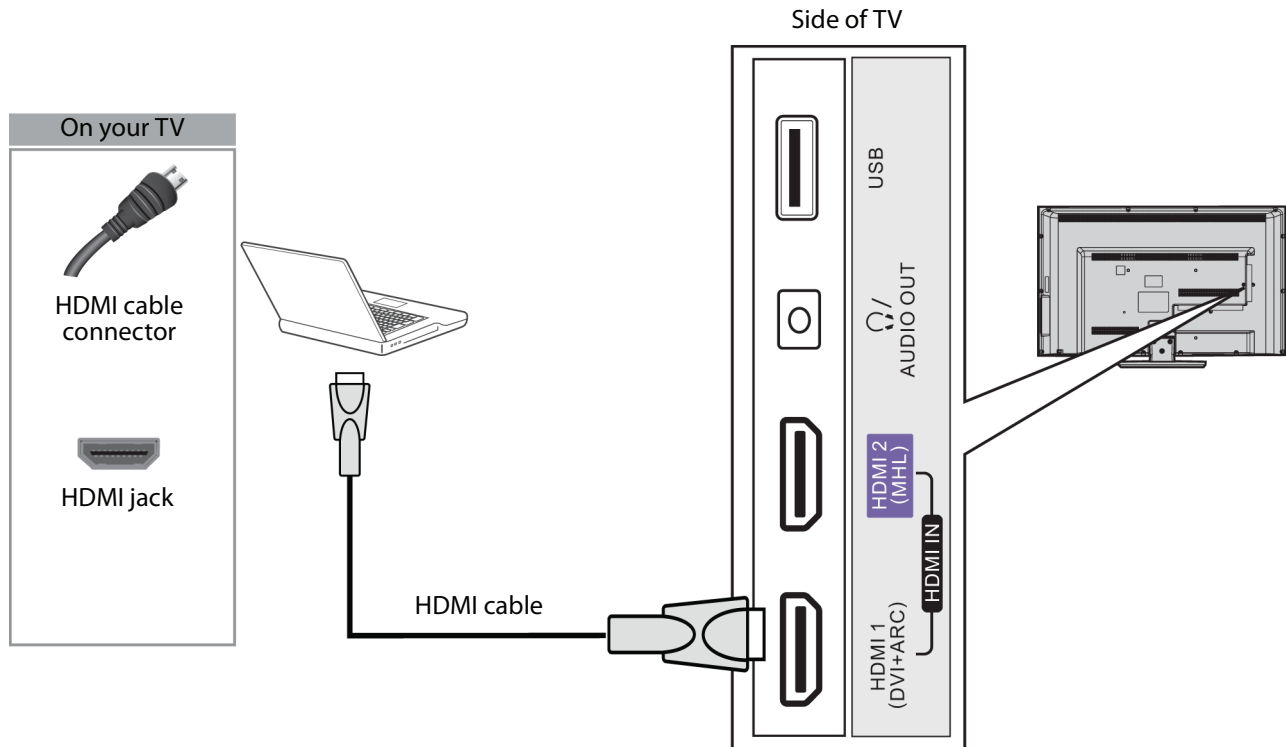

- 1 Make sure that your TV's power cord is unplugged and the computer is turned off.
- 2 Connect an HDMI cable (not provided) to one of the **HDMI** jacks on the side of your TV and to the **HDMI OUT** jack on the computer.
- 3 Plug your TV's power cord into a power outlet, then turn on your TV and the computer.
- 4 Press **INPUT** to open the *INPUT SOURCE* list.
- 5 Press **▲** or **▼** to highlight **HDMI 1** or **HDMI 2**, then press **ENTER**.
- 6 Adjust the display properties on the computer, if necessary.

DVI (same as HDMI but requires an audio connection)

Note
 You must use the **HDMI 1 (DVI+ARC)** jack to connect a computer using DVI. If you use another HDMI jack, you will not hear sound from the TV speakers.

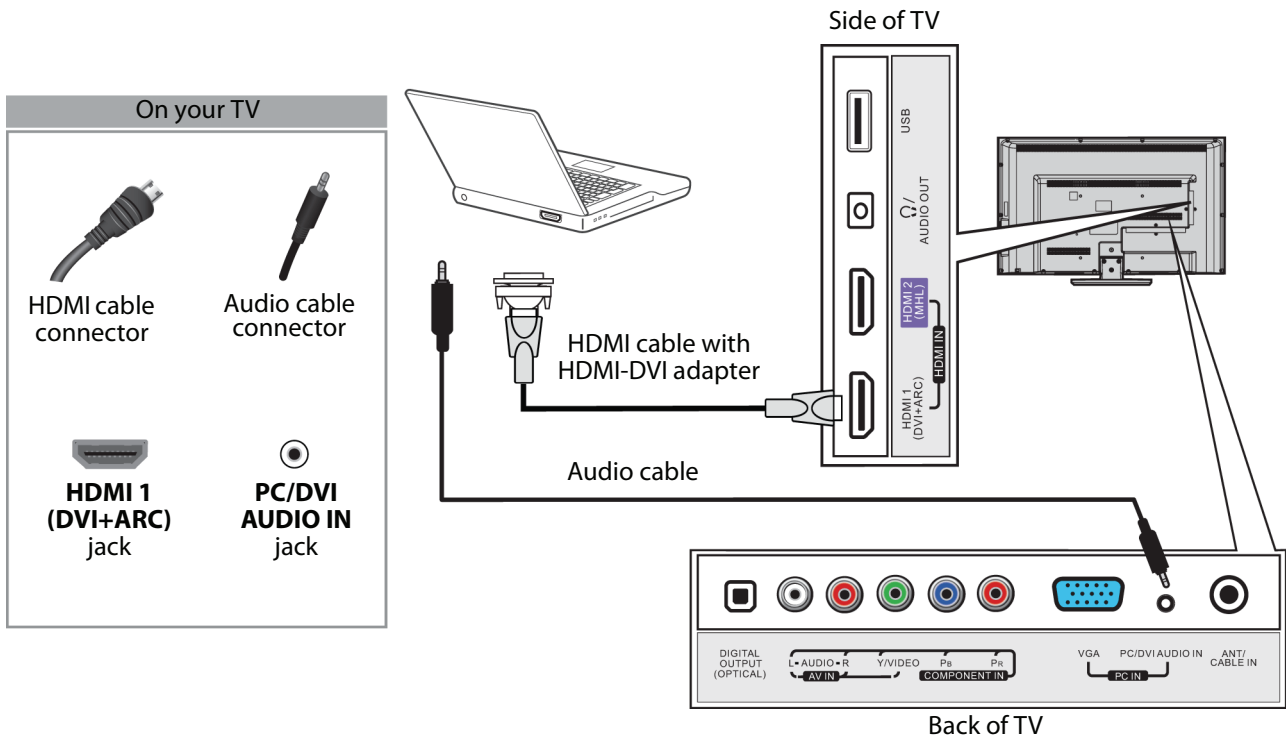

- 1 Make sure that your TV's power cord is unplugged and the computer is turned off.
- 2 Connect an HDMI-DVI adapter (not provided) to one end of an HDMI cable (not provided), then connect the adapter to the **DVI OUT** jack on the computer.
- 3 Connect the other end of the cable to the **HDMI 1 (DVI+ARC)** jack on the side of your TV.
- 4 Connect an audio cable (not provided) to the **PC/DVI AUDIO IN** jack on the back of your TV and to the **AUDIO OUT** (headphone) jack on the computer.

Note
 When you connect the audio using the **PC/DVI AUDIO IN** jack, the audio output is analog.

- 5 Plug your TV's power cord into a power outlet, then turn on your TV and the computer.
- 6 Press **INPUT** to open the *INPUT SOURCE* list.
- 7 Press **▲** or **▼** to select **HDMI 1**, then press **ENTER**.
- 8 Adjust the display properties on the computer, if necessary.

VGA (good)

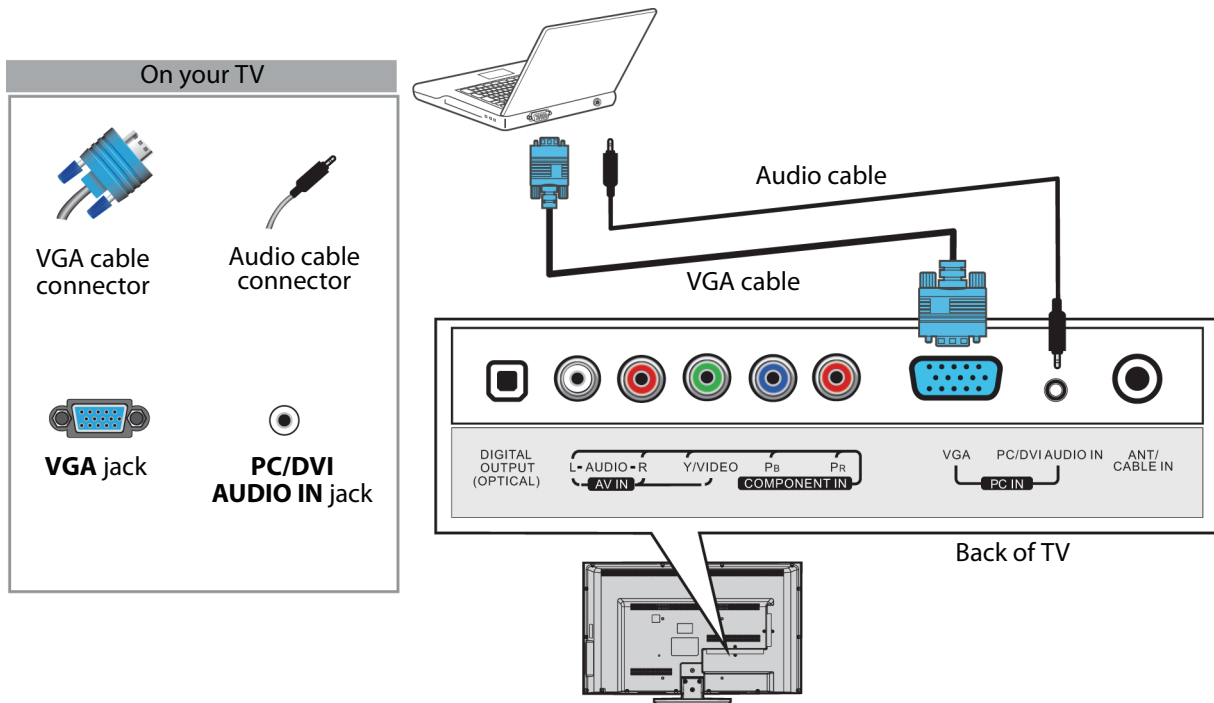

- 1 Make sure that your TV's power cord is unplugged and the computer is turned off.
- 2 Connect a VGA cable (not provided) to the **VGA** jack on the back of your TV and to the **VGA** jack on the computer.
- 3 Connect an audio cable (not provided) to the **PC/DVI AUDIO IN** jack on the back of your TV and to the **AUDIO OUT** (headphone) jack on the computer.
- 4 Plug your TV's power cord into a power outlet, then turn on your TV and the computer.
- 5 Press **INPUT** to open the *INPUT SOURCE* list.
- 6 Press **▲** or **▼** to select **VGA**, then press **ENTER**.
- 7 Adjust the display properties on the computer, if necessary.

Connect a USB flash drive

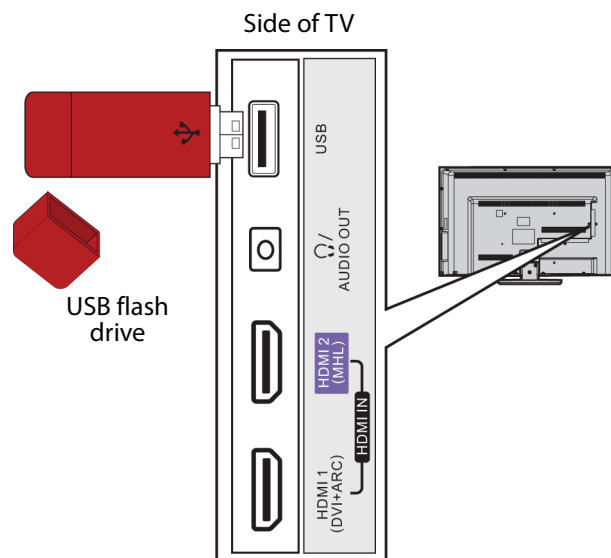

- 1 Plug a USB flash drive into the **USB** port on the side of your TV.

Caution

Do not remove the USB flash drive or turn off the TV while using the USB flash drive. You may lose data or damage the USB flash drive.

- 2 If your TV is turned on when you connect the USB flash drive, press **▲** or **▼** to select **Yes** in the message that appears. The *PHOTOS* menu opens.

OR

If you switch to a different video input source after you plug in the USB flash drive and want to switch back to the drive, press **INPUT** to open the *INPUT SOURCE* list, press **▲** or **▼** to select **USB (Photos)**, then press **ENTER**. The *PHOTOS* menu opens.

Note

The **Photos** viewer only supports JPEG format images (with ".jpg" file extensions) and not all JPEG files are compatible with your TV. For more information, see "[Use a USB flash drive](#)" on page 47.

Connect headphones

When you connect headphones, the TV speakers are muted.

Warning

Loud noise can damage your hearing. When using headphones, use the lowest volume setting on your headphones that still lets you hear the sound.

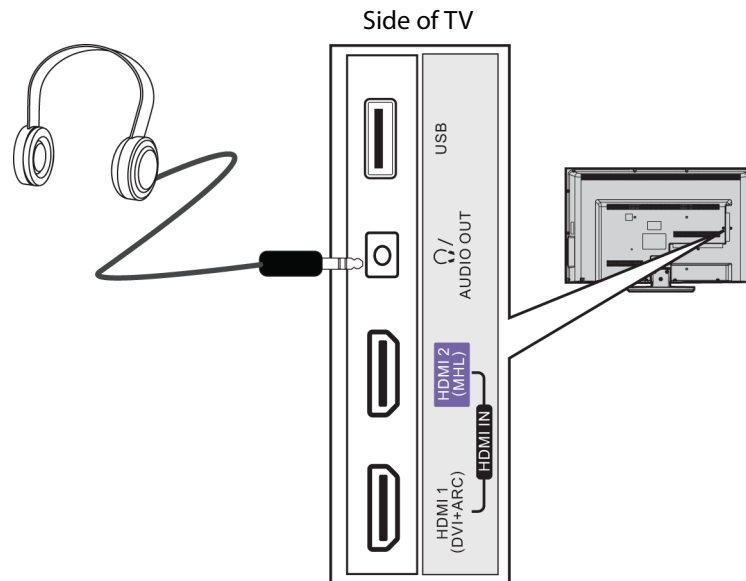

- 1 Connect the headphones to the /AUDIO OUT jack on the side of your TV.
- 2 In the screen that opens, press or to highlight **Headphones**, then press **ENTER**. For more information, see "[Select the audio out mode](#)" on page 54.

Notes

- If you connect headphones when your TV is turned off, then you turn on your TV, the TV speakers are muted and the audio plays through the headphones.
- You can also connect a home theater system, sound bar, or external speaker system to the /AUDIO OUT jack.

Connect external speakers or a sound bar

You can connect external speakers or a sound bar to the digital audio jack.

Digital audio

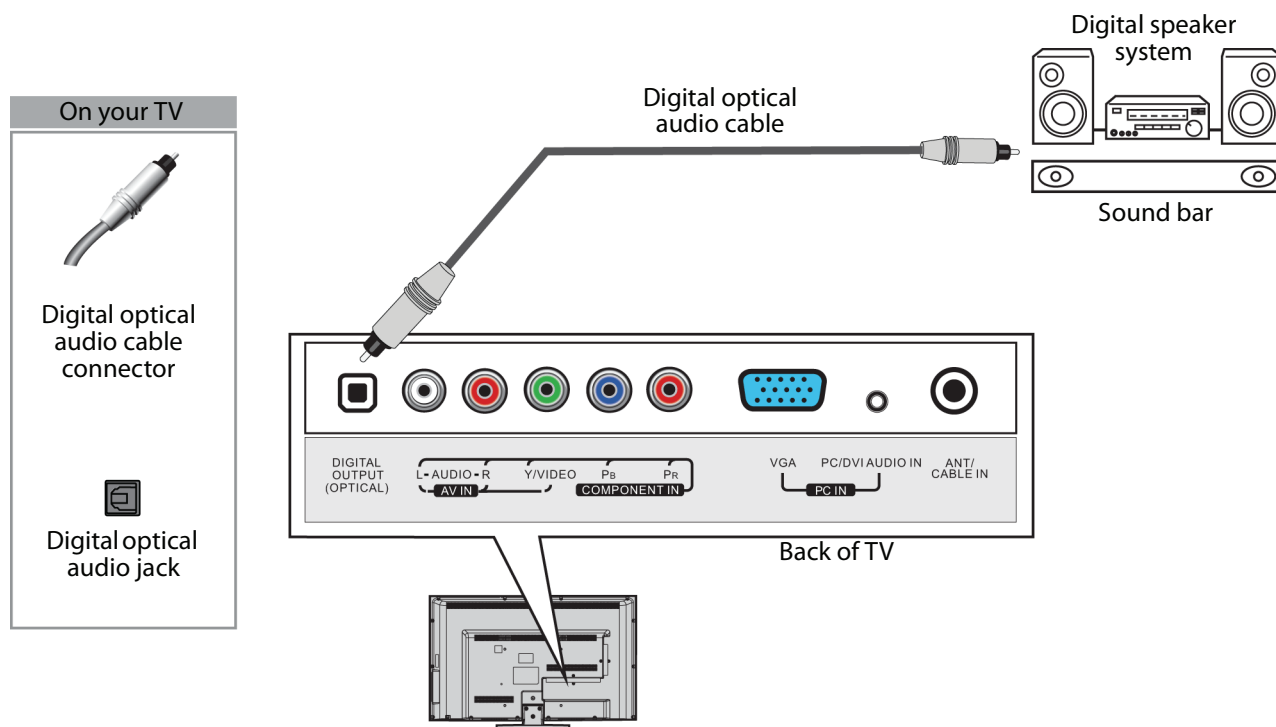

- 1 Make sure that your TV's power cord is unplugged and the digital speaker system or sound bar is turned off.
- 2 Connect a digital optical audio cable (not provided) to the **DIGITAL OUTPUT (OPTICAL)** jack on the back of your TV and to the optical **AUDIO IN** jack on the digital speaker system or sound bar.
- 3 Plug your TV's power cord into a power outlet, then turn on your TV.
- 4 Turn on the digital speaker system or sound bar, then set it to the correct source. For more information, see the documentation that came with the digital speaker system or sound bar.
- 5 On your TV, set the **Digital Audio/SPDIF** option on the **AUDIO** menu to **PCM**. See the **Digital Audio/SPDIF** option in "[Adjust sound settings](#)" on page 53.

Analog audio

When you connect an analog system or sound bar to the /AUDIO OUT jack, the TV speakers are muted.

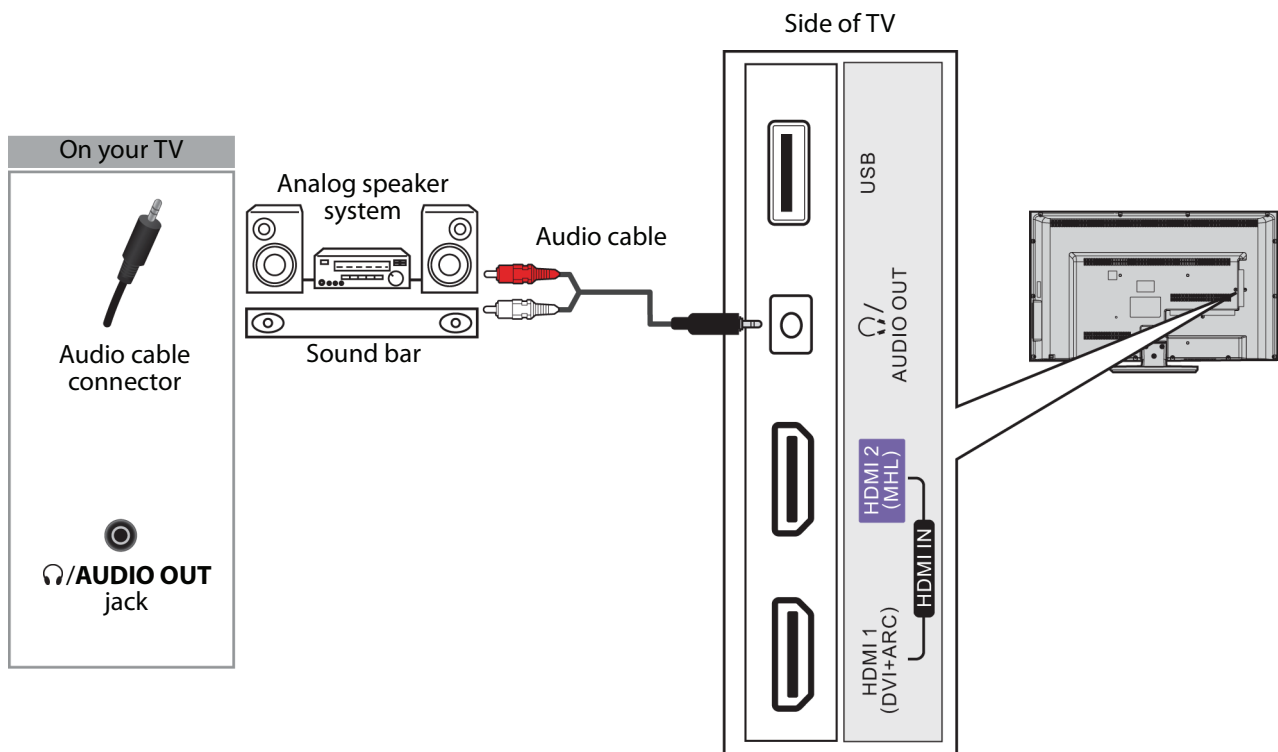

- 1 Make sure that your TV's power cord is unplugged and the analog speaker system or sound bar is turned off.
- 2 Connect an audio cable (not provided) to the /AUDIO OUT jack on the side of your TV and to the **AUDIO IN** jacks on the analog speaker system or sound bar.
- 3 Plug your TV's power cord into a power outlet, then turn on your TV.
- 4 Turn on the analog speaker system or sound bar, then set it to the correct source. For more information, see the documentation that came with the analog speaker system or sound bar.
- 5 On your TV, set the **Headphone/Audio Out** option on the *AUDIO* menu to **Audio Out Fixed** or **Audio Out Variable**. See the **Headphone/Audio Out** option in "*Adjust sound settings*" on page 53.

Connect a home theater system with multiple devices

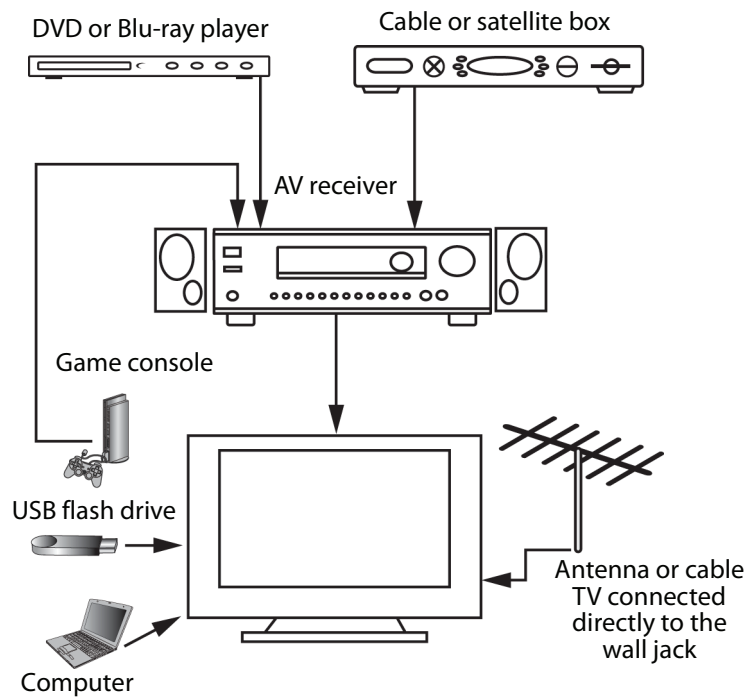

The connections you make depend on the video and audio jacks available on your devices. Refer to the documentation that came with your devices for connection information.

Just remember to use the best connection types available for the best picture and sound. For information about connection types, see ["What connection should I use?"](#) on page 12.

Connect power

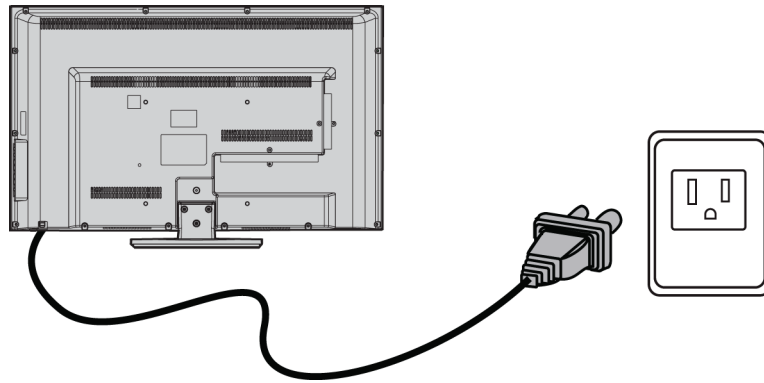

- Connect the AC power cord to a power outlet.

Caution

- Your TV should only be operated from the power source indicated on the label.
- Always unplug the AC power cord from the power outlet when you will not be using your TV for an extended period of time.
- The power cord is permanently attached to your TV. Do not try to unplug it from the back of your TV.

Use the remote control

Install remote control batteries

- 1 While pressing the release latch on the back of the remote control, lift the battery compartment cover off the remote control.

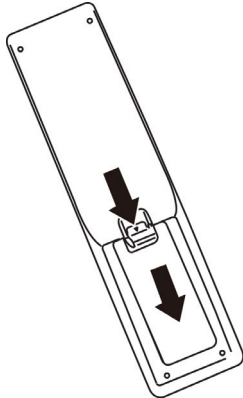

- 2 Insert two AAA batteries into the battery compartment. Make sure that you match the + and - symbols on the batteries with the + and - symbols in the battery compartment.

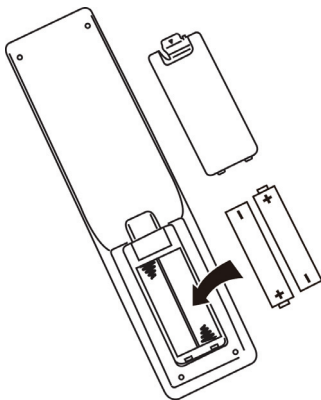

- 3 Replace the battery compartment cover.

Cautions

- Batteries should not be exposed to excessive heat, such as sunshine, heat registers, or fire.
- Battery chemicals can cause a rash. If the batteries leak, clean the battery compartment with a cloth. If chemicals touch your skin, wash immediately.
- Make sure that batteries are disposed of correctly. Do not burn or incinerate.

Notes

- Do not mix batteries of different types.
- Do not mix old and new batteries.
- Remove batteries when the charge is depleted.
- If the remote control is not going to be used for an extended period of time, remove the batteries.

Aim the remote control

- Point the remote control towards the remote sensor on the front of your TV. For the location of the remote sensor, see "[Front](#)" on page 8.

Turn on your TV for the first time

The first time you turn on your TV, the *TV SETUP* wizard opens. The wizard guides you through setting up basic settings including the menu language, time setting, picture mode, TV signal source, and the channel list.

- 1 Make sure that you have:
 - Installed the remote control batteries. (See page 36 for details.)
 - Connected an antenna, cable TV, or satellite TV. (See page 13 through 18 for details.)
 - Connected the power cord. (See page 35 for details.)
- 2 Press (power) to turn on your TV. The *Choose your Menu Language* screen opens.



- 3 Press or to highlight the language you want, then press **ENTER**. The time setting screen opens.



- 4 Press or to highlight **Mode**, then press to access the setting.
- 5 Press or to select **Manual** (to set the date and time manually) or **Auto** (to set the date and time automatically from a TV signal source based on the time zone you select), then press **ENTER**, **MENU**, or .

Note

If you select **Auto**, the displayed time will be incorrect until your TV gets the correct time from a TV signal source.

- 6 Press or to highlight **Time Zone**, then press to access the setting.
- 7 Press or to select your time zone. You can select **Eastern**, **Central**, **Mountain**, **Pacific**, **Alaska**, **Hawaii**, **Atlantic**, or **Newfoundland**, then press **ENTER**, **MENU**, or .
- 8 Press or to highlight **Daylight Saving**, then press to access the setting.
- 9 Press or to select **On** (if your viewing area observes Daylight Saving Time) or **Off** (if your viewing area does not observe Daylight Saving Time), then press **ENTER**, **MENU**, or .
- 10 If you selected **Manual** for **Mode**:
 - Press or to highlight **Year**, **Month**, or **Day**, then press to access the setting. Press or to adjust the setting, then press **ENTER**.
 - Press or to highlight **Time**, then press to access the setting. Press or to highlight the hour, minute, or AM/PM field, then press or to adjust the setting. When you are finished, press **ENTER**.
- 11 When you have finished setting the time, press **ENTER**. The *What is your viewing environment* screen opens.

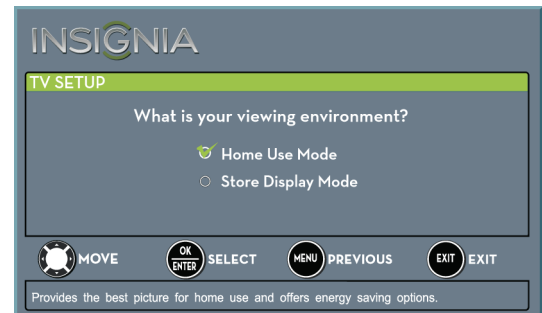

- 12 Press or to highlight **Home Use Mode** or **Store Display Mode**, then press **ENTER**.

If you selected **Store Display Mode**, a message asks if you are sure you want this mode. Select **Yes** to continue using **Store Display Mode**, or select **No** to change your selection, then press **ENTER**. **Store Display Mode** is not an energy savings mode and will display a retail banner.

The *Choose your TV Source* screen opens.



13 Press **▲** or **▼** to highlight **Antenna, Cable Service, or Satellite Service**, then press **ENTER**.

A If you select **Antenna**, your TV scans for available channels. The scan may take several minutes.

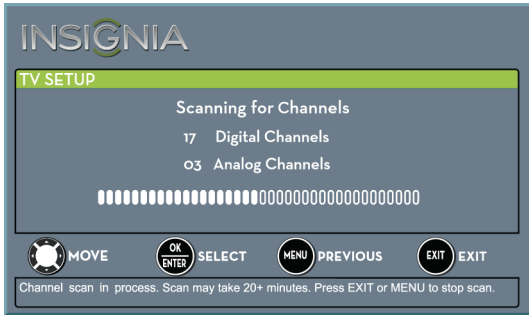

Note
You can press **EXIT** to stop the auto channel search, but you will need to run the auto channel search again to create a channel list.

B If you select **Cable Service**, a message asks if you have a cable box:

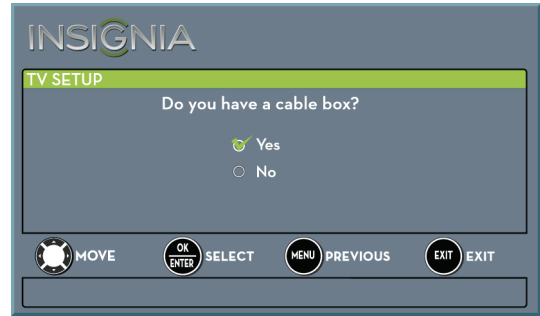

- Select **No**, then press **ENTER** if no cable box is connected. Your TV scans for available channels. The scan may take several minutes.
- Select **Yes**, then press **ENTER** if a cable box is connected. A message asks how you connected the cable box to your TV.

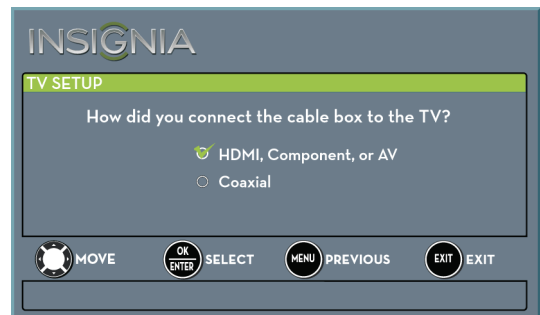

- Select **HDMI, Component, or AV**, then press **ENTER** if you connected a cable box to your TV using one of these cables. Read the message, then press **ENTER** to close the wizard.
- Select **Coaxial**, then press **ENTER** if you connected a cable box to your TV using a coaxial cable. Read the message, then press **ENTER** to start the channel scan (VHF channels only).

Note
You can press **EXIT** to stop the auto channel search, but you will need to run the auto channel search again to create a channel list.

- C If you select **Satellite Service**, a message asks how you connected the satellite box to your TV:

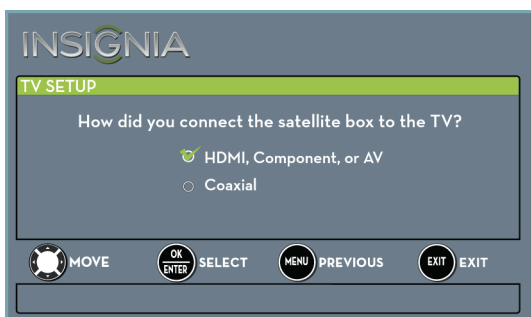

- Select **HDMI, Component, or AV**, then press **ENTER** if you connected a satellite box to your TV using one of these cables. Read the message, then press **ENTER** to close the wizard.
- Select **Coaxial**, then press **ENTER** if you connected a satellite box to your TV using a coaxial cable. Read the message, then press **ENTER** to start the channel scan (VHF channels only).

Note

You can press **EXIT** to stop the auto channel search, but you will need to run the auto channel search again to create a channel list.

- 14 To watch TV, press **INPUT**, press **▲** or **▼** to highlight the video input source for your TV in the **INPUT SOURCE** list, then press **ENTER**.
- If your TV is connected to an antenna, cable TV (no box), or cable or satellite TV box using a coaxial cable, select **TV**.
 - If your TV is connected to a cable or satellite box using an HDMI cable or HDMI cable with a DVI adapter, select **HDMI 1** or **HDMI 2**.
 - If your TV is connected to a cable or satellite box using a component video cable, select **Component/AV**.
 - If your TV is connected to a cable or satellite box using an AV (composite video) cable, select **Component/AV**.

Understand the basics

Turn your TV on or off

- 1 Make sure that the power cord is connected to a power outlet.
- 2 Press **⏻** (power) to turn on your TV. The power indicator turns off.
- 3 Press **⏻** (power) again to turn off your TV. Your TV enters standby mode, and the power indicator turns red.

Warning

When your TV is in standby mode, it is still receiving power. To completely disconnect power, unplug the power cord.

Note

If your TV does not receive an input signal for several minutes, it automatically goes into standby mode.

Select the video input source

Note

Your TV automatically detects and displays which video jacks have devices connected to them when the devices are turned on. You can turn this feature off to always display all inputs. For more information, see "Turn Input Sensor on or off" on page 68.

- 1 Turn on your TV.
- 2 If you want to use a device connected to a video input (such as a DVD or Blu-ray player), turn on the device.
- 3 Press **INPUT**. The **INPUT SOURCE** list opens.

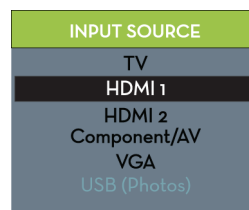

- 4 Press **▲** or **▼** to select a video input source, then press **ENTER**.

On-screen menu overview

Notes

- Depending on the signal source selected, you may see different options on your screen.
- Menu items that are not selectable are grayed out.
- The screens shown in this manual are for explanation purposes and may vary from the actual screens on your TV.

SETTINGS menu (TV mode)



PICTURE menu (TV mode)

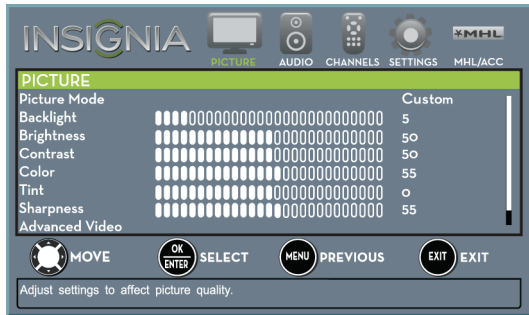

PHOTOS menu (USB mode)



AUDIO menu (TV mode)

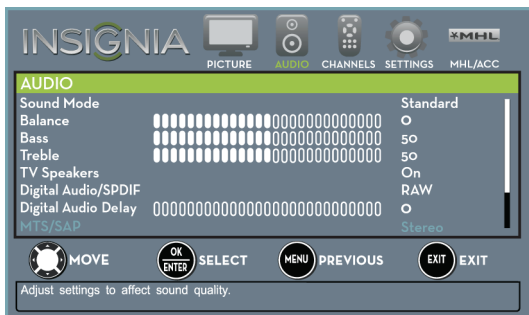

Navigate the menus

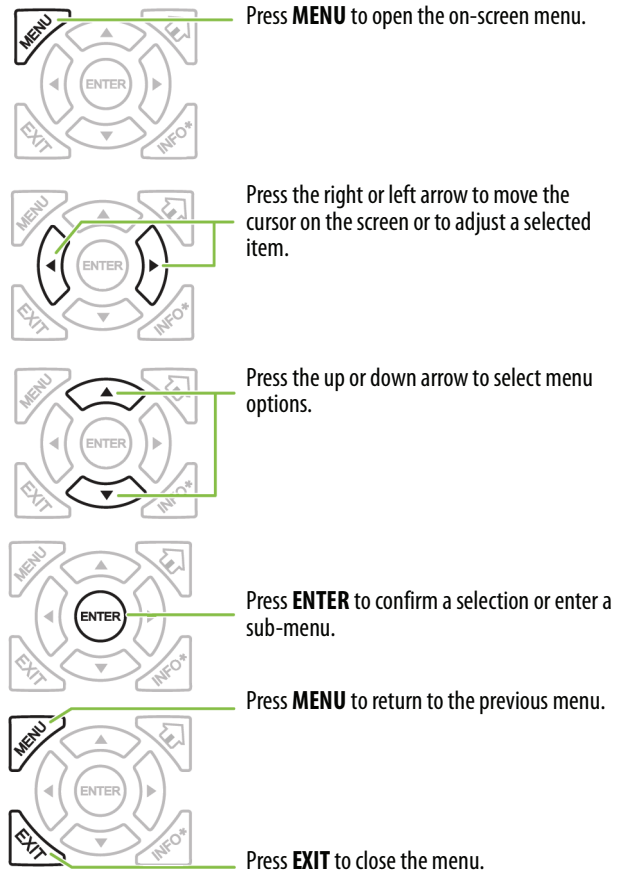

CHANNELS menu (TV mode)



Select a channel

- Press **CH** \wedge or **CH** \vee to go to the next or previous channel on the memorized channel list.
- Press the number buttons to enter the channel number you want, then wait for the channel to change or press **ENTER** to immediately change the channel.
- To select a digital sub-channel, press the number buttons to select the main digital channel, press \blacksquare (sub-channel), then press the number button for the sub-channel. Wait for the channel to change, or press **ENTER** to immediately change the channel. For example, to tune to channel 5.1, press **5**, \blacksquare (sub-channel), then **1**.

Note

Button presses must be within three seconds of each other.

- Press \curvearrowright (return) to go to the last viewed channel.
- Press **FAVORITE** to open the favorite channel list, press \blacktriangle or \blacktriangledown to highlight a channel, then press **ENTER**. For information about setting up a favorite channel list, see “[Set up a favorite channel list](#)” on page 57.

Note

If a list has more than one page, press \blacktriangle or \blacktriangledown to scroll through the pages.

Adjust the volume

- Press **VOL+** or **VOL-** to increase or decrease the volume.
- Press **MUTE** to turn off the sound. Press **MUTE** again to turn the sound back on.

View channel information

- Press **INFO*** to view an information banner. The information banner shows the current program information such as channel number, video input source, and resolution.
 - Digital channel information—Displays the channel number, station name, channel label, broadcast program name, TV rating, signal type, audio information, resolution, current time, signal strength, day of the week, date and current program start and end times, if provided by the broadcaster.
 - Analog channel information—Displays channel number, channel label (if present), signal type, audio information, day of the week, date, and resolution, if provided by the broadcaster.

Use a Roku Streaming Stick

You can connect a Roku Streaming Stick and enjoy streaming video and audio.

Note

- You can purchase a Roku Streaming Stick at www.bestbuy.com, www.bestbuy.ca, or www.futureshop.ca.
- You must use the purple **HDMI2 (MHL)** jack to connect a Roku Streaming Stick.

Connect and use

- 1 Connect a Roku Streaming Stick to your TV. For connection instructions, see "Connect a Roku Streaming Stick" on page 22. A message tells you the stick is connected.
- 2 Press **ENTER** to access your Roku Streaming Stick. Your stick's menu opens.

Note

Your Roku Streaming Stick's menu will vary depending on the content you have loaded on the device.

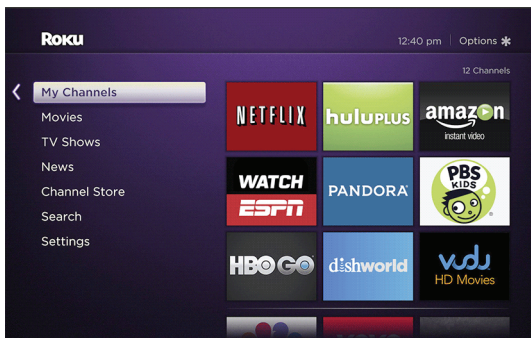

- 3 Use the following buttons to navigate on your Roku Streaming Stick:



Switch back to the Roku Streaming Stick

- Press **HOME** (home).
- OR
- Press **INPUT**, press **▲** or **▼** to select **HDMI2 (Roku)**, then press **ENTER**.

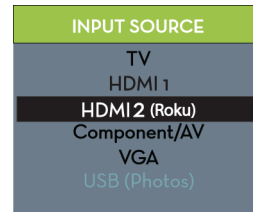

- OR
- Press **MENU**, then press **◀** or **▶** to highlight **STREAMING**, then press **ENTER**.

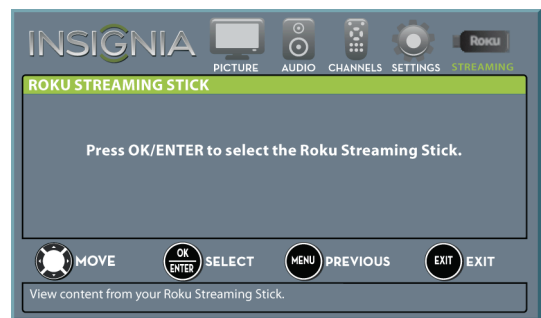

Your stick's menu opens.

Note

Your Roku Streaming Stick's menu will vary depending on the content you have loaded on the device.

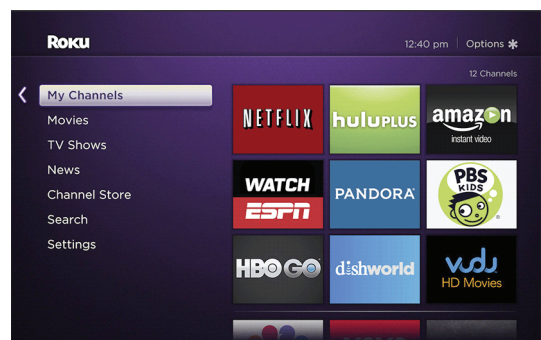

Use an MHL-enabled device

You can connect your MHL-enabled device, such as a cell phone, and view your device's screen on your TV.

Note
You must use the purple **HDMI 2 (MHL)** jack to connect an MHL-enabled device.

Connect and use

- 1 Connect an MHL-enabled device to your TV. For connection instructions, see "Connect an MHL-enabled device" on page 23. A message tells you the device is connected.
- 2 Press **ENTER** to access your MHL-enabled device. Your device's menu opens.

Note
Your device's menu will vary depending on the device and the Apps you have loaded on the device.

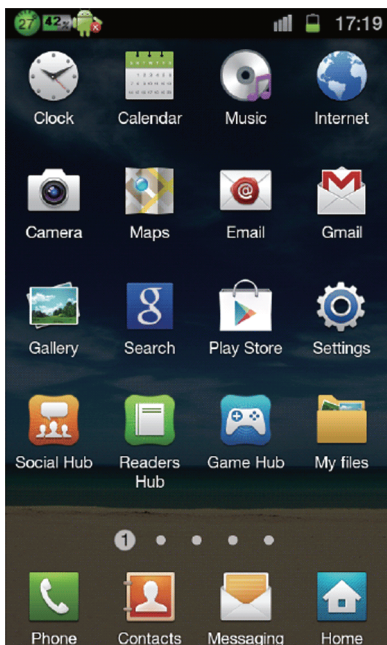

- 3 Use **▲ ▼ ◀ ▶** and **ENTER** to navigate on your device.

Note
The buttons you use to navigate on your device may vary depending on the device.

Switch back to a connected device

- 1 Press **INPUT**, then press **▲** or **▼** to select **HDMI2 (MHL/ACC)**.

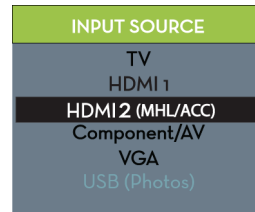

OR

- Press **MENU**, then press **◀** or **▶** to highlight **MHL/ACC**.



- 2 Press **ENTER** to access your MHL-enabled device. Your device's menu opens.

Note
Your device's menu will vary depending on the device and the Apps you have loaded on the device.

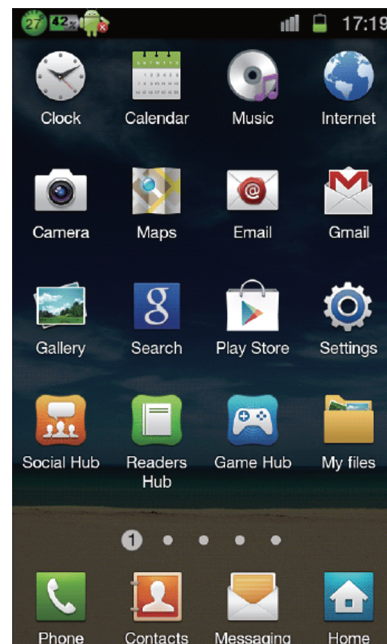

Use INlink

INlink lets you control HDMI CEC-compatible devices connected to the HDMI jacks on your TV using the remote control that came with your TV. To use INlink, you must set the **INlink Control** setting on the *SETTINGS · INlink* menu to **On**.

Notes

- HDMI cables must be used to connect HDMI CEC-compatible devices to your TV.
- The connected device's HDMI CEC feature must be turned on.
- If you connect an HDMI device that is not HDMI CEC-compatible, none of the **INlink Control** features work.
- Depending on the connected HDMI device, some **INlink Control** features may not work.

Turn INlink on or off

- 1 Press **MENU**. The on-screen menu opens.
- 2 Press **◀** or **▶** to highlight **SETTINGS**, then press **▼** or **ENTER**. The *SETTINGS* menu opens.



- 3 Press **▲** or **▼** to highlight **INlink**, then press **ENTER**. The *SETTINGS · INlink* menu opens.



- 4 Press **▲** or **▼** to highlight **INlink Control**, then press **ENTER**.
- 5 Press **▲** or **▼** to highlight **On** or **Off**, then press **ENTER**.
- 6 Press **MENU** to return to the previous menu, or press **EXIT** to close the menu.

Turn Device Auto Power Off on or off

When INlink is set to **On**, **Device Auto Power Off** automatically turns off HDMI CEC devices when you turn off your TV.

- 1 Press **MENU**. The on-screen menu opens.
- 2 Press **◀** or **▶** to highlight **SETTINGS**, then press **▼** or **ENTER**. The *SETTINGS* menu opens.



- 3 Press **▲** or **▼** to highlight **INlink**, then press **ENTER**. The *SETTINGS · INlink* menu opens.

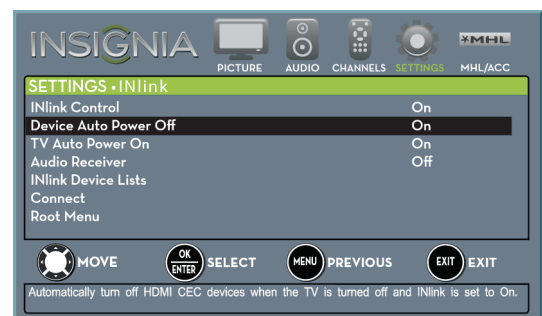

- 4 Press **▲** or **▼** to highlight **Device Auto Power Off**, then press **ENTER**.
- 5 Press **▲** or **▼** to highlight **On** (turns off the connected devices when you turn off your TV) or **Off** (does not turn off the connected devices when you turn off your TV), then press **ENTER**.
- 6 Press **MENU** to return to the previous menu, or press **EXIT** to close the menu.

Turn TV Auto Power On on or off

TV Auto Power On automatically turns on your TV when an HDMI CEC device is turned on, if the device has this feature.

- 1 Press **MENU**. The on-screen menu opens.
- 2 Press **◀** or **▶** to highlight **SETTINGS**, then press **▼** or **ENTER**. The *SETTINGS* menu opens.



- 3 Press **▲** or **▼** to highlight **INlink**, then press **ENTER**. The *SETTINGS · INlink* menu opens.



- 4 Press **▲** or **▼** to highlight **TV Auto Power On**, then press **ENTER**.
- 5 Press **▲** or **▼** to highlight **On** (turns on your TV when you turn on the connected device) or **Off** (does not turn on your TV when you turn on the connected device), then press **ENTER**.
- 6 Press **MENU** to return to the previous menu, or press **EXIT** to close the menu.

Turn Audio Receiver on or off

When **INlink** is turned on and you have connected an HDMI CEC-compatible audio receiver to your TV, turning on **Audio Receiver** lets you use your TV's remote control to control the volume on the audio receiver.

- 1 Press **MENU**. The on-screen menu opens.
- 2 Press **◀** or **▶** to highlight **SETTINGS**, then press **▼** or **ENTER**. The *SETTINGS* menu opens.



- 3 Press **▲** or **▼** to highlight **INlink**, then press **ENTER**. The *SETTINGS · INlink* menu opens.



- 4 Press **▲** or **▼** to highlight **Audio Receiver**, then press **ENTER**.
- 5 Press **▲** or **▼** to highlight **On** (your TV's remote control controls the connected audio receiver's volume) or **Off** (your TV's remote control does not control the connected audio receiver's volume), then press **ENTER**.
- 6 Press **MENU** to return to the previous menu, or press **EXIT** to close the menu.

Display a list of INlink-compatible devices

You can display a list of HDMI CEC devices that are connected to your TV.

- 1 Press **MENU**. The on-screen menu opens.
- 2 Press **◀** or **▶** to highlight **SETTINGS**, then press **▼** or **ENTER**. The **SETTINGS** menu opens.



- 3 Press **▲** or **▼** to highlight **INlink**, then press **ENTER**. The **SETTINGS · INlink** menu opens.



- 4 Press **▲** or **▼** to highlight **INlink Device Lists**, then press **ENTER**. A list of HDMI CEC-compatible devices you have connected appears.
- 5 Press **MENU** to return to the previous menu, or press **EXIT** to close the menu.

Select an INlink-compatible device

When you have more than one INlink-compatible device connected, you can select the device you want to use.

- 1 Press **MENU**. The on-screen menu opens.
- 2 Press **◀** or **▶** to highlight **SETTINGS**, then press **▼** or **ENTER**. The **SETTINGS** menu opens.



- 3 Press **▲** or **▼** to highlight **INlink**, then press **ENTER**. The **SETTINGS · INlink** menu opens.



- 4 Press **▲** or **▼** to highlight **Connect**, then press **ENTER**. A list of HDMI CEC-compatible devices you have connected opens.
- 5 Press **▲** or **▼** to highlight the device you want to connect to, then press **ENTER**.
- 6 Press **MENU** to return to the previous menu, or press **EXIT** to close the menu.

Open an INlink-compatible device's root menu

You can open an INlink-compatible device's root menu, then use your TV's remote control to control the device, if the device has this feature.

- 1 Press **INPUT**, press **▲** or **▼** to highlight the INlink-compatible device you want, then press **ENTER**.
- 2 Press **MENU**. The on-screen menu opens.
- 3 Press **◀** or **▶** to highlight **SETTINGS**, then press **▼** or **ENTER**. The *SETTINGS* menu opens.



- 4 Press **▲** or **▼** to highlight **INlink**, then press **ENTER**. The *SETTINGS · INlink* menu opens.



- 5 Press **▲** or **▼** to highlight **Root Menu**, then press **ENTER**. The device's root menu opens, and you can use your TV's remote control to control the device.
- 6 Press **MENU** to return to the previous menu, or press **EXIT** to close the menu.

Use a USB flash drive

You can connect a USB flash drive to your TV to view compatible JPEG pictures.

Notes

- Never remove the USB flash drive or turn off your TV while viewing JPEG pictures.
- The JPEG picture viewer only supports JPEG format images (with ".jpg" file extensions) and not all JPEG files are compatible with your TV.

Switch to USB mode

- 1 Make sure that you have connected the USB flash drive to the USB port on your TV.
- 2 If your TV is turned on when you connect the USB flash drive, press **▲** or **▼** to highlight **Yes** in the message that appears, then press **ENTER**. The *PHOTOS* menu opens.

OR

If you connected the USB flash drive, then changed to a different video input source, press **INPUT** to open the *INPUT SOURCE* list, press **▲** or **▼** to highlight **USB (Photos)**, then press **ENTER**. The *PHOTOS* menu opens.

Note

To exit USB mode, press **INPUT** to open the *INPUT SOURCE* list, then select another input source.

Browse photos

- 1 Switch to USB mode. See “Switch to USB mode” on page 47. The *PHOTOS* menu opens.



- 2 Press ▲ or ▼ to highlight **Browse Photos**, then press **ENTER**. The screen displays folder names and photo files stored on the USB flash drive in a thumbnail index with the first folder or file highlighted. A control bar appears at the bottom of the screen.

Note

Photos are shown in the order they appear on the USB flash drive. They may not be listed in file name order.



- 3 To navigate the thumbnail index screen, press:
 - ▲ ▼ ◀ or ▶ to browse through the files and folders.
 - **ENTER** to view a highlighted photo full-screen or open a highlighted folder.
 - **MENU** to open the *PHOTOS* menu.
 - **FAVORITE** to add or remove a photo from the favorite photo list. A heart appears on a photo that has been added to the favorite photo list.
 - Press **EXIT** to close the control bar.

When a photo is displayed full-screen, a control bar appears at the bottom of the photo. The file name, picture resolution, size, and date are displayed on the bottom of the control bar. If you do not press a button within 10 seconds, the control bar closes. Press **INFO** to open the control bar again.



- 4 To navigate on the photo screen, press:
 - ◀ to go to the previous photo.
 - ▶ to go to the next photo.
 - **ENTER** to rotate the photo clockwise.
 - **ASPECT** one or more times to enlarge the image by 2x, or 4x or to select **Fill** (to fill the screen). You can press ▲ ▼ ◀ or ▶ to pan the photo.
 - **EXIT** to return to the thumbnail index.
 - **MENU** to return to the *PHOTOS* menu.

View favorite photos

After you create your favorite photo list, you can browse among your favorite photos quickly.

- 1 Switch to USB mode. See “Switch to USB mode” on page 47. The *PHOTOS* menu opens.



- 2 Press **▲** or **▼** to highlight **Favorite Photos**, then press **ENTER**. A thumbnail index of your favorite photos opens with a control bar at the bottom of the screen. A heart appears on a favorite photo.

Note
Photos are shown in the order they appear on the USB flash drive. They may not be listed in file name order.

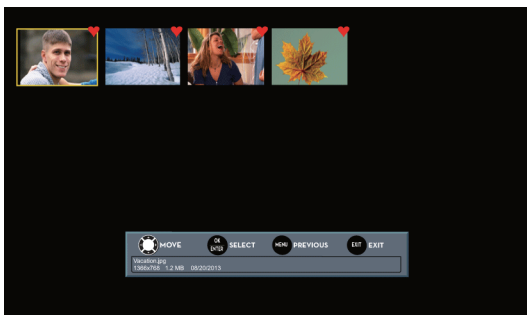

You select photos and navigate on the photo screen in the same way you do when you are browsing through photos. For more information, see “Browse photos” on page 48.

View photos in a slideshow

You can view your photos in a slideshow.

- 1 Switch to USB mode. See “Switch to USB mode” on page 47. The *PHOTOS* menu opens.
- 2 If the photos you want to view are in a folder on the USB flash drive, select the folder. For information about selecting a folder, see “Browse photos” on page 48 or “View favorite photos” on page 49.
- 3 Press **MENU**. The *PHOTOS* menu opens again.

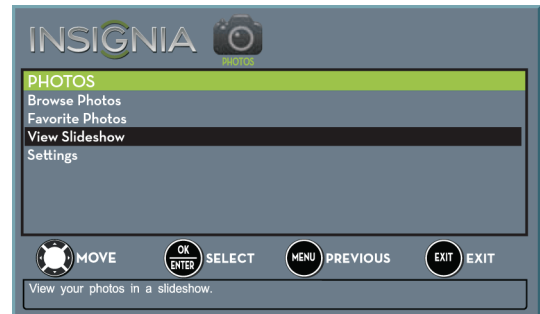

- 4 Press **▲** or **▼** to highlight **View Slideshow**, then press **ENTER**. A slideshow starts with the first photo in the current folder.
- 5 To control the slideshow:

Press...	To...
MENU OR ⬆ (home)	Press to open the <i>PHOTOS</i> menu.
◀ (left arrow) OR ◀◀ (previous)	Return to the previous photo.
▶ (right arrow) OR ▶▶ (next)	Go to the next photo.
ENTER OR ⏸ (pause)	Pause the slideshow. Press again to resume the slideshow.
▶ (play)	When paused, press to resume the slideshow.
■ (stop) OR EXIT	Press to stop the slideshow and return to the thumbnail index.

Customize slideshow settings

You can customize the slideshow settings, including **Repeat**, **Shuffle**, **Speed**, and **Transition**.

- 1 Switch to USB mode. See "Switch to USB mode" on page 47. The *PHOTOS* menu opens.



- 2 Press **▲** or **▼** to highlight **Settings**, then press **ENTER**. The *PHOTOS · SETTINGS* menu opens.

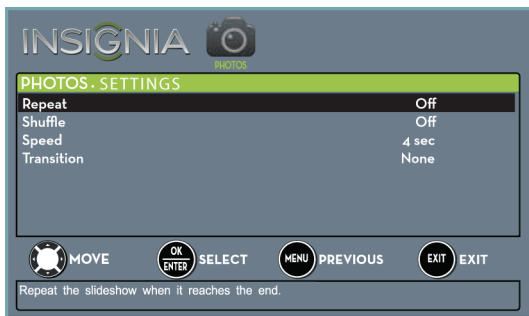

- 3 Press **▲** or **▼** to highlight an option, then press **ENTER**. You can select:
 - **Repeat**—Repeats the slideshow when it reaches the end. You can select **On** or **Off**.
 - **Shuffle**—Displays the slideshow photos in random order. You can select **On** or **Off**.
 - **Speed**—Sets the amount of time a photo is displayed before the slideshow moves to the next photo. You can select **4 Sec**, **6 Sec**, or **8 Sec**.
 - **Transition**—Selects the way photos transition when moving to the next file in the slideshow. You can select:
 - **None**—No transition effect.
 - **Fade to Black**—Fades the screen to black between photos.
 - **Vertical Wipe**—Wipes the screen from top to bottom between photos.
 - **Horizontal Wipe**—Wipes the screen from left to right between photos.
 - **Random**—Randomly selects a transition effect.
- 4 Press **EXIT** to close the menu.

Adjust the picture

Adjust the TV picture

You can adjust various settings to improve the quality of the TV picture. Also, you can reset all picture settings to the factory default.

- 1 Press **MENU**. The on-screen menu opens with the *PICTURE* menu displayed.

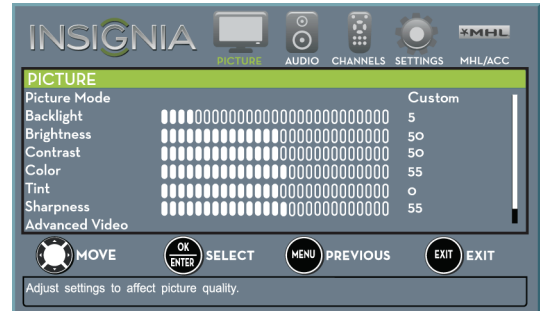

- 2 Press **▼** or **ENTER** to access the menu.
- 3 Press **▲** or **▼** to highlight an option, then press **ENTER** to access the option. You can select:
 - **Picture Mode**—Selects the picture mode. You can select:
 - **Vivid**—(a bright and vivid picture). Significantly increases the contrast, brightness, and sharpness. This selection is good for video games, animation, and in bright light environments.
 - **Standard**—(a standard picture). Moderately increases the contrast, brightness, and sharpness. This selection is good for standard TV broadcasts.
 - **Energy Savings**—(the backlight brightness is decreased). Your TV has a backlight that provides light for displaying a picture. By reducing the amount of light, your TV uses less energy.
 - **Movie**—(a finely detailed picture). Adjusts the brightness and contrast and lowers the sharpness for a more realistic picture. This selection is good for watching the highest quality video such as Blu-ray Discs, DVDs, and HDTV.
 - **Game**—Adjusts the picture for the ultimate gaming experience.

Note

Game is only available when the video input is set to **HDMI**, **Component/AV**, or **VGA**.

- **Custom**—(customized picture). Lets you manually adjust picture settings such as brightness, contrast, and sharpness.

Note

You can also press **PICTURE** to select the picture mode.

- **Backlight**—Sets the overall brilliance of the screen.
- **Brightness**—Adjusts the brightness of the dark areas of the picture.

- **Contrast**—Adjusts the brightness of the light areas of the picture.
- **Color**—Adjusts the color intensity of the picture. A low setting may make the color look faded. A high setting may make the color look artificial.
- **Tint**—Adjusts the color balance of the picture. Use this control to make skin tones look more natural.
- **Sharpness**—Adjusts the color detail of images. If you set this control too high, dark images may appear with light or white edges.
- **Advanced Video**—Opens the *PICTURE · ADVANCED VIDEO* menu where you can adjust additional video options.



- **Aspect Ratio**—Adjusts how the picture fills the screen. You can select:

Note

You can also press **ASPECT** to select the aspect ratio.

- **Overscan**—Extends text and images past the screen edges to hide edge artifacts. You can select **On** or **Off**.
 - **DCR (Dynamic Backlight)**—Enhances the contrast ratio between light and dark areas of the picture. You can select **Off**, **Low**, or **High**.
 - **Color Temperature**—Selects the color temperature. You can select **Cool** (to enhance the blues), **Normal**, or **Warm** (to enhance the reds).
 - **Noise Reduction**—Selects the noise reduction mode to reduce picture noise (snow). You can select **Off**, **Low**, **Middle**, or **High**.
 - **Adaptive Contrast**—Automatically adjusts picture detail and brightness. You can select **On** or **Off**.
 - **Reset Picture Settings**—Resets all picture settings to factory mode.
- 4 Press **◀** or **▶** to adjust the option, or press **▲** or **▼** to select a setting.
 - 5 Press **MENU** to return to the previous menu, or press **EXIT** to close the menu.

Aspect ratio options	Example
<p>Normal: Displays the image in the original aspect ratio. Black bars appear if the image is not in the widescreen (16:9) aspect ratio.</p>	
<p>Zoom: Expands the image to fill the screen. The top and bottom of the image may be cropped.</p>	
<p>Wide: Use this option to view content recorded in a 16:9 (wide-screen) aspect ratio.</p>	
<p>Cinema: Stretches the image at the edges, but keeps a clear image in the center.</p>	
<p>Auto: Automatically adjusts the image based on the screen size and the TV program. Note: Auto is only available when Auto Aspect Ratio in the CHANNELS menu is set to On.</p>	

Automatically adjust the aspect ratio

Auto Aspect Ratio automatically changes how the picture looks on the screen (aspect ratio) based on the TV program you are viewing.

- 1 Press **MENU**. The on-screen menu opens.
- 2 Press **◀** or **▶** to highlight **CHANNELS**, then press **▼** or **ENTER**. The **CHANNELS** menu opens.



- 3 Press **▲** or **▼** to highlight **Auto Aspect Ratio**, then press **ENTER**.
- 4 Press **▲** or **▼** to select **On** (automatically adjust the aspect ratio) or **Off** (does not automatically adjust the aspect ratio), then press **ENTER**.
- 5 Press **MENU** to return to the previous menu, or press **EXIT** to close the menu.

Set the power on picture mode

You can set the picture mode your TV uses when you turn it on.

- 1 Press **MENU**. The on-screen menu opens.
- 2 Press **◀** or **▶** to highlight **SETTINGS**, then press **▼** or **ENTER**. The **SETTINGS** menu opens.



- 3 Press **▲** or **▼** to highlight **Reset to Default**, then press **ENTER**. The **SETTINGS · RESET TO DEFAULT** menu opens.



- 4 Press **▲** or **▼** to highlight **Power on in Vivid Mode**, then press **ENTER**.
- 5 Press **▲** or **▼** to highlight **On** (when you turn on your TV, it will be in **Vivid** picture mode) or **Off** (when you turn on your TV, it will be in the picture mode it was in before you turned it off), then press **ENTER**.
- 6 Press **MENU** to return to the previous menu, or press **EXIT** to close the menu.

Adjust the computer image

When you connect a computer to your TV using the VGA jack, you may need to adjust the computer image to improve the quality.

Note

The **Computer Settings** option is only available when a computer is connected to the VGA jack on the back of your TV.

- 1 Make sure that your TV is in VGA mode. For more information, see "Select the video input source" on page 39.
- 2 Press **MENU**. The on-screen menu opens.
- 3 Press **◀** or **▶** to highlight **SETTINGS**, then press **ENTER**. The **SETTINGS** menu opens.



- 4 Press **▲** or **▼** to highlight **Computer Settings**, then press **ENTER**. The **SETTINGS · COMPUTER SETTINGS** menu opens.

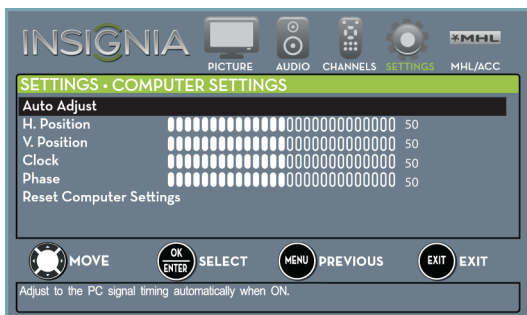

- 5 Press **▲** or **▼** to highlight an option, then press **ENTER** to access the option. You can select:
 - **Auto Adjust**—Automatically adjusts the image settings such as position and phase.
 - **H. Position**—Moves the image right or left.
 - **V. Position**—Moves the image up or down.
 - **Clock**—Minimizes vertical stripes in the screen image.
 - **Phase**—Adjusts the focus of stable images.
 - **Reset Computer Settings**—Resets all computer settings to factory mode.
- 6 Press **◀** or **▶** to adjust the option, or press **▲** or **▼** to select a setting.
- 7 Press **MENU** to return to the previous menu, or press **EXIT** to close the menu.

Adjust the sound

Adjust sound settings

You can adjust sound settings to improve the sound quality. You also can reset all sound settings to the factory default.

- 1 Press **MENU**. The on-screen menu opens.
- 2 Press **◀** or **▶** to highlight **AUDIO**, then press **▼** or **ENTER**. The **AUDIO** menu opens.

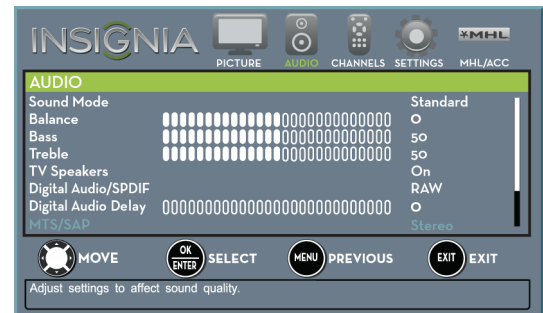

- 3 Press **▲** or **▼** to highlight an option, then press **ENTER** to access the option. You can select:
 - **Sound Mode**—Selects the sound mode. You can select:
 - **Standard**—Balances treble and bass. This setting is good for watching standard TV broadcasts.
 - **Theater**—Enhances treble and bass for a rich sound experience. This setting is good for watching DVDs, Blu-ray discs, and HDTV.
 - **Music**—Preserves the original sound. This setting is good for listening to music.
 - **News**—Enhances vocals for TV audio. This setting is good for watching news broadcasts.
 - **Custom**—Lets you manually adjust sound settings.
 - **Balance**—Adjusts the balance between the left and right audio channels.
 - **Bass**—Adjusts the low sounds.
 - **Treble**—Adjusts the high sounds.
 - **TV Speakers**—Selects where to play TV audio. When you connect headphones to your TV, audio plays through both the headphones and the TV speakers. You can select:
 - **Auto** (default setting)—Automatically turns off the TV speakers when you connect a device to the **◻/AUDIO OUT** jack. When the device is disconnected, the TV speakers turn on automatically.
 - **On**—Always plays the audio through the TV speakers. If a device is connected to the **◻/AUDIO OUT** jack, the audio is played through both the TV speakers and the device.
 - **Off**—Turns off the TV speakers and plays the audio only through the device connected to the **◻/AUDIO OUT** jack. If you disconnect the device, the TV speakers remain turned off.

- **Digital Audio/SPDIF**—Sends digital audio to an external audio system. You can select:
 - **RAW** (to pass through the original digital audio sound).
 - **PCM** (to output audio in 2-channel stereo).
- **Digital Audio Delay**—Fine tunes the audio when it is not in sync with the video.
- **MTS/SAP**—(Analog channels only) Selects the audio mode. You can select:
 - **Mono**—Select this option if there is noise or static on weak stereo broadcasts.
 - **Stereo**—Select this option for programs broadcast in stereo.
 - **SAP**—Select this option to listen to a secondary audio program, if available.

Note

You can also press **MTS/SAP** one or more times to select the audio mode.

- **Audio Language Default**—(Digital channels only) Selects an alternate audio language, if available.
 - **Headphones/Audio Out**—You can use the **⌚/AUDIO OUT** jack on the side of your TV to connect headphones, a home theater system, sound bar, or external speaker system. When a device is connected to the **⌚/AUDIO OUT** jack, the TV speakers are muted. You can select:
 - **Headphones/Audio Out Variable**—Select this option to use the remote control that came with your TV to control the audio from headphones, a home theater system, a sound bar, or an external speaker system you connected to the **⌚/AUDIO OUT** jack.
 - **Audio Out Fixed**—Select this option to use the remote control that came with the home theater system, sound bar, or external speaker system you connected to the **⌚/AUDIO OUT** jack to control the audio.
 - **Reset Audio Settings**—Reset all audio settings to factory defaults.
- 4 Press **◀** or **▶** to adjust the option, or press **▲** or **▼** to select a setting.
 - 5 Press **MENU** to return to the previous menu, or press **EXIT** to close the menu.

Select the audio out mode

If your TV is on when you connect a device to the **⌚/AUDIO OUT** jack on the side of your TV, a screen opens where you select which audio out mode you want to use.

- 1 Connect headphones, a home theater system, sound bar, or external speaker system to the **⌚/AUDIO OUT** jack on the side of your TV. The following screen opens.

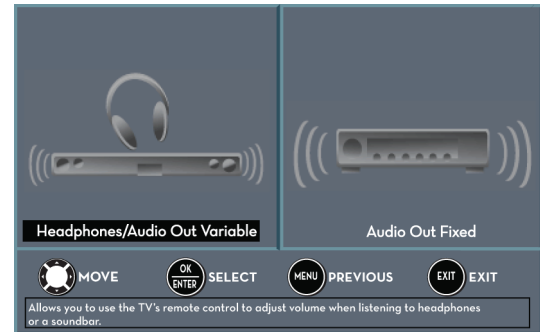

- 2 Press **◀** or **▶** to highlight the audio out mode you want to use, then press **ENTER**. You can select:
 - **Audio Out Fixed**—Select this option to use the remote control that came with the home theater system, sound bar, or external speaker system you connected to the **⌚/AUDIO OUT** jack to control the audio.

Play TV audio only

You can turn off the picture on your TV and listen to the program audio only.

- 1 Press **MENU**. The on-screen menu opens.
- 2 Press **◀** or **▶** to highlight **CHANNELS**, then press **▼** or **ENTER**. The **CHANNELS** menu opens.



- 3 Press **▲** or **▼** to highlight **Audio Only**, then press **ENTER**.
- 4 Press **▲** or **▼** to select **On**.
- 5 Press **MENU** to return to the previous menu, or press **EXIT** to close the menu.

Notes

- The picture turns off in about five seconds.
- **Audio Only** works only when the input source is TV, and your TV is receiving a broadcast signal.
- To exit audio only mode, press any button. When you exit audio only mode, the **Audio Only** option is automatically reset to **Off**.

Change channel settings

Automatically scan for channels

When you scan for channels, your TV searches for channels with signals and stores the channel information in the channel list. When you press **CH ▲** or **CH ▼**, your TV goes to the next or previous channel in the channel list.

If the TV signal source changes, for example you change from an outdoor antenna to cable TV (no box), you need to scan for channels.

- 1 Press **MENU**. The on-screen menu opens.
- 2 Press **◀** or **▶** to highlight **CHANNELS**, then press **▼** or **ENTER**. The **CHANNELS** menu opens.



- 3 Press **▲** or **▼** to highlight **Auto Channel Search**, then press **ENTER**. The **CHANNELS · AUTO CHANNEL SEARCH** screen opens.



- 4 Press **▲** or **▼** to highlight **Antenna**, **Cable Service**, or **Satellite Service**, then press **ENTER**.
 - A If you select **Antenna**, your TV scans for available channels. The scan may take several minutes.

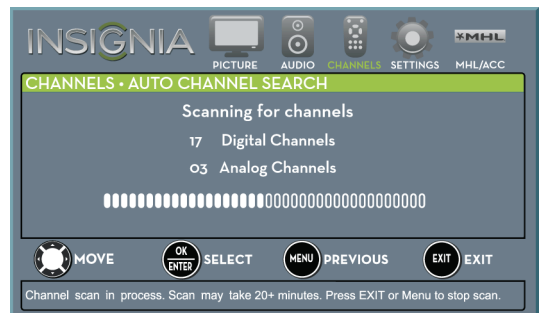

Note

You can press **EXIT** to stop the auto channel search, but you will need to run the auto channel search again to create a channel list.

B If you select **Cable Service**, a message asks if you have a cable box:

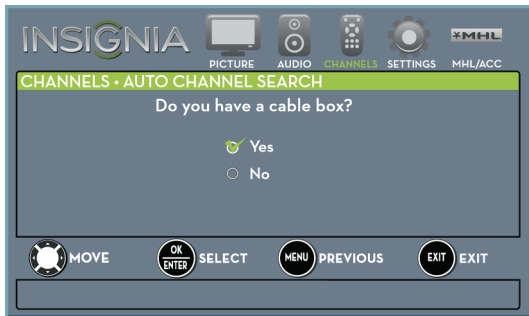

- Select **No**, then press **ENTER** if no cable box is connected. Your TV scans for available channels. The scan may take several minutes.
- Select **Yes**, then press **ENTER** if a cable box is connected. A message asks how you connected the cable box to your TV.

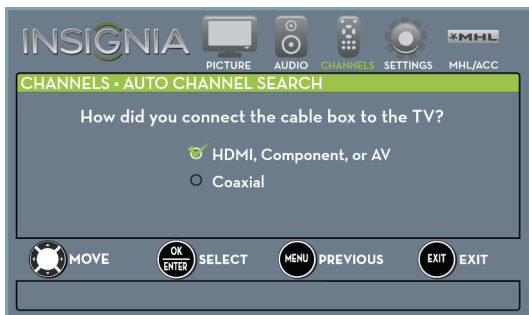

- Select **HDMI, Component, or AV**, then press **ENTER** if you connected a cable box to your TV using one of these cables. Read the message, then press **ENTER** to close the wizard.
- Select **Coaxial**, then press **ENTER** if you connected a cable box to your TV using a coaxial cable. Read the message, then press **ENTER** to start the channel scan (VHF channels only).

Note

You can press **EXIT** to stop the auto channel search, but you will need to run the auto channel search again to create a channel list.

C If you select **Satellite Service**, a message asks how you connected the satellite box to your TV:

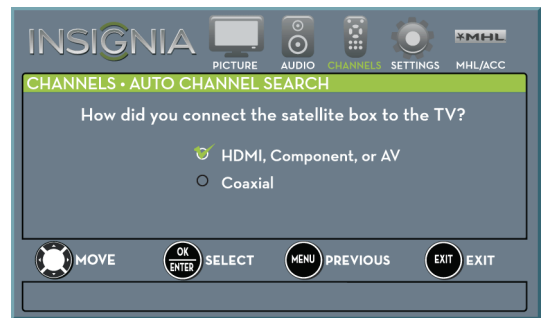

- Select **HDMI, Component, or AV**, then press **ENTER** if you connected a satellite box to your TV using one of these cables. Read the message, then press **ENTER** to close the wizard.
- Select **Coaxial**, then press **ENTER** if you connected a satellite box to your TV using a coaxial cable. Read the message, then press **ENTER** to start the channel scan (VHF channels only).

Note

You can press **EXIT** to stop the auto channel search, but you will need to run the auto channel search again to create a channel list.

Hide channels

You can hide channels in the channel list. When you press **CH** \wedge or **CH** \vee , your TV skips the hidden channels. You can still tune to a hidden channel by pressing the number buttons for the channel.

- 1 Press **MENU**. The on-screen menu opens.
- 2 Press \blacktriangleleft or \blacktriangleright to highlight **CHANNELS**, then press \blacktriangledown or **ENTER**. The **CHANNELS** menu opens.



- 3 Press \blacktriangleup or \blacktriangledown to highlight **Add/Skip Channels**, then press **ENTER**. The **CHANNELS · ADD/SKIP CHANNELS** screen opens.



- 4 Press \blacktriangleup \blacktriangledown \blacktriangleleft or \blacktriangleright to highlight the channel you want to hide, then press **ENTER**. The check mark disappears.

Notes

- If you highlight a channel in the list for two to four seconds, your TV displays the channel in the background.
- A channel with a check mark is not hidden. A channel with no check mark is hidden.
- If the list has more than one page, press \blacktriangleup or \blacktriangledown to scroll through the pages.

- 5 Press **MENU** to return to the previous menu, or press **EXIT** to close the menu.

Set up a favorite channel list

You can create a favorite channel list so you can quickly browse through your favorite channels by pressing **FAVORITE**, then selecting a channel from the favorite channel list.

- 1 Press **MENU**. The on-screen menu opens.
- 2 Press \blacktriangleleft or \blacktriangleright to highlight **CHANNELS**, then press \blacktriangledown or **ENTER**. The **CHANNELS** menu opens.



- 3 Press \blacktriangleup or \blacktriangledown to highlight **Favorites**, then press **ENTER**. The **CHANNELS · FAVORITES** screen opens.



- 4 Press \blacktriangleup \blacktriangledown \blacktriangleleft or \blacktriangleright to highlight the channel you want to add to the favorites list, then press **ENTER**. A check mark appears next to the channel.

Notes

- If you highlight a channel in the list for two to four seconds, your TV displays the channel in the background.
- To remove a channel from the favorites list, highlight the channel, then press **ENTER**. The check mark disappears and the channel is removed from the list.
- If the list has more than one page, press \blacktriangleup or \blacktriangledown to scroll through the pages.

- 5 Press **MENU** to return to the previous menu, or press **EXIT** to close the menu.

View a favorite channel

- 1 Press **FAVORITE**. The favorite channel list opens.
- 2 Press \blacktriangleup or \blacktriangledown to highlight a channel, then press **ENTER**.

Add or change a channel label

If a channel is not already labeled, you can label the channel to make it easier to identify. You can also relabel a channel that is already labeled.

- 1 Press **MENU**. The on-screen menu opens.
- 2 Press **◀** or **▶** to highlight **CHANNELS**, then press **▼** or **ENTER**. The **CHANNELS** menu opens.



- 3 Press **▲** or **▼** to highlight **Channel Labels**, then press **ENTER**. The **CHANNELS · CHANNEL LABELS** screen opens with the channel number field highlighted.

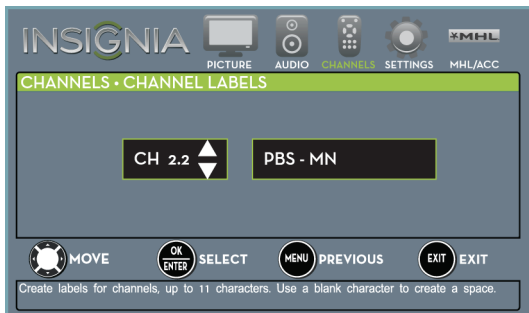

- 4 Press **▲** or **▼** to select the channel you want to label, then press **▶** to move to the channel label field.

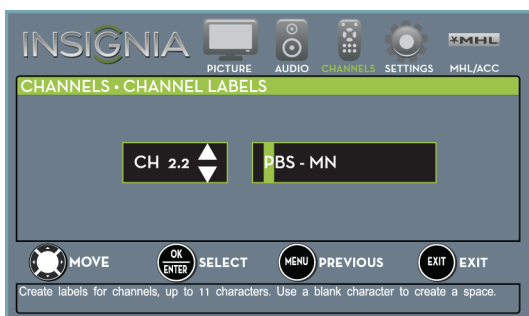

- 5 Press **▲** or **▼** to select a character, then press **◀** or **▶** to move to the previous or next character position. Repeat this step to enter additional characters. You can enter as many as 11 characters.
- 6 When you have completed the label, press **ENTER**.
- 7 Press **EXIT** to close the menu.

Check the digital signal strength

You can check the digital signal strength to determine if you need to adjust your antenna or digital cable input. The higher the signal strength, the less likely you are to experience picture degradation.

- 1 Press **MENU**. The on-screen menu opens.
- 2 Press **◀** or **▶** to highlight **CHANNELS**, then press **▼** or **ENTER**. The **CHANNELS** menu opens.



- 3 Press **▲** or **▼** to highlight **Channel Strength**, then press **ENTER**. The **Channel Strength** screen opens showing the signal strength meter.



- 4 Press **MENU** to return to the previous menu, or press **EXIT** to close the menu.

Set parental controls

Parental controls let you prevent your children from watching inappropriate material on TV. When set, parental controls read the rating of the program (with some exceptions, such as news and sports) and deny access to programs that exceed the ratings level you select. To watch programs that exceed the selected rating, you must enter a password.

Set or change the password

- 1 Press **MENU**. The on-screen menu opens.
- 2 Press **◀** or **▶** to highlight **SETTINGS**, then press **▼** or **ENTER**. The *SETTINGS* menu opens.



- 3 Press **▲** or **▼** to highlight **Parental Controls**, then press **ENTER**. The *Enter password* screen opens.



- 4 Press the number buttons to enter the four-digit password. The default password is **0000**. You should change the password to a number you can remember. The *SETTINGS · PARENTAL CONTROLS* menu opens.



- 5 Press **▲** or **▼** to highlight **Change Password**, then press **ENTER**. The *SETTINGS · PARENTAL CONTROLS · CHANGE PASSWORD* screen opens.



- 6 Press the number buttons to enter a password, then enter the password again. A message tells you that the password has been changed.

Note

If you forget your password, enter **9999**.

- 7 Press **MENU** to return to the previous menu, or press **EXIT** to close the menu.

Lock control buttons

When the button lock is turned **On**, the buttons on the side of your TV are locked, and you can only operate your TV using the remote control.

- 1 Press **MENU**. The on-screen menu opens.
- 2 Press **◀** or **▶** to highlight **SETTINGS**, then press **▼** or **ENTER**. The *SETTINGS* menu opens.



- 3 Press **▲** or **▼** to highlight **Parental Controls**, then press **ENTER**. The *Enter password* screen opens.



- 4 Press the number buttons to enter the four-digit password. The *SETTINGS · PARENTAL CONTROLS* menu opens.



- 5 Press **▲** or **▼** to highlight **Button Lock**, then press **ENTER**.
- 6 Press **▲** or **▼** to select **On** (locks the buttons) or **Off** (unlocks the buttons).
- 7 Press **MENU** to return to the previous menu, or press **EXIT** to close the menu.

Block unrated TV

Some TV programs, such as news and sports shows are not rated. When **Block Unrated TV** is turned on, TV programs that do not have ratings are blocked. When you try to watch a blocked program, you are prompted to enter the parental controls password.

- 1 Press **MENU**. The on-screen menu opens.
- 2 Press **◀** or **▶** to highlight **SETTINGS**, then press **▼** or **ENTER**. The *SETTINGS* menu opens.



- 3 Press **▲** or **▼** to highlight **Parental Controls**, then press **ENTER**. The *Enter password* screen opens.



- 4 Press the number buttons to enter the four-digit password. The *SETTINGS · PARENTAL CONTROLS* menu opens.



- 5 Press **▲** or **▼** to highlight **Block Unrated TV**, then press **ENTER**.
- 6 Press **▲** or **▼** to select **On** (to block unrated TV) or **Off** (to unblock unrated TV).
- 7 Press **MENU** to return to the previous menu, or press **EXIT** to close the menu.

Set parental control levels

You can set parental controls for the U.S. and Canada.

U.S. rating levels

U.S. TV ratings	
NONE	Not rated
TV-Y	All children
TV-Y7	Suitable for children 7 and older
TV-G	General audiences
TV-PG	Parental guidance suggested
TV-14	Parental guidance strongly suggested
TV-MA	Mature audiences only

Some of the age-based TV Parental Guidelines ratings also have content-based ratings.

U.S. TV content ratings	
All	All ratings are blocked
FV	Fantasy violence
L	Strong language
S	Sexual situations
V	Violence
D	Suggestive dialog

U.S. movie (MPAA) ratings	
None	Movie not rated
G	General audiences
PG	Parental guidance suggested
PG-13	Suitable for children 13 and older
R	Parental guidance suggested for children under 17
NC-17	Not suitable for children under 17
X	Adults only

Canadian rating levels

Canadian English ratings	
E	Exempt programming
C	Suitable for all children
C8+	Suitable for children 8 and older
G	General audiences
PG	Parental guidance suggested
14+	Suitable for children 14 and older
18+	Adult only

Canadian French ratings	
E	Exempt programming
G	General audiences
8ans+	Suitable for children 8 and older
13ans+	Suitable for children 13 and older
16ans+	Suitable for children 16 and older
18ans+	Adult only

- 1 Press **MENU**. The on-screen menu opens.
- 2 Press **◀** or **▶** to highlight **SETTINGS**, then press **▼** or **ENTER**. The **SETTINGS** menu opens.



- 3 Press **▲** or **▼** to highlight **Parental Controls**, then press **ENTER**. The **Enter password** screen opens.



- 4 Press the number buttons to enter the four-digit password. The **SETTINGS · PARENTAL CONTROLS** menu opens.



- Press **▲** or **▼** to highlight **USA Parental Locks**, then press **ENTER**. (To set Canadian ratings, select **Canadian Parental Locks**.)

USA Parental Locks



Canadian Parental Locks



- Press **◀** or **▶** to highlight:
 - **Movie Ratings** or **TV Ratings** for USA ratings.
 - **Canadian English** or **Canadian French** for Canadian ratings.
- Press **▲** or **▼** to select the rating. If a rating has sub-ratings, press **◀** or **▶** to highlight a sub-rating.

Note
When you block a rating, that rating and all higher ratings are blocked.

- Press **ENTER** to confirm. A lock symbol appears when a rating is blocked.
- Press **MENU** to return to the previous menu, or press **EXIT** to close the menu.

Download rating information

If the program you are viewing has downloadable rating information, you can download the information to use when setting parental controls.

Note
If the program you are viewing does not have RRT5 rating information, RRT5 is grayed on the **SETTINGS · PARENTAL CONTROLS** menu and cannot be selected.

- Press **MENU**. The on-screen menu opens.
- Press **◀** or **▶** to highlight **SETTINGS**, then press **▼** or **ENTER**. The **SETTINGS** menu opens.



- Press **▲** or **▼** to highlight **Parental Controls**, then press **ENTER**. The **Enter password** screen opens.



- Press the number buttons to enter the four-digit password. The **SETTINGS · PARENTAL CONTROLS** menu opens.



- Press **▲** or **▼** to highlight **RRT5**, then press **ENTER**. The **SETTINGS · PARENTAL CONTROLS · RRT5** screen opens. The screen that opens may vary depending on the broadcaster.

- 6 Press **▲▼◀▶** to select the program and content types you want to block, then press **ENTER**. The *SETTINGS · PARENTAL CONTROLS* menu opens.
- 7 To reset the RRT5 information to the factory default, press **▲** or **▼** to highlight **Reset RRT5**.



- 8 Press **ENTER**. A box opens.
- 9 Press **▲** or **▼** to highlight **Yes** or **No**, then press **ENTER**.
- 10 Press **MENU** to return to the previous menu, or press **EXIT** to close the menu.

Use closed captioning

Closed captioning displays a text version of the TV program audio or displays information provided by the broadcaster.

Turn closed captioning on or off

- 1 Press **MENU**. The on-screen menu opens.
- 2 Press **◀▶** to highlight **SETTINGS**, then press **▼** or **ENTER**. The *SETTINGS* menu opens.



- 3 Press **▲▼** to highlight **Closed Caption**, then press **ENTER**. The *SETTINGS · CLOSED CAPTION* menu opens.



- 4 Press **▲▼** to highlight **Caption Control**, then press **ENTER**. A menu opens.
- 5 Press **▲▼** to select **CC Off** (turns off closed captioning), **CC On** (turns on closed captioning), or **CC on when mute** (turns on closed captioning when the sound is muted).
- 6 Press **MENU** to return to the previous menu, or press **EXIT** to close the menu.

Note

You can also press **CCD** to turn closed captioning on or off.

Select the analog closed captioning mode

Analog channels usually have one or more closed captioning modes. The CC1 mode usually displays a text version of the TV program audio in a small banner. The other CC modes display information provided by the broadcaster. The Text modes display information in a box that covers half of the screen.

- 1 Press **MENU**. The on-screen menu opens.
- 2 Press **◀** or **▶** to highlight **SETTINGS**, then press **▼** or **ENTER**. The **SETTINGS** menu opens.



- 3 Press **▲** or **▼** to highlight **Closed Caption**, then press **ENTER**. The **SETTINGS · CLOSED CAPTION** menu opens.

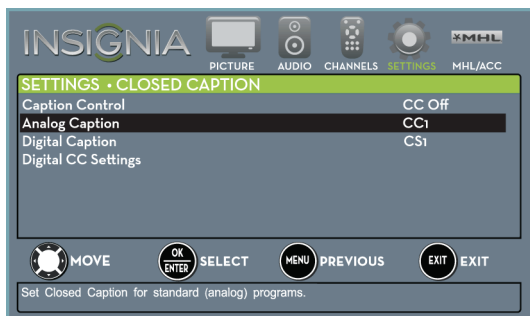

- 4 Press **▲** or **▼** to highlight **Analog Caption**, then press **ENTER**. A menu opens.
- 5 Press **▲** or **▼** to select an analog caption setting. You can select:
 - **CC1** through **CC4**—Closed captioning appears in a small banner across the bottom of the screen. **CC1** is usually the “printed” version of the audio. **CC2** through **CC4** display content provided by the broadcaster.
 - **Text1** through **Text4**—Closed captioning covers half or all of the screen. **Text1** through **Text4** display content provided by the broadcaster.
- 6 Press **MENU** to return to the previous menu, or press **EXIT** to close the menu.

Select the digital closed captioning mode

Digital channels usually have one or more closed captioning modes. The CC1 mode usually displays a text version of the TV program audio in a small banner. The other CC modes display information provided by the broadcaster. CS1 mode displays a text version of the audio in the same language as the audio.

- 1 Press **MENU**. The on-screen menu opens.
- 2 Press **◀** or **▶** to highlight **SETTINGS**, then press **▼** or **ENTER**. The **SETTINGS** menu opens.

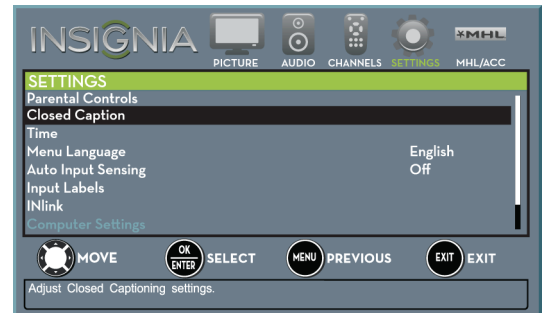

- 3 Press **▲** or **▼** to highlight **Closed Caption**, then press **ENTER**. The **SETTINGS · CLOSED CAPTION** menu opens.

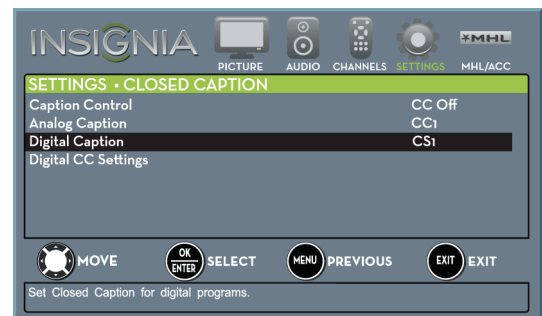

- 4 Press **▲** or **▼** to highlight **Digital Caption**, then press **ENTER**. A menu opens.
- 5 Press **▲** or **▼** to select a digital caption setting. You can select:
 - **CS1** through **CS6**—CS1 is usually the “printed” version of the audio. CS2 through CS6 display content provided by the broadcaster. You can change the way digital closed captioning is displayed on the screen. For more information, see “[Customize digital closed captioning settings](#)” on page 65.
 - **CC1** through **CC4**—Closed captioning appears in a small banner across the bottom of the screen. **CC1** is usually the “printed” version of the audio. **CC2** through **CC4** display content provided by the broadcaster.
- 6 Press **MENU** to return to the previous menu, or press **EXIT** to close the menu.

Customize digital closed captioning settings

- 1 Press **MENU**. The on-screen menu opens.
- 2 Press **◀** or **▶** to highlight **SETTINGS**, then press **▼** or **ENTER**. The *SETTINGS* menu opens.
- 3 Press **MENU** to return to the previous menu, or press **EXIT** to close the menu.



- 4 Press **▲** or **▼** to highlight **Closed Caption**, then press **ENTER**. The *SETTINGS · CLOSED CAPTION* menu opens.

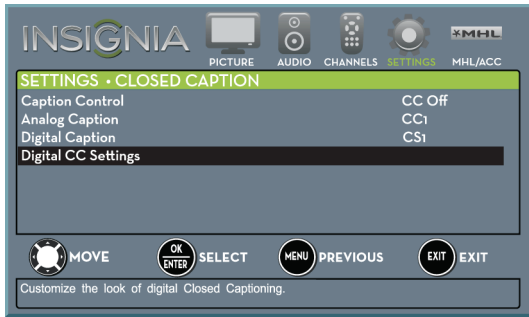

- 5 Press **▲** or **▼** to highlight **Digital CC Settings**, then press **ENTER**. The *SETTINGS · CLOSED CAPTION · DIGITAL CC SETTINGS* menu opens with **Style** highlighted.

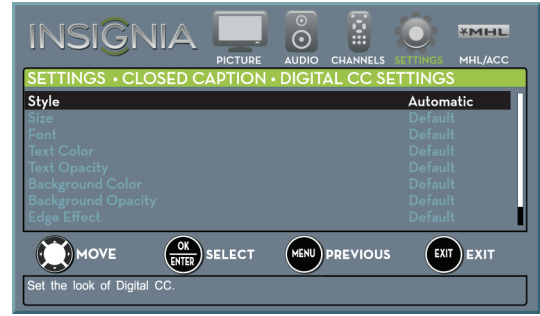

- 6 Press **ENTER**, then press **▲** or **▼** to select **Custom**.
- 7 Press **▲** or **▼** to highlight an option, then press **ENTER**. You can select:
 - **Size**—Selects the font size.
 - **Font**—Selects the font style.
 - **Text Color**—Selects the color for the words.
 - **Text Opacity**—Selects the opacity level for the words.
 - **Background Color**—Selects the color for the background.
 - **Background Opacity**—Selects the opacity level for the background.
 - **Edge Effect**—Selects the style of the letter edge.
 - **Edge Color**—Selects the color of the letter edge.
- 8 Press **MENU** to return to the previous menu, or press **EXIT** to close the menu.

Adjust time settings

When you set up your TV for the first time, the clock was set up. If you move your TV to a different time zone, you need to reset the clock to the correct time.

Set the clock

- 1 Press **MENU**. The on-screen menu opens.
- 2 Press **◀** or **▶** to highlight **SETTINGS**, then press **▼** or **ENTER**. The **SETTINGS** menu opens.



- 3 Press **▲** or **▼** to highlight **Time**, then press **ENTER**. The **SETTINGS · TIME** menu opens.



- 4 Press **▲** or **▼** to highlight **Date/Time**, then press **ENTER**. The **SETTINGS · TIME · DATE/TIME** menu opens.



- 5 Press **▲** or **▼** to highlight **Mode**, then press **ENTER**. A menu opens.
- 6 Press **▲** or **▼** to highlight **Manual** (to set the options manually) or **Auto** (the options are automatically set by the TV signal source), then press **ENTER**.
- 7 Press **▲** or **▼** to highlight **Time Zone**, then press **ENTER**. A menu opens.
- 8 Press **▲** or **▼** to select your time zone, then press **ENTER**. You can select **Eastern, Central, Mountain, Pacific, Alaska, Hawaii, Atlantic, or Newfoundland**.
- 9 If your viewing area observes Daylight Saving Time, press **▲** or **▼** to highlight **Daylight Saving**, then press **ENTER**.
- 10 Press **▲** or **▼** to select **On** or **Off**, then press **ENTER** to close the menu.
- 11 If you selected **Manual** for **Mode**:
 - Press **▲** or **▼** to highlight **Year, Month, or Day**, then press **▶** to access the setting. Press **▲** or **▼** to adjust the setting, then press **ENTER**.
 - Press **▲** or **▼** to highlight **Time**, then press **▶** to access the setting. Press **◀** or **▶** to highlight the hour, minute, or AM/PM field, then press **▲** or **▼** to adjust the setting. When you are finished, press **ENTER**.
- 12 Press **MENU** to return to the previous menu, or press **EXIT** to close the menu.

Set the sleep timer

You can specify the amount of time before your TV automatically turns off.

- 1 Press **MENU**. The on-screen menu opens.
- 2 Press **◀** or **▶** to highlight **SETTINGS**, then press **▼** or **ENTER**. The **SETTINGS** menu opens.

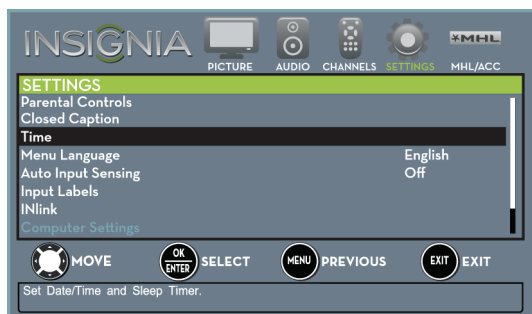

- 3 Press **▲** or **▼** to highlight **Time**, then press **ENTER**. The **SETTINGS · TIME** menu opens.



- 4 Press **▲** or **▼** to highlight **Sleep Timer**, then press **ENTER**. A menu opens.
- 5 Press **▲** or **▼** to select the amount of time before your TV turns off automatically. You can select **Off, 5, 10, 15, 30, 60, 90, 120, 180, or 240** minutes.

To turn off the sleep timer, select **Off**.

- 6 Press **MENU** to return to the previous menu, or press **EXIT** to close the menu.

Note

You can also press **SLEEP** to set the sleep timer.

Adjust menu settings

Select the menu language

Your TV can display the on-screen menu in English, French, or Spanish. When you set up your TV for the first time, you selected the language. You can change the menu language to a different language.

- 1 Press **MENU**. The on-screen menu opens.
- 2 Press **◀** or **▶** to highlight **SETTINGS**, then press **▼** or **ENTER**. The **SETTINGS** menu opens.



- 3 Press **▲** or **▼** to highlight **Menu Language**, then press **ENTER**. A menu opens.
- 4 Press **▲** or **▼** to highlight a language, then press **ENTER**. You can select **English, Français, or Español**.
- 5 Press **MENU** to return to the previous menu, or press **EXIT** to close the menu.

Label an input source

You can add a label to an input source to make it easier to identify.

- 1 Press **MENU**. The on-screen menu opens.
- 2 Press **◀** or **▶** to highlight **SETTINGS**, then press **▼** or **ENTER**. The *SETTINGS* menu opens.



- 3 Press **▲** or **▼** to highlight **Input Labels**, then press **ENTER**. The *SETTINGS · INPUT LABELS* screen opens with the input source field highlighted.



- 4 Press **▲** or **▼** to select the input source you want to label, then press **▶** to move to the label field.



- 5 Press **▲** or **▼** to select a character, then press **◀** or **▶** to move to the previous or next character position. Repeat this step to enter additional characters.
- 6 When you have completed the label, press **ENTER** to save your label. The next time you press **INPUT**, your label will appear in the *INPUT SOURCE* list.
- 7 Press **MENU** to return to the previous menu, or press **EXIT** to close the menu.

Turn Input Sensor on or off

When the Input Sensor feature is turned on, your TV automatically detects which video jacks have devices connected to them and turned on. Your TV uses this information to determine what options you can select on the *INPUT SOURCE* list when you press **INPUT**.

- 1 Press **MENU**. The on-screen menu opens.
- 2 Press **◀** or **▶** to highlight **SETTINGS**, then press **▼** or **ENTER**. The *SETTINGS* menu opens.



- 3 Press **▲** or **▼** to highlight **Auto Input Sensing**, then press **ENTER**. A menu opens.
- 4 Press **▲** or **▼** to select **On** (turns on the input sensor) or **Off** (turns off the input sensor).
- 5 Press **MENU** to return to the previous menu, or press **EXIT** to close the menu.

Maintenance

- Do not use your TV in areas that are too hot or too cold, because the cabinet may warp or the screen may malfunction. Your TV works best in temperatures that are comfortable to you.
- Storage temperatures are 32° to 122°F (0° to 50°C).
- Working temperatures are 41° to 104°F (5° to 40°C).
- Do not place your TV in direct sunlight or near a heat source.

Clean the TV cabinet

Clean the cabinet with a soft, lint-free cloth. If the cabinet is especially dirty, moisten a soft, lint-free cloth in a weak detergent solution, squeeze the excess moisture from the cloth, then wipe the cabinet with the cloth. Use a clean cloth to dry the cabinet.

Clean the TV screen

Clean the screen with a soft, lint-free cloth.

Troubleshoot

Warning

Do not try to repair your TV yourself.
Contact authorized service personnel.

Restore settings to the defaults

When you restore default settings, all the settings you have customized (including parental controls) are reset.

- 1 Press **MENU**. The on-screen menu opens.
- 2 Press **◀** or **▶** to highlight **SETTINGS**, then press **▼** or **ENTER**. The **SETTINGS** menu opens.



- 3 Press **▲** or **▼** to highlight **Reset to Default**, then press **ENTER**. The **SETTINGS · RESET TO DEFAULT** menu opens.



- 4 Press **▲** or **▼** to highlight **Reset to Default**, then press **ENTER**. A message asks if you want to reset all TV settings to the default settings.
- 5 Press **▲** or **▼** to select **Yes** (to reset) or **No** (to not reset), then press **ENTER**.

If you select Yes, your TV turns off, then turns on again. The **TV SETUP** wizard opens.

- 6 Go through the **TV SETUP** wizard. For more information, see "Turn on your TV for the first time" on page 37.

View system information

You may need to view system information during troubleshooting.

- 1 Press **MENU**. The on-screen menu opens.
- 2 Press **◀** or **▶** to highlight **SETTINGS**, then press **▼** or **ENTER**. The **SETTINGS** menu opens.



- 3 Press **▲** or **▼** to highlight **System Info**, then press **ENTER**. **SETTINGS · UPDATE FIRMWARE** menu opens.



- 4 Press **▲** or **▼** to highlight **System Info**, then press **ENTER**. Information about the TV software version is displayed.
- 5 Press **MENU** to return to the previous menu, or press **EXIT** to close the menu.

Update the TV firmware

If your TV is behaving oddly and you have tried all the solutions in the troubleshooting pages, you may need to update the TV firmware.

Cautions

- Make sure that you have tried all other solutions before you upgrade the firmware.
- While the firmware is updating, do not turn off your TV.

Note

- To update the TV firmware, you need a:
- Computer with an available USB port
 - High-speed Internet connection
 - USB flash drive

- 1 Go to www.insigniaproducts.com, then click **Support & Service**. Enter your model number in the box under **Manual, Firmware, Drivers & Product Information**, then click ►.
- 2 Follow the instructions in the *Firmware Installation Guide* on the Insignia website to download the firmware update and copy it to a USB flash drive.
- 3 Plug the USB flash drive into the **USB** port on the side of your TV.
- 4 Press **MENU**. The on-screen menu opens.
- 5 Press ◀ or ▶ to highlight **SETTINGS**, then press ▼ or **ENTER**. The *SETTINGS* menu opens.



- 6 Press ▲ or ▼ to highlight **System Info**, then press **ENTER**. The *SETTINGS · UPDATE FIRMWARE* menu opens.



- 7 Press ▲ or ▼ to highlight **Update Firmware**, then press **ENTER**. A message asks if you want to update the TV firmware.

- 8 Highlight **Yes**, then press **ENTER**.

If you have plugged in a USB flash drive with the firmware update, the firmware update starts automatically. Otherwise, a screen opens with instructions about how to download the update. Follow the instructions, then press **ENTER**.

While your TV installs the firmware update, your TV displays a status screen. **Do not turn off your TV until the update is complete.**

- 9 When the update is complete, unplug the USB flash drive, then press **ENTER**. Your TV turns off then on to complete the update.
- 10 If the channel list has been deleted, you need to scan for channels. For more information, see *"Automatically scan for channels"* on page 55.

Note

- If you see a message that says the firmware file is incorrect, make sure that you have downloaded the correct file for your model.
- If you see a message that says the update failed or the TV screen is blank and the power LED is blinking red then blue, turn off your TV, it back on, then run the upgrade again.

Video and audio

Problem	Solution
Picture does not fill the screen. There are black bars around the picture.	<ul style="list-style-type: none"> Change the aspect ratio. An increasing amount of digital TV and movies are presented in wide screen (16:9). See the "Aspect Ratio" option in "Adjust the TV picture" on page 50.
No picture (screen is not lit) and no sound.	<ul style="list-style-type: none"> Press on the TV or the remote control. Make sure that the Audio Only option is set to Off. See "Play TV audio only" on page 55. Make sure that the video cables are connected securely to your TV. Adjust the contrast and brightness. See "Adjust the TV picture" on page 50. Make sure that the power cord is plugged in. Make sure that the correct video input source is selected. See "Select the video input source" on page 39. Try another channel. The station may be experiencing problems. Make sure that the incoming signal is compatible. Make sure that the antenna or cable TV is connected correctly and securely. See "Connect a cable or satellite box" on page 13 or "Connect an antenna or cable TV (no box)" on page 18. Check the closed caption settings. Some TEXT modes can block the screen. See "Select the analog closed captioning mode" on page 64 or "Select the digital closed captioning mode" on page 64.

Problem	Solution
Dark, poor, or no picture (screen is lit), but sound is good.	<ul style="list-style-type: none"> Try another channel. The station may be experiencing problems. Make sure that the antenna or cable TV is connected correctly and securely. See "Connect a cable or satellite box" on page 13 or "Connect an antenna or cable TV (no box)" on page 18. Adjust the brightness. See "Adjust the TV picture" on page 50. Change to a different picture mode. See "Adjust the TV picture" on page 50. If you are using an antenna, the digital channel signal may be low. To check the digital channel signal strength, see "Check the digital signal strength" on page 58. If you are using an antenna and the signal strength is low, adjust the antenna or use a highly directional outdoor antenna or set-top antenna with a built-in amplifier. Make sure that the video cables are connected securely to your TV. The video cable(s) you are using may be bad. Try a new set. Try another channel. The station may be experiencing problems.
No color, dark picture, or color is not correct.	<ul style="list-style-type: none"> Try another channel. The station may be experiencing problems. Adjust the color settings. See "Adjust the TV picture" on page 50. Make sure that the video cables are connected correctly and securely to your TV. Make sure that the antenna or cable TV is connected correctly and securely. See "Connect a cable or satellite box" on page 13 or "Connect an antenna or cable TV (no box)" on page 18. If you are using an antenna, the digital channel signal may be low. To check the digital channel signal strength, see "Check the digital signal strength" on page 58. If you are using an antenna and the signal strength is low, adjust the antenna or use a highly directional outdoor antenna or set-top antenna with a built-in amplifier.

Problem	Solution
Only snow (noise) appears on the screen.	<ul style="list-style-type: none"> • Try another channel. The station may be experiencing problems. • Make sure that the antenna or cable TV is connected correctly and securely. See “Connect a cable or satellite box” on page 13 or “Connect an antenna or cable TV (no box)” on page 18. • If you are using an antenna, the digital channel signal may be low. To check the digital channel signal strength, see “Check the digital signal strength” on page 58. • If you are using an antenna and the signal strength is low, adjust the antenna or use a highly directional outdoor antenna or set-top antenna with a built-in amplifier.
Picture quality is good on some channels and poor on others. Sound is good.	<ul style="list-style-type: none"> • The problem may be caused by a poor or weak signal from the broadcaster or cable TV provider. • If you connect to cable without a set-top box and experience poor picture quality, you may need to install a set-top box to improve signal reception and picture quality. Contact your cable TV provider about upgrading to a set-top box.

Problem	Solution
Dotted lines or stripes appear on the screen.	<ul style="list-style-type: none"> • Make sure that the antenna or cable TV is connected correctly and securely. See “Connect a cable or satellite box” on page 13 or “Connect an antenna or cable TV (no box)” on page 18. • If you are using an antenna, the digital channel signal may be low. To check the digital channel signal strength, see “Check the digital signal strength” on page 58. • If you are using an antenna and the signal strength is low, adjust the antenna or use a highly directional outdoor antenna or set-top antenna with a built-in amplifier. • Make sure that the video cables are connected securely to your TV. • The video cable(s) you are using may be bad. Try a new set. • Other devices (for example, a surround sound receiver, external speakers, fans, or hair dryers) may be interfering with your TV. Try turning off one device at a time to determine which device is causing interference. After you have determined which device is causing interference, move it further from the TV to eliminate the interference.
Double images.	<ul style="list-style-type: none"> • Use a highly directional outdoor antenna, cable TV, or satellite TV.
The picture has a few bright or dark spots.	<ul style="list-style-type: none"> • A few bright or dark spots on an LCD screen is normal. It does not affect the operation of your TV.

Problem	Solution
Good picture, but no sound.	<ul style="list-style-type: none"> • Increase the volume. • Make sure that the sound is not muted. • Make sure that you do not have headphones connected. When headphones are connected, no sound comes from the TV speakers. • Change to a different audio mode. • If you are using a home theater system, sound bar, or external speaker system, make sure it is turn on and is not muted. • If you are using a home theater system, sound bar, or external speaker system and have connected it with a digital optical cable, set the Digital Audio/SPDIF option on the AUDIO menu to PCM. See the Digital Audio/SPDIF option in “Adjust sound settings” on page 53. Make sure that the audio cables are connected correctly and securely to your TV. • Make sure that the antenna or cable TV is connected correctly and securely. See “Connect a cable or satellite box” on page 13 or “Connect an antenna or cable TV (no box)” on page 18. • If you are using an antenna, the digital channel signal may be low. To check the digital channel signal strength, see “Check the digital signal strength” on page 58. • The audio cables you are using may be bad. Try a new set.
Poor picture.	<ul style="list-style-type: none"> • Make sure that the room is not too bright. Light reflecting off the screen can make the picture difficult to see. • If an S-VHS camera or a camcorder is connected while another connected device is turned on, the picture may be poor. Turn off one or more devices.
Good sound, but poor color.	<ul style="list-style-type: none"> • Adjust the contrast, color, and brightness settings. See “Adjust the TV picture” on page 50.

Problem	Solution
Audio noise.	<ul style="list-style-type: none"> • Other devices (for example, a surround sound receiver, external speakers, fans, or hair dryers) may be interfering with your TV. Try turning off one device at a time to determine which device is causing interference. After you have determined which device is causing interference, move it further from the TV to eliminate the interference.
No output from one of the speakers.	<ul style="list-style-type: none"> • Adjust the audio balance. See “Adjust sound settings” on page 53. • Make sure that the audio cables are connected correctly and securely to your TV.
After images appear.	<ul style="list-style-type: none"> • Do not display a still image, such as a logo, game, or computer image, for an extended period of time. This can cause a permanent after-image to be burned into the screen. This type of damage is not covered by your warranty.

Remote control

Problem	Solution
Remote control does not work.	<ul style="list-style-type: none"> • Make sure that the power cord is correctly connected to your TV and a power outlet. • Make sure that there are no obstructions between the remote control and the remote control sensor on the front of the TV. • Point the remote control directly at the remote control sensor on your TV. For the location of the remote control sensor, see “Front” on page 8. • The supplied batteries are wrapped tightly in clear plastic. Make sure that you have removed this plastic from the batteries. • Make sure that the batteries are installed correctly. See “Install remote control batteries” on page 36. • Replace dead batteries with new batteries. See “Install remote control batteries” on page 36.

Problem	Solution
Trouble programming your existing universal remote control.	<ul style="list-style-type: none"> • See instructions and a table of common codes in “Program universal remote controls” on page 80. • Codes are subject to change. For up-to-date codes, go to www.insigniaproducts.com/remotecodes • Replace dead batteries with new batteries. See “Install remote control batteries” on page 36. • Refer to the User Guide that accompanied your universal remote control and contact the manufacturer if problems persist.

General

Problem	Solution
No power.	<ul style="list-style-type: none"> • Make sure that the power cord is correctly connected to your TV and a power outlet. • Unplug the power cord, wait 60 seconds, then plug the cord back in and turn on your TV. • Other devices (for example, a surround sound receiver, external speakers, fans, or hair dryers) may be interfering with your TV. Try turning off one device at a time to determine which device is causing interference. After you have determined which device is causing interference, move it further from the TV to eliminate the interference.
“No signal” error message is displayed.	<ul style="list-style-type: none"> • Press INPUT and make sure that you have selected the correct input for the device or service you are trying to use. • If you are using a cable or satellite box, use the remote that came with that box to change channels. • Make sure that you have the correct input selected to view channels from the cable or satellite box.
After Auto Channel Search, there are no channels.	<ul style="list-style-type: none"> • Reception can vary by channel depending on the broadcast power level of a given station. Contact your cable or satellite TV provider. • Make sure that the antenna or cable/satellite TV is connected securely to your TV. • Try replacing the cable between the antenna/cable or cable/satellite box and your TV.

Problem	Solution
When I press INPUT , I cannot select my device (it is grayed out).	<ul style="list-style-type: none"> • Turn on the device. Your TV automatically detects and displays which video jacks have devices connected to them when the devices are turned on. • Turn off Auto Input Sensing. See “Turn Input Sensor on or off” on page 68.
One or more channels do not display.	<ul style="list-style-type: none"> • Make sure that the channels are not blocked. See “Set parental control levels” on page 61. • Make sure that the channels are not hidden. The channel may have been deleted from the channel list. You can tune to the channel by pressing the number buttons or you can add the channel back to the channel list. See “Hide channels” on page 57. • If you are using a cable or satellite box, use the remote that came with that box to change channels. • Make sure that you have the correct input selected to view channels from the cable or satellite box. • If you are using an antenna, the digital channel signal may be low. To check the digital channel signal strength, see “Check the digital signal strength” on page 58.
Password is lost.	<ul style="list-style-type: none"> • Enter 9999 to access parental controls, then set a new password. See “Set or change the password” on page 59.
Some settings cannot be accessed.	<ul style="list-style-type: none"> • If a setting is grayed, the setting is not available in the current video input mode (for example TV mode). Change to a different video input source. See “Select the video input source” on page 39.
TV cabinet creaks.	<ul style="list-style-type: none"> • When the TV is in use, the temperature rises naturally and may cause the cabinet to expand or contract which can cause a creaking noise. This is not a malfunction.
Control buttons do not work.	<ul style="list-style-type: none"> • Make sure that the Button Lock option is set to Off. See “Lock control buttons” on page 60. • Unplug the power cord, wait a few seconds, then plug the cord back in and turn on your TV.
TV keeps turning off.	<ul style="list-style-type: none"> • Make sure that the sleep timer is not turned on. See “Set the sleep timer” on page 67.

Problem	Solution
A retail banner is displayed.	<ul style="list-style-type: none"> You selected "Retail Mode" when you ran the TV setup wizard. Reset your TV to the factory defaults, then select Home Use Mode on the <i>What is your viewing environment</i> screen. See "Restore settings to the defaults" on page 69.

Roku Streaming Stick

Problem	Solution
I cannot see a picture on my TV.	<ul style="list-style-type: none"> Make sure that your TV is turned on. Make sure that the Roku Streaming Stick is securely connected to the purple HDMI 2 (MHL) jack. See "Connect a Roku Streaming Stick" on page 22. Make sure that the you have selected HDMI2 (Roku) as the video input source. See "Select the video input source" on page 39. Try adjusting the picture settings on your TV. See "Adjust the TV picture" on page 50.
I cannot hear sound.	<ul style="list-style-type: none"> Make sure that the you have selected HDMI2 (Roku) as the video input source. See "Select the video input source" on page 39. If you are using external speakers, a sound bar, or a home theater system, make sure that the audio cables are connected securely. See "Connect external speakers or a sound bar" on page 32. If you are using external speakers, a sound bar, or a home theater system, make sure that the volume is turned up and not muted. If you are using external speakers, a sound bar, or a home theater system, make sure that you have selected the correct output mode. Try adjusting the audio settings on your TV. See "Adjust sound settings" on page 53.

Problem	Solution
I cannot connect to my wireless network.	<ul style="list-style-type: none"> Make sure that there are no obstructions, like cement walls, between your Roku Streaming Stick and your wireless router. Make sure that you have selected the correct wireless router name on the "Wireless" screen. If your network requires a password, make sure that you have entered the correct password. Passwords are case sensitive. If you have turned off SSID broadcasting on your wireless router, select "My network is not shown" on the "Wireless" screen. If you are not getting three or more signal-strength bars above your wireless network, adjust the location of your wireless router.
I cannot stream Netflix movies through my Roku Streaming Stick.	<ul style="list-style-type: none"> Make sure that you have a Netflix unlimited streaming membership. Membership is required to instantly watch movies and TV episodes streaming from Netflix.
I cannot watch all channels through my Roku Streaming Stick.	<ul style="list-style-type: none"> Not all channels are available in Canada.

MHL-enabled device

Problem	Solution
The mobile device does not charge when connected to the HDMI 2 (MHL) jack.	<ul style="list-style-type: none"> Make sure that the cables are securely connected. Make sure that you are using an MHL cable. An MHL cable may be difficult to identify. It may look like a micro USB-to-HDMI cable because the cable connectors are the same, but the cable itself is thinner. The cable also may not be labeled MHL.

Problem	Solution
My TV is not displaying the video or playing the audio from the connected mobile device.	<ul style="list-style-type: none"> • Make sure that the cable is securely connected to the purple HDMI 2 (MHL) jack. • Make sure that the cables are securely connected. • Make sure that you are using an MHL cable. An MHL cable may be difficult to identify. It may look like a micro USB-to-HDMI cable because the cable connectors are the same, but the cable itself is thinner. The cable also may not be labeled MHL. • Make sure that the correct video input source is selected. See “Select the video input source” on page 39. • Try adjusting the picture settings on your TV. • Some Apps may not work on your TV, depending on how the App developer programmed the App.
My TV is playing the audio from a connected device but is not displaying the video.	<ul style="list-style-type: none"> • Make sure that the cables are securely connected. • Make sure that you are using an MHL cable. An MHL cable may be difficult to identify. It may look like a micro USB-to-HDMI cable because the cable connectors are the same, but the cable itself is thinner. The cable also may not be labeled MHL. • Try adjusting the picture settings on your TV. • Some Apps may not work on your TV, depending on how the App developer programmed the App.

Problem	Solution
My TV is displaying the video from the connected device but is not playing the audio.	<ul style="list-style-type: none"> • Make sure that the volume on your mobile device is turned up and not muted. • Make sure that the volume on your TV is turned up and not muted. • Make sure that the cables are securely connected. • Make sure that you are using an MHL cable. An MHL cable may be difficult to identify. It may look like a micro USB-to-HDMI cable because the cable connectors are the same, but the cable itself is thinner. The cable also may not be labeled MHL. • Try adjusting the audio settings on your TV. • Some Apps may not work on your TV, depending on how the App developer programmed the App. • Make sure that you do not have headphones connected. When headphones are connected, no sound comes from the TV speakers. • If you are using a home theater system, sound bar, or external speaker system, make sure that it is turned on and is not muted. • If you are using a home theater system, sound bar, or external speaker system and have connected with a digital optical cable, set the Digital Audio/SPDIF option on the AUDIO menu to PCM. See the Digital Audio/SPDIF option in “Adjust sound settings” on page 53.

INlink (CEC-compatible) device

Problem	Solution
My TV is not displaying the video from the connected CEC device.	<ul style="list-style-type: none"> • Make sure that the HDMI cable is connected securely to your TV and the device. • Make sure that the device is connected to your TV with an HDMI cable. • Make sure that the device is a CEC device. See the documentation that came with the device for more information. • Make sure that the correct video input source is selected. See "Select the video input source" on page 39. • Make sure that the INlink feature is turned on. See "Turn INlink on or off" on page 44. • Try adjusting the TV picture. See "Adjust the TV picture" on page 50. • If the device is not an Insignia device, it may not be compatible with your TV.
My TV is not playing the audio from the connected CEC device.	<ul style="list-style-type: none"> • Make sure that the HDMI cable is connected securely to your TV and the device. • Make sure that the device is connected to your TV with an HDMI cable. • Make sure that the device is a CEC device. See the documentation that came with the device. • Make sure that the TV volume is turned up and not muted. • Try adjusting the TV sound. See "Adjust sound settings" on page 53. • Make sure that the TV speakers are turned on and not muted. See "Adjust sound settings" on page 53. • Make sure that the INlink feature is turned on. See "Turn INlink on or off" on page 44. • If you have connected an HDMI CEC audio receiver, adjust the volume on the receiver. When your TV detects an audio receiver, the TV speakers turn off and sound plays through receiver speakers only. • If the device is not an Insignia device, it may not be compatible with your TV.

Problem	Solution
My TV's remote control does not control the device.	<ul style="list-style-type: none"> • Make sure that there are no obstructions between the remote control and the remote control sensors on your TV and the device. • Depending on the device, all the buttons may not work. • Make sure that the INlink feature is turned on. See "Turn INlink on or off" on page 44. • If you are trying to control the volume on an HDMI CEC audio receiver using your TV remote control, make sure that the TV Speakers option on the <i>Audio</i> menu is set to On. See "Adjust sound settings" on page 53. • If you are trying to control the volume on an HDMI CEC audio receiver using your TV remote control, make sure that the Audio Receiver option on the <i>INlink</i> menu is set to On. See "Turn Audio Receiver on or off" on page 45. • The device may not support this feature. See the documentation that came with the device for more information.
The device does not show up in the INlink Device list.	<ul style="list-style-type: none"> • Make sure that the device is turned on. • Make sure that the HDMI cable is connected securely to your TV and the device. • Make sure that the device is connected to your TV with an HDMI cable. • Make sure that the INlink feature is turned on. See "Turn INlink on or off" on page 44. • Make sure that the device is a CEC device. See the documentation that came with the device. • If the device is not an Insignia device, it may not be compatible with your TV.
My device does not turn off when I turn off my TV.	<ul style="list-style-type: none"> • Make sure that the INlink feature is turned on. See "Turn INlink on or off" on page 44. • Make sure that Device Auto Power Off is set to On on the <i>INlink</i> menu. See "Turn Device Auto Power Off on or off" on page 44. • The device may not support this feature. See the documentation that came with the device for more information.

Problem	Solution
My TV does not turn on when I turn on my device.	<ul style="list-style-type: none"> • Make sure that the INlink feature is turned on. See "Turn INlink on or off" on page 44. • Make sure that TV Auto Power On is set to On on the <i>INlink</i> menu. See "Turn TV Auto Power On on or off" on page 45. • The device may not support this feature. See the documentation that came with the device for more information.
The Audio Receiver setting on the <i>INlink</i> menu keeps turning back on after it is turned off.	<ul style="list-style-type: none"> • When Audio Receiver is set to Off and INlink Control is set to On and you make an adjustment to the audio receiver (for example, turn the volume knob or press a button), Audio Receiver is automatically set to On. To prevent this from happening, turn off the INlink feature. See "Turn INlink on or off" on page 44.
Two volume bars appear when adjusting the volume.	<ul style="list-style-type: none"> • When you adjust the volume on the audio receiver or with the TV remote control, a double volume bar appears, one for the TV volume and one for the audio receiver volume.

Problem	Solution
I cannot select the Root Menu option on the <i>INlink</i> menu. OR The device's root menu does not open when I select Root Menu on the <i>INlink</i> menu.	<ul style="list-style-type: none"> • The device may not support this feature. See the documentation that came with the device for more information.

Note

If the problem is not solved by using these troubleshooting instructions, turn off your TV, then turn it on again.

Specifications

Specifications are subject to change without notice.

Dimensions and weight

Without stand	28.9 × 17.5 × 3.1" (73.5 × 44.4 × 7.9 cm) 11.5 lbs. (5.2 kg)
With stand	28.9 × 18.8 × 6.3" (73.5 × 47.8 × 16.0 cm) 12.1 lbs. (5.5 kg)

Screen

Screen size measured diagonally	31.5 in.
Display type	LED
Screen refresh rate	60Hz
Display resolution	1080p
Panel resolution	1920 (H) × 1080 (V)
Aspect ratio	16:9
Contrast ratio (typical)–panel	2,000:1
Dynamic contrast ratio–list value	50,000:1
TV Brightness (minimum) cd/m ²	160 nits
Comb filter	3d y/c digital
Response time	6.5 ms
Horizontal viewing angle	178°
Vertical viewing angle	178°

Display resolutions

HDMI suggested resolutions	1080p, 1080i, 720p, 480p, 480i
Component video suggested resolutions	1080i, 720p, 480p, 480i
PC/VGA suggested scan rates	640 × 480/60Hz, 800 × 600/60Hz, 1024 × 768/60Hz, 1280 × 1024/60Hz, 1360 × 768/60Hz

Tuner

Analog	NTSC
Digital	ATSC, 8-VSB, Clear-QAM

Inputs

HDMI	2 (side) E-EDID compliant HDCP compliant MHL-enabled (HDMI 2 (MHL) jack)
Component video	1 (back)
Composite video	1 (back) Shared with component Y
Shared audio (component and composite)	Yes
PC/VGA	1 (back)
3.5mm PC audio input	1 (back)
DVI	1 (side) HDMI 1 (DVI+ARC) jack
USB	1 (side) Supports JPEG and firmware upgrade
Antenna/Cable	1 (back)

Outputs

Video	No
Analog audio/Headphone	1 (side)
Digital audio	1 (optical) (back)
WiFi	No
Ethernet	No

Audio

DTS Tuning Package	DTS Sound
Speakers	Number: 2 Watts per channel: 5W

Power

Power consumption	On: 40W Standby: <0.5W
Power input	AC 120 V, 60Hz

Miscellaneous

OSD languages	English, French, Spanish
INlink	Yes
MHL-enabled	Yes HDMI 2 (MHL) jack
Game Mode	Yes
ENERGY STAR qualified	No
Internet connectable	No
TV base screws	Stand column to TV screen: T4 type (12 mm length) (3 pcs) Base to stand column: T4 type (14 mm length) (1 pc)
V-Chip (version 2.0)	Yes
Sleep timer	Yes
Channel labeling	Yes
VESA mount (mm) (horizontal × vertical)	200 × 200
VESA mount screws	M6 type

Note

The length of the wall-mount screws vary depending on the wall-mount bracket you purchased. See the instructions that came with the wall-mount bracket for screw lengths.

Program universal remote controls

You can operate your Insignia TV with a new or existing universal remote control.

- 1 See the table in “[Common universal remote control codes](#)” on page 80 for common codes. If you have problems programming your remote or need a different remote control code:
 - Contact the universal remote control or cable/satellite company of the remote control you are trying to program
 - Visit www.insigniaproducts.com/remotecodes for the latest remote control code information.
 - Call the Insignia Customer Care Center 1-877-467-4289.
- 2 Follow your universal remote control’s instructions to enter the TV code you found in Step 1.

Tips

- If your universal remote control has a code search feature, run a code search to identify a code that matches your TV. See your universal remote control’s instructions for details.
- If your universal remote control has a “Learn” feature, you can manually program it using the Insignia TV remote to “teach” the commands one at a time. See your universal remote control’s instructions for details.

Common universal remote control codes

The following is a list of the most common remote control codes. Codes for other remote controls are available online at: <http://www.insigniaproducts.com/remotecodes> or check with your cable or satellite TV provider for the remote control code.

Insignia TV codes for universal remote controls (for all Insignia TVs manufactured after Jan. 1, 2007)

Universal remote control makes and models	
One for All	0054
Phillips	0198, 0490
RCA	135
Sony	068, 069, 078, 096, 100, 164, 168, 229, 026

Set-top box makes and models	
Cablevision	068, 069, 078, 096, 100, 164, 168, 229, 026
Charter	2002, 1204, 1423, 1517, 0171, 1963, 0463, 1463, 0842, 1326, 167, 415, 424, 450, 456, 461, 507, 523, 567, 577, 586
Comcast	10171, 11204, 11326, 11463, 11517, 11641, 11780, 11785, 11892, 11963, 12002
Cox	1326, 1463
DirectTV	10171, 11204, 11326, 11517, 11564, 11641, 11963, 12002
Dish Network	720
Time Warner	400, 450, 461, 456, 10463, 1463, 0463
TiVo	0091
Verizon	0198, 0490

Tips

- The brand name is often visible on the front of the universal remote control, and the model number is often visible on the back.
- If your universal remote control isn’t listed on the chart, refer to your universal remote control’s instructions and try codes for the brands Orion, Emerson, Memorex, Sansui, Sylvania, or Zenith. You may need to try several codes before finding a match.

Legal notices

FCC Statement

This device complies with Part 15 of the FCC Rules. Operation is subject to the following two conditions: (1) this device may not cause harmful interference, and (2) this device must accept any interference received, including interference that may cause undesired operation.

This equipment has been tested and found to comply with the limits for a Class B digital device, pursuant to Part 15 of the FCC Rules. These limits are designed to provide reasonable protection against harmful interference in a residential installation. This equipment generates, uses and can radiate radio frequency energy and, if not installed and used in accordance with the instructions, may cause harmful interference to radio communications. However, there is no guarantee that interference will not occur in a particular installation. If this equipment does cause harmful interference to radio or television reception, which can be determined by turning the equipment off and on, the user is encouraged to try to correct the interference by one or more of the following measures:

- Reorient or relocate the receiving antenna.
- Increase the separation between the equipment and receiver.
- Connect the equipment into an outlet on a circuit different from that to which the receiver is connected.
- Consult the dealer or an experienced radio/TV technician for help.

Warning

Changes or modifications not expressly approved by the party responsible for compliance could void the user's authority to operate the equipment.

Cables

Connections to this device must be made with shielded cables with metallic RF/EMI connector hoods to maintain compliance with FCC Rules and Regulations.

Canadian Notice

CAN ICES-3 (B)/NMB-3(B)

Standard Television Receiving Apparatus — Appareil de réception télévision ordinaire, Canada BETS-7 / NTMR-7

IC Statement

This device complies with Industry Canada licence—exempt RSS standard(s).

Operation is subject to the following two conditions: (1) this device may not cause interference, and (2) this device must accept any interference, including interference that may cause undesired operation of the device.

This equipment complies with IC radiation exposure limits set forth for an uncontrolled environment.

Dolby License Notice and Trademark Acknowledgement



Manufactured under license from Dolby Laboratories. Dolby and the double-D symbol are trademarks of Dolby Laboratories.

HDMI



The terms HDMI and HDMI High-Definition Multimedia Interface, and the HDMI Logo are trademarks or registered trademarks of HDMI Licensing LLC in the United States and other countries.

DTS Sound™



For DTS Patents, see <http://patents.dts.com>. Manufactured under license from DTS Licensing Limited. DTS, the Symbol, & DTS and the Symbol together are registered trademarks and DTS Sound is a trademark of DTS, Inc. © DTS, Inc. All Rights Reserved.

MHL™ (Mobile High-Definition Link)



MHL and the MHL logo are trademarks or registered trademarks of MHL Licensing, LLC in the United States and other countries.

Roku®



Roku and the Roku logo are registered trademarks of Roku, Inc. in the United States and other countries.

One-year limited warranty - Insignia Televisions

Definitions:

Insignia Products ("Insignia") warrants to you, the original purchaser of this new Insignia-branded television ("Product"), that the Product shall be free of defects in the original manufacturer of the material or workmanship for a period of one (1) year from the date of your purchase of the Product ("Warranty Period"). For this warranty to apply, your Product must be purchased in the United States or Canada from a Best Buy or Future Shop authorized dealer of Insignia brand products only that are packaged with this warranty statement.

How long does the coverage last?

The Warranty Period lasts for 1 year (365 days) from the date you purchased the Product. Your purchase date is printed on the receipt you received with the Product.

What does this warranty cover?

During the Warranty Period, if the original manufacture of the material or workmanship of the Product is determined to be defective by an authorized Insignia repair center or store personnel, Insignia will (at its sole option): (1) repair the Product with new or rebuilt parts; or (2) replace the Product at no charge with new or rebuilt comparable products or parts. Products and parts replaced under this warranty become the property of Insignia and are not returned to you. If service of Products or parts are required after the Warranty Period expires, you must pay all labor and parts charges. This warranty lasts as long as you own your Insignia Product during the Warranty Period. Warranty coverage terminates if you sell or otherwise transfer the Product.

How to obtain warranty service?

If you purchased the Product at a Best Buy or Future Shop retail store location and your television Product has a screen size of less than 42 inches, please take your original receipt and the Product to any Best Buy or Future Shop store. Make sure that you place the Product in its original packaging or packaging that provides the same amount of protection as the original packaging. If you purchased the Product from a Best Buy or Future Shop online web site, mail your original receipt and the Product to the address listed on the web site. Make sure that you put the Product in its original packaging or packaging that provides the same amount of protection as the original packaging.

To obtain in-home warranty service for a television with a screen 42 inches or larger, in the United States call 1-888-BESTBUY, Canada call 1-866-BESTBUY for Future Shop call 1-800-663-2275. Call agents will diagnose and correct the issue over the phone or will have an Insignia-approved repair technician dispatched to your home.

Where is the warranty valid?

This warranty is valid only in the United States and Canada at Best Buy or Future Shop branded retail stores or websites to the original purchaser of the product in the county where the original purchase was made.

What does the warranty not cover?

This warranty does not cover:

- Customer instruction/education
- Installation
- Set up adjustments
- Cosmetic damage
- Damage due to acts of God, such as power surges
- Accident(s)
- Misuse, unintentional or intentional
- Abuse, unintentional or intentional
- Negligence
- Commercial purposes/use, including but not limited to use in a place of business or in communal areas of a multiple dwelling condominium or apartment complex, or otherwise used in a place of other than a private home.
- Modification of any part of the Product, including the antenna
- Plasma display panel damaged by static (non-moving) images applied for lengthy periods (burn-in).
- Damage due to incorrect operation or maintenance
- Connection to an incorrect voltage or power supply

- Outages, static or other problems with over-the-air reception of television broadcast signals.
- Attempted repair by any person not authorized by Insignia to service the Product
- Products sold "as is" or "with all faults"
- Consumables, including but not limited to batteries (i.e. AA, AAA, C etc.)
- Products where the factory applied serial number has been altered or removed
- Loss or Theft of this product or any part of the product
- Failures or Damage caused by any contact including but not limited to liquids, gels or pastes.
- Up to three (3) pixel failures (dots that are dark or incorrectly illuminated) grouped in an area smaller than one tenth (1/10) of the display size or up to five (5) pixel failures throughout the display. (Pixel based displays may contain a limited number of pixels that may not function normally.)
- Problems with delay in motion or action of video images while playing first-person style video games.

REPAIR REPLACEMENT AS PROVIDED UNDER THIS WARRANTY IS YOUR EXCLUSIVE REMEDY FOR BREACH OF WARRANTY. INSIGNIA SHALL NOT BE LIABLE FOR ANY INCIDENTAL OR CONSEQUENTIAL DAMAGES FOR THE BREACH OF ANY EXPRESS OR IMPLIED WARRANTY ON THIS PRODUCT, INCLUDING, BUT NOT LIMITED TO, LOST DATA, LOSS OF USE OF YOUR PRODUCT, LOST BUSINESS OR LOST PROFITS. INSIGNIA PRODUCTS MAKES NO OTHER EXPRESS WARRANTIES WITH RESPECT TO THE PRODUCT, ALL EXPRESS AND IMPLIED WARRANTIES FOR THE PRODUCT, INCLUDING, BUT NOT LIMITED TO, ANY IMPLIED WARRANTIES OF AND CONDITIONS OF MERCHANTABILITY AND FITNESS FOR A PARTICULAR PURPOSE, ARE LIMITED IN DURATION TO THE WARRANTY PERIOD SET FORTH ABOVE AND NO WARRANTIES, WHETHER EXPRESS OR IMPLIED, WILL APPLY AFTER THE WARRANTY PERIOD. SOME STATES, PROVINCES AND JURISDICTIONS DO NOT ALLOW LIMITATIONS ON HOW LONG AN IMPLIED WARRANTY LASTS, SO THE ABOVE LIMITATION MAY NOT APPLY TO YOU. THIS WARRANTY GIVES YOU SPECIFIC LEGAL RIGHTS, AND YOU MAY ALSO HAVE OTHER RIGHTS, WHICH VARY FROM STATE TO STATE OR PROVINCE TO PROVINCE.

Contact Insignia:

For customer service please call 1-877-467-4289

www.insigniaproducts.com

INSIGNIA is a trademark of Best Buy and its affiliated companies.

Registered in some countries.

Distributed by Best Buy Purchasing, LLC

7601 Penn Ave South, Richfield, MN 55423 U.S.A.

©2014 Best Buy. All rights reserved.

Made in China

INSIGNIA™

www.insigniaproducts.com (877) 467-4289

INSIGNIA is a trademark of Best Buy and its affiliated companies.

Registered in some countries.

Distributed by Best Buy Purchasing, LLC

7601 Penn Ave South, Richfield, MN 55423 U.S.A.

©2014 Best Buy. All rights reserved.

Made in China

V1 ENGLISH
13-1025

Free Manuals Download Website

<http://myh66.com>

<http://usermanuals.us>

<http://www.somanuals.com>

<http://www.4manuals.cc>

<http://www.manual-lib.com>

<http://www.404manual.com>

<http://www.luxmanual.com>

<http://aubethermostatmanual.com>

Golf course search by state

<http://golfingnear.com>

Email search by domain

<http://emailbydomain.com>

Auto manuals search

<http://auto.somanuals.com>

TV manuals search

<http://tv.somanuals.com>