

MB820

Socket 478 Pentium® 4
Intel® 875P Chipset
Industrial Motherboard

USER'S MANUAL

Version 1.0

Acknowledgments

Award is a registered trademark of Award Software International, Inc.

PS/2 is a trademark of International Business Machines Corporation.

Intel and Pentium 4 are registered trademarks of Intel Corporation.

Microsoft Windows is a registered trademark of Microsoft Corporation.

Winbond is a registered trademark of Winbond Electronics Corporation.

All other product names or trademarks are properties of their respective owners.

Table of Contents

Introduction	1
Checklist.....	1
Product Description	2
Board Dimensions.....	3
Installations	4
ATX Power Installation.....	5
Installing the Memory	5
Setting the Jumpers	6
Connectors on MB820.....	11
Watchdog Timer Configuration.....	23
BIOS Setup.....	27
Drivers Installation	49
Intel 875P Chipset Software Intallation Utility	50
Realtek AC97 Codec Audio Driver Installation	53
Intel PRO LAN Drivers Installation.....	54
VGA Drivers Installation.....	55

This page is intentionally left blank.

Introduction

Checklist

Your MB820 Pentium® 4 motherboard package should include the items listed below:

- The MB820 motherboard
- This User's Manual
- 1 Backplate
- 2 IDE Cable
- 1 Floppy Cable
- 2 SATA Cable
- 1 Dual-Serial-Port Cable
- 1 CD containing the following:
 - Chipset Drivers
 - Flash Memory Utility

Product Description

The MB820 Pentium® 4 motherboard incorporates the Intel 875P chipset that can utilize a single PGA478 processor of up to 3.2GHz or higher and supports FSB frequency of 400/533/800Mhz (100Mhz, 133Mhz, and 200Mhz HCLK respectively).

The 875P chipset is designed for use with the Pentium® 4 processor with 512-KB L2 cache on 0.13 micron process. The integrated MCH component provides the CPU interface, DDR interface, AGP interface, Hub Interface and AGP 8X graphics interface.

Four DDR memory sockets supports DDR 400/333/266 SDRAM DIMM modules of up to 4GB in capacity. ECC is also supported.

The board also comes optional with either integrated 10/100MB LAN support or an Intel® 82547GI Gigabit LAN controller. Two Serial ATA connectors offer 1.5 Gigabits/sec data throughput speed - faster than the most advanced parallel ATA.

Expansion is provided by four PCI slots, two ISA slots and one AGP8X interface. Other advanced features include six USB 2.0 ports, IrDA interface, PCI to ISA bridge, digital I/O, four serial ports, watchdog timer and audio function. Dimensions of the board are 12" by 9.5" in an ATX form factor.

Board Dimensions

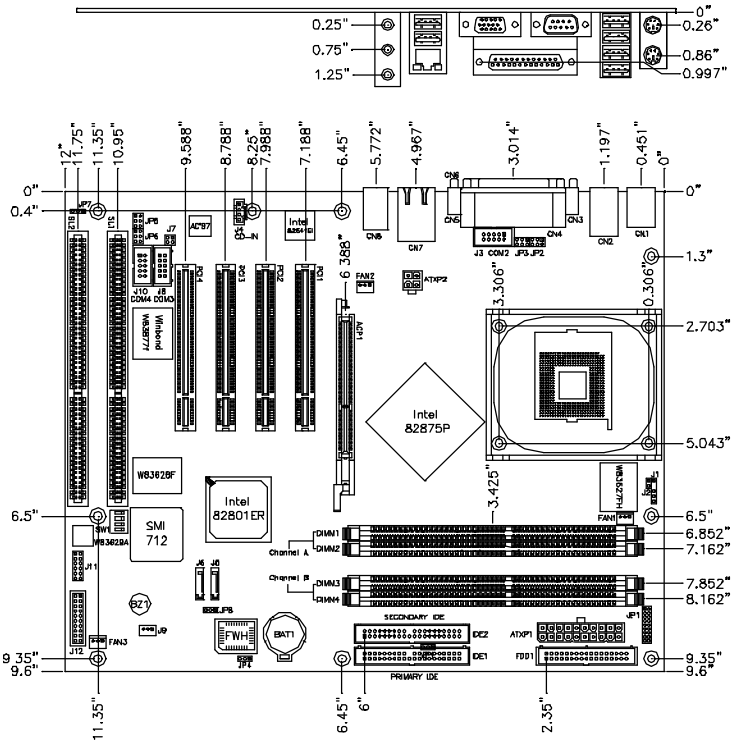

Installations

This section provides information on how to use the jumpers and connectors on the MB820 in order to set up a workable system. The topics covered are:

- ATX Power Installation
- Installing the Memory
- Setting the Jumpers
- Connectors on MB820
- Watchdog Timer Configuration

ATX Power Installation

The system power is provided to the motherboard with the ATXP1 and ATXP2 ATX power connectors. ATXP2 is a 4-pin 12V power connector. ATXP1 is to be connected to a standard ATX power connector.

Installing the Memory

The MB820 motherboard supports four DDR memory sockets for a maximum total memory of 4GB in DDR memory type. You can install unbuffered & ECC DDR DIMMs. It supports DDR266 when installed with CPUs that have clock speeds of 400MHz. It supports DDR266/333 when installed with CPUs that have clock speeds of 533MHz. It supports DDR266/320/400 when installed with CPUs that have clock speeds of 800MHz. The board provides dual channel functionality for its DIMM slots. DIMM1/2 is for one channel and DIMM3/4 is for another channel. Enabling dual channels can increase data access rates by putting two similar-size DDR modules into two same-color DIMM slots.

Basically, the system memory interface has the following features:

- Supports two 64-bit wide DDR data channels

- Available bandwidth up to 3.2GB/s (DDR400) for single-channel mode and 6.4GB/s (DDR400) in dual-channel mode.

- Supports ECC DIMMs.

- Supports 128Mb, 256Mb, 512Mb, 1Gb DDR technologies.

- Supports only x8, x16, DDR devices with four banks

- Registered DIMMs not supported

- Supports opportunistic refresh

- Up to 16 simultaneously open pages (four per row, four rows maximum)

Setting the Jumpers

Jumpers are used on MB820 to select various settings and features according to your needs and applications. Contact your supplier if you have doubts about the best configuration for your needs. The following lists the connectors on MB820 and their respective functions.

Jumper Locations on MB820.....	7
JP1: RS232/422/485 (COM2) Selection.....	8
JP2: COM1 RS232 +5V/+12V Power Setting.....	8
JP3: COM2 RS232 +5V/+12V Power Setting.....	8
JP4: Clear CMOS Contents.....	9
JP5: COM3 RS232 +5V/+12V Power Setting.....	9
JP6: COM4 RS232 +5V/+12V Power Setting.....	9
JP7: DiskOnChip Address Select.....	10
JP8: Onboard VGA Enable/Disable.....	10

Jumper Locations on MB820

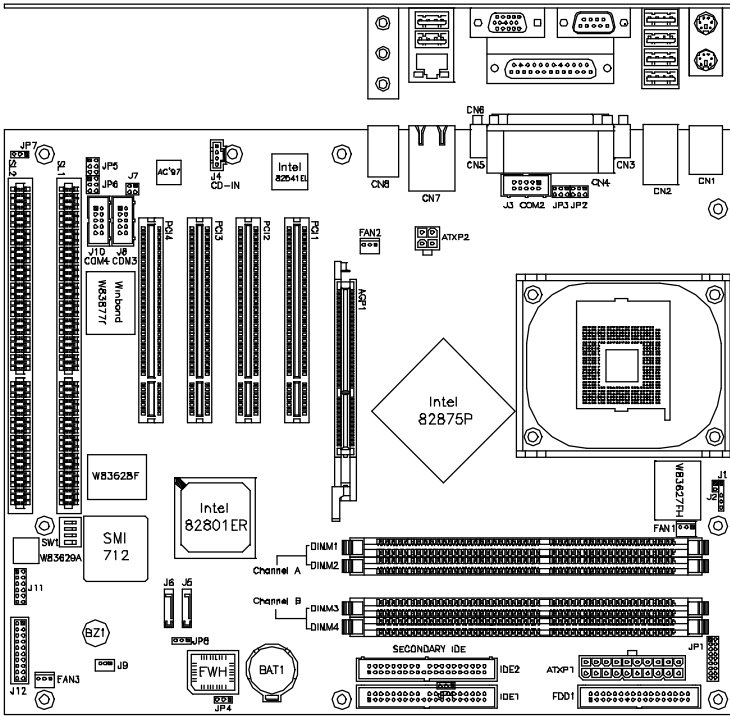

Jumper Locations on MB820 Page

JP1: RS232/422/485 (COM2) Selection..... 8

JP2: COM1 RS232 +5V/+12V Power Setting 8

JP3: COM2 RS232 +5V/+12V Power Setting 8

JP4: Clear CMOS Contents 9

JP5: COM3 RS232 +5V/+12V Power Setting 9

JP6: COM4 RS232 +5V/+12V Power Setting 9

JP7: DiskOnChip Address Select..... 10

JP8: Onboard VGA Enable/Disable 10

JP1: RS232/422/485 (COM2) Selection

COM1 is fixed for RS-232 use only.

J3, COM2 is selectable for RS232, RS-422 and RS-485.

The following table describes the jumper settings for COM2 selection.



COM2 Function	RS-232	RS-422	RS-485
Jumper Setting (pin closed)	Short: 1-2	Short: 3-4	Short: 5-6
	9-11	7-9	7-9
	10-12	8-10	8-10
	15-17	13-15	13-15
	16-18	14-16	14-16

JP2: COM1 RS232 +5V/+12V Power Setting

JP2	Setting	Function
	Pin 1-2 Short/Closed	+12V
	Pin 3-4 Short/Closed	Normal
	Pin 5-6 Short/Closed	+5V

JP3: COM2 RS232 +5V/+12V Power Setting

JP3	Setting	Function
	Pin 1-2 Short/Closed	+12V
	Pin 3-4 Short/Closed	Normal
	Pin 5-6 Short/Closed	+5V

JP4: Clear CMOS Contents

Use JP4, a 3-pin header, to clear the CMOS contents. *Note that the ATX-power connector should be disconnected from the motherboard before clearing CMOS.*

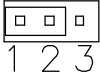
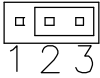
JP4	Setting	Function
	Pin 1-2 Short/Closed	Normal
	Pin 2-3 Short/Closed	Clear CMOS

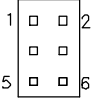

JP5: COM3 RS232 +5V/+12V Power Setting

JP5	Setting	Function
	Pin 1-2 Short/Closed	+12V
	Pin 3-4 Short/Closed	Normal
	Pin 5-6 Short/Closed	+5V

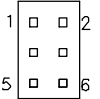
JP6: COM4 RS232 +5V/+12V Power Setting



JP6	Setting	Function
	Pin 1-2 Short/Closed	+12V
	Pin 3-4 Short/Closed	Normal
	Pin 5-6 Short/Closed	+5V

JP7: DiskOnChip Address Select

JP7	Address
	D0000-D7FFF
	D8000-DFFFF (default)

JP8: Onboard VGA Enable/Disable

Use JP8 to enable or disable the onboard VGA controller.

JP8	Setting	Onboard VGA
	Pin 1-2 Short/Closed	Enabled
	Pin 2-3 Short/Closed	Disabled

Connectors on MB820

The connectors on MB820 allows you to connect external devices such as keyboard, floppy disk drives, hard disk drives, printers, etc. The following table lists the connectors on MB820 and their respective functions.

Connector Locations on MB820	12
ATXP1: ATX Power Supply Connector.....	13
ATXP2: ATX 12V Power Connector.....	13
DIMM1, DIMM2: DDR Channel A Connectors.....	13
DIMM3, DIMM4: DDR Channel B Connectors.....	13
AGP1: AGP Slot.....	13
PCI1, PCI2, PCI3, PCI4: PCI Slots.....	13
SL1, SL2: ISA Slots.....	13
CN1: PS/2 Keyboard and PS/2 Mouse Connectors.....	14
CN2: 4-port USB Connector	14
CN3, J3: Serial Ports.....	14
CN4: Parallel Port Connector.....	15
CN6: VGA CRT Connector.....	15
CN7: USB and LAN RJ45 Connectors	16
CN8: Audio Connector	16
J1: IrDA Connector	16
J4: CD-In Audio Connector.....	16
J5, J6: Serial ATA (SATA) Connectors.....	17
J8, J10: COM3 and COM4 Serial Ports Connector	17
J9: Wake On LAN Connector	17
J11: Digital I/O Connector (4 in, 4 out).....	18
J12: System Function Connector.....	18
FAN1: CPU Fan Power Connector	20
FAN2: VGA Fan Power Connector	20
FAN3: Chassis Fan Power Connector.....	20
FDD1: Floppy Drive Connector	21
IDE, IDE2: Primary and Secondary IDE Connectors	22

Connector Locations on MB820

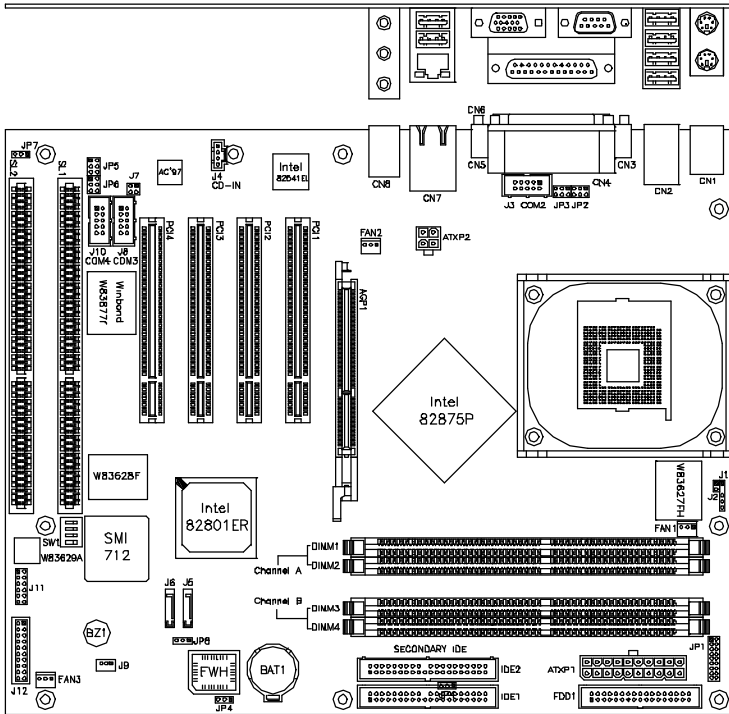

ATXP1: ATX Power Supply Connector

ATXP1 is a 20-pin ATX power supply connector. Refer to the following table for the pin out assignments.

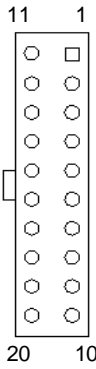

Signal Name	Pin #	Pin #	Signal Name
3.3V	11	1	3.3V
-12V	12	2	3.3V
Ground	13	3	Ground
PS-ON	14	4	+5V
Ground	15	5	Ground
Ground	16	6	+5V
Ground	17	7	Ground
-5V	18	8	Power good
+5V	19	9	5VSB
+5V	20	10	+12V

ATXP2: ATX 12V Power Connector

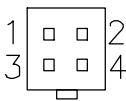

Pin #	Signal Name
1	Ground
2	Ground
3	+12V
4	+12V

DIMM1, DIMM2: DDR Channel A Connectors

DIMM1 and DIMM2 are the first DDR channel connectors that must be use together at one time in order for the system to function properly.

DIMM3, DIMM4: DDR Channel B Connectors

DIMM3 and DIMM4 are the second DDR channel connectors that must be use together at one time in order for the system to function properly.

AGP1: AGP Slot

PCI1, PCI2, PCI3, PCI4: PCI Slots

SL1, SL2: ISA Slots

CN1: PS/2 Keyboard and PS/2 Mouse Connectors

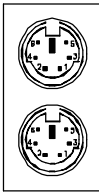

PS/2 Mouse

PS/2 Keyboard

Signal Name	Keyboard	Mouse	Signal Name
Keyboard data	1	1	Mouse data
N.C.	2	2	N.C.
GND	3	3	GND
5V	4	4	5V
Keyboard clock	5	5	Mouse clock
N.C.	6	6	N.C.

CN2: 4-port USB Connector

CN2 is a USB connector consisting of four ports stacked vertically.



CN2

Pin	Signal Name
1	Ground
2	USB+
3	USB-
4	Vcc

CN3, J3: Serial Ports

CN3 (COM1) is a DB-9 connector, while J3 is a COM2 pin-header connector. COM2 is optionally available as a DB-9 connector (CN5).



COM1

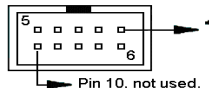

COM2

Signal Name	Pin #	Pin #	Signal Name
DCD, Data carrier detect	1	6	DSR, Data set ready
RXD, Receive data	2	7	RTS, Request to send
TXD, Transmit data	3	8	CTS, Clear to send
DTR, Data terminal ready	4	9	RI, Ring indicator
GND, ground	5	10	Not Used

CN4: Parallel Port Connector

CN4 is a DB-25 external connector situated on top of the VGA and serial ports. The following table describes the pin-out assignments of this connector.

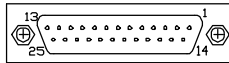

CN4 Parallel Port

Signal Name	Pin #	Pin #	Signal Name
Line printer strobe	1	14	AutoFeed
PD0, parallel data 0	2	15	Error
PD1, parallel data 1	3	16	Initialize
PD2, parallel data 2	4	17	Select
PD3, parallel data 3	5	18	Ground
PD4, parallel data 4	6	19	Ground
PD5, parallel data 5	7	20	Ground
PD6, parallel data 6	8	21	Ground
PD7, parallel data 7	9	22	Ground
ACK, acknowledge	10	23	Ground
Busy	11	24	Ground
Paper empty	12	25	Ground
Select	13	N/A	N/A

CN6: VGA CRT Connector

CN6 is a DB-15 VGA connector located beside the COM1 port. The following table shows the pin-out assignments of this connector.

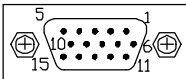

Signal Name	Pin #	Pin #	Signal Name
Red	1	2	Green
Blue	3	4	N.C.
GND	5	6	GND
GND	7	8	GND
N.C.	9	10	GND
N.C.	11	12	N.C.
HSYNC	13	14	VSYNC
NC	15		

CN7: USB and LAN RJ45 Connectors

CN7 consists of an RJ-45 connector (top) and two stacked USB ports. Refer to the section below for their respective pin assignments.

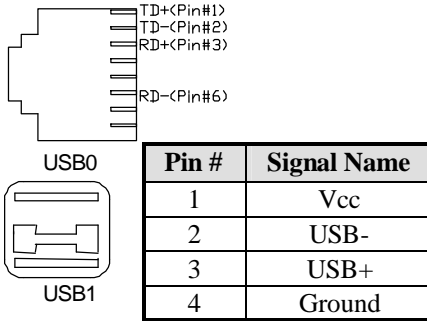

CN8: Audio Connector

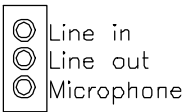

CN8 is a 3-jack audio connector beside the USB/RJ45 combo connector.

J1: IrDA Connector

J1 is used for an optional IrDA connector for wireless communication.

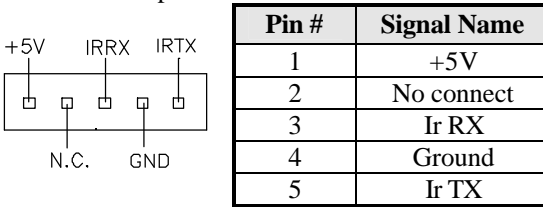

J4: CD-In Audio Connector

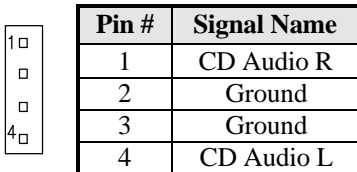

J5, J6: Serial ATA (SATA) Connectors

The SATA connectors support serial ATA 150. Each connector can only use one serial ATA hard disk. J6 is port 1 and J5 is port 2.

J8, J10: COM3 and COM4 Serial Ports Connector

J8 and J10 are both 10-pin headers, as the COM3 and COM4 serial port pin headers supporting RS232.

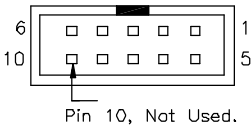

Pin #	Signal Name
1	DCD
2	RX
3	TX
4	DTR
5	GND
6	DSR
7	RTS
8	CTS
9	RI
10	NC

J9: Wake On LAN Connector

J9 is a 3-pin header for the Wake On LAN function on the motherboard. The following table shows the pin out assignments of this connector. Wake On LAN will function properly only with an ATX power supply with 5VSB that has 1A.

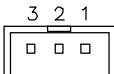

Pin #	Signal Name
1	+5VSB
2	Ground
3	LAN Wakeup

J11: Digital I/O Connector (4 in, 4 out)

This 12-pin Digital I/O connector supports TTL levels and is used to control external devices requiring ON/OFF circuitry.

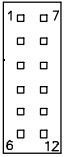

Signal Name	Pin #	Pin #	Signal Name
IN0	1	7	+5V
IN1	2	8	OUT0
IN2	3	9	Ground
IN3	4	10	OUT1
GROUND	5	11	+12V
OUT2	6	12	OUT3

J12: System Function Connector

J12 provides connectors for system indicators that provide light indication of the computer activities and switches to change the computer status. J12 is a 20-pin header that provides interfaces for the following functions.

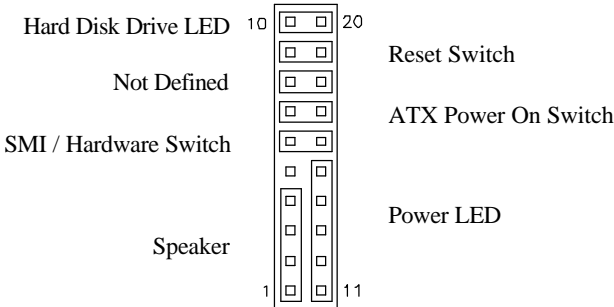

Speaker: Pins 1 - 4

This connector provides an interface to a speaker for audio tone generation. An 8-ohm speaker is recommended.

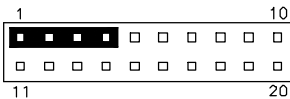

Pin #	Signal Name
1	Speaker out
2	No connect
3	Ground
4	+5V

Power LED: Pins 11 - 15

The power LED indicates the status of the main power switch.

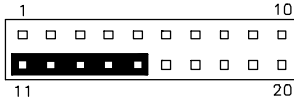

Pin #	Signal Name
11	Power LED
12	No connect
13	Ground
14	No connect
15	Ground

SMI/Hardware Switch: Pins 6 and 16

This connector supports the "Green Switch" on the control panel, which, when pressed, will force the system into the power-saving mode immediately.

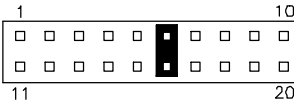

Pin #	Signal Name
6	SMI
16	Ground

ATX Power ON Switch: Pins 7 and 17

This 2-pin connector is an "ATX Power Supply On/Off Switch" on the system that connects to the power switch on the case. When pressed, the power switch will force the system to power on. When pressed again, it will force the system to power off.

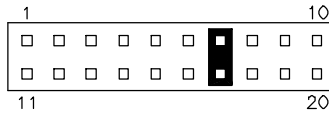

Reset Switch: Pins 9 and 19

The reset switch allows the user to reset the system without turning the main power switch off and then on again. Orientation is not required when making a connection to this header.

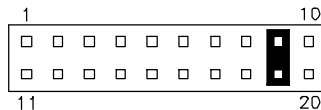

Hard Disk Drive LED Connector: Pins 10 and 20

This connector connects to the hard drive activity LED on control panel. This LED will flash when the HDD is being accessed.

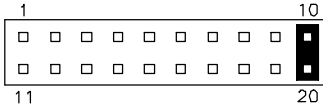

Pin #	Signal Name
10	HDD Active
20	5V

FAN1: CPU Fan Power Connector

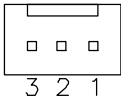

Pin #	Signal Name
1	Ground
2	+12V
3	Rotation detection

FAN2: VGA Fan Power Connector

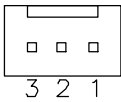

Pin #	Signal Name
1	Ground
2	+12V
3	Rotation detection

FAN3: Chassis Fan Power Connector

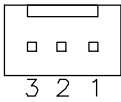

Pin #	Signal Name
1	Ground
2	+12V
3	Rotation detection

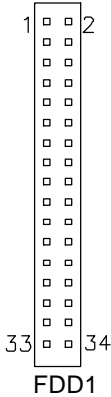
FDD1: Floppy Drive Connector

Signal Name	Pin #	Pin #	Signal Name
Ground	1	2	RM/LC
Ground	3	4	No connect
Ground	5	6	No connect
Ground	7	8	Index
Ground	9	10	Motor enable 0
Ground	11	12	Drive select 1
Ground	13	14	Drive select 0
Ground	15	16	Motor enable 1
Ground	17	18	Direction
Ground	19	20	Step
Ground	21	22	Write data
Ground	23	24	Write gate
Ground	25	26	Track 00
Ground	27	28	Write protect
Ground	29	30	Read data
Ground	31	32	Side 1 select
Ground	33	34	Diskette change

IDE, IDE2: Primary and Secondary IDE Connectors

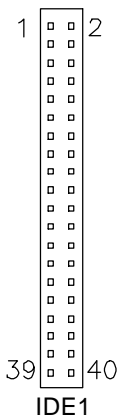

Diagram of IDE1 connector showing pins 1 to 40. Pin 1 is at the top, and pin 40 is at the bottom. The connector is labeled IDE1.

Signal Name	Pin #	Pin #	Signal Name
Reset IDE	1	2	Ground
Host data 7	3	4	Host data 8
Host data 6	5	6	Host data 9
Host data 5	7	8	Host data 10
Host data 4	9	10	Host data 11
Host data 3	11	12	Host data 12
Host data 2	13	14	Host data 13
Host data 1	15	16	Host data 14
Host data 0	17	18	Host data 15
Ground	19	20	Protect pin
DRQ0	21	22	Ground
Host IOW	23	24	Ground
Host IOR	25	26	Ground
IOCHRDY	27	28	Host ALE
DACK0	29	30	Ground
IRQ14	31	32	No connect
Address 1	33	34	No connect
Address 0	35	36	Address 2
Chip select 0	37	38	Chip select 1
Activity	39	40	Ground

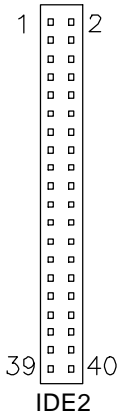

Diagram of IDE2 connector showing pins 1 to 40. Pin 1 is at the top, and pin 40 is at the bottom. The connector is labeled IDE2.

Signal Name	Pin #	Pin #	Signal Name
Reset IDE	1	2	Ground
Host data 7	3	4	Host data 8
Host data 6	5	6	Host data 9
Host data 5	7	8	Host data 10
Host data 4	9	10	Host data 11
Host data 3	11	12	Host data 12
Host data 2	13	14	Host data 13
Host data 1	15	16	Host data 14
Host data 0	17	18	Host data 15
Ground	19	20	Protect pin
DRQ1	21	22	Ground
Host IOW	23	24	Ground
Host IOR	25	26	Ground
IOCHRDY	27	28	Host ALE
DACK1	29	30	Ground
IRQ15	31	32	No connect
Address 1	33	34	No connect
Address 0	35	36	Address 2
Chip select 0	37	38	Chip select 1
Activity	39	40	Ground

Watchdog Timer Configuration

The WDT is used to generate a variety of output signals after a user programmable count. The WDT is suitable for use in the prevention of system lock-up, such as when software becomes trapped in a deadlock. Under these sort of circumstances, the timer will count to zero and the selected outputs will be driven. Under normal circumstance, the user will restart the WDT at regular intervals before the timer counts to zero.

SAMPLE CODE:

This code and information is provided "as is" without warranty of any kind, either expressed or implied, including but not limited to the implied warranties of merchantability and/or fitness for a particular purpose.

```

;[]=====
; Name  : Enable_And_Set_Watchdog
; IN    : AL - 1 sec ~ 255sec
; OUT   : None
;[]=====
Enable_And_Set_Watchdog Proc Near
    push    ax                ;save time interval
    call   Unlock_Chip

    mov     cl, 2Bh
    call   Read_Reg
    and    al, NOT 10h
    call   Write_Reg         ;set GP24 as WDTO

    mov     cl, 07h
    mov     al, 08h
    call   Write_Reg         ;switch to LD8

```

```

mov    cl, 0F5h
call  Read_Reg
and   al, NOT 08h
call  Write_Reg    ;set count mode as second

```

```

pop   ax
mov   cl, 0F6h
call  Write_Reg    ;set watchdog timer

```

```

mov   al, 01h
mov   cl, 30h
call  Write_Reg    ;watchdog enabled

```

```

call  Lock_Chip
ret

```

Enable_And_Set_Watchdog Endp

```

;[]=====

```

```

; Name : Disable_Watchdog
; IN   : None
; OUT  : None

```

```

;[]=====

```

Disable_Watchdog Proc Near

```

call  Unlock_Chip

```

```

mov   cl, 07h
mov   al, 08h
call  Write_Reg    ;switch to LD8

```

```

xor   al, al
mov   cl, 0F6h
call  Write_Reg    ;clear watchdog timer

```

```

xor   al, al
mov   cl, 30h
call  Write_Reg    ;watchdog disabled

```

```

call  Lock_Chip
ret

```

Disable_Watchdog Endp

```

;[]=====

```

```
; Name : Unlock_Chip
; IN : None
; OUT : None
```

```
;[]=====
```

```
Unlock_Chip Proc Near
    mov dx, 2Eh
    mov al, 87h
    out dx, al
    out dx, al
    ret
```

```
Unlock_Chip Endp
```

```
;[]=====
```

```
; Name : Lock_Chip
; IN : None
; OUT : None
```

```
;[]=====
```

```
Unlock_Chip Proc Near
    mov dx, 2Eh
    mov al, 0AAh
    out dx, al
    ret
```

```
Unlock_Chip Endp
```

```
;[]=====
```

```
; Name : Write_Reg
; IN : CL - register index
; AL - Value to write
; OUT : None
```

```
;[]=====
```

```
Write_Reg Proc Near
    push ax
    mov dx, 2Eh
    mov al, cl
    out dx, al
    pop ax
    inc dx
    out dx, al
    ret
```

```
Write_Reg Endp
```

```
;[]=====
```

```
; Name : Read_Reg  
; IN : CL - register index  
; OUT : AL - Value to read
```

```
;[]=====
```

```
====  
Read_Reg Proc Near  
    mov  al, cl  
    mov  dx, 2Eh  
    out dx, al  
    inc dx  
    in  al, dx  
    ret
```

```
Read_Reg Endp
```

```
;[]=====
```

BIOS Setup

This chapter describes the different settings available in the Award BIOS that comes with the motherboard. The topics covered in this chapter are as follows:

BIOS Introduction.....	28
BIOS Setup.....	28
Standard CMOS Setup.....	30
Advanced BIOS Features.....	33
Advanced Chipset Features.....	36
Integrated Peripherals.....	38
Power Management Setup.....	42
PNP/PCI Configurations.....	45
PC Health Status.....	46
Frequency/Voltage Control.....	47
Load Fail-Safe Defaults.....	48
Load Setup Defaults.....	48
Set Supervisor/User Password.....	48
Save & Exit Setup.....	48
Exit Without Saving.....	48

BIOS Introduction

The Award BIOS (Basic Input/Output System) installed in your computer system's ROM supports Intel® Pentium® 4 processors. The BIOS provides critical low-level support for a standard device such as disk drives, serial ports and parallel ports. It also adds virus and password protection as well as special support for detailed fine-tuning of the chipset controlling the entire system.

BIOS Setup

The Award BIOS provides a Setup utility program for specifying the system configurations and settings. The BIOS ROM of the system stores the Setup utility. When you turn on the computer, the Award BIOS is immediately activated. Pressing the key immediately allows you to enter the Setup utility. If you are a little bit late pressing the key, POST (Power On Self Test) will continue with its test routines, thus preventing you from invoking the Setup. If you still wish to enter Setup, restart the system by pressing the "Reset" button or simultaneously pressing the <Ctrl>, <Alt> and <Delete> keys. You can also restart by turning the system Off and back On again. The following message will appear on the screen:

```
Press <DEL> to Enter Setup
```

In general, you press the arrow keys to highlight items, <Enter> to select, the <PgUp> and <PgDn> keys to change entries, <F1> for help and <Esc> to quit.

When you enter the Setup utility, the Main Menu screen will appear on the screen. The Main Menu allows you to select from various setup functions and exit choices.

Phoenix - AwardBIOS CMOS Setup Utility

Standard CMOS Features	Frequency/Voltage Control
Advanced BIOS Features	Load Fail-Safe Defaults
Advanced Chipset Features	Load Optimized Defaults
Integrated Peripherals	Set Supervisor Password
Power Management Setup	Set User Password
PnP/PCI Configurations	Save & Exit Setup
PC Health Status	Exit Without Saving
ESC : Quit	↑ ↓ → ← : Select Item
F10 : Save & Exit Setup	
Time, Date, Hard Disk Type...	

The section below the setup items of the Main Menu displays the control keys for this menu. At the bottom of the Main Menu just below the control keys section, there is another section, which displays information on the currently highlighted item in the list.

Note: *If the system cannot boot after making and saving system changes with Setup, the Award BIOS supports an override to the CMOS settings that resets your system to its default.*

Warning: *It is strongly recommended that you avoid making any changes to the chipset defaults. These defaults have been carefully chosen by both Award and your system manufacturer to provide the absolute maximum performance and reliability. Changing the defaults could cause the system to become unstable and crash in some cases.*

Standard CMOS Setup

“Standard CMOS Setup” choice allows you to record some basic hardware configurations in your computer system and set the system clock and error handling. If the motherboard is already installed in a working system, you will not need to select this option. You will need to run the Standard CMOS option, however, if you change your system hardware configurations, the onboard battery fails, or the configuration stored in the CMOS memory was lost or damaged.

Phoenix - AwardBIOS CMOS Setup Utility
Standard CMOS Features

Date (mm:dd:yy)	Thu, May 21, 2001	Item Help
Time (hh:mm:ss)	00 : 00 : 00	Menu Level
IDE Channel 0 Master	None	Change the day, month, Year and century
IDE Channel 0 Slave	None	
IDE Channel 1 Master	None	
IDE Channel 1 Slave	None	
IDE Channel 2 Master	None	
IDE Channel 3 Master	None	
Drive A	1.44M, 3.5 in.	
Drive B	None	
Video	EGA/VGA	
Halt On	All Errors	
Base Memory	640K	
Extended Memory	129024K	
Total Memory	130048K	

At the bottom of the menu are the control keys for use on this menu. If you need any help in each item field, you can press the <F1> key. It will display the relevant information to help you. The memory display at the lower right-hand side of the menu is read-only. It will adjust automatically according to the memory changed. The following describes each item of this menu.

Date

The date format is:

Day : Sun to Sat
Month : 1 to 12
Date : 1 to 31
Year : 1994 to 2079

To set the date, highlight the “Date” field and use the PageUp/ PageDown or +/- keys to set the current time.

Time

The time format is: **Hour : 00 to 23**
Minute : 00 to 59
Second : 00 to 59

To set the time, highlight the "Time" field and use the <PgUp>/ <PgDn> or +/- keys to set the current time.

IDE Primary HDDs / IDE Secondary HDDs

The onboard PCI IDE connectors provide Primary and Secondary channels for connecting up to four IDE hard disks or other IDE devices. Each channel can support up to two hard disks; the first is the "Master" and the second is the "Slave".

Press <Enter> to configure the hard disk. The selections include Auto, Manual, and None. Select 'Manual' to define the drive information manually. You will be asked to enter the following items.

CYLS : Number of cylinders
HEAD : Number of read/write heads
PRECOMP : Write precompensation
LANDZ : Landing zone
SECTOR : Number of sectors

The Access Mode selections are as follows:

Auto
Normal (HD < 528MB)
Large (for MS-DOS only)
LBA (HD > 528MB and supports
Logical Block Addressing)

Remarks: The main board supports two serial ATA ports and are represented in this setting as IDE Channel 2 / 3 Master.

Drive A / Drive B

These fields identify the types of floppy disk drive A or drive B that has been installed in the computer. The available specifications are:

360KB	1.2MB	720KB	1.44MB	2.88MB
5.25 in.	5.25 in.	3.5 in.	3.5 in.	3.5 in.

Video

This field selects the type of video display card installed in your system. You can choose the following video display cards:

EGA/VGA	For EGA, VGA, SEGA, SVGA or PGA monitor adapters. (default)
CGA 40	Power up in 40 column mode.
CGA 80	Power up in 80 column mode.
MONO	For Hercules or MDA adapters.

Halt On

This field determines whether or not the system will halt if an error is detected during power up.

No errors	The system boot will not be halted for any error that may be detected.
All errors	Whenever the BIOS detects a non-fatal error, the system will stop and you will be prompted.
All, But Keyboard	The system boot will not be halted for a keyboard error; it will stop for all other errors
All, But Diskette	The system boot will not be halted for a disk error; it will stop for all other errors.
All, But Disk/Key	The system boot will not be halted for a keyboard or disk error; it will stop for all others.

Advanced BIOS Features

This section allows you to configure and improve your system and allows you to set up some system features according to your preference.

Phoenix - AwardBIOS CMOS Setup Utility
Advanced BIOS Features

		ITEM HELP
Hard Disk Boot Priority	Press Enter	Menu Level
CPU L1 and L2 Cache	Enabled	
Hyper-threading Technology	Enabled	
Quick Power On Self Test	Enabled	
First Boot Device	Floppy	Select Hard Disk Boot Device
Second Boot Device	Hard Disk	Priority
Third Boot Device	CD-ROM	
Boot Other Device	Enabled	
Swap Floppy Drive	Disabled	
Boot Up Floppy Seek	Disabled	
Boot Up Numlock Status	On	
Gate A20 Option	Fast	
Typematic Rate Setting	Disabled	
Typematic Rate (chars/Sec)	6	
Typematic Delay (Msec)	250	
Security Option	Setup	
APIC Mode	Enabled	
MPS Version Control for OS	1.4	
OS Select For DRAM>64MB	Non-OS2	
Report No FDD For WIN 95	Yes	
Small Logo (EPA) Show	Enabled	

Hard Disk Boot Priority

This item allows you to set the priority for hard disk boot. When you press enter, the selections shows the current hard disks used in your system as well as the "Bootable Add-in Card" that is relevant to other boot sources media such as SCSI cards and LAN cards.

CPU L1 and L2 Cache

Cache memory is additional memory that is much faster than conventional DRAM (system memory). CPUs from 486-type on up contain internal cache memory, and most, but not all, modern PCs have additional (external) cache memory. When the CPU requests data, the system transfers the requested data from the main DRAM into cache memory, for even faster access by the CPU. These items allow you to enable (speed up memory access) or disable the cache function. By default, these items are Enabled.

Hyper-Threading Technology

This feature is enabled when your processor supports Hyper-Threading Technology. Otherwise, this field will be hidden.

Quick Power On Self Test

When enabled, this field speeds up the Power On Self Test (POST) after the system is turned on. If it is set to *Enabled*, BIOS will skip some items.

First/Second/Third Boot Device

These fields determine the drive that the system searches first for an operating system. The options available include *Floppy*, *LS120*, *Hard Disk*, *CDROM*, *ZIP100*, *USB-FDD*, *USB-CDROM* and *Disable*.

Boot Other Device

These fields allow the system to search for an operating system from other devices other than the ones selected in the First/Second/Third Boot Device.

Swap Floppy Drive

This item allows you to determine whether or not to enable Swap Floppy Drive. When enabled, the BIOS swaps floppy drive assignments so that Drive A becomes Drive B, and Drive B becomes Drive A. By default, this field is set to *Disabled*.

Boot Up Floppy Seek

This feature controls whether the BIOS checks for a floppy drive while booting up. If it cannot detect one (either due to improper configuration or its absence), it will flash an error message.

Boot Up NumLock Status

This allows you to activate the NumLock function after you power up the system.

Gate A20 Option

This field allows you to select how Gate A20 is worked. Gate A20 is a device used to address memory above 1 MB.

Typematic Rate Setting

When disabled, continually holding down a key on your keyboard will generate only one instance. When enabled, you can set the two typematic controls listed next. By default, this field is set to *Disabled*.

Typematic Rate (Chars/Sec)

When the typematic rate is enabled, the system registers repeated keystrokes speeds. Settings are from 6 to 30 characters per second.

Typematic Delay (Msec)

When the typematic rate is enabled, this item allows you to set the time interval for displaying the first and second characters. By default, this item is set to *250msec*.

Security Option

This field allows you to limit access to the System and Setup. The default value is *Setup*. When you select *System*, the system prompts for the User Password every time you boot up. When you select *Setup*, the system always boots up and prompts for the Supervisor Password only when the Setup utility is called up.

APIC Mode

APIC stands for Advanced Programmable Interrupt Controller. The default setting is *Enabled*.

MPS Version Control for OS

This option specifies the MPS (Multiprocessor Specification) version for your operating system. MPS version 1.4 added extended configuration tables to improve support for multiple PCI bus configurations and improve future expandability. The default setting is *1.4*.

OS Select for DRAM > 64MB

This option allows the system to access greater than 64MB of DRAM memory when used with OS/2 that depends on certain BIOS calls to access memory. The default setting is *Non-OS/2*.

Report No FDD For WIN 95

If you are using Windows 95/98 without a floppy disk drive, select Enabled to release IRQ6. This is required to pass Windows 95/98's SCT test. You should also disable the Onboard FDC Controller in the Integrated Peripherals screen when there's no floppy drive in the system. If you set this feature to Disabled, the BIOS will not report the missing floppy drive to Win95/98.

Small Logo (EPA) Show

The EPA logo appears at the right side of the monitor screen when the system is boot up. The default setting is *Enabled*.

Advanced Chipset Features

This Setup menu controls the configuration of the chipset.

Phoenix - AwardBIOS CMOS Setup Utility
Advanced Chipset Features

DRAM Timing Selectable	By SPD	ITEM HELP
CAS Latency Time	2.5	Menu Level
Active to Precharge Delay	7	
DRAM RAS# to CAS# Delay	3	
DRAM RAS# Precharge	3	
Memory Frequency For	Auto	
System BIOS Cacheable	Enabled	
Video BIOS Cacheable	Enabled	
Memory Hole at 15M-16M	Disabled	
Delay Prior to Thermal	16 Min	
AGP Aperture Size (MB)	128	
Init Display First	PCI Slot	
DRAM Data Integrity Mode	Non-ECC	

DRAM Timing Selectable

This option refers to the method by which the DRAM timing is selected. The default is **By SPD**.

CAS Latency Time

You can configure CAS latency time in HCLKs as 2 or 2.5 or 3. The system board designer should set the values in this field, depending on the DRAM installed. Do not change the values in this field unless you change specifications of the installed DRAM or the installed CPU.

Active to Precharge Delay

The default setting for the Active to Precharge Delay is **7**.

DRAM RAS# to CAS# Delay

This option allows you to insert a delay between the RAS (Row Address Strobe) and CAS (Column Address Strobe) signals. This delay occurs when the SDRAM is written to, read from or refreshed. Reducing the delay improves the performance of the SDRAM.

DRAM RAS# Precharge

This option sets the number of cycles required for the RAS to accumulate its charge before the SDRAM refreshes. The default setting for the Active to Precharge Delay is **3**.

Memory Frequency For

This field sets the frequency of the DRAM memory installed. The default setting is *Auto*. The other settings are *DDR266*, *DDR333*, *DDR320* and *DDR400*.

System BIOS Cacheable

The setting of *Enabled* allows caching of the system BIOS ROM at F000h-FFFFh, resulting in better system performance. However, if any program writes to this memory area, a system error may result.

Video BIOS Cacheable

The Setting *Enabled* allows caching of the video BIOS ROM at C0000h-F7FFFh, resulting in better video performance. However, if any program writes to this memory area, a system error may result.

Memory Hole At 15M-16M

In order to improve performance, certain space in memory can be reserved for ISA cards. This memory must be mapped into the memory space below 16 MB. The choices are *Enabled* and *Disabled*.

Delay Prior to Thermal

This field activates the CPU thermal function after the systems boots for the set number of minutes. The options are *16Min* and *64Min*.

AGP Aperture Size

The field sets aperture size of the graphics. The aperture is a portion of the PCI memory address range dedicated for graphics memory address space. Host cycles that hit the aperture range are forwarded to the AGP without any translation. The default setting is *128M*.

Init Display First

This field allows the system to initialize first the VGA on chip or the display card on the PCI Slot.

DRAM Data Integrity Mode

This BIOS feature controls the ECC feature of the memory controller. ECC, which stands for Error Checking and Correction, enables the memory controller to detect and correct single-bit soft memory errors. The memory controller will also be able to detect double-bit errors although it will not be able to correct them. This provides increased data integrity and system stability. However, this feature can only be enabled if you are using special ECC memory modules.

Integrated Peripherals

This section sets configurations for your hard disk and other integrated peripherals. The first screen shows three main items for user to select. Once an item selected, a submenu appears. Details follow.

Phoenix - AwardBIOS CMOS Setup Utility
Integrated Peripherals

On-Chip Primary IDE Device	Press Enter	ITEM HELP
Onboard Device	Press Enter	Menu Level
SuperIO Device	Press Enter	

Phoenix - AwardBIOS CMOS Setup Utility
OnChip IDE Device

IDE Block Mode	Enabled	ITEM HELP
IDE DMA transfer access	Enabled	Menu Level
On-Chip Primary PCI IDE	Enabled	If your IDE hard drive supports block mode select Enabled for automatic detection of the optimal number of block read/writes per sector the drive can support
IDE Primary Master PIO	Auto	
IDE Primary Slave PIO	Auto	
IDE Primary Master UDMA	Auto	
IDE Primary Slave UDMA	Auto	
On-Chip Secondary PCI IDE	Enabled	
IDE Secondary Master PIO	Auto	
IDE Secondary Slave PIO	Auto	
IDE Secondary Master UDMA	Auto	
IDE Secondary Slave UDMA	Auto	
*** On-Chip Serial ATA Setting ***		
SATA Mode	IDE	
On-Chip Serial ATA	Auto	
Serial ATA Port0 Mode	SATA0 master	
Serial ATA Port1 Mode	SATA1 master	

Phoenix - AwardBIOS CMOS Setup Utility
Onboard Device

USB Controller	Enabled	ITEM HELP
USB 2.0 Controller	Disabled	Menu Level
USB Keyboard Support	Disabled	
USB Mouse Support	Disabled	
AC97 Audio	Auto	
LAN Controller	Enabled	

Phoenix - AwardBIOS CMOS Setup Utility
SuperIO Device

		ITEM HELP
Onboard FDC Controller	Enabled	Menu Level
Onboard Serial Port 1	3F8/IRQ4	
Onboard Serial Port 2	2F8/IRQ3	
UART Mode Select	Normal	
RxD , TxD Active	Hi, Lo	
IR Transmission Delay	Enabled	
UR2 Duplex Mode	Half	
Use IR Pins	IR-Rx2Tx2	
Onboard Parallel Port	378/IRQ7	
Parallel Port Mode	SPP	
EPP Mode Select	EPP1.7	
ECP Mode Use DMA	3	
Onboard Serial Port 3	3E8H	
Serial Port 3 Use IRQ	IRQ5	
Onboard Serial Port 4	Disabled	
Serial Port 4 Use IRQ	IRQ10	
Chip Select Pin	Disabled	

IDE HDD Block Mode

This field allows your hard disk controller to use the fast block mode to transfer data to and from your hard disk drive.

IDE DMA Transfer Access

Allows IDE transfer to be done in DMA mode

OnChip Primary/Secondary PCI IDE

The integrated peripheral controller contains an IDE interface with support for two IDE channels. Select *Enabled* to activate each channel separately.

IDE Primary/Secondary Master/Slave PIO

These fields allow your system hard disk controller to work faster. Rather than have the BIOS issue a series of commands that transfer to or from the disk drive, PIO (Programmed Input/Output) allows the BIOS to communicate with the controller and CPU directly.

The system supports five modes, numbered from 0 (default) to 4, which primarily differ in timing. When Auto is selected, the BIOS will select the best available mode.

IDE Primary/Secondary Master/Slave UDMA

These fields allow your system to improve disk I/O throughput to 33Mb/sec with the Ultra DMA/33 feature. The options are *Auto* and *Disabled*.

On-Chip Serial ATA

The default setting of *Auto* allows the Serial ATA drive to be enabled, when the system detects one.

USB Controller

The options for this field are *Enabled* and *Disabled*. By default, this field is set to *Enabled*.

USB 2.0 Controller

The options for this field are *Enabled* and *Disabled*. By default, this field is set to *Disabled*. In order to use USB 2.0, necessary OS drivers must be installed first.

USB Keyboard Support

The options for this field are *Enabled* and *Disabled*. By default, this field is set to *Disabled*.

USB Mouse Support

The options for this field are *Enabled* and *Disabled*. By default, this field is set to *Disabled*.

AC97 Audio

The default setting of the AC97 Audio is *Auto*.

LAN Controller

The default setting of the LAN controller is *Enabled*.

Onboard FDC Controller

Select *Enabled* if your system has a floppy disk controller (FDC) installed on the motherboard and you wish to use it. If you install an add-in FDC or the system has no floppy drive, select *Disabled* in this field. This option allows you to select the onboard FDD port.

Onboard Serial/Parallel Port

These fields allow you to select the onboard serial and parallel ports and their addresses. The default values for these ports are:

Serial Port 1	3F8/IRQ4
Serial Port 2	2F8/IRQ3
Serial Port 3	3E8H/IRQ5
Serial Port 4	Disabled
Parallel Port	378H/IRQ7

UART Mode Select

This field determines the UART 2 mode in your computer. The default value is *Normal*. Other options include *IrDA* and *ASKIR*.

Parallel Port Mode

This field allows you to determine parallel port mode function.

SPP	Standard Printer Port
EPP	Enhanced Parallel Port
ECP	Extended Capabilities Port

Chip Select Pin

This item is used in conjunction with the digital I/O function.

Power Management Setup

The Power Management Setup allows you to save energy of your system effectively.

Phoenix - AwardBIOS CMOS Setup Utility
Power Management Setup

ACPI Function	Enabled	ITEM HELP
Power Management	User Define	Menu Level
Video Off Method	V/H SYNC+Blank	
Video Off In Suspend	Yes	
Suspend Type	Stop Grant	
Modem Use IRQ	3	
Suspend Mode	Disabled	
HDD Power Down	Disabled	
Soft-Off by PWR-BTTN	Instant-Off	
CPU THRM-Throttling	50%	
Wake-Up by PCI Card	Disabled	
Power On by Ring	Disabled	
Wake Up on Lan	Disabled	
Resume by Alarm	Disabled	
Date (of Month) Alarm	0	
Time (hh:mm:ss) Alarm	0 : 0 : 0	
** Reload Global Timer Events **		
Primary IDE 0	Enabled	
Primary IDE 1	Enabled	
Secondary IDE 0	Enabled	
Secondary IDE 1	Enabled	
FDD, COM, LPT Port	Enabled	
PCI PIRQ(A-D) #	Enabled	

ACPI Function

Enable this function to support ACPI (Advance Configuration and Power Interface).

Power Management

This field allows you to select the type of power saving management modes. There are four selections for Power Management.

Min. Power Saving	Minimum power management
Max. Power Saving	Maximum power management.
User Define	Each of the ranges is from 1 min. to 1hr. Except for HDD Power Down which ranges from 1 min. to 15 min.

Video Off Method

This field defines the Video Off features. There are three options.

V/H SYNC + Blank	Default setting, blank the screen and turn off vertical and horizontal scanning.
DPMS	Allows BIOS to control the video display.
Blank Screen	Writes blanks to the video buffer.

Video Off In Suspend

When enabled, the video is off in suspend mode. The default setting is *Yes*.

Suspend Type

The default setting for the Suspend Type field is *Stop Grant*.

Modem Use IRQ

This field sets the IRQ used by the Modem. By default, the setting is **3**.

Suspend Mode

When enabled, and after the set time of system inactivity, all devices except the CPU will be shut off.

HDD Power Down

When enabled, and after the set time of system inactivity, the hard disk drive will be powered down while all other devices remain active.

Soft-Off by PWRBTN

This field defines the power-off mode when using an ATX power supply. The *Instant Off* mode allows powering off immediately upon pressing the power button. In the *Delay 4 Sec* mode, the system powers off when the power button is pressed for more than four seconds or enters the suspend mode when pressed for less than 4 seconds.

CPU THRM-Throttling

When the system enters Doze mode, the CPU clock runs only part of the time. You may select the percent of time that the clock runs.

Wake-Up by PCI Cards

Enable this field to allow wake up function through a PCI card.

Power On by Ring

This field enables or disables the power on of the system through the modem connected to the serial port or LAN.

Wake Up On LAN

Enable this field to allow wake up function through the onboard LAN.

Resume by Alarm

This field enables or disables the resumption of the system operation. When enabled, the user is allowed to set the *Date* and *Time*.

Reload Global Timer Events

The HDD, FDD, COM, LPT Ports, and PCI PIRQ are I/O events that can prevent the system from entering a power saving mode or can awaken the system from such a mode. When an I/O device wants to gain the attention of the operating system, it signals this by causing an IRQ to occur. When the operating system is ready to respond to the request, it interrupts itself and performs the service.

PNP/PCI Configurations

This option configures the PCI bus system. All PCI bus systems on the system use INT#, thus all installed PCI cards must be set to this value.

Phoenix - AwardBIOS CMOS Setup Utility
PnP/PCI Configurations

PNP OS Install	No	ITEM HELP
Reset Configuration Data	Disabled	Menu Level
Resources Controlled By	Auto (ESCD)	Default is Disabled. Select Enabled to reset Extended System Configuration Data (ESCD) when you exit Setup if you have installed a new add-on and the system reconfiguration has caused such a serious conflict that the OS cannot boot
IRQ Resources	Press Enter	
DMA Resources	Press Enter	
PCI/VGA Palette Snoop	Disabled	
INT Pin 1 Assignment	Auto	
INT Pin 2 Assignment	Auto	
INT Pin 3 Assignment	Auto	
INT Pin 4 Assignment	Auto	
INT Pin 5 Assignment	Auto	
INT Pin 6 Assignment	Auto	
INT Pin 7 Assignment	Auto	
INT Pin 8 Assignment	Auto	

PNP OS Install

Enable the PNP OS Install option if it is supported by the operating system installed. The default value is *No*.

Reset Configuration Data

This field allows you to determine whether to reset the configuration data or not. The default value is *Disabled*.

Resources Controlled by

This PnP BIOS can configure all of the boot and compatible devices automatically with the use of a use a PnP operating system such as Windows 95.

PCI/VGA Palette Snoop

Some non-standard VGA display cards may not show colors properly. This field allows you to set whether or not MPEG ISA/VESA VGA cards can work with PCI/VGA. When this field is enabled, a PCI/VGA can work with an MPEG ISA/VESA VGA card. When this field is disabled, a PCI/VGA cannot work with an MPEG ISA/VESA card.

PC Health Status

This section shows the parameters in determining the PC Health Status. These parameters include temperatures, fan speeds and voltages.

Phoenix - AwardBIOS CMOS Setup Utility
PC Health Status

CPU Warning Temperature	Disabled	ITEM HELP
System Temp.		Menu Level
CPU Temp		
CPU FAN Speed (FAN1)		
System FAN Speed (FAN3)		
Chassis FAN Speed (FAN2)		
Vcore (V)		
+3.3V		
+5V		
+12V		
-12V		
VBAT		
5VSB(V)		
Shutdown Temperature	Disabled	
CPU Fan Failure Warning	Disabled	
Sys. FAN Failure Warning	Disabled	
Cha. FAN Failure Warning	Disabled	

CPU Warning Temperature

This field allows the user to set the temperature so that when the temperature is reached, the system sounds a warning. This function can help prevent damage to the system that is caused by overheating.

Temperatures/Fan Speeds/Voltages

These fields are the parameters of the hardware monitoring function feature of the motherboard. The values are read-only values as monitored by the system and show the PC health status.

Shutdown Temperature

This field allows the user to set the temperature by which the system automatically shuts down once the threshold temperature is reached. This function can help prevent damage to the system that is caused by overheating.

CPU/System/Chassis Fan Failure Warning

When enabled, this field lets the system sounds an audible warning to the user that the CPU fan or chassis fan has malfunctioned.

Frequency/Voltage Control

This section shows the user how to configure the processor frequency.

Phoenix - AwardBIOS CMOS Setup Utility
Frequency/Voltage Control

Auto Detect DIMM/PCI Clk	Disabled	ITEM HELP
Spread Spectrum	Disabled	Menu Level

Auto Detect DIMM/PCI Clk

This field enables or disables the auto detection of the PCI clock.

Spread Spectrum

This field sets the value of the spread spectrum. The default setting is *Disabled*. This field is for CE testing use only.

Load Fail-Safe Defaults

This option allows you to load the troubleshooting default values permanently stored in the BIOS ROM. These default settings are non-optimal and disable all high-performance features.

Load Setup Defaults

This option allows you to load the default values to your system configuration. These default settings are optimal and enable all high performance features.

Set Supervisor/User Password

These two options set the system password. Supervisor Password sets a password that will be used to protect the system and Setup utility. User Password sets a password that will be used exclusively on the system. To specify a password, highlight the type you want and press <Enter>. The Enter Password: message prompts on the screen. Type the password, up to eight characters in length, and press <Enter>. The system confirms your password by asking you to type it again. After setting a password, the screen automatically returns to the main screen.

To disable a password, just press the <Enter> key when you are prompted to enter the password. A message will confirm the password to be disabled. Once the password is disabled, the system will boot and you can enter Setup freely.

Save & Exit Setup

This option allows you to determine whether or not to accept the modifications. If you type “Y”, you will quit the setup utility and save all changes into the CMOS memory. If you type “N”, you will return to Setup utility.

Exit Without Saving

Select this option to exit the Setup utility without saving the changes you have made in this session. Typing “Y” will quit the Setup utility without saving the modifications. Typing “N” will return you to Setup utility.

Drivers Installation

This section describes the installation procedures for software and drivers under the Windows 98SE, Windows ME, Windows 2000 and Windows XP. The software and drivers are included with the motherboard. If you find the items missing, please contact the vendor where you made the purchase. The contents of this section include the following:

Intel® 875P Chipset Software Intallation Utility**Error! Bookma**
Realtek AC97 Codec Audio Driver Installation**Error! Bookma**
Intel® PRO LAN Drivers Installation**Error! Bookmark not def**
VGA Drivers Installation.. **Error! Bookmark not defined.**

IMPORTANT NOTE:

After installing your Windows operating system (Windows 98SE/ME/2000/XP), you must install first the Intel® Chipset Software Installation Utility before proceeding with the drivers installation.

Intel 875P Chipset Software Intallation Utility

The Intel® 875P Chipset Drivers should be installed first before the software drivers to enable Plug & Play INF support for Intel® chipset components. Follow the instructions below to complete the installation under Windows 98SE/ME/2000/XP.

1. Insert the CD that comes with the motherboard and the screen below would appear. Click Intel Chipsets and then Intel(R) 875P Chipset Drivers.

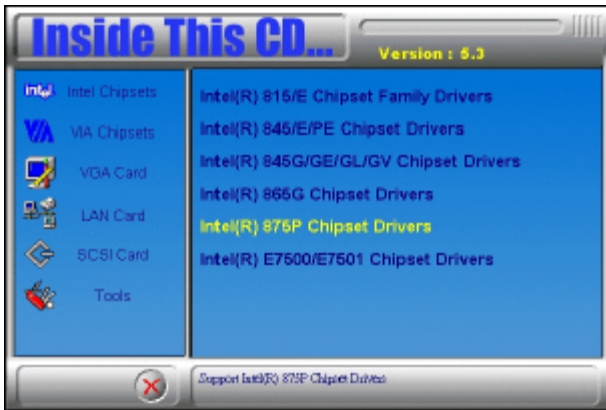

2. Click Intel(R) Chipset Software Intallation Utility.

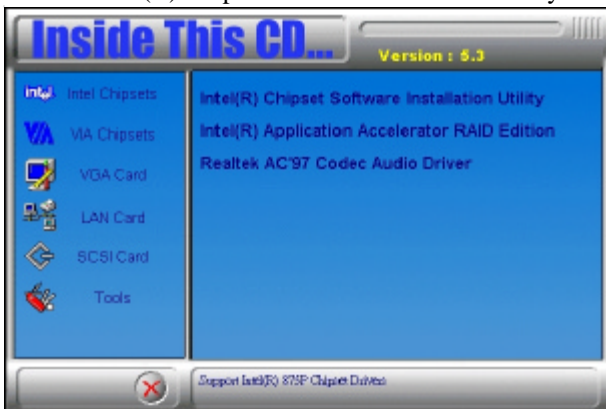

3. When the Welcome screen appears, click Next to continue.

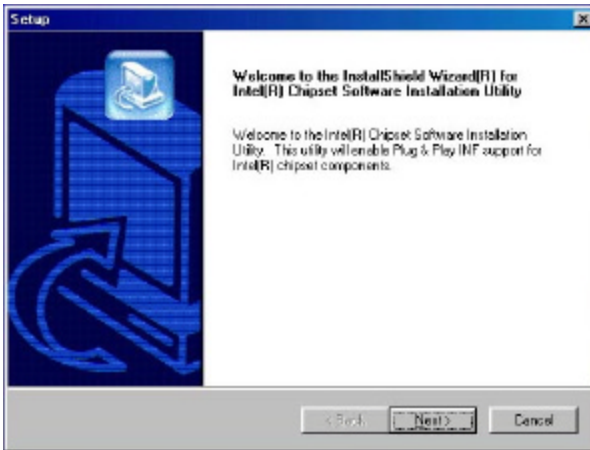

4. Click Yes to accept the software license agreement and proceed with the installation process.

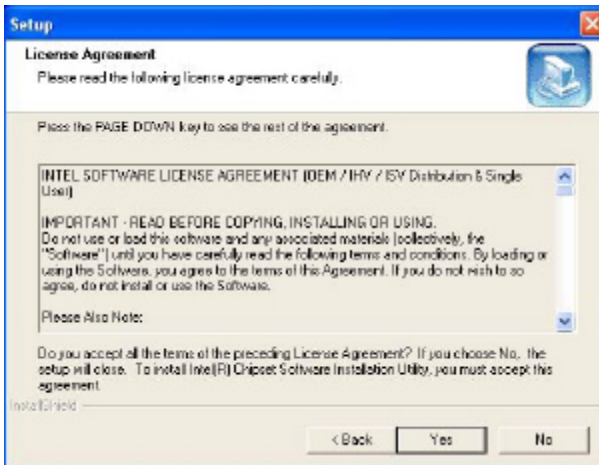

5. On Readme Information screen, click Next to continue the installation.

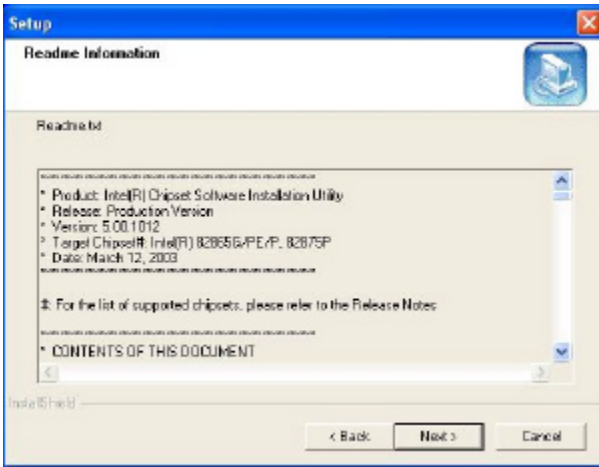

6. The Setup process is now complete. Click Finish to restart the computer and for changes to take effect. When the computer has restarted, the system will be able to find some devices. Restart your computer when prompted.

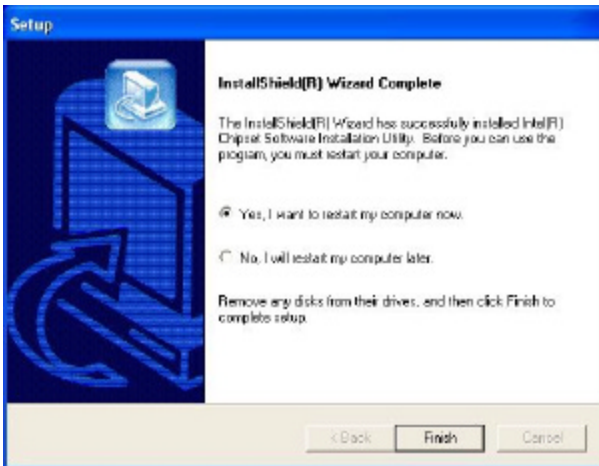

Realtek AC97 Codec Audio Driver Installation

Follow the steps below to install the Realtek AC97 Codec Audio Drivers.

1. Insert the CD that comes with the motherboard and the screen below would appear. Click Intel(R) Chipsets, then Intel(R) 875P Chipset Family Drivers. Click Realtek AC97 Codec Audio Drivers to start installation.

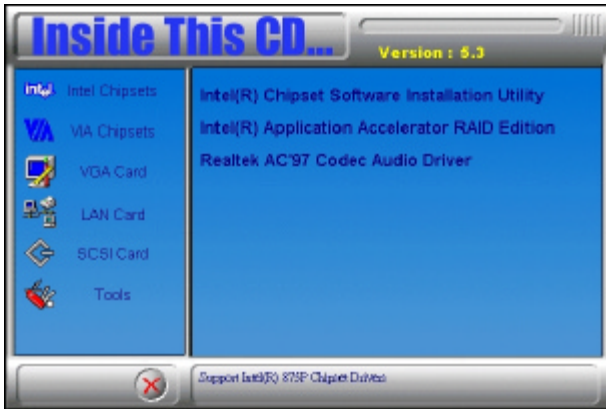

2. Click Finish to restart the computer and for changes to take effect. .

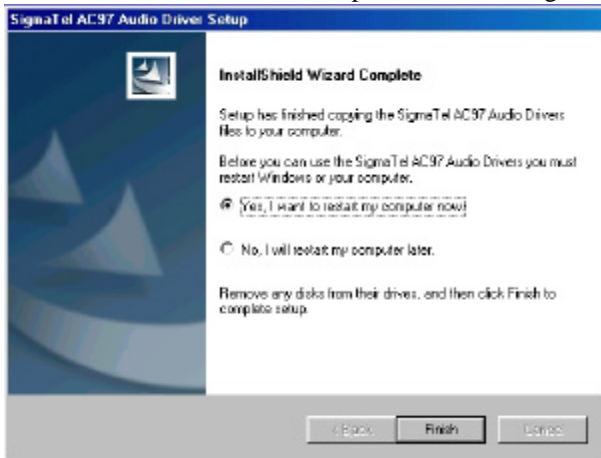

Intel PRO LAN Drivers Installation

The Intel® PRO LAN drivers support both Intel® PRO/100 and PRO/1000 drivers. Follow the steps below to complete the installation.

1. Insert the CD that comes with the motherboard and the screen below would appear. Click on LAN Card on the left side to make the LAN drivers selection. Click on Intel(R) PRO LAN Drivers.

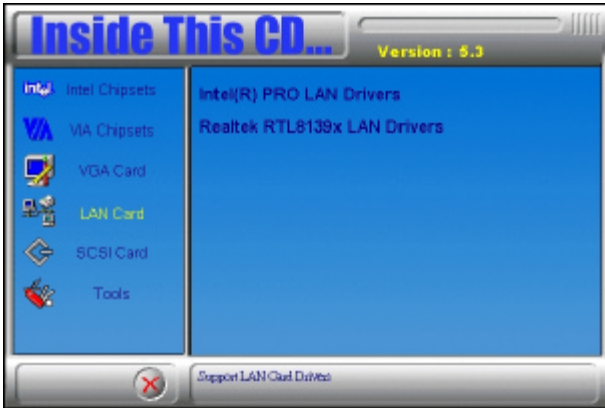

2. Click Install Software to continue.



3. When prompted, click Restart to restart the computer for new settings to take effect.

VGA Drivers Installation

To install the SMI VGA drivers (SMI SM712), follow the steps below to proceed with the installation.

1. Insert the CD that comes with the MB820 and the screen below would appear. Click VGA Card on the left side.

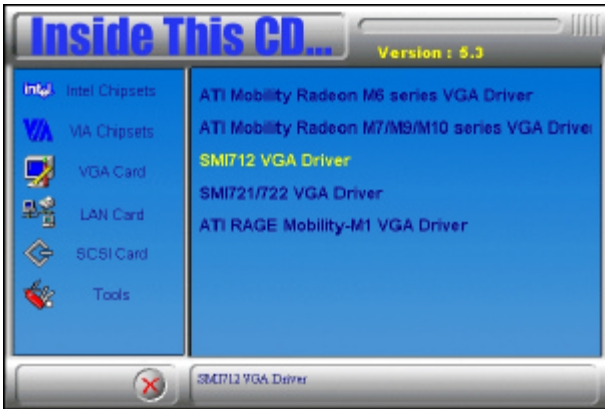

2. On the right side of the screen, click on SMI712 VGA Driver.

3. A Welcome screen would then appear. Click Next to start copying of files needed for the driver installation.

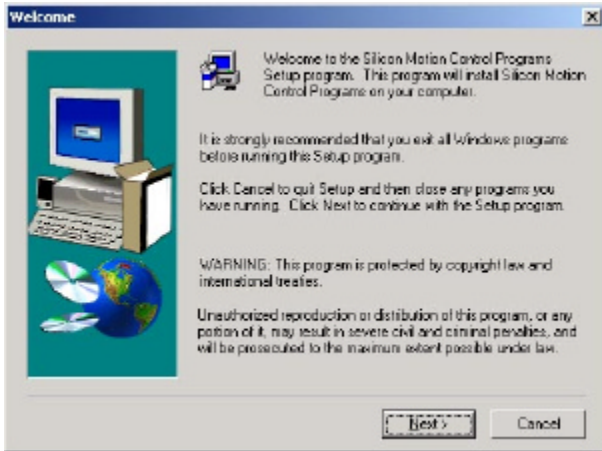

4. After file copying is done, restart the computer when prompted for changes to take effect.

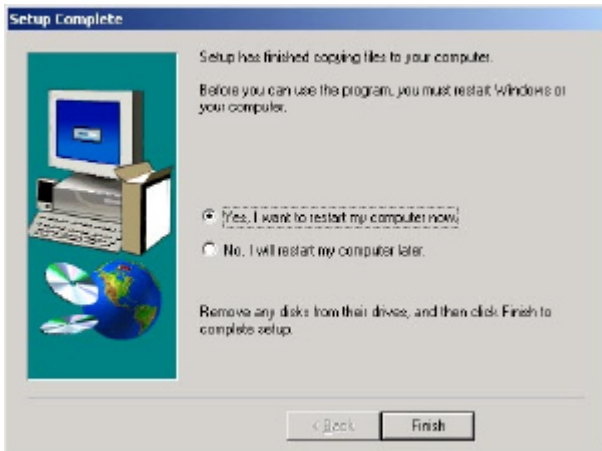

Free Manuals Download Website

<http://myh66.com>

<http://usermanuals.us>

<http://www.somanuals.com>

<http://www.4manuals.cc>

<http://www.manual-lib.com>

<http://www.404manual.com>

<http://www.luxmanual.com>

<http://aubethermostatmanual.com>

Golf course search by state

<http://golfingnear.com>

Email search by domain

<http://emailbydomain.com>

Auto manuals search

<http://auto.somanuals.com>

TV manuals search

<http://tv.somanuals.com>