

MB900-R

Socket LGA775 Pentium® 4
Intel® 945G Chipset
Industrial Motherboard

USER'S MANUAL

Version 1.0

Acknowledgments

Award is a registered trademark of Award Software International, Inc.

PS/2 is a trademark of International Business Machines Corporation.

Intel and Pentium 4 are registered trademarks of Intel Corporation.

Microsoft Windows is a registered trademark of Microsoft Corporation.

Winbond is a registered trademark of Winbond Electronics Corporation.

All other product names or trademarks are properties of their respective owners.

Table of Contents

Introduction	1
Checklist	1
MB900-R Specifications	2
Board Dimensions	3
Installations	4
Installing the CPU	5
ATX Power Installation	6
Installing the Memory	6
Setting the Jumpers	7
Connectors on MB900-R.....	11
Watchdog Timer Configuration	20
BIOS Setup.....	25
Drivers Installation	47
Intel 945G Chipset Software Installation Utility	48
Intel 945G Chipset Graphics Driver	50
Realtek Codec Audio Driver Installation	51
Marvell 88E8052 LAN Drivers Installation	52
Intel PRO LAN Drivers Installation.....	53
Appendix	55
A. I/O Port Address Map	55
B. Interrupt Request Lines (IRQ)	56

This page is intentionally left blank.

Introduction

Checklist

Your MB900-R Pentium® 4 motherboard package should include the items listed below:

- The MB900-R motherboard
- This User's manual
- 1 Back I/O shield
- 1 IDE cable
- 1 Floppy cable
- 1 SATA cable
- 1 Serial-Port cable
- 1 CD containing the following:
 - Chipset Drivers
 - Flash Memory Utility

MB900-R Specifications

Form Factor	Micro-ATX / 244mm x 244mm
CPU Type	Intel Pentium D (dual core) / Pentium 4 / Celeron D
CPU Voltage	0.8375V~1.6V (VRD 10.1)
System Speed	3.8GHz
CPU FSB	533/800/1066MHz
Green /APM	APM1.2
CPU Socket	Socket 775
Cache	256K/1M/2M Level 2 (CPU integrated)
Chipset	Intel 945G Chipset GMCH: 945G, 1202-pin FCBGA ICH: ICH7 652-pin mBGA; FWH
BIOS	Award BIOS Support ACPI Function
Memory	2x DDRII 533/667 DIMM Modules (w/o ECC), Max. 2GB (Dual Channels)
VGA	945G built-in, support CRT
LAN	1. ICH7 LAN controller (10/100Mb) + PHY 82562ET 2. Marvel 88E8052 PCI-Exp Gigabit LAN controller x1
USB	ICH7 built-in USB 2.0 host controller, supports 8 ports
SATA II	ICH7 built-in Serial ATA II controller (300MB/s), 2 ports
Parallel IDE	ICH7 built-in one channel Ultra DMA 33/66/100, IDE1 40-pin, 2.5mm; Compact Flash Socket x1 on IDE1
Audio	ICH7 Built-in Audio controller + AC97 Codec ALC880 8 Channel (Line-out, Line-in & Mic.), D-Sub connector
LPC I/O	Winbond W83627EHG: Parallel x1, FDC 1.44MB, COM1 (RS232), COM2 (RS232/422/485), Hardware monitor (3 thermal inputs, 4 voltage monitor inputs, VIDO-4 & 3 Fan headers). Not use IrDA
2 nd LPC I/O	Fintek F81216, supports COM3, 4 (RS232)
Expansion Slots	PCI Express x16 slot x1 PCI Express x1 slot x1 PCI slot x2
Edge Connectors	PS/2 KB/Mouse, LPT, VGA, COM1, Dual triple DIN for high definition audio, RJ45, USB x4
On Board Headers / Connectors	USB x 4, SATA x2, IDE1, FDD, COM2/3/4, IrDA, audio (line out / Mic)
Power Connector	ATX 12V (24 pin + 8 pin)
System Voltage	+5V, +3.3V, +12V, -12V & 5VSB (2A)
Other	Modem Wakeup & LAN Wakeup
Watchdog Timer	Yes (256 segments: 0, 1, 2..., 255 sec/min)
Digital I/O	4 In / 4 Out
BIOS Function	<ul style="list-style-type: none"> - Power on after power fail - Boot from USB/CDROM/USBZIP/USBHDD/USB/HDD & PXE boot - Supports PC health monitoring for CPU, power supply, Aux temperatures and voltages. Supports CPU overheating protection

Remarks: MB900-R supports both Pentium® D dual core CPU and Pentium® 4 single core CPU. It also supports EMT64 processors.

Board Dimensions

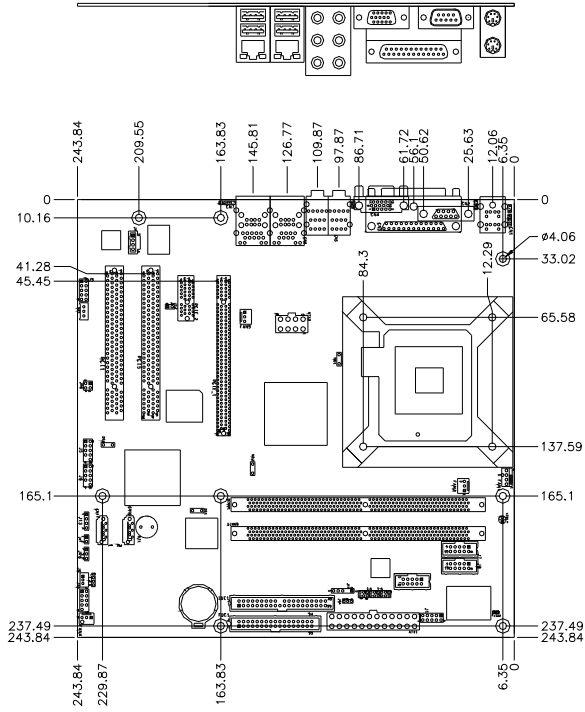

Installations

This section provides information on how to use the jumpers and connectors on the MB900-R in order to set up a workable system. The topics covered are:

Installing the CPU	5
ATX Power Installation	6
Installing the Memory	6
Setting the Jumpers	7
Connectors on MB900-R	11
Watchdog Timer Configuration	20

Installing the CPU

The MB900-R motherboard supports an LGA 775 processor socket for Intel® Pentium® 4 processors.

The LGA 775 processor socket comes with a lever to secure the processor. Refer to the pictures below, from left to right, on how to place the processor into the CPU socket. ***Please note that the cover of the LGA775 socket must always be installed during transport to avoid damage to the socket.***

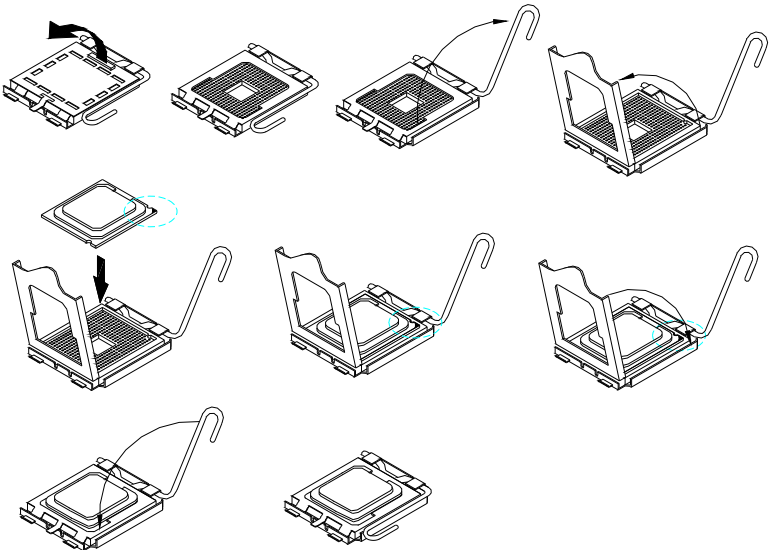

ATX Power Installation

The system power is provided to the motherboard with the ATX1 and ATX_12V power connectors. ATX1 is a 24-pin power connector and ATX_12V is a 8-pin 12V power connector.

The 24-pin power connector can to be connected to a standard 20-pin ATX power connector in a standard ATX power supply (Min. 400watt).

Note: The power supply 5VSB voltage must be at least 2A .

Installing the Memory

The MB900-R motherboard supports two DDR2 memory sockets for a maximum total memory of 2GB in DDR memory type. It supports DDR2 533/667.

Basically, the system memory interface has the following features:

- Supports two 64-bit wide DDR data channels
- Available bandwidth up to 5.3GB/s (DDR2 667) for single -channel mode and 10.7GB/s (DDR2 667) in dual -channel mode.
- Supports 256Mb, 512Mb, 1Gb DDR2 technologies.
- Supports only x8, x16, DDR2 devices with four banks
- Supports only unbuffered DIMMs
- Supports opportunistic refresh
- Up to 32 simultaneously open pages (four per row, four rows maximum)

Setting the Jumpers

Jumpers are used on MB900-R to select various settings and features according to your needs and applications. Contact your supplier if you have doubts about the best configuration for your needs. The following lists the connectors on MB900-R and their respective functions.

Jumper Locations on MB900-R	8
JP1, JP2, JP3: RS232/422/485 (COM2) Selection	9
JP4: IDE DMA Mode Setting	9
JP6: Clear CMOS Contents	9
JP7: CF Socket Master / Slave Selection	10

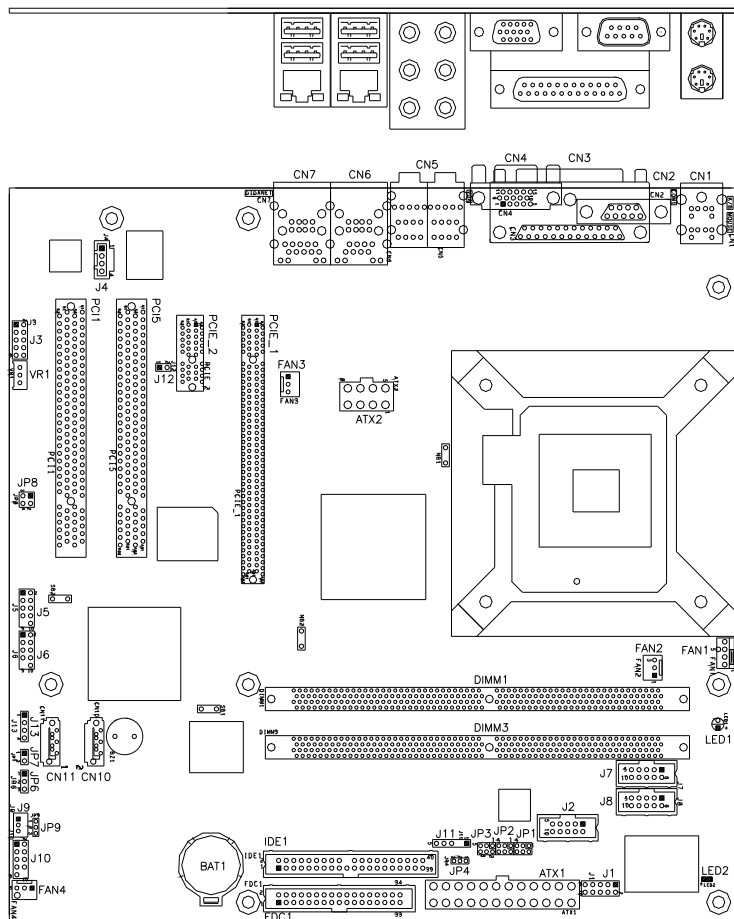

Jumper Locations on MB900-R

JP1, JP2, JP3: RS232/422/485 (COM2) Selection 9

JP4: IDE DMA Mode Setting 9

JP6: Clear CMOS Contents 9

JP7: CF Socket Master / Slave Selection 10

JP1, JP2, JP3: RS232/422/485 (COM2) Selection

COM1 is fixed for RS-232 use only.

COM2 is selectable for RS232, RS-422 and RS-485. COM3 and COM4 are fixed for RS-232 use only. The following table describes the jumper settings for COM2 selection.

COM2 Function	RS-232	RS-422	RS-485
Jumper Setting (pin closed)	JP1: 1-2	JP1: 3-4	JP1: 5-6
	JP2: 3-5 & 4-6	JP2: 1-3 & 2-4	JP2: 1-3 & 2-4
	JP3: 3-5 & 4-6	JP3: 1-3 & 2-4	JP3: 1-3 & 2-4

JP4: IDE DMA Mode Setting

JP4	Setting	Function
	Pin 1-2 Short/Closed	UDMA66 (default)
	Pin 2-3 Short/Closed	Forced UDMA33

JP6: Clear CMOS Contents

Use JP6, a 3-pin header, to clear the CMOS contents. *Note that the ATX-power connector should be disconnected from the motherboard before clearing CMOS.*

JP6	Setting	Function
	Pin 1-2 Short/Closed	Normal
	Pin 2-3 Short/Closed	Clear CMOS

JP7: CF Socket Master / Slave Selection

JP7	CF Mode
	Slave
	Master

Connectors on MB900-R

The connectors on MB900-R allows you to connect external devices such as keyboard, floppy disk drives, hard disk drives, printers, etc. The following table lists the connectors on MB900-R and their respective functions.

ATX1: 24-pin ATX Power Connector	13
ATX2: ATX 12V Power Connector	13
MB900-R Edge Connectors	13
CN1: PS/2 Keyboard and PS/2 Mouse Connectors	14
CN2, J2, J7, J8: COM1/2/3/4 Serial Ports	14
CN3: Parallel Port Connector	15
CN4: VGA CRT Connector	15
CN5: Audio Connector	16
CN6: 10/100 RJ-45 and USB0/1 Connector	16
CN7: GbE RJ-45 and USB2/3 Connector	16
CN11, CN10: SATA0/1 Connector	16
J1: Digital I/O Connector (4 in, 4 out)	17
J3: Audio Front Header	17
J5: USB4/USB5 Connector	17
J6: USB6/USB7 Connector	17
J9: Wake On LAN Connector	18
J10: System Function Connector	18
J11: IrDA Connector	18
FAN1: CPU Fan Power Connector	18
FAN2, FAN3, FAN4: Fan Power Connectors	19
IDE1: Primary IDE Connectors	19
PCIE_1: x16 PCI Express Slot	19
PCIE_2: x1 PCI Express Slot	19
PCI1, PCI5: PCI Slots	19
CN12: CF Socket	19
J12: SMBus	19

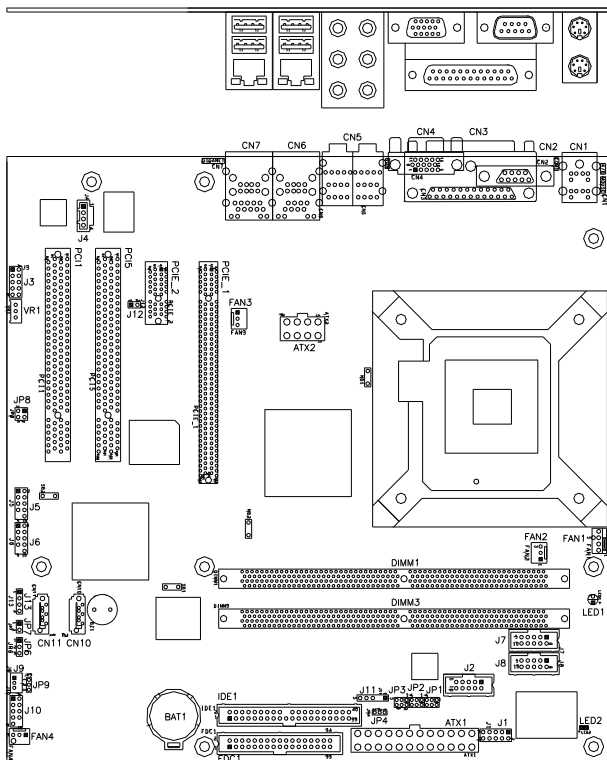

Connector Locations on MB900-R

ATX1: 24-pin ATX Power Connector	13
ATX2: ATX 12V Power Connector	13
MB900-R Edge Connectors	13
CN1: PS/2 Keyboard and PS/2 Mouse Connectors	14
CN2, J2, J7, J8: COM1/2/3/4 Serial Ports	14
CN3: Parallel Port Connector	15
CN4: VGA CRT Connector	15
CN5: Audio Connector	16
CN6: 10/100 RJ-45 and USB0/1 Connector	16
CN7: GbE RJ-45 and USB2/3 Connector	16
CN11, CN10: SATA0/1 Connector	16
J1: Digital I/O Connector (4 in, 4 out)	17
J3: Audio Front Header	17
J5: USB4/USB5 Connector	17
J6: USB6/USB7 Connector	17
J9: Wake On LAN Connector	18
J10: System Function Connector	18
J11: IrDA Connector	18
FAN1: CPU Fan Power Connector	18
FAN2, FAN3, FAN4: Fan Power Connectors	19
IDE1: Primary IDE Connectors	19
PCIE_1: x16 PCI Express Slot	19
PCIE_2: x1 PCI Express Slot	19
PCI1, PCI5: PCI Slots	19
CN12: CF Socket	19
J12: SMBus	19

ATX1: 24-pin ATX Power Connector

Signal Name	Pin #	Pin #	Signal Name
3.3V	13	1	3.3V
-12V	14	2	3.3V
Ground	15	3	Ground
PS-ON	16	4	+5V
Ground	17	5	Ground
Ground	18	6	+5V
Ground	19	7	Ground
-5V	20	8	Power good
+5V	21	9	5VSB
+5V	22	10	+12V
+5V	23	11	+12V
Ground	24	12	+3.3V

ATX2: ATX 12V Power Connector

Signal Name	Pin #	Pin #	Signal Name
+12V	5	1	Ground
+12V	6	2	Ground
+12V	7	3	Ground
+12V	8	4	Ground

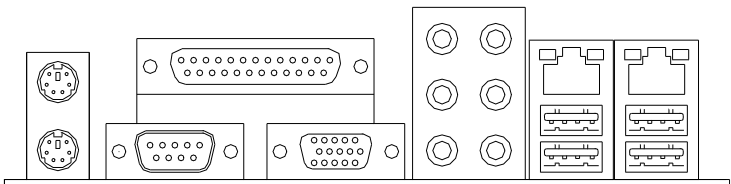

MB900-R Edge Connectors

CN1: PS/2 Keyboard and PS/2 Mouse Connectors



Mouse (top)
Keyboard (bottom)

Keyboard Signal	Pin #	Mouse Signal
Keyboard data	1	Mouse data
N.C.	2	N.C.
GND	3	GND
5V	4	5V
Keyboard clock	5	Mouse clock
N.C.	6	N.C.

CN2, J2, J7, J8: COM1/2/3/4 Serial Ports

CN2 (COM1) is a DB-9 connector, while J2, J7 and J8 are a COM pin-header connectors.

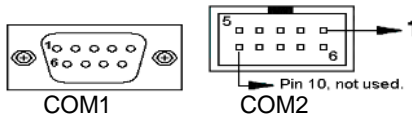

Signal Name	Pin #	Pin #	Signal Name
DCD, Data carrier detect	1	6	DSR, Data set ready
RXD, Receive data	2	7	RTS, Request to send
TXD, Transmit data	3	8	CTS, Clear to send
DTR, Data terminal ready	4	9	RI, Ring indicator
GND, ground	5	10	Not Used

COM2 is jumper selectable for RS-232, RS-422 and RS-485.

Pin #	Signal Name		
	RS-232	R2-422	RS-485
1	DCD	TX-	DATA-
2	RX	TX+	DATA+
3	TX	RX+	NC
4	DTR	RX-	NC
5	Ground	Ground	Ground
6	DSR	RTS-	NC
7	RTS	RTS+	NC
8	CTS	CTS+	NC
9	RI	CTS-	NC
10	NC	NC	NC

CN3: Parallel Port Connector

CN3 is a DB-25 external connector situated on top of the VGA and serial ports.

CN4 Parallel Port

Signal Name	Pin #	Pin #	Signal Name
Line printer strobe	1	14	AutoFeed
PD0, parallel data 0	2	15	Error
PD1, parallel data 1	3	16	Initialize
PD2, parallel data 2	4	17	Select
PD3, parallel data 3	5	18	Ground
PD4, parallel data 4	6	19	Ground
PD5, parallel data 5	7	20	Ground
PD6, parallel data 6	8	21	Ground
PD7, parallel data 7	9	22	Ground
ACK, acknowledge	10	23	Ground
Busy	11	24	Ground
Paper empty	12	25	Ground
Select	13	N/A	N/A

CN4: VGA CRT Connector

CN4 is a DB-15 VGA connector located beside the COM1 port. The following table shows the pin-out assignments of this connector.

Signal Name	Pin #	Pin #	Signal Name
Red	1	2	Green
Blue	3	4	N.C.
GND	5	6	GND
GND	7	8	GND
VCC	9	10	GND
N.C.	11	12	DDCDATA
HSYNC	13	14	VSYNC
DDCCLK	15		

CN5: Audio Connector

CN6: 10/100 RJ-45 and USB0/1 Connector

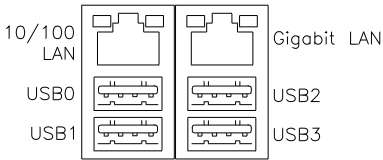

CN7: GbE RJ-45 and USB2/3 Connector

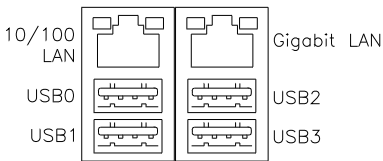

CN11, CN10: SATA0/1 Connector

Pin #	Signal Name
1	Ground
2	TX+
3	TX-
4	Ground
5	RX-
6	RX+
7	Ground

J1: Digital I/O Connector (4 in, 4 out)

This 10-pin digital I/O connector supports TTL levels and is used to control external devices requiring ON/OFF circuitry.

Signal Name	Pin #	Pin #	Signal Name
Ground	1	2	+5V
Out3	3	4	Out1
Out2	5	6	Out0
IN3	7	8	IN1
IN2	9	10	IN0

J3: Audio Front Header

Signal Name	Pin #	Pin #	Signal Name
MIC2_L	1	2	Ground
MIC2_R	3	4	Presence#
Line2_L	5	6	MIC2_ID
Sense	7	8	NC
Line2_R	9	10	Line2_ID

J5: USB4/USB5 Connector

Signal Name	Pin	Pin	Signal Name
Vcc	1	2	Vcc
D-	3	4	D-
D+	5	6	D+
Ground	7	8	Ground
Protect Pin	9	10	NC

J6: USB6/USB7 Connector

Signal Name	Pin	Pin	Signal Name
Vcc	1	2	Vcc
D-	3	4	D-
D+	5	6	D+
Ground	7	8	Ground
Protect Pin	9	10	NC

J9: Wake On LAN Connector

J9 is a 3-pin header for the Wake On LAN function on the motherboard. The following table shows the pin out assignments of this connector. Wake On LAN will function properly only with an ATX power supply with 5VSB that has 1A.

Pin #	Signal Name
1	+5VSB
2	Ground
3	LAN Wakeup

J10: System Function Connector

J10 provides connectors for system indicators that provide light indication of the computer activities and switches to change the computer status.

■

Signal Name	Pin #	Pin #	Signal Name
HD_LED+	1	2	PWR/ SLP_LED+
HD_LED-	3	4	PWR/ SLP_LED-
RST_SW-	5	6	PWR_SW+
RST_SW+	7	8	PWR_SW-
Reserved	9	10	NC

J11: IrDA Connector

Pin #	Signal Name
1	+5V
2	No connect
3	Ir RX
4	Ground
5	Ir TX

FAN1: CPU Fan Power Connector

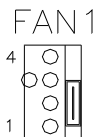

Pin #	Signal Name
1	Ground
2	+12V
3	Sense
4	Control

FAN2, FAN3, FAN4: Fan Power Connectors

Pin #	Signal Name
1	Ground
2	+12V
3	Rotation detection

IDE1: Primary IDE Connectors

Signal Name	Pin #	Pin #	Signal Name
Reset IDE	1	2	Ground
Host data 7	3	4	Host data 8
Host data 6	5	6	Host data 9
Host data 5	7	8	Host data 10
Host data 4	9	10	Host data 11
Host data 3	11	12	Host data 12
Host data 2	13	14	Host data 13
Host data 1	15	16	Host data 14
Host data 0	17	18	Host data 15
Ground	19	20	Protect pin
DRQ0	21	22	Ground
Host IOW	23	24	Ground
Host IOR	25	26	Ground
IOCHRDY	27	28	Host ALE
DACK0	29	30	Ground
IRQ14	31	32	No connect
Address 1	33	34	No connect
Address 0	35	36	Address 2
Chip select 0	37	38	Chip select 1
Activity	39	40	Ground

IDE1

PCIE_1: x16 PCI Express Slot**PCIE_2: x1 PCI Express Slot****PCI1, PCI5: PCI Slots****CN12: CF Socket****J12: SMBus**

This is a 2-pin header. Pin 1 is SMB_CLK; Pin 2 is SMB_DATA.

Watchdog Timer Configuration

The WDT is used to generate a variety of output signals after a user programmable count. The WDT is suitable for use in the prevention of system lock-up, such as when software becomes trapped in a deadlock. Under these sorts of circumstances, the timer will count to zero and the selected outputs will be driven. Under normal circumstance, the user will restart the WDT at regular intervals before the timer counts to zero.

SAMPLE CODE:

```
//=====
//
// THIS CODE AND INFORMATION IS PROVIDED "AS IS" WITHOUT WARRANTY OF ANY
// KIND, EITHER EXPRESSED OR IMPLIED, INCLUDING BUT NOT LIMITED TO THE
// IMPLIED WARRANTIES OF MERCHANTABILITY AND/OR FITNESS FOR A PARTICULAR
// PURPOSE.
//
//=====
#include <stdio.h>
#include <stdlib.h>
#include "W627EHF.H"
//=====
int main (int argc, char *argv[]);
void copyright(void);
void EnableWDT(int);
void DisableWDT(void);
//=====
int main (int argc, char *argv[])
{
    unsigned char bBuf;
    unsigned char bTime;
    char **endptr;

    copyright();

    if (argc != 2)
    {
        printf(" Parameter incorrect!!\n");
        return 1;
    }

    if (Init_W627EHF() == 0)
    {
        printf(" Winbond 83627HF is not detected, program abort. \n");
        return 1;
    }
    bTime = strtol (argv[1], endptr, 10);
    printf("System will reset after %d seconds\n", bTime);

    EnableWDT(bTime);

    return 0;
}
//=====
```



```

void copyright(void)
{
    printf("\n===== Winbond 83627EHF Watch Timer Tester (AUTO DETECT) ===== \n\n")
        "      Usage : W627E_WD reset_time\n\n"
        "      Ex : W627E_WD 3 => reset system after 3 second\n\n"
        "           W627E_WD 0 => disable watch dog timer\n\n");
}
//=====
void EnableWDT(int interval)
{
    unsigned char bBuf;

    bBuf = Get_W627EHF_Reg( 0x2D);
    bBuf &= (~0x01);
    Set_W627EHF_Reg( 0x2D, bBuf);           //Enable WDTO

    Set_W627EHF_LD( 0x08);                 //switch to logic device 8
    Set_W627EHF_Reg( 0x30, 0x01);         //enable timer

    bBuf = Get_W627EHF_Reg( 0xF5);
    bBuf &= (~0x08);
    Set_W627EHF_Reg( 0xF5, bBuf);         //count mode is second

    Set_W627EHF_Reg( 0xF6, interval);     //set timer
}
//=====
void DisableWDT(void)
{
    Set_W627EHF_LD(0x08);                 //switch to logic device 8
    Set_W627EHF_Reg(0xF6, 0x00);         //clear watchdog timer
    Set_W627EHF_Reg(0x30, 0x00);         //watchdog disabled
}
//=====

```

```

=====
//
// THIS CODE AND INFORMATION IS PROVIDED "AS IS" WITHOUT WARRANTY OF ANY
// KIND, EITHER EXPRESSED OR IMPLIED, INCLUDING BUT NOT LIMITED TO THE
// IMPLIED WARRANTIES OF MERCHANTABILITY AND/OR FITNESS FOR A PARTICULAR
// PURPOSE.
//
=====
#include "W627EHF.H"
#include <dos.h>
=====
unsigned int W627EHF_BASE;
void Unlock_W627EHF (void);
void Lock_W627EHF (void);
=====
unsigned int Init_W627EHF(void)
{
    unsigned int result;
    unsigned char ucDid;

    W627EHF_BASE = 0x2E;
    result = W627EHF_BASE;

    ucDid = Get_W627EHF_Reg(0x20);
    if (ucDid == 0x88)
    {
        goto Init_Finish;
    }

    W627EHF_BASE = 0x4E;
    result = W627EHF_BASE;
    ucDid = Get_W627EHF_Reg(0x20);
    if (ucDid == 0x88)
    {
        goto Init_Finish;
    }

    W627EHF_BASE = 0x00;
    result = W627EHF_BASE;

Init_Finish:
    return (result);
}
=====
void Unlock_W627EHF (void)
{
    outportb(W627EHF_INDEX_PORT, W627EHF_UNLOCK);
    outportb(W627EHF_INDEX_PORT, W627EHF_UNLOCK);
}
=====
void Lock_W627EHF (void)
{
    outportb(W627EHF_INDEX_PORT, W627EHF_LOCK);
}
=====
void Set_W627EHF_LD( unsigned char LD)
{
    Unlock_W627EHF();
    outportb(W627EHF_INDEX_PORT, W627EHF_REG_LD);
    outportb(W627EHF_DATA_PORT, LD);
    Lock_W627EHF();
}
=====
void Set_W627EHF_Reg( unsigned char REG, unsigned char DATA)
{
    Unlock_W627EHF();
    outportb(W627EHF_INDEX_PORT, REG);
}

```

```

        outportb(W627EHF_DATA_PORT, DATA);
        Lock_W627EHF();
    }
}
=====
unsigned char Get_W627EHF_Reg(unsigned char REG)
{
    unsigned char Result;
    Unlock_W627EHF();
    outportb(W627EHF_INDEX_PORT, REG);
    Result = inportb(W627EHF_DATA_PORT);
    Lock_W627EHF();
    return Result;
}
}
=====

//=====
//
// THIS CODE AND INFORMATION IS PROVIDED "AS IS" WITHOUT WARRANTY OF ANY
// KIND, EITHER EXPRESSED OR IMPLIED, INCLUDING BUT NOT LIMITED TO THE
// IMPLIED WARRANTIES OF MERCHANTABILITY AND/OR FITNESS FOR A PARTICULAR
// PURPOSE.
//
//=====
#ifndef __W627EHF_H
#define __W627EHF_H                1
//=====
#define W627EHF_INDEX_PORT        (W627EHF_BASE)
#define W627EHF_DATA_PORT        (W627EHF_BASE+1)
//=====
#define W627EHF_REG_LD            0x07
//=====
#define W627EHF_UNLOCK            0x87
#define W627EHF_LOCK              0xAA
//=====
unsigned int Init_W627EHF(void);
void Set_W627EHF_LD(unsigned char);
void Set_W627EHF_Reg(unsigned char, unsigned char);
unsigned char Get_W627EHF_Reg(unsigned char);
//=====
#endif __W627EHF_H

```

File of the Main.cpp

```

//=====
//
// THIS CODE AND INFORMATION IS PROVIDED "AS IS" WITHOUT WARRANTY OF ANY
// KIND, EITHER EXPRESSED OR IMPLIED, INCLUDING BUT NOT LIMITED TO THE
// IMPLIED WARRANTIES OF MERCHANTABILITY AND/OR FITNESS FOR A PARTICULAR
// PURPOSE.
//
//=====
#include <dos.h>
#include <conio.h>
#include <stdio.h>
#include <stdlib.h>

```

```

#include "W627HF.H"
//=====
void ClrKbBuf(void);
int main (int argc, char *argv[]);
//=====
int main (int argc, char *argv[])
{
    unsigned char ucDO = 0;           //data for digital output
    unsigned char ucDI;              //data for digital input
    unsigned char ucBuf;

    Set_W627HF_LD( 0x07);            //switch to logic device 7

    Set_W627HF_Reg(0xF1, 0x00);      //clear
    ucDI = Get_W627HF_Reg(0xF1) & 0x0F;

    ClrKbBuf();
    while(1)
    {
        ucDO++;
        Set_W627HF_Reg(0xF1, ((ucDO & 0x0F) << 4));
        ucBuf = Get_W627HF_Reg(0xF1) & 0x0F;
        if (ucBuf != ucDI)
        {
            ucDI = ucBuf;
            printf("Digital I/O Input Changed. Current Data is 0x%X\n",ucDI);
        }

        if (kbhit())
        {
            getch();
            break;
        }
        delay(500);
    }
    return 0;
}
//=====
void ClrKbBuf(void)
{
    while(kbhit())
    {
        getch();
    }
}
//-----

```

BIOS Setup

This chapter describes the different settings available in the Award BIOS that comes with the board. The topics covered in this chapter are as follows:

BIOS Introduction	26
BIOS Setup	26
Standard CMOS Setup	28
Advanced BIOS Features	31
Advanced Chipset Features	34
Integrated Peripherals	36
Power Management Setup	40
PNP/PCI Configurations	43
PC Health Status	44
Frequency/Voltage Control	45
Load Fail-Safe Defaults	46
Load Optimized Defaults	46
Set Supervisor/User Password	46
Save & Exit Setup	46
Exit Without Saving	46

BIOS Introduction

The Award BIOS (Basic Input/Output System) installed in your computer system's ROM supports Intel processors. The BIOS provides critical low-level support for a standard device such as disk drives, serial ports and parallel ports. It also adds virus and password protection as well as special support for detailed fine-tuning of the chipset controlling the entire system.

BIOS Setup

The Award BIOS provides a Setup utility program for specifying the system configurations and settings. The BIOS ROM of the system stores the Setup utility. When you turn on the computer, the Award BIOS is immediately activated. Pressing the key immediately allows you to enter the Setup utility. If you are a little bit late pressing the key, POST (Power On Self Test) will continue with its test routines, thus preventing you from invoking the Setup. If you still wish to enter Setup, restart the system by pressing the "Reset" button or simultaneously pressing the <Ctrl>, <Alt> and <Delete> keys. You can also restart by turning the system Off and back On again. The following message will appear on the screen:

Press to Enter Setup

In general, you press the arrow keys to highlight items, <Enter> to select, the <PgUp> and <PgDn> keys to change entries, <F1> for help and <Esc> to quit.

When you enter the Setup utility, the Main Menu screen will appear on the screen. The Main Menu allows you to select from various setup functions and exit choices.

Phoenix - AwardBIOS CMOS Setup Utility

Standard CMOS Features	Frequency/Voltage Control
Advanced BIOS Features	Load Fail-Safe Defaults
Advanced Chipset Features	Load Optimized Defaults
Integrated Peripherals	Set Supervisor Password
Power Management Setup	Set User Password
PnP/PCI Configurations	Save & Exit Setup
PC Health Status	Exit Without Saving
ESC : Quit	↑ ↓ → ← : Select Item
F10 : Save & Exit Setup	
Time, Date, Hard Disk Type...	

The section below the setup items of the Main Menu displays the control keys for this menu. At the bottom of the Main Menu just below the control keys section, there is another section, which displays information on the currently highlighted item in the list.

Note: *If the system cannot boot after making and saving system changes with Setup, the Award BIOS supports an override to the CMOS settings that resets your system to its default.*

Warning: *It is strongly recommended that you avoid making any changes to the chipset defaults. These defaults have been carefully chosen by both Award and your system manufacturer to provide the absolute maximum performance and reliability. Changing the defaults could cause the system to become unstable and crash in some cases.*

Standard CMOS Setup

“Standard CMOS Setup” choice allows you to record some basic hardware configurations in your computer system and set the system clock and error handling. If the motherboard is already installed in a working system, you will not need to select this option. You will need to run the Standard CMOS option, however, if you change your system hardware configurations, the onboard battery fails, or the configuration stored in the CMOS memory was lost or damaged.

Phoenix - AwardBIOS CMOS Setup Utility
Standard CMOS Features

		Item Help
Date (mm:dd:yy)	Wed, Apr 28, 2004	Menu Level > Change the day, month, Year and century
Time (hh:mm:ss)	00 : 00 : 00	
IDE Channel 0 Master	None	
IDE Channel 0 Slave	None	
IDE Channel 1 Master	None	
IDE Channel 1 Slave	None	
Drive A	1.44M, 3.5 in.	
Drive B	None	
Video	EGA/VGA	
Halt On	All Errors	
Base Memory	640K	
Extended Memory	129024K	
Total Memory	130048K	

At the bottom of the menu are the control keys for use on this menu. If you need any help in each item field, you can press the <F1> key. It will display the relevant information to help you. The memory display at the lower right-hand side of the menu is read-only. It will adjust automatically according to the memory changed. The following describes each item of this menu.

Date

The date format is:

Day : Sun to Sat
Month : 1 to 12
Date : 1 to 31
Year : 1999 to 2099

To set the date, highlight the “Date” field and use the PageUp/ PageDown or +/- keys to set the current time.

Time

The time format is: **Hour** : 00 to 23
 Minute : 00 to 59
 Second : 00 to 59

To set the time, highlight the “Time” field and use the <PgUp>/ <PgDn> or +/- keys to set the current time.

IDE Channel Master/Slave

The onboard PCI IDE connectors provide Primary and Secondary channels for connecting up to four IDE hard disks or other IDE devices. Each channel can support up to two hard disks; the first is the “Master” and the second is the “Slave”.

Press <Enter> to configure the hard disk. The selections include Auto, Manual, and None. Select ‘Manual’ to define the drive information manually. You will be asked to enter the following items.

CYLS : Number of cylinders
HEAD : Number of read/write heads
PRECOMP : Write precompensation
LANDING ZONE : Landing zone
SECTOR : Number of sectors

The Access Mode selections are as follows:

CHS (HD < 528MB)
 LBA (HD > 528MB and supports
 Logical Block Addressing)
 Large (for MS-DOS only)
 Auto

Remarks: The main board supports two serial ATA ports and are represented in this setting as IDE Channel 2 or 3.

Drive A / Drive B

These fields identify the types of floppy disk drive A or drive B that has been installed in the computer. The available specifications are:

360KB	1.2MB	720KB	1.44MB	2.88MB
5.25 in.	5.25 in.	3.5 in.	3.5 in.	3.5 in.

Video

This field selects the type of video display card installed in your system. You can choose the following video display cards:

EGA/VGA	For EGA, VGA, SEGA, SVGA or VGA monitor adapters. (default)
CGA 40	Power up in 40 column mode.
CGA 80	Power up in 80 column mode.
MONO	For Hercules or MDA adapters.

Halt On

This field determines whether or not the system will halt if an error is detected during power up.

No errors	The system boot will not be halted for any error that may be detected.
All errors	Whenever the BIOS detects a non-fatal error, the system will stop and you will be prompted.
All, But Keyboard	The system boot will not be halted for a keyboard error; it will stop for all other errors
All, But Diskette	The system boot will not be halted for a disk error; it will stop for all other errors.
All, But Disk/Key	The system boot will not be halted for a keyboard or disk error; it will stop for all others.

Advanced BIOS Features

Phoenix - AwardBIOS CMOS Setup Utility
Advanced BIOS Features

		ITEM HELP
CPU Feature	Press Enter	
Hard Disk Boot Priority	Press Enter	
Virus Warning	Disabled	
CPU L1 and L2 Cache	Enabled	
CPU L3 Cache	Enabled	
Quick Power On Self Test	Enabled	
First Boot Device	Floppy	
Second Boot Device	Hard Disk	
Third Boot Device	CDROM	
Boot Other Device	Enabled	
Swap Floppy Drive	Disabled	
Boot Up Floppy Seek	Disabled	
Boot Up NumLock Status	On	
Gate A20 Option	Fast	
Typematic Rate Setting	Disabled	
Typematic Rate (Chars/Sec)	6	
Typematic Delay (Msec)	250	
Security Option	Setup	
APIC Mode	Enabled	
MPS Version Control for OS	1.4	
OS Select For DRAM>64MB	Non-OS2	
Report No FDD For WIN 95	Yes	
Small Logo (EPA) Show	Enabled	
		Menu Level >

CPU Feature

Press Enter to configure the settings relevant to CPU Feature.

Hard Disk Boot Priority

With the field, there is the option to choose, aside from the hard disks connected, "Bootable add-in Cards" which refers to other external devices.

Virus Warning

If this option is enabled, an alarm message will be displayed when trying to write on the boot sector or on the partition table on the disk, which is typical of the virus.

CPU L1 / L2 / L3 Cache

Cache memory is additional memory that is much faster than conventional DRAM (system memory). CPUs from 486-type on up contain internal cache memory, and most, but not all, modern PCs have additional (external) cache memory. When the CPU requests data, the system transfers the requested data from the main DRAM into cache memory, for even faster access by the CPU. These items allow you to enable (speed up memory access) or disable the cache function. By default, these items are Enabled.

Quick Power On Self Test

When enabled, this field speeds up the Power On Self Test (POST) after the system is turned on. If it is set to *Enabled*, BIOS will skip some items.

First/Second/Third Boot Device

These fields determine the drive that the system searches first for an operating system. The options available include *Floppy*, *LSI20*, *Hard Disk*, *CDROM*, *ZIP100*, *USB-Floppy*, *USB-ZIP*, *USB-CDROM*, *LAN* and *Disable*.

Boot Other Device

These fields allow the system to search for an OS from other devices other than the ones selected in the First/Second/Third Boot Device.

Swap Floppy Drive

This item allows you to determine whether or not to enable Swap Floppy Drive. When enabled, the BIOS swaps floppy drive assignments so that Drive A becomes Drive B, and Drive B becomes Drive A. By default, this field is set to *Disabled*.

Boot Up Floppy Seek

This feature controls whether the BIOS checks for a floppy drive while booting up. If it cannot detect one (either due to improper configuration or its absence), it will flash an error message.

Boot Up NumLock Status

This allows you to activate the NumLock function after you power up the system.

Gate A20 Option

This field allows you to select how Gate A20 is worked. Gate A20 is a device used to address memory above 1 MB.

Typematic Rate Setting

When disabled, continually holding down a key on your keyboard will generate only one instance. When enabled, you can set the two typematic controls listed next. By default, this field is set to *Disabled*.

Typematic Rate (Chars/Sec)

When the typematic rate is enabled, the system registers repeated keystrokes speeds. Settings are from 6 to 30 characters per second.

Typematic Delay (Msec)

When the typematic rate is enabled, this item allows you to set the time interval for displaying the first and second characters. By default, this item is set to *250msec*.

Security Option

This field allows you to limit access to the System and Setup. The default value is *Setup*. When you select *System*, the system prompts for the User Password every time you boot up. When you select *Setup*, the system always boots up and prompts for the Supervisor Password only when the Setup utility is called up.

APIC Mode

APIC stands for Advanced Programmable Interrupt Controller. The default setting is *Enabled*.

MPS Version Control for OS

This option specifies the MPS (Multiprocessor Specification) version for your operating system. MPS version 1.4 added extended configuration tables to improve support for multiple PCI bus configurations and improve future expandability. The default setting is *1.4*.

OS Select for DRAM > 64MB

This option allows the system to access greater than 64MB of DRAM memory when used with OS/2 that depends on certain BIOS calls to access memory. The default setting is *Non-OS/2*.

Report No FDD For WIN 95

If you are using Windows 95/98 without a floppy disk drive, select Enabled to release IRQ6. This is required to pass Windows 95/98's SCT test. You should also disable the Onboard FDC Controller in the Integrated Peripherals screen when there's no floppy drive in the system. If you set this feature to Disabled, the BIOS will not report the missing floppy drive to Win95/98.

Small Logo (EPA) Show

The EPA logo appears at the right side of the monitor screen when the system is boot up. The default setting is *Enabled*.

Advanced Chipset Features

This Setup menu controls the configuration of the chipset.

Phoenix - AwardBIOS CMOS Setup Utility
Advanced Chipset Features

		ITEM HELP
DRAM Timing Selectable	By SPD	Menu Level >
CAS Latency Time	4	
DRAM RAS# to CAS# Delay	4	
DRAM RAS# Precharge	4	
Precharge delay (tRAS)	12	
System Memory Frequency	533MHZ	
SLP_S4# Assertion Width	1 to 2 Sec	
System BIOS Cacheable	Enabled	
Video BIOS Cacheable	Disabled	
Memory Hole at 15M-16M	Disabled	
PCI Express Root Port Func	Press Enter	
** On-Chip VGA Setting **		
PEG/On Chip VGA Control	Auto	
PEG Force x1	Disabled	
On-Chip Frame Buffer Size	8MB	
DVMT Mode	DVMT	
DVMT/FIXED memory Size	128MB	
Onboard PCU-E LAN	Enable	
Onchip ICH7 LAN	Enable	

DRAM Timing Selectable

This option refers to the method by which the DRAM timing is selected. The default is *By SPD*.

CAS Latency Time

You can configure CAS latency time in HCLKs as 2 or 2.5 or 3. The system board designer should set the values in this field, depending on the DRAM installed. Do not change the values in this field unless you change specifications of the installed DRAM or the installed CPU.

DRAM RAS# to CAS# Delay

This option allows you to insert a delay between the RAS (Row Address Strobe) and CAS (Column Address Strobe) signals. This delay occurs when the SDRAM is written to, read from or refreshed. Reducing the delay improves the performance of the SDRAM.

DRAM RAS# Precharge

This option sets the number of cycles required for the RAS to accumulate its charge before the SDRAM refreshes. The default setting for the Active to Precharge Delay is *4*.

Precharge Delay (tRAS)

The default setting for the Precharge Delay is *12*.

System Memory Frequency

The default setting is *533MHz*.

SLP_S4# Assertion Width

The default setting is *1 to 2 Sec*.

System BIOS Cacheable

The setting of *Enabled* allows caching of the system BIOS ROM at F000h-FFFFh, resulting in better system performance. However, if any program writes to this memory area, a system error may result.

Video BIOS Cacheable

The Setting *Enabled* allows caching of the video BIOS ROM at C0000h-F7FFFh, resulting in better video performance. However, if any program writes to this memory area, a system error may result.

Memory Hole At 15M-16M

In order to improve performance, certain space in memory can be reserved for ISA cards. This memory must be mapped into the memory space below 16 MB. The choices are *Enabled* and *Disabled*.

On-Chip VGA Setting

The fields under the On-Chip VGA Setting and their default settings are:

PEG/On Chip VGA Control: Auto

PEG Force x1: Disabled

On-Chip Frame Buffer Size: 8MB

DVMT Mode: DVMT

DVMT/Fixed Memory Size: 128MB

Onboard PCI-E LAN

By default, this setting is enabled.

Onchip ICH7 LAN

By default, this setting is enabled.

Integrated Peripherals

This section sets configurations for your hard disk and other integrated peripherals. The first screen shows three main items for user to select. Once an item selected, a submenu appears. Details follow.

Phoenix - AwardBIOS CMOS Setup Utility
Integrated Peripherals

OnChip IDE Device	Press Enter	ITEM HELP
Onboard Device	Press Enter	Menu Level >
SuperIO Device	Press Enter	
2 nd SuperIO Device	Press Enter	

Phoenix - AwardBIOS CMOS Setup Utility
OnChip IDE Device

IDE HDD Block Mode	Enabled	ITEM HELP
IDE DMA transfer access	Enabled	
On-chip Primary PCI IDE	Enabled	
IDE Primary Master PIO	Auto	Menu Level >
IDE Primary Slave PIO	Auto	
IDE Primary Master UDMA	Auto	
IDE Primary Slave UDMA	Auto	
On-Chip Secondary PCI IDE	Enabled	
IDE Secondary Master PIO	Auto	
IDE Secondary Slave PIO	Auto	
IDE Secondary Master UDMA	Auto	
IDE Secondary Slave UDMA	Auto	
*** On-Chip Serial ATA Setting ***		
On-Chip Serial ATA	Auto	
SATA Port Speed Settings	Disabled	
PATA IDE Mode	Primary	
SATA port	P1, P3 is Secondary	

Phoenix - AwardBIOS CMOS Setup Utility
Onboard Device

USB Controller	Enabled	ITEM HELP
USB 2.0 Controller	Enabled	Menu Level >
USB Keyboard Support	Disabled	
USB Mouse Support	Disabled	
Azalia AC97 Audio Select	Auto	

Phoenix - AwardBIOS CMOS Setup Utility
2nd Super IO Device

Onboard Serial Port 3	3E8h	ITEM HELP
Serial Port 3 Use IRQ	IRQ11	Menu Level >
Onboard Serial Port 4	Disabled	
Serial Port 4 Use IRQ	IRQ10a	

Phoenix - AwardBIOS CMOS Setup Utility
SuperIO Device

		ITEM HELP
POWER ON Function	BUTTON ONLY	
KB Power ON Password	Enter	
Hot Key power ON	Ctrl-F1	
Onboard FDC Controller	Enabled	
Onboard Serial Port 1	3F8/IRQ4	
Onboard Serial Port 2	2F8/IRQ3	
UART Mode Select	Normal	
RxD , TxD Active	Hi, Lo	
IR Transmission Delay	Disabled	
UR2 Duplex Mode	Half	
Use IR Pins	IR-Rx2Tx2	
PWRON After PWR-Fail	Off	
		Menu Level >

IDE HDD Block Mode

This field allows your hard disk controller to use the fast block mode to transfer data to and from your hard disk drive.

IDE DMA Transfer Access

This field, by default, is enabled

On-chip Primary PCI IDE Enabled

This field, by default, is enabled

OnChip Primary/Secondary PCI IDE

The integrated peripheral controller contains an IDE interface with support for two IDE channels. Select *Enabled* to activate each channel separately.

IDE Primary/Secondary Master/Slave PIO

These fields allow your system hard disk controller to work faster. Rather than have the BIOS issue a series of commands that transfer to or from the disk drive, PIO (Programmed Input/Output) allows the BIOS to communicate with the controller and CPU directly.

The system supports five modes, numbered from 0 (default) to 4, which primarily differ in timing. When Auto is selected, the BIOS will select the best available mode.

IDE Primary/Secondary Master/Slave UDMA

These fields allow your system to improve disk I/O throughput to 33Mb/sec with the Ultra DMA/33 feature. The options are *Auto* and *Disabled*.

On-Chip Serial ATA Setting

The fields under the SATA setting includes SATA Mode (IDE), On -Chip Serial ATA (Auto), PATA IDE Mode (Secondary) and SATA Port (PO, P2 is Primary).

USB Controller

The options for this field are *Enabled* and *Disabled*. By default, this field is set to *Enabled*.

USB 2.0 Controller

The options for this field are *Enabled* and *Disabled*. By default, this field is set to *Enabled*. In order to use USB 2.0, necessary OS drivers must be installed first. *Please update your system to Windows 2000 SP4 or Windows XP SP2.*

USB Keyboard and Mouse Support

The options for this field are *Enabled* and *Disabled*. By default, this field is set to *Disabled*.

Azalia AC97 Audio Select

This field, by default, is set to *Auto*. The selections are *Azalia, AC97 Audio and Modem, AC97 Audio only, AC97 Modem only, and All Disabled*.

Power ON Function

This field is related to how the system is powered on – such as with the use of conventional power button, keyboard or hot keys. The default is *BUTTON ONLY*.

KB Power ON Password

This field allows users to set the password when keyboard power on is the mode of the Power ON function.

Hot Key Power ON

This field sets certain keys, also known as hot keys, on the keyboard that can be used as a ‘switch’ to power on the system.

Onboard FDC Controller

Select *Enabled* if your system has a floppy disk controller (FDC) installed on the motherboard and you wish to use it. If you install an add-in FDC or the system has no floppy drive, select *Disabled* in this field. This option allows you to select the onboard FDD port.

Onboard Serial Port

These fields allow you to select the onboard serial ports and their addresses. The default values for these ports are:

Serial Port 1	3F8/IRQ4
Serial Port 2	2F8/IRQ3

UART Mode Select

This field determines the UART 2 mode in your computer. The default value is *Normal*. Other options include *IrDA* and *ASKIR*.

PWRON After PWR-Fail

This field sets the system power status whether *on or off* when power returns to the system from a power failure situation.

Power Management Setup

Phoenix - AwardBIOS CMOS Setup Utility
Power Management Setup

		ITEM HELP
ACPI Function	Enabled	
ACPI Suspend	S1(POS)	
RUN VGABIOS if S3 Resume	Auto	Menu Level >
Power Management	User Define	
Video Off Method	DPMS	
Video Off In Suspend	Yes	
Suspend Type	Stop Grant	
Modem Use IRQ	3	
Suspend Mode	Disabled	
HDD Power Down	Disabled	
Soft-Off by PWR-BTTN	Instant-Off	
Wake-Up by PCI Card	Disabled	
Power On by Ring	Disabled	
Resume by Alarm	Disabled	
Date (of Month) Alarm	0	
Time (hh:mm:ss) Alarm	0 : 0 : 0	
** Reload Global Timer Events **		
Primary IDE 0	Disabled	
Primary IDE 1	Disabled	
Secondary IDE 0	Disabled	
Secondary IDE 1	Disabled	
FDD, COM, LPT Port	Disabled	
PCI PIRQ[A-D] #	Disabled	

ACPI Function

Enable this function to support ACPI (Advance Configuration and Power Interface).

ACPI Suspend

The default setting of the ACPI Suspend mode is *S1(POS)*.

RUN VGABIOS if S3 Resume

The default setting of this field is *Auto*.

Power Management

This field allows you to select the type of power saving management modes. There are four selections for Power Management.

Min. Power Saving	Minimum power management
Max. Power Saving	Maximum power management.
User Define	Each of the ranges is from 1 min. to 1hr. Except for HDD Power Down which ranges from 1 min. to 15 min.

Video Off Method

This field defines the Video Off features. There are three options.

V/H SYNC + Blank	Default setting, blank the screen and turn off vertical and horizontal scanning.
DPMS	Allows BIOS to control the video display.
Blank Screen	Writes blanks to the video buffer.

Video Off In Suspend

When enabled, the video is off in suspend mode.

Suspend Type

The default setting for the Suspend Type field is *Stop Grant*.

Modem Use IRQ

This field sets the IRQ used by the Modem. By default, the setting is **3**.

Suspend Mode

When enabled, and after the set time of system inactivity, all devices except the CPU will be shut off.

HDD Power Down

When enabled, and after the set time of system inactivity, the hard disk drive will be powered down while all other devices remain active.

Soft-Off by PWRBTN

This field defines the power-off mode when using an ATX power supply. The *Instant Off* mode allows powering off immediately upon pressing the power button. In the *Delay 4 Sec* mode, the system powers off when the power button is pressed for more than four seconds or enters the suspend mode when pressed for less than 4 seconds.

Wake up by PCI Card

By default, this field is disabled.

Power On by Ring

This field enables or disables the power on of the system through the modem connected to the serial port or LAN.

Resume by Alarm

This field enables or disables the resumption of the system operation. When enabled, the user is allowed to set the *Date* and *Time*.

Reload Global Timer Events

The HDD, FDD, COM, LPT Ports, and PCI PIRQ are I/O events that can prevent the system from entering a power saving mode or can awaken the system from such a mode. When an I/O device wants to gain the attention of the operating system, it signals this by causing an IRQ to occur. When the operating system is ready to respond to the request, it interrupts itself and performs the service.

PNP/PCI Configurations

This option configures the PCI bus system. All PCI bus systems on the system use INT#, thus all installed PCI cards must be set to this value.

Phoenix - AwardBIOS CMOS Setup Utility
PnP/PCI Configurations

		ITEM HELP
Init Display First	PCI Slot	
Reset Configuration Data	Disabled	
Resources Controlled By	Auto (ESCD)	Menu Level
IRQ Resources	Press Enter	
PCI/VGA Palette Snoop	Disabled	
INT Pin 1 Assignment	Auto	
INT Pin 2 Assignment	Auto	
INT Pin 3 Assignment	Auto	
INT Pin 4 Assignment	Auto	
INT Pin 5 Assignment	Auto	
INT Pin 6 Assignment	Auto	
INT Pin 7 Assignment	Auto	
INT Pin 8 Assignment	Auto	
PCI Express relative items		
Maximum Payload Size	4096	Select Yes if you are using a Plug and Play capable operating system Select No if you need the BIOS to configure non-boot devices

Init Display First

The default setting is *PCI Card*.

Reset Configuration Data

This field allows you to determine whether to reset the configuration data or not. The default value is *Disabled*.

Resources Controlled by

This PnP BIOS can configure all of the boot and compatible devices with the use of a PnP operating system such as Windows 95.

PCI/VGA Palette Snoop

Some non-standard VGA display cards may not show colors properly. This field allows you to set whether or not MPEG ISA/VESA VGA cards can work with PCI/VGA. When this field is enabled, a PCI/VGA can work with an MPEG ISA/VESA VGA card. When this field is disabled, a PCI/VGA cannot work with an MPEG ISA/VESA card.

Maximum Payload Size

The default setting of the PCI Express Maximum Payload Size is 4096.

PC Health Status

This section shows the parameters in determining the PC Health Status. These parameters include temperatures, fan speeds and voltages.

Phoenix - AwardBIOS CMOS Setup Utility
PC Health Status

		ITEM HELP
Shutdown Temperature	Disabled	
CPU Warning Temperature	Disabled	
Current System Temp	45°C/113°F	
Current CPU TEMP	45°C/113°F	Menu Level >
FAN2 Speed	5400 RPM	
FAN1 Speed	5400 RPM	
Vcore(V)	1.02 V	
+12 V	1.32 V	
VTT	1.8V	
-5V	-5.02	
+5V	5.25 V	
-12V	-11.89	
3.3V	3.37V	
VBAT (V)	3.21 V	
5VSB(V)	5.67 V	

CPU Warning Temperature

This field allows the user to set the temperature so that when the temperature is reached, the system sounds a warning. This function can help prevent damage to the system that is caused by overheating.

Temperatures/Voltages

These fields are the parameters of the hardware monitoring function feature of the motherboard. The values are read-only values as monitored by the system and show the PC health status.

Frequency/Voltage Control

This section shows the user how to configure the processor frequency.

Phoenix - AwardBIOS CMOS Setup Utility
Frequency/Voltage Control

CPU Clock Ratio	14x	ITEM HELP
Auto Detect PCI Clk	Disabled	Menu Level >
Spread Spectrum Modulated	Disabled	

CPU Clock Ratio

This field's default setting is **14x**.

Auto Detect PCI Clk

This field enables or disables the auto detection of the PCI clock.

Spread Spectrum Modulated

This field sets the value of the spread spectrum. The default setting is **Disabled**. This field is for CE testing use only.

Load Fail-Safe Defaults

This option allows you to load the troubleshooting default values permanently stored in the BIOS ROM. These default settings are non-optimal and disable all high-performance features.

Load Optimized Defaults

This option allows you to load the default values to your system configuration. These default settings are optimal and enable all high performance features.

Set Supervisor Password

These two options set the system password. Supervisor Password sets a password that will be used to protect the system and Setup utility. User Password sets a password that will be used exclusively on the system. To specify a password, highlight the type you want and press <Enter>. The Enter Password: message prompts on the screen. Type the password, up to eight characters in length, and press <Enter>. The system confirms your password by asking you to type it again. After setting a password, the screen automatically returns to the main screen.

To disable a password, just press the <Enter> key when you are prompted to enter the password. A message will confirm the password to be disabled. Once the password is disabled, the system will boot and you can enter Setup freely.

Save & Exit Setup

This option allows you to determine whether or not to accept the modifications. If you type “Y”, you will quit the setup utility and save all changes into the CMOS memory. If you type “N”, you will return to Setup utility.

Exit Without Saving

Select this option to exit the Setup utility without saving the changes you have made in this session. Typing “Y” will quit the Setup utility without saving the modifications. Typing “N” will return you to Setup utility.

Drivers Installation

This section describes the installation procedures for software and drivers under the Windows 2000 and Windows XP. The software and drivers are included with the board. If you find the items missing, please contact the vendor where you made the purchase. The contents of this section include the following:

Intel 945G Chipset Software Installation Utility	48
Intel 945G Chipset Graphics Driver	50
Realtek Codec Audio Driver Installation	51
Marvell 88E8052 LAN Drivers Installation.....	52
Intel PRO LAN Drivers Installation.....	53

IMPORTANT NOTE:

After installing your Windows operating system (Windows 2000/XP), you must install first the Intel Chipset Software Installation Utility before proceeding with the drivers installation.

Intel 945G Chipset Software Installation Utility

The Intel® 945G Chipset Drivers should be installed first before the software drivers to enable Plug & Play INF support for Intel chipset components. Follow the instructions below to complete the installation under Windows 2000/XP. (Before installed Intel Chipset Software Installation Utility, Please update your system to Windows 2000 SP4 or Windows XP SP1A)

1. Insert the CD that comes with the board and the screen below would appear. Click *Intel Chipsets*, then *Intel(R) Chipset Software Installation Utility*.



2. When the Welcome screen appears, click *Next* to continue.

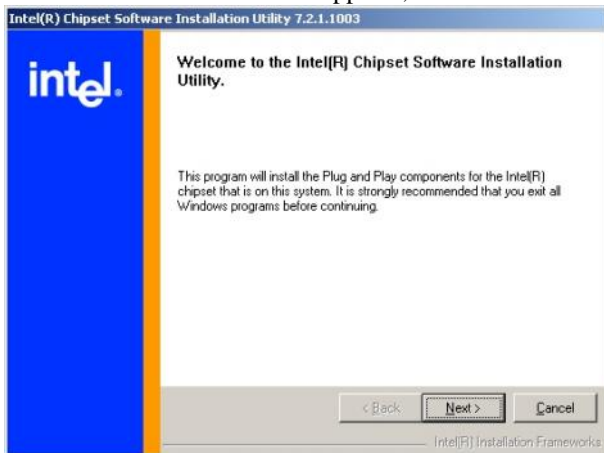

3. Click **Yes** to accept the software license agreement and proceed with the installation process.



4. On Readme Information screen, click **Next** to continue the installation.

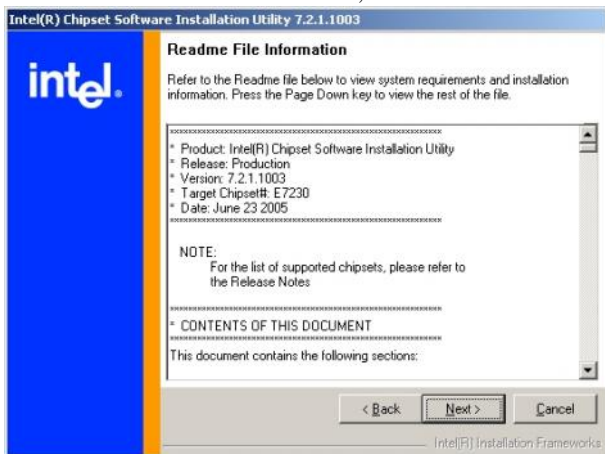

5. The Setup process is now complete. Click **Finish** to restart the computer and for changes to take effect.

Intel 945G Chipset Graphics Driver

The Intel® 945G Chipset Family Graphics Drivers come in the CD with the motherboard. Follow the instructions below to complete the installation under Windows 2000/XP.

1. Insert the CD that comes with the board and the screen below would appear. Click **Intel Chipsets**, then **Intel (R) I945G Chipset Family Graphics Driver**.



2. When the Welcome screen appears, click **Next** to continue.
3. Click **Yes** to accept the software license agreement and proceed with the installation process.
4. The Setup process is now complete. Click **Finish** to restart the computer and for changes to take effect.

Realtek Codec Audio Driver Installation

Follow the steps below to install the Realtek High Definition Codec Audio Drivers.

1. Insert the CD that comes with the board and the screen below would appear. Click *Intel Chipsets*, then *Realtek High Definition Codec Audio Driver*.



2. When the Welcome screen appears, click *Next* to continue.

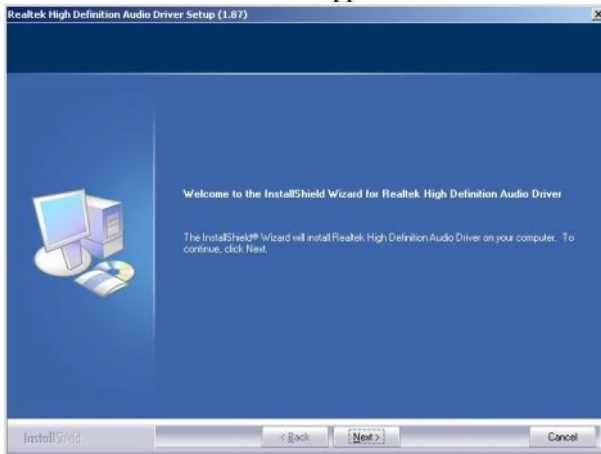

3. The Setup process is now complete. Restart the computer when prompted for changes to take effect.

Marvell 88E8052 LAN Drivers Installation

Insert the CD that comes with the board to install the PCI Express Gigabit LAN drivers. In the initial screen, click on LAN Card on the left side, then Marvell LAN Controller Driver. Follow the instructions accordingly to finish the installation process.



2. To use the wake up function by PCIe LAN, go to the Device Manager under Windows and select LAN controller. The following window will appear (Generic Marvell Yukon Chipset based Ethernet Controller Properties). Click Advanced and select Wake From Shutdown. In the Value field on the right, select On.

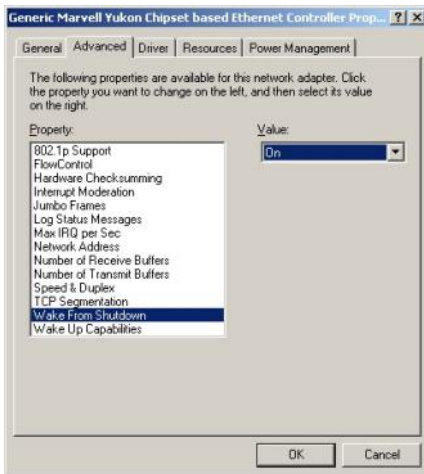

3. Then, also in the Advanced section, click on Wake Up Capabilities. In the Value field on the right, select Magic Packet, then click OK.

Intel PRO LAN Drivers Installation

Follow the instructions below to complete the installation under Windows 2000/XP.

1. Insert the CD that comes with the board and the screen below would appear. Click *Intel Chipsets*, then *Intel (R) PRO LAN Network Drivers*.



2. On the next screen, click **Install Drivers** to start the drivers installation.



This page is intentionally left blank.

Appendix

A. I/O Port Address Map

Each peripheral device in the system is assigned a set of I/O port addresses that also becomes the identity of the device. The following table lists the I/O port addresses used.

Address	Device Description
000h - 01Fh	DMA Controller #1
020h - 03Fh	Interrupt Controller #1
040h - 05Fh	Timer
060h - 06Fh	Keyboard Controller
070h - 07Fh	Real Time Clock, NMI
080h - 09Fh	DMA Page Register
0A0h - 0BFh	Interrupt Controller #2
0C0h - 0DFh	DMA Controller #2
0F0h	Clear Math Coprocessor Busy Signal
0F1h	Reset Math Coprocessor
1F0h - 1F7h	IDE Interface
278h - 27Fh	Parallel Port #2(LPT2)
2F8h - 2FFh	Serial Port #2(COM2)
2B0h - 2DFh	Graphics adapter Controller
378h - 3FFh	Parallel Port #1(LPT1)
360h - 36Fh	Network Ports
3B0h - 3BFh	Monochrome & Printer adapter
3C0h - 3CFh	EGA adapter
3D0h - 3DFh	CGA adapter
3F0h - 3F7h	Floppy Disk Controller
3F8h - 3FFh	Serial Port #1(COM1)

B. Interrupt Request Lines (IRQ)

Peripheral devices use interrupt request lines to notify CPU for the service required. The following table shows the IRQ used by the devices on board.

Level	Function
IRQ0	System Timer Output
IRQ1	Keyboard
IRQ2	Interrupt Cascade
IRQ3	Serial Port #2
IRQ4	Serial Port #1
IRQ5	Reserved
IRQ6	Floppy Disk Controller
IRQ7	Parallel Port #1
IRQ8	Real Time Clock
IRQ9	Reserved
IRQ10	Reserved
IRQ11	Reserved
IRQ12	PS/2 Mouse
IRQ13	80287
IRQ14	Primary IDE
IRQ15	Secondary IDE

Free Manuals Download Website

<http://myh66.com>

<http://usermanuals.us>

<http://www.somanuals.com>

<http://www.4manuals.cc>

<http://www.manual-lib.com>

<http://www.404manual.com>

<http://www.luxmanual.com>

<http://aubethermostatmanual.com>

Golf course search by state

<http://golfingnear.com>

Email search by domain

<http://emailbydomain.com>

Auto manuals search

<http://auto.somanuals.com>

TV manuals search

<http://tv.somanuals.com>