

# **INTELLEC SERIES II INSTALLATION & SERVICE MANUAL**

Manual Order No. 9800559A

Copyright © 1978 Intel Corporation  
Intel Corporation, 3065 Bowers Avenue, Santa Clara, California 95051

The information in this document is subject to change without notice.

Intel Corporation makes no warranty of any kind with regard to this material, including, but not limited to, the implied warranties of merchantability and fitness for a particular purpose. Intel Corporation assumes no responsibility for any errors that may appear in this document. Intel Corporation makes no commitment to update nor to keep current the information contained in this document.

No part of this document may be copied or reproduced in any form or by any means without the prior written consent of Intel Corporation.

The following are trademarks of Intel Corporation and may be used only to describe Intel products:

ICE  
INSITE  
INTEL  
INTELLEC  
LIBRARY MANAGER

MCS  
MEGACHASSIS  
MICROMAP  
MULTIBUS

PROMPT  
RMX  
UPI  
μSCOPE

This manual is intended for the design engineer, programmer, or technician who must install and maintain the Intellec Series II microcomputer development system. It describes, briefly, the Intellec Series II models 210, 220, and 230. It contains the procedures to install the systems, from unpacking to checkout. It also contains troubleshooting and service information and procedures to upgrade the system with Intel products and external peripheral devices.

This manual is divided into the following chapters and appendixes:

- “Introduction,” which briefly describes the models and their features.
- “Installation,” which contains the procedures to unpack, inspect, assemble, and checkout the systems.
- “Troubleshooting and Service,” which describes the service procedures, diagnostic features, and troubleshooting procedures.
- “Upgrade and Enhancement Procedures,” which contains the procedures to add Intel products and external peripheral devices to increase the system capabilities.
- “Appendix A. Configuring the Serial Interfaces,” which describes the facilities available to customize the serial channel interfaces to specific devices.
- “Appendix B. Power Supply Usage,” which lists the power supply usage by the basic systems and power available for options.
- “Appendix C. Spare Parts Lists,” which lists the recommended spare parts for each of the models.

This manual is part of the Intellec Series II library. The other manuals in the library are:

- *A Guide to Microcomputer Development Systems*, 9800558, which introduces microcomputer development systems in general and the Intellec in particular. It presents an overview of the purposes and uses of development systems.
- *ISIS II User's Guide*, 9800306, which describes the operation of the models 220 and 230.
- *Intellec Series II Model 210 User's Guide*, 9800557, which describes the operation of the model 210.
- *Intellec Series II Hardware Reference Manual*, 9800556, which describes the operation of the system modules and includes a high-level functional description of each.
- *Intellec Series II Schematic Drawings*, 9800554, which contains the system schematic diagrams.

Additionally, you may have need for some of the following manuals. These manuals are available from the Intel Corporation or your supplier.

## Programming Language Manuals

- *PL/M-80 Programming Manual, 9800286*
- *8080/8085 Assembly Language Programming Manual, 9800301*
- *FORTRAN-80 Programming Manual, 9800481*
- *MCS-48 and UPI-41 Assembly Language Programming and Operator's Manual, 9800255*

## Operator's Manuals

- *8080/8085 Macro Assembler Operator's Manual, 9800292*
- *ISIS-II PL/M-80 Compiler Operator's Manual, 9800300*
- *8080/8085 FORTRAN Compiler Operator's Manual, 9800480*

## In-Circuit Emulator Manuals

- *In-Circuit Emulator-80 Operator's Manual, 9800185*
- *In-Circuit Emulator-48 Operator's Manual, 9800464*
- *In-Circuit Emulator-85 Operator's Manual, 9800463*
- *In-Circuit Emulator-80 Hardware Reference Manual, 9800167*



# TABLE OF CONTENTS

## PREFACE

### CHAPTER 1 INTRODUCTION

The Systems . . . . .	1-1
Model 210 General Description . . . . .	1-1
Model 220 General Description . . . . .	1-2
Model 230 General Description . . . . .	1-3
Safety . . . . .	1-4
The Care And Feeding Of Diskettes . . . . .	1-4

### CHAPTER 2 INSTALLATION

How To Use This Chapter . . . . .	2-1
Initial Inspection And Unpacking . . . . .	2-1
Inventory . . . . .	2-1
Equipment Inspection . . . . .	2-1
Assembly - Model 210 . . . . .	2-3
Attaching A Terminal . . . . .	2-4
Assembly - Models 220 And 230 . . . . .	2-5
Checkout . . . . .	2-6

### CHAPTER 3 TROUBLESHOOTING AND SERVICE

How To Use This Chapter . . . . .	3-1
Troubleshooting Procedure . . . . .	3-1
System Will Not Power Up . . . . .	3-1
Malfunctions on Systems That Will Power Up . . . . .	3-3
Diagnostics . . . . .	3-3
IPB Diagnostics . . . . .	3-4
IPB Error Messages . . . . .	3-4
IOC Diagnostics . . . . .	3-5
General Test . . . . .	3-6
Keyboard/CRT Test . . . . .	3-6
Disk Test . . . . .	3-6
Confidence Test . . . . .	3-7
Confidence Test Execution . . . . .	3-7
Processor Test . . . . .	3-8
Memory Test . . . . .	3-8
CRT and Keyboard Test . . . . .	3-8
TTY Test . . . . .	3-9
Diskette Test . . . . .	3-10
Line Printer Test . . . . .	3-11
High Speed Punch Test . . . . .	3-12
High Speed Reader Test . . . . .	3-12
End of Test . . . . .	3-13/3-14

### CHAPTER 4 UPGRADE AND ENHANCEMENT PROCEDURES

Adding RAM To The Model 210 And 220 . . . . .	4-1
Adding the SBC-032 RAM Board . . . . .	4-1
Checkout of the SBC-032 RAM Board . . . . .	4-2
Adding the SBC-016 16K RAM Module . . . . .	4-3
Checkout of the SBC-016 16K RAM Module . . . . .	4-3
Adding Diskette Controllers And Drives . . . . .	4-4
Installing a Double Density Disk Controller in a Model 210 and 220 . . . . .	4-4
Checkout of the Disk Drive and Controller . . . . .	4-7
Installing a Double Density Disk Unit in the Model 220 or 230 . . . . .	4-8
Connecting the Integral Drive to a Double-Density Controller . . . . .	4-8
Installing a Disk Drive in the Model 230 Chassis . . . . .	4-8
Checkout of Main Chassis Disk Unit . . . . .	4-14
Installing An Expansion Chassis . . . . .	4-14
Checkout of the Expansion Chassis . . . . .	4-15
Adding Peripherals . . . . .	4-15
Adding In-Circuit Emulators . . . . .	4-16
Adding Multibus Modules . . . . .	4-16
Installing The Model 210 Enhancement Package . . . . .	4-17

### APPENDIX A CONFIGURING THE SERIAL INTERFACES

### APPENDIX B POWER SUPPLY USAGE

### APPENDIX C SPARE PARTS LIST

### APPENDIX D MODIFYING THE BAUD RATE

### APPENDIX E TELETYPEWRITER MODIFICATIONS

## TABLES

B-1	Model 210 Power Supply Usage . . . . .	B-1
B-2	Model 220 Power Supply Usage . . . . .	B-1
B-3	Model 230 Power Supply Usage . . . . .	B-1
B-4	Expansion Chassis Power Availability . . . . .	B-2

## ILLUSTRATIONS

1-1	Model 210 Chassis . . . . .	1-1/1-2
1-2	Model 220 Chassis . . . . .	1-2
1-3	Model 230 Chassis . . . . .	1-3
2-1	Top Cover and Front Panel Screws . . . . .	2-2
2-2	Model 230 Card Cage . . . . .	2-3
2-3	Power Switching Card . . . . .	2-3
2-4	Power Cord Receptacle . . . . .	2-4
2-5	Model 210 Terminal Connection . . . . .	2-4
2-6	Keyboard Connection . . . . .	2-5
2-7	Power Cord Receptacle . . . . .	2-5
2-8	Power Switching Card . . . . .	2-6
2-9	CRT Controls . . . . .	2-7
4-1	SBC-032 Jumper Locations . . . . .	4-2
4-2	SBC-016 16K RAM Module Jumper Locations . . . . .	4-3
4-3	Model 230 Disk Drive Connectors . . . . .	4-4
4-4	Address Selection Switches on the Channel Board . . . . .	4-5
4-5	Address Selection Switch Positions for 78H . . . . .	4-5

## ILLUSTRATIONS (cont'd.)

4-6	Interrupt Selection Switch on the Interface Board . . . . .	4-6
4-7	Model 220 Back Panel Disk Cable Locations . . . . .	4-7
4-8	Locating the Disk Control Cable . . . . .	4-7
4-9	Cabling Integral Drive to DD Controller . . . . .	4-8
4-10	CRT Cover Removal . . . . .	4-9
4-11	CRT Mounting Screws . . . . .	4-10
4-12	Panel Removal . . . . .	4-10
4-13	Bracket Installation . . . . .	4-11
4-14	Inserting Diskette Drive . . . . .	4-11
4-15	Installing the Side Bracket . . . . .	4-12
4-16	Disk Drive Power Connections . . . . .	4-12
4-17	Single Density Interface Cable Connections . . . . .	4-13
4-18	Double Density Interface Cable Connections . . . . .	4-13
4-19	Cable Port in Main Chassis . . . . .	4-14
4-20	Cable Port in Expansion Chassis . . . . .	4-15
4-21	Model 210, 220 and 230 Interface Connections . . . . .	4-16
4-22	Model 210 Mother Board Removal . . . . .	4-17
4-23	Expansion Chassis Mother Board Installation . . . . .	4-18
A-1	Serial 1 Lines and Jumpers . . . . .	A-1/A-2
A-2	Serial 2 Lines and Jumpers . . . . .	A-1/A-2

This manual covers three important aspects of using your Intellec Series II Microcomputer Development System:

- Installation
- Troubleshooting and service
- System upgrade and enhancement

Installation gives you step-by-step procedures to follow, from unpacking the shipping cartons through checking out the assembled system.

Troubleshooting and service gives you procedures to narrow problems down to a single part of the system. It tells you how to execute the ROM-based diagnostics and the diskette- or paper tape-based confidence tests.

System upgrade and enhancement gives you the instructions to install and check out the most common additions usually made to the system. It also gives you step-by-step instructions for the installations and checkouts, including installation of the model 210-to-model 220 enhancement package, which converts a model 210 to a model 220.

## The Systems

There are three Intellec Series II Microcomputer Development System models:

- Model 210
- Model 220
- Model 230

This manual covers installation and service of all three models. Operating instructions for the model 210 are in the *Intellec Series II Model 210 User's Guide*. Operating instructions for the models 220 and 230 are in the *ISIS-II User's Guide*.

## Model 210 General Description

The model 210 is a packaged microcomputer development system. It contains 32K bytes of RAM, ROM-based monitor, editor, assembler, and diagnostics. You must provide your own system console (TTY or equivalent) to interface with the model 210. It contains interfaces for standard development peripherals. The model 210 has three spare card slots in the card cage for system expansion. Figure 1-1 shows a model 210 chassis with the external parts labeled.

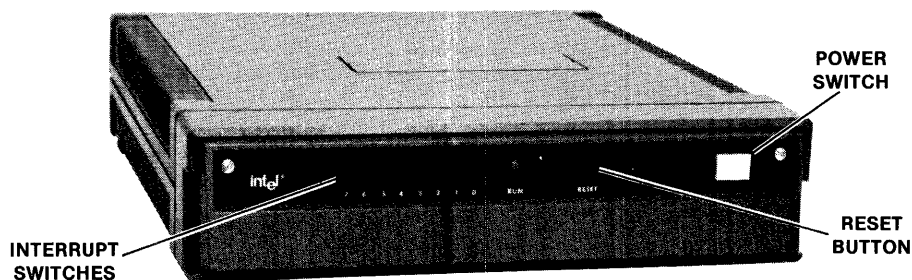

Fig. 1-1 Model 210 Chassis

559-5

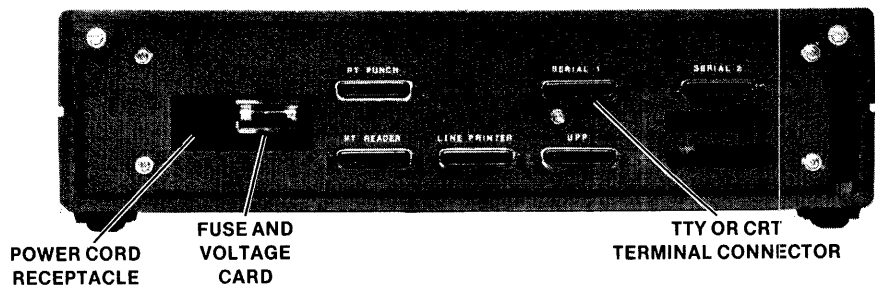
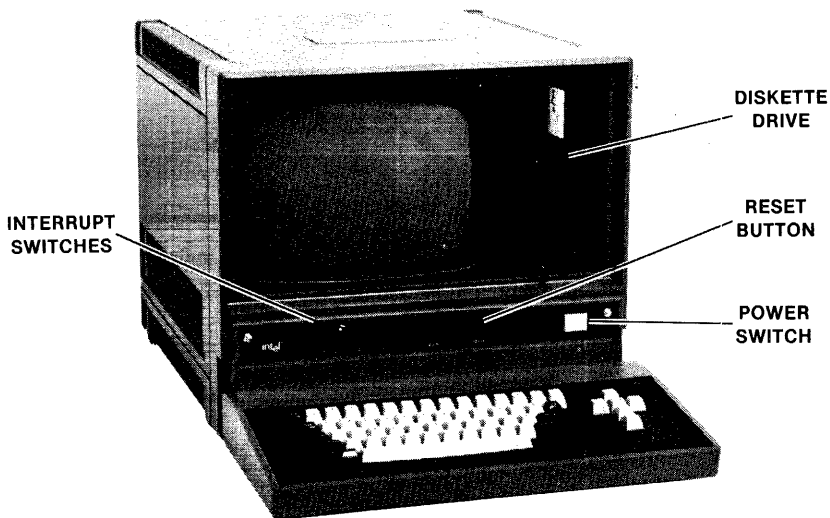

Fig. 1-1 Model 210 Chassis (cont'd.)

559-6

### Model 220 General Description

The model 220 is a packaged microcomputer development system. It contains a CRT display, keyboard, 32K bytes of RAM, ROM-based monitor and diagnostics, one single-density disk drive, and interfaces for standard development peripherals. The model 220 has five spare card slots in the card cage for additional components. Figure 1-2 shows a model 220 chassis with the external parts labeled.



559-4

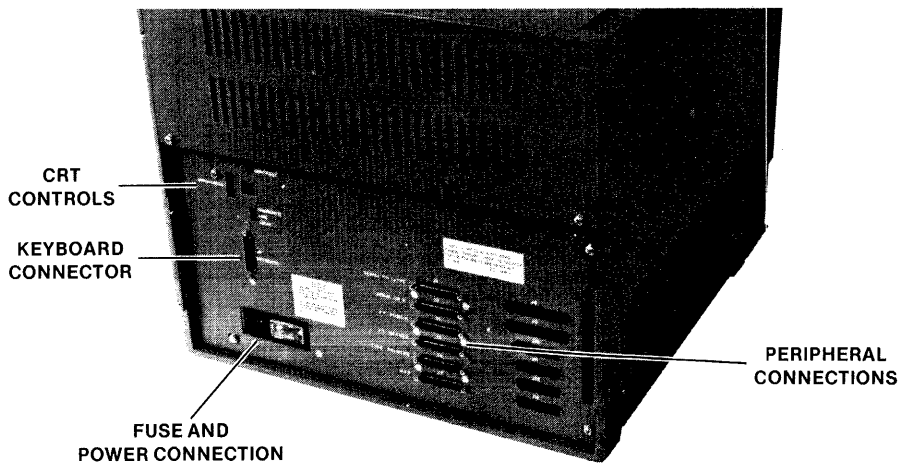

Fig. 1-2 Model 220 Chassis

559-15



### Model 230 General Description

The model 230 is a packaged microcomputer development system. It contains a CRT display, keyboard, 64K bytes of RAM, ROM-based monitor and diagnostics, two double-density disk drives in a separate chassis, and interfaces for standard development peripherals. The model 230 has two spare card slots in the card cage for additional components. Figure 1-3 shows the model 230 chassis with the external parts labeled.

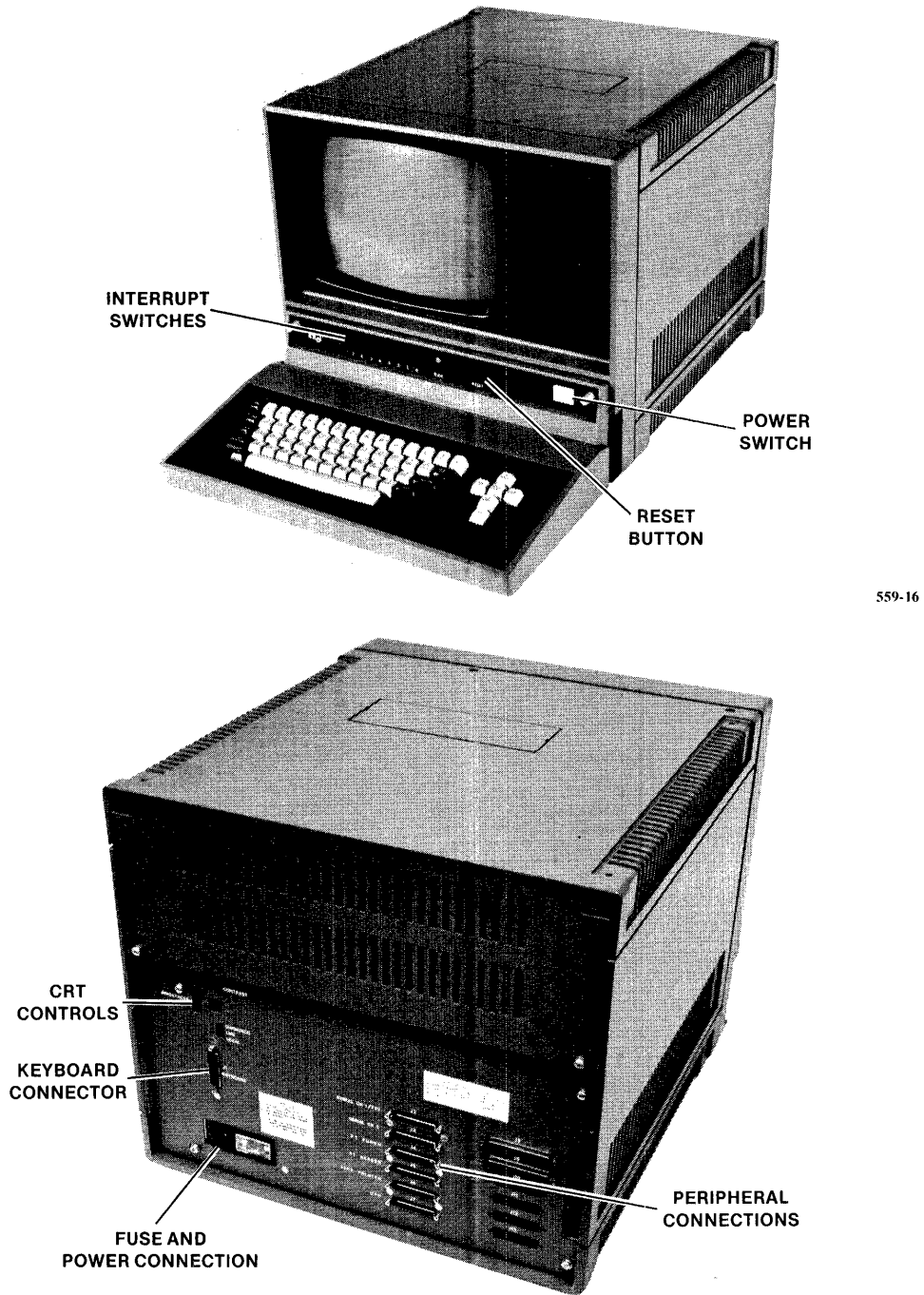

559-16

Fig. 1-3 Model 230 Chassis

559-17

## Safety

**Most of the procedures in this manual involve working inside the Intellec Series II covers. Lethal voltages exist inside the system. Do not work inside the covers with the power on unless it is necessary. Power is, of course, necessary during many troubleshooting procedures. Exercise extreme care and do not wear jewelry while working inside the box.**

## The Care And Feeding Of Diskettes

Your Intellec Series II system uses floppy diskettes for bulk direct-access storage of data and programs. Floppy diskettes are reliable and durable if used and handled correctly and sensibly. The following precautions will ensure long, trouble-free performance from your diskettes:

- *Never* touch the recording surface that shows through the holes in the container.
- *Always* keep diskettes in the envelope when not being used in a drive unit.
- *Never* press the Reset switch on the Intellec Series II front panel while a disk drive light is on. The light indicates that the drive is performing a disk I/O operation. Pressing the Reset switch at this time may cause spurious bit patterns that can destroy some of the data to be written on the diskette.
- *Never* turn off the Intellec Series II or the disk drive power without first removing the diskettes from all drives on the system. Turning off the power may cause write current to be applied to the recording heads which will destroy some of the data on the diskette.

This chapter contains procedures to unpack, inspect, assemble, and check out your Intellec Series II Microcomputer Development System.

The procedures are designed to detect any damaged and malfunctioning component and, in the case of malfunctions, isolate the problem to a replaceable unit.

If you follow the procedures step by step, you will have the system operational in the least amount of time, with little trouble even if malfunctions are encountered.

You will do some disassembly during these procedures. This is to provide a controlled, limited environment during the checkout procedure. In this way malfunctions, if any, can be pinpointed to a component.

## How To Use This Chapter

This chapter covers the installation of all three Intellec Series II models. Start with the next section "Initial Inspection and Unpacking" and proceed, section by section, until you are directed to a specific section. When the installation of your model is complete, you will be directed to operating manuals for your system.

If you are told to go to Chapter 3 because of a malfunction, return to the following step after the malfunction is fixed.

## Initial Inspection And Unpacking

You have probably already unpacked and looked the system over. If you discovered any damage, contact Intel or your supplier right away. If you haven't taken the system and parts out of the box yet, do it now. Be careful lifting the system out of the boxes, some of the units weigh more than 80 pounds.

## Inventory

The documentation package in which you found this manual contains a checklist of all the parts that should be in the box. Make sure you have everything you should have. If anything is missing, contact Intel or your supplier.

## Equipment Inspection

If any defects or broken parts are found during this inspection, contact Intel or your supplier. Don't proceed with the installation procedure unless you are told to do so.

Inspect the units on all sides. Look for dents, holes, and scratches.

Remove the top cover of the main chassis. The cover is held in place by two screws on the front of the top and two screws on the back panel as shown in Figure 2-1. Check all cable connections inside the chassis to make sure they are firmly seated.

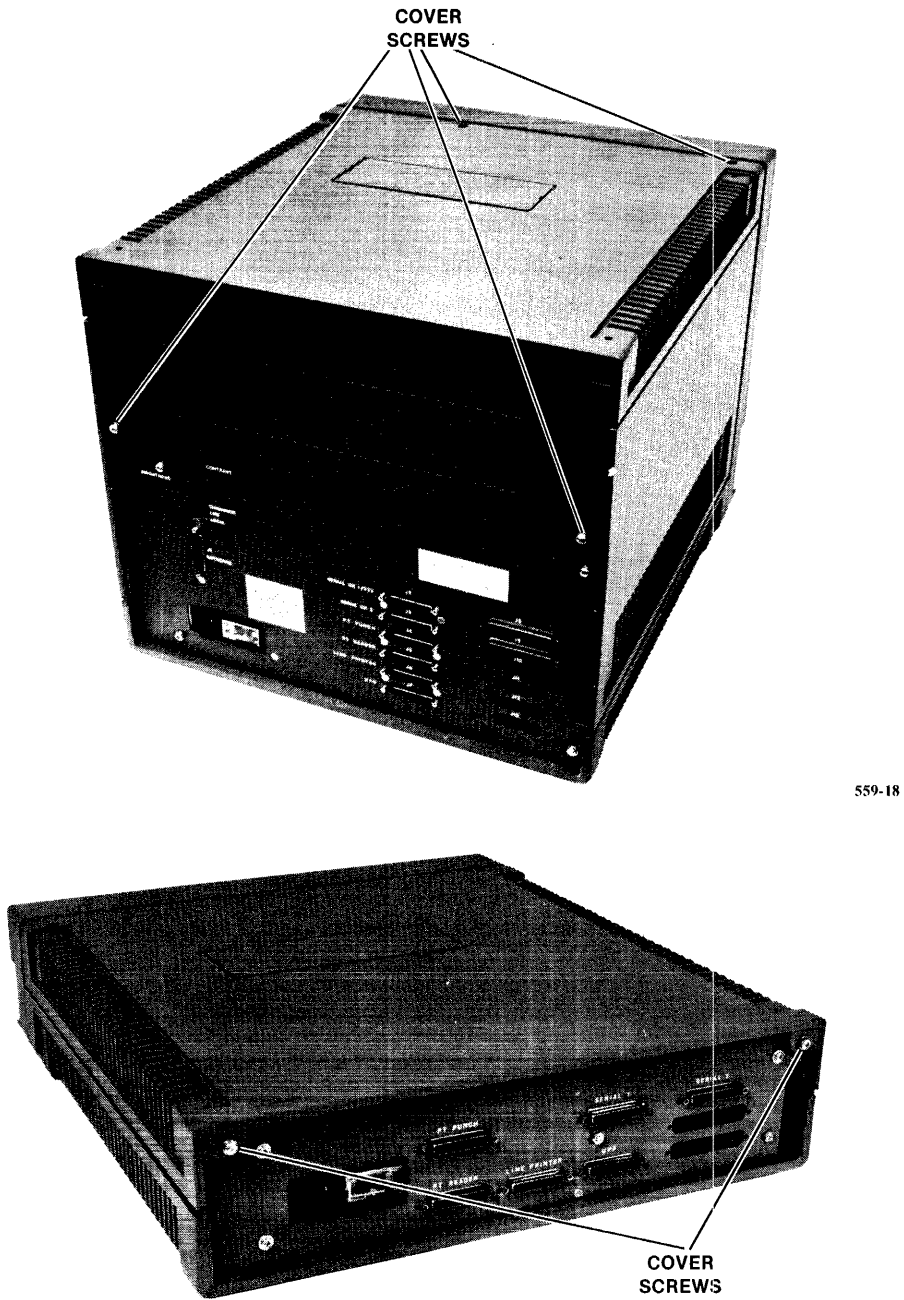

Fig. 2-1 Top Cover and Front Panel Screws

559-19

Replace the top cover.

Remove the front panel. Turn the screws at each end a quarter of a turn counter-clockwise and pull the panel off. Remove the Integrated Processor Board (IPB). The interrupt switches, run light, and Reset switch are physically attached to the IPB. Inspect the board for damage. Replace the IPB.

(Model 230 only) Remove the SBC-032 RAM board and inspect it for damage. Unplug the diskette control cable from the diskette controller interface card. Remove the two diskette controller cards (note which card the cable was removed from). Inspect the cards for damage. Do not replace the SBC-032 and diskette controller cards at this time. These boards will be replaced during the checkout procedure. Figure 2-2 shows the boards in the card cage.

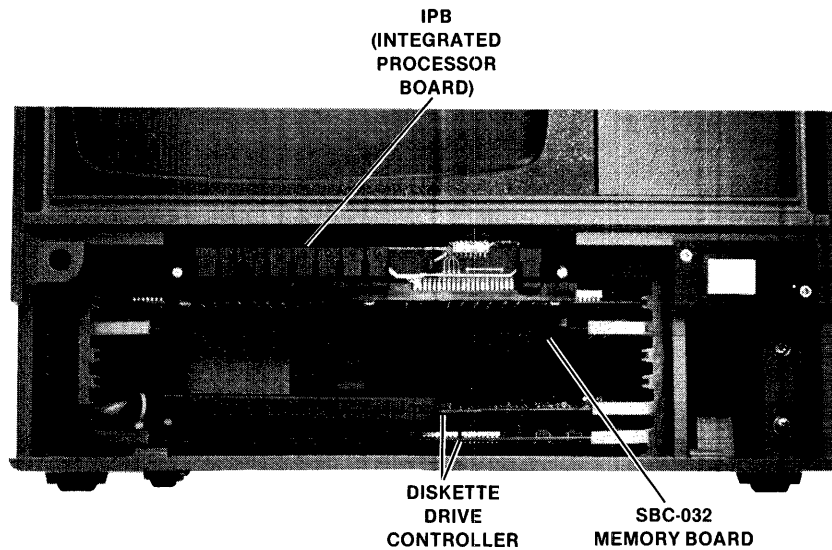

Fig. 2-2 Model 230 Card Cage

559-20

If you are installing a model 210, continue on to the next section. If you are installing a model 220 or 230, skip the next section and go to "Assembly - Models 220 and 230."

## Assembly - Model 210

Very little assembly is required to make your Intellec Series II model 210 operational.

1. Slide the plastic shield at the main power socket to the left. Remove the voltage switching card. This card is designed for four primary voltages as shown in Figure 2-3. Make sure the card is inserted correctly for your line voltage. The card must be inserted so you can read your voltage with the card in the slot. Plug the card back into the slot.

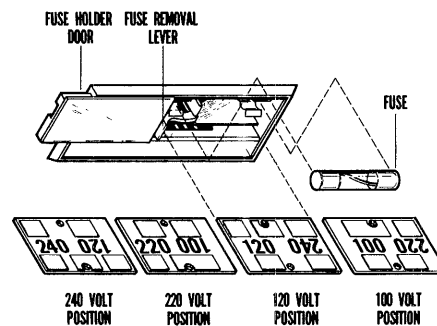

Fig. 2-3 Power Switching Card

559-12

2. Make sure the correct fuse is installed above the voltage switching card:
  - 110VAC - 4 amp
  - 220VAC - 2 amp
3. Slide the plastic shield to the right and plug the main power cord into the socket as shown in Figure 2-4.

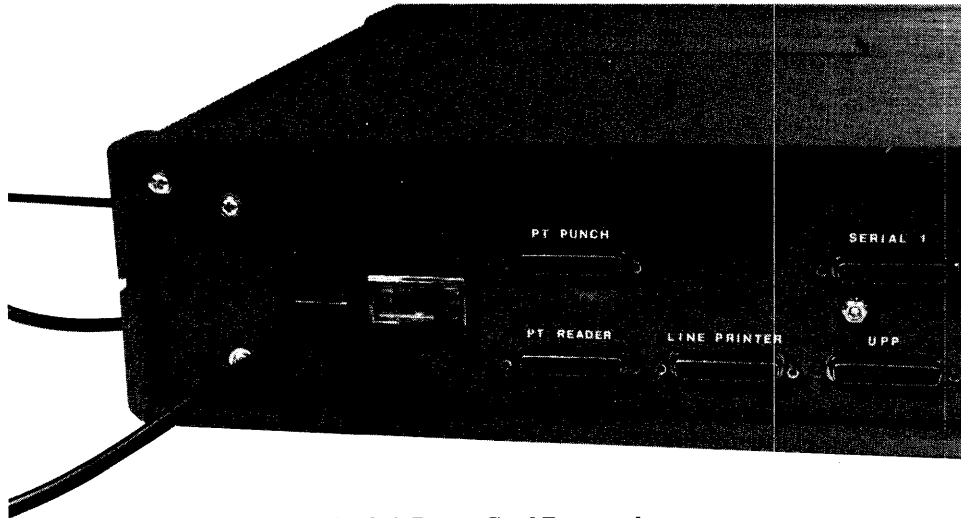

Fig. 2-4 Power Cord Receptacle

559-21

Do not plug the unit into the line power until told to do so in the Checkout section.

### Attaching A Terminal

Before you can proceed with the system checkout of the model 210 you must attach a terminal. You can attach a TTY to the SERIAL CH1 connection or a CRT terminal to the SERIAL CH2 connection. The connections are shown in Figure 2-5.

SERIAL CH1 is a 20 ma current loop interface. It is set for a baud rate of 110. The SERIAL CH2 interface is set for a baud rate of 2400. You can change the baud rate on either channel. Instructions for changing the baud rates are in Appendix D. Your TTY may require modifications for attachment to a 20ma current loop and remote activation of the reader/punch. Appendix E contains the directions for these modifications.

Appendix A shows the lines and associated pin numbers used with each of the serial interfaces. You need a male 25-pin D-subminiature plug for either connector.

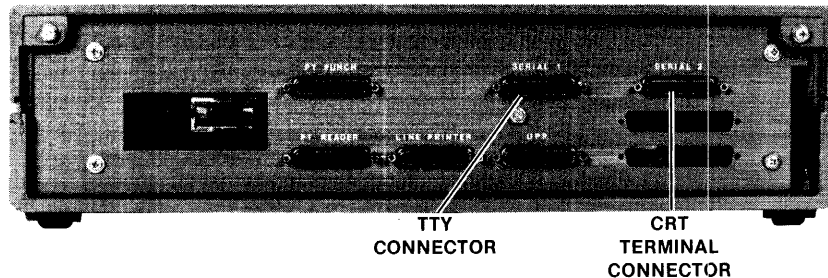

Fig. 2-5 Model 210 Terminal Connection

559-22

## Assembly - Models 220 And 230

Very little assembly is required to make your Intellec Series II operational. At the end of the following procedure, a model 220 will be completely assembled. A model 230 will be operational but will not have the diskette units cabled to the main chassis and will be missing the cards you removed during the inspection. These parts of the model 230 will be installed during the checkout.

To assemble the Intellec Series II main chassis you must connect the keyboard to the main chassis and attach the power cord.

1. Remove the keyboard cable that is coiled up inside the keyboard case. Do not unplug the cable from the keyboard.
2. Route the keyboard cable under the main chassis.
3. Plug the keyboard cable into the keyboard socket on the back of the main chassis (Figure 2-6).

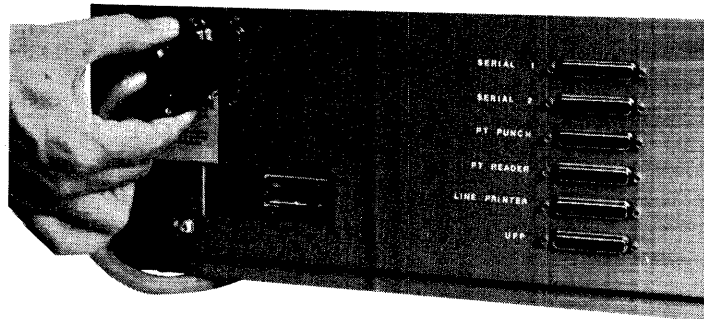

Fig. 2-6 Keyboard Connection

559-26

4. Slide the plastic shield at the main power socket to the left (Figure 2-7). Remove the voltage switching card. Make sure the voltage switching card is inserted correctly for your line voltage. This card is designed for four primary voltages as shown in Figure 2-8. The card must be plugged so you can read your voltage with the card in the slot. Plug the card back into the slot. If the card was plugged incorrectly for the voltage you ordered, call Intel or your supplier, you may have a diskette drive and CRT of the wrong voltage. Also check the voltage sticker on the front of the diskette drive to make sure it matches the voltage of the system.

### WARNING

Changing the voltage card does not change the voltage of the CRT and integral diskette drive.

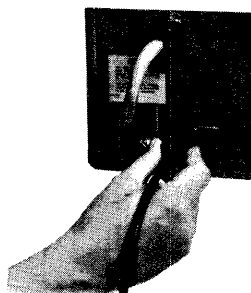

Fig. 2-7 Power Cord Receptacle

559-24

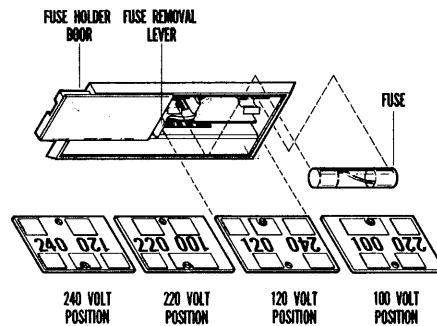

Fig. 2-8 Power Switching Card

559-12

5. Make sure the correct fuse is installed above the voltage switching card:
  - 110VAC - 8 amp
  - 220VAC - 4 amp
6. Slide the plastic shield to the right and plug the main power cord into the socket.

Do not plug the unit into the line power until told to do so in the Checkout section.

## Checkout

This procedure checks the functions of the system in steps. During this checkout, you use the Monitor, the built-in diagnostics, and the Confidence test. You first test the basic system and then add the parts of the system one at a time.

If you encounter errors or responses different from those described in the procedure, go to Chapter 3 and follow the troubleshooting procedure. If you get a diagnostic error

1. Make sure the main power switch is off. In the off position, the button is flush with the front panel. It is recessed when in the on position.
2. Plug the power cord into the wall socket.
3. Press the main power switch. The main power switch should light, the red run light should come on, and the cooling fans should run. The Monitor sign-on message should appear at the top left corner of the screen (or external terminal):

**SERIES II MONITOR Vx.y**

where x.y is the version and release of the Monitor. Following the message, the Monitor prompt character, a period (.), is displayed with the cursor following it. If nothing appears on the screen, adjust the brightness and contrast controls on the back panel of the model 220 or 230. These controls are shown in Figure 2-9. If you still don't get a display, go the Chapter 3 Troubleshooting and Service.

The ROM-based dignostics partially checked out the system when the system was turned on. If any errors were encountered, messages like the following would have been displayed on the screen:

**FAILURE — IOC NOT RESPONDING**  
**FAILURE — MONITOR CHECKSUM**  
**FAILURE — IOC INTERRUPTS**



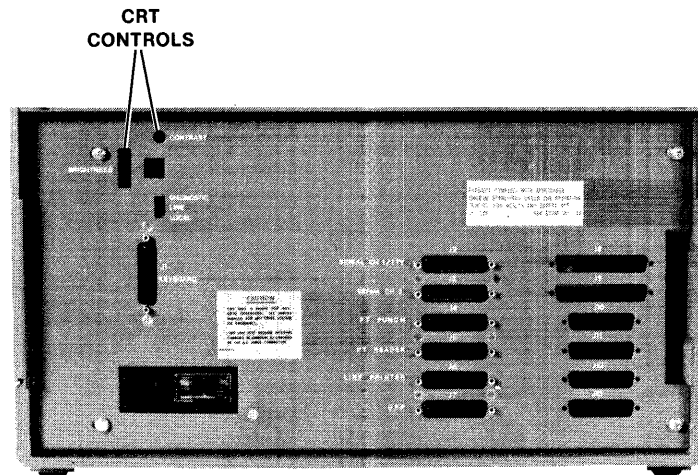

Fig. 2-9 CRT Controls

559-25

4. The diagnostics that were executed when the power was turned on did not check the memory (RAM). We will execute the diagnostics again, including the RAM test. This execution of the diagnostics will display messages describing what is being tested. From the keyboard, enter the following:

.Z\$ <CR>

The period is the prompt character displayed by the system: don't type it. Z is the Z key on the keyboard and \$ is the dollar sign character. <CR> represents the Return key on the keyboard. As a test is started, the following message is displayed:

TESTING <function>

<function> is the function being tested - CHECKSUMS, IOC, PIO, OR RAM.

When the test completes successfully, the message is expanded:

TESTING <function> — PASSED

If an error message is displayed on the screen, instead of PASSED, go to the Diagnostic Messages section in Chapter 3 of this manual.

#### NOTE

You will always get the error message "IOC NOT RESPONDING" when testing a model 210. This is a normal situation because the model does not have an input/output controller (IOC) board.

If your system only has 32K of RAM, you will always get error messages indicating failures in RAM for blocks 32K-48K and 48K-64K. This is a normal situation, ignore the messages.

5. (210 only) Attach any remaining I/O devices to the correct connection on the back panel. If you have a paper tape reader, load the Confidence Test paper tape. Enter the Monitor Read command:

.R0 <CR>

After the paper tape has been read, enter the Monitor Execute command to run the Confidence Test:

.G <CR>

A description of the Confidence Test and meanings of the messages is in Chapter 3.

The checkout of the model 210 is complete at this point. To get started with your system you can perform some of the sample sessions in *A Guide to Microcomputer Development Systems*. Then proceed to the *Intellec Model 21 User's Guide* for detailed descriptions of the functions and commands.

6. Put the Line/Diagnostic/Local switch on the back of the chassis in the Diagnostic position. Press the Reset button. The audible alarm should sound *five* times and the IOC diagnostic sign-on should be displayed:

INTELLEC SERIES II IOC DIAGNOSTIC Vx.y

If these indications don't occur go to the "IOC Diagnostics" section of Chapter 3.

Next, you can perform additional tests by pressing the G, C, K, and D keys. A description of these tests is in "IOC Diagnostics" in Chapter 3.

The remaining steps in the checkout procedure are labeled for model 230 only or model 230 and model 220. If you are checking out a model 220, go to step 14.

7. (230 only) Press the main power button to turn off the unit.
8. (230 only) Replace the SBC-032 RAM board that was removed during the equipment inspection.
9. (230 only) Press the main power button. Execute the IPB diagnostics again to test the additional 32K of RAM on the SBC-032. If an error message is displayed, go to the Diagnostic Messages section of Chapter 3.
10. (230 only) Press the main power button to turn the unit off.
11. (230 only) Plug the diskette drive unit power cord into the wall socket. Plug the diskette interface cable into the socket on the back of the diskette unit and into the top diskette interface socket on the back of the main chassis.
12. (230 only) Replace the diskette controller cards that were removed during the equipment inspection. Connect the diskette control cable to the controller interface card. You can now replace the front panel.
13. (230 only) Turn the diskette unit power on. Press the main chassis main power button.
14. (220 and 230) Load the Confidence Test diskette.
 

(Model 220) Load the diskette . Gently push the diskette all the way into the drive and close the door.

(Model 230) Load the diskette into the right hand drive (drive 0). Gently push the diskette all the way into the drive until it locks and close the door. The right hand drive is drive 0 and the left hand drive is drive 1. The test requires that the diskette be loaded in drive 0.
15. (220 and 230) Press the Reset button. The Confidence test is loaded and begins execution. This test will prompt you for certain actions. Go to the section "Confidence Test" in Chapter 3 for operating instructions for this test.

This completes the checkout of the models 220 and 230. For an introduction to the Intellec Series II, including sample sessions, see *A Guide to Microcomputer Development Systems*. Then proceed to the *ISIS-II User's Guide* for detailed descriptions of the functions and commands.

Your Intellec Series II Microcomputer Development System is designed for easy troubleshooting and repair. Its modular design makes it possible to quickly isolate a problem to a module or peripheral device.

The Integrated Processor Board (IPB) has ROM-based diagnostics that are always available. The Input/Output Controller (IOC) in the models 220 and 230 has ROM-based diagnostics. The Parallel Input/Output (PIO) board in the model 210 does not have any diagnostics but it is exercised by the IPB diagnostics. The diagnostic routines that do not modify memory or require operator intervention are executed each time the system is turned on and each time the Reset button is pressed.

A copy of the Intellec Series II Confidence test is shipped with each system. If you have a model 210, the test is on paper tape. A diskette version of the test is shipped with models 220 and 230.

Be sure to read and keep the "Service Policy and Procedure" letter shipped with the system. This letter contains a description of Intel's service facilities and "Hot Line" telephone numbers for immediate assistance and the fastest possible replacement of malfunctioning parts.

## How To Use This Chapter

When you have a problem with your Intellec Series II, always follow the appropriate troubleshooting procedure from the beginning. The procedure is designed to narrow the problem down to a single failing system component or peripheral device. The procedure does not attempt to isolate the problem to a chip or module on a board, only to the board itself. The procedure does not attempt to isolate a problem within a peripheral device, only to the whole device. When a problem is isolated to a peripheral device, go to the troubleshooting information in the device documentation manual. When the procedure calls for the execution of a diagnostic, see the Diagnostic subsection of this chapter for operating directions. When a diagnostic encounters a failure, an error message is displayed on the console. Go to the Diagnostic Messages subsection and look up the message to find the necessary repair action.

## Troubleshooting Procedure

This section contains two troubleshooting procedures, one for a unit that will not power up and one for a unit that will power up but will not function properly.

### System Will Not Power Up

This procedure covers the situation when the system does nothing, that is, the fans don't run, no lights light, and nothing appears on the screen. Before opening the chassis, make sure:

- The system is plugged in.
- There is power at the wall socket.
- The main power fuse is not blown.

**Model 210 Power Supply Test Points**

Check at connectors "C" & "B" at input to mother board.

Pin	"C" Voltage	"B" Voltage
1	signal gnd	signal bad
2	- 10V	+ 5V
3	- 12V	+ 5V
4	+ 5V	+ 12V
5	+ 5V	Key
6	Key	-
7	signal gnd	signal gnd

**Models 220 & 230 Power Supply Test Points**

Check at connector "A" at input to IOC board.

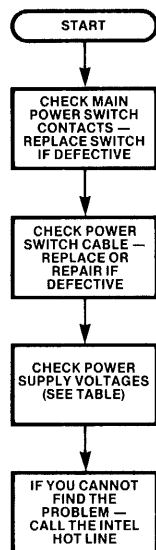

Pin	Voltage
1	+ 24V
2	+ 24V return
3	+ 5V
4	Key
5	sig gnd
6	sig gnd
7	+ 12V
8	- 10V
9	- 12V
10	frame gnd
11	

**Malfunctions on System That Will Power Up**

To isolate a malfunction, follow the procedure in this section. Before beginning this procedure, disconnect all peripheral devices attached to the back panel. Then remove all cards from the card cage except the IPB. You will replace the devices and cards one by one to isolate the problem.

After you have isolated and repaired the problem, run the Confidence test (described later in this chapter) to verify the fix.

If you cannot reproduce the original problem with the diagnostics, try the Confidence test.

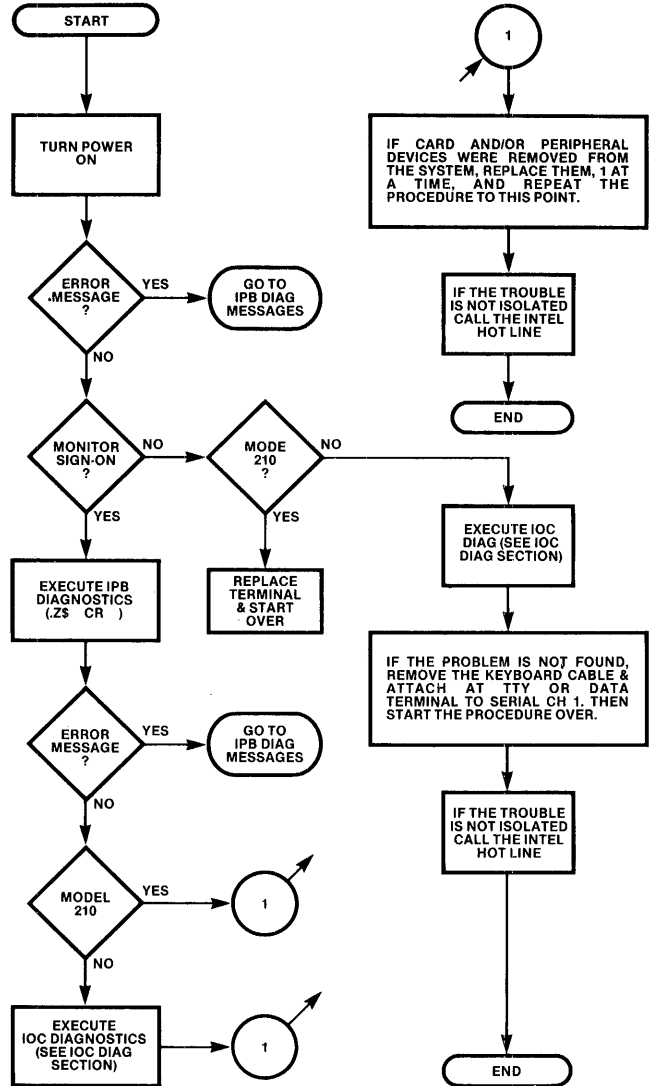

## Diagnostics

The Intellec Series II has two sets of diagnostic routines:

- IPB diagnostics, which test the major features of the IPB and invoke the non-interactive diagnostics of the IOC (in the models 220 and 230). The IPB diagnostics test the PIO board on the model 210.
- IOC diagnostics, which test the major features of the IOC in the models 220 and 230. The model 210 does not contain an IOC. The IOC diagnostics that require user intervention are not executed when invoked by the IPB diagnostics.

## IPB Diagnostics

The IPB diagnostics are invoked in any of three ways: by a Monitor command, when the is turned on, and when the Reset button is pressed. When invoked by the Monitor command, the entire set of diagnostics are executed.

To execute the diagnostics with the Monitor command, you must first put the Monitor in control of the system. You can do this pressing the interrupt 0 button or by turning on the system without a system diskette loaded. Enter the Diagnostic command:

.Z\$ <CR>

\$ represents the dollar sign key on the keyboard, not the ESC or ALT MODE character.

As each test starts, the message:

TESTING <function>

is displayed on the screen. function is CHECKSUMS, IOC, PIO, or RAM.

When the test completes without error, the message is expanded:

TESTING <function> — PASSED

If errors are encountered, error messages are displayed:

TESTING <function>

FAILURE - <error message>

The Diagnostic Messages section of this chapter lists and explains the diagnostic error messages.

### NOTE

There are two error messages you may get on your system that indicate the configuration of your system rather than an error. On a *model 210* you will always get the IOC NOT RESPONDING message because the model 210 does not have an IOC board. On a system with *less than 64K of memory* you will get one or two error messages indicating a failure in RAM blocks 32K through 48K and 48K through 64K. A 32K system gets both messages and a 48K system gets just one message.

When invoked by the Reset button or when turned on, all but the RAM functional test are performed. The RAM test destroys the contents of memory from 10H to the highest address available to the user. The test writes known data patterns into memory and then reads them. It does not destroy the Monitor work areas.

The initiation and successful completion messages are not displayed when the diagnostics are invoked by the Reset button or when turned on. However, if errors are encountered, error messages are displayed.

## IPB Error Messages

The following messages are issued by the IPB diagnostics.

FAILURE -- BOOT CHECKSUM

The expected checksum was not obtained from the BOOT ROM. Replace the IPB.

FAILURE -- IOC CHECKSUM

The expected checksum was not obtained from the IOC ROM. Replace the IOC board.

**FAILURE -- IOC INTERRUPTS**

An expected interrupt from the IOC did not occur. The problem could be in the IOC board or in the interrupt circuitry in the IPB. The IPB is more likely.

**FAILURE -- IOC NOT RESPONDING**

The IPB diagnostics attempted to execute the IOC diagnostics but got no response from the IOC. This may be a loose cable or card. Check all connections and make sure all cards are seated in their sockets. If that does not eliminate the error, replace the IOC. Other IOC errors may follow this one. Ignore any other error messages until this problem is fixed. This message is always issued when testing a model 210. It should be ignored.

**FAILURE -- IOC RAM**

The diagnostic routine did not read the same data it wrote in the IOC RAM. Replace the IOC board.

**FAILURE -- MONITOR CHECKSUM**

The expected checksum was not obtained from the Monitor ROM. Replace the IPB.

**FAILURE -- PIO CHECKSUM**

The expected checksum was not obtained. Replace the IOC board, or, in a model 210, the PIO board.

**FAILURE -- PIO INTERRUPTS**

An expected interrupt from the PIO did not occur. The problem could be in the PIO circuitry or in the interrupt circuitry in the IPB. The IPB is more likely.

**FAILURE -- PIO NOT RESPONDING**

The IPB diagnostics attempted to execute the IOC diagnostics but got no response from the PIO portion. This may be a loose cable or card. Check all connections and make sure all cards are seated in their sockets. If that does not eliminate the error, replace the IOC board, or, in a model 210, the PIO board. Other PIO errors may follow this one. Ignore any other error messages until this problem is fixed.

**FAILURE -- PIO RAM**

The diagnostic routine did not read the same data it wrote in the PIO RAM. Replace the IOC board, or, in a model 210, the PIO board.

**FAILURE -- RAM BANK mmK - nnK**

A RAM failure was encountered in the area of RAM specified in the message. The possible values for mmK - nnK are 0K - 32K, 32K - 48K, and 48K - 62K. You will receive one of these error messages for each bank of RAM that is not installed in the system. For example, a 32K system will issue this message twice, once for the 32K - 48K bank and once for the 48K - 62K bank.

**IOC Diagnostics**

The IOC diagnostics have interactive and non-interactive routines. The non-interactive routines are executed by the IPB diagnostics.

To execute the IOC diagnostics, place the Local/Diagnostic/Line switch in the Diagnostic position and press the Reset button on the front panel. The basic diagnostic test sounds the audible alarm five times at the successful completion of

the test. If the audible alarm does not sound you may have an IPB problem that prevents the Reset signal from getting to the IOC. Turn the system off and then on. If you still don't get the audible alarm, you have problems in the IOC board. If the audible alarm sounds less than five times, you have problems in the IOC board.

After the audible alarm sounds five times, the IOC diagnostic signon message is displayed:

INTELLEC SERIES II IOC DIAGNOSTIC, Vx.y

If the message is not displayed (after five sounds of the alarm) you have a defective CRT monitor.

After the sign-on message is displayed, you are requested to type a sequence of characters:

TYPE CNTL-@, RUBOUT, "U", and "\*"

These characters test all the lines in the keyboard cable. The expected bit pattern (binary code) of each character is displayed along with the actual code received across the cable. If you type the correct characters and the bit patterns do not match, you probably have a defective keyboard cable.

After the keyboard test is completed, you can execute any of the following:

- General test which tests the internal portions of the IOC.
- Keyboard/CRT test which displays the full ASCII character set and echos characters typed at the keyboard.
- Disk test which exercises the disk drive.

### **General Test**

The general test is started by pressing the G key. The test exercises the IOC memory components and issues a success or failure message. If the test fails, replace the IOC board.

### **Keyboard/CRT Test**

The keyboard/CRT test is started by pressing the K key. It fills the screen with a pattern of 95 characters. It then fills the screen with any character that is typed at the keyboard. The test keeps echoing a screen full of characters until you press the space bar.

If you type a control character (↑x), the screen is filled with ↑x string. (x is the key pressed with the control). You determine the success or failure of the test by examining the CRT displays.

### **Disk Test**

The disk test is started by pressing the D key. The test requests that you load a scratch (blank or otherwise useless) diskette in the drive. It then formats the diskette and exercises the drive.



## Confidence Test

The Intellec Series II Confidence Test is a diskette- or paper tape-based verification test that exercises standard Intellec Series II modules and input/output devices. With certain exceptions, the test returns a pass or fail indication. The exceptions are the CRT, TTY, and line printer tests that require you to examine what is displayed or printed.

The test verifies the functioning of:

- IPB
- RAM memory (minimum of 32K located at 0-32K, plus any additional contiguous and non-contiguous blocks of memory).
- CRT and keyboard (if installed)
- Single- and double-density diskette drives (if installed)
- Teletypewriter (if installed)
- Line printer (if installed)
- High Speed Paper Tape Reader (if installed)
- High Speed Paper Tape Punch (if installed)

The confidence test is partially interactive. Several of the tests require some response from the operator. If the response is not received within a predetermined period of time, the particular test is not executed and the program proceeds to the next test.

The confidence test is not a replacement for the ROM-based diagnostics but an expansion to the system diagnostic capability. The confidence test checks input/output devices that the ROM-based diagnostics do not check.

## Confidence Test Execution

To start the confidence test in a diskette system, load the diskette in drive 0 and press the Reset button on the front panel. The test programs are loaded and execution begins.

To start the confidence test in a paper tape system, load the paper tape in the reader and issue the Monitor read command (R0). The test programs are loaded into memory and you can start execution by entering a Monitor Execute (G) command.

After you begin execution, the following message is displayed:

```
INTELLEC SERIES II CONFIDENCE TEST, Vx.y
```

where x.y is the version and release number of the test.

Tests can be aborted during execution by entering Control/C (press the C key while the CTRL key is depressed). This results in the following message:

```
TEST ABORTED
```

The next test is then started. If any other key is pressed during execution, the following message is displayed:

```
TEST RUNNING, STRIKE CONTROL/C TO ABORT
```

The test continues to execute after this message is displayed.

You can abort all the tests except the IPB test. The IPB test executes too quickly to require abort capability.

### Processor Test

The IPB test executes 8080 instructions and verifies the result of each.

The test begins with the message:

**PROCESSOR TEST**

At the successful completion of the test, the program displays:

**PROCESSOR TEST PASSED**

If an error occurs, the test terminates with the address of the failure:

**PROCESSOR TEST   nnnn**

where nnnn is the address where the failure occurred. (This address is displayed as a normal function of the Monitor and cannot be used to determine the exact failure.) If a failure is encountered in the IPB test, control is passed to the Monitor. The remaining tests are not executed because results are meaningless if the IPB is malfunctioning.

### Memory Test

If the processor test completed without error, execution proceeds to the memory test. All the installed RAM except the areas used by the Monitor and by the confidence test itself is tested. The test consists of writing known patterns into RAM and then reading from RAM and comparing the data.

The memory test starts with the following message:

**MEMORY TEST (1 MIN)**

1 MIN specifies that the test takes approximately one minute.

For each contiguous block of memory the following message is displayed:

**TESTING RAM xxxx-yyyy**

where xxxx is the beginning address of the block and yyyy is the ending address. If no errors occur in the memory block, the following message is displayed:

**TESTING RAM xxxx-yyyy PASSED**

If an error occurs, the following is displayed:

**TESTING RAM xxxx-yyyy #FAILED#**

If there is more RAM installed, it is tested. When all installed RAM is tested, the test proceeds to the next test.

You can abort the test by entering Control/C.

### CRT and Keyboard Test

The CRT and keyboard test displays the full character set on the CRT and then echos all input from the keyboard to the CRT.

The CRT and keyboard test starts with the message:

**CRT TEST**

If a CRT is not installed, the following message is displayed:

**CRT TEST #CRT NOT READY#**

If the CRT is installed, the test displays two lines of the ASCII character set on the CRT. It then prompts for keyboard input:

**ECHO CHARACTERS FROM CRT KEYBOARD UNTIL ESC KEY ENTERED**

The test will echo on the CRT everything you type on the CRT keyboard. To make sure the ESC key functions correctly, press it to exit the keyboard test. If no input from the keyboard is received within 10 seconds of the last input, the test is ended with the message:

**TIME OUT, NO KEYBOARD INPUT FOR 10 SECONDS**

The detection of errors in the CRT and keyboard test is up to the operator. You should observe all displays to make sure the correct characters are being read from the keyboard and displayed on the CRT.

### **TTY Test**

The TTY test checks the TTY keyboard, printer, punch, and reader. If the punch and reader are not turned on when the program requests, they are not tested. The test begins with the message:

**TTY TEST**

If a TTY is not attached to the system, the following message is displayed:

**TTY TEST #TTY NOT READY#**

If a TTY is attached to the system, two lines of the ASCII character set are printed. Then the following message is displayed:

**ECHO CHARACTERS FROM TTY KEYBOARD UNTIL ESC KEY ENTERED**

The program will echo back to the TTY all keys that are pressed on the TTY keyboard. This phase of the test is ended by pressing the ESC key or by not pressing any key for 10 seconds. If you let the program time out, the following message is displayed:

**TIME OUT, NO KEYBOARD INPUT FOR 10 SECONDS**

The program then prompts to have the reader/punch turned on:

**TURN ON TTY PUNCH  
STRIKE CONSOLE ESC KEY (1 MIN)**

If the punch/reader is not turned on and the ESC key is not pressed within 10 seconds, the program times out with the message:

**TIME OUT, NO KEYBOARD INPUT FOR 1 MINUTE**

If you press the ESC keyboard the test punches a null leader, two lines of the ASCII character set, and a null trailer. It then displays the messages:

TURN OFF TTY PUNCH  
LOAD PUNCHED TAPE IN TTY READER  
STRIKE CONSOLE ESC KEY

Press the ESC key on the keyboard after you load the paper tape that was punched in the punch test. If the ESC key is not pressed within one minute, the program times out with the message:

TIME OUT, NO KEYBOARD INPUT FOR 1 MINUTE

If errors are encountered while reading the tape, that is, if the program does not read what it punched, the following message is displayed:

#TTY DATA ERRORS#

The test cannot determine if the error occurred during the punch or read operation. You should check the code on the tape to determine if it was punched correctly.

### Diskette Test

The diskette test checks all drives on the system regardless of the density. The test requires scratch diskettes in each drive to be tested. The program prompts when it is ready for the scratch diskettes.

### WARNING

Be sure to replace the diskette containing the confidence test with a scratch diskette. Otherwise, if the diskette is not write-protected, the test will destroy the diskette contents.

The test begins with the message:

DISKETTE TEST

If there are no diskette controllers present in the system, the following message is displayed:

#NO DISKETTE CONTROLLER PRESENT#

If there are diskette controllers present, the program continues with the following warning and prompt:

WARNING: DISKETTE FILES ON DRIVES TESTED WILL BE DESTROYED

LOAD WRITE ENABLED SCRATCH DISKETTE INTO ANY DRIVE TO BE TESTED

STRIKE CONSOLE ESC KEY (1 MIN)

If there is no input for one minute, the following message is displayed:

TIME OUT, NO KEYBOARD INPUT FOR 1 MINUTE  
DISKETTE DRIVES NOT TESTED

The test starts with drive 0 and proceeds through all the possible drives, 0 through 5. As each the test of each drive begins, the following message is displayed:

TESTING DRIVE #n

where n is the drive number. After this message is displayed, the test waits three seconds before starting the test. **This is your last chance to abort the test if you did not load a *scratch* diskette.**

TO ABORT

Press Control/C  
or  
open the drive door

Any one of the following error messages may be displayed for each drive:

#NO DISKETTE CONTROLLER PRESENT#  
#UNEXPECTED I/O COMPLETE#  
#DRIVE STATUS CHANGE#  
#TIME OUT#  
#DRIVE NOT READY#  
#WRITE ERROR#  
#WRITE PROTECTED#  
#DATA OVERRUN#  
#DATA/ADDRESS MARK ERROR#  
#ADDRESS MARK ERROR#  
#ID CRC ERROR#  
#SYNC ERROR#  
#ADDRESS ERROR#  
#SEEK ERROR#  
#DATA CRC ERROR#  
#DELETED RECORD ERROR#

If no errors are encountered the passed message is displayed:

PASSED

### **Line Printer Test**

The line printer test checks high and low speed printers. The test prints the full character set on the printer. You must check the printed material to make sure it correct and lined up.

The line printer test checks for a line printer in the system.

The test begins with the message:

LINE PRINTER TEST

If no printer is present or it is powered off, the following message is displayed and the program waits 10 seconds for the printer to be turned on:

#LINE PRINTER NOT READY#

TEST WAITING 10 SECONDS FOR DEVICE "READY"

You have 10 seconds to make the printer ready. If it becomes ready during the 10 seconds, the following message is displayed:

**NOW PRINTING ASCII CHARACTER SET**

The program prints 20 lines of the ASCII character set on the printer. You must examine the printout to determine the success or failure of the test.

If the printer is not present or made ready within 10 seconds, the time out message is displayed, and the next test is started.

**High Speed Punch Test**

The high speed punch test checks for a high speed punch in the system. The test begins with the message:

**HIGH SPEED PUNCH TEST**

If no punch is present or is powered off, the following message is displayed and the program waits 10 seconds for you to turn the punch on:

**#HIGH SPEED PUNCH NOT READY#**

**TEST WAITING 10 SECONDS FOR DEVICE "READY"**

You have 10 seconds to make the punch ready. If it becomes ready during the 10 seconds, the following message is displayed:

**NOW PUNCHING ASCII CHARACTER SET**

The program punches a null header, two lines of the ASCII character set, and a null trailer. You may examine the paper tape to determine the success or failure of the test, or you can use the tape as input for the high speed reader test.

**High Speed Reader Test**

The high speed reader test checks for a high speed reader in the system. The test begins with the message:

**HIGH SPEED READER TEST**

If no reader is present or is powered off, the following message is displayed and the program waits 10 seconds for you to turn the reader on:

**#HIGH SPEED READER NOT READY#**

**TEST WAITING 10 SECONDS FOR DEVICE "READY"**

You have 10 seconds to make the reader ready. If it becomes ready during the 10 seconds, the following message is displayed:

**LOAD HIGH SPEED READER WITH TAPE FROM TTY OR HIGH SPEED PUNCH TEST**

**STRIKE ANY CONSOLE KEY (1 MIN)**

The test reads the tape and displays the following message if it encounters any unexpected data:

**#HIGH SPEED READER DATA ERROR#**

The program cannot determine if the error occurred during punching or reading. You must determine where the error is by examining the punched tape.

### **End of Test**

At the completion of all the tests, the program displays the end message:

**END OF CONFIDENCE TEST**

Control of the system is returned to Monitor. You can rerun the tests by entering the Monitor Execute (G) command. No starting address is required, the confidence test starting address is loaded in the program counter (P register).



# CHAPTER 4 UPGRADE AND ENHANCEMENT PROCEDURES

This chapter contains the procedures to upgrade your Intellec Series II to increase functional capability. The procedures covered are:

- Adding memory to models 210 and 220
- Adding disk drives
- Adding an expansion chassis
- Adding peripherals
  - CRT Terminal
  - TTY
  - MDS-PRN Printer
  - MDS-770/771 Printer
  - High Speed Tape Reader and Punch
  - Universal Prom Programmer
- Adding in-circuit emulators to the models 220 and 230
- Adding multibus modules to the models 220 and 230

## NOTE

Before adding components that will be powered from the Intellec Series II power supply, make sure that the power supply has the capacity to handle the component. Appendix C contains tables of available current capacity for each of the power supplies for each model.

This chapter also contains the procedure to incorporate the model 210 enhancement package that increases the model 210 capability to that of a model 220.

## Adding RAM To The Model 210 And 220

The Intellec Series II models 210 and 220 come with 32K of RAM. You can upgrade the RAM with the addition of an SBC-032 32K RAM board, or 1 or 2 SBC-016 16K RAM Modules.

When an SBC-032 is added, it supplies RAM addresses 32K through 64K.

The SBC-016 16K RAM Module can be used to supply address spaces 32K through 48K, 48K through 64K, or both (with 2 boards, of course).

## Adding the SBC-032 RAM Board

You can insert the SBC-032 RAM board into any available socket in the card cage (usually the slot below the IPB is used). Before installing the board, make sure the following jumpers are in place for operation in the system as address space 32K through 64K. The correct jumper positions are shown in the following table. Figure 4-1 shows the location of these jumpers.



ADDRESS SELECTION JUMPERS		TIMING SELECTION JUMPERS	
Location	Jumper	Location	Jumper
W1	E1-E10	W8	E29-E31
W2	E4-E15	W12	T50-L1
W5	E5-E21		
W6	E7-E17		
W7	E8-E18		

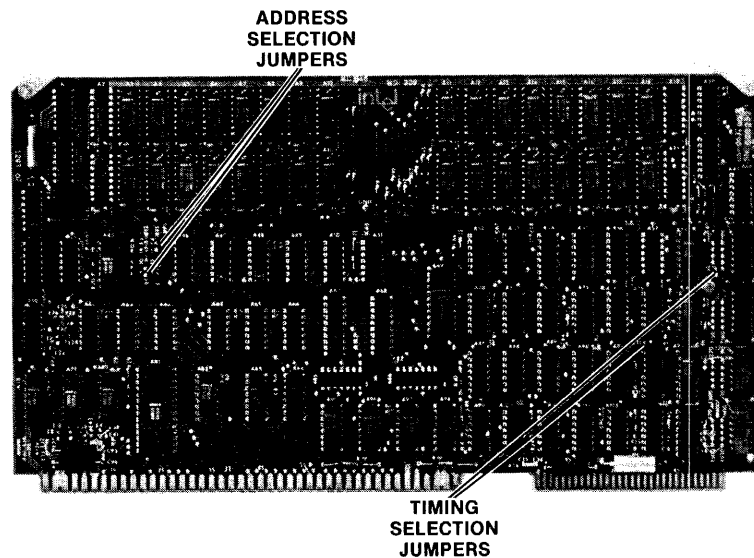

Fig. 4-1 SBC 032 Jumper Locations

559-9

After checking the jumpers, do the following:

1. Turn the system power off.
2. Remove the front panel by turning the screws at either end a quarter turn counter-clockwise and pulling the cover off.
3. Insert the SCB-032 in any available slot in the card cage. Make sure the board is seated in the socket.
4. Replace the front panel and tighten the screws.

### Checkout of the SBC-032 RAM Board

Check out the SBC-032 in the system with the following procedure:

1. Press the main power button. Do not load a diskette in the diskette drive.
2. Execute the IPB diagnostics by entering:  
`.Z$ <CR>`

If errors messages are displayed, go the Diagnostic Messages section in Chapter 3.

## Adding the SBC-016 16K RAM Module

You can insert the SBC-016 16K RAM Module into any available socket in the card cage. Before installing the board, make sure the following jumpers are in place for operation in the Intellec Series II models 210 or 220. The correct jumper positions are listed in the following table. Figure 4-2 shows the locations of the jumpers.

ACKNOWLEDGE SELECT JUMPER	MODULE SELECT JUMPER	
	Memory Space	Jumper
1-2	32K-48K	7-6
	48K-64K	7-5

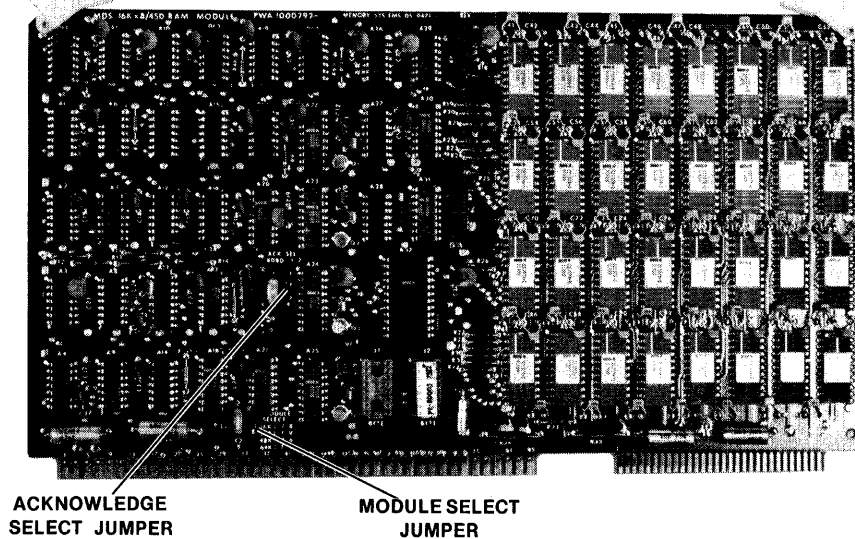

Fig. 4-2 SBC-016 16K RAM Module Jumper Locations

559-26

After checking (and adjusting if necessary) the jumpers, do the following:

1. Turn the system power off.
2. Remove the front panel by turning the screws at either end a quarter turn counter-clockwise and pulling the cover off.
3. Insert the board(s) in any available slot in the card cage. Make sure the board is seated in the socket.
4. Replace the front panel and tighten the screws.

### Checkout of the SBC-016 16K RAM Module

Check out the SBC-016 16K RAM Module in the system with the following procedure:

1. Press the main power button. Do not load a diskette in the diskette drive.
2. Execute the IPB diagnostics by entering:  
`.Z$ <CR>`

If errors messages are displayed, go to the Diagnostic Messages section of Chapter 3.

## Adding Diskette Controllers And Drives

You can add a single- or double-density controller to the models 210, 220, and 230. You must have two adjacent card cage slots available for the controller. The controllers for both the single or double-density drives consists of an interface board, a channel board, and a dual auxiliary connector.

The single-density controller handles two single-density drives. The double-density controller handles four double density drives.

The model 230 has a double-density disk controller installed in the card cage. This model comes with two double-density diskette drives. The model 230 has two disk interface connectors on the back panel, as shown in Figure 4-3. The bottom connector interfaces with drives 0 and 1. The top connector interfaces with drives 2 and 3 (if installed).

### NOTE

If you move 2-card components from an Intellec Microcomputed Development System to an Intellec Series II, you cannot use the auxiliary connector from the old system. Use one of the spare auxiliary connectors shipped with the Series II system. The spacing between the Series II card cage slots is smaller.

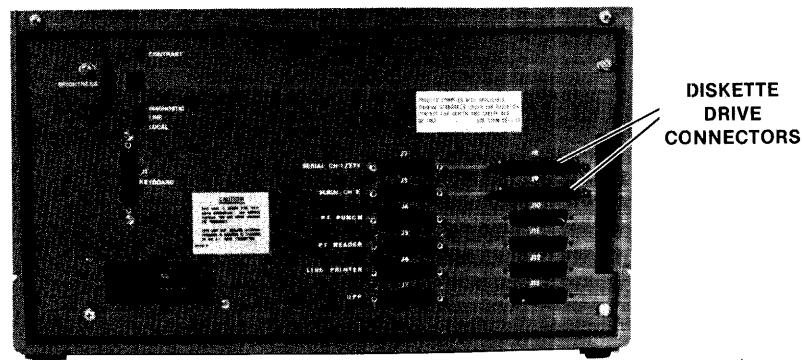

Fig. 4-3 Model 230 Disk Drive Connectors

559-27

The model 220 has a single-density disk controller integrated in the IOC board. This model comes with one drive mounted in the main chassis. If no other drives are installed, this drive is designated drive 0.

## Installing A Double Density Disk Controller In A Model 210 or 220

The double-density disk controller consists of two boards, an interface board and a channel board. Together these boards are referred to in this manual as the controller.

The two controller boards communicate with each other through a 60-pin auxiliary connector supplied with the boards. The controller interface board communicates with the drives through the Floppy Disk Controller cable which is plugged into the 100-pin connector on the upper edge of the interface board. The channel board also

has a 100-pin connector on the upper edge, but this connector is only used for test points during problem analysis. The other end of the controller cable has two sockets that are mounted on the Intellec Series II back panel.

Before installing the controller you must assign a base address to the channel board and set the interrupt level on the interface board.

ISIS-II requires a base address of 78H. Set the base address switches which are shown in Figure 4-4 to the positions shown in Figure 4-5.

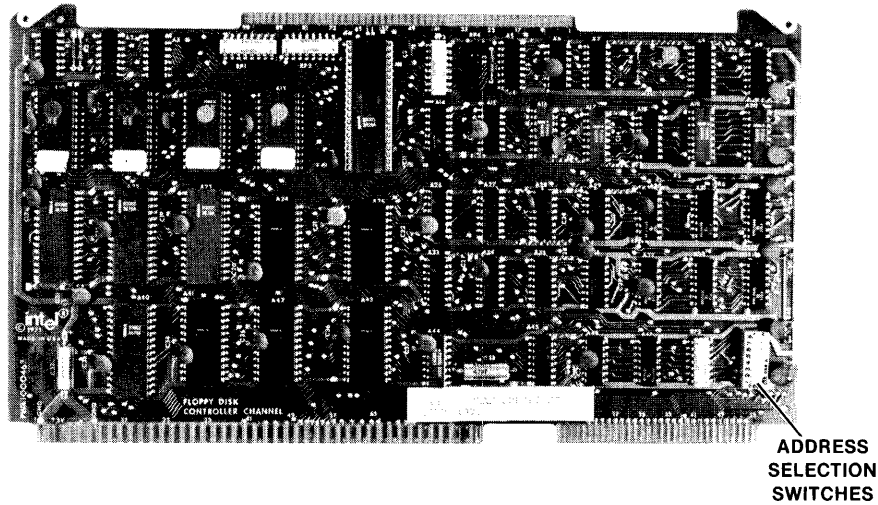

Fig. 4-4 Address Selection Switches on the Channel Board

559-28

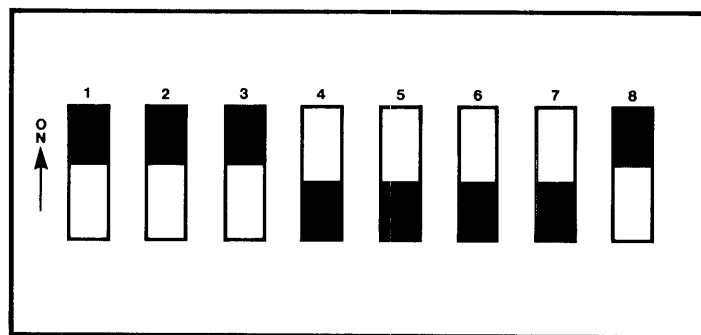
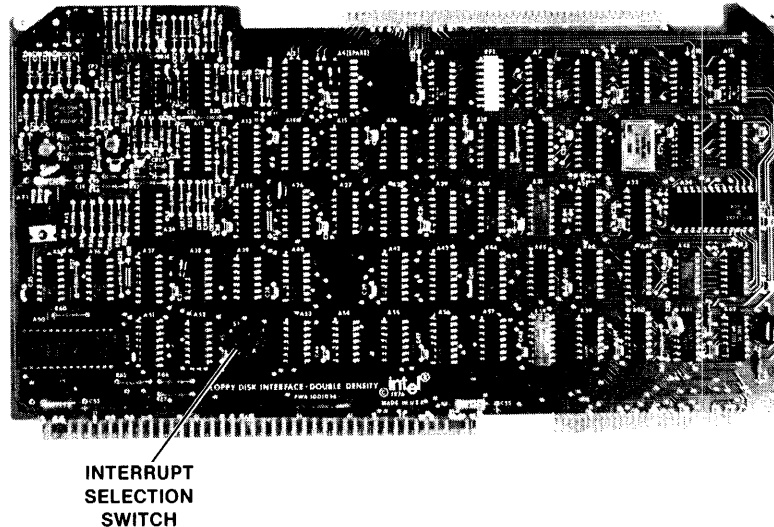

Fig. 4-5 Address Selection Switch Positions for 78H

559-30

ISIS-II requires an interrupt level of 3. Set the interrupt selector switch which is shown in Figure 4-6 to position 2 (which is interrupt level 3).

---



**Fig. 4-6 Interrupt Selection Switch on the Interface Board**

559-29

Now install the disk controller according to the following procedure:

1. Turn off the system.
2. Remove the top cover of the main chassis. The cover is held in place with two screws on the top front and two screws on the back panel. Remove the screws and lift the cover off.
3. Remove the front panel.
4. Choose two adjacent slots in the card cage for the disk controller cards.
5. Insert the two cards into the 60-pin auxiliary connector. This connector will not be physically attached to the mother board.
6. Insert the cards (in the auxiliary connector) into the card cage slots. Press them firmly into the bus sockets.
7. Install the two connectors on the disk control cable in the holes on the back panel as shown in Figure 4-7. Put the connector for drives 0 and 1 in the bottom hole and drives 2 and 3 in the top hole. Attach the connectors with hardware supplied with the controller.
8. Dress the cable along the side of the main chassis as shown in Figure 4-8.
9. Plug the 100-pin plug into the edge connector on the upper edge of interface card.
10. Replace the main chassis top cover.
11. Plug the disk interface cable into the top connector on the back panel of the main chassis. Plug the other end of the cable into the connector on the disk unit.

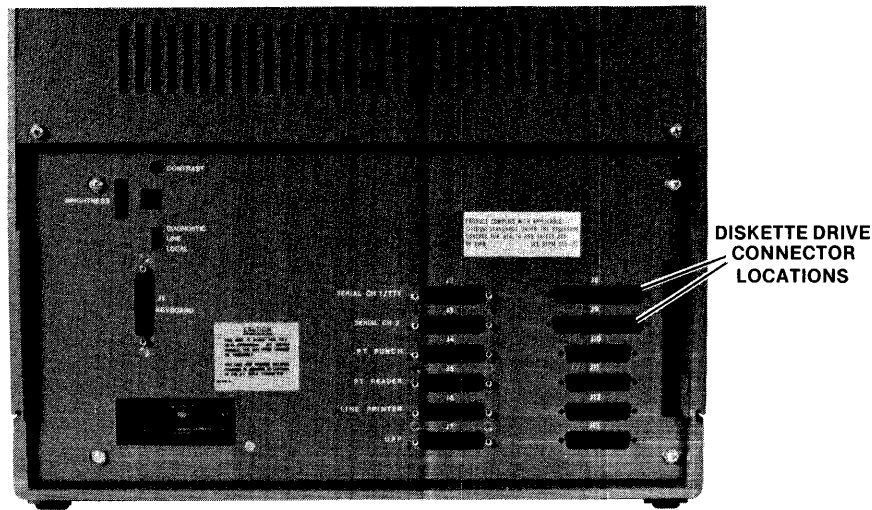

Fig. 4-7 Model 220 Back Panel Disk Cable Locations

559-31

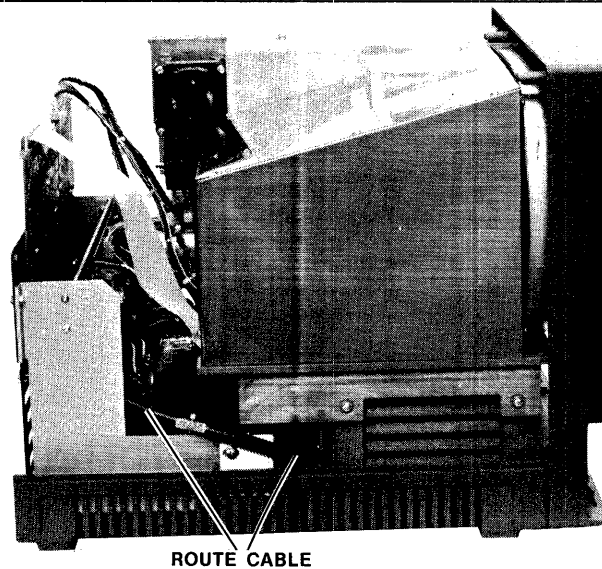

Fig. 4-8 Locating the Disk Control Cable

559-8

### Checkout of the Disk Drive and Controller

Check out the disk drives and controller in the system with the following procedure:

1. Turn the disk unit power on but do not load a diskette.
2. Press the main power button on the main chassis.
3. Execute the IOC diagnostics (see Diagnostics in Chapter 3). If any error messages were displayed, go to the Diagnostic Messages section of Chapter 3.
4. Put a Diagnostic Confidence Test disk in drive 0. Drive 0 is now the right hand drive in the new disk drive unit. The chassis mounted drive is now drive 4.
5. Press Reset and make sure test loads and displays the sign on message.
6. Execute the applicable tests, especially the diskette test.

## Installing an Additional Double Density Disk Unit in the Model 220 or 230

This procedure covers the addition of a two disk drive unit to a model 230 or to a model 220 that has a double-density disk controller installed.

You can install the two drive unit by simply plugging it into the additional disk interface connection on the back panel, below the current disk interface cable.

The drives connected to this connection will have addresses F2 and F3.

Checkout the new drives with the Confidence test, see Chapter 3 for operating instructions.

## Connecting the Integral Drive to a Double-Density Controller

The integral diskette drive in the model 220 is attached to the IOC board. The controller in the IOC board is a single-density controller. You can connect this drive to a double-density controller by replacing the interface cable with another interface cable and plugging it into the top diskette connection on the back panel as shown in Figure 4-9.

In this configuration, the integral diskette drive is drive 2.

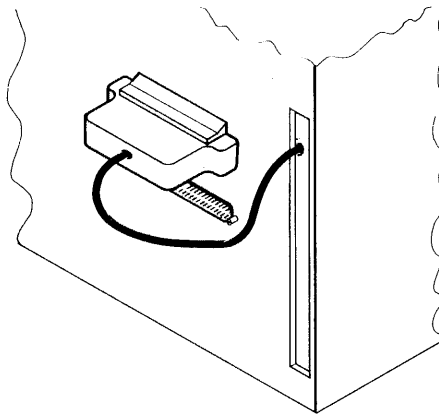

Fig. 4-9 Cabling Integral Drive to DD Controller

559-43

## Installing A Disk Drive In The Model 230 Chassis

One disk drive can be installed in the model 230 chassis. If it is to be used as a single-density drive, it plugs into the IOC board. As a double-density drive it uses one of the disk interface connections on the back panel.

Install the disk drive according to the following procedure:

1. Turn off the system.
2. Remove the chassis top cover. The cover is held in place by two screws in the top front and two screws in the back panel. Remove the screws and lift the cover off.
3. Remove the top protective cover over the CRT. The protective cover is held in place by six screws as shown in Figure 4-10.

4. Remove the four screws that hold the CRT unit to the chassis member. Slide the CRT unit to the side of the chassis. It is not necessary to remove it completely. See Figure 4-11.
5. Remove the blank panel from the front of the chassis. It is held in place by three screws on the back side. See Figure 4-12.
6. Install the disk drive bracket to the inboard holes next to the CRT. See Figure 4-13.
7. Slide the CRT unit back into place and replace the four mounting screws. Replace the top protective cover.
8. Slide the disk unit into place from the back of the chassis. Be careful not damage the power supply board. See Figure 4-14.
9. Bolt the disk drive to the top bracket with the supplied bolts.
10. Install the side bracket and tighten the screws as shown in Figure 4-15.
11. Attach the DC and AC power cables as shown in Figure 4-16.

Single density interface cable installation: Attach the interface cable from the disk drive to the IOC board as shown in Figure 4-17.

Double density interface cable installation: Attach the interface cable from the disk drive to the back panel disk interface connection as shown in Figure 4-18.

---

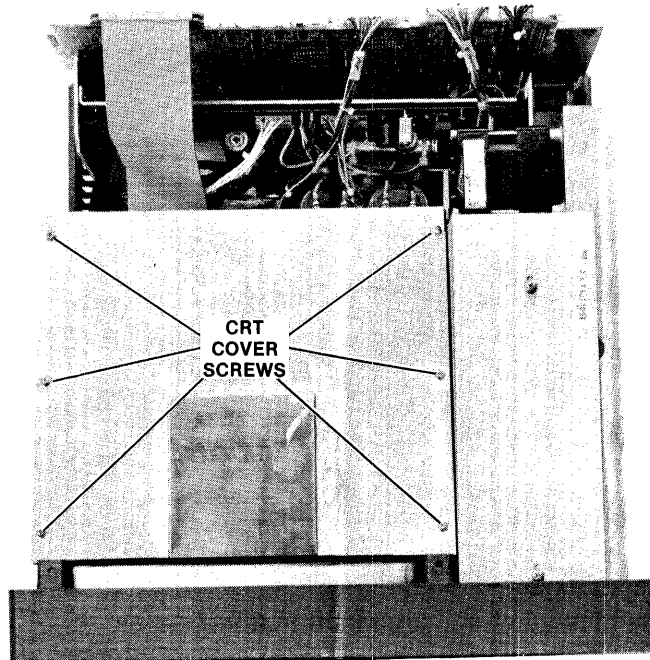

**Fig. 4-10 CRT Cover Removal**

559-7



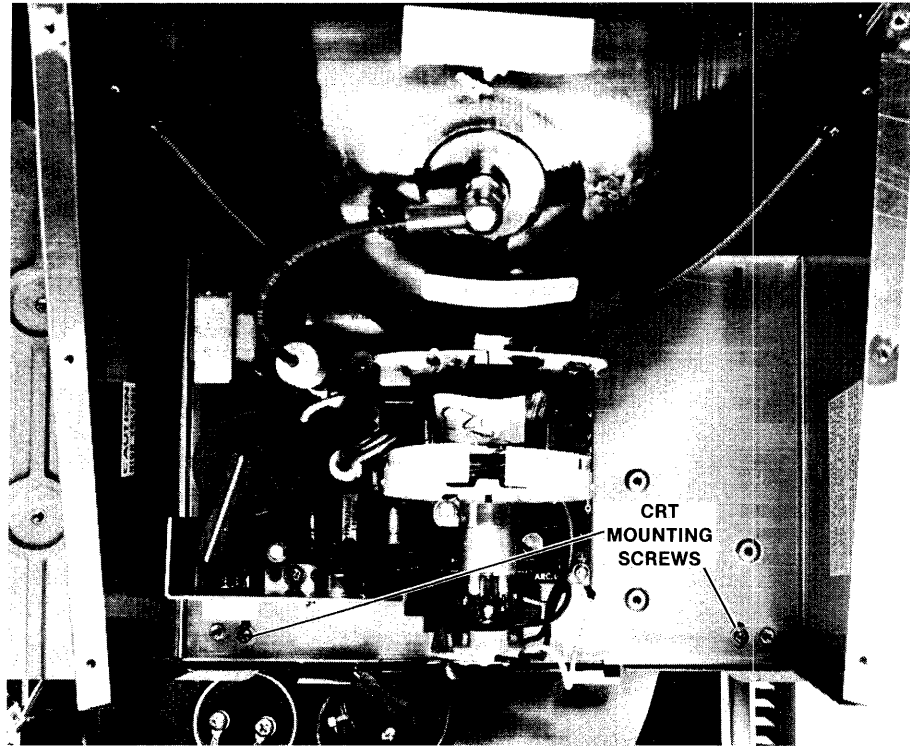

Fig. 4-11 CRT Mounting Screws

559-32

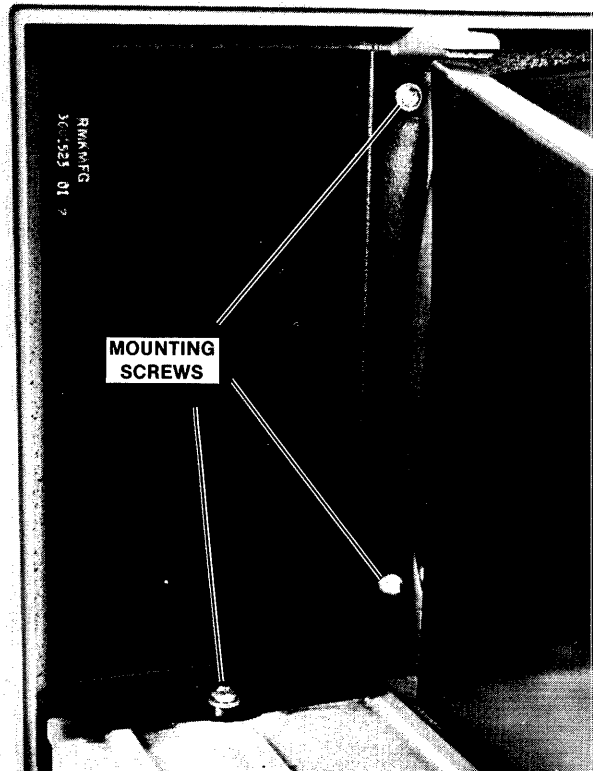

Fig. 4-12 Panel Removal

559-33

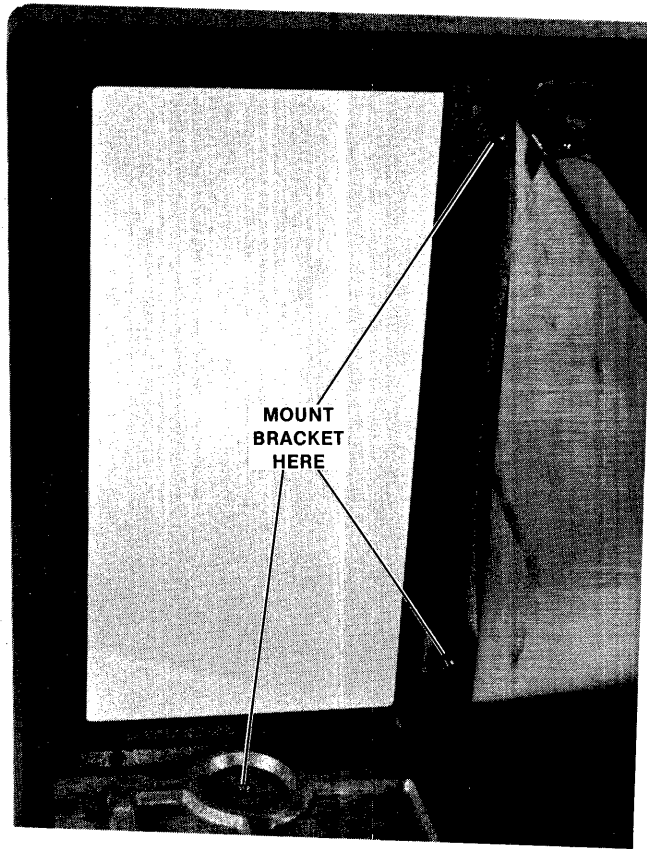

Fig. 4-13 Bracket Installation

559-34

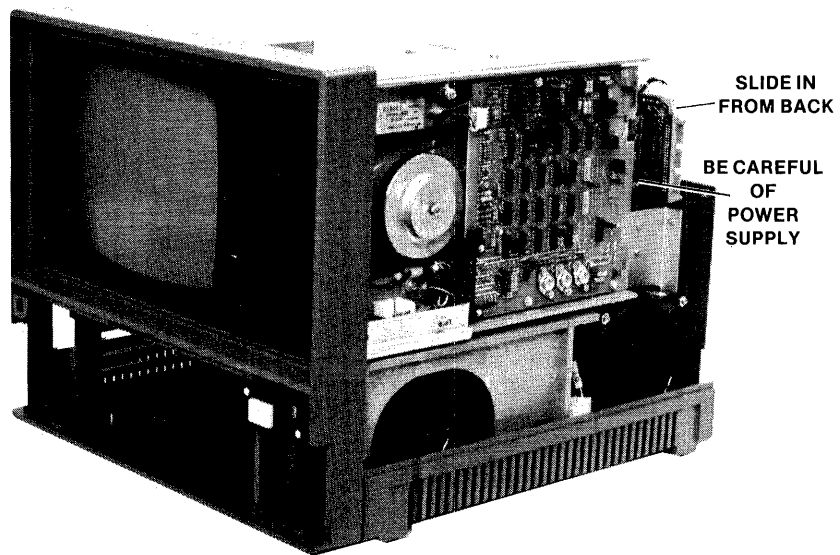

Fig. 4-14 Inserting Diskette Drive

559-36

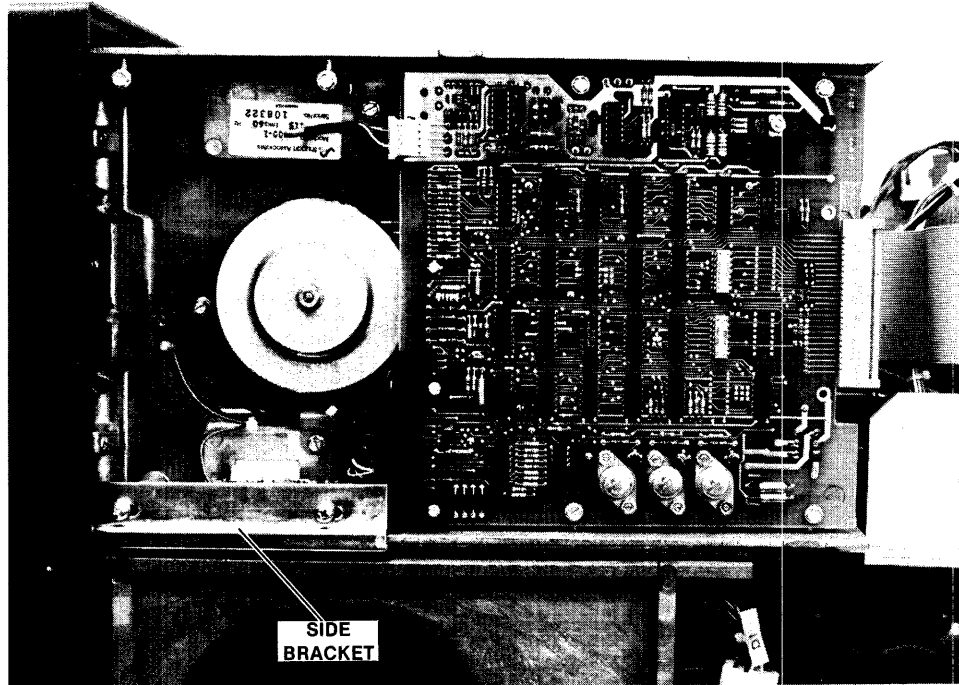

Fig. 4-15 Installing the Side Bracket

559-35

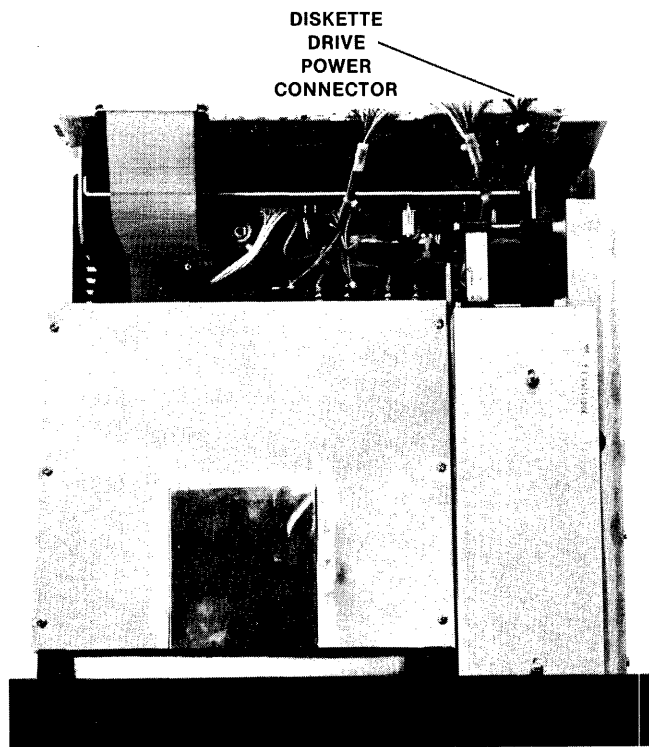

Fig. 4-16 Disk Drive Power Connections

559-38

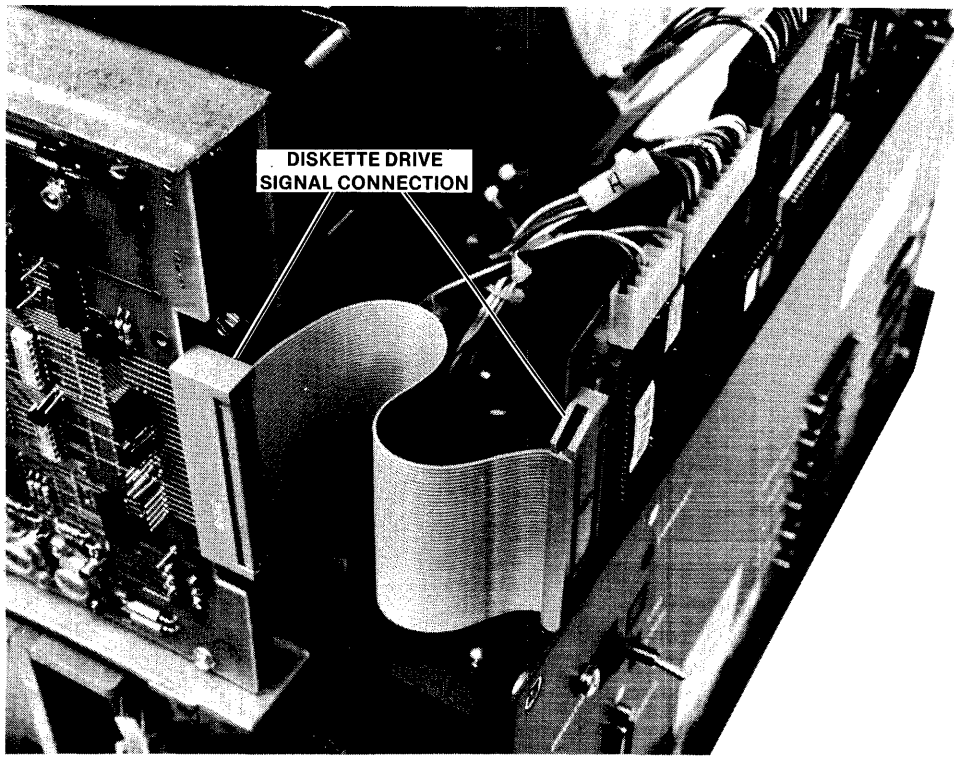

Fig. 4-17 Single Density Interface Cable Connections

559-37

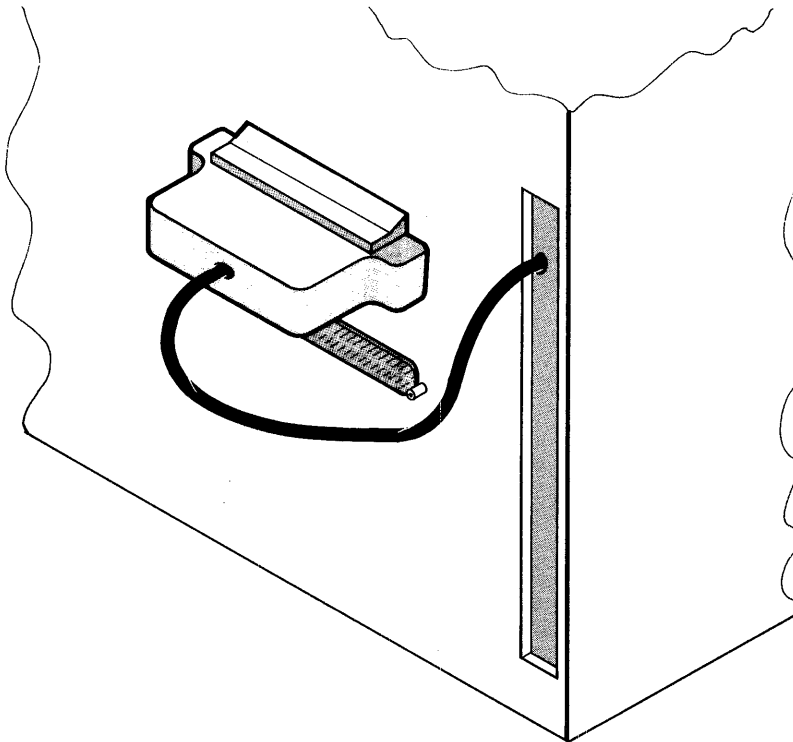

Fig. 4-18 Double Density Interface Cable Connections

559-43

If the new drive is a single-density unit, it has an address of F4. If all other drives are moved from the system for some reason, it has an address of F0.

If the new drive is a double-density unit, it is drive 0 if it is plugged into the bottom disk interface connection on the back panel or is drive 2 if plugged into the top connector.

### Checkout of Main Chassis Disk Unit

If the new main chassis disk drive is single-density, execute the IOC diagnostics. See IOC diagnostic section in Chapter 3.

Load the Diagnostic Confidence Test diskette in drive 0 and execute the applicable tests, especially the diskette test. The operating instructions for the test is in Chapter 3 of this manual.

## Installing An Expansion Chassis

An expansion chassis adds four card slots to you Intellec Series II. The expansion chassis contains its own power supply. The only connection with the main chassis is the bus. The expansion chassis is powered by a control line from the main chassis. A relay on the expansion chassis mother board is controlled from the main chassis.

The expansion chassis must set under the main chassis.

Install an expansion chassis according to the following procedure:

1. Turn off the system power.
2. Turn the main chassis on its side.
3. Remove the cable port cover on the bottom of the main chassis as shown in Figure 4-19.
4. Remove the cable port cover on the top of the expansion chassis as shown in Figure 4-20.
5. Plug the bus cables into the connectors inside the cable port on the top of the expansion chassis.
6. Place the main chassis on top of the expansion chassis and tilt it backward. Holding it in place, plug the bus cables into the connectors inside the main chassis cable port.

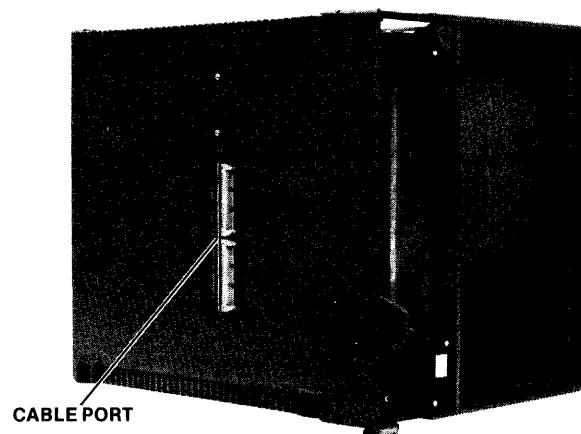

Fig. 4-19 Cable Port in Main Chassis

559-3

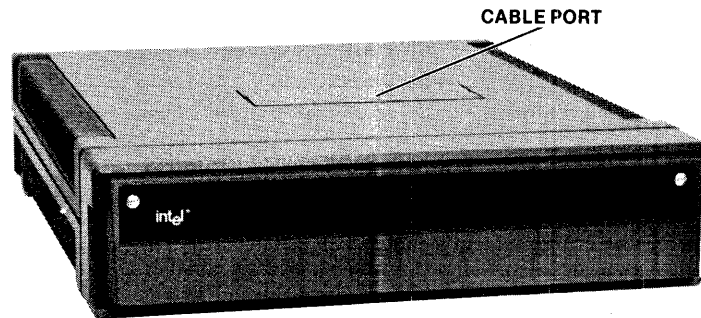

Fig. 4-20 Cable Port in Expansion Chassis

559-1

## Checkout Of The Expansion Chassis

The checkout of the expansion chassis requires a functional unit that is known to operate completely in the main chassis. Before installing the board in expansion chassis, plug the main chassis and expansion chassis into the wall sockets. Press the main power button on the main chassis. Make sure that cooling fans in the expansion chassis are operating.

Turn off the power.

Install the unit you have chosen for the checkout and install it in the expansion chassis. Perform a normal checkout of this unit.

## Adding Peripherals

Your Intellec Series II has a socket configured for attachment of the following devices:

- Line printer
- Paper tape reader
- Paper tape punch
- Universal PROM programmer
- TTY - (Serial channel 1 - see Appendix A for information on configuring this interface)
- Modem - (Serial channel 2 - see Appendix A for information on configuring this interface)
- Data terminal - (Serial channel 2 - see Appendix A for information on configuring this interface)

Figure 4-21 shows the interface connectors on the back panel of the models 210, 220, and 230 where these devices are attached to the system.

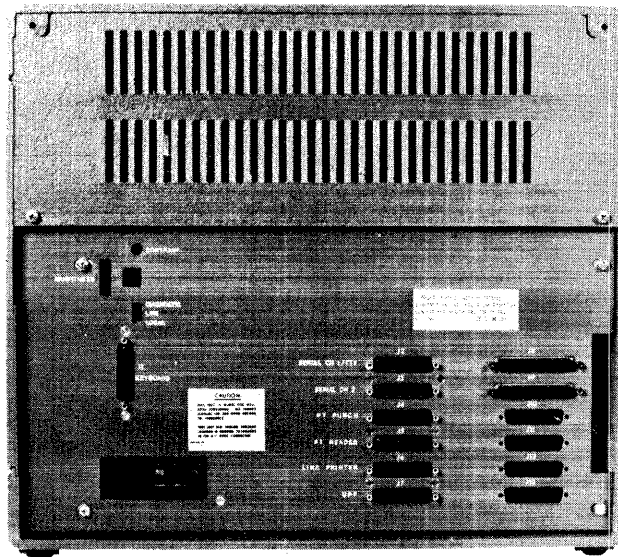

MODELS 220 AND 230

559-40

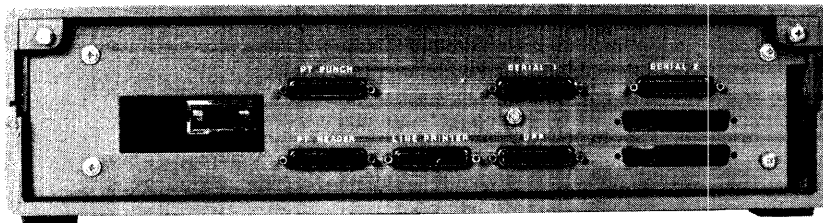

MODEL 210

Fig. 4-21 Model 210, 220 and 230 Interface Connections

559-39

## Adding In-Circuit Emulators

You can install any of the in-circuit emulators in an Intellec Series II. The procedures to install the in circuit emulators in the Series II are in the in circuit emulator documentation packages.

### NOTE

If you move 2-card components from an Intellec Microcomputed Development System to an Intellec Series II, you cannot use the auxiliary connector from the old system. Use one of the spare auxiliary connectors shipped with the Series II system. The spacing between the Series II card cage slots is smaller.

## Adding Multibus Modules

You can add any Multibus compatible module to the Intellec Series II. The installation of the modules is covered in the module documentation. You only concern when installing new modules in the Intellec Series II is whether there is enough power available to drive the module. Check Appendix B and subtract the power consumption of other modules you have installed.

## Installing The Model 210 Enhancement Package

The model 210 enhancement package lets the model 210 user add model 220 capability without duplicating the hardware available in the model 210.

After the enhancement package is installed, you will have an Intellec Series II model 220. Optionally, you can convert you old model 210 chassis to an expansion chassis.

The enhancement package contains:

- Model 220 main chassis with a single-density disk drive.
- Intellec Series II keyboard.
- Expansion chassis bus cables.
- Expansion chassis mother board.
- Expansion chassis front panel overlay.

The following procedure covers moving the IPB to the new chassis and, (if you choose) modifying the old 210 to an expansion chasis. When you have finished this procedure, go to the Installation chapter of this manual and perform the model 220 installation and checkout procedure.

1. Disconnect the model 210 power cord.
2. Remove the model 210 front panel.
3. Remove the model 210 top cover. It is held in place by two screws on the back panel.
4. Remove the IPB from the model 210 chassis.
5. Remove the “piggy-back” ROM card from the IPB. The ROM card is held in place by plastic snap fasteners. Lift the ROM card and unplug the cables from the IPB. This ROM card will not be used in the new system.
6. Insert the IPB in the top slot of the 220 chassis.
7. Remove all additional cards you may have installed in the model 210 chassis. These will be replaced in either chassis when the conversion is complete.
8. Remove the model 210 mother board as shown in Figure 4-22.

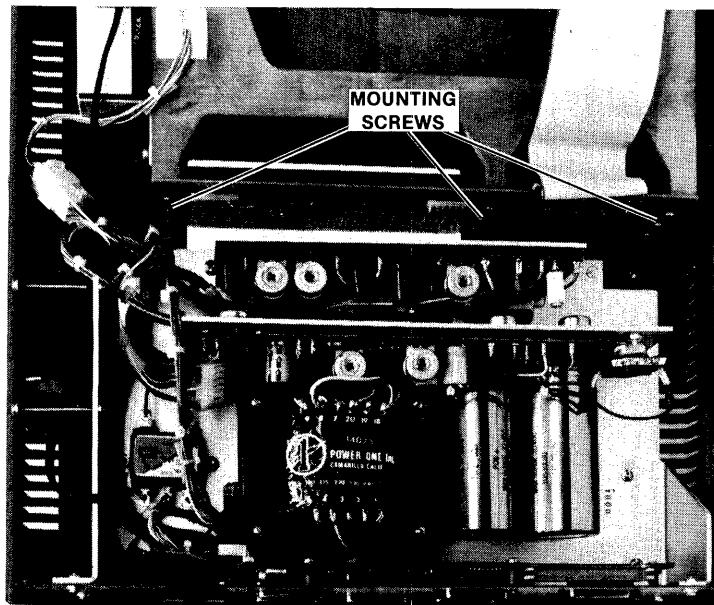

**Fig. 4-22 Model 210 Mother Board Removal**

559-41



9. Install the expansion chassis mother board as shown in Figure 4-23.

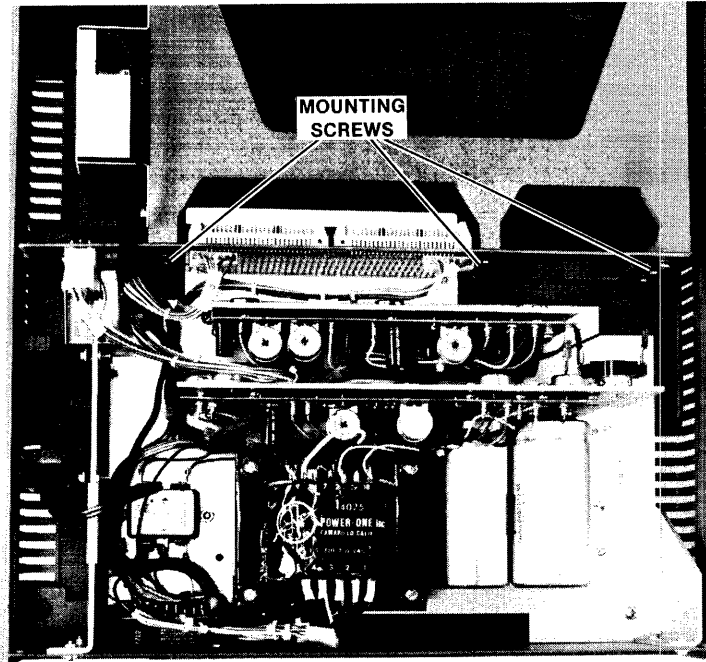

Fig. 4-23 Expansion Chassis Mother Board Installation

559-42

10. Remove the cable port panel from the model 210 top cover.
11. Replace the model 210 (which is now an expansion chassis) top cover.
12. Place the front panel overlay on the old model 210 front panel. Then put it back on the chassis.
13. Go to the section, "Installing an Expansion Chassis," in this chapter for instructions on installing the expansion chassis.
14. Go to the Installation chapter for the model 220 installation and checkout procedure. Do not replace the product cards (if any) until after the checkout. In the unlikely event that there are problems, they will be easier to isolate if a basic system is being checked out.



# APPENDIX A CONFIGURING THE SERIAL INTERFACES

The problems that sometimes occur when connecting devices from different manufactures through an interface designated RS232C are usually due to different interpretations of the RS232C specification.

The Intellec Series II serial interfaces, Serial 1 and Serial 2, are designed to be adaptable to any interpretation of the specification. The serial interfaces are implemented with extensive line jumpering capability.

As shipped, Serial 1 is jumpered for a standard TTY terminal configuration. Serial 2 is jumpered for modem or CRT terminal.

The jumpers are located at the top right corner of the IOC board and are accessible by removing the main chassis top cover. Figure A-1 shows the lines and jumpers available in Serial 1, with the jumpers shown as shipped. Figure A-2 shows the lines and jumpers available in Serial 2, with the jumpers shown as shipped.

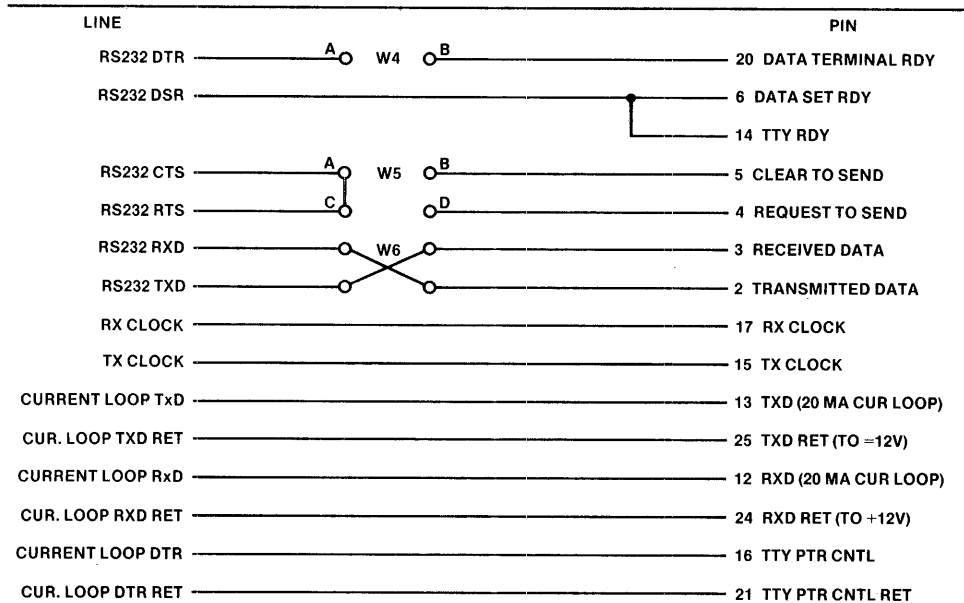

Fig. A-1 Serial 1 Lines and Jumpers

559-10

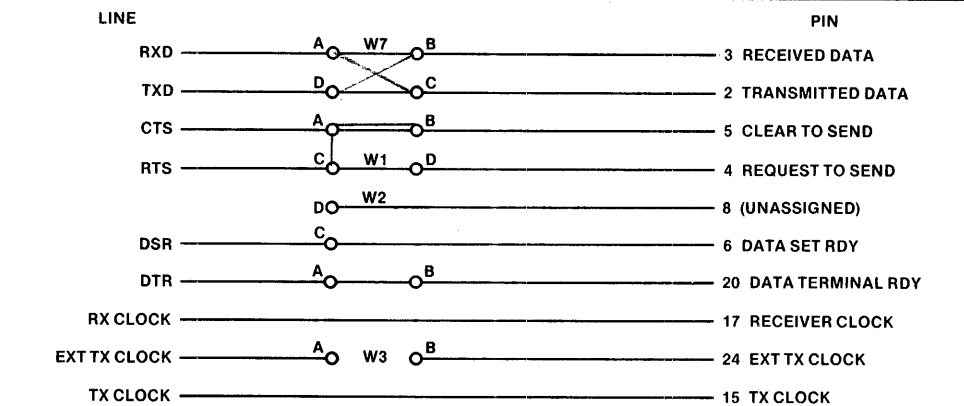

Fig. A-2 Serial 2 Lines and Jumpers

559-11



## APPENDIX B POWER SUPPLY USAGE

The following tables list the power supply capacity of the models 210, 220, 230, and expansion chassis, the power required by the basic system components, and the power available for options.

**Table B-1. Model 210 Power Supply Usage**

	+ 5v	+ 12v	- 12v	- 10v
Capacity	20.0a	1.0a	0.3a	0.8a
IPB usage	4.0a	0.3a	0.1a	0.01a
PIO usage	1.25a	0	0	0
Total	5.25a	0.3a	0.1a	0.01a
Available for options	14.75a	0.7a	0.2a	0.79a

**Table B-2. Model 220 Power Supply Usage**

	+ 5v	+ 12v	- 12v	- 10v	+ 15v	+ 24v
Capacity	30.0a	2.5a	0.5a	1.0a	1.5a	1.7a
IPB usage	4.0a	0.3a	0.1a	0.01a	0	0
IOC usage	2.8a	0.2a	0	0.01a	0	0
CRT usage	0	0	0	0	1.5a	0
Keyboard usage	0.4a	0	0	0	0	0
Drive usage	1.0a	0	0	0	0	1.7a
Total	8.2a	0.5a	0.1a	0.02a	1.5a	1.7a
Available for options	21.8a	2.0a	0.4a	1.98a	0	0

**Table B-3. Model 230 Power Supply Usage**

	+ 5v	+ 12v	- 12v	- 10v	+ 15v	+ 24v
Capacity	30.0a	2.5a	0.5a	1.0a	1.5a	1.7a
IPB usage	4.0a	0.3a	0.1a	0.01a	0	0
IOC usage	2.8	0.2a	0	0.01a	0	0
CRT usage	0	0	0	0	1.5a	0
Keyboard usage	0.4a	0	0	0	0	0
SBC-032 usage	2.0a	0.4a	0	0.05a	0	0
Disk controller usage	5.25a	0	0	0.1a	0	0
Total	14.45a	0.9a	0.1a	0.17a	1.5a	0
Available for options	15.55a	1.6a	0.4a	0.83a	0	1.7a

**Table B-4. Expansion Chassis Power Availability**

	+ 5v	+ 12v	- 12v	- 10v
Available for options	20.0a	1.0a	0.3a	0.8a

The model 220 can support most combinations of options except two In Circuit Emulators or multiple communication controllers.

The model 230 can support most one- and two-board options.

The following table shows which Intellec Series II are used on which models. You may wish to order parts to have on hand should any problems occur.

PART NUMBER	DESCRIPTION	210	220	230	EX.CH	DISK
1001194-01	IPB	1	1	1		
1001214-04	IOC		1	1		
1001166-01	PIO	1				
SCB-032	SBC-032 memory					
1001203-01	auxiliary PROM bd.	1				
1001200-01	front panel	1	1			
1001036-01	diskette controller (interface board)			1		
1000467-01	diskette controller (channel board)			1		
	Monitor ROM	1	1	1		
	Boot ROM	1	1	1		
	IOC ROM		1	1		
4501253	power supply		1	1		
4501268	power supply	1			1	
4501498	power supply					1
4501240	keyboard		1	1		
4501244-01	CRT monitor		1	1		
450963-xx	diskette drive xx = 01 - 115VAC xx = 02 - 220VAC			1		1
74-008	fan - 75cfm		1	1		
74-007	fan - 27cfm	1			1	1
4001516-01	diskette controller cable			1		
4001612-01	power cable	1				
4001614-01	power cable		1	1		
4001615-01	CRT cable		1	1		
4001496-01	signal cable					1
4001612-01	power cable					1
4001236-01	front panel cover		1	1		
4001267-01	front panel cover	1				
4001267-02	front panel cover				1	
3001177-01	snap in cover	1	1	1	1	
4001264-01	expansion cables	1	1	1	1	
80-006	extractor for expansion cables	1	1	1	1	
4001261	keyboard cable		1	1		
4001261-01	keyboard cable		1	1		
4001499-01	peripheral cable			1		
	line filter	1	1	1	1	1
601-f22-64	VSIF connector	1	1	1	1	1
76-002	relay				1	
66-048	power switch	1	1	1		
#327	lamp for power sw.	1	1	1		
68-165	line cord	1	1	1	1	1
70-025	fuse - 3AG F.B. 8a		1	1		

PART NUMBER	DESCRIPTION	210	220	230	EX.CH	DISK
70-023	fuse - 3AG F.B. 4a	1	1	1	1	1
70-026	fuse - 3AG F.B. 2a	1			1	1
56-317	brightness pot		1	1		
66-050	slide switch		1	1		
	led indicator					1
	power switch					1
1001773-01	signal adaptor					1
82-122	spring clip for relay				1	
4001256-01	integral disk signal cable		1			
4001257-01	IOC cable		1	1		
4001262-01	power switch cable	1				
4001515-01	dc power cable	1			1	
4001522-01	integral disk power cable		1			
4001608-01	dc power cable		1	1		



## APPENDIX D MODIFYING THE BAUD RATE

*DOES NOT WORK*

The Serial Channel 1 interface for the TTY is set for a baud rate of 110. The Serial Channel 2 interface for a CRT terminal is set for baud rate of 2400. The baud rate is set when the system is turned on. You can change it by executing a program that contains the following instructions. The values for the variables in the instructions are in the table that follows the code. The code example is written to change the TTY (Serial Channel 1) baud rate. To change the CRT baud rate, change the three occurrences of "OUT 0F5H" to "OUT 0F7H".

```
MVI  A,020H      ;RESET THE 8251 USART
OUT  0F5H
MVI  A,036H      ;LOAD THE 8253 COUNTER 1 FOR
                   ;MODE 3, LSB FOLLOWED BY MSB
OUT  0F3H
LXI  H, <baud code> ;LOAD LEAST SIGNIFICANT BYTE
                   ;OF BAUD COUNT FOR THE 8253
MOV  A,L
OUT  0F0H
MOV  A,H          ;MOST SIGNIFICANT OF BAUD COUNT
OUT  0F0H
MVI  A, <baud multiplier> ;LOAD MULTIPLIER ORED WITH
                   ;USART CONTROLS
OUT  0F5H
MVI  A,025H      ;ENABLE TRANSMITTER, RECEIVER,
                   ;AND REQUEST TO SEND (RTS)
OUT  0F5H
```

**BAUD RATE CODE**

BAUD RATE	BAUD CODE	BAUD MULTIPLIER
110	2BAH	0CEH
150	080H	0CFH
300	040H	0CFH
600	020H	0CFH
1200	010H	0CFH
2400	020H	0CEH
4800	010H	0CEH
9600	008H	0CEH



# APPENDIX E

## TELETYPEWRITER MODIFICATIONS

### E-1. INTRODUCTION

This appendix provides information required to modify a Model ASR-33 Teletypewriter for use with certain Intel SBC 80 computer systems.

### E-2. INTERNAL MODIFICATIONS

#### WARNING

Hazardous voltages are exposed when the top cover of the teletypewriter is removed. To prevent accidental shock, disconnect the teleprinter power cord before proceeding beyond this point.

Remove the top cover and modify the teletypewriter as follows:

- a. Remove blue lead from 750-ohm tap on current source register; reconnect this lead to 1450-ohm tap. (Refer to figures E-1 and E-2.)
- b. On terminal block, change two wires as follows to create an internal full-duplex loop (refer to figures E-1 and E-3):
  1. Remove brown/yellow lead from terminal 3; reconnect this lead to terminal 5.
  2. Remove white/blue lead from terminal 4; reconnect this lead to terminal 5.
- c. On terminal block, remove violet lead from terminal 8; reconnect this lead to terminal 9. This changes the receiver current level from 60 mA to 20 mA.

A relay circuit card must be fabricated and connected to the paper tape reader driver circuit. The relay circuit card to be fabricated requires a relay, a diode, a thyrector, a small 'vector' board for mounting the components, and suitable hardware for mounting the assembled relay card.

A circuit diagram of the relay circuit card is included in figure E-4; this diagram also includes the part numbers of the relay, diode, and thyrector. (Note that a 470-ohm resistor and a 0.1  $\mu$ F capacitor may be

substituted for the thyrector.) After the relay circuit card has been assembled, mount it in position as shown in figure E-5. Secure the card to the base plate using two self-tapping screws. Connect the relay circuit to the distributor trip magnet and mode switch as follows:

- a. Refer to figure E-4 and connect a wire (Wire 'A') from relay circuit card to terminal L2 on mode switch. (See figure E-6.)
- b. Disconnect brown wire shown in figure E-7 from plastic connector. Connect this brown wire to terminal I2 on mode switch. (Brown wire will have to be extended.)
- c. Refer to figure E-4 and connect a wire (Wire 'B') from relay circuit board to terminal L1 on mode switch.

### E-3. EXTERNAL CONNECTIONS

Connect a two-wire receive loop, a two-wire send loop, and a two-wire tape reader control loop to the external device as shown in figure E-4. The external connector pin numbers shown in figure E-4 are for interface with an RS232C device.

### E-4. SBC 530 TTY ADAPTER

The SBC 530, which converts RS232C signal levels to an optically isolated 20 mA current loop interface, provides signal translation for transmitted data, received data, and a paper tape reader relay. The SBC 530 interfaces an Intel SBC 80 computer system to a teletypewriter as shown in figure E-8.

The SBC 530 requires +12V at 98 mA and -12V at 98 mA. An auxiliary supply must be used if the SBC 80 system does not supply this power. A schematic diagram of the SBC 530 is supplied with the unit. The following auxiliary power connector (or equivalent) must be procured by the user:

Connector, Molex 09-50-7071  
Pins, Molex 08-50-0106  
Polarizing Key, Molex 15-04-0219



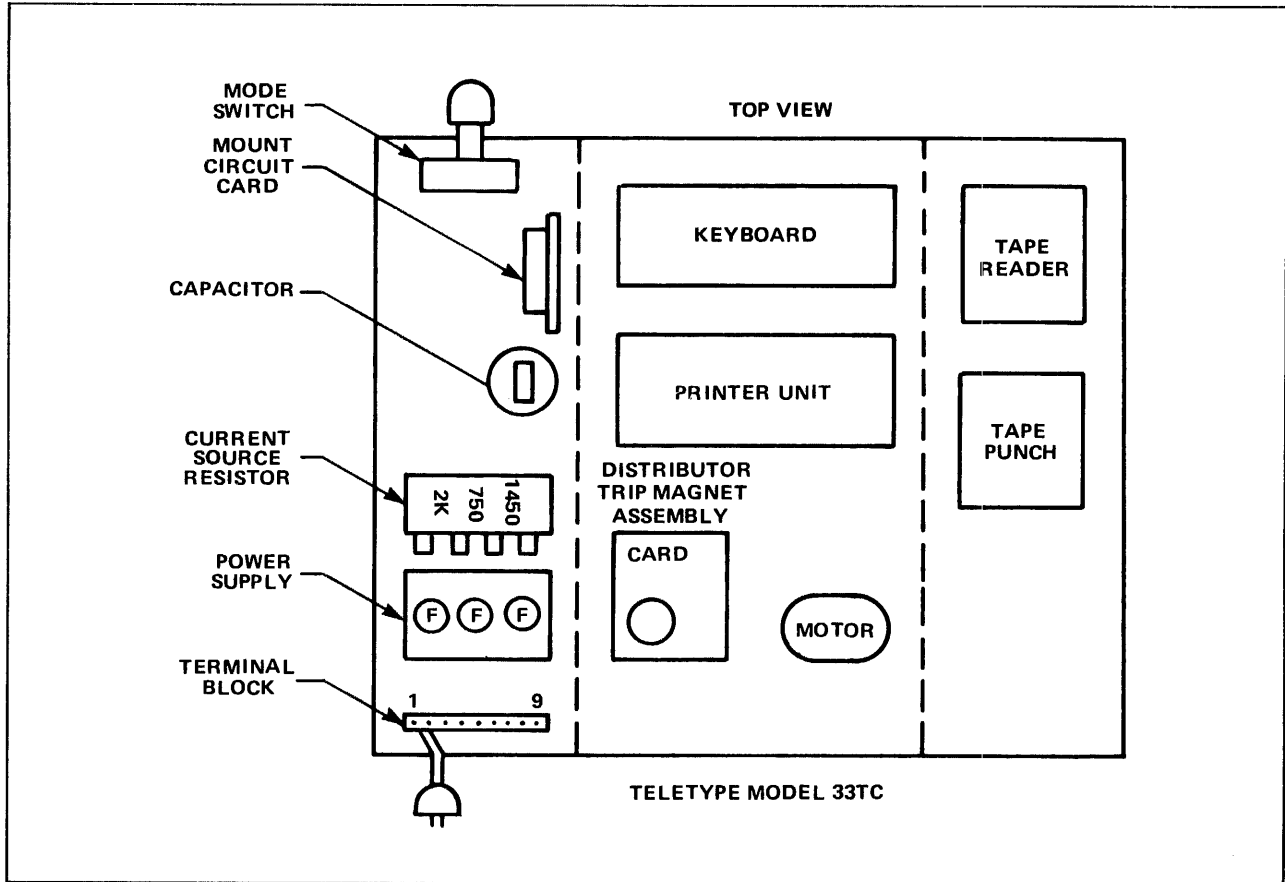

Figure E-1. Teletype Component Layout

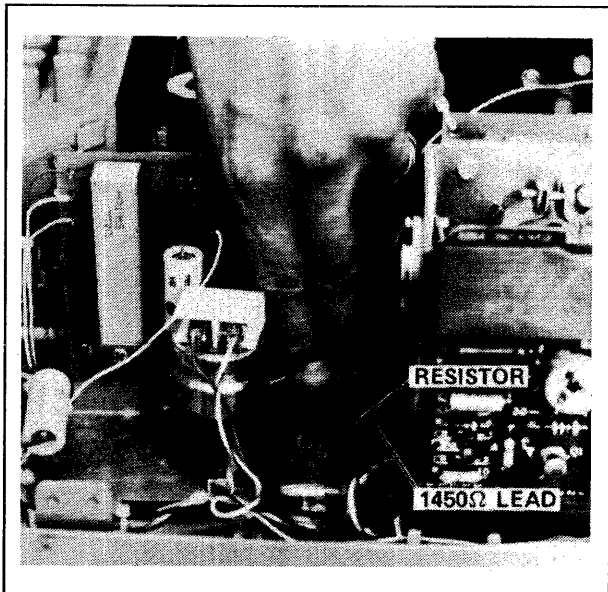

Figure E-2. Current Source Resistor

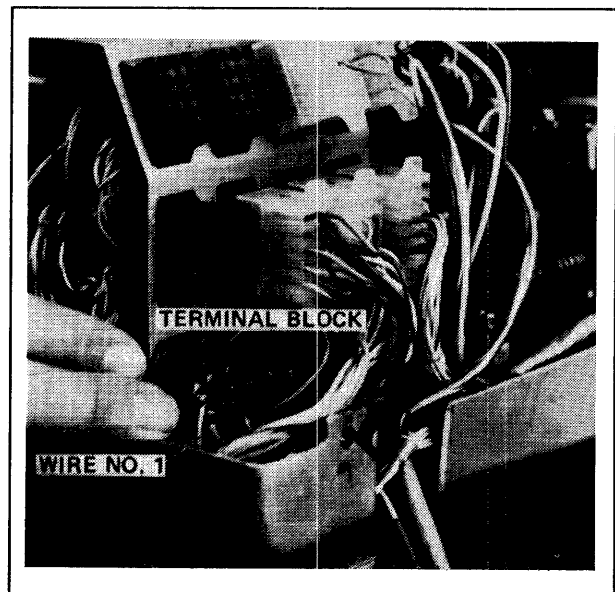

Figure E-3. Terminal Block

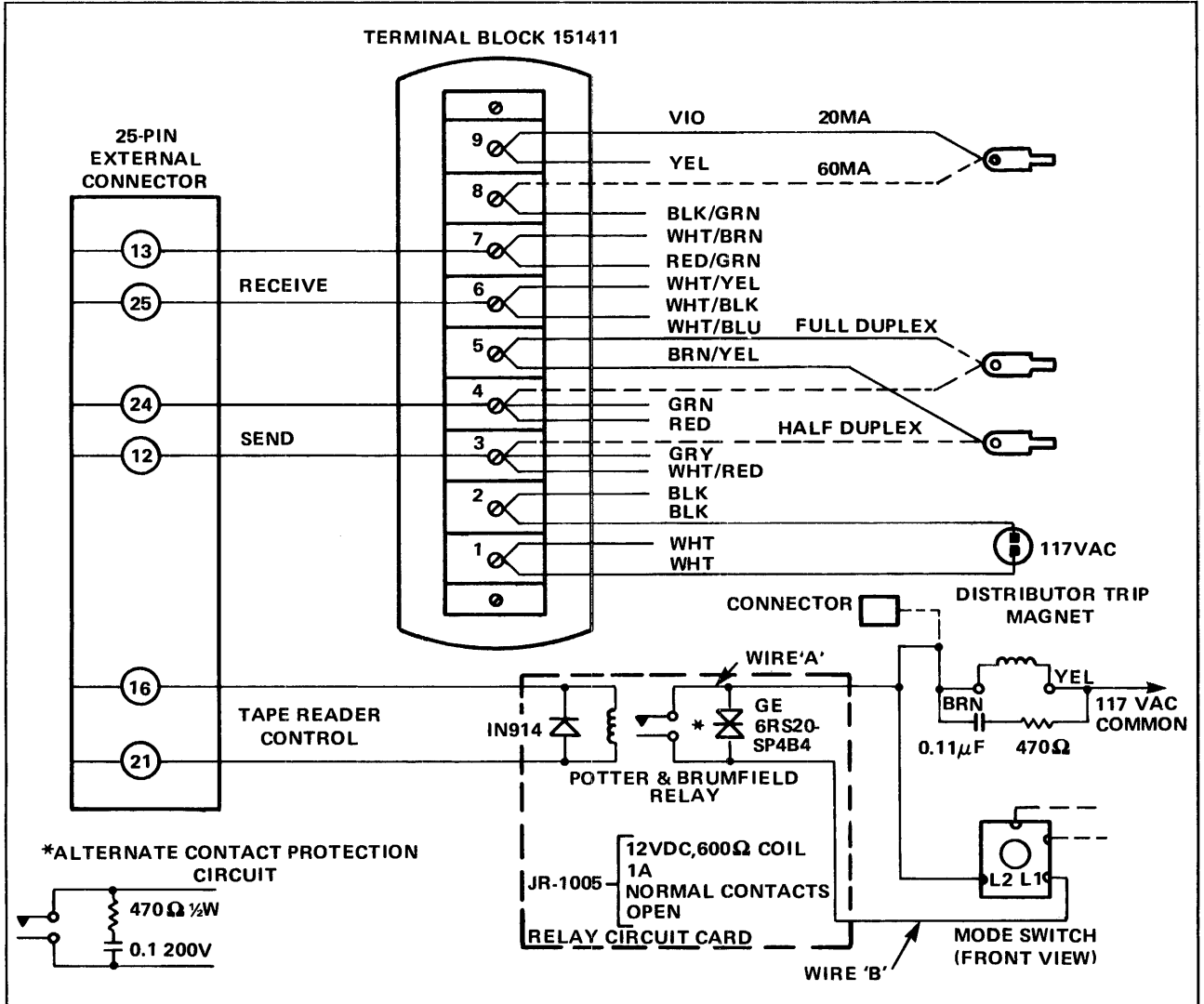

Figure E-4. Teletypewriter Modifications

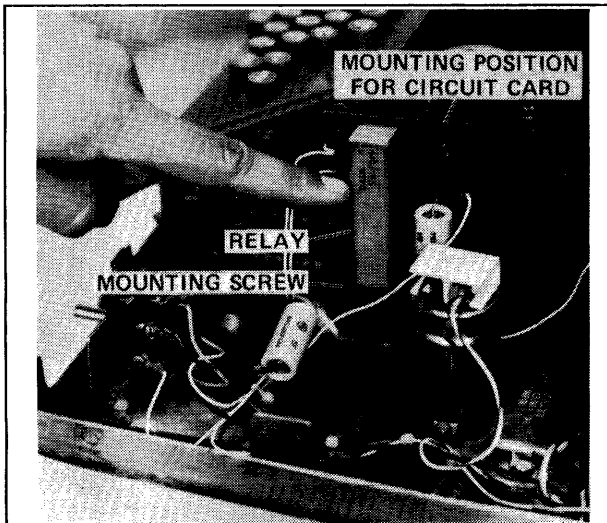

Figure E-5. Relay Circuit

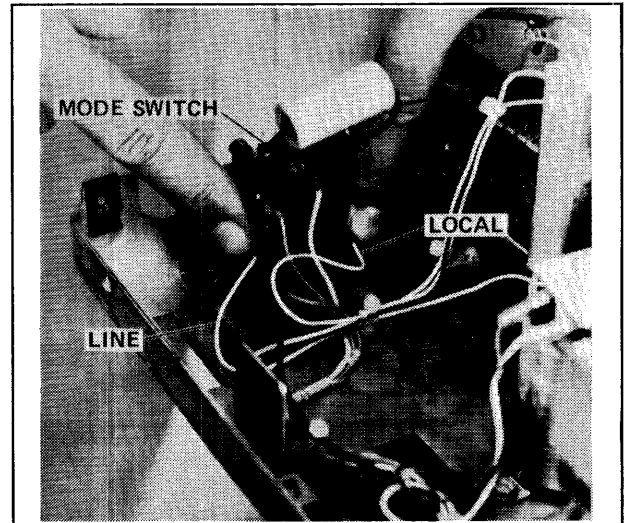

Figure E-6. Mode Switch

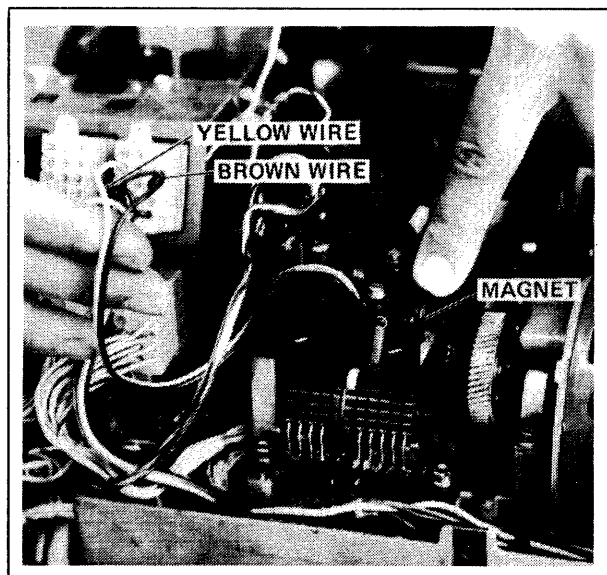

Figure E-7. Distributor Trip Magnet

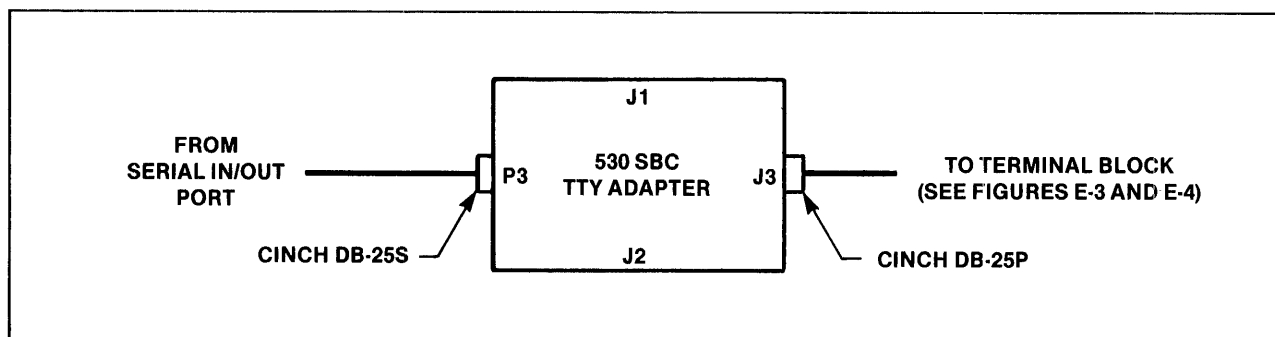

Figure E-8. TTY Adapter Cabling

- aborting a test 3-7, 3-11
- acknowledge select jumper 4-3
- adding
  - diskette controllers 4-4
  - In-Circuit Emulators 4-16
  - Multibus modules 4-16
  - peripheral devices 4-15
  - RAM, 16K 4-3
  - RAM, 32K 4-1
- address selection, memory board 4-2, 4-3
- adjusting voltages 3-2, 3-3
- assembly
  - model 210 2-3
  - model 220 2-5
  - model 230 2-5
- attaching a terminal 2-4
- available power
  - expansion chassis B-2
  - model 210 B-1
  - model 220 B-1
  - model 230 B-1
- brightness control 2-7
- cable port 4-14
- card slots, spare 1-1, 1-2, 1-3
- care of diskettes 1-4
- checkout
  - diskette drives 4-7, 4-14
  - expansion chassis 4-15
  - memory 4-2, 4-3
  - model 210 2-6
  - model 220 2-6
  - model 230 2-6
  - RAM 4-2, 4-3
- commands
  - diagnostic 3-4, 3-6
  - execute 2-8
  - G 2-8
  - R 2-7
  - read 2-7
  - Z\$ 3-4
- confidence test
  - description 3-7 thru 3-13
  - messages 3-7 thru 3-13
- consumption, power 3-1
- contrast control 2-7
- converting a 210 4-17
- cord, power 2-4, 2-5
- CRT
  - controls 2-7
  - test, confidence test 3-8
  - test, IOC diagnostics 3-6
- cursor 2-6
- damage procedure 2-1
- description
  - model 210 1-1
  - model 220 1-2
  - model 230 1-3
- diagnostic
  - command 3-4, 3-6
  - initiation
    - confidence test 3-7
    - IOC test 3-5
    - IPB test 3-4
- diagnostics
  - IOC 3-5
  - IPB 3-4
- disk test, IOC diagnostics 3-6
- diskette controller, installation 4-4
- diskette test aborting 3-11
- diskette test, confidence test 3-10
- diskette-based diagnostics 3-7
- diskettes, care of 1-4
- enhancement package installation 4-17
- error messages, IPB diagnostics 3-4
- execute command 2-8
- execution of IOC diagnostics 3-5
- execution of IPB diagnostics 3-4
- execution of confidence test 3-7
- expansion chassis 4-14
- fuse rating
  - model 210 2-4
  - model 220 2-6
  - model 230 2-6
- G command 2-8
- general description
  - model 210 1-1
  - model 220 1-2
  - model 230 1-3
- general test, IOC diagnostics 3-6
- high speed punch test 3-12
- high speed reader test 3-12
- In-Circuit Emulators 4-16
- inspection 2-1
- installation
  - model 210 2-3
  - model 220 2-5
  - model 230 2-5
- installation, enhancement package 4-17
- installing
  - model 210 2-3
  - model 220 2-5
  - model 230 2-5
- installing an expansion chassis 4-14
- installing enhancement package 4-17
- interrupt switches 1-1, 1-2, 1-3
- Introduction 1-1
- inventory 2-1
- inventory checklist 2-1
- I/O configuration, serial A-1
- IOC diagnostics 3-5
- IPB diagnostics 3-4

- IPB error messages 3-4
- keyboard
  - cable connections 2-5
  - installation 2-5
  - test, confidence test 3-8
- keyboard/CRT test, IOC diagnostics 3-6
- line printer test, confidence test 3-11
- SBC-016 4-3
- memory board jumpers
  - SBC-016 4-2
  - SBC-032 4-3
- memory capacity
  - model 210 1-1
  - model 220 1-2
  - model 230 1-3
- memory test 3-8, 3-4
- memory test, confidence test 3-8
  - model 210 1-1
  - model 220 1-2
  - model 230 1-3
- module select jumper 4-3
- monitor 2-6
- Multibus modules 4-16
- no power 3-1
- on-off switch 1-1, 1-2, 1-3
- paper tape punch, installing 4-15
- paper tape reader, installing 4-15
- paper tape-based diagnostics 3-7
- part numbers C-1
- parts list C-1
- peripheral devices, installing 4-15
- port, cable 4-14
- power available
  - expansion chassis B-2
    - model 210 B-1
    - model 220 B-1
    - model 230 B-1
- power consumption
  - expansion chassis B-2
    - model 210 B-1
    - model 220 B-1
    - model 230 B-1
- power cord 2-4, 2-5
- power socket 2-4 2-5
- power supply usage
  - model 210 B-1
  - model 220 B-1
  - model 230 B-1
- power switch 1-1, 1-2, 1-3
- procedure, checkout 2-6
- processor test, confidence test 3-8
- PROM programmer, installing 4-15
- punch test, confidence test 3-12
- punch, installing 4-15
- R command 2-7
- RAM test 4-2, 4-3
- read command 2-7
- reader test, confidence test 3-12
- reader, installing 4-15
- ROM-based diagnostics 3-3
- ROM-based monitor 2-6
- run light 2-6
- SBC-032 4-1
- safety 1-4
- serial I/O configuration A-1
- service 3-1
- service policy and procedure 3-1
- spare card slots 1-1, 1-2, 1-3
- spare parts list C-1
- tape punch, installing 4-15
- tape reader, installing 4-15
- teletypewriter test, confidence test 3-9
- teletypewriter, installing 2-4
- terminal, attaching 2-4
- test initiation 3-4, 3-5
- test, aborting 3-7, 3-11
- testing
  - memory 3-4, 3-8
  - the line printer 3-11
  - the CRT 3-6, 3-8
  - the IOC 3-7
  - the IPB 3-4
  - the PIO 3-5
  - the TTY 3-9
  - the external disk drives 3-10
  - the integral disk drive 3-6
  - the keyboard 3-6
  - the punch 3-12
  - RAM 3-4, 3-8
  - the reader 3-12
- timing selection, memory board 4-2
- troubleshooting 3-1
- TTY test, confidence test 3-9
- TTY, installing 2-4
- universal PROM programmer, installing 4-15
- unpacking 2-1
- upgrade and enhancement 4-1
- upgrading 4-1
- UPP, installing 4-15
- voltage adjustments
  - model 210 3-2
  - model 220 3-2
  - model 230 3-2
- voltage control, input 2-3, 2-6
- Z\$ command 3-4



### REQUEST FOR READER'S COMMENTS

The Microcomputer Division Technical Publications Department attempts to provide documents that meet the needs of all Intel product users. This form lets you participate directly in the documentation process.

Please restrict your comments to the usability, accuracy, readability, organization, and completeness of this document.

1. Please specify by page any errors you found in this manual.

---

---

---

---

---

---

2. Does the document cover the information you expected or required? Please make suggestions for improvement.

---

---

---

---

---

---

3. Is this the right type of document for your needs? Is it at the right level? What other types of documents are needed?

---

---

---

---

---

---

4. Did you have any difficulty understanding descriptions or wording? Where?

---

---

---

---

---

---

5. Please rate this document on a scale of 1 to 10 with 10 being the best rating. \_\_\_\_\_

NAME \_\_\_\_\_ DATE \_\_\_\_\_

TITLE \_\_\_\_\_

COMPANY NAME/DEPARTMENT \_\_\_\_\_

ADDRESS \_\_\_\_\_

CITY \_\_\_\_\_ STATE \_\_\_\_\_ ZIP CODE \_\_\_\_\_

Please check here if you require a written reply.





INTEL CORPORATION, 3065 Bowers Avenue, Santa Clara, California 95051 (408) 987-8080

Printed in U.S.A./B-6/278/15K CP



## Free Manuals Download Website

<http://myh66.com>

<http://usermanuals.us>

<http://www.somanuals.com>

<http://www.4manuals.cc>

<http://www.manual-lib.com>

<http://www.404manual.com>

<http://www.luxmanual.com>

<http://aubethermostatmanual.com>

Golf course search by state

<http://golfingnear.com>

Email search by domain

<http://emailbydomain.com>

Auto manuals search

<http://auto.somanuals.com>

TV manuals search

<http://tv.somanuals.com>