

FS-979

Full-size PICMG CPU Card

User's Manual

Edition: 1.0

2004/8/30



Copyright

Copyright 2003 - 2004. All rights reserved. This document is copyrighted and all rights are reserved. The information in this document is subject to change without prior notice to make improvements to the products.

This document contains proprietary information and protected by copyright. No part of this document may be reproduced, copied, or translated in any form or any means without prior written permission of the manufacturer.

All trademarks and/or registered trademarks contains in this document are property of their respective owners.

Disclaimer

The company shall not be liable for any incidental or consequential damages resulting from the performance or use of this product.

The company does not issue a warranty of any kind, express or implied, including without limitation implied warranties of merchantability or fitness for a particular purpose.

The company has the right to revise the manual or include changes in the specifications of the product described within it at any time without notice and without obligation to notify any person of such revision or changes.

Trademark

All trademarks are the property of their respective holders.

Any questions please visit our website at <http://www.annso.com>

Packing List:

Please check the packing list before you start to apply this production.

Hardware:

FS-979 Full-size PICMG CPU Card x 1

Cable Kit:

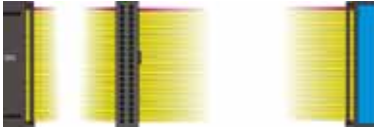

40-pin ATA100 IDE flat cable x 1



Floppy flat cable x 1

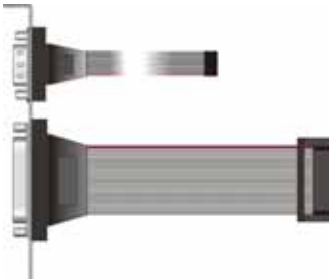

DB25 & DB9 cable with bracket x 1
(FS-979VDL & FS-979VDG only)

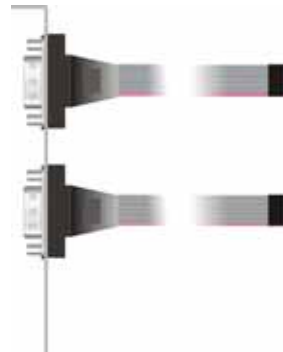

Dual DB9 cable with bracket x 1
(FS-979VDG2 & FS-979VDG3 only)

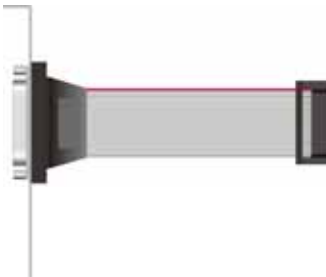

DB25 cable with bracket x 1
(FS-979VDG2 & FS-979VDG3 only)

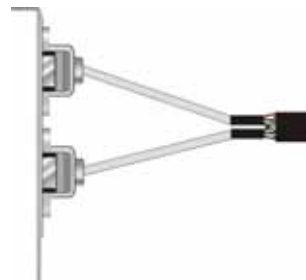

Dual USB cable with bracket x 2



Serial ATA ribbon cable x 2



Audio cable with bracket x 1

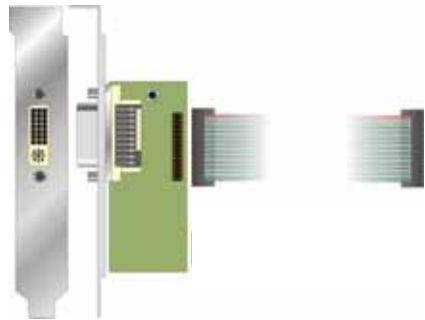

DVI module with bracket x 1



4-pin to 3-pin ATX cable x 1



PS/2 Keyboard & Mouse Cable x 1

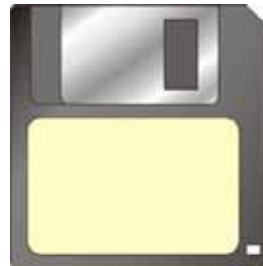

RAID drivers Disc for Windows 2000,
Windows XP and Windows Server 2003



VGA cable x 1 (FS-979VDG3 only)

CD Content:

Divers

User's Manual

Index

Chapter 1 <Introduction>	7
1.1 <Product Overview>.....	7
1.2 <Product Specification>	8
1.3 <Component Placement>	10
1.4 <Block Diagram>.....	11
Chapter 2 <Hardware Setup>	13
2.1 <Connector Location>.....	13
2.2 <Connector Reference>.....	14
2.2.1 <Internal Connector>.....	14
2.2.2 <External Connector>.....	14
2.3 <Jumper Reference>	15
2.4 <CPU and Memory installation>	16
2.4.1 <CPU Installation>.....	16
2.4.2 <Memory Installation>	17
2.5 <CMOS Setup>	18
2.6 <Enhanced IDE Interface>.....	19
2.7 <Serial ATA interface>	20
2.8 <LAN Interface>	21
2.9 <Audio Interface>	22
2.10 <Display Interface>	23
2.11 <Compact Flash Interface>	25
2.12 <USB2.0 Interface>.....	26
2.13 <Power and Fan Installation>	27
2.13.1 <Power connectors>.....	27
2.13.2 <Fan Connectors>.....	28
2.14 <Serial Port Configuration>.....	29
2.15 <GPIO Interface>	30
2.16 <Switch and Indicator>.....	31

Chapter 3 <System Configuration>	33
3.1 <SATA Configuration>	33
3.2 <SATA RAID Configuration>	36
3.3 <Video Memory Setup>	39
3.4 <Display Properties Setting>.....	41
Chapter 4 <BIOS Setup>	43
Appendix A <I/O Port Pin Assignment>	45
A.1 IDE Port	45
A.2 <Serial ATA Port>	45
A.3 < Floppy Port >	46
A.4 <IrDA Port>	46
A.5 < Parallel Port>	47
A.6 <Serial Port>	47
A.6.1 <External DB9 serial port>	47
A.6.2 <Internal serial port>	47
A.7 <VGA Port>.....	48
A.8 <LAN Port>	48
A.8.1 < Fast Ethernet>	48
A.8.2 <Gigabit Ethernet >	48
A.9 <AT Keyboard Port>	49
A.10 <PS/2 Keyboard & Mouse Port>.....	49
Appendix B <Flash BIOS>	51
B.1 BIOS Auto Flash Tool	51
B.2 Flash Method.....	51

Chapter 1 <Introduction>

1.1 <Product Overview>

FS-979 is the Full-size single board computer with last Intel desktop technology with PICMG form factor. Based on Intel® 915GV and ICH6R, the board integrates a new Pentium 4 processor 775-pin socket, DDR2 memory socket, and Intel® Graphic Media Accelerator 900 technology, LAN, AC97 audio, USB2.0 and Serial ATA with RAID function for a powerful rack-mount/wall-mount system.

Intel® LGA775 processor

The Intel® Pentium 4 processor now comes with a new form factor with 775-pin PLGA package, for 800MHz front-side-bus, 1MB L2 cache, and for 90nm manufacturing technology, the PLGA processor without pin header on solder side can make user installing the processor on the socket easier.

Intel® 915GV and ICH6R chipset

The Intel® 915GV integrates DDR2 400/533MHz for memory, and Graphic Media Accelerator (GMA) 900 technology for new graphic engine. It can provide up to 224MB of frame buffer when you install over 256MB of system memory. The ICH6R integrates with up to 8 USB2.0 interfaces (4 ports for **FS-979**), and serial ATA interface with RAID function.

Dual Display Supported

Based on Intel® 915G GMA900 technology, the board supports dual display function with CRT and DVI display interfaces. You can take this advantage for gaming, security monitoring or other demonstration applications.

Multimedia interfaces

FS-979 also integrates AC97 audio, Compact Flash and DVI interface, for these flexible functions, system integrator can built more powerful systems for many field applications.

Max up to 3 Gigabit Intel® LAN

With up to 3 PCI-Express 1x with Intel Gigabit LAN controllers, the board comes with the powerful network function for Server or Workstation.

1.2 <Product Specification>

General Specification

Form Factor	Full-size PICMG Single Board Computer
CPU	Intel® Pentium 4 processor with LGA775 socket Package type: 775 pin PLGA L2 Cache: 1MB / Front side bus: 800MHz (200MHz x 4) Intel® Hyper-Threading Technology supported
Memory	4 x 240-pin DDR2 400/533MHz SDRAM Maximum DRAM address decode space is 4GB. Up to 8GB/s of bandwidth with dual-channel interleaved mode Dual-Channel technology supported Unbuffered, none-ECC memory supported only
Chipset	Intel® 915GV (Northbridge) and ICH6R (Southbridge)
BIOS	Phoenix-Award v6.00PG 4Mb PnP flash BIOS
Green Function	Power saving mode includes doze, standby and suspend modes. ACPI version 1.0 and APM version 1.2 compliant
Watchdog Timer	System reset programmable watchdog timer with 1 ~ 255 sec./min. of timeout value
Real Time Clock	Intel® ICH6R built-in RTC with lithium battery
Enhanced IDE	Enhanced IDE interface supports dual channels and up to 2 ATAPI devices at Ultra DMA100 One 40-pin IDE port onboard
Serial ATA	Intel® ICH6R integrates 4 Serial ATA interface RAID 0, 1, Intel Matrix Storage Technology supported

Multi-I/O Port

Chipset	Intel® 82801FR ICH6R with Winbond® W83627THF controller
Serial Port	One RS232 and one jumper selectable RS232/422/485
USB Port	4 x Hi-Speed USB 2.0 ports with 480Mbps of transfer rate
Parallel Port	One internal bi-direction parallel port with SPP/ECP/EPP mode
Floppy Port	One internal Floppy port
IrDA Port	One IrDA compliant Infrared interface supports SIR
K/B & Mouse	External PS/2 keyboard and mouse ports on rear I/O panel
GPIO	One 12-pin Digital I/O connector with 8-bit programmable
Smart Fan	One CPU fan connectors for fan speed controllable

VGA Display Interface

Chipset	Intel® 915GV GMCH (Graphic Memory Controller Hub)
Core Frequency	333MHz
Memory	Intel® DVMT 3.0 with up to 224MB shared with system memory
Display Type	CRT, LCD monitor with DB15 or DVI interface
Connector	External DB15 female connector on rear I/O panel Internal header connector for DVI interface

Ethernet Interface

Chipset	Intel® PRO/100 LAN interface with 82562EZ PHY Or Intel® PRO/1000 LAN interface with 82570EI controller	
Type	82562EZ	10Base-T / 100Base-TX auto-switching Fast Ethernet Full duplex, IEEE802.3U compliant
	82570EI	10Base-T / 100Base-TX/1000Base-T auto-switching Gigabit Ethernet Full duplex, IEEE802.3U compliant
Connector	External RJ45 connectors with LED on rear I/O panel	

Solid State Disk Interface

Flash Type	Compact Flash Type-I/II for Compact Flash Card or Micro Drive
Capacity	Up to 1GB flash memory

ISA Interface

ISA Bridge	Winbond W83628F & W83629D
Function	I/O & IRQ supported only, no support DMA & bus mastering

Audio Interface

Chipset	Intel® ICH6R with Realtek® ALC201A AC97 3D audio codec
Interface	2 channel 3D audio with Line-in, Line-out and MIC-in
Connector	Internal header for Line-out, Line-in and MIC-in Internal CD audio connector

Power and Environment

Power Requirement	Standard AT 4-pin power supply Additional +12V 4-pin power connector 3-pin ATX function connector
Dimension	338 (L) x 122 (H) mm
Temperature	Operating within 0 ~ 60°C (32 ~ 140°F) Storage within -20 ~ 85°C (-4 ~ 185°F)

Ordering Code

FS-979VDL	Full-size Intel® Pentium 4 PICMG single board computer with LGA775, DDR2, AC97 Audio, CF, USB2.0, DVI, 10/100Mbps LAN
------------------	---

The specifications may be different as the actual board.

For further product information please visit the website at <http://www.annso.com>

1.3 <Component Placement>

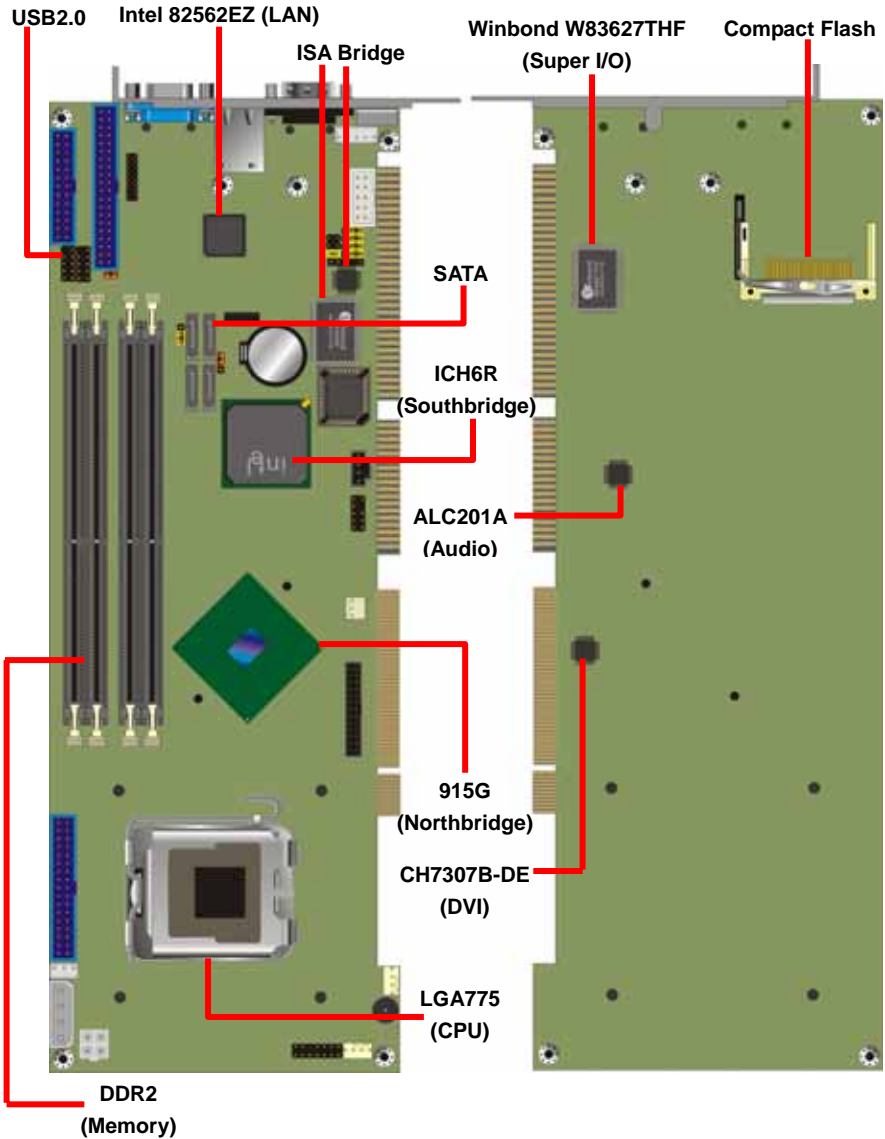

1.4 <Block Diagram>

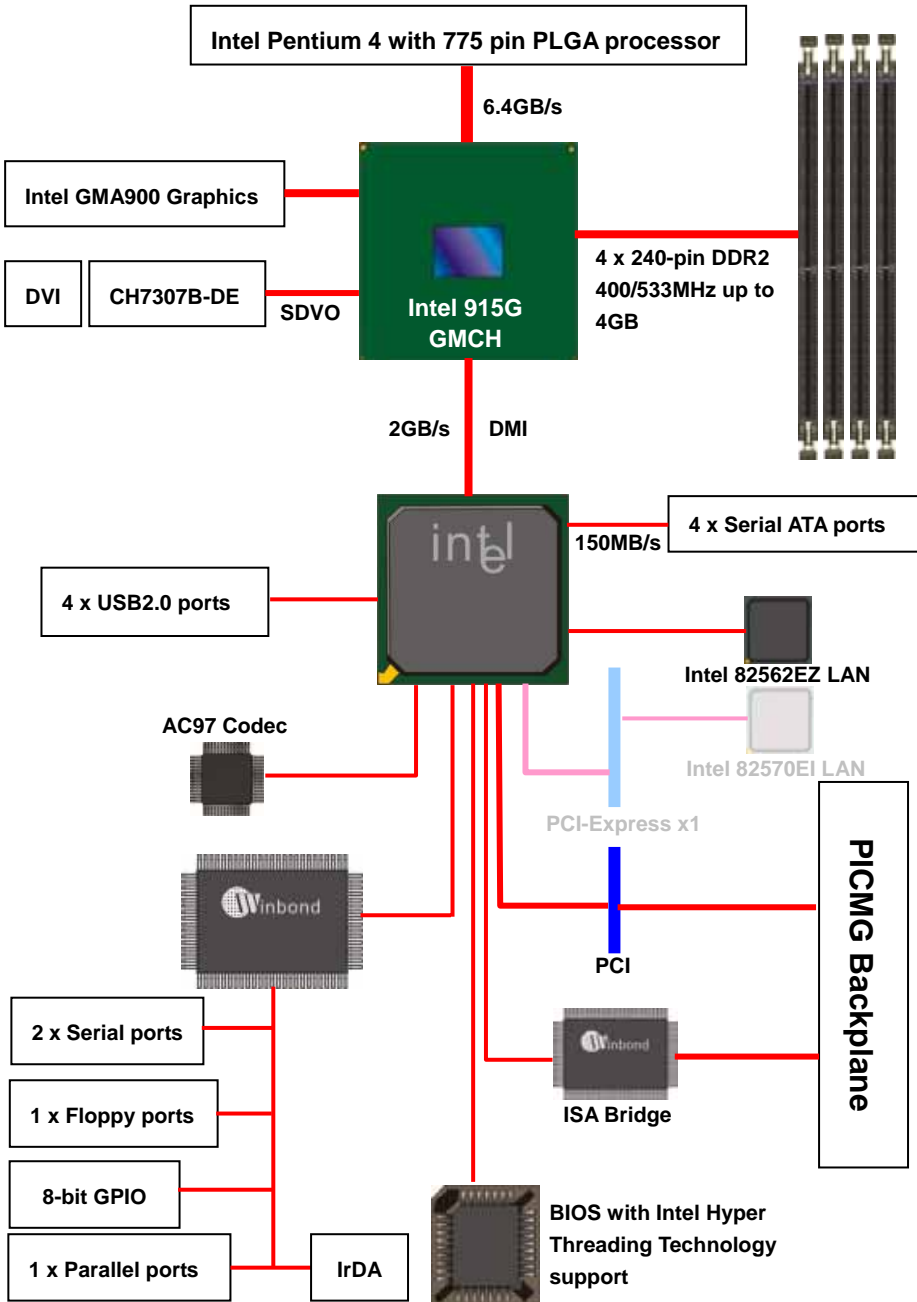

(This Page is Left for Blank)

Chapter 2 <Hardware Setup>

2.1 <Connector Location>

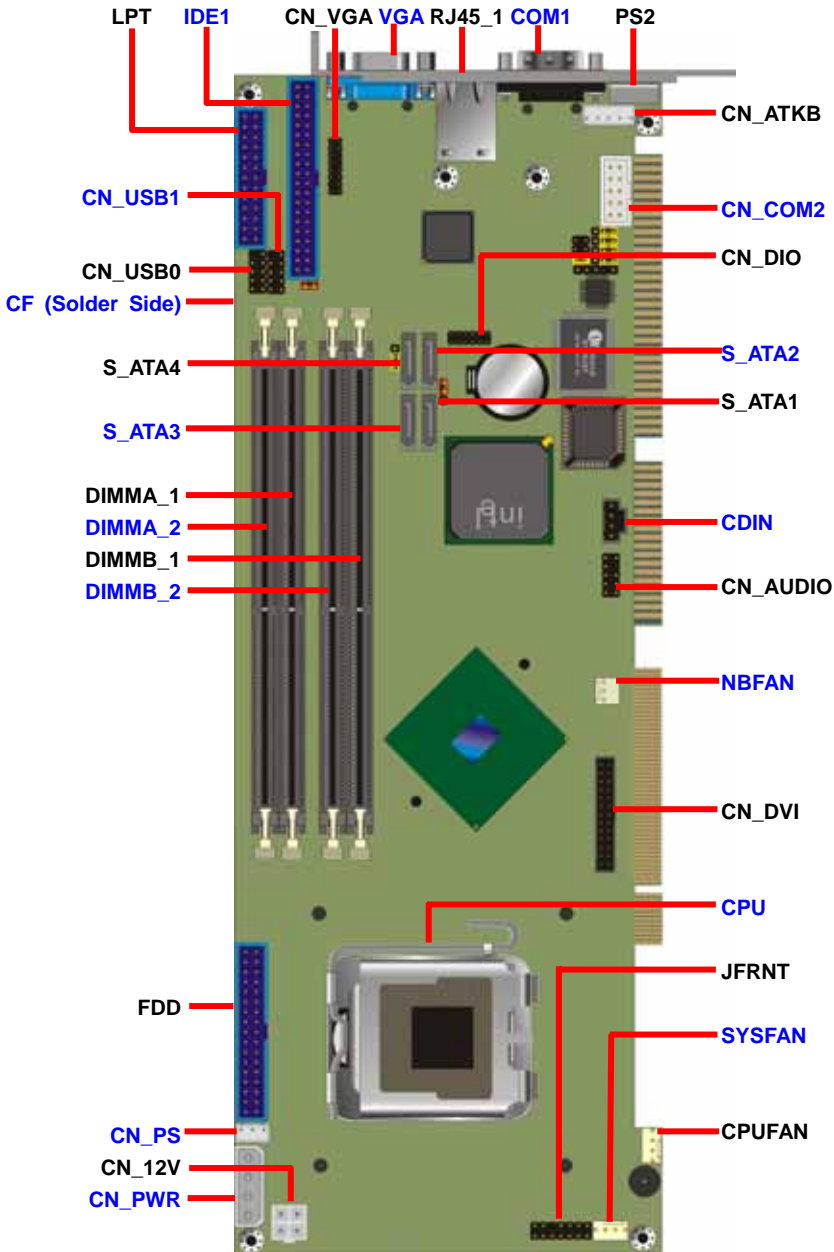

2.2 <Connector Reference>

2.2.1 <Internal Connector>

Connector	Function	Remark
CPU	LGA775 CPU socket	Standard
DIMMA_1/2	240 –pin DDR2 SDRAM DIMM socket	Standard
DIMMB_1/2	240 –pin DDR2 SDRAM DIMM socket	Standard
IDE1	40-pin primary IDE connector	Standard
FDD	26-pin slim type floppy connector	Standard
S_ATA1/2/3/4	7-pin Serial ATA connector	Standard
CN_PWR	4-pin AT power supply connector	Standard
CN_12V	4-pin +12V additional power supply connector	Standard
CN_PS	3-pin ATX function connector	Standard
CN_AUDIO	5 x 2-pin audio connector	Standard
CDIN	4-pin CD-ROM audio input connector	Standard
CN_DIO	6 x 2-pin digital I/O connector	Standard
CN_USB0	10-pin USB 1/2 connector	Standard
CN_USB1	10-pin USB 3/4 connector	Standard
NBFAN	3-pin Northbridge chip fan connector	Standard
CPUFAN	4-pin CPU fan connector	Standard
SYSFAN	4-pin system fan connector	Standard
CN_IR	5-pin IrDA connector	Standard
CN_ATKB	5-pin AT keyboard connector	Standard
CN_DVI	26-pin TMDS connector	Standard
JFRNT	14-pin front panel switch/indicator connector	Standard
CF	Compact Flash TYPE-II socket	Standard
CN_COM2	10-pin serial port connector	Standard
CN_COM1	10-pin serial port connector	VDG2/VDG3

2.2.2 <External Connector>

Connector	Function	Remark
VGA	DB15 VGA connector	VDL/VDG/VDG2
RJ45_1	RJ45 LAN connector	Standard
COM1	Serial port connector	DVL only
PS2	PS/2 Keyboard/Mouse connector	Standard
RJ45_2	RJ45 LAN connector	VDG2 only
RJ45_3	RJ45 LAN connector	VDG3 only

2.3 <Jumper Reference>

Jumper	Function
JRTC	CMOS Operating/Clear Setting
JDOM	IDE1 Pin-20 voltage setting
JCFSEL	Compact Flash address setting
JCSEL1	COM2 communication mode setting
JCSEL2	COM2 communication mode setting

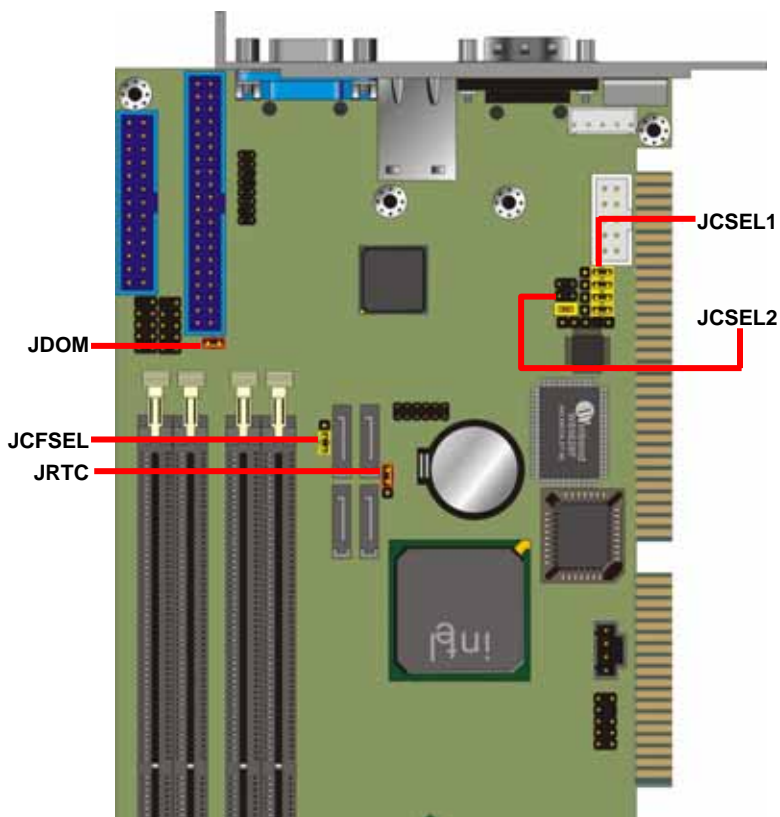

2.4 <CPU and Memory installation>

2.4.1 <CPU Installation>

FS-979 has a LGA755 CPU socket onboard; please check following steps to install the processor properly.

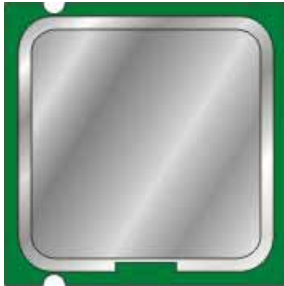

Intel® Pentium 4 processor
 Package type: 775 pin PLGA
 L2 Cache: 1MB
 FSB: 800MHz (200MHz x 4)
 Manufacturing: 90nm
 Intel Hyper Threading
 Technology supported

1. Lift this bar

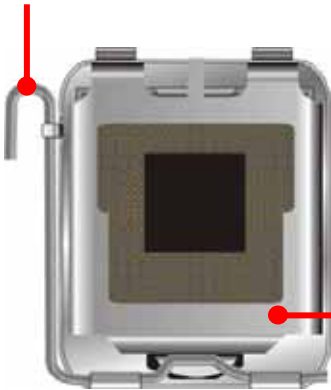

2. Uncover this plate



Check point

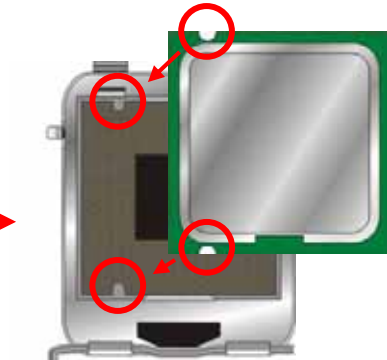

3. Place the CPU on the top of the pins



4. Lock this bar

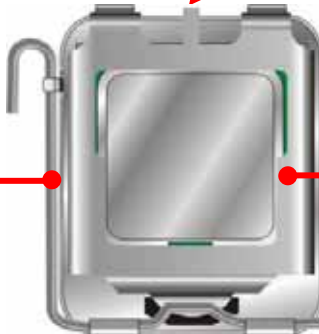

3. Cover this plate

Notice: Please place the CPU on the pins tenderly to avoid bending the pins

2.4.2 <Memory Installation>

FS-979 has four 240-pin DDR2 DIMM support up to 4GB of memory capacity. The memory frequency supports 400/533MHz (100MHz x 4 or 133MHz x 4). Only Non-ECC memory is supported. **Dual-Channel technology** is supported while applying two same modules.

Notice: When applying 4GB of memory, due to the memory resource issue, the available memory size would be less than 4GB.

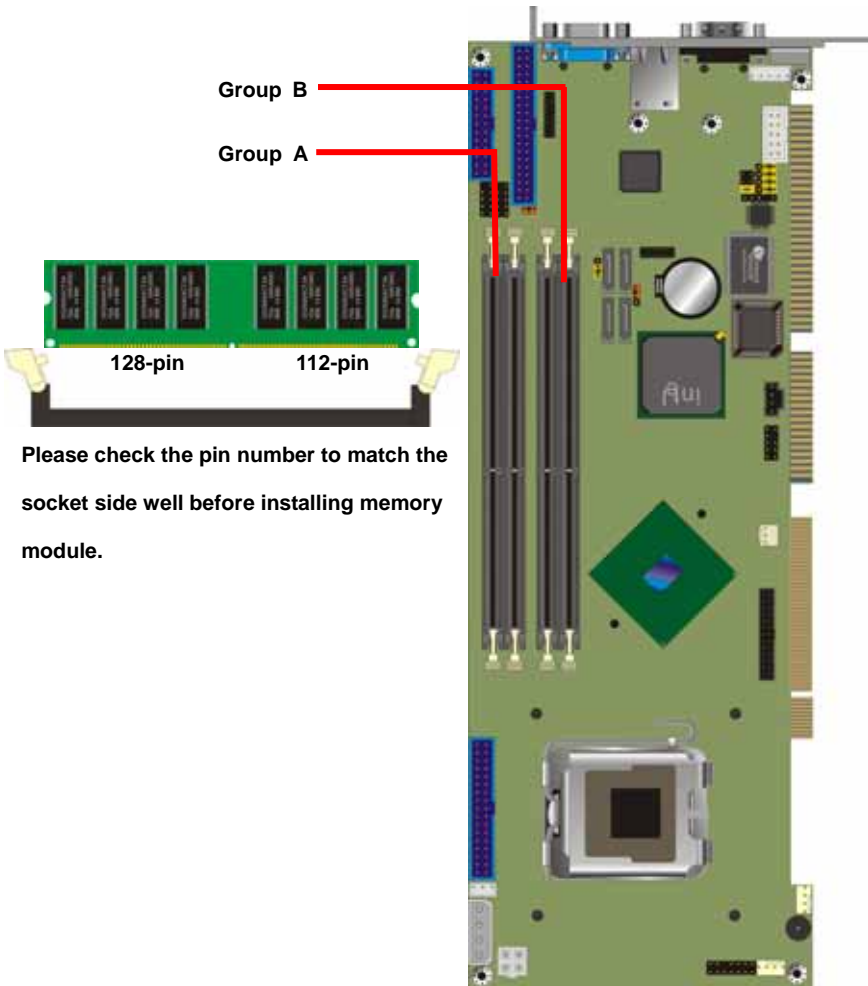

2.5 <CMOS Setup>

The board's data of CMOS can be setting in BIOS. If the board refuses to boot due to inappropriate CMOS settings, here is how to proceed to clear (reset) the CMOS to its default values.

Jumper: JRTC

Type: Onboard 3-pin jumper

JRTC	Mode
1-2	Clear CMOS
2-3	Normal Operation

Default setting

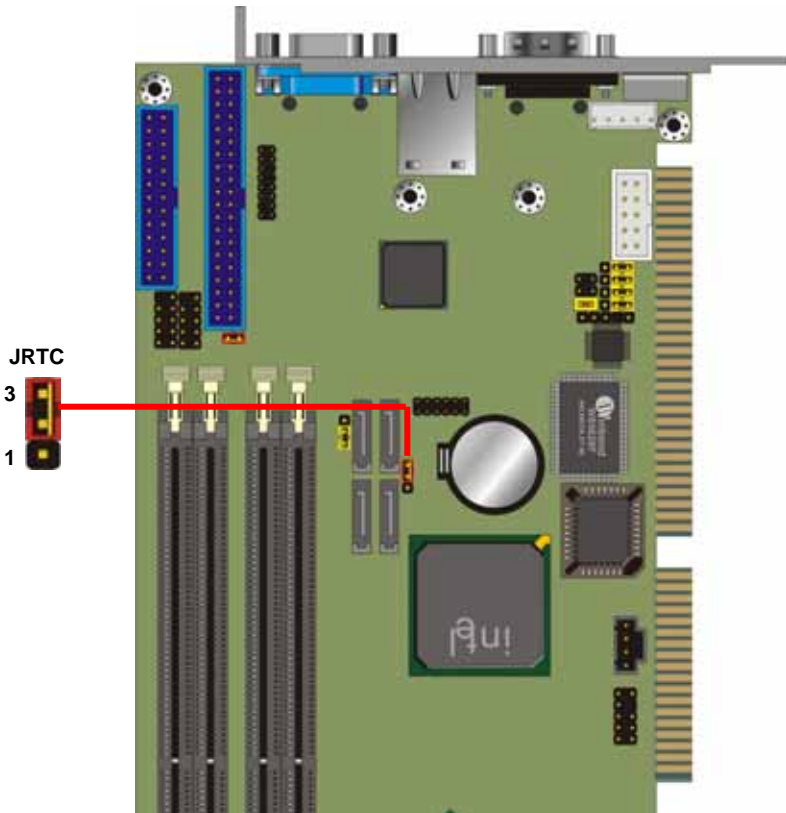

2.6 <Enhanced IDE Interface>

The Intel® ICH6R (south bridge chip) supports one enhanced IDE interface, dual channel for two ATAPI devices with ATA100. Based on this function, **FS-979** has one 40-pin IDE connector with jumper selectable for pin-20 +5V supported. The jumper **JDOM** is two-pin type for pin-20 supplied with +5V to apply the DOM (Disk on Module).

Jumper: **JDOM**

Type: onboard 3-pin header

JDOM	Mode
ON	IDE1 pin-20 5V power supply enable
OFF	No 5V power supply on IDE1 pin-20

Default setting

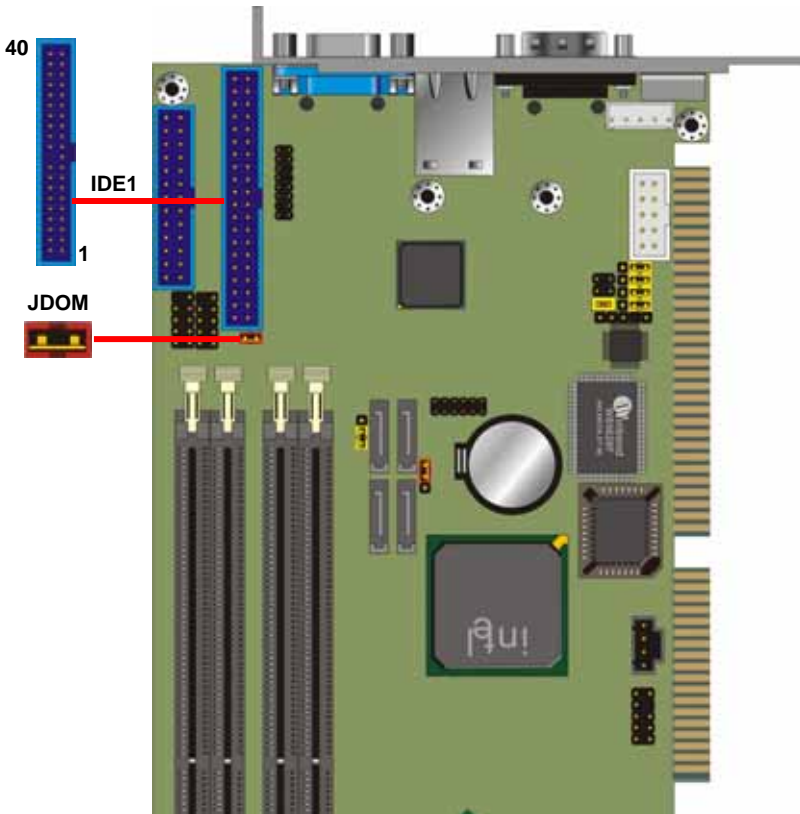

2.7 <Serial ATA interface>

FS-979 has four Serial ATA interfaces with RAID function, the transfer rate of the Serial ATA can be up to 150MB/s. Please go to <http://www.serialata.org/> for more about Serial ATA technology information. Based on Intel® ICH6R, it supports **Intel® Matrix Storage Technology** with combination of RAID 0 and RAID 1 modes. The main features of RAID on ICH6R are listed below:

1. Supports for up to RAID volumes on a single, two-hard drive RAID array.
2. Supports for two, two-hard drive RAID arrays on any of four Serial ATA ports.
3. Supports for Serial ATA ATAPI devices.
4. Supports for RAID spares and automatic rebuild.
5. Supports for AHCI on RAID arrays, including NCQ and native hot plug.

For more information please visit Intel's official website.

For more about the system setup for Serial ATA, please check the chapter of SATA configuration.

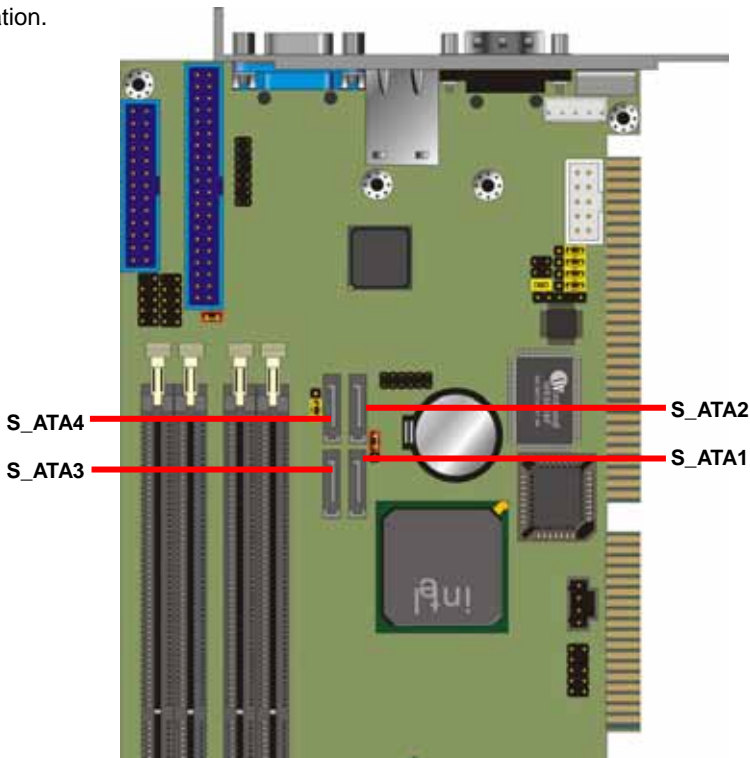

2.8 <LAN Interface>

The board comes with an Intel PRO/100 LAN with 82562EZ PHY, or up to three Intel PRO/1000 Gigabit LAN with 82570EI for PCI-Express 1x bus. The PCI-Express is the last expansion interface technology, for its serial data transfer scheme, each 1x lane will be up to 500MB/s (duplex).

(PS: The Gigabit LAN version is not available yet)

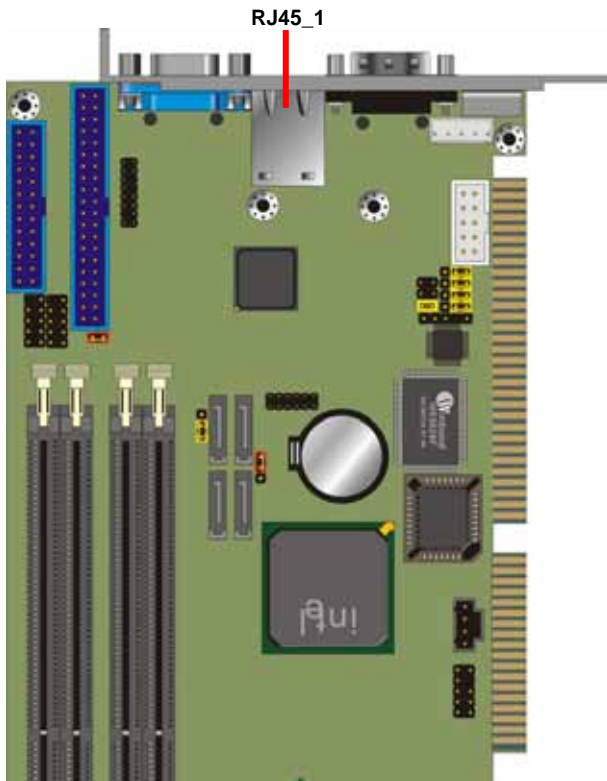

2.9 <Audio Interface>

FS-979 integrated with REALTEK® ALC201A Codec for 2 channel sound output. It supports 18-bit stereo full-duplex, compliant with AC97 Rev.2.2 specifications.

Connector: CN_AUDIO

Type: 10-pin (2 x 5) header (pitch = 2.54mm)

Pin	Description	Pin	Description
1	Line – Right	2	Ground
3	Line – Left	4	MIC
5	MIC	6	Ground
7	N/C	8	Line Out – Left
9	Line Out – Right	10	Ground

Connector: CDIN

Type: 4-pin header (pitch = 2.54mm)

Pin	Description
1	CD – Left
2	Ground
3	Ground
4	CD – Right

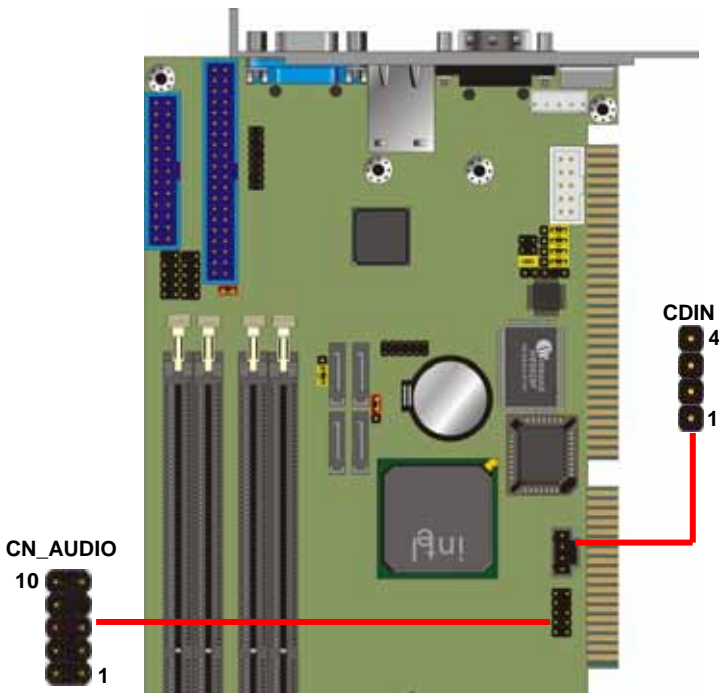

2.10 <Display Interface>

FS-979 integrates with Intel® 915G GMCH for Intel Graphic Media Accelerator (GMA) 900 technology. It supports Intel® DVM (Dynamic Video Memory Technology) 3.0 for up to 224MB frame buffer size shared with system memory. With a 333MHz core and DirectX 9 and OpenGL acceleration, **FS-979** provides the powerful onboard graphics interface without additional graphic card. *(More information please visit Intel's website)*

The board also comes with a DVI interface with CHRONTEL CH7307B-DE for digital video interface.

Connector: **CN_VGA**

Type: 16-pin (2 x 8) pin header (pitch = 2.0mm)

Pin	Description	Pin	Description
1	Red	9	Green
2	Blue	10	N/C
3	Ground	11	Ground
4	Ground	12	Ground
5	N/C	13	Ground
6	N/C	14	Data
7	HSYNC	15	VSYNC
8	Clock	16	N/C

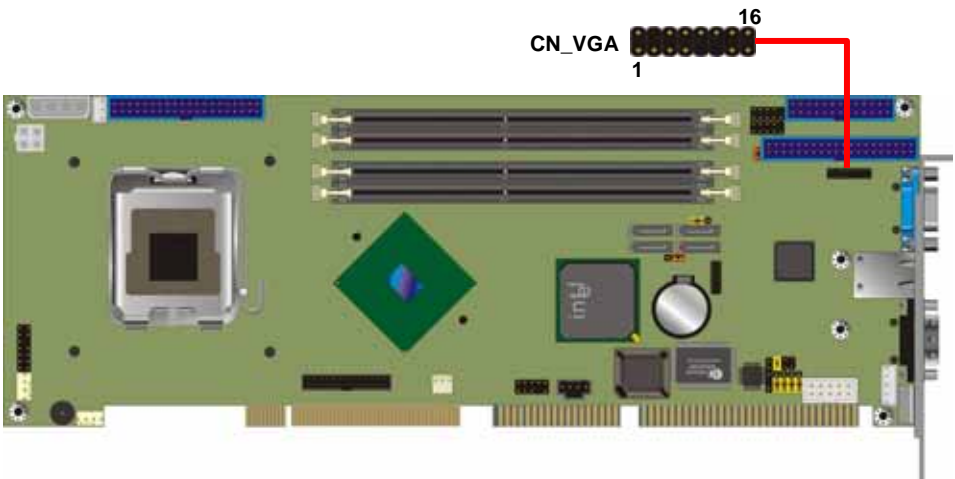

Connector: **CN_DVI**

Connector type: 26-pin header connector (pitch = 2.00mm)

Pin Number	Assignment	Pin Number	Assignment
1	TMDS_TX1+	2	TMDS_TX1-
3	Ground	4	Ground
5	TMDS_TXC+	6	TMDS_TXC-
7	Ground	8	PVDD
9	N/C	10	N/C
11	TMDS_TX2+	12	TMDS_TX2-
13	Ground	14	Ground
15	TMDS_TX0+	16	TMDS_TX0-
17	N/C	18	HPDET
19	DDCDATA	20	DDCCLK

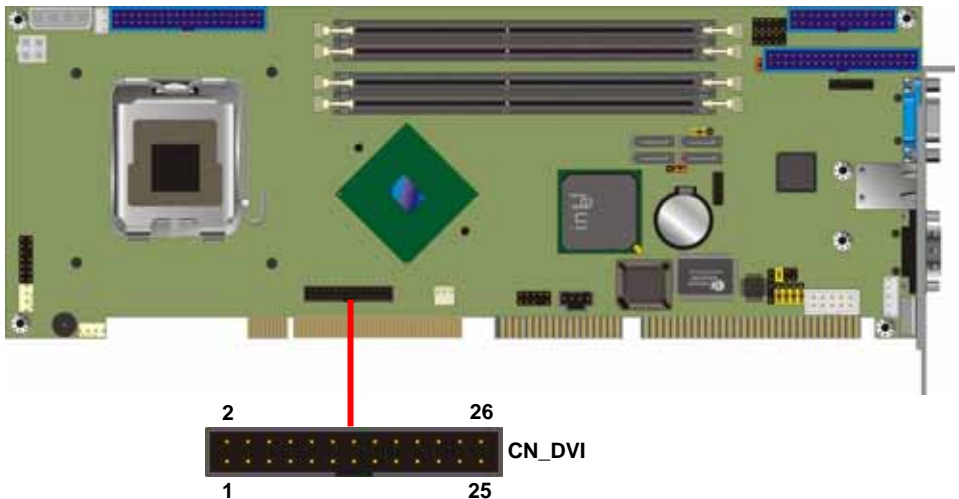

2.11 <Compact Flash Interface>

The board has one Compact Flash Type-II socket, users can apply embedded system on CF card or Micro drives, the jumper **JCFSEL** can let you select operating mode under master or slave. The Compact Flash socket supports storage type only.

Jumper: **JCFSEL**

Type: onboard 3-pin header

JCFSEL	Mode
1-2	Master
2-3	Slave

Default setting

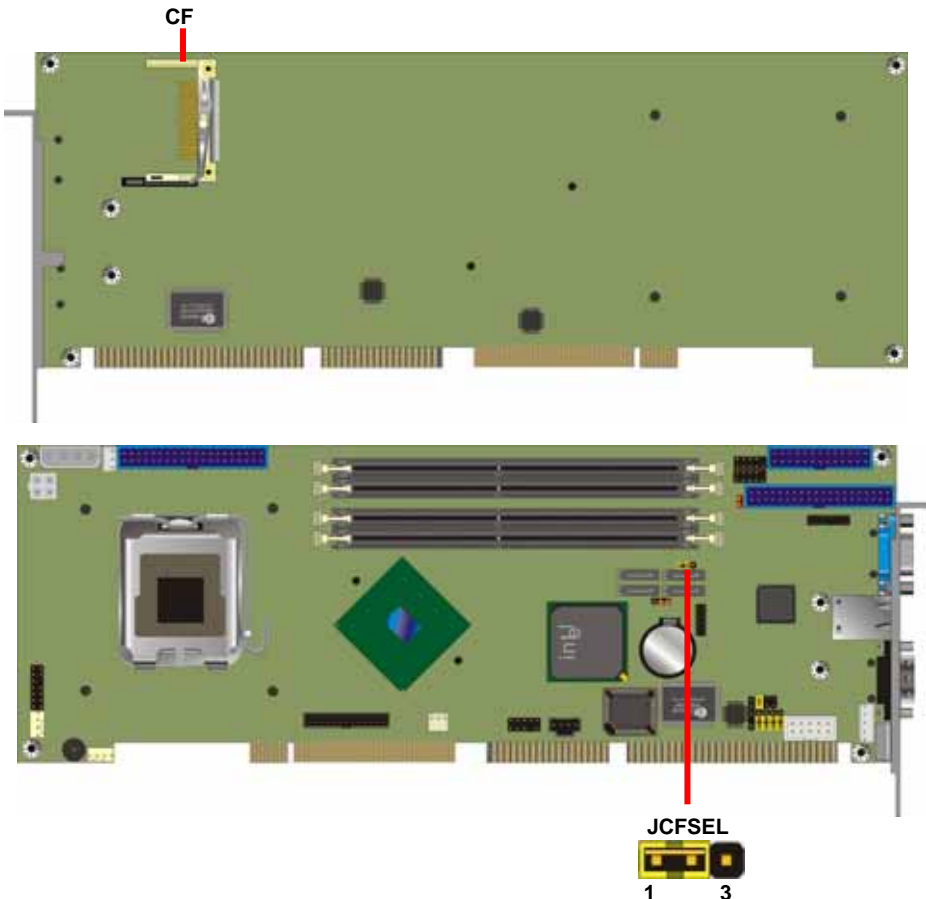

2.12 <USB2.0 Interface>

The board supports 4 USB2.0 ports based on Intel® ICH6R, which can support up to 480Mbps of transfer rate, and offer 500mA for maximum rating.

The Intel® ICH6R contains an Enhanced Host Controller Interface (EHCI) and four Universal Host Controller Interfaces (UHCI), it can determine whether your connected device is for USB1.1 or USB2.0, and change the transfer rate automatically.

Connector: **CN_USB0/1**

Type: 10-pin (5 x 2) header for USB1/2 & USB3/4 Ports

Pin	Description	Pin	Description
1	VCC	2	VCC
3	Data0-	4	Data1-
5	Data0+	6	Data1+
7	Ground	8	Ground
9	Ground	10	N/C

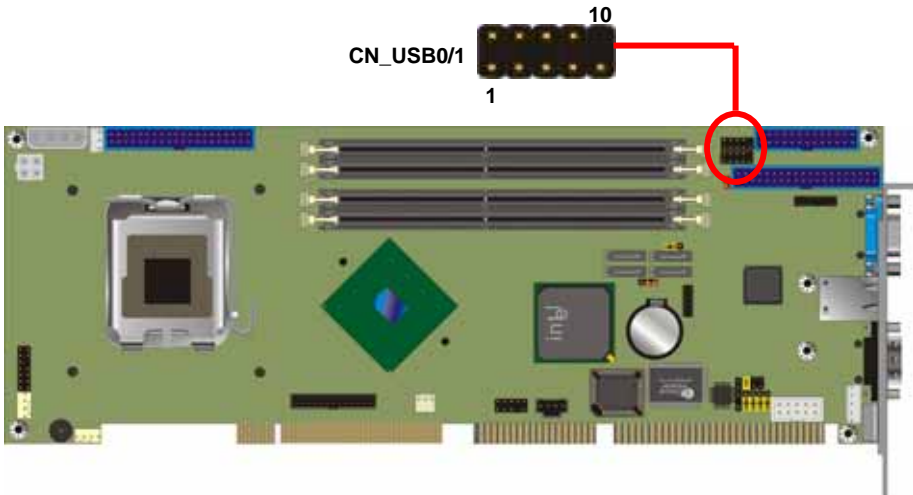

2.13 <Power and Fan Installation>

The board comes with a 4-pin AT power connector and a 4-pin additional 12V power connector for powering the board, three fan connectors for Northbridge, CPU and system. The board also provides a 3-pin ATX function connector. You can just connect the two power connectors without any backplane to work.

2.13.1 <Power connectors>

Connector: **CN_PWR**

Type: 4-pin P-type connector for for +5V/+12V input

Pin	Description	Pin	Description	Pin	Description	Pin	Description
1	+5V	2	Ground	3	Ground	4	+12V

Connector: **CN_12V**

Type: 4-pin standard Pentium 4 additional +12V power connector

Pin	Description	Pin	Description
1	Ground	2	Ground
3	+12V	4	+12V

Notice: The CN_12V is necessary for CPU powering; please ensure your power supply has the connector for it.

Connector: **CN_PS**

Type: 3-pin ATX function connector

Pin	Description	Pin	Description	Pin	Description
1	5V Standby	2	Ground	3	Power On

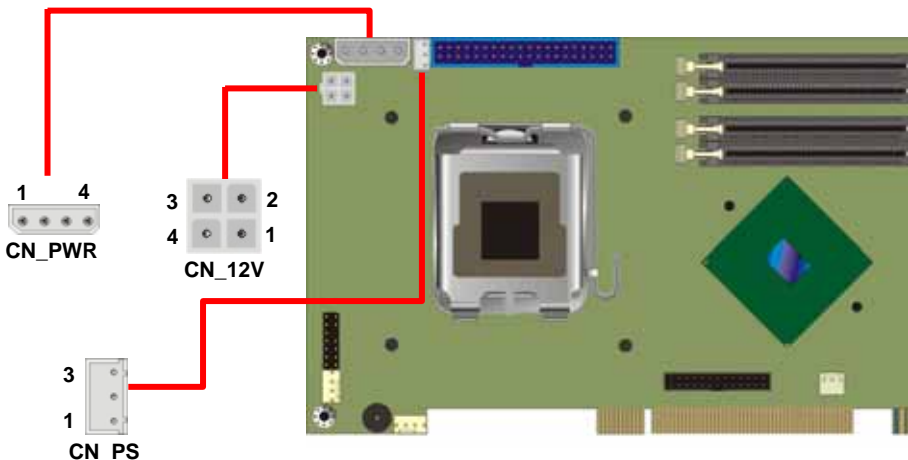

2.13.2 <Fan Connectors>

Connector: **CPUFAN**

Type: 4-pin fan wafer connector

Pin	Description	Pin	Description
1	Ground	2	+12V
3	Fan Speed Detection	4	Fan Control

Connector: **NBFAN, SYSFAN**

Type: 3-pin fan wafer connector

Pin	Description	Pin	Description	Pin	Description
1	Ground	2	+12V	3	Fan Control

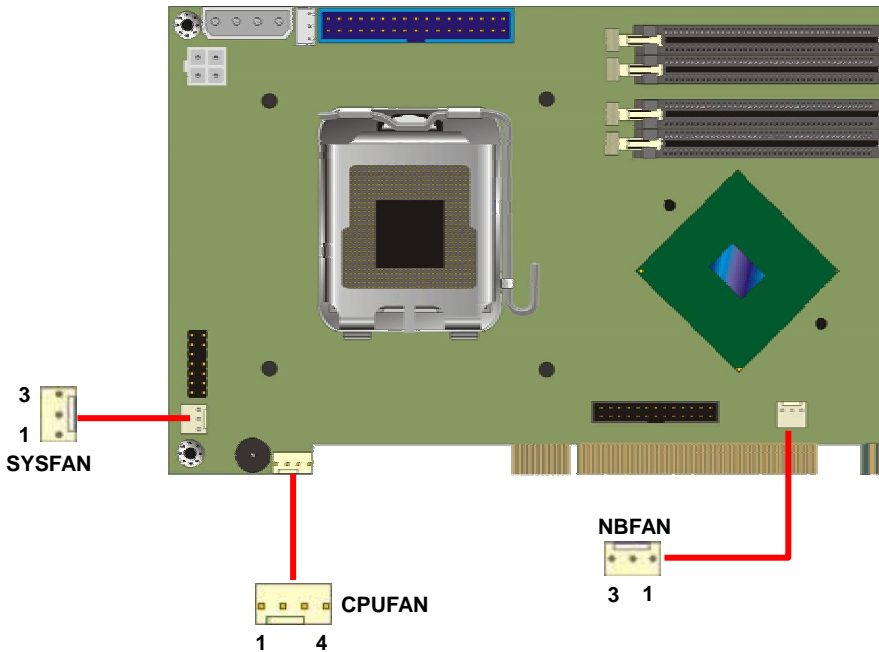

2.14 <Serial Port Configuration>

The board supports one RS232 serial port and one jumper selectable RS232/422/485 serial ports. The jumper JCSEL1 & JCSEL2 can let you configure the communicating modes for COM2.

Jumper: **JCSEL1/2**

Type: onboard 12-, 6-pin header

COM2 Mode	JCSEL1	JCSEL2
RS-232	1-2/4-5/7-8/10-11	1-2
RS-422	1-2/4-5/8-9/11-12	5-6
RS-485	2-3/5-6/7-8/10-11	3-4

Default setting

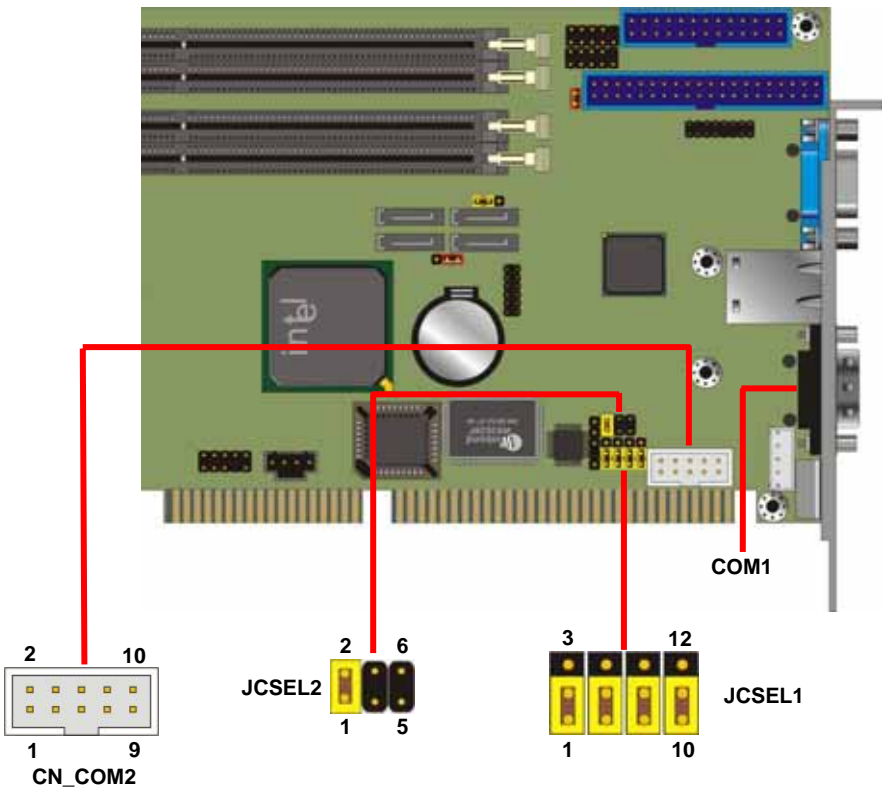

2.15 <GPIO Interface>

The board provides a 12-pin General Purpose I/O interface, with programmable 8-bit I/O (4-bit input & 4-bit output).

Connector: **CN_DIO**

Type: onboard 2 x 6-pin header, pitch=2.0mm

Pin	Description	Pin	Description
1	Ground	2	Ground
3	GP10	4	GP14
5	GP11	6	GP15
7	GP12	8	GP16
9	GP13	10	GP17
11	VCC	12	+12V

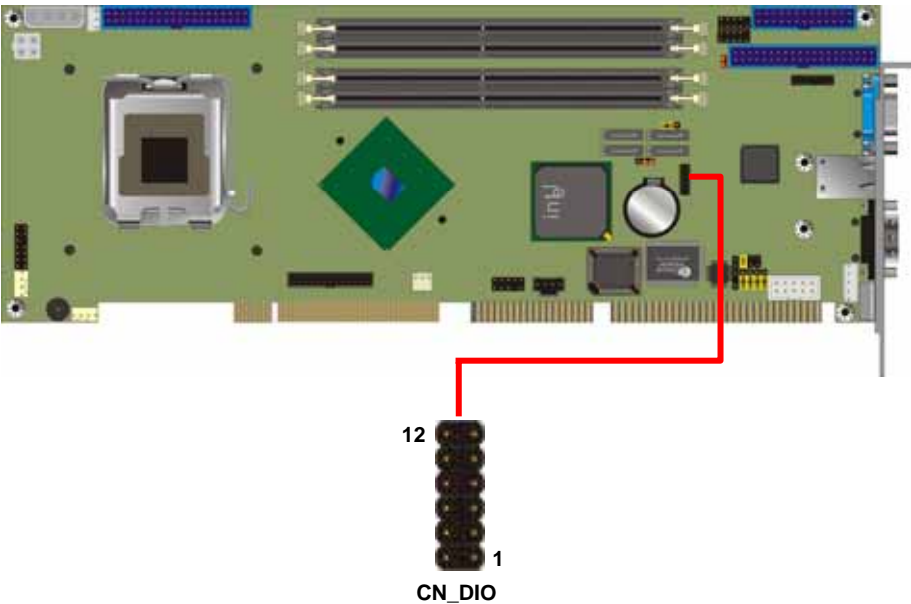

2.16 <Switch and Indicator>

The **JFRNT** provides front control panel of the board, such as power button, reset and beeper, etc. Please check well before you connecting the cables on the chassis.

Connector: **JFRNT**

Type: onboard 14-pin (2 x 7) 2.54-pitch header

Function	Signal	PIN		Signal	Function
IDE LED	Vcc (+)	1	2	(+) Vcc	Power LED
	Active	3	4	N/C	
Reset	Reset	5	6	GND	Speaker
	GND	7	8	Vcc	
N/C		9	10	N/C	
Power Button	PWRBT	11	12	N/C	
	GND	13	14	SPKIN	

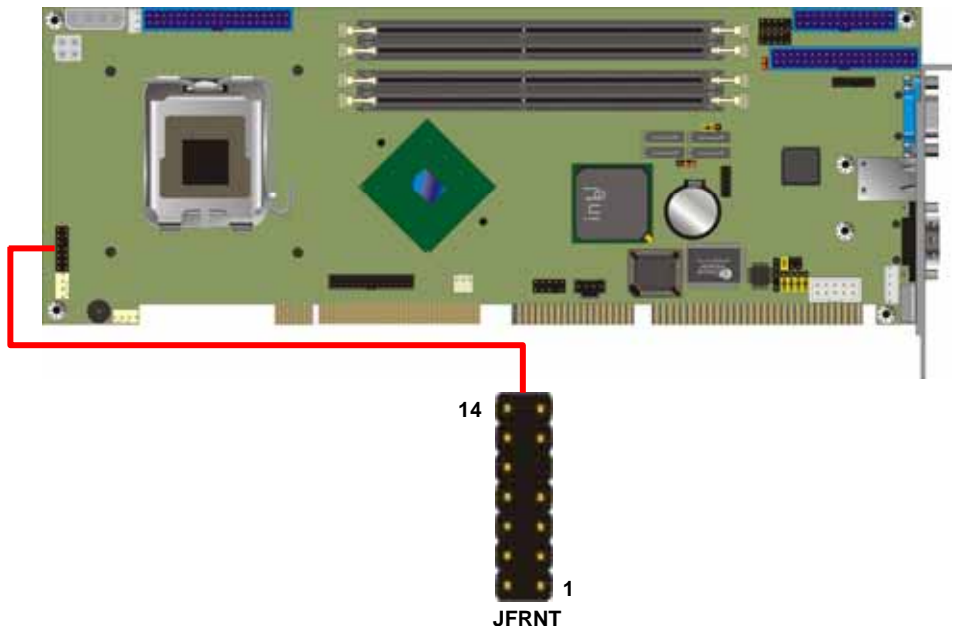

(This Page is Left for Blank)

Chapter 3 <System Configuration>

3.1 <SATA Configuration>

Based on Intel® ICH6R Southbridge chip, the board supports 4 Serial ATA ports; please follow the touring guide to setup your Serial ATA devices.

For Windows 98/SE/ME, Windows NT4.0 and DOS system, they only support up to 4 IDE devices including SATA devices, and Windows 2000/XP/Server2003 have no such limitation.

Operating System (Support Mode)	Parallel ATA	Serial ATA			
	Primary (2 Devices)	SATA1	SATA2	SATA3	SATA4
Windows 2000/XP (Enhance Mode)	○	○	○	○	○
Windows 98/ME/NT4.0					
Type 1 (Combine Mode)	○ (Primary)	X	○ (Secondary)	X	○ (Secondary)
Type 2 (Combine Mode)	○ (Secondary)	○ (Primary)	X	○ (Primary)	X
Type 3 (SATA only)	X	○ (Primary) (Master)	○ (Secondary) (Master)	○ (Primary) (Slave)	○ (Secondary) (Slave)

(Table 3.1.1)

The following BIOS setup screen shows how to setup your ATAPI devices with each mode.

SATA Mode:

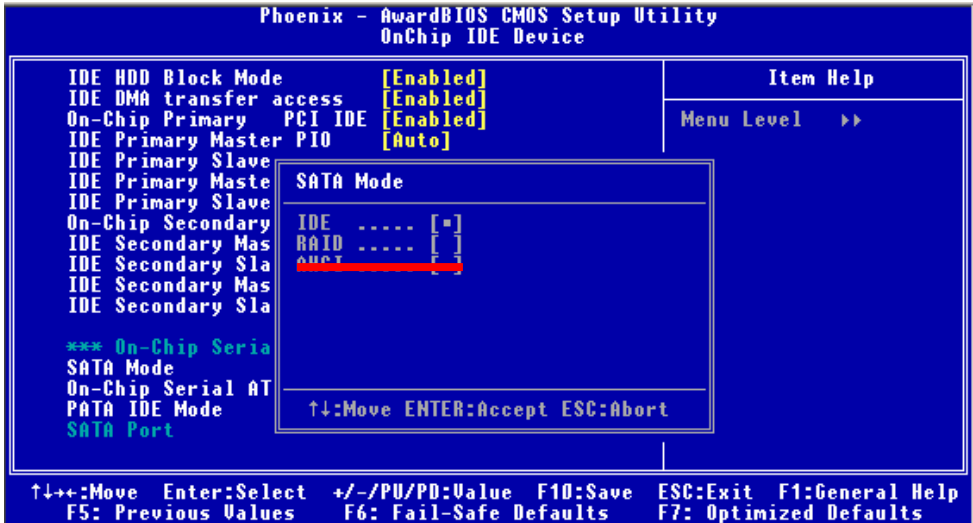

This option can let you select whether the Serial ATA hard drives would work under normal IDE mode or RAID mode. The RAID mode need more than one HDD is applied.

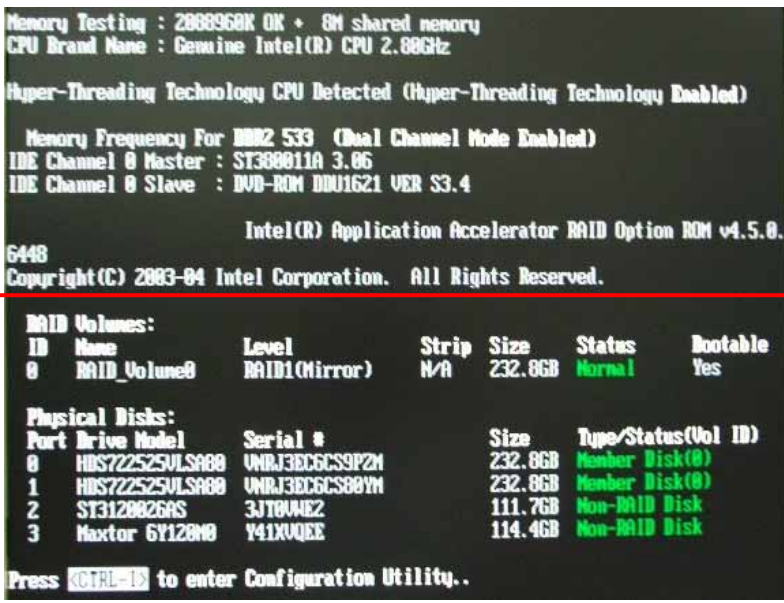

Once you enable the RAID mode, the boot-up screen would pop up the RAID configuration option for setup.

On-Chip Serial ATA mode:

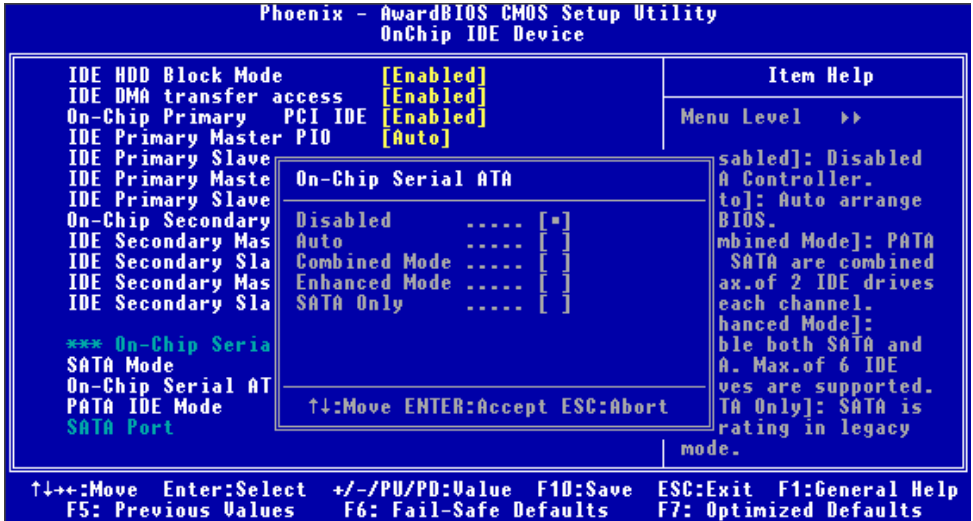

This option can let you select operation modes of Serial ATA drives.

Disabled: To disable the onboard Serial ATA controller.

Auto: To allow the system select the optimized mode automatically.

Combined mode: PATA and SATA work as two channels for supporting two drives on each channel.

Enhanced mode: Max supported of the PATA and SATA for up to 6 drives.

SATA Only: To disable the PATA and only apply the SATA drives.

Notice: The Combined mode and Enhanced mode are supported depends on your operating system, please check **page33** for relative information.

3.2 <SATA RAID Configuration>

The board integrates Intel® ICH6R with RAID function for Serial ATA drives, and supports the configurations below:

RAID 0 (Striping): Two hard drives operating as one drive for optimized data R/W performance. It needs two unused drives to build this operation.

RAID 1 (Mirroring): Copies the data from first drive to second drive for data security, and if one drive fails, the system would access the applications to the workable drive. It needs two unused drives or one used and one unused drive to build this operation. The second drive must be the same or larger size than first one.

Intel Matrix Storage Technology: This technology would allow you to use **RAID 0+1** mode on only two drives (4 drives needed on traditional RAID 0+1). It will create two partitions on each hard drive to simulate **RAID 0** and **RAID 1**. It also can let you modify the partition size without re-formatted.

For more information of Intel Matrix Storage Technology, please visit Intel's website.

If you need to install an operation system on the RAID set, please use the driver disk attached in the package when it informs you to obtain the RAID drivers.

```

Intel(R) Application Accelerator RAID Option ROM v4.0.0.6211
Copyright(C) 2003-04 Intel Corporation. All Rights Reserved.

[ MAIN MENU ]

1. Create RAID Volume
2. Delete RAID Volume
3. Reset Disks to Non-RAID
4. Exit

[ DISK/VOLUME INFORMATION ]

RAID Volumes:
None defined.

Non-RAID Disks:
Port Drive Model      Serial #      Size      Type/Status (Vol ID)
-----
0-0000000000000000  xxxxxxxx    74.5GB   Non-RAID Disk
1-0000000000000000  xxxxxxxx    74.5GB   Non-RAID Disk

[ ↓↑ ] -Select      [ ESC ] Exit      [ Enter ] -Select Menu

```

Please press <CTRL+I> to enter the RAID configuration menu.

You can setup the RAID under operation system for Microsoft® Windows XP SP1 or Windows 2000 SP4 version, please install the Intel® Application Accelerator Ver.4.5 later to support RAID configuration with Intel® Matrix Storage Technology.

1. After installing Intel Application Accelerator, please execute Intel® Storage Utility.

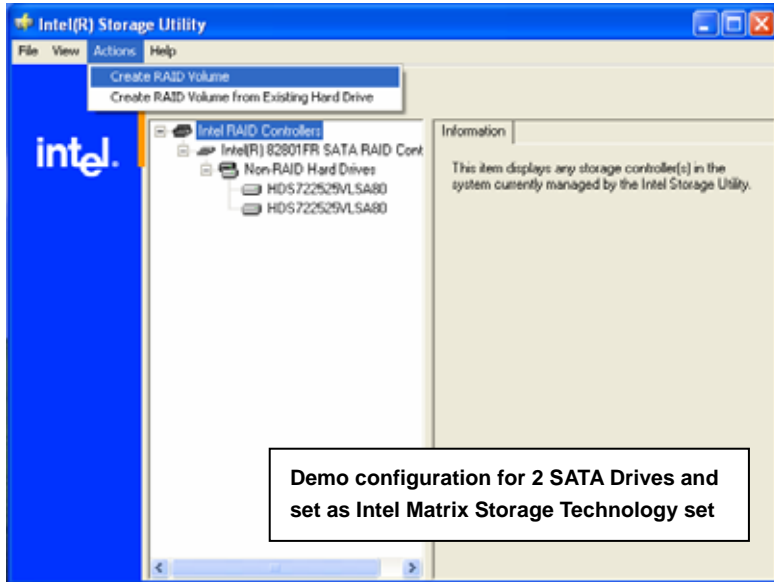

2. Select Actions to Create RAID Volume

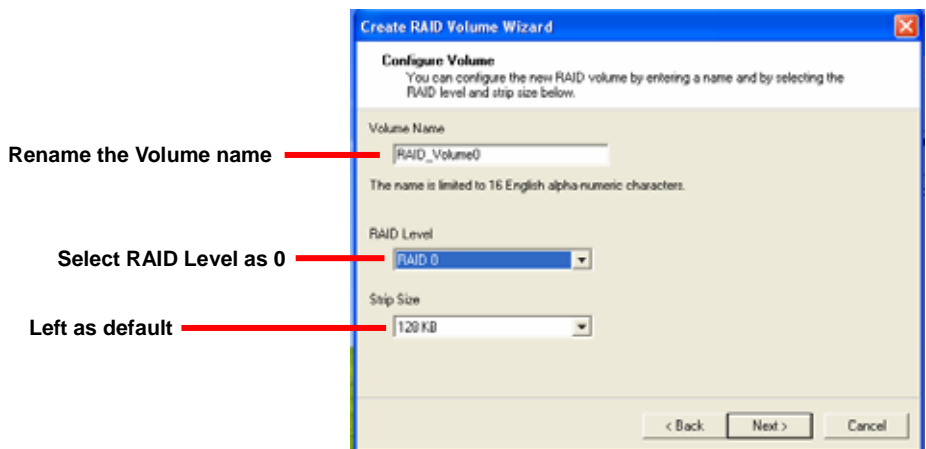

3. Please select two hard drives to prepare to set the RAID volume

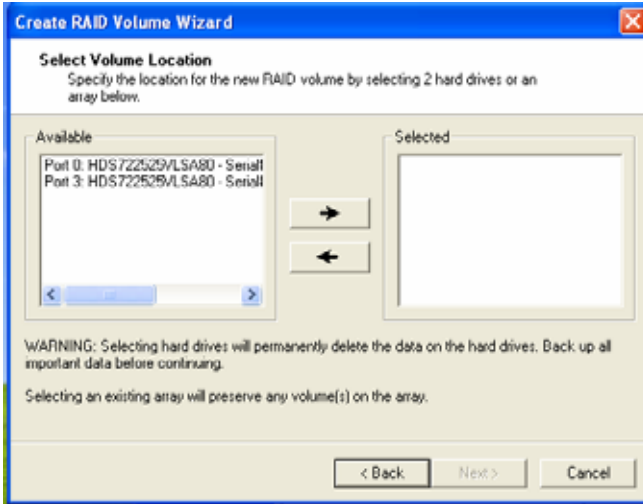

4. Specify the Volume size

Tune this bar to specify the volume size, if you specify the volume size lower than maximum, you can create a second volume for another RAID set. (Make RAID 0+1 on only two hard drives)

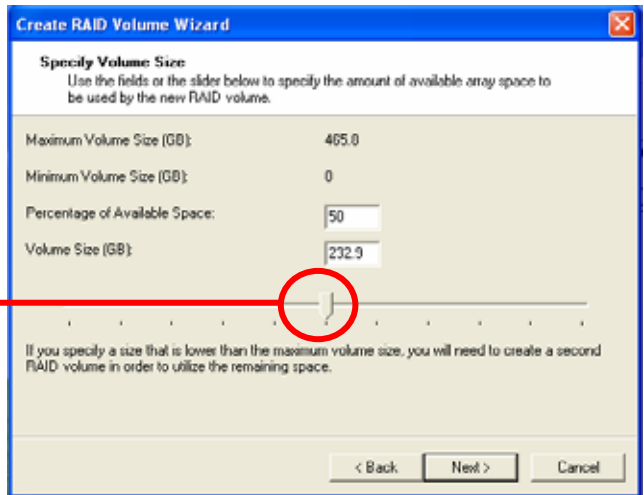

5. Repeat the step 1 to create second volume as RAID Level 1.

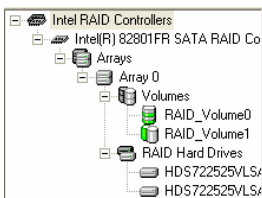

For other configuration set please click Help on tool bar.

3.3 <Video Memory Setup>

Based on Intel® 915G chipset with GMA (Graphic Media Accelerator) 900, the board supports Intel® DVMT (Dynamic Video Memory Technology) 3.0, which would allow the video memory be triggered up to 224MB.

To support DVMT, you need to install the Intel GMA 900 Driver with supported OS.

BIOS Setup:

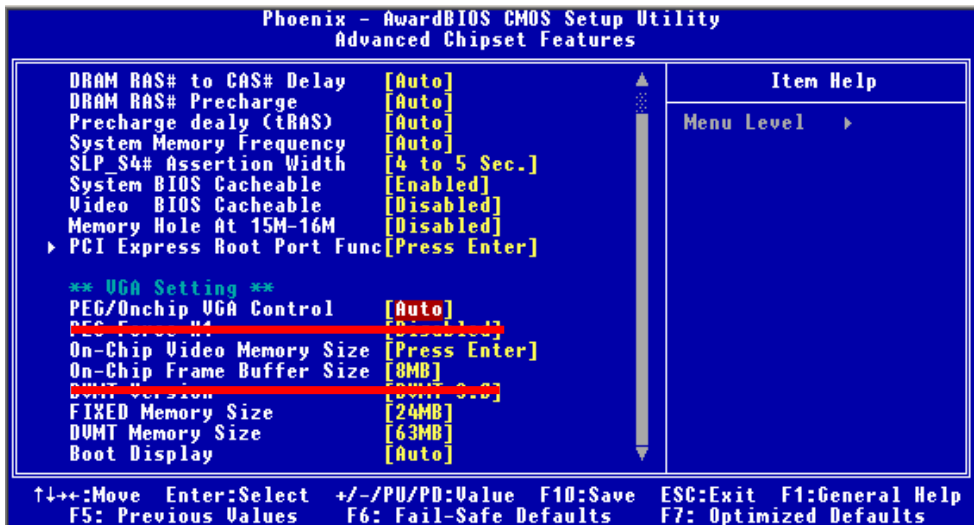

On-Chip Video Memory Size: This option combines three items below for setup.

On-Chip Frame Buffer Size:

This item can let you select video memory which been allocated for legacy VGA and SVGA graphics support and compatibility. The available option is **1MB** and **8MB**.

Fixed Memory Size:

This item can let you select a static amount of page-locked graphics memory which will be allocated during driver initialization. Once you select the memory amount, it will be no longer available for system memory.

DVMT Memory Size:

This item can let you select a maximum size of dynamic amount usage of video memory, the system would configure the video memory depends on your application, this item is strongly recommend to be selected as **MAX DVMT**.

Fixed + DVMT Memory Size:

You can select the fixed amount and the DVMT amount at the same time for a guaranteed video memory and additional dynamic video memory, please check the table below for available setting.

System Memory	On-Chip Frame Buffer Size	Fixed Memory Size	DVMT Memory Size	Total Graphic Memory
128MB~255MB	1MB	32MB	0MB	32MB
	1MB	0MB	32MB	32MB
	8MB	32MB	0MB	32MB
	8MB	0	32MB	32MB
256MB~511MB	1MB	64MB	0MB	64MB
	1MB	0	64MB	64MB
	1MB	128MB	0MB	128MB
	1MB	0	128MB	128MB
	1MB	64MB	64MB	128MB
	8MB	64MB	0MB	64MB
	8MB	0	64MB	64MB
	8MB	128MB	0MB	128MB
	8MB	0	128MB	128MB
	8MB	64MB	64MB	128MB
512MB upper	1MB	64MB	0	64MB
	1MB	0	64MB	64MB
	1MB	128MB	0	128MB
	1MB	0	128MB	128MB
	1MB	64MB	64MB	128MB
	1MB	0	224MB	224MB
	8MB	64MB	0	64MB
	8MB	0	64MB	64MB
	8MB	128MB	0	128MB
	8MB	0	128MB	128MB
	8MB	64MB	64MB	128MB
	8MB	0	224MB	224MB

Notice:

1. The On-Chip Frame Buffer Size would be included in the Fixed Memory.

Please select the memory size according to this table.

3.4 <Display Properties Setting>

Based on Intel 915G GMCH with GMA 900 (Graphic Media Accelerator), the board supports two DACs for display device as different resolution and color bit.

Please install the Intel Graphic Driver before you starting setup display devices.

1. Click right button on the desktop to lunch **display properties**

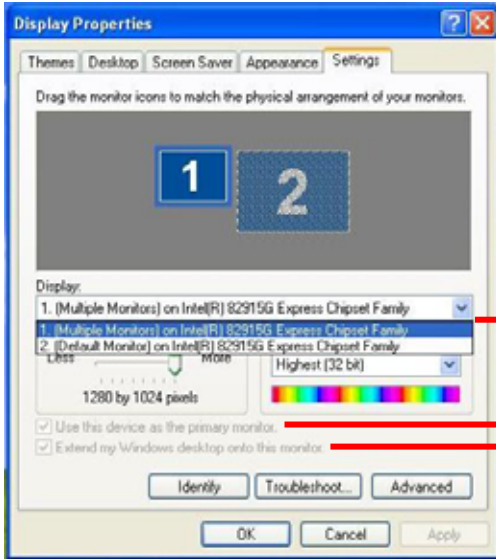

You can find two DACs on this setup screen, to select each for resolution and color bit setup.

You can choose on of the device for primary monitor.

You can setup the two devices for extended desktop

2. Click **Advanced** button for more specificity setup.



Click Graphics Properties... for advanced setup

3. This setup options can let you define each device settings.

Click **Monitor** to setup the CRT monitor for Colors, Resolution and Refresh Rate

Click **Digital Display** to setup the DVI monitor for Colors, and Resolution

Click **Intel® Dual Display Clone** to setup the dual display mode as same screen

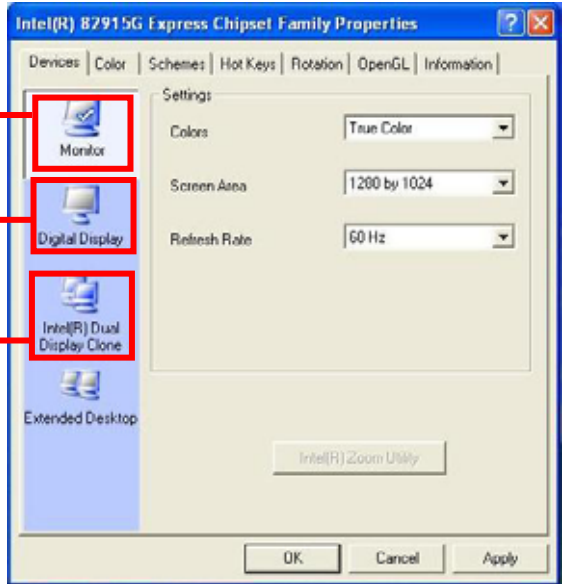

Set the main display device here

Click **Extended Desktop** to setup the dual display mode as different screen display

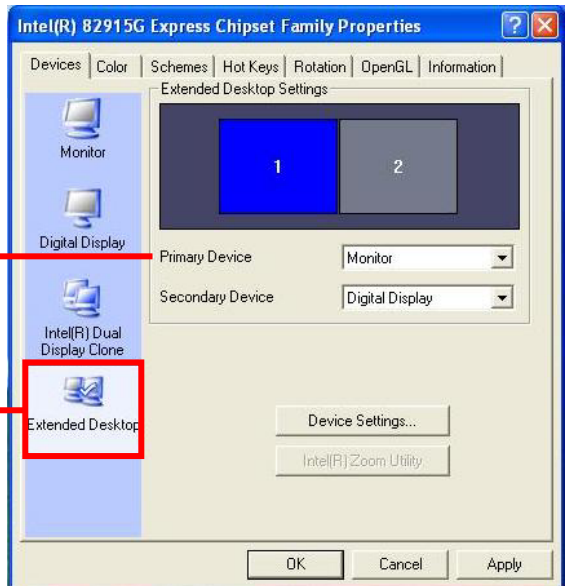

Chapter 4 <BIOS Setup>

The motherboard uses the Award BIOS for the system configuration. The Award BIOS in the single board computer is a customized version of the industrial standard BIOS for IBM PC AT-compatible computers. It supports Intel x86 and compatible CPU architecture based processors and computers. The BIOS provides critical low-level support for the system central processing, memory and I/O sub-systems.

The BIOS setup program of the single board computer let the customers modify the basic configuration setting. The settings are stored in a dedicated battery-backed memory, NVRAM, retains the information when the power is turned off. If the battery runs out of the power, then the settings of BIOS will come back to the default setting.

The BIOS section of the manual is subject to change without notice and is provided here for reference purpose only. The settings and configurations of the BIOS are current at the time of print, and therefore they may not be exactly the same as that displayed on your screen.

To activate CMOS Setup program, press key immediately after you turn on the system. The following message "Press DEL to enter SETUP" should appear in the lower left hand corner of your screen. When you enter the CMOS Setup Utility, the Main Menu will be displayed as **Figure 4-1**. You can use arrow keys to select your function, press <Enter> key to accept the selection and enter the sub-menu.

Figure 4-1 CMOS Setup Utility Main Screen

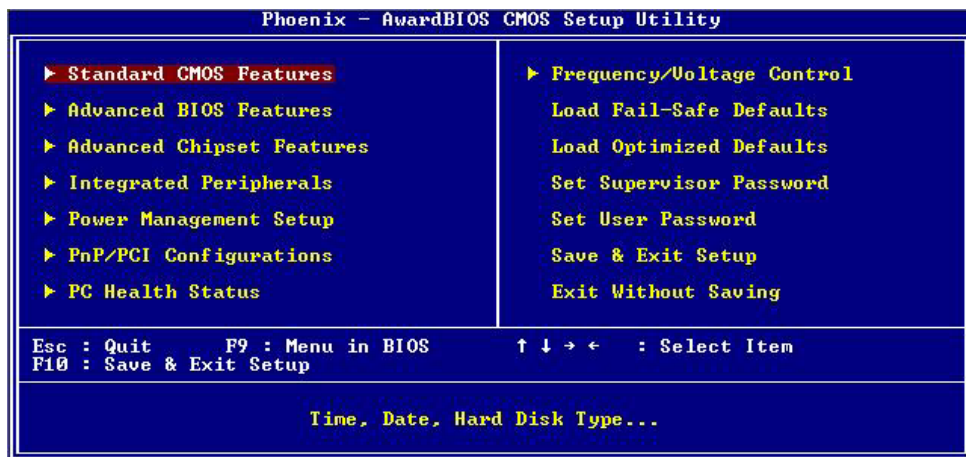

(This Page is Left for Blank)

Appendix A <I/O Port Pin Assignment>

A.1 IDE Port

Connector: IDE1

Type: 40-pin (20 x 2) box header



Pin	Description	Pin	Description
1	Reset	2	Ground
3	D7	4	D8
5	D6	6	D9
7	D5	8	D10
9	D4	10	D11
11	D3	12	D12
13	D2	14	D13
15	D1	16	D14
17	D0	18	D15
19	Ground	20	VCC
21	REQ	22	Ground
23	IOW-/STOP	24	Ground
25	IOR-/HDMARDY	26	Ground
27	IRDY/DDMARDY	28	IDESEL
29	DACK-	30	Ground
31	IRQ	32	N/C
33	A1	34	CBLID
35	A0	36	A2
37	CS0 (MASTER CS)	38	CS1 (SLAVE CS)
39	LED ACT-	40	Ground

A.2 <Serial ATA Port>

Connector: S_ATA1/2/3/4

Type: 7-pin wafer connector

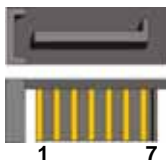

1	2	3	4	5	6	7
GND	RSATA_TXP1	RSATA_TXN1	GND	RSATA_RXN1	RSATA_RXP1	GND

A.3 < Floppy Port >

Connector: **Floppy**

Type: 34-pin (2 x 17) header



Pin	Description	Pin	Description
1	Ground	2	DRIVE DENSITY SELECT 0
3	Ground	4	DRIVE DENSITY SELECT 1
5	Ground	6	N/C
7	Ground	8	INDEX-
9	Ground	10	MOTOR ENABLE A-
11	Ground	12	DRIVER SELECT B-
13	Ground	14	DRIVER SELECT A-
15	Ground	16	MOTOR ENABLE B-
17	Ground	18	DIRECTION-
19	Ground	20	STEP-
21	Ground	22	WRITE DATA-
23	Ground	24	WRITE GATE-
25	Ground	26	TRACK 0-
27	Ground	28	WRITE PROTECT-
29	Ground	30	READ DATA-
31	Ground	32	HEAD SELECT-
33	Ground	34	DISK CHANGE-

A.4 <IrDA Port>

Connector: **CN_IR**

Type: 5-pin header for SIR Ports

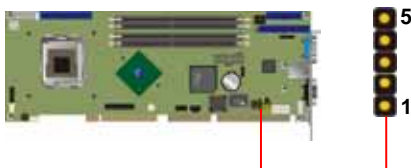

Pin	Description
1	VCC
2	N/C
3	IRRX
4	Ground
5	IRTX

A.5 < Parallel Port >

Connector: **CN_LPT**

Type: 26-pin (2 x 13) 2.54-pitch box header



Pin	Description	Pin	Description
1	STROBE-	14	AUTO FEED-
2	D0	15	ERROR-
3	D1	16	INITIALIZE-
4	D2	17	SELECT INPUT-
5	D3	18	Ground
6	D4	19	Ground
7	D5	20	Ground
8	D6	21	Ground
9	D7	22	Ground
10	ACKNOWLEDGE-	23	Ground
11	BUSY	24	Ground
12	PAPER EMPTY	25	Ground
13	SELECT+	26	N/C

A.6 <Serial Port >

A.6.1 <External DB9 serial port >

Connector: **COM1**

Type: 9-pin D-sub male connector on bracket

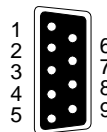

Pin	Description	Pin	Description
1	DCD	6	DSR
2	SIN	7	RTS
3	SO	8	CTS
4	DTR	9	RI
5	Ground		

A.6.2 <Internal serial port >

Connector: **CN_COM1 (VDG2/VDG3 only); CN_COM2**

Type: 10-pin (2 x 5) 2.54-pitch header

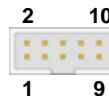

Pin	Description	Pin	Description
1	DCD	2	SIN
3	SO	4	DTR
5	Ground	6	DSR
7	RTS	8	CTS
9	RI	10	N/C

A.7 <VGA Port>

Connector: **VGA**

Type: 15-pin D-sub female connector on bracket

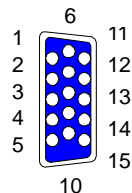

Pin	Description	Pin	Description	Pin	Description
1	RED	6	Ground	11	N/C
2	GREEN	7	Ground	12	5VCCA
3	BLUE	8	Ground	13	HSYNC
4	N/C	9	LVGA5V	14	VSYNC
5	Ground	10	Ground	15	5VCLK

A.8 <LAN Port>

A.8.1 < Fast Ethernet>

Connector: **RJ45_1 (VDL only)**

Type: RJ45 connector with LED on bracket



Pin	1	2	3	4	5	6	7	8
Description	TX+	TX-	RX+	N/C	N/C	RX-	N/C	N/C

A.8.2 <Gigabit Ethernet >

Connector: **RJ45_1 (VDG only) RJ45_2 (VDG2 Only)
RJ45_3 (VDG3 only)**

Type: RJ45 connector with LED on bracket

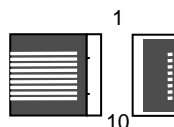

Pin	1	2	3	4	5
Description	TRD0+	TRD0-	TRD1+	TRD1-	NC
Pin	6	7	8	9	10
Description	NC	TRD2+	TRD2-	TRD3+	TRD3-

A.9 <AT Keyboard Port>

Connector: CN_ATKB

Type: 5-pin box header

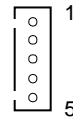

Pin	1	2	3	4	5
Description	VCC	Ground	N/C	DATA	CLK

A.10 <PS/2 Keyboard & Mouse Port>

Connector: PS2

Type: 6-pin Mini-DIN connector on bracket

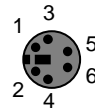

Pin	1	2	3	4	5	6
Description	KBD	MSD	Ground	VCC	KBC	MSC

Note: The PS/2 connector supports standard PS/2 keyboard directly or both PS/2 keyboard and mouse through the PS/2 Y-type cable.

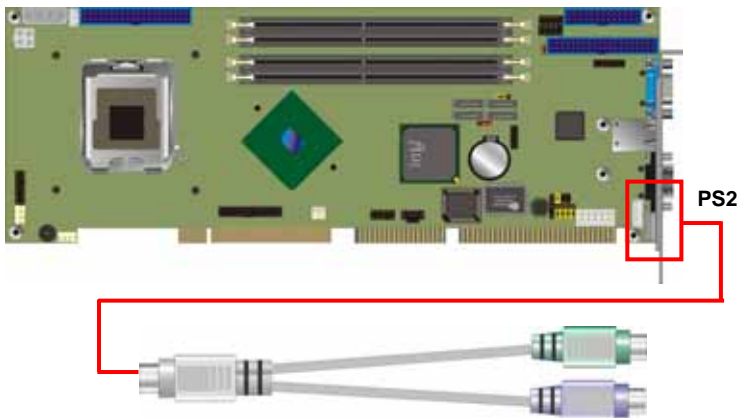

(This Page is Left for Blank)

Appendix B <Flash BIOS>

B.1 BIOS Auto Flash Tool

The board is based on Award BIOS and can be updated easily by the BIOS auto flash tool. You can download the tool online at the address below:

<http://www.award.com>

File name of the tool is "awdf flash.exe", it's the utility that can write the data into the BIOS flash ship and update the BIOS.

B.2 Flash Method

1. Please make a bootable floppy disk.
2. Get the last .bin files you want to update and copy it into the disk.
3. Copy awardflash.exe to the disk.
4. Power on the system and flash the BIOS. (Example: C:/ awardflash XXX.bin)
5. Re-star the system.

Contact Information

Any advice or comment about our products and service, or anything we can help you please don't hesitate to contact with us. We will do our best to support you for your products, projects and business

Annso Technology Co., Ltd

Address	The south faces industry area of Xia Gang Fu Hai road, Chang'an Town,Dongguan City, Guangdong, China	
TEL	+86-769-81666360	81666395-97
FAX	+86-769-81666306	
Website	http://www.annso.com	
E-mail	Rita@annso.com.cn	

Annso is our trademark of industrial PC division



Free Manuals Download Website

<http://myh66.com>

<http://usermanuals.us>

<http://www.somanuals.com>

<http://www.4manuals.cc>

<http://www.manual-lib.com>

<http://www.404manual.com>

<http://www.luxmanual.com>

<http://aubethermostatmanual.com>

Golf course search by state

<http://golfingnear.com>

Email search by domain

<http://emailbydomain.com>

Auto manuals search

<http://auto.somanuals.com>

TV manuals search

<http://tv.somanuals.com>