

# ET900

Intel® Core™ Duo/Solo 945GM  
COM Express (Type II) CPU Module

## USER'S MANUAL

Version 1.0

---

## Acknowledgments

Award is a registered trademark of Award Software International, Inc.

PS/2 is a trademark of International Business Machines Corporation.

Intel and Celeron are registered trademarks of Intel Corporation.

Microsoft Windows is a registered trademark of Microsoft Corporation.

Winbond is a registered trademark of Winbond Electronics Corporation.

All other product names or trademarks are properties of their respective owners.

### Attention:

Before installing the CPU heat sink, remove the two protective sheaths as shown in the figure below.

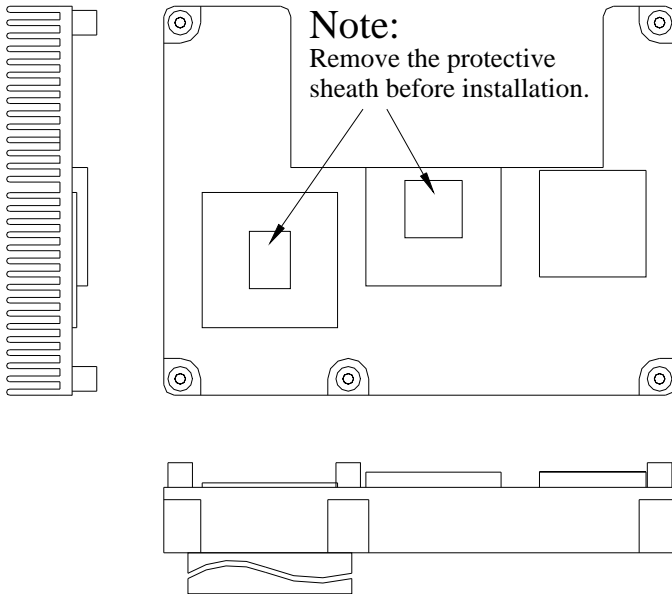

---

# Table of Contents

<b>Introduction .....</b>	<b>1</b>
Product Description.....	1
Checklist.....	2
ET900 Specifications .....	3
Dimensions.....	4
Installing the Processor .....	5
Installing the Memory .....	6
Connectors on ET900.....	7
J2, J3: COM Express Type 2 Connectors.....	7
<b>BIOS Setup.....</b>	<b>11</b>
<b>Drivers Installation .....</b>	<b>35</b>
Intel Chipset Software Installation Utility.....	36
VGA Drivers Installation .....	38
AC97 Codec Audio Driver Installation (IP400 carrier board only) .....	40
Intel PRO LAN Drivers Installation.....	42
Marvell LAN Drivers Installation (IP400 carrier board only) .....	43



The ET900 945GM COM Express CPU Module

# Introduction

## Product Description

---

---

The ET900 board incorporates the Mobile Intel® 945GM Express Chipset for Embedded Computing, consisting of the Intel® 945GM Graphic Memory Controller Hub (GMCH) and Intel® I/O Controller Hub 7-M (ICH7-M), an optimized integrated graphics solution with a 533MHz and 667MHz front-side bus. Dimensions of the board are 95mm x 125mm.

The integrated powerful 3D graphics engine, based on Intel® Graphics Media Accelerator 950 (Intel® GMA 950) architecture, operates at core speeds of up to 400 MHz. It features a low-power design and is validated with the Intel® Core Duo/Solo on 65nm process. With DDR2 667MHz SO-DIMM socket on board, the board supports up to 2GB of DDR2 system memory.

Intel® Graphics Media Accelerator 950 supports a unique intelligent memory management scheme called Dynamic Video Memory Technology (DVMT). DVMT handles diverse applications by providing the maximum (224MB) availability of system memory for general computer usage, while supplying additional graphics memory when a 3D-intensive application requests it. The Intel GMA 950 graphics architecture also takes advantage of the high-performance Intel processor. Intel GMA 950 graphics supports Dual Independent Display technology.

The main features of the board are:

- Supports COM ETX Type II Module pin-out definitions
- Supports Intel® Core™ Duo/Solo processors
- Supports up to 533/667MHz FSB
- One DDR2 SDRAM SO-DIMM, Max. 2GB
- Intel® 945GM Express VGA for CRT / LVDS
- Intel® 945GM Integrated VGA; Supports CRT / LVDS
- Supports up to six x1 PCI-E, one x16 PCI-E, four PCI

## Checklist

---

---

Your ET900 package should include the items listed below.

- The ET900 CPU Module
- This User's Manual
- 1 CD containing the following:
  - Chipset Drivers
  - Flash Memory Utility

## ET900 Specifications

<b>Form Factor</b>	COM-ETX w/ Pin-Out Type 2
<b>CPU Type</b>	Intel Core Duo/Solo Mobile Processors
<b>CPU Voltage</b>	0.700V ~ 1.5V
<b>System Speed</b>	Up to 1.66GHz or above
<b>CPU Operate Frequency</b>	533MHz/667MHz FSB
<b>Cache</b>	2MB
<b>Green /APM</b>	APM1.2
<b>CPU Socket</b>	BGA CPU on board / mPGA 478MT Socket
<b>Chipset</b>	Intel 945GM Chipset GMCH: 82945GM 1466-pin FCBGA ICH7M: 82801GBM 652-pin mBGA FWH
<b>BIOS</b>	Award BIOS, support ACPI Function
<b>Memory</b>	DDR2 667/533 SO-DIMM x1 (w/o ECC function), Max. 2GB
<b>VGA</b>	945GM built-in, supports CRT/S-VIDEO
<b>LVDS</b>	945GM built-in, supports 18+18 bits, single or dual channel LVDS
<b>TV-Out</b>	Support TV-Out (Composite) and S-Video
<b>LAN</b>	ICH7M built-in 10/100BT MAC + Intel EP82562ET PHY
<b>USB 2.0</b>	ICH7M built-in USB 2.0 host controller, support 8 ports
<b>Serial ATA Ports</b>	ICH7M built-in SATA controller, supports 2 ports
<b>Parallel IDE</b>	ICH7M built-in one channel Ultra DMA 33/66/100
<b>Audio</b>	ICH7M Built-in Audio controller (AC97 Codec at carrier board)
<b>Connector to Carrier Board</b>	Two 220-pin connectors (A-B & C-D)
<b>Watchdog Timer</b>	Yes (256 segments, 0, 1, 2...255 sec/min)
<b>System Voltage</b>	+5V, +3.3V, +12V, 5VSB
<b>Other</b>	Modem Wakeup, LAN Wakeup
<b>Board Size</b>	95mm x 125mm

# Dimensions

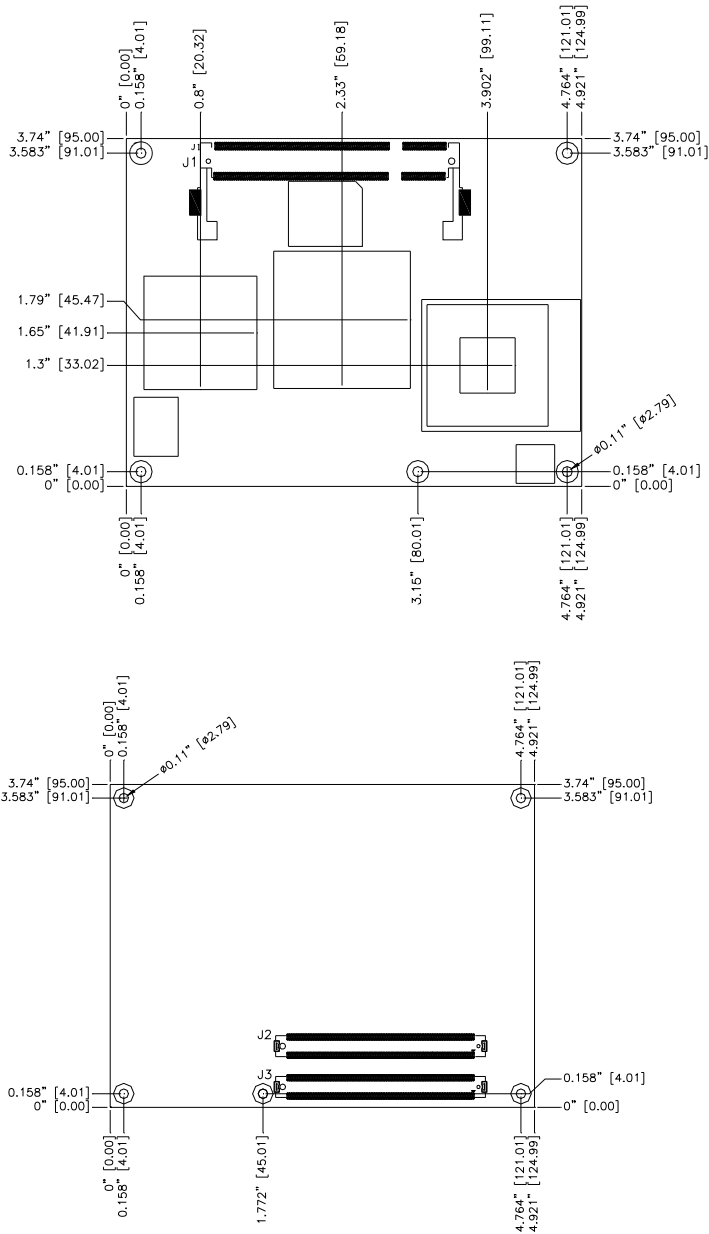



---

## Installing the Processor

---

The ET900 is available with a processor socket on board or with an Intel® processor on board. In the case that your ET900 comes a Socket 479 processor socket for Intel® Pentium® M or Celeron® M processors, follow the instructions below regarding the processor installation.

The processor socket comes with a screw to secure the processor. As shown in the left picture below, loosen the screw first before inserting the processor. Place the processor into the socket by making sure the notch on the corner of the processor corresponds with the notch on the inside of the socket. Once the processor has slide into the socket, fasten the screw. Refer to the figures below.

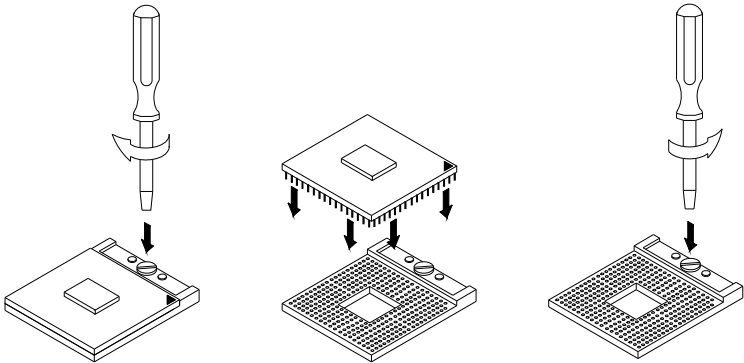

**NOTE:** Ensure that the CPU heat sink and the CPU top surface are in total contact to avoid CPU overheating problem that would cause your system to hang or be unstable.

## Installing the Memory

---

The ET900 COM Express CPU module accommodates 200-pin DDR2-533 and DDR2-667 SODIMM memory modules with capacities up to 2GB. Non-ECC is supported.

### Installing and Removing Memory Modules

To install the DDR2 modules, locate the memory slot on the board and perform the following steps:

1. Hold the DDR2 module so that the key of the DDR2 module align with those on the memory slot. Insert the module into the socket at a slight angle (approximately 30 degrees). Note that the socket and module are both keyed, which means that the module can be installed only in one direction.
2. To seat the memory module into the socket, apply firm and even pressure to each end of the module until you feel it slip down into the socket.
3. With the module properly seated in the socket, rotate the module downward. Continue pressing downward until the clips at each end lock into position.
4. To remove the DDR2 module, press the clips with both hands.

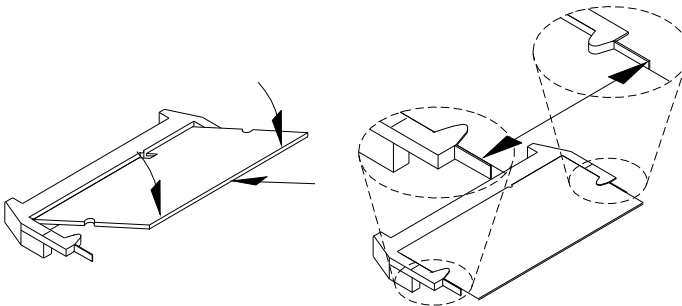

---

## Connectors on ET900

---

### J2, J3: COM Express Type 2 Connectors

The Type 2 connectors come in two 220-pin 0.5mm pitch receptacles. They include PCI, IDE, GBE and up to 22 general-purpose PCIE lanes (PCIE 0-5 and PCIE 16-31). For most Type 2 implementations, it is expected that PCIE lanes 16-31 are used for graphics. Hence they are designated PEG lanes 0-15 in the following table. Modules implementing Pin out Type 2, such as the ET900, uses the pin-out shown.

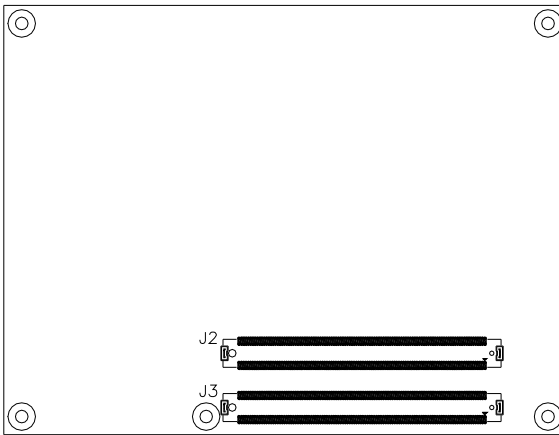

Row A		Row B		Row C		Row D	
Pin	Signal	Pin	Signal	Pin	Signal	Pin	Signal
A1	GND (FIXED)	B1	GND (FIXED)	C1	GND (FIXED)	D1	GND (FIXED)
A2	NC	B2	GBE0_ACT#	C2	IDE_D7	D2	IDE_D5
A3	NC	B3	LPC_FRAME#	C3	IDE_D6	D3	IDE_D10
A4	GBE0_LINK100#	B4	LPC_AD0	C4	IDE_D3	D4	IDE_D11
A5	NC	B5	LPC_AD1	C5	IDE_D15	D5	IDE_D12
A6	NC	B6	LPC_AD2	C6	IDE_D8	D6	IDE_D4
A7	NC	B7	LPC_AD3	C7	IDE_D9	D7	IDE_D0
A8	GBE0_LINK#	B8	LPC_DRQ0#	C8	IDE_D2	D8	IDE_REQ
A9	GBE0_MDI1-	B9	LPC_DRQ1#	C9	IDE_D13	D9	IDE_IOW#
A10	GBE0_MDI1+	B10	LPC_CLK	C10	IDE_D1	D10	IDE_ACK#
A11	GND (FIXED)	B11	GND (FIXED)	C11	GND (FIXED)	D11	GND (FIXED)
A12	GBE0_MDI0-	B12	PWRBTN#	C12	IDE_D14	D12	IDE_IRQ
A13	GBE0_MDI0+	B13	SMB_CK	C13	IDE_IORDY	D13	IDE_A0
A14	NC	B14	SMB_DAT	C14	IDE_IOR#	D14	IDE_A1
A15	SUS_S3#	B15	SMB_ALERT#	C15	PCI_PME#	D15	IDE_A2
A16	SATA0_TX+	B16	SATA1_TX+	C16	PCI_GNT2#	D16	IDE_CS1#
A17	SATA0_TX-	B17	SATA1_TX-	C17	PCI_REQ2#	D17	IDE_CS3#
A18	SUS_S4#	B18	SUS-STAT#	C18	PCI_GNT1#	D18	IDE_RESET#
A19	SATA0_RX+	B19	SATA1_RX+	C19	Pcl_REQ1#	D19	PCI_GNT3#
A20	SATA0_RX-	B20	SATA1_RX-	C20	PCI_GNT0#	D20	PCI_REQ3#
A21	GND (FIXED)	B21	GND (FIXED)	C21	GND (FIXED)	D21	GND (FIXED)
A22	NC	B22	NC	C22	PCI_REQ0#	D22	PCI_AD1
A23	NC	B23	NC	C23	PCI_RESET#	D23	PCI_AD3
A24	SUS_S5#	B24	NC	C24	PCI_AD0	D24	PCI_AD5
A25	NC	B25	NC	C25	PCI_AD2	D25	PCI_AD7
A26	NC	B26	NC	C26	PCI_AD4	D26	PCI_C/BE0#
A27	BATLOW#	B27	NC	C27	PCI_AD6	D27	PCI_AD9
A28	ATA_ACT#	B28	AC_SDIN2	C28	PCI_AD8	D28	PCI_AD11
A29	AC_SYNC	B29	AC_SDIN1	C29	PCI_AD10	D29	PCI_AD13
A30	SC_RST#	B30	AC_SDIN0	C30	PCI_AD12	D30	PCI_AD15
A31	GND (FIXED)	B31	GND (FIXED)	C31	GND (FIXED)	D31	GND (FIXED)
A32	AC_BITCLK	B32	SPKR	C32	PCI_AD13	D32	PCI_PAR
A33	AC_SDOUT	B33	I2C_CK	C33	PCI_C/BE1#	D33	PCI_SERR#
A34	NC	B34	I2C_DAT	C34	PCI_PERR#	D34	PCI_STOP#
A35	THRMTRIP#	B35	THRM#	C35	PCI_LOCK#	D35	PCI_TRDY#
A36	USB6-	B36	USB7-	C36	PCI_DEVSEL#	D36	PCI_FRAME#
A37	USB6+	B37	USB7+	C37	PCI_IRDY#	D37	PCI_AD16
A38	USB_6_7_OC#	B38	USB_4_5_OC#	C38	PCI_C/BE2#	D38	PCI_AD18
A39	USB4-	B39	USB5-	C39	PCI_AD17	D39	PCI_AD20
A40	USB4+	B40	USB5+	C40	PCI_AD19	D40	PCI_AD22
A41	GND (FIXED)	B41	GND (FIXED)	C41	GND (FIXED)	D41	GND (FIXED)
A42	USB2-	B42	USB3-	C42	PCI_AD21	D42	PCI_AD24
A43	USB2+	B43	USB3+	C43	PCI_AD23	D43	PCI_AD26
A44	USB_2_3_OC#	B44	USB_0_1_OC#	C44	PCI_C/BE3#	D44	PCI_AD28
A45	USB0-	B45	USB1-	C45	PCI_AD25	D45	PCI_AD30
A46	USB0+	B46	USB1+	C46	PCI_AD27	D46	PCI_IRQC#
A47	VCC_RTC	B47	EXCD1_PERTST#	C47	PCI_AD29	D47	PCI_IRQD#
A48	EXCD0_PERTST#	B48	EXCD1_CPPE#	C48	PCI_AD31	D48	NC
A49	EXCD0CPPE#	B49	SYS_RESET#	C49	PCI_IRQA#	D49	NC
A50	LPC_SERIRQ	B50	CB_RESET#	C50	PCI_IRQB3	D50	PCI_CLK

Row A		Row B		Row C		Row D	
Pin	Signal	Pin	Signal	Pin	Signal	Pin	Signal
A51	GND (FIXED)	B51	GND (FIXED)	C51	GND (FIXED)	D51	GND (FIXED)
A52	NC	B52	NC	C52	PEG_RX0+	D52	PEG_TX0+
A53	NC	B53	NC	C53	PEG_RX0-	D53	PEG_TX0-
A54	GPIO	B54	GPO1	C54	NC	D54	PEG_LANE_RV#
A55	NC	B55	NC	C55	PEG_RX1+	D55	PEG_TX1+
A56	NC	B56	NC	C56	PEG_RX1-	D56	PEG_TX1-
A57	GND	B57	GPO2	C57	NC	D57	NC
A58	PCIE_TX3+	B58	PCIE_RX3+	C58	PEG_RX2+	D58	PEG_TX2+
A59	PCIE_TX3-	B59	PCIE_RX3-	C59	PEG_RX2-	D59	PEG_TX2-
A60	GND (FIXED)	B60	GND (FIXED)	C60	GND (FIXED)	D60	GND (FIXED)
A61	PCIE_TX2+	B61	PCIE_RX2+	C61	PEG_RX3+	D61	PEG_TX3+
A62	PCIE_TX2-	B62	PCIE_RX2-	C62	PEG_RX3-	D62	PEG_TX3-
A63	GPIO	B63	GPO3	C63	RSVD	D63	RSVD
A64	PCIE_TX1+	B64	PCIE_RX1+	C64	RSVD	D64	RSVD
A65	PCIE_TX1-	B65	PCIE_RX1-	C65	PEG_RX4+	D65	PEG_TX4+
A66	GND	B66	WAKE0#	C66	PEG_RX4-	D66	PEG_TX4-
A67	GPIO	B67	WAKE1#	C67	RSVD	D67	GND
A68	PCIE_TX0+	B68	PCIE_RX0+	C68	PEG_RX5+	D68	PEG_TX5+
A69	PCIE_TX0-	B69	PCIE_RX0-	C69	PEG_RX5-	D69	PEG_TX5-
A70	GND (FIXED)	B70	GND (FIXED)	C70	GND (FIXED)	D70	GND (FIXED)
A71	LVDS_A0+	B71	LVDS_B0+	C71	PEG_RX6+	D71	PEG_TX9+
A72	LVDS_A0-	B72	LVDS_B0-	C72	PEG_RX6-	D72	PEG_TX9-
A73	LVDS_A1+	B73	LVDS_B1+	C73	SDVO_DATA	D73	SDVO_CLK
A74	LVDS_A1-	B74	LVDS_B1-	C74	PEG_RX7+	D74	PEG_TX7+
A75	LVDS_A2+	B75	LVDS_B2+	C75	PEG_RX7-	D75	PEG_TX7-
A76	LVDS_A2-	B76	LVDS_B2-	C76	GND	D76	GND
A77	LVDS_VDD_EN	B77	NC	C77	RSVD	D77	IDE_CBLID#
A78	NC	B78	NC	C78	PEG_RX8+	D78	PEG_TX8+
A79	NC	B79	LVDS_BKLT_EN	C79	PEG_RX8-	D79	PEG_TX8-
A80	GND (FIXED)	B80	GND (FIXED)	C80	GND (FIXED)	D80	GND (FIXED)
A81	LVDS_A_CK+	B81	LVDS_B_CK+	C81	PEG_RX9+	D81	PEG_TX9+
A82	LVDS_A_CK-	B82	LVDS_B_CK-	C82	PEG_RX9-	D82	PEG_TX9-
A83	LVDS_I2C_CK	B83	LVDS_BKLT_Ctrl	C83	RSVD	D83	RSVD
A84	LVDS_I2C_DAT	B84	VCC_5V_SBY	C84	GND	D84	GND
A85	GPIO	B85	VCC_5V_SBY	C85	PEG_RX10+	D85	PEG_TX10+
A86	KBD_RSD#	B86	VCC_5V_SBY	C86	PEG_RX10-	D86	PEG_TX10-
A87	KBD_A2OGATE	B87	VCC_5V_SBY	C87	GND	D87	GND
A88	PCIE0_CK_REF+	B88	RSVD	C88	PEG_RX11+	D88	PEG_TX11+
A89	PCIE0_CK_REF-	B89	VGA_RED	C89	PEG_RX11-	D89	PEG_TX11-
A90	GND (FIXED)	B90	GND (FIXED)	C90	GND (FIXED)	D90	GND (FIXED)
A91	RSVD	B91	VGA_GRN	C91	PEG_RX12+	D91	PEG_TX12+
A92	RSVD	B92	VGA_BLU	C92	PEG_RX12-	D92	PEG_TX12-
A93	GPO0	B93	VGA_HSYNC	C93	GND	D93	GND
A94	RSVD	B94	VGA_VSYNC	C94	PEG_RX13+	D94	PEG_TX13+
A95	RSVD	B95	VGA_I2C_CK	C95	PEG_RX13-	D95	PEG_TX13-
A96	GND	B96	VGA_I2C_DATA	C96	GND	D96	GND
A97	VCC_12V	B97	TV_DAC_A	C97	RSVD	D97	PEG_ENABLE#
A98	VCC_12V	B98	TV_DAC_B	C98	PEG_RX14+	D98	PEG_TX14+
A99	VCC_12V	B99	TV_DAC_C	C99	PEG_RX14-	D99	PEG_TX14-
A100	GND (FIXED)	B100	GND (FIXED)	C100	GND (FIXED)	D100	GND (FIXED)
A101	VCC_12V	B101	VCC_12V	C101	PEG_RX15+	D101	PEG_TX15+
A103	VCC_12V	B103	VCC_12V	C103	PEG_RX15-	D103	PEG_TX15-
A103	VCC_12V	B103	VCC_12V	C103	GND	D103	GND
A104	VCC_12V	B104	VCC_12V	C104	VCC_12V	D104	VCC_12V
A105	VCC_12V	B105	VCC_12V	C105	VCC_12V	D105	VCC_12V
A106	VCC_12V	B106	VCC_12V	C106	VCC_12V	D106	VCC_12V
A107	VCC_12V	B107	VCC_12V	C107	VCC_12V	D107	VCC_12V
A108	VCC_12V	B108	VCC_12V	C108	VCC_12V	D108	VCC_12V
A109	VCC_12V	B109	VCC_12V	C109	VCC_12V	D109	VCC_12V
A110	GND (FIXED)	B110	GND (FIXED)	C110	GND (FIXED)	D110	GND (FIXED)

This page is intentionally left blank.

---

# BIOS Setup

This chapter describes the different settings available in the Award BIOS that comes with the board. The topics covered in this chapter are as follows:

BIOS Introduction .....	12
BIOS Setup .....	12
Standard CMOS Setup .....	14
Advanced BIOS Features .....	17
Advanced Chipset Features .....	20
Integrated Peripherals .....	23
Power Management Setup .....	27
PNP/PCI Configurations .....	30
PC Health Status .....	31
Frequency/Voltage Control .....	32
Load Fail-Safe Defaults .....	33
Load Optimized Defaults .....	33
Set Supervisor/User Password .....	33
Save & Exit Setup .....	33
Exit Without Saving .....	33

## BIOS Introduction

The Award BIOS (Basic Input/Output System) installed in your computer system's ROM supports Intel processors. The BIOS provides critical low-level support for a standard device such as disk drives, serial ports and parallel ports. It also adds virus and password protection as well as special support for detailed fine-tuning of the chipset controlling the entire system.

## BIOS Setup

The Award BIOS provides a Setup utility program for specifying the system configurations and settings. The BIOS ROM of the system stores the Setup utility. When you turn on the computer, the Award BIOS is immediately activated. Pressing the <Del> key immediately allows you to enter the Setup utility. If you are a little bit late pressing the <Del> key, POST (Power On Self Test) will continue with its test routines, thus preventing you from invoking the Setup. If you still wish to enter Setup, restart the system by pressing the "Reset" button or simultaneously pressing the <Ctrl>, <Alt> and <Delete> keys. You can also restart by turning the system Off and back On again. The following message will appear on the screen:

```
Press <DEL> to Enter Setup
```

In general, you press the arrow keys to highlight items, <Enter> to select, the <PgUp> and <PgDn> keys to change entries, <F1> for help and <Esc> to quit.

When you enter the Setup utility, the Main Menu screen will appear on the screen. The Main Menu allows you to select from various setup functions and exit choices.



## Phoenix - AwardBIOS CMOS Setup Utility

Standard CMOS Features	Frequency/Voltage Control
Advanced BIOS Features	Load Fail-Safe Defaults
Advanced Chipset Features	Load Optimized Defaults
Integrated Peripherals	Set Supervisor Password
Power Management Setup	Set User Password
PnP/PCI Configurations	Save & Exit Setup
PC Health Status	Exit Without Saving
ESC : Quit	↑ ↓ → ← : Select Item
F10 : Save & Exit Setup	
Time, Date, Hard Disk Type...	

The section below the setup items of the Main Menu displays the control keys for this menu. At the bottom of the Main Menu just below the control keys section, there is another section, which displays information on the currently highlighted item in the list.

**Note:** *If the system cannot boot after making and saving system changes with Setup, the Award BIOS supports an override to the CMOS settings that resets your system to its default.*

**Warning:** *It is strongly recommended that you avoid making any changes to the chipset defaults. These defaults have been carefully chosen by both Award and your system manufacturer to provide the absolute maximum performance and reliability. Changing the defaults could cause the system to become unstable and crash in some cases.*

## Standard CMOS Setup

“Standard CMOS Setup” choice allows you to record some basic hardware configurations in your computer system and set the system clock and error handling. If the board is already installed in a working system, you will not need to select this option. You will need to run the Standard CMOS option, however, if you change your system hardware configurations, the onboard battery fails, or the configuration stored in the CMOS memory was lost or damaged.

Phoenix - AwardBIOS CMOS Setup Utility  
Standard CMOS Features

Date (mm:dd:yy)	Wed, Apr 28, 2004	Item Help
Time (hh:mm:ss)	00 : 00 : 00	Menu Level >
IDE Channel 0 Master	None	Change the day, month, Year and century
IDE Channel 0 Slave	None	
IDE Channel 1 Master	None	
IDE Channel 1 Slave	None	
Drive A	1.44M, 3.5 in.	
Drive B	None	
Video	EGA/VGA	
Halt On	All Errors	
Base Memory	640K	
Extended Memory	129024K	
Total Memory	130048K	

At the bottom of the menu are the control keys for use on this menu. If you need any help in each item field, you can press the <F1> key. It will display the relevant information to help you. The memory display at the lower right-hand side of the menu is read-only. It will adjust automatically according to the memory changed. The following describes each item of this menu.

### Date

The date format is:

**Day :** Sun to Sat  
**Month :** 1 to 12  
**Date :** 1 to 31  
**Year :** 1999 to 2099

To set the date, highlight the “Date” field and use the PageUp/PageDown or +/- keys to set the current time.

### Time

The time format is: **Hour : 00 to 23**  
**Minute : 00 to 59**  
**Second : 00 to 59**

To set the time, highlight the “Time” field and use the <PgUp>/<PgDn> or +/- keys to set the current time.

### IDE Channel Master/Slave

The onboard PCI IDE connector provides Primary and Secondary channels for connecting up to two IDE hard disks or other IDE devices.

Press <Enter> to configure the hard disk. The selections include Auto, Manual, and None. Select ‘Manual’ to define the drive information manually. You will be asked to enter the following items.

**CYLS :** Number of cylinders  
**HEAD :** Number of read/write heads  
**PRECOMP :** Write precompensation  
**LANDING ZONE :** Landing zone  
**SECTOR :** Number of sectors

The Access Mode selections are as follows:

CHS (HD < 528MB)  
 LBA (HD > 528MB and supports  
 Logical Block Addressing)  
 Large (for MS-DOS only)  
 Auto

**Remarks:** The main board supports two serial ATA ports and are represented in this setting as IDE Channel 0.

### Drive A / Drive B

These fields identify the types of floppy disk drive A or drive B that has been installed in the computer. The available specifications are:

360KB 1.2MB 720KB 1.44MB 2.88MB  
 5.25 in. 5.25 in. 3.5 in. 3.5 in. 3.5 in.

### Video

This field selects the type of video display card installed in your system.

You can choose the following video display cards:

EGA/VGA	For EGA, VGA, SEGA, SVGA or PGA monitor adapters. (default)
CGA 40	Power up in 40 column mode.
CGA 80	Power up in 80 column mode.
MONO	For Hercules or MDA adapters.

### Halt On

This field determines whether or not the system will halt if an error is detected during power up.

No errors	The system boot will not be halted for any error that may be detected.
All errors	Whenever the BIOS detects a non-fatal error, the system will stop and you will be prompted.
All, But Keyboard	The system boot will not be halted for a keyboard error; it will stop for all other errors
All, But Diskette	The system boot will not be halted for a disk error; it will stop for all other errors.
All, But Disk/Key	The system boot will not be halted for a keyboard or disk error; it will stop for all others.

## Advanced BIOS Features

This section allows you to configure and improve your system and allows you to set up some system features according to your preference.

Phoenix - AwardBIOS CMOS Setup Utility  
Advanced BIOS Features

CPU Feature	Press Enter	ITEM HELP
Hard Disk Boot Priority	Press Enter	
Virus Warning	Disabled	Menu Level >
CPU L1 and L2 Cache	Enabled	
Quick Power On Self Test	Enabled	
First Boot Device	Floppy	
Second Boot Device	Hard Disk	
Third Boot Device	CDROM	
Boot Other Device	Enabled	
Swap Floppy Drive	Disabled	
Boot Up Floppy Seek	Disabled	
Boot Up NumLock Status	On	
Gate A20 Option	Fast	
Typeomatic Rate Setting	Disabled	
Typeomatic Rate (Chars/Sec)	6	
Typeomatic Delay (Msec)	250	
Security Option	Setup	
APIC Mode	Enabled	
MPS Version Control for OS	1.4	
OS Select For DRAM>64MB	Non-OS2	
Report No FDD For WIN 95	Yes	
Small Logo (EPA) Show	Enabled	

### CPU Feature

Press Enter to configure the settings relevant to CPU Feature.

### Hard Disk Boot Priority

With the field, there is the option to choose, aside from the hard disks connected, "Bootable add-in Cards" which refers to other external devices.

### Virus Warning

If this option is enabled, an alarm message will be displayed when trying to write on the boot sector or on the partition table on the disk, which is typical of the virus.

### CPU L1 and L2 Cache

Cache memory is additional memory that is faster than conventional DRAM (system memory). CPUs from 486-type on up contain internal cache memory, and most, but not all, modern PCs have additional (external) cache memory. When the CPU requests data, the system transfers the requested data from the main DRAM into cache memory, for even faster access by the CPU. These allow you to enable (speed up memory access) or disable the cache function.

### **Quick Power On Self Test**

When enabled, this field speeds up the Power On Self Test (POST) after the system is turned on. If it is set to *Enabled*, BIOS will skip some items.

### **First/Second/Third Boot Device**

These fields determine the drive that the system searches first for an operating system. The options available include *Floppy*, *LS120*, *Hard Disk*, *CDROM*, *ZIP100*, *USB-Floppy*, *USB-ZIP*, *USB-CDROM*, *LAN* and *Disable*.

### **Boot Other Device**

These fields allow the system to search for an OS from other devices other than the ones selected in the First/Second/Third Boot Device.

### **Swap Floppy Drive**

This item allows you to determine whether or not to enable Swap Floppy Drive. When enabled, the BIOS swaps floppy drive assignments so that Drive A becomes Drive B, and Drive B becomes Drive A. By default, this field is set to *Disabled*.

### **Boot Up Floppy Seek**

This feature controls whether the BIOS checks for a floppy drive while booting up. If it cannot detect one (either due to improper configuration or its absence), it will flash an error message.

### **Boot Up NumLock Status**

This allows you to activate the NumLock function after you power up the system.

### **Gate A20 Option**

This field allows you to select how Gate A20 is worked. Gate A20 is a device used to address memory above 1 MB.

### **Typematic Rate Setting**

When disabled, continually holding down a key on your keyboard will generate only one instance. When enabled, you can set the two typematic controls listed next. By default, this field is set to *Disabled*.

### **Typematic Rate (Chars/Sec)**

When the typematic rate is enabled, the system registers repeated keystrokes speeds. Settings are from 6 to 30 characters per second.

### **Typematic Delay (Msec)**

When the typematic rate is enabled, this item allows you to set the time interval for displaying the first and second characters. By default, this item is set to *250msec*.

### **Security Option**

This field allows you to limit access to the System and Setup. The default value is *Setup*. When you select *System*, the system prompts for the User Password every time you boot up. When you select *Setup*, the system always boots up and prompts for the Supervisor Password only when the Setup utility is called up.

### **APIC Mode**

APIC stands for Advanced Programmable Interrupt Controller. The default setting is *Enabled*.

### **MPS Version Control for OS**

This option specifies the MPS (Multiprocessor Specification) version for your operating system. MPS version 1.4 added extended configuration tables to improve support for multiple PCI bus configurations and improve future expandability. The default setting is *1.4*.

### **OS Select for DRAM > 64MB**

This option allows the system to access greater than 64MB of DRAM memory when used with OS/2 that depends on certain BIOS calls to access memory. The default setting is *Non-OS/2*.

### **Report No FDD For WIN 95**

If you are using Windows 95/98 without a floppy disk drive, select *Enabled* to release IRQ6. This is required to pass Windows 95/98's SCT test. You should also disable the Onboard FDC Controller in the Integrated Peripherals screen when there's no floppy drive in the system. If you set this feature to *Disabled*, the BIOS will not report the missing floppy drive to Win95/98.

### **Small Logo (EPA) Show**

The EPA logo appears at the right side of the monitor screen when the system is boot up. The default setting is *Enabled*.

## Advanced Chipset Features

This Setup menu controls the configuration of the chipset.

Phoenix - AwardBIOS CMOS Setup Utility  
Advanced Chipset Features

		ITEM HELP
DRAM Timing Selectable	By SPD	Menu Level >
CAS Latency Time	4	
DRAM RAS# to CAS# Delay	4	
DRAM RAS# Precharge	4	
Precharge delay (tRAS)	12	
System Memory Frequency	533MHZ	
SLP_S4# Assertion Width	1 to 2 Sec	
System BIOS Cacheable	Enabled	
Video BIOS Cacheable	Disabled	
Memory Hole at 15M-16M	Disabled	
PCI Express Root Port Func	Press Enter	
** On-Chip VGA Setting **		
PEG/On Chip VGA Control	Auto	
On-Chip Frame Buffer Size	8MB	
DVMT Mode	DVMT	
DVMT/FIXED memory Size	128MB	
Boot Display	Auto	
Panel Scaling	Auto	
Panel Number	1024x768 18 bit SC	
TV Standard	Off	
Video Connector	Automatic	
TV Format	Auto	

### DRAM Timing Selectable

This option refers to the method by which the DRAM timing is selected. The default is *By SPD*.

### CAS Latency Time

You can configure CAS latency time in HCLKs as 2 or 2.5 or 3. The system board designer should set the values in this field, depending on the DRAM installed. Do not change the values in this field unless you change specifications of the installed DRAM or the installed CPU.

### DRAM RAS# to CAS# Delay

This option allows you to insert a delay between the RAS (Row Address Strobe) and CAS (Column Address Strobe) signals. This delay occurs when the SDRAM is written to, read from or refreshed. Reducing the delay improves the performance of the SDRAM.



**DRAM RAS# Precharge**

This option sets the number of cycles required for the RAS to accumulate its charge before the SDRAM refreshes. The default setting for the Active to Precharge Delay is **4**.

**Precharge Delay (tRAS)**

The default setting for the Precharge Delay is **12**.

**System Memory Frequency**

The default setting is **533MHz**.

**SLP\_S4# Assertion Width**

The default setting is **1 to 2 Sec**.

**System BIOS Cacheable**

The setting of *Enabled* allows caching of the system BIOS ROM at F000h-FFFFh, resulting in better system performance. However, if any program writes to this memory area, a system error may result.

**Video BIOS Cacheable**

The Setting *Enabled* allows caching of the video BIOS ROM at C0000h-F7FFFh, resulting in better video performance. However, if any program writes to this memory area, a system error may result.

**Memory Hole At 15M-16M**

In order to improve performance, certain space in memory can be reserved for ISA cards. This memory must be mapped into the memory space below 16 MB. The choices are *Enabled* and *Disabled*.

**On-Chip VGA Setting**

The fields under the On-Chip VGA Setting and their default settings are:

- PEG/On Chip VGA Control: Auto
- On-Chip Frame Buffer Size: 8MB
- DVMT Mode: DVTM
- DVMT/Fixed Memory Size: 128MB
- Boot Display: Auto
- Panel Scaling: Auto
- Panel Number: 1024x768 18 bit SC
- TV Standard: Off
- Video Connector: Automatic
- TV Format: Auto

### Panel Scaling

The default setting is *Auto*. The options available include *On* and *Off*.

### Panel Number

These fields allow you to select the LCD Panel type. The default values for these ports are:

640x480	18bit SC
800x480	18bit SC
800x600	18bit SC
1024x768	18bit SC
1280x1024	18bit DC
1280x768	18bit SC
1400x1050	18bit DC
1600x1200	18bit DC

## Integrated Peripherals

This section sets configurations for your hard disk and other integrated peripherals. The first screen shows three main items for user to select. Once an item selected, a submenu appears. Details follow.

Phoenix - AwardBIOS CMOS Setup Utility  
Integrated Peripherals

OnChip IDE Device	Press Enter	ITEM HELP
Onboard Device	Press Enter	Menu Level >
SuperIO Device	Press Enter	

Phoenix - AwardBIOS CMOS Setup Utility  
**OnChip IDE Device**

IDE HDD Block Mode	Enabled	ITEM HELP
On-chip Primary PCI IDE	Enabled	Menu Level >
IDE Primary Master PIO	Auto	
IDE Primary Slave PIO	Auto	
IDE Primary Master UDMA	Auto	
IDE Primary Slave UDMA	Auto	
On-Chip Secondary PCI IDE	Enabled	
IDE Secondary Master PIO	Auto	
IDE Secondary Slave PIO	Auto	
IDE Secondary Master UDMA	Auto	
IDE Secondary Slave UDMA	Auto	
*** On-Chip Serial ATA Setting ***		
On-Chip Serial ATA	Auto	
PATA IDE Mode	Secondary	
SATA port	P0, P2 is Primary	

Phoenix - AwardBIOS CMOS Setup Utility  
**Onboard Device**

USB Controller	Enabled	ITEM HELP
USB 2.0 Controller	Enabled	Menu Level >
USB Keyboard Support	Disabled	
AC97 Audio Select	Auto	

Phoenix - AwardBIOS CMOS Setup Utility  
**SuperIO Device**

		ITEM HELP
POWER ON Function	BUTTON ONLY	
KB Power ON Password	Enter	
Hot Key power ON	Ctrl-F1	
Onboard FDC Controller	Enabled	
Onboard Serial Port 1	3F8/IRQ4	Menu Level >
Onboard Serial Port 2	2F8/IRQ3	
UART Mode Select	Normal	
RxD , TxD Active	Hi, Lo	
IR Transmission Delay	Disabled	
UR2 Duplex Mode	Half	
Use IR Pins	IR-Rx2Tx2	
PWRON After PWR-Fail	Off	

**IDE HDD Block Mode**

This field allows your hard disk controller to use the fast block mode to transfer data to and from your hard disk drive.

**On-chip Primary PCI IDE Enabled**

This field, by default, is enabled

**OnChip Primary/Secondary PCI IDE**

The integrated peripheral controller contains an IDE interface with support for two IDE channels. Select *Enabled* to activate each channel separately.

**IDE Primary/Secondary Master/Slave PIO**

These fields allow your system hard disk controller to work faster. Rather than have the BIOS issue a series of commands that transfer to or from the disk drive, PIO (Programmed Input/Output) allows the BIOS to communicate with the controller and CPU directly.

The system supports five modes, numbered from 0 (default) to 4, which primarily differ in timing. When Auto is selected, the BIOS will select the best available mode.

**IDE Primary/Secondary Master/Slave UDMA**

These fields allow your system to improve disk I/O throughput to 33Mb/sec with the Ultra DMA/33 feature. The options are *Auto* and *Disabled*.

### **On-Chip Serial ATA Setting**

The fields under the SATA setting includes On-Chip Serial ATA (Auto), PATA IDE Mode (Secondary) and SATA Port (PO, P2 is Primary).

### **USB Controller**

The options for this field are *Enabled* and *Disabled*. By default, this field is set to *Enabled*.

### **USB 2.0 Controller**

The options for this field are *Enabled* and *Disabled*. By default, this field is set to *Enabled*. In order to use USB 2.0, necessary OS drivers must be installed first. *Please update your system to Windows 2000 SP4 or Windows XP SP2.*

### **USB Keyboard Support**

The options for this field are *Enabled* and *Disabled*. By default, this field is set to *Disabled*.

### **AC97 Audio Select**

This field, by default, is set to *Auto*.

### **Power ON Function**

This field is related to how the system is powered on – such as with the use of conventional power button, keyboard or hot keys. The default is *BUTTON ONLY*.

### **KB Power ON Password**

This field allows users to set the password when keyboard power on is the mode of the Power ON function.

### **Hot Key Power ON**

This field sets certain keys, also known as hot keys, on the keyboard that can be used as a ‘switch’ to power on the system.

### **Onboard FDC Controller**

Select *Enabled* if your system has a floppy disk controller (FDC) installed on the main board and you wish to use it. If you install an add-in FDC or the system has no floppy drive, select *Disabled* in this field. This option allows you to select the onboard FDD port.

### **Onboard Serial Port**

These fields allow you to select the onboard serial ports and their addresses. The default values for these ports are:

Serial Port 1	3F8/IRQ4
Serial Port 2	2F8/IRQ3

### **UART Mode Select**

This field determines the UART 2 mode in your computer. The default value is *Normal*. Other options include *IrDA* and *ASKIR*.

### **PWRON After PWR-Fail**

This field sets the system power status whether *on* or *off* when power returns to the system from a power failure situation.

## Power Management Setup

Phoenix - AwardBIOS CMOS Setup Utility  
Power Management Setup

ACPI Function	Enabled	ITEM HELP
ACPI Suspend	S1(POS)	
RUN VGABIOS if S3 Resume	Auto	Menu Level >
Power Management	User Define	
Video Off Method	DPMS	
Video Off In Suspend	Yes	
Suspend Type	Stop Grant	
Modem Use IRQ	3	
Suspend Mode	Disabled	
HDD Power Down	Disabled	
Soft-Off by PWR-BTTN	Instant-Off	
Wake-Up by PCI Card	Disabled	
Power On by Ring	Disabled	
Resume by Alarm	Disabled	
Date (of Month) Alarm	0	
Time (hh:mm:ss) Alarm	0 : 0 : 0	
** Reload Global Timer Events **		
Primary IDE 0	Disabled	
Primary IDE 1	Disabled	
Secondary IDE 0	Disabled	
Secondary IDE 1	Disabled	
FDD, COM, LPT Port	Disabled	
PCI PIRQ[A-D] #	Disabled	

### ACPI Function

Enable this function to support ACPI (Advance Configuration and Power Interface).

### ACPI Suspend

The default setting of the ACPI Suspend mode is *SI(POS)*.

### RUN VGABIOS if S3 Resume

The default setting of this field is *Auto*.

### Power Management

This field allows you to select the type of power saving management modes. There are four selections for Power Management.

Min. Power Saving	Minimum power management
Max. Power Saving	Maximum power management.
User Define	Each of the ranges is from 1 min. to 1hr. Except for HDD Power Down which ranges from 1 min. to 15 min.

### Video Off Method

This field defines the Video Off features. There are three options.

V/H SYNC + Blank	Default setting, blank the screen and turn off vertical and horizontal scanning.
DPMS	Allows BIOS to control the video display.
Blank Screen	Writes blanks to the video buffer.

### Video Off In Suspend

When enabled, the video is off in suspend mode. The default setting is *Yes*.

### Suspend Type

The default setting for the Suspend Type field is *Stop Grant*.

### Modem Use IRQ

This field sets the IRQ used by the Modem. By default, the setting is **3**.

### Suspend Mode

When enabled, and after the set time of system inactivity, all devices except the CPU will be shut off.

### HDD Power Down

When enabled, and after the set time of system inactivity, the hard disk drive will be powered down while all other devices remain active.

### Soft-Off by PWRBTN

This field defines the power-off mode when using an ATX power supply. The *Instant Off* mode allows powering off immediately upon pressing the power button. In the *Delay 4 Sec* mode, the system powers off when the power button is pressed for more than four seconds or enters the suspend mode when pressed for less than 4 seconds.

### Wake up by PCI Card

By default, this field is disabled.

### Power On by Ring

This field enables or disables the power on of the system through the modem connected to the serial port or LAN.



**Resume by Alarm**

This field enables or disables the resumption of the system operation. When enabled, the user is allowed to set the *Date* and *Time*.

**Reload Global Timer Events**

The HDD, FDD, COM, LPT Ports, and PCI PIRQ are I/O events that can prevent the system from entering a power saving mode or can awaken the system from such a mode. When an I/O device wants to gain the attention of the operating system, it signals this by causing an IRQ to occur. When the operating system is ready to respond to the request, it interrupts itself and performs the service.

## PNP/PCI Configurations

This option configures the PCI bus system. All PCI bus systems on the system use INT#, thus all installed PCI cards must be set to this value.

Phoenix - AwardBIOS CMOS Setup Utility  
PnP/PCI Configurations

Init Display First	PCI Slot	ITEM HELP
Reset Configuration Data	Disabled	
Resources Controlled By	Auto (ESCD)	Menu Level
IRQ Resources	Press Enter	Select Yes if you are using a Plug and Play capable operating system Select No if you need the BIOS to configure non-boot devices
PCI/VGA Palette Snoop	Disabled	
INT Pin 1 Assignment	Auto	
INT Pin 2 Assignment	Auto	
INT Pin 3 Assignment	Auto	
INT Pin 4 Assignment	Auto	
INT Pin 5 Assignment	Auto	
INT Pin 6 Assignment	Auto	
INT Pin 7 Assignment	Auto	
INT Pin 8 Assignment	Auto	
**PCI Express relative items**		
Maximum Payload Size	4096	

### Init Display First

The default setting is *PCI Card*.

### Reset Configuration Data

This field allows you to determine whether to reset the configuration data or not. The default value is *Disabled*.

### Resources Controlled by

This PnP BIOS can configure all of the boot and compatible devices with the use of a PnP operating system such as Windows 95.

### PCI/VGA Palette Snoop

Some non-standard VGA display cards may not show colors properly. This field allows you to set whether or not MPEG ISA/VESA VGA cards can work with PCI/VGA. When this field is enabled, a PCI/VGA can work with an MPEG ISA/VESA VGA card. When this field is disabled, a PCI/VGA cannot work with an MPEG ISA/VESA card.

### Maximum Payload Size

The default setting of the PCI Express Maximum Payload Size is 4096.

## PC Health Status

This section shows the parameters in determining the PC Health Status. These parameters include temperatures, fan speeds and voltages.

Phoenix - AwardBIOS CMOS Setup Utility  
PC Health Status

		ITEM HELP
CPU Warning Temperature	Disabled	
Current System Temp	45°C/113°F	
Current CPU Temp	45°C/113°F	
Vcore(V)	1.02 V	
Vcc3	3.3V	
Shutdown Temperature	Disabled	
System FAN Speed	5400 RPM	
CPU FAN Speed	5400 RPM	
		Menu Level >

### CPU Warning Temperature

This field allows the user to set the temperature so that when the temperature is reached, the system sounds a warning. This function can help prevent damage to the system that is caused by overheating.

### Temperatures/Voltages

These fields are the parameters of the hardware monitoring function feature of the main board. The values are read-only values as monitored by the system and show the PC health status.

### Shutdown Temperature

This field allows the user to set the temperature by which the system automatically shuts down once the threshold temperature is reached. This function can help prevent damage to the system that is caused by overheating.

## Frequency/Voltage Control

This section shows the user how to configure the processor frequency.

Phoenix - AwardBIOS CMOS Setup Utility  
Frequency/Voltage Control

Auto Detect PCI Clk	Disabled	ITEM HELP
Spread Spectrum Modulated	Disabled	Menu Level >

### Auto Detect PCI Clk

This field enables or disables the auto detection of the PCI clock.

### Spread Spectrum Modulated

This field sets the value of the spread spectrum. The default setting is *Disabled*. This field is for CE testing use only.

### **Load Fail-Safe Defaults**

This option allows you to load the troubleshooting default values permanently stored in the BIOS ROM. These default settings are non-optimal and disable all high-performance features.

### **Load Optimized Defaults**

This option allows you to load the default values to your system configuration. These default settings are optimal and enable all high performance features.

### **Set Supervisor Password**

These two options set the system password. Supervisor Password sets a password that will be used to protect the system and Setup utility. User Password sets a password that will be used exclusively on the system. To specify a password, highlight the type you want and press <Enter>. The Enter Password: message prompts on the screen. Type the password, up to eight characters in length, and press <Enter>. The system confirms your password by asking you to type it again. After setting a password, the screen automatically returns to the main screen.

To disable a password, just press the <Enter> key when you are prompted to enter the password. A message will confirm the password to be disabled. Once the password is disabled, the system will boot and you can enter Setup freely.

### **Save & Exit Setup**

This option allows you to determine whether or not to accept the modifications. If you type “Y”, you will quit the setup utility and save all changes into the CMOS memory. If you type “N”, you will return to Setup utility.

### **Exit Without Saving**

Select this option to exit the Setup utility without saving the changes you have made in this session. Typing “Y” will quit the Setup utility without saving the modifications. Typing “N” will return you to Setup utility.

This page is intentionally left blank.

---

## Drivers Installation

This section describes the installation procedures for software and drivers under the Windows 98SE, Windows ME, Windows 2000 and Windows XP. The software and drivers are included with the main board. If you find the items missing, please contact the vendor where you made the purchase. The contents of this section include the following:

Intel Chipset Software Installation Utility.....	36
VGA Drivers Installation .....	38
AC97 Codec Audio Driver Installation (IP400 carrier board only) .....	40
Intel PRO LAN Drivers Installation.....	42
Marvell LAN Drivers Installation (IP400 carrier board only) .....	43

### **IMPORTANT NOTE:**

After installing your Windows operating system (Windows 98SE/ME/2000/XP), you must install first the Intel Chipset Software Installation Utility before proceeding with the drivers installation.

## Intel Chipset Software Installation Utility

The Intel Chipset Drivers should be installed first before the software drivers to enable Plug & Play INF support for Intel chipset components. Follow the instructions below to complete the installation under Windows 2000/XP.

1. Insert the CD that comes with the board. Click **Intel Chipsets** and then **Intel(R) I945GM Chipset Drivers**.
2. Click **Intel(R) Chipset Software Installation Utility**.

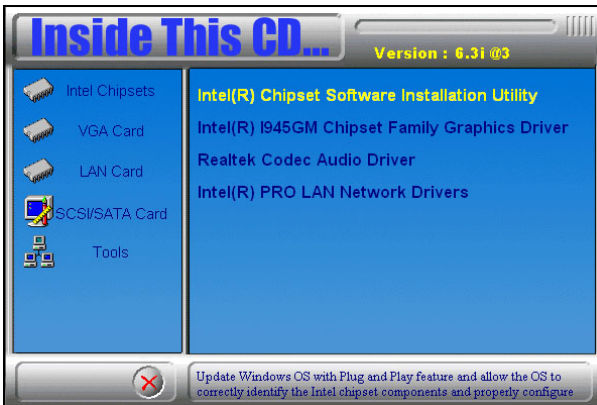
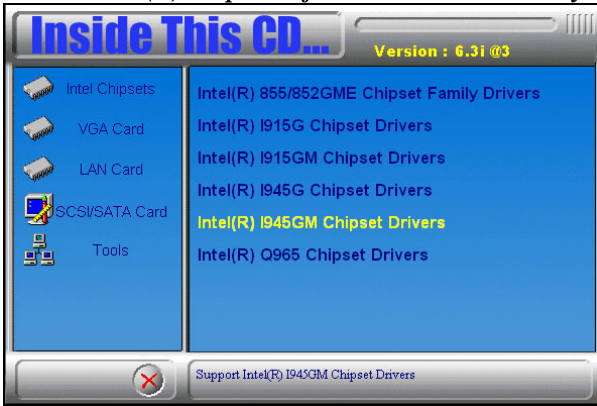



3. When the Welcome screen appears, click **Next** to continue.

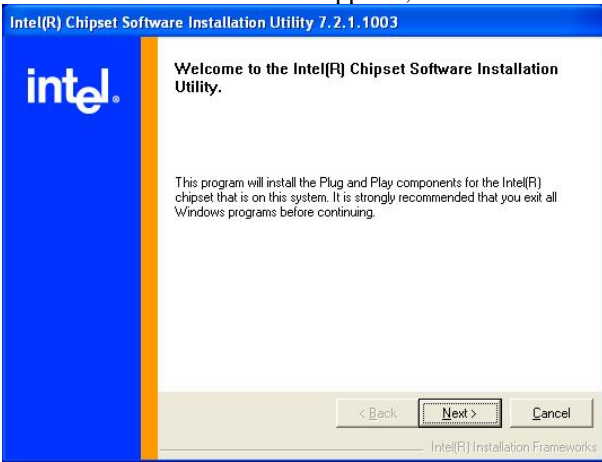

4. Click **Yes** to accept the software license agreement and proceed with the installation process.

5. On Readme Information screen, click **Next** to continue the installation.

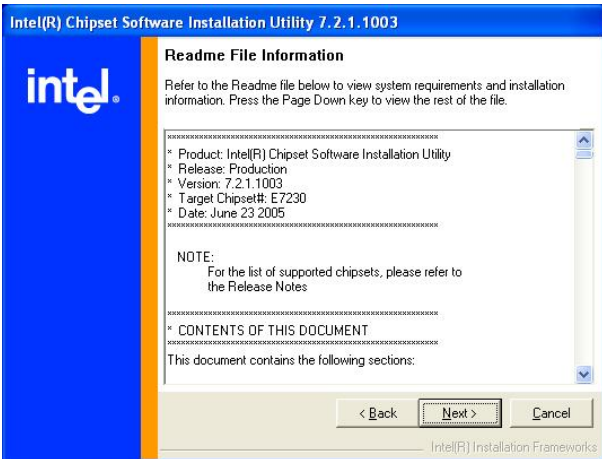

6. The Setup process is now complete. Click **Finish** to restart the computer and for changes to take effect. When the computer has restarted, the system will be able to find some devices. Restart your computer when prompted.

## VGA Drivers Installation

To install the VGA drivers, follow the steps below to proceed with the installation.

1. Insert the CD that comes with the board. Click *Intel Chipsets* and then *Intel(R) I945GM Chipset Drivers*.

2. Click *Intel(R) I945GM Chipset Family Graphics Driver*.

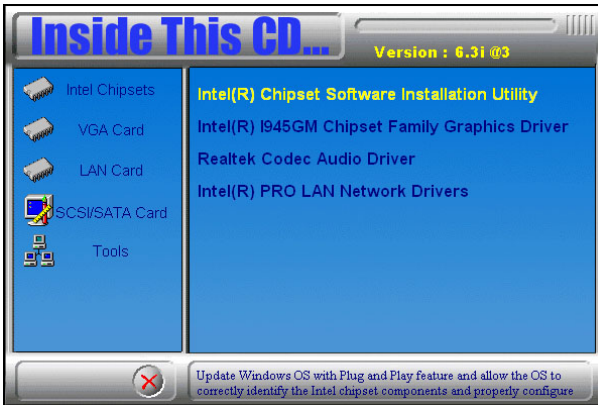
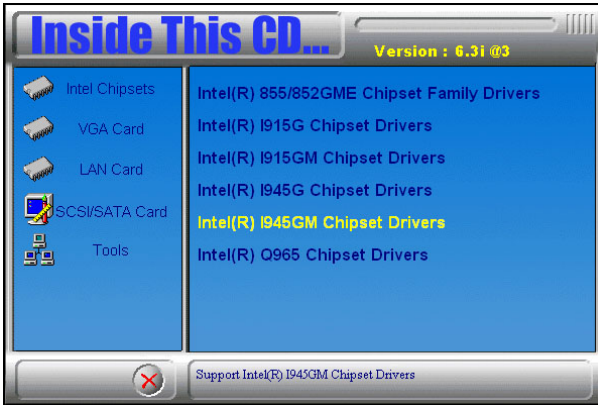

3. When the Welcome screen appears, click *Next* to continue.

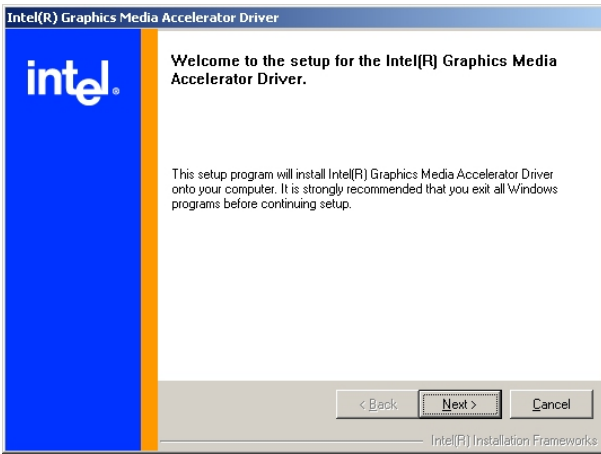

4. When the setup is complete, restart the computer as prompted and for changes to take effect.

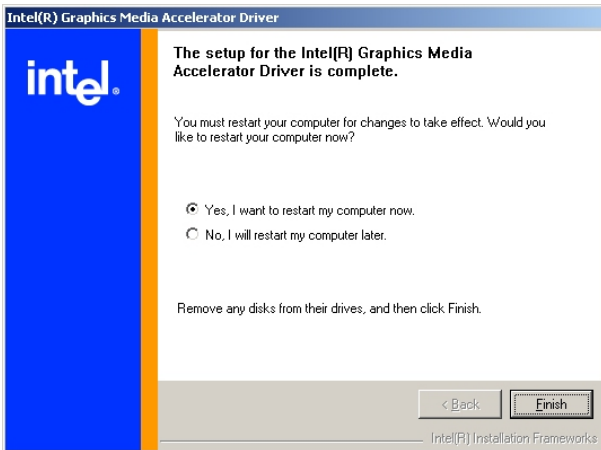

## AC97 Codec Audio Driver Installation (IP400 carrier board only)

Follow the steps below to install the Realtek AC97 Codec Audio Drivers.

1. Insert the CD that comes with the board. Click *Intel Chipsets* and then *Intel(R) I945GM Chipset Drivers*.

2. Click *Realtek Codec Audio Driver*.

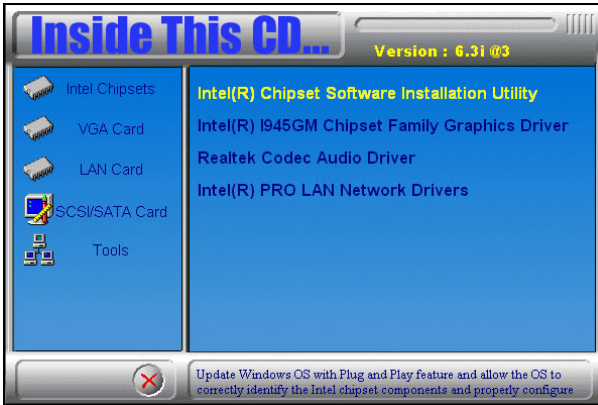

3. When the screen below appears, click *Yes* to continue with the installation.



4. Click **Finish** to restart the computer and for changes to take effect. .

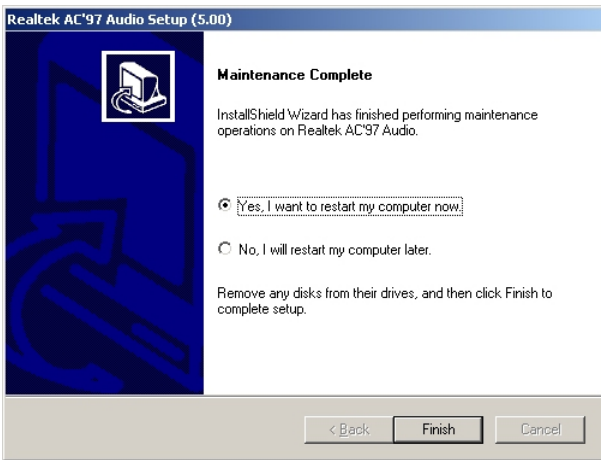

## Intel PRO LAN Drivers Installation

Follow the steps below to complete the installation of the Intel PRO LAN drivers.

1. Insert the CD that comes with the board. Click **Intel Chipsets** and then **Intel(R) I945GM Chipset Drivers**. Then, click **Intel(R) PRO LAN Network Drivers**.



2. Click **Install Base Software** to continue.



3. When prompted, please to restart the computer for new settings to take effect.

## Marvell LAN Drivers Installation (IP400 carrier board only)

Follow the steps below to complete the installation of the Intel PRO LAN drivers.

1. Insert the CD that comes with the board. Click **LAN Card** and then **Marvell LAN Controller Driver**.



2. When the Welcome screen appears, click **Next** to continue.



3. Click **Next** to agree with the license agreement.

4. When the Readme Information appears, click **Next** to continue
5. When the Ready to Install the Program appears, click **Install** to continue.
6. After the installation is complete, click **Finish**.

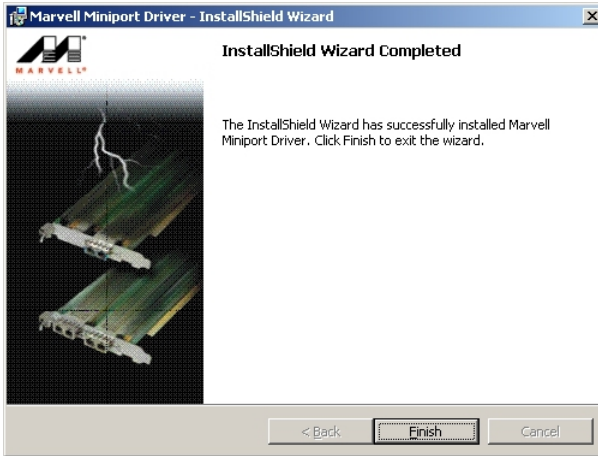

7. To use the wake up function with PCIe LAN, go to the **Device Manager under Windows** and select **LAN controller**. The window for **Generic Marvell Yukon Chipset based Ethernet Controller Properties** will appear. Click **Advanced** and select **Wake From Shutdown**. In the Value field on the right, select **On**.
8. Then, also in the **Advanced** section, click on **Wake Up Capabilities**. In the Value field on the right, select **Magic Packet**, then click **OK**.



## Free Manuals Download Website

<http://myh66.com>

<http://usermanuals.us>

<http://www.somanuals.com>

<http://www.4manuals.cc>

<http://www.manual-lib.com>

<http://www.404manual.com>

<http://www.luxmanual.com>

<http://aubethermostatmanual.com>

Golf course search by state

<http://golfingnear.com>

Email search by domain

<http://emailbydomain.com>

Auto manuals search

<http://auto.somanuals.com>

TV manuals search

<http://tv.somanuals.com>