

AR-B1890

Intel® Pentium® M / Celeron® M Socket 478 Processor

Mini-ITX Board

User's Manual

Rev. 1.0

June. 2006

Copyright

The trademarks mentioned in the manual are legally registered to their respective companies.

Notice

The written content provided with this product is the property of Acrosser. No part of this manual may be reproduced, copied, transmitted in any form or by any means without prior written permission of Acrosser.

Manual Classification

In order to assist in the use of this product, Acrosser has categorized the user manual. For detailed product information and specifications, please carefully read the “ Product User Manual ”.

Packing List

Please make sure that the following materials before you start installing your board.

- ☆ AR-B1890 board
- ☆ Quick Installation Guide
- ☆ CD for manual and drivers
- ☆ Cable Kit (CPU cooler, IDE cable, Serial ATA cable, Serial Port cable, Slim type floppy cable, I/O Shield)

Table Of Contents

General Information

Introduction.....	5
Specification.....	6
Block Diagram.....	8
Mechanical Drawing.....	9

Hardware Installation

Connectors Location.....	11
List of Connectors.....	13
Jumpers Locations.....	14
List of Jumpers.....	14
Jumpers Setting.....	15
LVDS Panel Voltage Selection (JP3).....	15
Clear CMOS Selection (JP5).....	15
COM2 RS232/422/485 Slection (JP6, JP7).....	16
VGA Display / Audio Connector (CN1).....	17
5.1 Channel Audio Connector (CN2).....	17
COM 3 RS-232 Connector (CN3).....	17
COM4 RS-232 Connector (CN4).....	18
CD - In Connector (CN5).....	18
TV - Out Connector (CN6).....	18
DVOB Connector (CN7).....	19
LVDS Connector (CN8).....	20
ATX Power Connector (CN9).....	20
IrDA Connector (CN10).....	21
System Fan Connector (CN11).....	21
Front Panel Connector (CN12).....	21
GPIO Connector (CN13).....	22
CPU Fan Connector (CN14).....	22
PS2 KB/ MS Connector (PS2-KBMS1 A / B).....	22
EIDE Connector (IDE1).....	23
USB Connector (USB1).....	23
Slim Floppy Connector (FDD1).....	24
COM1 RS-232 Connector (COM1).....	24
COM2 RS-232 / 422 / 485 Connector (COM2).....	24

Gigabit LAN / USB Connector (RJUSB1).....	25
Ethernet LAN / USB Connector (RJUSB2).....	25
Mini - PCI Slot (MPCI1).....	25
CompactFlash Slot (CFD1).....	25
SoDIMM Slot (DIMM1).....	25
SoDIMM Slot (DIMM 2).....	25
SATA1 Connector (SATA1).....	25
SATA2 Connector (SATA2).....	25
PCI - Express Slot (PCIE1).....	25

BIOS Setup

AwardBIOS CMOS Setup Utility.....	26
Standard CMOS Features.....	27
Advanced BIOS Features.....	29
Advanced Chipset Features.....	32
Integrated Peripherals.....	34
Power Management Setup.....	37
PnP / PCI Configurations.....	39
PC Health Status.....	40
Load Fail – Safe Defaults.....	41
Load Optimized Defaults.....	41
Set Supervisor / User Password.....	41
Save & Exit Setup.....	41
Exit Without Saving.....	41

Drivers Installation

Install Chipset Drivers.....	42
Install VGA drivers.....	42
Install AC97 Codec Audio Drivers.....	42
Install Marvell GigaLAN Drivers.....	42
Install Realtek Ethernet Drivers.....	42

General Information

Introduction

The AR-B1890 Mini – ITX board incorporates the Intel® 915GM Express and Intel® I / O controller Hub ICH6 - M chipset , supports the Intel® Pentium® M / Celeron® M processors with 533 / 400 MHz Front Side Bus (FSB), Intel® Graphics Media Accelerator 900 (Intel® GMA 900), DDRII 533 MHz system memory, PCI - Express interface, Ethernet / Gigabit LAN, Realtek Audio, LVDS, CompactFlash, Mini – PCI, Serial ATA, USB 2.0.

Multimedia Applications

For multimedia application solution, Intel® 915GM Express and ICH6 – M chipset provides on board high performance graphics, 18 – bit LVDS interface, HDTV TV – Out and Audio function. This feature will be good of use in very requirement of the multimedia application.

Widely Expanded Interface

The board provides PCI – Express x 1 slot, you can add a third LAN port, 6 ~ 8 COM Port, and also provides Mini – PCI slot and CompactFlash Type II slot.

Specification

Board	AR-B1890
CPU	Up to Intel® Pentium M 2.26G (400 / 533MHz FSB) Celeron® M 1.6G (400MHz FSB)
Chipset	Intel® 915GM Express chipset + ICH6 - M
Memory	DDR II SoDIMM slot support up to 2GB memory Support dual channel DDR II 400 / 533 SoDIMM
VGA	Built in Intel® 915GM GMCH Express chipset
I / O Control	Intel® ICH6 – M + ITE 8712 + Fintek F81216D
LAN	1 Realtek RTL8100C 10 / 100Mbit LAN 1 Marvell 88E8053 10 / 100 / 1000Mbit LAN
Audio	Intel® ICH6 – M with Realtek ALC655 Codec
IDE	UDMA 33 / 66 / 100 ATA IDE connection
FDD	1 Slim FDD connection
SATA	2 Serial ATA ports
Slot	1 Mini – PCI slot 1 CompactFlash slot 1 PCI – Express x 1 slot
BIOS	Phoenix – Award 4Mb PnP Flash
GPIO	8 – bit digital I / O
Green Function	ACPI 1.0 and APM 1.2 compliant
Watchdog Timer	System reset programmable watchdog timer with 1 ~ 255 Min. of time - out
H / W Monitoring	ITE 8712 support power supply voltage and temperature monitoring functions
Real Time Clock	Intel® ICH6 – M built – in RTC with Lithium battery
Form Factor	Mini – ITX 6.69 “(L) x 6.69” (W) / 17 x 17 mm

VGA Display

Chipset	Intel® 915GM GMCH Express chipset
Memory	Shared system memory up to 128MB
Display	CRT / LCD monitor with analog for 18 – bit dual channel LVDS interface
TV-OUT	Support PAL/NTSC

I / O Ports

Keyboard/ Mouse	1 PS / 2 ports
Serial	2 internal RS - 232 ports (COM 3 / 4) 1 external RS – 232 port (COM 1) 1 external RS – 232 / 422 / 485 port (COM 2)
VGA	1 VGA port
Audio	1 external jack for MIC – In / Line – In / Line – Out
LAN	2 external RJ – 45 ports with LED
USB	2 internal USB 2.0 ports 4 external USB 2.0 ports

Power And Environment

POWER	ATX power connector
TEMPERATURE	Operating temperature with 0°C~60°C (32°F~140°F) Storage temperature with 20°C~80°C (-68°F~176°F)

Block Diagram

Intel Pentium-M ITX Board

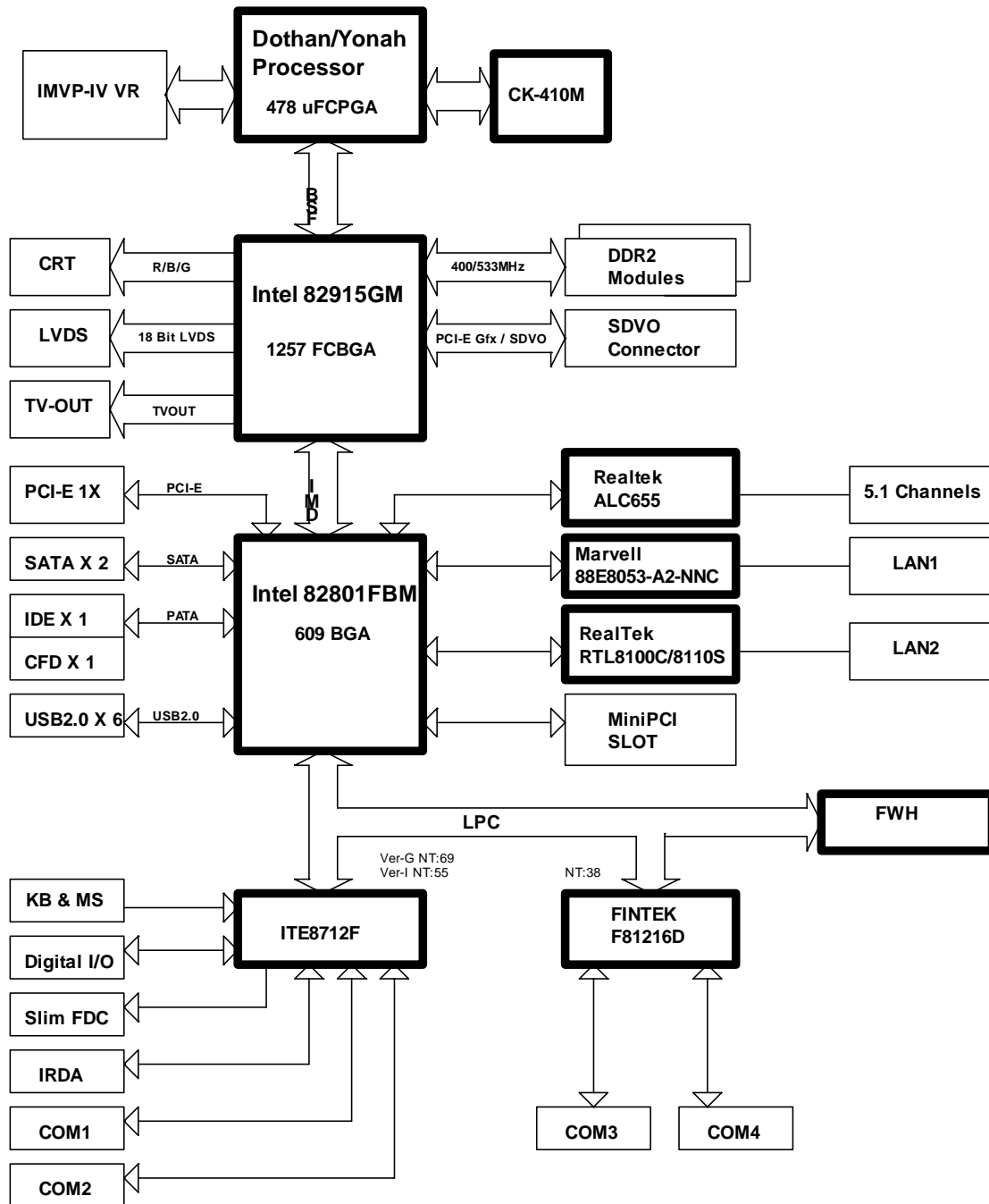

Mechanical Drawing

Component side

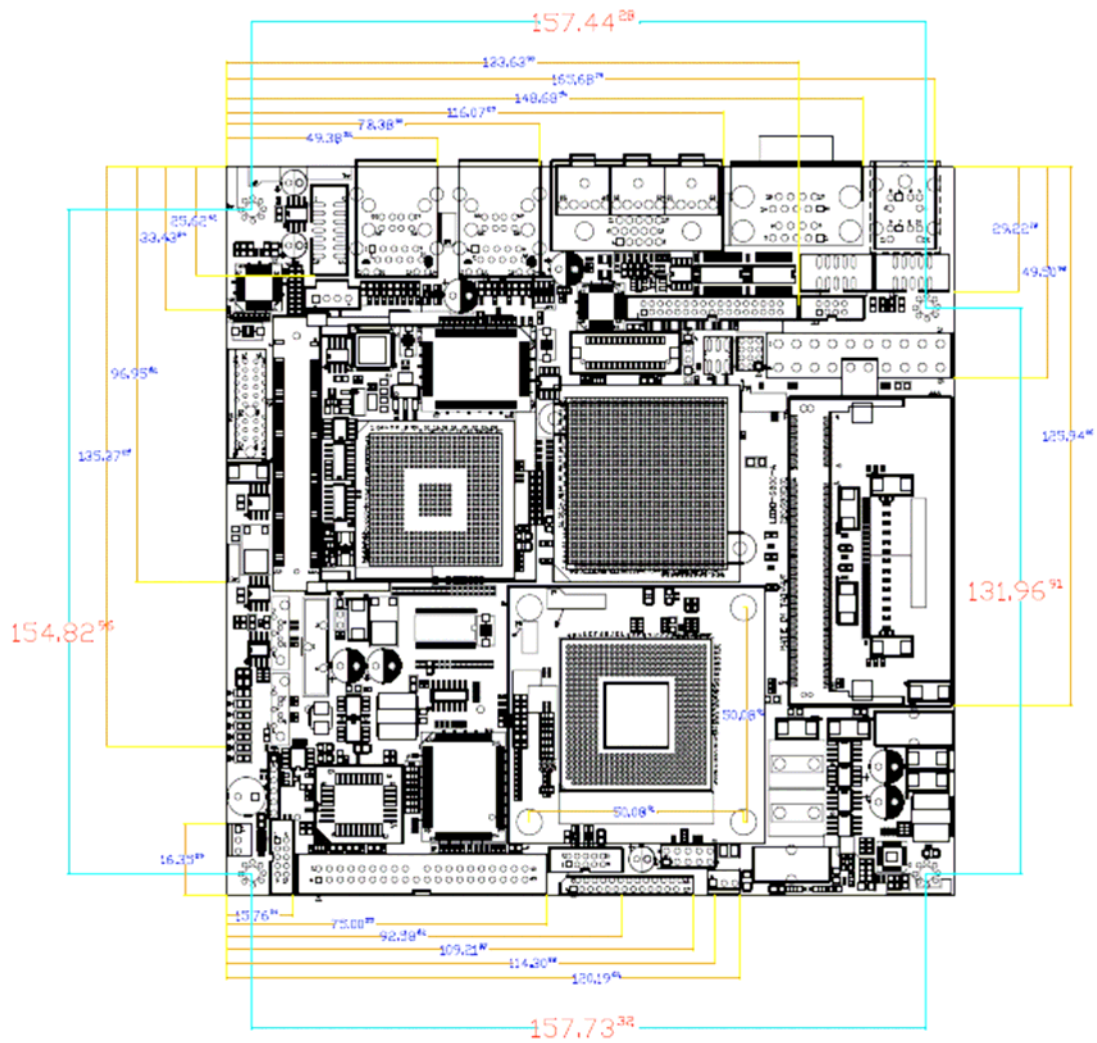

Solder Side

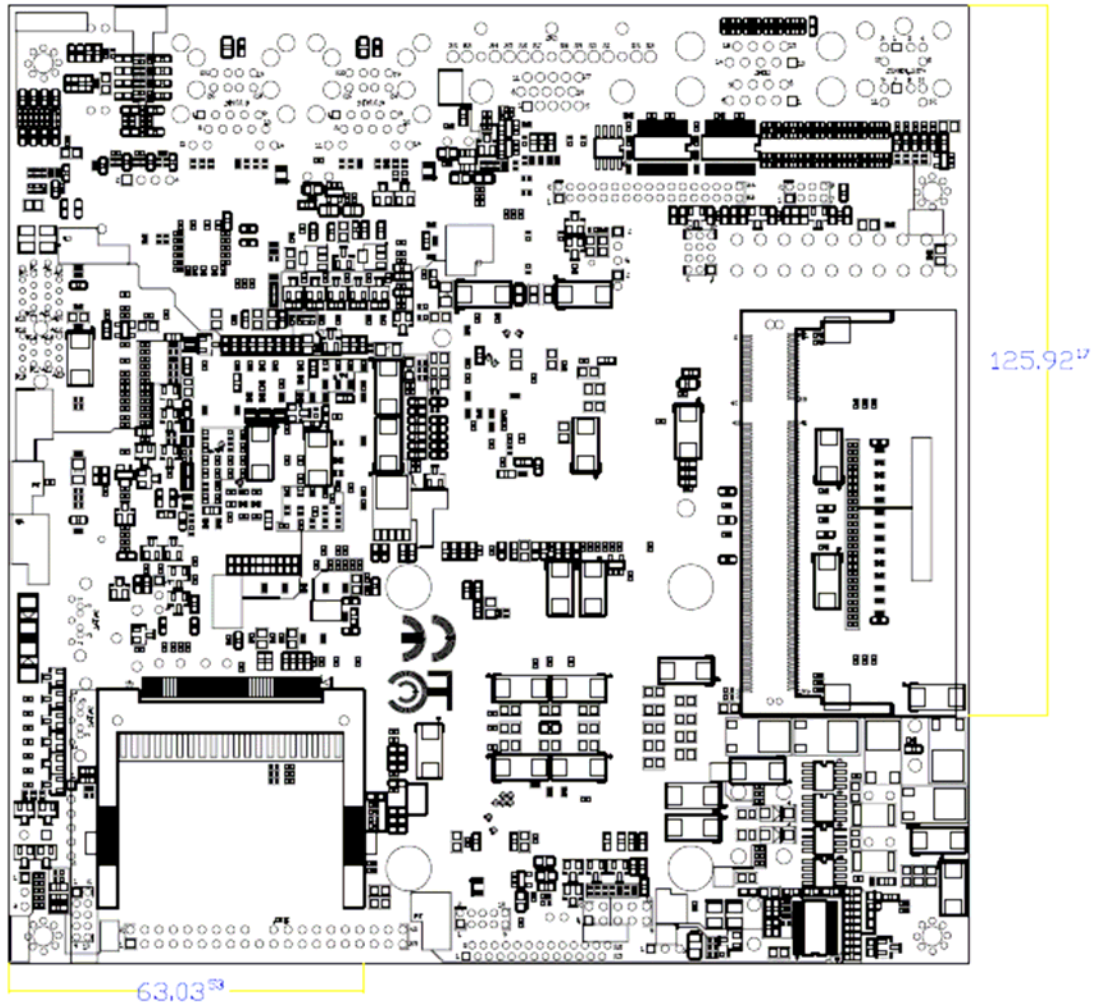

Hardware Installation

Connectors Location

Component Side

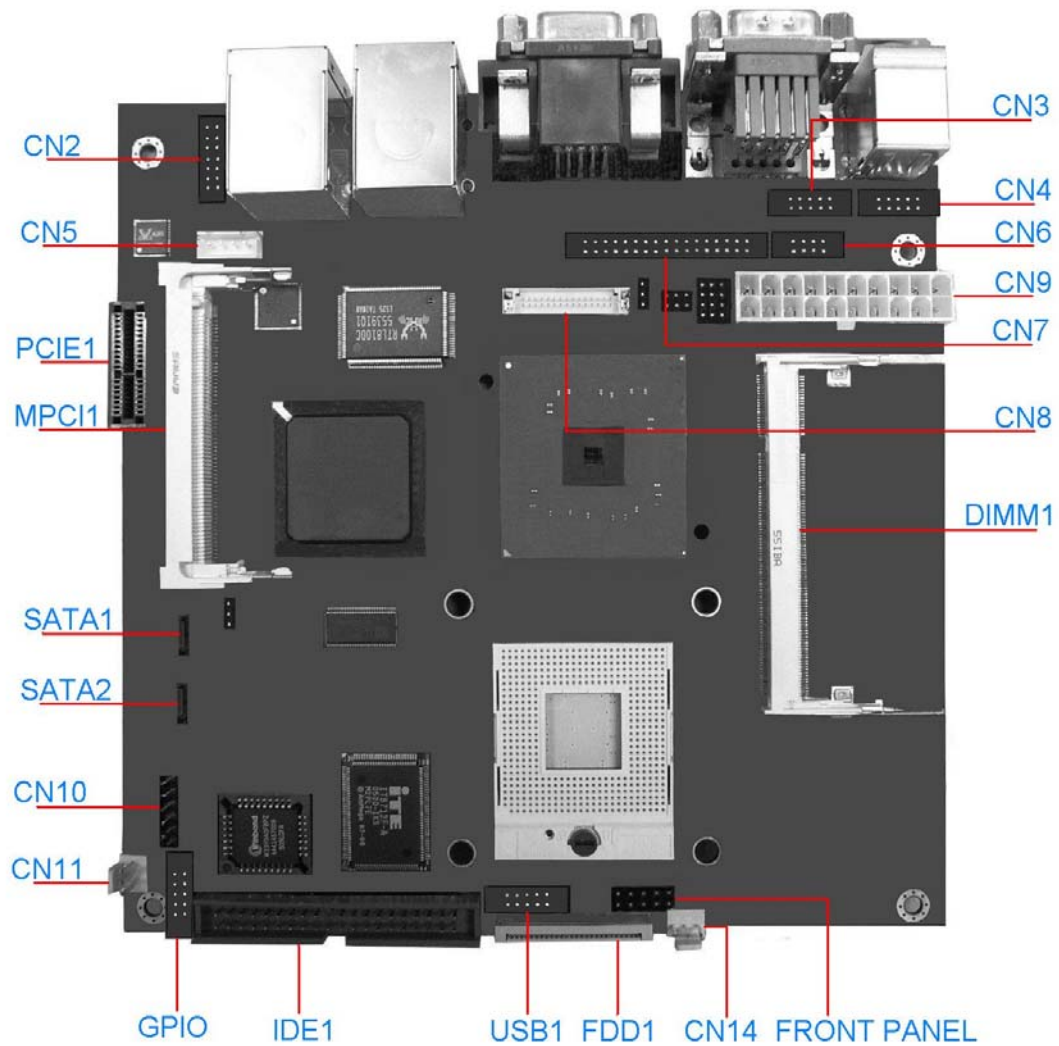

Solder Side

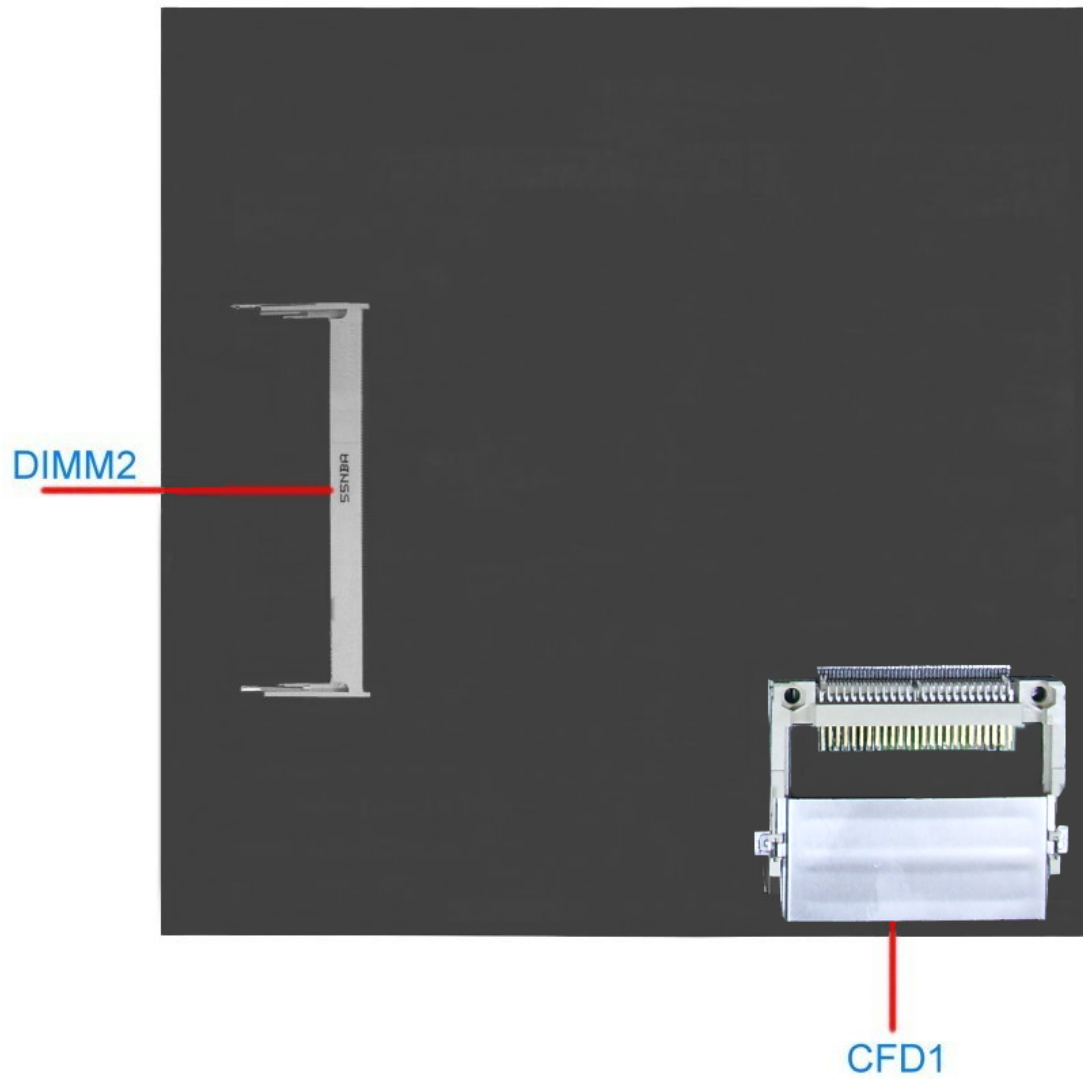

I / O Panel



List of Connectors

Connector	Function
CN1	VGA Display / Audio Connector
CN2	Front Audio Connector
CN3	COM 3 RS-232 Connector
CN4	COM4 RS-232 Connector
CN5	CD - In Connector
CN6	TV - Out Connector
CN7	DVOB Connector
CN8	LVDS Connector
CN9	ATX Power Connector
CN10	IrDA Connector
CN11	System Fan Connector
CN12	Front Panel Connector
CN13	GPIO Connector
CN14	CPU Fan Connector
PS2-KBMS1 A / B	PS2 Keyboard / Mouse Connector
FDD1	Slim Floppy Connector
IDE1	EIDE Connector
COM1	COM1 RS-232 Connector
COM2	COM2 RS-232 / RS-422 / RS-485 Connector
RJUSB1 A / B	Gigabit LAN / USB Connector
RJUSB2 A / B	Ethernet LAN / USB Connector
USB1	USB1 Connector
USB2	USB2 Connector
MPC11	Mini - PCI Slot
CFD1	CompactFlash Slot
DIMM1	SoDIMM Slot
DIMM2	SoDIMM Slot
SATA1	SATA1 Connector
SATA2	SATA2 Connector
PCIE1	PCI - Express Slot

Jumpers Locations

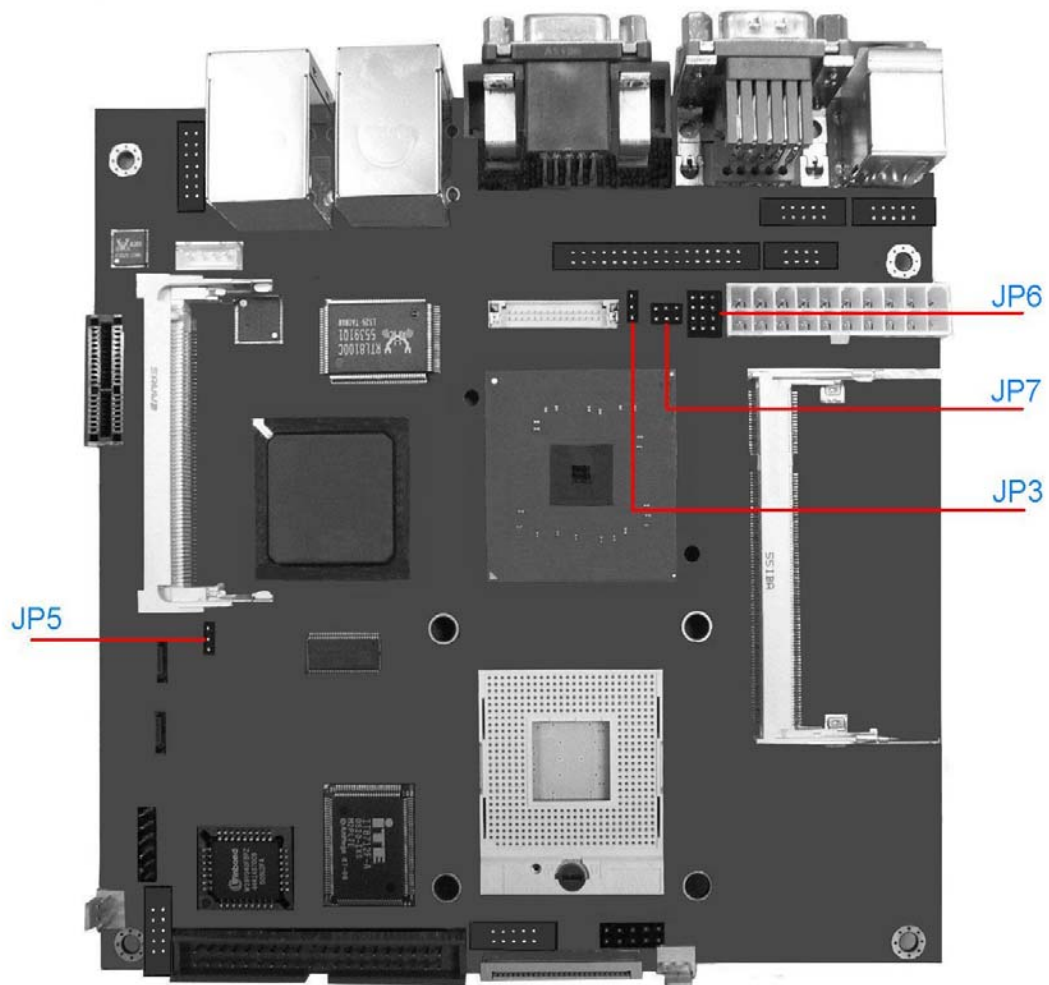

List of Jumpers

JP3	LVDS Panel Voltage Selection (+5V / +3.3V)
JP5	Clear CMOS Selection
JP6	COM2 RS232/422/485 Select
JP7	COM2 RS232/422/485 Select

Jumpers Setting

OPEN 1 - 2 - 3



1 2 3

SHORT 1 - 2



1 2 3

SHORT 2 - 3

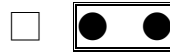

1 2 3

LVDS Panel Voltage Selection (JP3)

5V



1 2 3

3.3V



2 3

Clear CMOS Selection (JP5)

Protected



1 2

Clear CMOS



2 3

COM2 RS232/422/485 Selection (JP6,JP7)

COM2 SETTING RS232

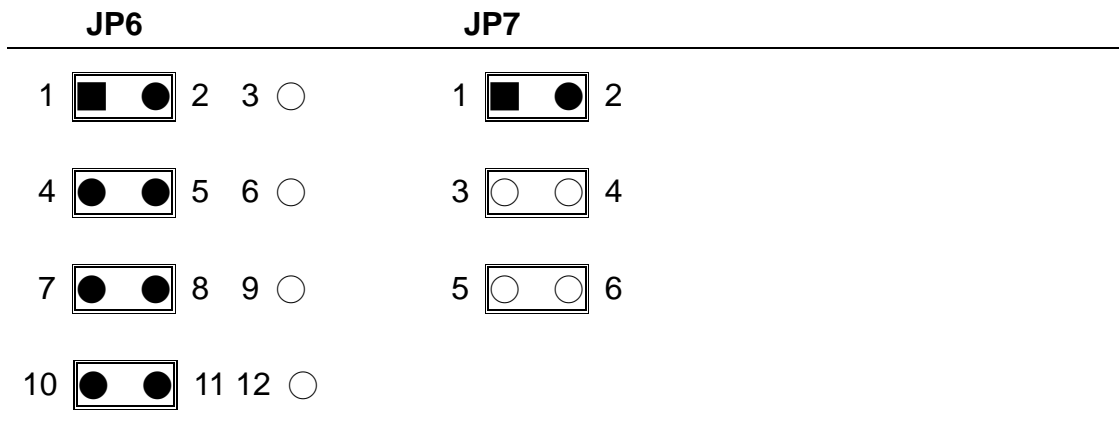

COM2 SETTING RS422

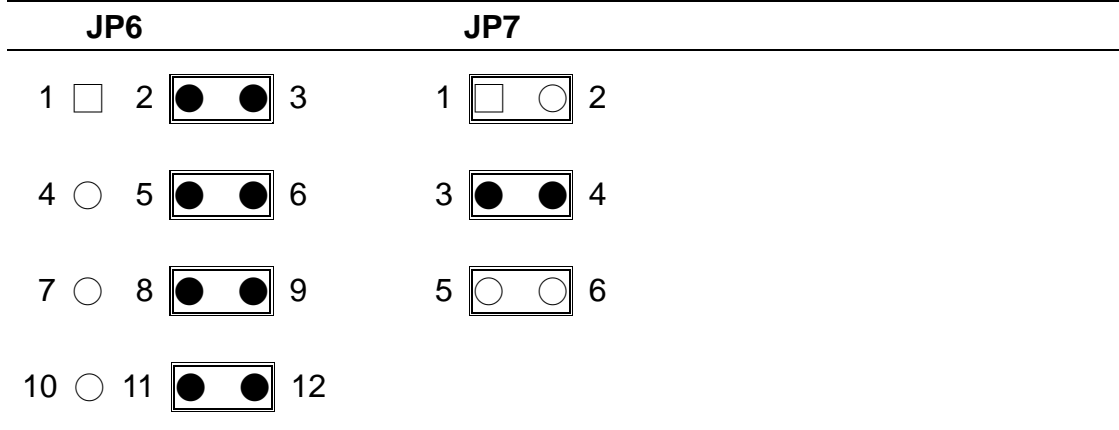

COM2 SETTING RS485

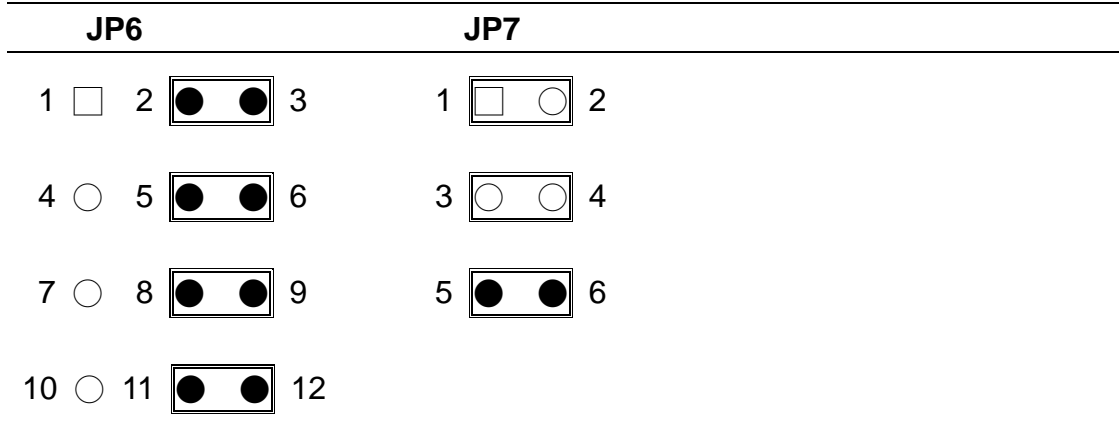

VGA Display Connector (CN1)

Pin	Assignment	Pin	Assignment
1	RED	2	GREEN
3	BLUE	4	N / C
5	GND	6	GND
7	GND	8	GND
9	VGA_VCC	10	GND
11	N / C	12	CRT _ DDCDATA
13	HSYNC	14	VSYNC
15	CRT_DDCCLK		

5.1 Channel Audio Connector (CN2)

Pin	Assignment	Pin	Assignment
1	LOUT _ R	2	LOUT _ L
3	GND	4	GND
5	SURROUND _ R	6	SURROUND _ L
7	GND	8	GND
9	LFE _ O	10	CEN _ O
11	GND	12	GND
13	SPDIF _ O	14	SPDIF _ I

COM 3 RS-232 Connector (CN3)

Pin	Assignment	Pin	Assignment
1	DCD3#	2	RXD3
3	TXD3	4	DTR3#
5	GND	6	DSR3#
7	RTS3#	8	CTS3#
9	RI3#	10	N / C

COM4 RS-232 Connector (CN4)

Pin	Assignment	Pin	Assignment
1	DCD4#	2	RXD4
3	TXD4	4	DTR4#
5	GND	6	DSR4#
7	RTS4	8	CTS4#
9	RI4#	10	N / C

CD - In Connector (CN5)

Pin	Assignment
1	CD-L
2	GND
3	GND
4	CD-R

TV - Out Connector (CN6)

Pin	Assignment	Pin	Assignment
1	Y	2	C
3	GND	4	GND
5	CVBS	6	N / C
7	GND	8	N / C

DVOB Connector (CN7)

Pin	Assignment	Pin	Assignment
1	5V	2	3.3V
3	SDVOB_INT#	4	SDVOB_INT
5	2.5V	6	GND
7	SDVO_FLDSTALL#	8	SDVO_FLDSTALL
9	GND	10	GND
11	SDVOB_RED#	12	SDVOB_RED
13	GND	14	GND
15	SDVOB_GREEN#	16	SDVOB_GREEN
17	GND	18	GND
19	SDVOB_BLUE#	20	SDVOB_BLUE
21	GND	22	GND
23	SDVOB_CLK#	24	SDVOB_CLK
25	GND	26	GND
27	SDVOCTRL_CLK	28	N / C
29	SDVOCTRL_DATA	30	N / C
31	GND	32	GND
33	SDVOB_RST#	34	N / C

LVDS Connector (CN8)

Pin	Assignment	Pin	Assignment
1	BKL _ EN	2	BKL _ CTL
3	LVDS _ VCC	4	GND
5	LVDS _ CH1 _ CLK-	6	LVDS _ CH1 _ CLK+
7	LVDS _ VCC	8	GND
9	LVDS _ CH1 _ DATA0-	10	LVDS _ CH1 _ DATA0+
11	LVDS _ CH1 _ DATA1-	12	LVDS _ CH1 _ DATA1+
13	LVDS _ CH1 _ DATA2-	14	LVDS _ CH1 _ DATA2+
15	N / C	16	N / C
17	N / C	18	N / C
19	LVDS _ CH2 _ DATA0-	20	LVDS _ CH2 _ DATA0+
21	LVDS _ CH2 _ DATA1-	22	LVDS _ CH2 _ DATA1+
23	LVDS _ CH2 _ DATA2-	24	LVDS _ CH2 _ DATA2+
25	LVDS_DDCPDATA	26	LVDS_DDCPCLK
27	LVDS _ VCC	28	GND
29	LVDS _ CH2 _ CLK-	30	LVDS _ CH2 _ CLK+

ATX Power Connector (CN9)

Pin	Assignment	Pin	Assignment
1	3.3V	2	3.3V
3	GND	4	5V
5	GND	6	5V
7	GND	8	N / C
9	5VSB	10	12V
11	3.3V	12	-12V
13	GND	14	PSON
15	GND	16	GND
17	GND	18	-5V
19	5V	20	5V

IrDA Connector (CN10)

Pin	Assignment
1	5V
2	CIRTX
3	IRRX
4	GND
5	IRTX
6	CIRRX

System Fan Connector (CN11)

Pin	Assignment
1	GND
2	12V
3	FAN Sense

Front Panel Connector (CN12)

Pin	Assignment	Pin	Assignment
1	GND	2	Power Switch
3	BUZZER-	4	BUZZER+
5	HD_LED-	6	HD_LED+
7	POWER LED-	8	Power LED+
9	GND	10	Reset

GPIO Connector (CN13)

Pin	Assignment
1	GPI
2	GPO
3	GPI
4	GPO
5	GPI
6	GPO
7	GPI
8	GPO
9	5V
10	GND

CPU Fan Connector (CN14)

Pin	Assignment
1	GND
2	12V
3	FAN Sense

PS2 KB / MS Connector (PS2-KBMS1 A / B)

Pin	Assignment	Pin	Assignment
1	KB_DATA	2	N / C
3	GND	4	KB_VCC
5	KB_CLK	6	N / C
7	MS_DATA	8	N / C
9	GND	10	KB_VCC
11	MS_CLK	12	N / C

EIDE Connector (IDE1)

Pin	Assignment	Pin	Assignment
1	IDERST#	2	GND
3	PID7	4	PID8
5	PID6	6	PID9
7	PID5	8	PID10
9	PID4	10	PID11
11	PID3	12	PID12
13	PID2	14	PID13
15	PID1	16	PID14
17	PID0	18	PID15
19	GND	20	N / C
21	PDREQ	22	GND
23	PIOR#	24	GND
25	PIOR#	26	GND
27	PRDY	28	GND
29	PACK#	30	GND
31	PIRQ14	32	N / C
33	PPDA1	34	ATA66 _ DET
35	PPDA0	36	PPDA2
37	PPCS1#	38	PPCS3#
39	HDLED#	40	GND

USB Connector (USB1)

Pin	Assignment	Pin	Assignment
1	USB_VCC	2	GND
3	USB4-	4	GND
5	USB4+	6	USB5+
7	GND	8	USB5-
9	GND	10	USB_VCC

Slim Floppy Connector (FDD1)

Pin	Assignment	Pin	Assignment
1	VCC	2	INDEX#
3	VCC	4	DRV _ SEL#
5	VCC	6	DSK _ CH#
7	N / C	8	N / C
9	N / C	10	MOTOR#
11	N / C	12	DIR#
13	DENSEL#	14	STEP#
15	GND	16	WDATA#
17	GND	18	WGATE#
19	GND	20	TRACK#
21	GND	22	WPROT#
23	GND	24	RDATA#
25	GND	26	SIDE#

COM1 RS-232 Connector (COM1)

Pin	Assignment	Pin	Assignment
1	DCD1#	2	RXD1
3	TXD1	4	DTR1#
5	GND	6	DSR1#
7	RTS1#	8	CTS1#
9	RI1#		

COM2 RS-232/422/485 Connector (COM2)

Pin	Assignment	Pin	Assignment
1	DCD2#(422TXD-/485DATA-)	2	RXD2(422RXD+)
3	TXD2(422TXD+/485DATA+)	4	DTR2#(422RXD-)
5	GND	6	DSR2#
7	RTS2#	8	CTS2#
9	RI2#		

Gigabit LAN / USB Connector (RJUSB1)

Standard RJ - 45 Connector / Standard USB Connector

Ethernet LAN / USB Connector (RJUSB2)

Standard RJ - 45 Connector / Standard USB Connector

Mini - PCI Slot (MPCI1)

Standard Mini - PCI Connector

CompactFlash Slot (CFD1)

Standard CompactFlash Connector Type II

SoDIMM Slot (DIMM1)

Standard DDRII SoDIMM Connector

SoDIMM Slot (DIMM 2)

Standard DDRII SoDIMM Connector

SATA1 Connector (SATA1)

Standard Serial ATA Connector

SATA2 Connector (SATA2)

Standard Serial ATA Connector

PCI - Express Slot (PCIE1)

Standard PCI – Express x 1 Slot

Standard CMOS Features

Phoenix – AwardBIOS CMOS Setup Utility

Standard CMOS Features

Date (mm:dd:yy)	Thu, Dec 15 2005	Item Help
Time (hh:mm:ss)	10 : 59 : 36	
IDE Channel 0 Master	[None]	Menu Level > Change the day, month, year and century
IDE Channel 0 Slave	[None]	
IDE Channel 1 Master	[None]	
IDE Channel 0 Slave	[None]	
Drive A	[1.44M, 3.5 in]	
Drive B	[None]	
Video	[EGA / VGA]	
Halt On	[All, But Keyboard]	
Base Memory	640K	
Extended memory	1038336K	
Total Memory	1039360K	

↑ ↓ → ←: Move Enter: Select +/- /PU/PD: Value F10: Save ESC: Exit F1: General Help
F5: Previous Values F6: Fail-Safe Defaults F7: Optimized Defaults

Date

Day Sun to Sat
Month Jan. through Dec.
Date 1 to 31
Year 1999 through 2099

Time

Hour 00 to 23
Minute 00 to 59
Second 00 to 59

IDE Channel 0, 1 Master / Slave

Auto Allow BIOS to automatically detect IDE devices.
None If no IDE devices are used.
Manual Enter the appropriate option based on following information.

Cylinder	Number of cylinders
Head	Number of heads
Precomp	Write precomp
Landing Zone	Landing zone
Sector	Number of sectors

Access Mode

CHS	HD < 528MB
LBA	HD > 528MB
Large	For MS-DOS only
Auto	

Drive A / Drive B

360KB, 5.25"	5.25" inch 360KB PC-type standard drive.
1.2MB, 5.25"	5.25" inch 1.2MB AT-type high-density drive.
720KB, 3.5"	3.5" inch 720KB double-sided drive.
1.44MB, 3.5"	3.5" inch 1.44MB double-sided drive.
2.88MB, 3.5"	3.5" inch 2.88MB double-sided drive.

Video

EGA/VGA	For EGA, VGA, SEGA, SVGA or PGA monitor adapters.
CGA 40	Power up in 40 column mode.
CGA 80	Power up in 80 column mode.
MONO	For Hercules or MDA adapters.

Halt On

No Errors	The system boot will not be halted for any error that may be detected.
All Errors	Whenever the BIOS detects a non-fail error the system will be stopped.
ALL, But Keyboard error, it	The system boot will not stop for a keyboard will stop for all other errors.
All, But Diskette will	The system boot will not stop for a disk error, it stop for all other errors.
All, But Disk/Key keyboard	The system boot will not stop for a disk or error, it will stop for all other errors.

Advanced BIOS Features

Phoenix – AwardBIOS CMOS Setup Utility

Advanced BIOS Features

CPU Features	[Press Enter]	Item Help
Hard Disk Boot Priority	[Press Enter]	Menu Level >
Virus Warning	[Disabled]	
CPU L1 & L2 Cache	[Enabled]	
Quick Power On Self Test	[Enabled]	
First Boot Device	[Floppy]	
Second Boot Device	[Hard Disk]	
Third Boot Device	[LS120]	
Boot Other Device	[Enabled]	
Swap Floppy Driver	[Disabled]	
Boot Up Floppy Seek	[Enabled]	
Boot Up NumLock Status	[On]	
Gate A20 Option	[Fast]	
Typematic Rate Setting	[Disabled]	
Typematic Rate (Chars/Sec)	6	
Typematic Delay	250	
Security Option	[Setup]	
APIC Mode	[Enabled]	
MPS Version Control For OS	[1. 4]	
Os Select For DRAM >64MB	[Non-OS2]	
Report No FDD For Win 95	[No]	
Small Logo(EPA)Show	[Disabled]	

↑ ↓ → ←:Move Enter:Select +/–/PU/PD:Value F10:Save ESC:Exit F1:General Help
F5:Previous Values F6:Fail-Safe Defaults F7:Optimized Defaults

CPU Feature

Press enter to configure the setting relevant CPU feature.

HDD Boot Priority

Select boot sequence for on board SCSI, RAID, etc.

Virus Warning

If this option enabled, an alarm message will be displayed when trying to write on the boot sector or on the partition table on the disk, which is typical of the virus.

CPU L1&L2 Cache This option allows you to enable or disable the cache function.

Quick Power On Self Test When this option enabled, this field speeds up the Power On Self Test after the system is turned on.

First/Second/Third Boot Device

Floppy	Select your boot device priority by Floppy.
LS120	Select your boot device priority by LS120.
Hard Disk	Select your boot device priority by Hard Disk.
CDROM	Select your boot device priority by CDROM.
ZIP	Select your boot device priority by ZIP.
USB-FDD	Select your boot device priority by USB-FDD.
USB-ZIP	Select your boot device priority by USB-ZIP.
USB-CDROM	Select your boot device priority by USB-CDROM.
USB-HDD	Select your boot device priority by USB-HDD.
LAN	Select your boot device priority by LAN.
Disabled	Disable this function.

Boot Other Device This option allows the system to search for an OS from other devices.

Swap Floppy Driver This option allows you to determine whether or not to enable Swap Floppy drive.

Boot Up Floppy Seek This option controls whether the BIOS checks for a floppy drive while booting up.

Boot Up NumLock Status This option allows you to activate the NumLock function after you power up the system.

Gate A20 Option This option allows you to select how Gate A20 is worked.

Typematic Rate Setting When disabled, continually holding down a key on your keyboard will generate only one instance. When enabled, you can set the two typematic controls listed next.

Typematic Rate (Chars/Sec)	When enabled, the system registers repeated keystrokes speeds. Setting are from 6 to 30 characters per second.
Typematic Delay	When enabled, this option allows you to set the time interval for displaying the first and second characters.
Security Option	When setup, the system always boots up and prompt for the Supervisor Password only. When system, the system prompts for the User Password every time you boot up.
APIC Mode	APIC stands for Advanced Programmable Interrupt Controller.
MPS Version Control For OS	This Option is specifies the Multiprocessor Specification version for your operating system.
Os Select For DRAM >64MB	This option allows the system to access greater than 64MB of DRAM memory when used with OS/2.
Report No FDD For Win 95	When disabled, the BIOS will not report the missing floppy drive to Win 95/98.
Small Logo(EPA)Show	The EPA logo appears at the right side of the monitor screen when the system is boot up.

Advanced Chipset Features

Phoenix – AwardBIOS CMOS Setup Utility

Advanced Chipset Features

		Item Help
DRAM Timing Selectable	[By SPD]	
CAS Latency Time	4	
DRAM RAS# to CAS# Delay	4	Menu Level >
DRAM RAS# Precharge	4	
Precharge delay (tRAS)	11	
System Memory Frequency	533MHz	
SLP_S4# Assertion Width	[4 to 5 Sec.]	
System BIOS cacheable	[Enabled]	
Video BIOS cacheable	[Disabled]	
Memory Hole At 15M-16M	[Disabled]	
PCI Express Root Port Func	[Press Enter]	
** VGA Setting **		
PEG/Onchip VGA Control	[Auto]	
On-Chip Frame Buffer Size	[8MB]	
DVMT Mode	[DVMT]	
DVMT/FIXED Memory Size	[128MB]	
Boot Display	[Auto]	
Panel Scaling	[Auto]	
Panel Number	[1]	
TV Standard	[Off]	
Video Connector	[Automatic]	
TV Format	[Auto]	
FWH Write Protection	[Disabled]	
Onboard LAN1 Control	[Enabled]	
Onboard LAN2 Control	[Enabled]	

↑ ↓ → ←: Move Enter: Select +/- /PU/PD: Value F10: Save ESC: Exit F1: General Help
 F5: Previous Values F6: Fail-Safe Defaults F7: Optimized Defaults

DRAM Timing Selectable This option refers to the method by which DRAM timing is select.

CAS Latency Time Do not change the values in this option unless you change specification of the installed DRAM or CPU.

DRAM RAS# to CAS# Delay	This option allows you to insert a delay between RAS and CAS signals.
DRAM RAS# Precharge	This option sets the number of cycles required for the RAS to accumulate its charge before the DRAM refreshes.
Precharge delay (tRAS)	The default setting Precharge delay is 8.
SLP_S4# Assertion Width	The default is 4 to 5 Sec.
System BIOS cacheable	When enabled, the system BIOS ROM at F0000h-FFFFFh.
Video BIOS cacheable	When enabled, the video BIOS ROM at C0000h-F7FFFh.
Memory Hole At 15M-16M	In order to improve performance, certain space in memory can be reserved for ISA cards. This memory must be mapped into the memory space below 16MB.
PCI Express Root Port Func	The default is Press Enter.
VGA Setting	The fields under the VGA setting and their default setting are:
PEG/Onchip VGA Control	Auto
On-Chip Frame Buffer Size	8MB
DVMT Mode	DVMT
DVMT/FIXED Memory Size	128MB
Boot Display	Auto
Panel Scaling	Auto
Panel Number	1
TV Standard	Off
Video Connector	Automatic
TV Format	Auto
FWH Write Protection	Disabled
Onboard LAN1 Control	Enabled
Onboard LAN2 Contro	Enabled

Integrated Peripherals

Phoenix – AwardBIOS CMOS Setup Utility

Integrated Peripherals

OnChip IDE Device	[Press Enter]	Item Help
Onboard Device	[Press Enter]	Menu Level >
Super IO Device	[Press Enter]	
Watch Dog Timer Select	[Disabled]	
Onboard Serial Port 5	[4F8]	
Serial Port 5 Use IRQ	[IRQ5]	
Onboard Serial Port 6	[4E8]	
Serial Port 5 Use IRQ	[IRQ7]	

↑ ↓ → ←:Move Enter:Select +/–/PU/PD:Value F10:Save ESC:Exit F1:General Help
F5:Previous Values F6:Fail-Safe Defaults F7:Optimized Defaults

Phoenix – AwardBIOS CMOS Setup Utility

OnChip IDE Device

IDE HDD Block Mode	[Enabled]	Item Help
IDE DMA transfer access	[Enabled]	Menu Level >
On-Chip Primary PCI IDE	[Enabled]	
IDE Primary Master PIO	[Auto]	
IDE Primary Slave PIO	[Auto]	
IDE Primary Master UDMA	[Auto]	
IDE Primary Slave UDMA	[Auto]	
*** On-Chip Serial ATA Setting ***		
On-Chip Serial ATA	[Auto]	
PATA IDE Mode	SECONDARY	
SATA Port	P0,P2 IS Primary	

↑ ↓ → ←:Move Enter:Select +/–/PU/PD:Value F10:Save ESC:Exit F1:General Help
F5:Previous Values F6:Fail-Safe Defaults F7:Optimized Defaults

IDE HDD Block Mode This option allows your Hard disk controller to use the fast block mode to transfer data to and from your Hard disk drive.

IDE DMA transfer access The default is Enabled.

IDE Primary / Secondary Master / Slave PIO

The PIO allows the BIOS to communicate with the controller and CPU directly. When Auto is selected, the BIOS will select the best available mode.

IDE Primary / Secondary Master / Slave UDMA

These option allow your disk I/O 33Mb/sec to Ultra DMA 33 feature.

On-Chip Serial ATA

The default is Auto.

Phoenix – AwardBIOS CMOS Setup Utility

Onboard Device

USB Controller	[Enabled]	Item Help
USB 2.0 Controller	[Enabled]	Menu Level >
USB Keyboard Support	[Enabled]	
USB Mouse Support	[Disabled]	
Azalia/AC97 Audio Select	[Auto]	

↑ ↓ → ←: Move Enter: Select +/–/PU/PD: Value F10: Save ESC: Exit F1: General Help
F5: Previous Values F6: Fail-Safe Defaults F7: Optimized Defaults

USB Controller

This option allows you to select USB Controller Enabled or Disabled.

USB 2.0 Controller

This option allows you to select USB 2.0 Controller Enabled or Disabled.

USB Keyboard Support

This option allows you to select USB Keyboard Support Enabled or Disabled.

USB Mouse Support

This option allows you to select USB Mouse Support Enabled or Disabled.

Azalia/AC97 Audio Select

This option allows you to select AC97 Audio function Enabled or Disabled.

Phoenix – AwardBIOS CMOS Setup Utility

Super IO Device

Onboard FDC Controller	[Enabled]	Item Help
Onboard Serial Port 1	[3F8/IRQ4]	Menu Level >
Onboard Serial Port 2	[2F8/IRQ3]	

↑ ↓ → ←: Move Enter: Select +/- /PU/PD: Value F10: Save ESC: Exit F1: General Help
F5: Previous Values F6: Fail-Safe Defaults F7: Optimized Defaults

Onboard FDC Controller This option allows you to select FDD port.

Onboard Serial Port 1 The default values is 3F8/IRQ4.

Onboard Serial Port 2 The default values is 2F8/IRQ3.

Power Management Setup

Phoenix – AwardBIOS CMOS Setup Utility

Power Management Setup

ACPI Function	[Enabled]	Item Help
ACPI Suspend Type	[S1(POS)]	
Run VGABIOS if S3 Resume	Auto	Menu Level >
Power Management	[User Define]	
Video Off Method	[DPMS]	
Video Off In Suspend	[Yes]	
Suspend Type	[Stop Grant]	
MODEM Use IRQ	[3]	
Suspend Mode	[Disabled]	
HDD Power Down	[Disabled]	
Soft-Off by PWR-BTTN	[Instant-Off]	
Wake-Up by PCI card	[Enabled]	
Power On by Ring	[Enabled]	
USB KB Wake-up From S3	Disabled	
Resume by Alarm	[Disabled]	
Date(of Month) Alarm	0	
Time(hh:mm:ss) Alarm	0 : 0 : 0	
** Reload Global Timer Events **		
Primary IDE 0	[Disabled]	
Primary IDE 1	[Disabled]	
Secondary IDE 0	[Disabled]	
Secondary IDE 1	[Disabled]	
FDD, COM, LPT, Port	[Disabled]	
PCI PIRQ(A-D)#	[Disabled]	

↑ ↓ → ← : Move Enter: Select + / - / PU / PD: Value F10: Save ESC: Exit F1: General Help
 F5: Previous Values F6: Fail-Safe Defaults F7: Optimized Defaults

ACPI Function Enable this option to support ACPI Function.

ACPI Suspend Type Select ACPI Suspend to S1(POS) or S3(STR).

Power Management

User Define Each of the ranges is from 1 min. to 1hr.
 Min. Saving Minimum power management
 Max. Saving Maximum power management

Video Off Method	
V/H SYNC+Blank	Blank the screen and turn off vertical and horizontal scanning.
DPMS	Allows BIOS to control the video display.
Blank Screen	Writes blanks to the video buffer.
Video Off In Suspend	Select the Video Off in Suspend mode.
Suspend Type	The default is Stop Grant.
MODEM Use IRQ	This option allows you to set the IRQ by Modem.
Suspend Mode	After the set time of system inactivity, all devices except CPU will be shut off.
HDD Power Down	After the set time of system inactivity, the Hard disk drive will be power down while all other devices remain active.
Soft-Off by PWR-BTTN	
Instant-Off	Press power button then Power Off instantly.
Delay 4 Sec.	Press power button 4 seconds to Power Off.
Enter	suspend if button is pressed less than 4 seconds.
Wake-Up by PCI card	The default is Enabled.
Power On by Ring	This field enable or disable the power on of the system through the modem connected to the serial port or LAN.
Resume by Alarm	This field enable or disable the resumption of the system operation.
Reload Global Timer Events	This field their default setting are:
Primary IDE 0	Disabled
Primary IDE 1	Disabled
Secondary IDE 0	Disabled
Secondary IDE 1	Disabled
FDD, COM, LPT, Port	Disabled
PCI PIRQ(A-D)#	Disabled

PnP / PCI Configurations

Phoenix – AwardBIOS CMOS Setup Utility

PnP/PCI Configurations

Init Display First	[PCI Slot]	Item Help
Reset Configuration Data	[Disabled]	
Resources Controlled By	[Auto(ESCD)]	Menu Level > Default is Disabled. Select Enabled to reset Extended System Configuration Data (ESCD) when you exit Setup if you have installed a new add-on and the system reconfiguration has caused such a serious conflict that the OS cannot boot
IRQ Resources	Press Enter	
DMA Resources	Press Enter	
PCI/VGA Palette Snoop	[Disabled]	
** PCI Express relative items **		
Maximum Payload Size	[4096]	

↑ ↓ → ←: Move Enter: Select +/–/PU/PD: Value F10: Save ESC: Exit F1: General Help
F5: Previous Values F6: Fail-Safe Defaults F7: Optimized Defaults

Init Display First

The default setting is PCI card.

Reset Configuration Data

This option allows you to determine whether to reset the configuration data or not.

Resources Controlled By

This PnP BIOS can configure all of the boot and compatible devices automatically with use a PnP operating system.

PCI/VGA Palette Snoop

Enabled

PCI/VGA can work with MPEG ISA/VESA VGA card.

Disabled
VGA

PCI/VGA cannot work with MPEG ISA/VESA card.

Maximum Payload Size

The default is 4096.

PC Health Status

Phoenix – AwardBIOS CMOS Setup Utility

PC Health Status

Shutdown Temperature	[60°C~140°F]	Item Help
VCPU	1.26V	Menu Level >
VMemory	1.76V	
V3.3V	3.26V	
V5V	4.97V	
V+12V	11.77V	
V-12V	(-)11.78V	
V5VSB	4.97V	
Voltage Battery	3.15V	
Temperature CPU	51°C	
Temperature GMCH	37°C	
Temperature System	27°C	
Fan CPU Speed	5273 RPM	
Fan System Speed	0 RPM	

↑ ↓ → ←:Move Enter:Select +/–/PU/PD:Value F10:Save ESC:Exit F1:General Help
 F5:Previous Values F6:Fail-Safe Defaults F7:Optimized Defaults

Shutdown Temperature

This option allows you to set the temperature Monitoring function feature of the board. The Values are read-only as monitored by the system and show the PC health status.

Load Fail – Safe Defaults

This menu contains the most appropriate values of the system parameters that allow minimum system performance.

Load Optimized Defaults

This menu allows you to load the factory defaults for BIOS and Chipset features which the system automatically detects.

Set Supervisor Password

When you select this function, the following message will appear at the center of the screen to assist you creating a password.

Type the password, up to eight characters and press <Enter>. You will be asked to confirm the password. Type the password again and press <Enter>.

You may also press <Esc> to abort the selection and not enter a password.

To disable a password, just press <Enter> when you are prompted to enter the password. A message "PASSWORD DISABLED" will appear to confirm the password being disabled. Once the password is disabled, the system will boot and you can enter Setup freely.

Save & Exit Setup

This menu allows you to determine whether to accept modifications or not. If you type "Y", you will quit the Setup Utility and save all your setup values to the CMOS. If you type "N", you will return to Setup Utility.

Exit Without Saving

This menu allows you to exit the Setup Utility without saving the changes. If you type "Y", you will quit the Setup Utility without saving to CMOS. If you type "N", you will return to Setup Utility.

Drivers Installation

Install Chipset Drivers

1. Insert the AR-B1890 CD-ROM into your CD-ROM drive. Click Intel® 915GMchipsets Drivers.
2. Click Intel® Chipset software Installation Utility.
3. When the welcome screen appears, click Next to continue.
4. Click Yes to accept the software license agreement and proceed with the installation process.
5. On readme information screen, click Next to continue the installation.
6. The setup process is complete now. Click Finish to restart the computer and for changes to take effect.

Install VGA drivers

1. Insert the AR-B1890 CD-ROM into your CD-ROM drive. Click Intel® 915GMchipsets Drivers..
2. Click Intel® 915GM Chipset Family Graphics Driver.
3. When the welcome screen appears, click Next to continue.
4. Click Yes to accept the software license agreement and continue the installation.
5. Restart the computer and for changes to take effect.

Install AC97 Codec Audio Drivers

1. Insert the AR-B1890 CD-ROM into your CD-ROM drive. Click Intel® 915GMchipsets Drivers.
2. Click Realtek AC'97 Codec Audio Driver.
3. Click Finish to restart the computer and for changes to take effect..

Install Marvell GigaLAN Drivers

1. Insert the AR-B1890 CD-ROM into your CD-ROM drive. Click LAN Card and Marvell LAN controller Driver.
2. When the welcome screen appears, click Next to continue
3. Click Yes to accept the software license agreement and continue the installation.
4. On readme information screen, click Next to continue the installation.
5. The setup process is complete now. Click Finish to restart the computer and for changes to take effect.

Install Realtek Ethernet Drivers

1. Insert the AR-B1890 CD-ROM into your CD-ROM drive. Click LAN Card and Realtek PRO LAN Driver.
2. When the welcome screen appears, click Next to continue
3. The setup process is complete now. Click Finish to restart the computer and for changes to take effect.

Free Manuals Download Website

<http://myh66.com>

<http://usermanuals.us>

<http://www.somanuals.com>

<http://www.4manuals.cc>

<http://www.manual-lib.com>

<http://www.404manual.com>

<http://www.luxmanual.com>

<http://aubethermostatmanual.com>

Golf course search by state

<http://golfingnear.com>

Email search by domain

<http://emailbydomain.com>

Auto manuals search

<http://auto.somanuals.com>

TV manuals search

<http://tv.somanuals.com>