

G4H875-N G4H875-C G4H875-B

Rev. A+
System Board
User's Manual

935-G4H875-000
A77100333

Copyright

This publication contains information that is protected by copyright. No part of it may be reproduced in any form or by any means or used to make any transformation/adaptation without the prior written permission from the copyright holders.

This publication is provided for informational purposes only. The manufacturer makes no representations or warranties with respect to the contents or use of this manual and specifically disclaims any express or implied warranties of merchantability or fitness for any particular purpose. The user will assume the entire risk of the use or the results of the use of this document. Further, the manufacturer reserves the right to revise this publication and make changes to its contents at any time, without obligation to notify any person or entity of such revisions or changes.

© 2004. All Rights Reserved.

Trademarks

Windows® 98 SE, Windows® ME, Windows® 2000, Windows NT® 4.0 and Windows® XP are registered trademarks of Microsoft Corporation. Intel®, Pentium® 4 and Celeron are registered trademarks of Intel Corporation. Award is a registered trademark of Award Software, Inc. Other trademarks and registered trademarks of products appearing in this manual are the properties of their respective holders.

Caution

To avoid damage to the system:

- Use the correct AC input voltage range.

To reduce the risk of electric shock:

- Unplug the power cord before removing the system chassis cover for installation or servicing. After installation or servicing, cover the system chassis before plugging the power cord.

Battery:

- Danger of explosion if battery incorrectly replaced.
- Replace only with the same or equivalent type recommend by the manufacturer.
- Dispose of used batteries according to the battery manufacturer's instructions.

Joystick or MIDI port:

- Do not use any joystick or MIDI device that requires more than 10A current at 5V DC. There is a risk of fire for devices that exceed this limit.

FCC and DOC Statement on Class B

This equipment has been tested and found to comply with the limits for a Class B digital device, pursuant to Part 15 of the FCC rules. These limits are designed to provide reasonable protection against harmful interference when the equipment is operated in a residential installation. This equipment generates, uses and can radiate radio frequency energy and, if not installed and used in accordance with the instruction manual, may cause harmful interference to radio communications. However, there is no guarantee that interference will not occur in a particular installation. If this equipment does cause harmful interference to radio or television reception, which can be determined by turning the equipment off and on, the user is encouraged to try to correct the interference by one or more of the following measures:

- Reorient or relocate the receiving antenna.
- Increase the separation between the equipment and the receiver.
- Connect the equipment into an outlet on a circuit different from that to which the receiver is connected.
- Consult the dealer or an experienced radio TV technician for help.

Notice:

1. The changes or modifications not expressly approved by the party responsible for compliance could void the user's authority to operate the equipment.
2. Shielded interface cables must be used in order to comply with the emission limits.

Notice

An electronic file of this manual is included in the CD. To view the user's manual, insert the CD into a CD-ROM drive. The autorun screen (Main Board Utility CD) will appear. Click "User's Manual" on the main menu.

Table of Contents

Chapter 1 - Introduction

1.1 Features and Specifications.....	7
1.2 Hyper-Threading Technology Functionality Requirements....	15
1.3 Package Checklist.....	15

Chapter 2 - Hardware Installation

2.1 System Board Layout	16
2.2 System Memory.....	19
2.3 CPU.....	24
2.4 Jumper Settings.....	29
2.5 Rear Panel I/O Ports.....	35
2.6 I/O Connectors.....	44

Chapter 3 - BIOS Setup

3.1 Award BIOS Setup Utility.....	60
3.2 Updating the BIOS.....	100

Chapter 4 - Supported Softwares

4.1 Desktop Management Interface.....	102
4.2 Drivers, Utilities and Software Applications.....	105
4.3 Installation Notes.....	113

Appendix A - Enabling the Hyper-Threading Technology

A.1 Enabling the Hyper-Threading Technology.....	114
--	-----

Appendix B - CPU Fan Protection

B.1 CPU Fan Protection.....	117
-----------------------------	-----

Appendix C - CPU Temperature Protection

C.1 CPU Temperature Protection.....	118
-------------------------------------	-----

Appendix D - System Error Messages

D.1 POST Beep.....	119
D.2 Error Messages.....	119

Appendix E - Troubleshooting

E.1 Troubleshooting Checklist.....	121
------------------------------------	-----

Chapter 1 - Introduction

1.1 Features and Specifications

1.1.1 Features

Chipset

- Intel® 875P chipset
 - Intel® 82875P Memory Controller Hub (MCH)
 - Intel® Hance Rapids I/O Controller Hub

Processor

The system board is equipped with Socket 478 for installing one of the following supported processors.

- Intel® Pentium® 4 (Prescott and Northwood) processor up to 3.2GHz+
 - Intel Hyper-Threading Technology
 - FSB: 533MHz and 800MHz
- Intel® Celeron® processor
 - 400MHz system data bus

System Memory

- Supports dual channel (128-bit wide) memory interface
 - Each channel supports 2 DIMM sockets
- Supports up to 4GB system memory
- Supports Dynamic mode to optimize system performance
- Synchronous operation with processor system bus
 - PC2100/PC2700/PC3200 (DDR266/DDR333/DDR400) with 800MHz FSB CPU (supports PAT mode). DDR333 will run at 320MHz memory frequency when used with 800MHz FSB CPU.
 - Use PC2100/PC2700 (DDR266/DDR333) with 533MHz FSB CPU
 - Use PC2100 (DDR266) with 400MHz FSB CPU
- Supports ECC/non-ECC DIMMs
- Supports unbuffered DIMMs

Density	128 Mbit		256 Mbit		512 Mbit	
Density Width	X8	X16	X8	X16	X8	X16
Single/Double	SS/DS	SS/DS	SS/DS	SS/DS	SS/DS	SS/DS
184-pin DDR	128/256MB	64MB/NA	256/512MB	128MB/NA	512/1024MB	256MB/NA

Performance Acceleration Technology (PAT)

PAT mode is supported only when the system uses DDR400 with 800MHz FSB CPU. PAT performs data transactions directly from the CPU to the system memory, bypassing the normal path of operation. This reduces the MCH timing therefore providing improved system performance.

Expansion Slots

- 1 AGP slot
- 4 PCI slots
- 1 PCI-X 64-bit/66MHz slot

AGP (Accelerated Graphics Port)

- Supports AGP 3.0 (AGP 4x and 8x) and AGP 2.0 (AGP 1x and 4x) spec.
- Supports 1.5V AGP 8x (2.13GB/sec.) and AGP 4x (1066MB/sec.) add-in cards.

AGP is an interface designed to support high performance 3D graphics cards for 3D graphics applications. It handles large amounts of graphics data with the following features:

- Pipelined memory read and write operations that hide memory access latency.
- Demultiplexing of address and data on the bus for nearly 100 percent efficiency.



Note:

AGP 2x and 3.3V AGP cards are not supported.

Onboard Audio Features

- 18-bit stereo full-duplex codec with independent variable sampling rate
- High quality differential CD input
- True stereo line level outputs
- 2-channel audio output

Onboard LAN Features

- 82547EI Gigabit LAN CSA interface (G4H875-N only)
 - Integrated power management functions
 - Full duplex support at both 10, 100 and 1000 Mbps
 - Supports IEEE 802.3u auto-negotiation
 - Supports wire for management
- 82551QM fast ethernet controller (G4H875-N, G4H875-C and G4H875-B)
 - Integrated IEEE 802.3, 10BASE-T and 100BASE-TX compatible PHY
 - Glueless 32-bit PCI master interface
 - Glueless CardBus master interface
 - 128 Kbyte Flash interface
 - Thin BGA 15 mm² package

Compatibility

- PCI 2.2 and AC '97 compliant
- Intel AGP version 3.0

PCI Bus Master IDE Controller

- Supports ATA/33, ATA/66 and ATA/100 hard drives
- PIO Mode 4 Enhanced IDE (data transfer rate up to 14MB/sec.)
- Bus mastering reduces CPU utilization during disk transfer
- Supports ATAPI CD-ROM, LS-120 and ZIP

IrDA Interface

The system board is equipped with an IrDA connector for wireless connectivity between your computer and peripheral devices. The IRDA (Infrared Data Association) specification supports data transfers of 115K baud at a distance of 1 meter.

USB Ports

The system board supports USB 2.0 and USB 1.1 ports. USB 1.1 supports 12Mb/second bandwidth while USB 2.0 supports 480Mb/second bandwidth providing a marked improvement in device transfer speeds between your computer and a wide range of simultaneously accessible external Plug and Play peripherals.

BIOS

- Award BIOS, Windows® 98SE/2000/ME/XP Plug and Play compatible
- Supports DMI 2.0 function
- 4Mbit or 8Mbit flash memory
- Supports optional BIOS Write Protect function by hardware

Desktop Management Interface (DMI)

The system board comes with a DMI 2.0 built into the BIOS. The DMI utility in the BIOS automatically records various information about your system configuration and stores these information in the DMI pool, which is a part of the system board's Plug and Play BIOS. DMI, along with the appropriately networked software, is designed to make inventory, maintenance and troubleshooting of computer systems easier. Refer to chapter 4 for instructions on using the DMI utility.

Rear Panel I/O Ports (PC 99 color-coded connectors)

- 1 mini-DIN-6 PS/2 mouse port
- 1 mini-DIN-6 PS/2 keyboard port
- 2 DB-9 serial ports
- 1 DB-25 parallel port
- 4 USB 2.0/1.1 ports (G4H875-N and G4H875-C only)
- 2 USB 2.0/1.1 ports (G4H875-B only)
- 2 RJ45 LAN ports (G4H875-N only)
- 1 RJ45 LAN port (G4H875-B and G4H875-C only)
- 3 audio jacks: line-out, line-in and mic-in

I/O Connectors

- 1 connector for 2 additional external USB 2.0/1.1 ports (G4H875-B only)
- 2 connectors for 2 external serial ports (G4H875-N only)
- 1 front audio connector for external line-out and mic-in jacks
- 1 connector for an external game/MIDI port
- 2 internal audio connectors (CD-in and AUX-in)
- 1 connector for IrDA interface
- 2 Serial ATA connectors
- 2 IDE connectors
- 1 floppy connector
- 2 ATX power supply connectors
- 1 Wake-On-LAN connector
- CPU fan, chassis fan, second fan and NB fan connectors

1.1.2 System Health Monitor Functions

The system board is capable of monitoring the following “system health” conditions.

- Monitors CPU/system temperature and overheat alarm
- Monitors $V_{core}/V_{CC3}/\pm 12V/V_{CC}/V_{BAT}/5V_{SB}$ voltages and failure alarm
- Monitors the fan speed of the chassis fan, CPU fan and NB fan; and failure alarm
- Read back capability that displays temperature, voltage and fan speed

1.1.3 Intelligence

CPU Fan Protection

The CPU Fan Protection function has the capability of monitoring the CPU fan when the system boots. Once it has detected that the CPU fan did not rotate, 5 warning beeps will sound then the system will automatically power-off. This preventive measure has been added to protect the CPU from damage and insure a safe computing environment.

CPU Temperature Protection

The CPU Temperature Protection function has the capability of monitoring the CPU's temperature during system boot-up. Once the system has detected that the CPU's temperature exceeded the temperature limit defined in the BIOS, 5 warning beeps will sound then the system will automatically power-off.

Dual Function Power Button

Depending on the setting in the "Soft-Off By PWR-BTTN" field of the Power Management Setup, this switch will allow the system to enter the Soft-Off or Suspend mode.

Wake-On-Ring

This feature allows the system that is in the Suspend mode or Soft Power Off mode to wake-up/power-on to respond to calls coming from an external modem or respond to calls from a modem PCI card that uses the PCI PME (Power Management Event) signal to remotely wake up the PC.



Important:

If you are using a modem add-in card, the 5VSB power source of your power supply must support a minimum of $\geq 720\text{mA}$.

Wake-On-LAN

This feature allows the network to remotely wake up a Soft Power Down (Soft-Off) PC. It is supported via the onboard LAN port, via a PCI LAN card that uses the PCI PME (Power Management Event) signal or via a LAN card that uses the Wake-On-LAN connector. However, if your system is in the Suspend mode, you can power-on the system only through an IRQ or DMA interrupt.



Important:

The 5VSB power source of your power supply must support $\geq 720\text{mA}$.

Wake-On-PS/2 Keyboard/Mouse

This function allows you to use the PS/2 keyboard or PS/2 mouse to power-on the system.



Important:

The 5VSB power source of your power supply must support $\geq 720\text{mA}$.

Wake-On-USB Keyboard

This function allows you to use a USB keyboard to wake up a system from the S3 (STR - Suspend To RAM) state.



Important:

- If you are using the Wake-On-USB Keyboard function for 2 USB ports, the 5VSB power source of your power supply must support $\geq 1.5\text{A}$.*
- If you are using the Wake-On-USB Keyboard function for 3 or more USB ports, the 5VSB power source of your power supply must support $\geq 2\text{A}$.*

RTC Timer to Power-on the System

The RTC installed on the system board allows your system to automatically power-on on the set date and time.

ACPI

The system board is designed to meet the ACPI (Advanced Configuration and Power Interface) specification. ACPI has energy saving features that enables PCs to implement Power Management and Plug-and-Play with operating systems that support OS Direct Power Management. Currently, only Windows® 98SE/2000/ME/XP supports the ACPI function. ACPI when enabled in the Power Management Setup will allow you to use the Suspend to RAM function.

With the Suspend to RAM function enabled, you can power-off the system at once by pressing the power button or selecting "Standby" when you shut down Windows® 98SE/2000/ME/XP without having to go through the sometimes tiresome process of closing files, applications and operating system. This is because the system is capable of storing all programs and data files during the entire operating session into RAM (Random Access Memory) when it powers-off. The operating session will resume exactly where you left off the next time you power-on the system.

Important:



The 5VSB power source of your power supply must support $\geq 1A$.

AC Power Failure Recovery

When power returns after an AC power failure, you may choose to either power-on the system manually, let the system power-on automatically or return to the state where you left off before power failure occurs.

1.2 Hyper-Threading Technology Functionality Requirements

Enabling the functionality of Hyper-Threading Technology for your computer system requires **ALL** of the following platforms.

Components:

- CPU - an Intel® Pentium® 4 Processor with HT Technology
- Chipset - an Intel® chipset that supports HT Technology
- BIOS - a BIOS that supports HT Technology and has it enabled
- OS - an operating system that includes optimizations for HT Technology

Please refer to Appendix A for information about enabling the functionality of the Hyper-Threading Technology. For more information on Hyper-Threading Technology, go to: www.intel.com/info/hyperthreading.

1.3 Package Checklist

The system board package contains the following items:

- One system board
- One user's manual
- One IDE cable
- One floppy cable
- One serial ATA data cable
- One I/O shield
- One "Main Board Utility" CD

If any of these items are missing or damaged, please contact your dealer or sales representative for assistance.

Chapter 2 - Hardware Installation

2.1 System Board Layout

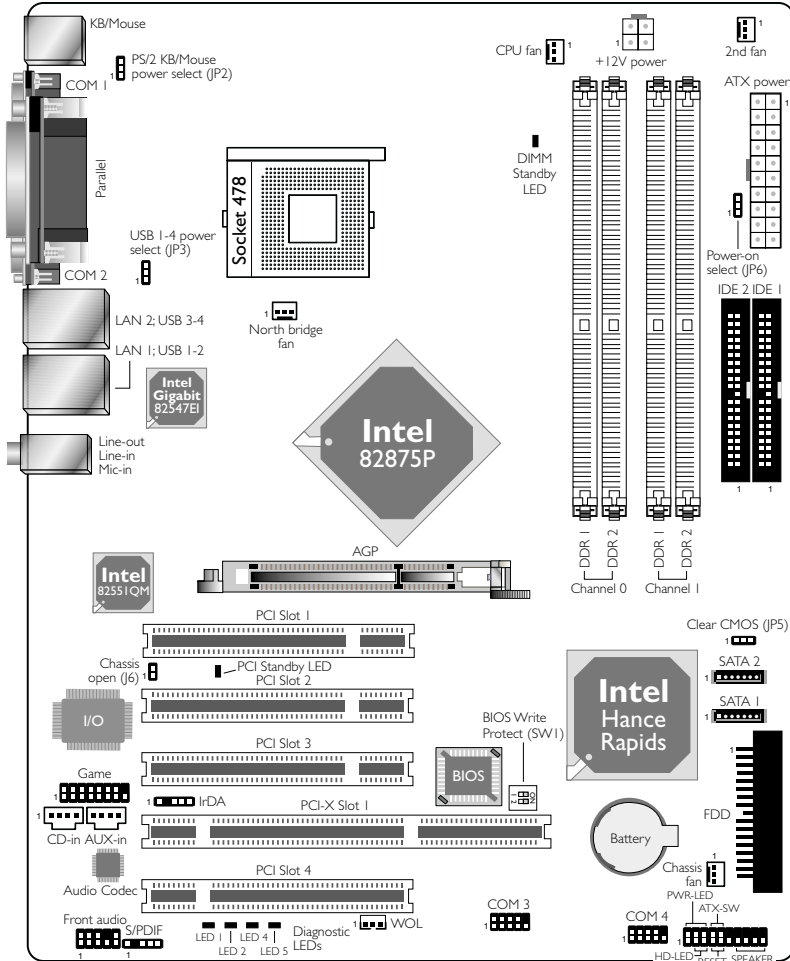

G4H875-N

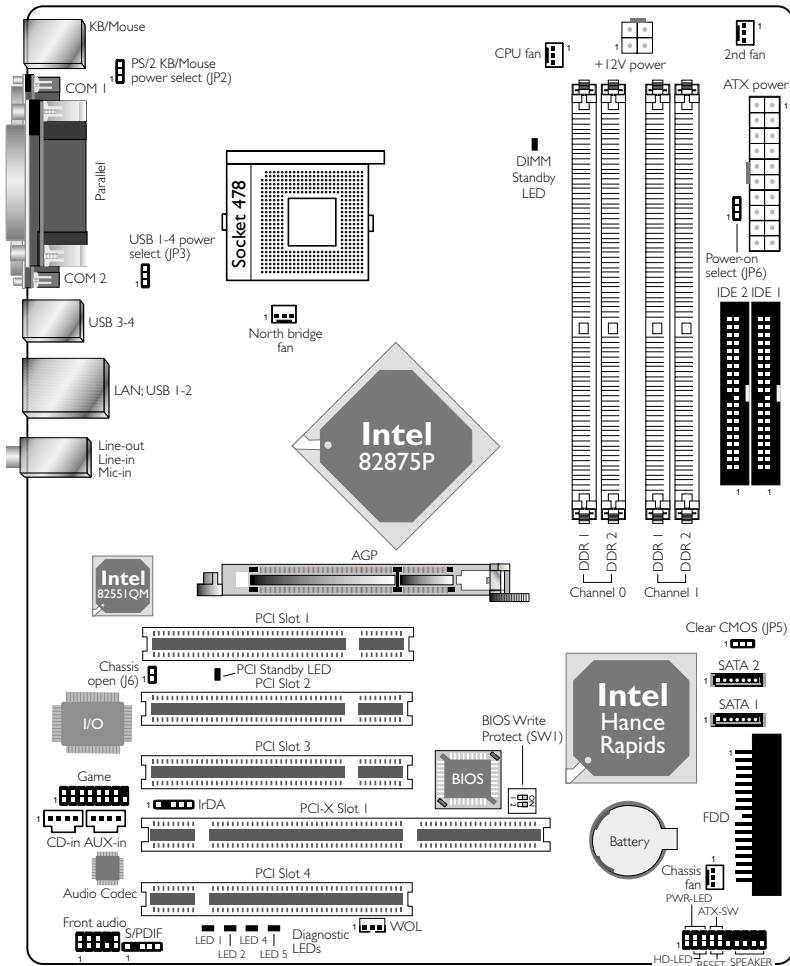

G4H875-C

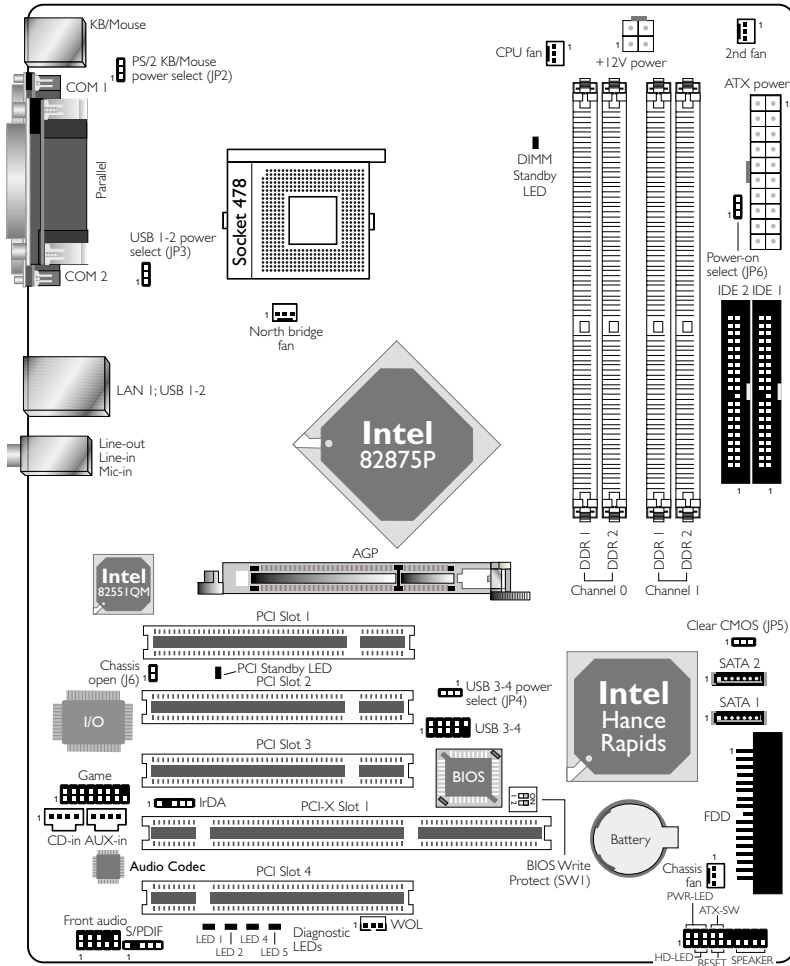

G4H875-B



Note:
 The illustrations on the following pages are based on the G4H875-N system board.

**Warning:**

Electrostatic discharge (ESD) can damage your system board, processor, disk drives, add-in boards, and other components. Perform the upgrade instruction procedures described at an ESD workstation only. If such a station is not available, you can provide some ESD protection by wearing an antistatic wrist strap and attaching it to a metal part of the system chassis. If a wrist strap is unavailable, establish and maintain contact with the system chassis throughout any procedures requiring ESD protection.

2.2 System Memory

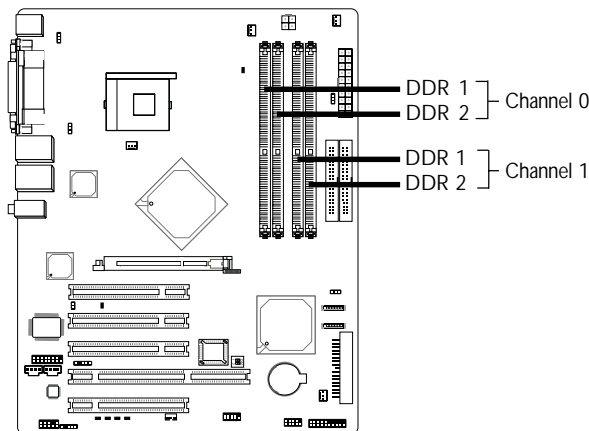

The system board supports DDR SDRAM DIMM. Double Data Rate SDRAM (DDR SDRAM) is a type of SDRAM that doubles the data rate through reading and writing at both the rising and falling edge of each clock. This effectively doubles the speed of operation therefore doubling the speed of data transfer.

The four DDR DIMM sockets on the system board are divided into 2 channels:

Channel 0 - DDR 1 and DDR 2

Channel 1 - DDR 1 and DDR 2

The system board supports the following memory interface.

Single Channel (SC)

Data will be accessed in chunks of 64 bits (8B) from the memory channels.

Virtual Single Channel (VSC)

If both channels are populated with different memory configurations, the MCH defaults to Virtual Single Channel.

Dual Channel (DC)

Dual channel provides better system performance because it doubles the data transfer rate.

Dynamic Mode Addressing

This mode minimizes the overhead of opening/closing pages in memory banks allowing for row switching to be done less often.

Single Channel	<ul style="list-style-type: none"> • DIMMs are on the same channel. • DIMMs in a channel can be identical or completely different. • Not all slots need to be populated.
Virtual Single Channel	<ul style="list-style-type: none"> • DIMMs of different memory configurations are on different channels. • Odd number of slots can be populated.
Dual Channel	<ul style="list-style-type: none"> • DIMMs of the same memory configuration are on different channels.
Dynamic Mode Addressing	<ul style="list-style-type: none"> • In single channel, requires even number of rows (side of the DIMM) populated. This mode can be enabled with 1 SS, 2 SS or 2 DS.
	<ul style="list-style-type: none"> • In VSC mode, both channels must have identical row structure.

BIOS Setting

Configure the system memory in the Advanced Chipset Features submenu of the BIOS.

The table below lists the various optimal operating modes that should be configured for the memory channel operation.

Config	DDR 1	DDR 2	DDR 3	DDR 4
No memory	E	E	E	E
Single channel A	P	E	E	E
Single channel A	P	P	E	E
Single channel A	E	P	E	E
Single channel B	E	E	P	E
Single channel B	E	E	P	P
Single channel B	E	E	E	P
Virtual single channel	E	P(**)	E	P(**)
Virtual single channel	E	P	P	E
Virtual single channel	E	P(**)	P	P(**)
Virtual single channel	P	E	E	P
Virtual single channel	P(**)	E	P(**)	E
Virtual single channel	p(**)	E	P(**)	P
Virtual single channel	P	P(**)	E	P(**)
Virtual single channel	P(**)	P	P(**)	E
Virtual single channel	P(**)	P(**)	P(**)	P(**)
Dual channel	E	P(*) (2,4)	E	P(*) (2,4)
Dual channel	P(*) (1,3)	E	P(*) (1,3)	E
Dual channel	P(*) (1,3)	P(*) (2,4)	P(*) (1,3)	P(*) (2,4)

Continued on the next page..

Config	DDR 1	DDR 2	DDR 3	DDR 4
Dynamic Mode Addressing	E	P(*) (2,4) DS	E	P(*) (2,4) DS
Dynamic Mode Addressing	P(*) (1,3) DS	E	P(*) (1,3) DS	E
Dynamic Mode Addressing	P(*) (1,3) DS	P(*) (2,4) DS	P(*) (1,3) DS	P(*) (2,4) DS
Dynamic Mode Addressing	E	P(*) (2,4) SS	E	P(*) (2,4) SS
Dynamic Mode Addressing	P(*) (1,3) SS	E	P(*) (1,3) SS	E
Dynamic Mode Addressing	P(*) (1,3) SS	P(*) (2,4) SS	P(*) (1,3) SS	P(*) (2,4) SS

P - denotes populated

E - denotes empty

* - denotes DIMMs are identical

** - denotes DIMMs are not identical

SS - denotes Single Sided DIMM

DS - denotes Double Sided DIMM

1, 2, 3 or 4 - denotes the DDR DIMM slot

2.2.1 Installing the DIM Module

A DIM module simply snaps into a DIMM socket on the system board. Pin 1 of the DIM module must correspond with Pin 1 of the socket.

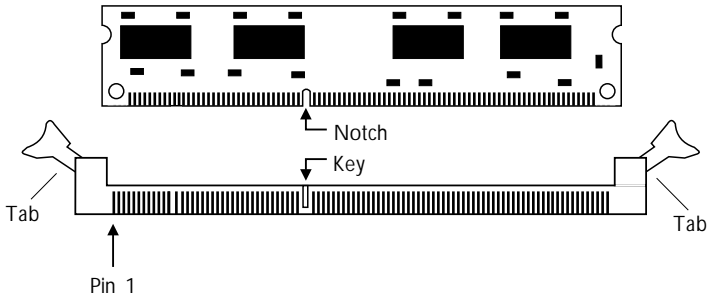

1. Pull the “tabs” which are at the ends of the socket to the side.
2. Position the DIMM above the socket with the “notch” in the module aligned with the “key” on the socket.
3. Seat the module vertically into the socket. Make sure it is completely seated. The tabs will hold the DIMM in place.

2.3 CPU

2.3.1 Overview

The system board is equipped with a surface mount 478-pin CPU socket. This socket is exclusively designed for installing an Intel processor.



2.3.2 Installing the CPU

1. Locate Socket 478 on the system board.
2. Unlock the socket by pushing the lever sideways, away from the socket, then lifting it up to a 90° angle. Make sure the socket is lifted to at least this angle otherwise the CPU will not fit in properly.

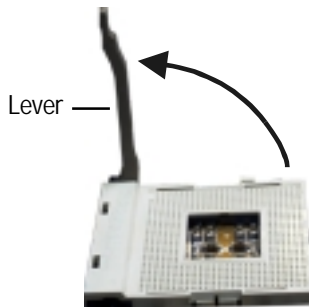

- Position the CPU above the socket then align the gold mark on the corner of the CPU (designated as pin 1) with pin 1 of the socket.



Important:

Handle the CPU by its edges and avoid touching the pins.



— Gold mark

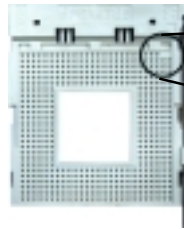

Pin 1

- Insert the CPU into the socket until it is seated in place. The CPU will fit in only one orientation and can easily be inserted without exerting any force.



Important:

Do not force the CPU into the socket. Forcing the CPU into the socket may bend the pins and damage the CPU.



5. Once the CPU is in place, push down the lever to lock the socket. The lever should click on the side tab to indicate that the CPU is completely secured in the socket.



2.3.3 Installing the Fan and Heat Sink

The CPU must be kept cool by using a CPU fan with heatsink. Without sufficient air circulation across the CPU and heat sink, the CPU will overheat damaging both the CPU and system board.



Note:

- *Only use Intel® certified fan and heat sink.*
- *An Intel® boxed processor package contains a retention mechanism, heat sink, fan and installation guide. If the installation procedure in the installation guide differs from the one in this section, please follow the installation guide in the package.*
- *If you are installing a non-boxed processor, the heat sink, fan and retention mechanism assembly may look different from the one shown in this section but the procedure will more or less be the same.*

1. The system board comes with the retention module base already installed.

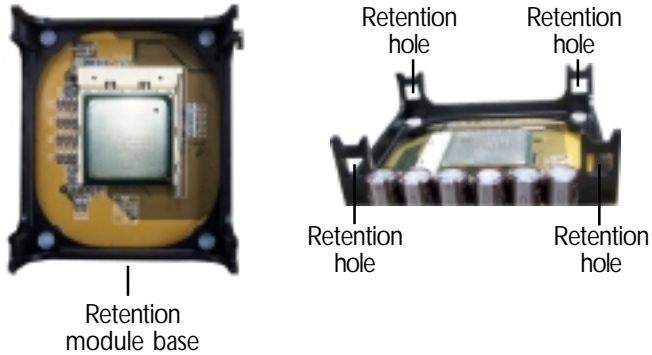

2. Position the fan / heat sink and retention mechanism assembly on the CPU, then align and snap the retention legs' hooks to the retention holes at the 4 corners of the retention module base.

**Note:**

You will not be able to snap the hooks into the holes if the fan / heat sink and retention mechanism assembly did not fit properly onto the CPU and retention module base.

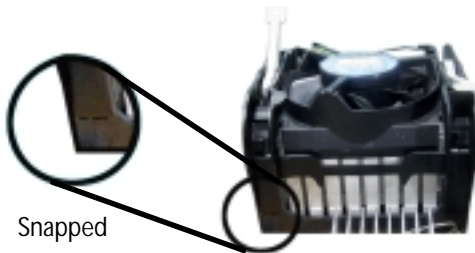

- The retention levers at this time remains unlocked as shown in the illustration below.



- Move the retention levers to their opposite directions then push them down. This will secure the fan / heat sink and retention mechanism assembly to the retention module base.



Note:

You will not be able to push the lever down if the direction is incorrect.



- Connect the CPU fan's cable connector to the CPU fan connector on the system board.

2.4 Jumper Settings

2.4.1 Clearing CMOS Data

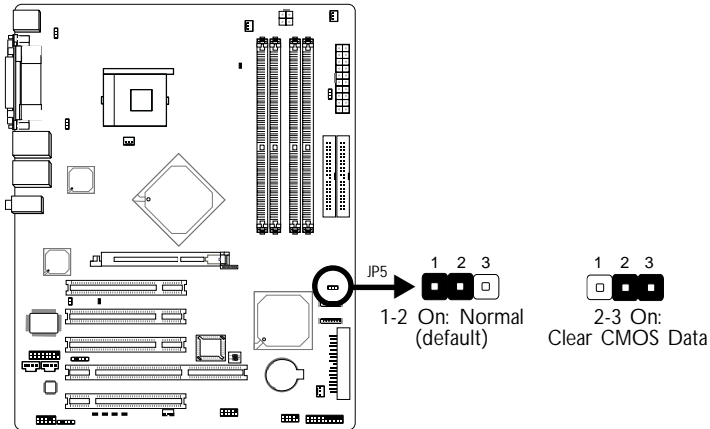

If you encounter the following,

- CMOS data becomes corrupted.*
- You forgot the supervisor or user password.*
- You are unable to boot-up the computer system because the processor's ratio/clock was incorrectly set in the BIOS.*

you can reconfigure the system with the default values stored in the ROM BIOS.

To load the default values stored in the ROM BIOS, please follow the steps below.

1. Power-off the system.
2. Set JP5 pins 2 and 3 to On. Wait for a few seconds and set JP5 back to its default setting, pins 1 and 2 On.
3. Now power-on the system.

If your reason for clearing the CMOS data is due to incorrect setting of the processor's ratio/clock in the BIOS, please proceed to step 4.

4. After powering-on the system, press to enter the main menu of the BIOS.
5. Select the Frequency/Voltage Control submenu and press <Enter>.
6. Set the "CPU Clock Ratio" or "CPU Clock" field to its default setting or an appropriate bus clock or frequency ratio. Refer to the Frequency/Voltage Control section in chapter 3 for more information.
7. Press <Esc> to return to the main menu of the BIOS setup utility. Select "Save & Exit Setup" and press <Enter>.
8. Type <Y> and press <Enter>.

2.4.2 PS/2 Keyboard/Mouse Wake Up

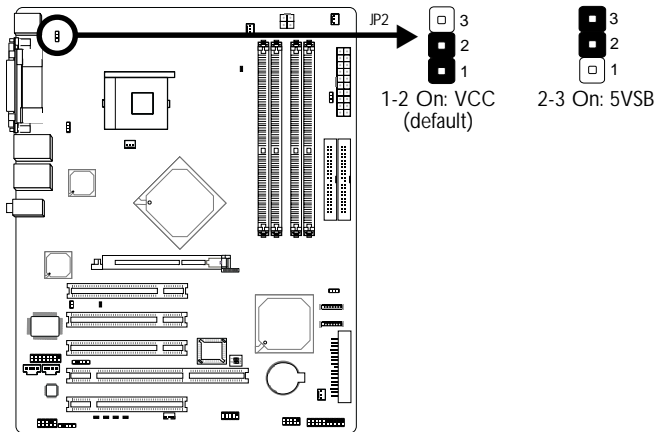

This jumper is used to select the power of the PS/2 Keyboard/Mouse port. Selecting 5VSB will allow you to use the Wake-On-PS/2 Keyboard/Mouse function.

BIOS Setting:

“Power On Function” (“Super IO Device” section) in the Integrated Peripherals submenu of the BIOS must be set accordingly. Refer to chapter 3 for more information.



Warning:

The 5VSB power source of your power supply must support $\geq 2A$.

2.4.3 USB Keyboard Wake Up

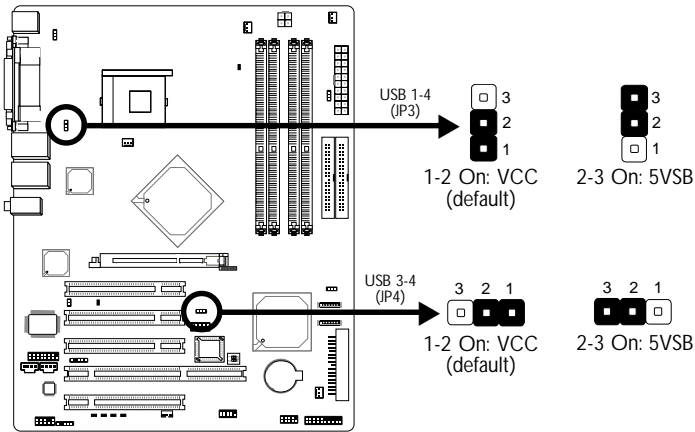

These jumpers are used to select the power of the USB ports. Selecting 5VSB will allow you to use the Wake-On-USB Keyboard function.

On the G4H875-N and G4H875-C system boards, JP3 is for setting USB 1-4 that are at the rear I/O panel. USB 3-4 are not present at the rear I/O panel of the G4H875-B system board, therefore JP3 on this board is for setting USB 1-2 only.

On the G4H875-B system board, JP4 is for setting the external ports connected to J12 (USB 3-4 connector).

BIOS Setting:

“USB KB WakeUp From S3(S4)” in the Power Management Setup submenu of the BIOS must be set to Enabled. Refer to chapter 3 for more information.

**Important:**

- If you are using the Wake-On-USB Keyboard function for 2 USB ports, the 5VSB power source of your power supply must support $\geq 2A$.
- If you are using the Wake-On-USB Keyboard function for 3 or more USB ports, the 5VSB power source of your power supply must support $\geq 2A$.

2.4.4 Power-on Select

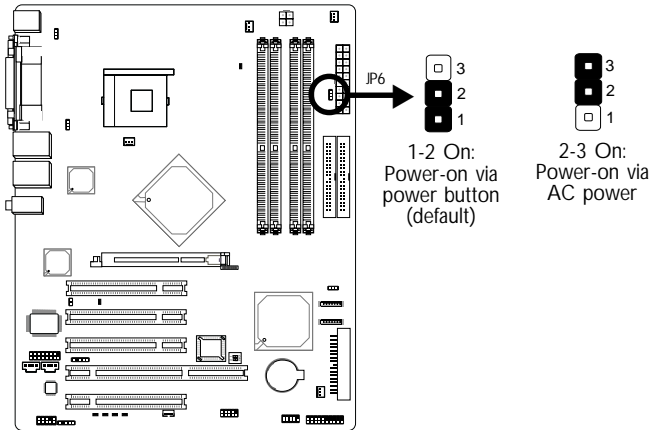

This jumper is used to select the method of powering on the system. If you want the system to power-on once AC power comes in, set JP6 pins 2 and 3 to On. If you want to use the power button, set pins 1 and 2 to On.

2.4.5 BIOS Write Protect

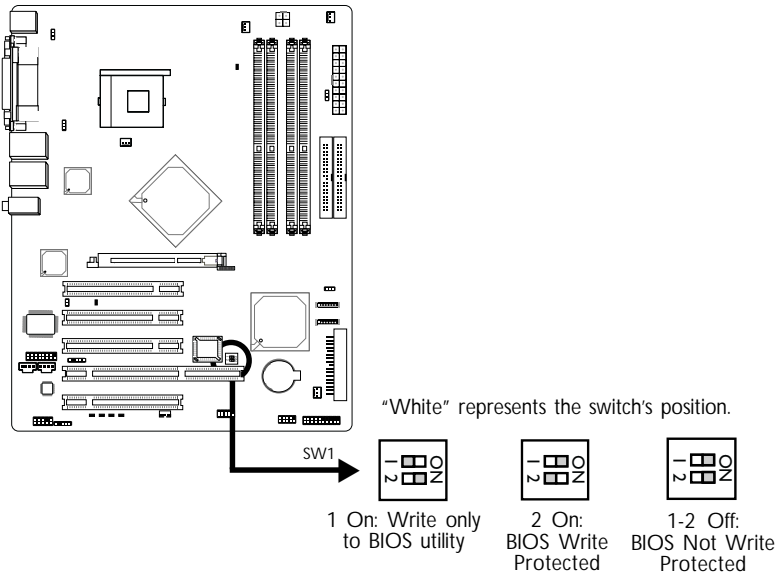

SW1 is used to configure the BIOS Write Protect function. When this function is enabled, the system will be protected from unnecessary updating or flashing of the BIOS. It secures the BIOS therefore any updates to it will not take effect.

1 On:

The BIOS is basically protected but will allow you to update changes ONLY by using the "Save & Exit Setup" function in the BIOS setup utility. This prevents accidental flashing of the BIOS.

2 On:

The BIOS Write Protect function is enabled. The BIOS is secured therefore you cannot update or flash the BIOS.

1 and 2 Off:

The BIOS Write Protect function is disabled. You can update or flash the BIOS anytime needed.

2.5 Rear Panel I/O Ports

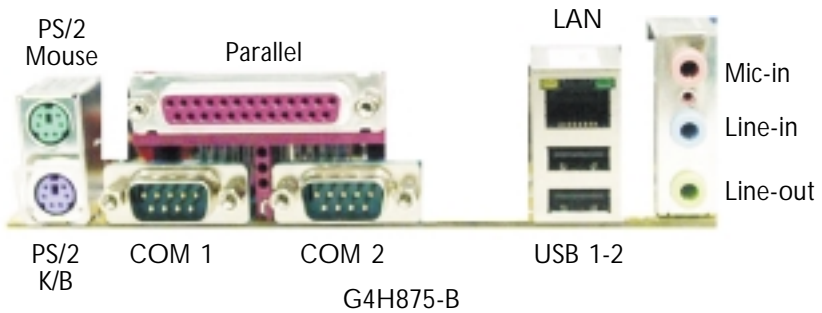
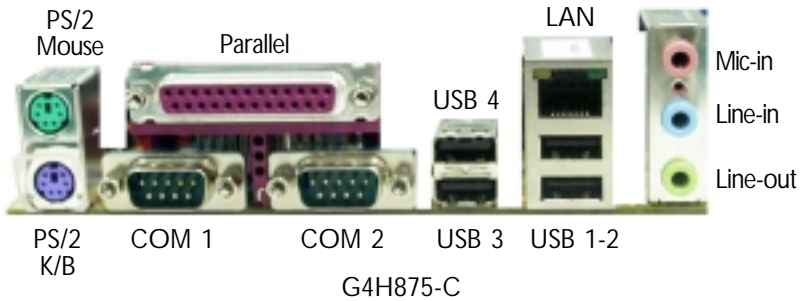
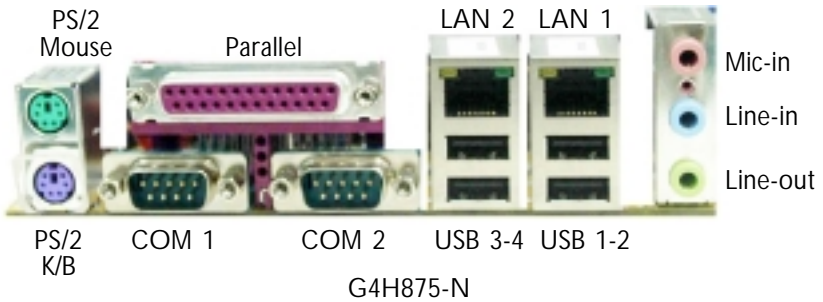

2.5.1 PS/2 Mouse and PS/2 Keyboard Ports

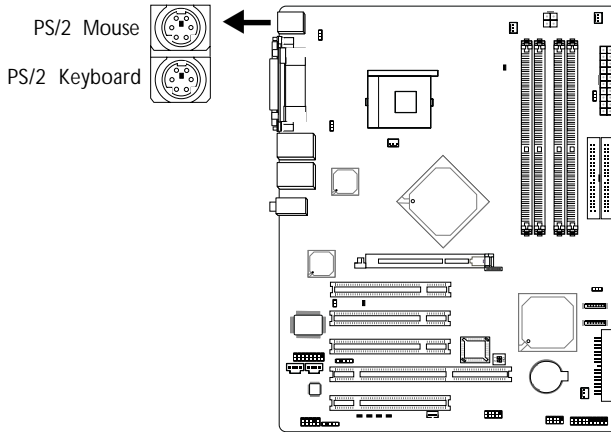

The system board is equipped with an onboard PS/2 mouse (Green) and PS/2 keyboard (Purple) ports - both at location CN1 of the system board. The PS/2 mouse port uses IRQ12. If a mouse is not connected to this port, the system will reserve IRQ12 for other expansion cards.

**Warning:**

Make sure to turn off your computer prior to connecting or disconnecting a mouse or keyboard. Failure to do so may damage the system board.

Wake-On-PS/2 Keyboard/Mouse

The Wake-On-PS/2 Keyboard/Mouse function allows you to use the PS/2 keyboard or PS/2 mouse to power-on the system. To use this function:

- **Jumper Setting:**
JP2 must be set to "2-3 On: 5VSB". Refer to "PS/2 Keyboard/Mouse Wake Up" in this chapter for more information.
- **BIOS Setting:**
"Power On Function" ("Super IO Device" section) in the Integrated Peripherals submenu of the BIOS must be set accordingly. Refer to chapter 3 for more information.

2.5.2 Serial Ports

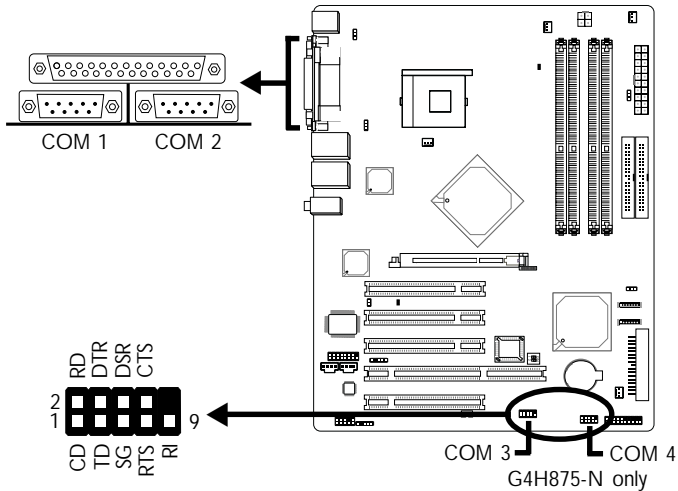

G4H875-N is equipped with 2 onboard serial ports (COM 1: CN3 and COM 2: CN4) - both in Teal/Turquoise color. It is also equipped with two 9-pin connectors (COM 3: J14 and COM 4: J16) for connecting external serial ports.

G4H875-C and G4H875-B are each equipped with COM 1 (CN3) and COM 2 (CN4). COM 3 and COM 4 are not present on these boards.

To use J14 or J16 to connect external serial ports, please refer to the following description. The serial ports may be mounted on a card-edge bracket. Install the card-edge bracket to the system chassis then insert the cable connector to J14 or J16. Make sure the colored stripe on the ribbon cable is aligned with pin 1 of J14 or J16.

Serial ports are RS-232C asynchronous communication ports with 16C550A-compatible UARTs that can be used with modems, serial printers, remote display terminals, and other serial devices.

BIOS Setting

Select the serial ports' I/O address in the Integrated Peripherals submenu ("Super IO Device" section) of the BIOS. Refer to chapter 3 for more information.

2.5.3 Parallel Port

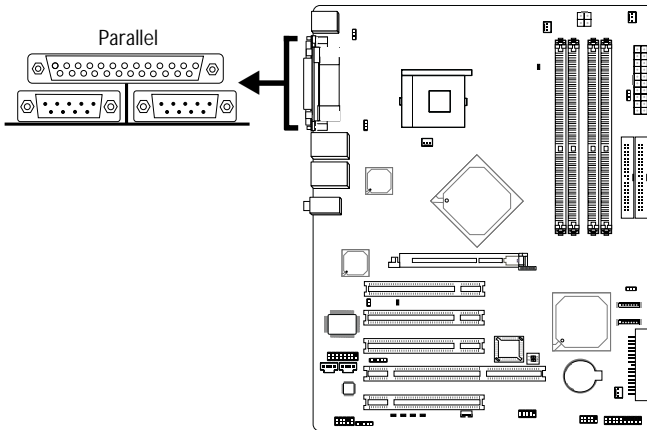

The system board has a standard parallel port (Burgundy) at location CN7 for interfacing your PC to a parallel printer. It supports SPP, ECP and EPP.

Setting	Function
SPP (Standard Parallel Port)	Allows normal speed operation but in one direction only.
ECP (Extended Capabilities Port)	Allows parallel port to operate in bidirectional mode and at a speed faster than the SPP's data transfer rate.
EPP (Enhanced Parallel Port)	Allows bidirectional parallel port operation at maximum speed.

BIOS Setting

Select the parallel port's mode in the Integrated Peripherals submenu ("Super IO Device" section) of the BIOS. Refer to chapter 3 for more information.

2.5.4 Universal Serial Bus Ports

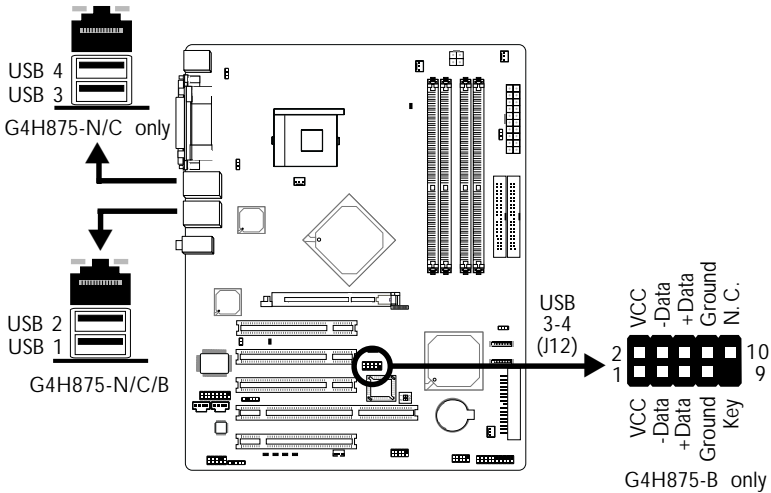

The system board supports USB 2.0/1.1 ports. USB allows data exchange between your computer and a wide range of simultaneously accessible external Plug and Play peripherals.

G4H875-N and G4H875-C are each equipped with four onboard USB 2.0/1.1 ports (Black) are at locations CN5 (USB 3-4) and CN6 (USB 1-2) of the system board.

G4H875-B is equipped with two onboard USB ports (USB 1-2) at location CN6. It is also equipped with a connector at location J12 for connecting additional external USB ports.

To use J12 to connect external USB ports, please refer to the following description. The USB ports may be mounted on a card-edge bracket. Install the card-edge bracket to the system chassis then insert the connector that is attached to the USB port cables to J12. Make sure pin 1 of the cable connector is aligned with pin 1 of J12.

BIOS Setting

Configure USB in the Integrated Peripherals submenu (“Onboard Device” section) of the BIOS. Refer to chapter 3 for more information.

Driver Installation

You may need to install the proper drivers in your operating system to use the USB device. Refer to your operating system’s manual or documentation for more information.

If you are using a USB 2.0 device, install the “Intel USB 2.0 Drivers”. Refer to chapter 4 for more information.

Wake-On-USB Keyboard

The Wake-On-USB Keyboard function allows you to use a USB keyboard to wake up a system from the S3 (STR - Suspend To RAM) state. To use this function:

- Jumper Setting:
JP3 and/or JP4 must be set to “2-3 On: 5VSB”. Refer to “USB Keyboard Wake Up” in this chapter for more information.
- BIOS Setting:
“USB KB WakeUp From S3(S4)” in the Power Management Setup submenu of the BIOS must be set to Enabled. Refer to chapter 3 for more information.



Important:

- *If you are using the Wake-On-USB Keyboard function for 2 USB ports, the 5VSB power source of your power supply must support $\geq 2A$.*
- *If you are using the Wake-On-USB Keyboard function for 3 or more USB ports, the 5VSB power source of your power supply must support $\geq 2A$.*

2.5.5 RJ45 LAN Port

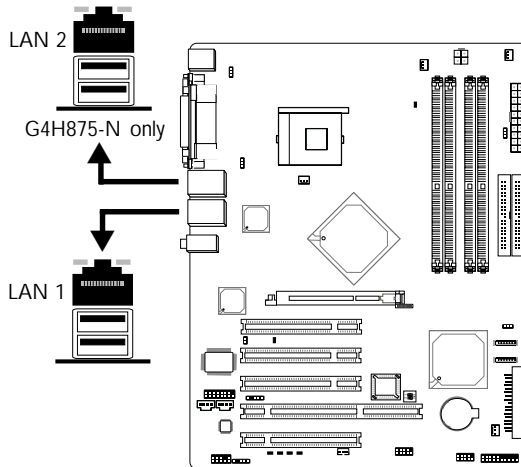

G4H875-N is equipped with 2 onboard RJ45 LAN ports. LAN 1 which is controlled by the Intel 82551QM chip is at location CN6 and LAN 2 which is controlled by the Intel Gigabit 82547EI chip is at location CN5.

G4H875-C and G4H875-B are each equipped with the LAN 1 port only.

LAN allows the system board to connect to a local area network by means of a network hub.

BIOS Setting

Enable or disable the Gigabit LAN in the Integrated Peripherals submenu (“Onboard Device” section) of the BIOS. Refer to chapter 3 for more information.

Driver Installation

Install the “Intel LAN Drivers”. Refer to chapter 4 for more information.

2.5.6 Audio

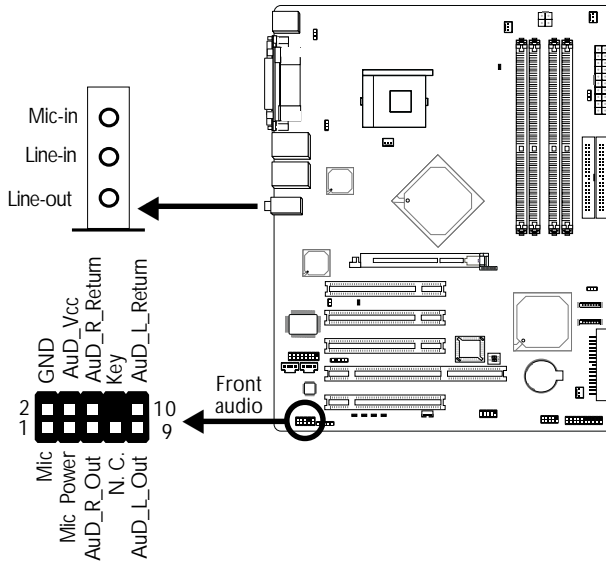

Mic-in, Line-in and Line-out

The mic-in, line-in and line-out jacks are at location CN2 of the system board. A jack is a one-hole connecting interface for inserting a plug.

- **Mic-in Jack (Pink)**
This jack is used to connect an external microphone.
- **Line-in Jack (Light Blue)**
This jack can be connected to the line-out jack of any external audio devices such as Hi-fi set, CD player, AM/FM radio tuner, synthesizer, etc. Connect a stereo cable from the line-out jack of your external device to this line-in jack.
- **Line-out Jack (Lime)**
This jack is used to connect external speakers for audio output from the system board. Using this jack disables the front audio's line-out function.

Front Audio

The front audio connector (J3) allows you to connect to the line-out and mic-in jacks that are at the front panel of your system. Using this connector will disable the rear audio's line-out and mic-in functions.

Remove the jumper caps from pins 5-6 and pins 9-10 of J3 prior to connecting the front audio cable connector. Make sure pin 1 of the cable connector is aligned with pin 1 of J3. If you are not using this connector, make sure to replace the jumper caps back to their original pin locations.

Pins 5-6 and 9-10 short (default)	The front audio is disabled. The rear audio is enabled.
Pins 5-6 and 9-10 open	The front audio is enabled. The rear audio is disabled.

Driver Installation

Install the "Audio Drivers". Refer to chapter 4 for more information.

2.6 I/O Connectors

2.6.1 Game/MIDI Port

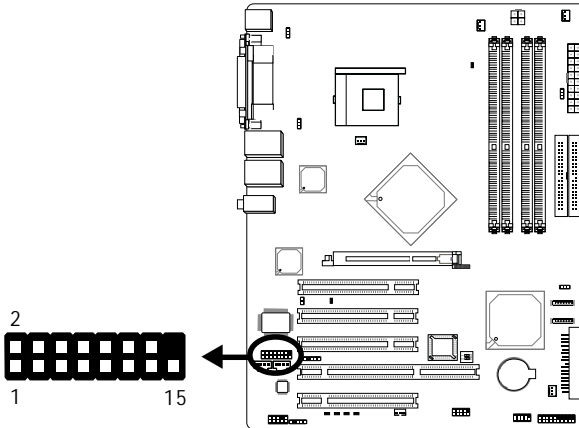

The system board is equipped with a 15-pin connector at location J2 for connecting an external game/MIDI port. The game/MIDI port may be mounted on a card-edge bracket. Install the card-edge bracket to the system chassis then connect the game/MIDI port cable to connector J2. Make sure the colored stripe on the ribbon cable is aligned with pin 1 of connector J2.

BIOS Setting

Configure the game port in the Integrated Peripherals submenu ("Super I/O Device" section) of the BIOS. Refer to chapter 3 for more information.

2.6.2 Internal Audio Connectors

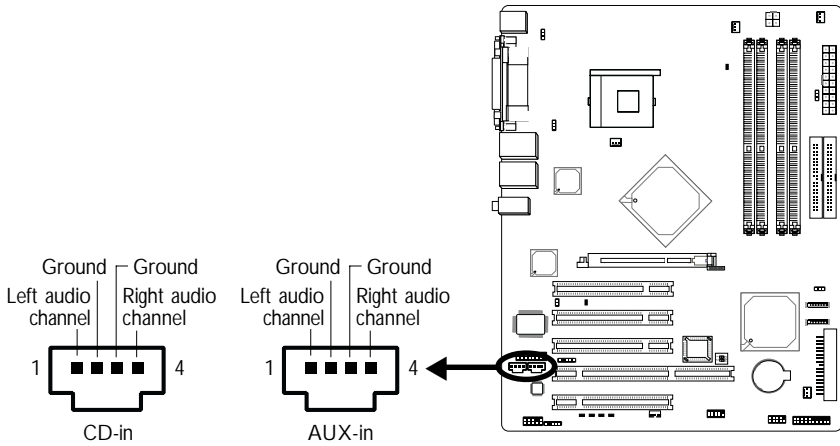

The CD-in (J1) and AUX-in (J4) connectors are used to receive audio from a CD-ROM drive, TV tuner or MPEG card.

2.6.3 S/PDIF Connector

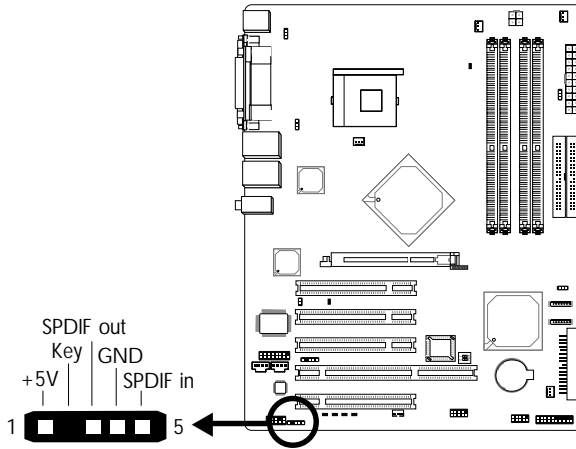

The S/PDIF connector (J5) is used to connect external S/PDIF ports. The S/PDIF ports may be mounted on a card-edge bracket. Install the card-edge bracket to the system chassis then connect the audio cable connector to J5. Make sure pin 1 of the audio cable connector is aligned with pin 1 of J5.

2.6.4 Floppy Disk Drive Connector

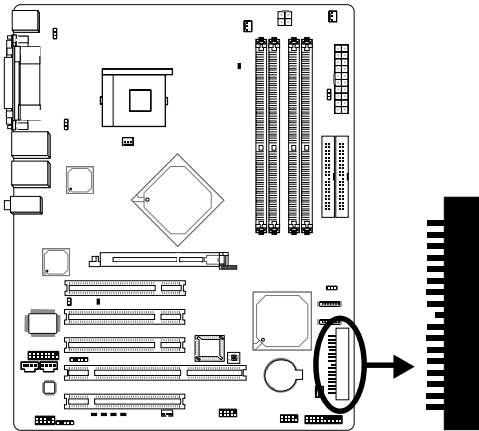

The system board is equipped with a shrouded floppy disk drive connector for connecting a standard floppy disk drive. To prevent improper floppy cable installation, the shrouded floppy disk header has a keying mechanism. The 34-pin connector on the floppy cable can be placed into the header only if pin 1 of the connector is aligned with pin 1 of the header.

Connecting the Floppy Disk Drive Cable

Install one end of the floppy disk drive cable into the shrouded floppy disk header (J21) on the system board and the other end-most connector to the floppy drive. The colored edge of the daisy chained ribbon cable should be aligned with pin 1 of J21.

BIOS Setting

Enable or disable this function in the Integrated Peripherals submenu ("Super I/O Device" section) of the BIOS. Refer to chapter 3 for more information.

2.6.5 Serial ATA Connectors

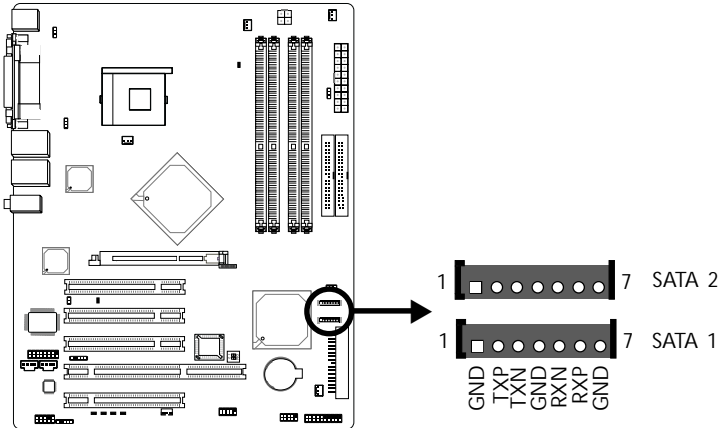

Connect one end of the SATA cable to J22 (SATA 2) or J23 (SATA 1) and the other end to your serial ATA device.

BIOS Setting

Configure the Serial ATA drives in the Integrated Peripherals submenu ("OnChip IDE Device" section) of the BIOS. Refer to chapter 3 for more information.

2.6.6 IDE Disk Drive Connector

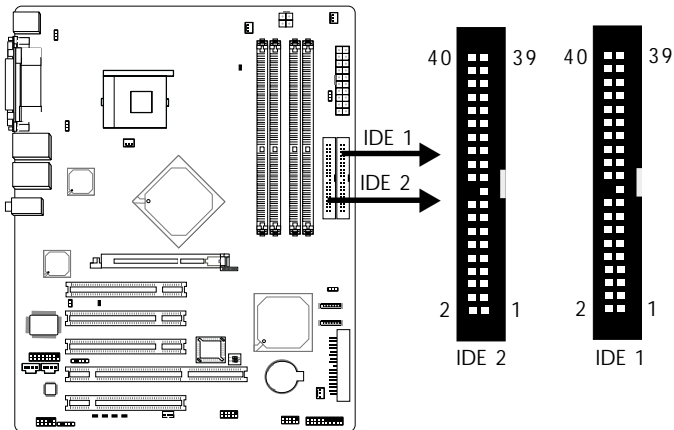

The system board is equipped with two shrouded PCI IDE headers that will interface four Enhanced IDE (Integrated Drive Electronics) disk drives. To prevent improper IDE cable installation, each shrouded PCI IDE header has a keying mechanism. The 40-pin connector on the IDE cable can be placed into the header only if pin 1 of the connector is aligned with pin 1 of the header.

Each IDE connector supports 2 devices, a Master and a Slave. Use an IDE ribbon cable to connect the drives to the system board. An IDE ribbon cable has 3 connectors on them, one that plugs into an IDE connector on the system board and the other 2 connect to IDE devices. The connector at the end of the cable is for the Master drive and the connector in the middle of the cable is for the Slave drive.

Connecting the IDE Disk Drive Cable

Install one end of the IDE cable into the IDE 1 header (J26) on the system board and the other connectors to the IDE devices.

If you are adding a third or fourth IDE device, use another IDE cable and install one end of the cable into the IDE 2 header (J24) on the system board and the other connectors to the IDE devices.

**Note:**

Refer to your disk drive user's manual for information about selecting proper drive switch settings.

Adding a Second IDE Disk Drive

When using two IDE drives, one must be set as the master and the other as the slave. Follow the instructions provided by the drive manufacturer for setting the jumpers and/or switches on the drives.

The system board supports Enhanced IDE or ATA-2, ATA/33, ATA/66 or ATA/100 hard drives. We recommend that you use hard drives from the same manufacturer. In a few cases, drives from two different manufacturers will not function properly when used together. The problem lies in the hard drives, not the system board.

**Important:**

If you encountered problems while using an ATAPI CD-ROM drive that is set in Master mode, please set the CD-ROM drive to Slave mode. Some ATAPI CD-ROMs may not be recognized and cannot be used if incorrectly set in Master mode.

BIOS Setting

Enable or disable the onboard primary or secondary IDE in the Integrated Peripherals submenu ("OnChip IDE Device" section) of the BIOS. Refer to chapter 3 for more information.

2.6.7 IrDA Connector

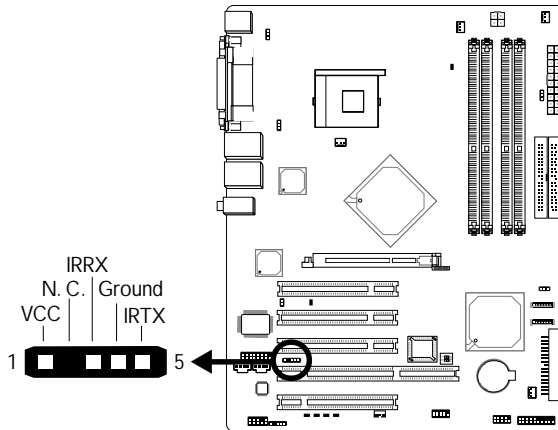

Connect your IrDA cable to connector J7 on the system board.



Note:

The sequence of the pin functions on some IrDA cable may be reversed from the pin function defined on the system board. Make sure to connect the cable to the IrDA connector according to their pin functions.

BIOS Setting

Configure IrDA in the Integrated Peripherals submenu ("Super IO Device" section) of the BIOS.

Driver Installation

You may need to install the proper drivers in your operating system to use the IrDA function. Refer to your operating system's manual or documentation for more information.

2.6.8 Cooling Fan Connectors

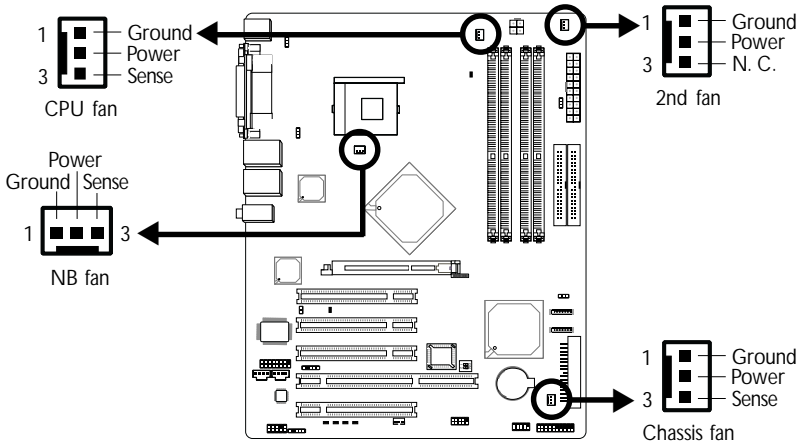

Connect the CPU fan's cable connector to the CPU fan connector (J13) on the system board. Connect the Intel 875P fan's cable connector to the NB fan connector (J27) on the system board. The chassis fan (J19) and second fan (J25) connectors are used to connect additional cooling fans. The cooling fans will provide adequate airflow throughout the chassis to prevent overheating the CPU and system board components.

BIOS Setting

The system is capable of monitoring the speed of the CPU fan, NB fan and chassis fan. The "PC Health Status" submenu of the BIOS will display the current speed of these cooling fans. Refer to chapter 3 for more information.

More Information

Refer to appendix B for information on using the CPU Fan Protection function.

2.6.9 Wake-On-LAN Connector

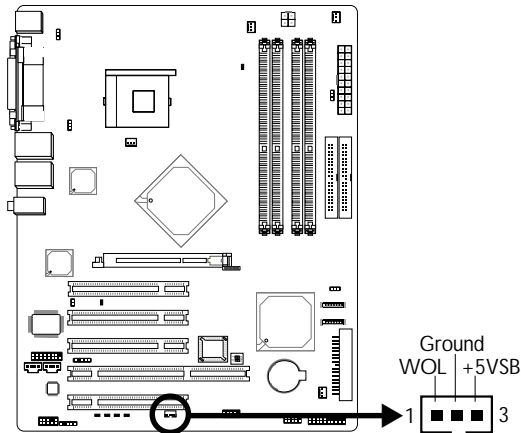

Your LAN card package should include a cable. Connect one end of the cable to the wakeup header on the card and the other end to location J10 on the system board. The network will detect Magic Packet and assert a wake up signal to power-up the system. Refer to the add-in card's manual for details. Note: Your LAN card must support the remote wake up function.



Important:

The 5VSB power source of your power supply must support $\geq 720\text{mA}$.

BIOS Setting

To use the Wake-On-LAN function, you must enable the "Wake Up On LAN Connector" field in the Power Management Setup of the BIOS.

2.6.10 Chassis Open Connector

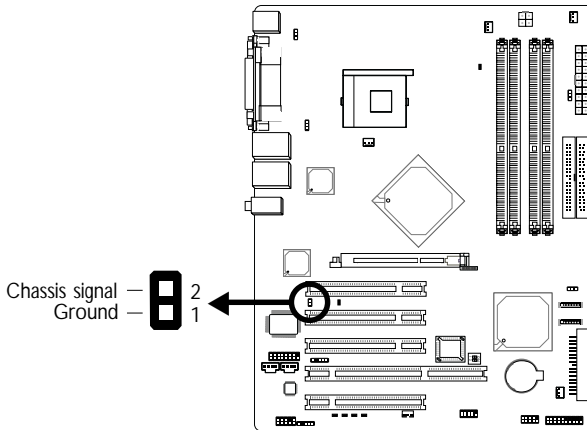

The system board supports the chassis intrusion detection function. To use this function, connect the chassis intrusion sensor cable from the chassis to J6. Whenever a chassis component has been removed, the sensor sends signal to J6 alerting you of a chassis intrusion event. To disable this function, place a jumper cap over J6.

Hardware Doctor Utility

Install "Hardware Doctor". By default, the chassis intrusion detection function is disabled. When enabled, a warning message will appear when the chassis is open. The utility can also be configured so that a beeping alarm will sound when the chassis is open. Refer to the "Hardware Doctor" section in chapter 4 for more information.

2.6.11 LEDs

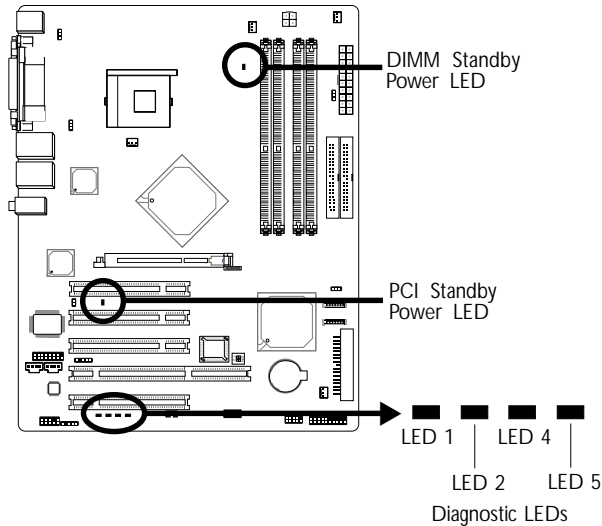

DIMM Standby Power LED

This LED will turn red when the system's power is on or when it is in the Suspend state (Power On Suspend or Suspend to RAM). It will not light when the system is in the Soft-Off state.

PCI Standby Power LED

This LED will turn red when the system is in the power-on, Soft-Off or Suspend (Power On Suspend or Suspend to RAM) state.



Important:

If the DIMM Standby Power LED or PCI Standby Power LED is lighted, you must power-off the system then turn off the power supply's switch or unplug the power cord prior to installing any memory modules or add-in cards.

Diagnostic LEDs

The 4 diagnostic LEDs are used to indicate the current condition of the system. Refer to the table on the next page for a list of LEDs' status and their corresponding system condition.

	LED 1	LED 2	LED 4	LED 5
Early program chipset register before POST.	On	Off	Off	Off
Testing memory presence.	Off	On	Off	Off
Detecting memory size.	On	On	Off	Off
No memory present.	Off	Off	On	Off
Programming DRAM timing register.	On	Off	On	Off
Calculating DRAM size variable including row, column and bank.	Off	On	On	Off
Initializing JEDEC of current DRAM row.	On	On	On	Off
Checking CMOS checksum and battery.	Off	Off	Off	On
Initializing the clock generator.	On	Off	Off	On
Initializing USB.	Off	On	Off	On
Testing all memory (cleared all extended memory to 0).	On	On	Off	On
Initializing the onboard Super IO.	Off	Off	On	On
Detecting and installing an IDE device.	On	Off	On	On
Final initialization.	Off	On	On	On
Booting the system.	On	On	On	On

2.6.12 Power Connectors

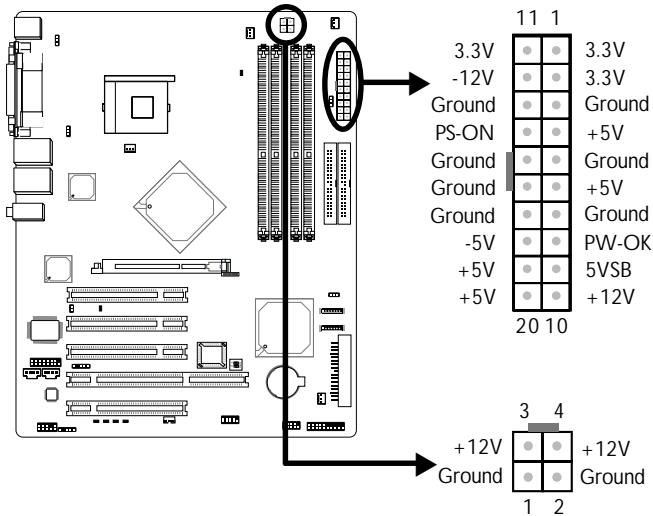

We recommend that you use a power supply that complies with the ATX12V Power Supply Design Guide Version 1.1. An ATX12V power supply has a standard 20-pin ATX main power connector and a 4-pin +12V power connector that must be inserted onto CN9 and CN8 connectors respectively.

The 4-pin +12V power connector enables the delivery of more +12VDC current to the processor's Voltage Regulator Module (VRM).

The system board requires a minimum of 250 Watt power supply to operate. Your system configuration (amount of memory, add-in cards, peripherals, etc.) may exceed the minimum power requirement. To ensure that adequate power is provided, use a 300 Watt (or greater) power supply.

2.6.13 Front Panel Connectors

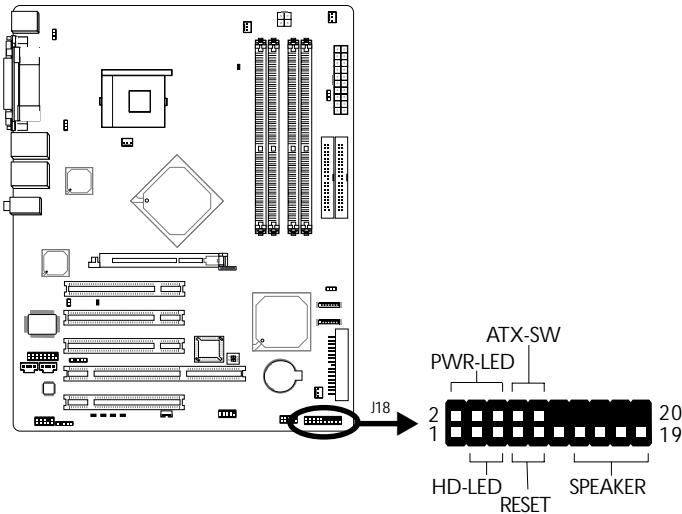
**HD-LED: Primary/Secondary IDE LED**

This LED will light when the hard drive is being accessed.

RESET: Reset Switch

This switch allows you to reboot without having to power off the system thus prolonging the life of the power supply or system.

SPEAKER: Speaker Connector

This connects to the speaker installed in the system chassis.

ATX-SW: ATX Power Switch

Depending on the setting in the BIOS setup, this switch is a “dual function power button” that will allow your system to enter the Soft-Off or Suspend mode. Refer to “Soft-Off By PWR-BTTN” in the Power Management Setup (Chapter 3).

PWR-LED: Power/Standby LED

When the system's power is on, this LED will light. When the system is in the S1 (POS - Power On Suspend) state, it will blink every second. When the system is in the S3 (STR - Suspend To RAM) state, it will blink every second.

**Note:**

If a system did not boot-up and the Power/Standby LED did not light after it was powered-on, it may indicate that the CPU or memory module was not installed properly. Please make sure they are properly inserted into their corresponding socket.

	Pin	Pin Assignment
HD-LED (Primary/Secondary IDE LED)	3 5	HDD LED Power HDD
Reserved	14 16	N. C. N. C.
ATX-SW (ATX power switch)	8 10	PWRBT+ PWRBT-
Reserved	18 20	N. C. N. C.
RESET (Reset switch)	7 9	Ground H/W Reset
SPEAKER (Speaker connector)	13 15 17 19	Speaker Data N. C. Ground Speaker Power
PWR-LED (Power/Standby LED)	2 4 6	LED Power (+) LED Power (+) LED Power (-) or Standby Signal

Chapter 3 - BIOS Setup

3.1 Award BIOS Setup Utility

The Basic Input/Output System (BIOS) is a program that takes care of the basic level of communication between the processor and peripherals. In addition, the BIOS also contains codes for various advanced features found in this system board. This chapter explains the Setup Utility for the Award BIOS.

After you power up the system, the BIOS message appears on the screen and the memory count begins. After the memory test, the following message will appear on the screen:

Press DEL to enter setup

If the message disappears before you respond, restart the system or press the "Reset" button. You may also restart the system by pressing the <Ctrl> <Alt> and keys simultaneously.

When you press , the main menu screen will appear.



3.1.1 Standard CMOS Features

Use the arrow keys to highlight “Standard CMOS Features” and press <Enter>. A screen similar to the one below will appear.



The settings on the screen are for reference only. Your version may not be identical to this one.

3.1.1.1 Date

The date format is <day>, <month>, <date>, <year>. Day displays a day, from Sunday to Saturday. Month displays the month, from January to December. Date displays the date, from 1 to 31. Year displays the year, from 1990 to 2098.

3.1.1.2 Time

The time format is <hour>, <minute>, <second>. The time is based on the 24-hour military-time clock. For example, 1 p.m. is 13:00:00. Hour displays hours from 00 to 23. Minute displays minutes from 00 to 59. Second displays seconds from 00 to 59.

3.1.1.3 IDE Channel 0 Master, IDE Channel 0 Slave, IDE Channel 1 Master and IDE Channel 1 Slave

Move the cursor to the "IDE Channel 0 Master", "IDE Channel 0 Slave", "IDE Channel 1 Master" or "IDE Channel 1 Slave" field, then press <Enter>.



Note:

The fields in this section will vary in accordance to the settings in the "On-Chip Serial ATA" field ("OnChip IDE Device" section) of the Integrated Peripherals submenu.

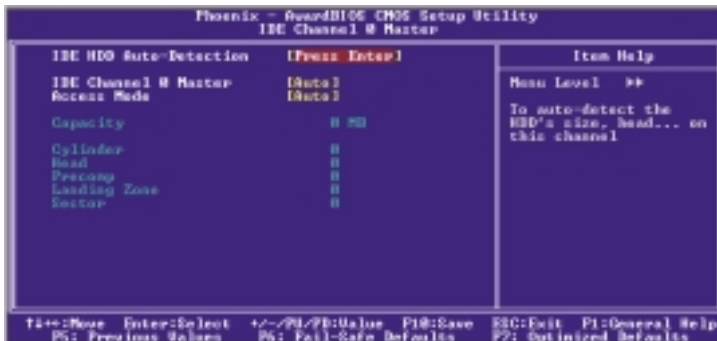

The settings on the screen are for reference only. Your version may not be identical to this one.

IDE HDD Auto Detection

Detects the parameters of the drive. The parameters will automatically be shown on the screen.

IDE Channel 0 Master/Slave and IDE Channel 1 Master/Slave

The drive type information should be included in the documentation from your hard disk vendor. If you select "Auto", the BIOS will auto-detect the HDD & CD-ROM drive at the POST stage and show the IDE for the HDD & CD-ROM drive. If a hard disk has not been installed, select "None".

Access Mode

For hard drives larger than 528MB, you would typically select the LBA type. Certain operating systems require that you select CHS or Large. Please check your operating system's manual or Help desk on which one to select.

Capacity

Displays the approximate capacity of the disk drive. Usually the size is slightly greater than the size of a formatted disk given by a disk checking program.

Cylinder

This field displays the number of cylinders.

Head

This field displays the number of read/write heads.

Precomp

This field displays the number of cylinders at which to change the write timing.

Landing Zone

This field displays the number of cylinders specified as the landing zone for the read/write heads.

Sector

This field displays the number sectors per track.

3.1.1.4 Drive A

This field identifies the type of floppy disk drive installed.

<i>None</i>	No floppy drive is installed
<i>360K, 5.25 in.</i>	5-1/4 in. standard drive; 360KB capacity
<i>1.2M, 5.25 in.</i>	5-1/4 in. AT-type high-density drive; 1.2MB capacity
<i>720K, 3.5 in.</i>	3-1/2 in. double-sided drive; 720KB capacity
<i>1.44M, 3.5 in.</i>	3-1/2 in. double-sided drive; 1.44MB capacity
<i>2.88M, 3.5 in.</i>	3-1/2 in. double-sided drive; 2.88MB capacity

3.1.1.5 Video

This field selects the type of video adapter used for the primary system monitor. Although secondary monitors are supported, you do not have to select the type. The default setting is EGA/VGA.

- EGA/VGA* Enhanced Graphics Adapter/Video Graphics Array. For EGA, VGA, SVGA and PGA monitor adapters.
- CGA 40* Color Graphics Adapter. Power up in 40-column mode.
- CGA 80* Color Graphics Adapter. Power up in 80-column mode.
- Mono* Monochrome adapter. Includes high resolution monochrome adapters.

3.1.1.6 Halt On

This field determines whether the system will stop if an error is detected during power up. The default setting is All Errors.

- No Errors* The system boot will not stop for any errors detected.
- All Errors* The system boot will stop whenever the BIOS detects a non-fatal error.
- All, But Keyboard* The system boot will not stop for a keyboard error; it will stop for all other errors.
- All, But Diskette* The system boot will not stop for a disk error; it will stop for all other errors.
- All, But Disk/Key* The system boot will not stop for a disk or keyboard error; it will stop for all other errors.

3.1.1.7 Base Memory

Displays the amount of base (or conventional) memory installed in the system. The value of the base memory is typically 512K for systems with 512K memory installed on the motherboard or 640K for systems with 640K or more memory installed on the motherboard.

3.1.1.8 Extended Memory

Displays the amount of extended memory detected during boot-up.

3.1.1.9 Total Memory

Displays the total memory available in the system.

3.1.2 Advanced BIOS Features

The Advanced BIOS Features allows you to configure your system for basic operation. Some entries are defaults required by the system board, while others, if enabled, will improve the performance of your system or let you set some features according to your preference.



The screen above list all the fields available in the Advanced BIOS Features submenu, for ease of reference in this manual. In the actual CMOS setup, you have to use the scroll bar to view the fields. The settings on the screen are for reference only. Your version may not be identical to this one.

3.1.2.1 CPU Feature

This field is used to configure the CPU that is installed on the system board.

3.1.2.2 Hard Disk Boot Priority

This field is used to select the boot sequence of the hard drives. Move the cursor to this field then press <Enter>. Use the Up or Down arrow keys to select a device then press <+> to move it up or <-> to move it down the list.

3.1.2.3 CPU L1 & L2 Cache

These fields speed up the memory access. The default value is enabled. Enable the external cache for better performance.

3.1.2.4 CPU L3 Cache

This field is used to enable or disable the CPU's L3 cache.

3.1.2.5 Hyper-Threading Technology (for Intel® Pentium® 4 Processor with Hyper-Threading Technology only)

This field is used to enable the functionality of the Intel® Pentium® 4 Processor with Hyper-Threading Technology and will appear only when using this processor.

3.1.2.6 Quick Power On Self Test

This field speeds up Power On Self Test (POST) whenever the system is powered on. The BIOS will shorten or skip some check items during POST. To attain the shortest POST time, select "Fast".

3.1.2.7 First Boot Device, Second Boot Device, Third Boot Device and Boot Other Device

Select the drive to boot first, second and third in the "First Boot Device" "Second Boot Device" and "Third Boot Device" fields respectively. The BIOS will boot the operating system according to the sequence of the drive selected. Set "Boot Other Device" to Enabled if you wish to boot from another device.

3.1.2.8 Boot Up Floppy Seek

When enabled, the BIOS will check whether the floppy disk drive installed is 40 or 80 tracks. Note that the BIOS cannot distinguish between 720K, 1.2M, 1.44M and 2.88M drive types as they are all 80 tracks. When disabled, the BIOS will not search for the type of floppy disk drive by track number. Note that there will not be any warning message if the drive installed is 360KB.

3.1.2.9 Boot Up NumLock Status

This allows you to determine the default state of the numeric keypad. By default, the system boots up with NumLock on wherein the function of the numeric keypad is the number keys. When set to Off, the function of the numeric keypad is the arrow keys.

3.1.2.10 Gate A20 Option

This entry allows you to select how gate A20 is handled. Gate A20 is a device used to address memory above 1 Mbyte. Initially, gate A20 was handled via the keyboard controller. Today, while keyboards still provide this support, it is more common, and much faster, for the system chipset to provide support for gate A20.

- Fast* The chipset controls Gate A20.
- Normal* A pin in the keyboard controller controls Gate A20.

3.1.2.11 Typematic Rate Setting

- Disabled* Continually holding down a key on your keyboard will cause the BIOS to report that the key is down.
- Enabled* The BIOS will not only report that the key is down, but will first wait for a moment, and, if the key is still down, it will begin to report that the key has been depressed repeatedly. For example, you would use such a feature to accelerate cursor movements with the arrow keys. You can then select the typematic rate and typematic delay in the "Typematic Rate (Chars/Sec)" and "Typematic Delay (Msec)" fields below.

3.1.2.12 Typematic Rate (Chars/Sec)

This field allows you to select the rate at which the keys are accelerated.

3.1.2.13 Typematic Delay (Msec)

This field allows you to select the delay between when the key was first depressed and when the acceleration begins.

3.1.2.14 Security Option

This field determines when the system will prompt for the password - everytime the system boots or only when you enter the BIOS setup. Set the password in the Set Supervisor/User Password submenu.

- System* The system will not boot and access to Setup will be denied unless the correct password is entered at the prompt.
- Setup* The system will boot, but access to Setup will be denied unless the correct password is entered at the prompt.

3.1.2.15 APIC Mode

Leave this field in its default setting.

3.1.2.16 MPS Version Control for OS

This field is used to select the MPS version that the system board is using.

3.1.2.17 OS Select for DRAM > 64MB

This field allows you to access the memory that is over 64MB in OS/2.

3.1.2.18 Report No FDD For WIN 95

The options are Yes and No.

3.1.2.19 Small Logo(EPA) Show

- Enabled* The EPA logo will appear during system boot-up.
- Disabled* The EPA logo will not appear during system boot-up.

3.1.3 Advanced Chipset Features

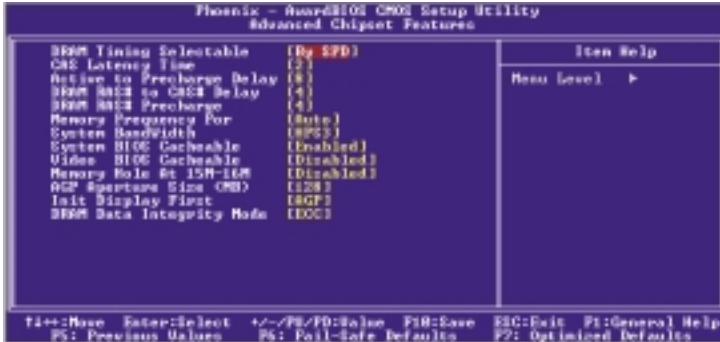

The settings on the screen are for reference only. Your version may not be identical to this one.

This section gives you functions to configure the system based on the specific features of the chipset. The chipset manages bus speeds and access to system memory resources. **These items should not be altered unless necessary.** The default settings have been chosen because they provide the best operating conditions for your system. The only time you might consider making any changes would be if you discovered some incompatibility or that data was being lost while using your system.

3.1.3.1 DRAM Timing Selectable

This field is used to select the timing of the DRAM.

By SPD The EEPROM on a DIMM has SPD (Serial Presence Detect) data structure that stores information about the module such as the memory type, memory size, memory speed, etc. When this option is selected, the system will run according to the information in the EEPROM. This option is the default setting because it provides the most stable condition for the system. The "CAS Latency Time" to "DRAM RAS# Precharge" fields will show the default settings by SPD.

Manual If you want your system to run at a performance better than the one “by SPD”, select “Manual” then select the best option in the “CAS Latency Time” to “DRAM RAS# Precharge” fields.

3.1.3.2 CAS Latency Time

This field is used to select the local memory clock periods.

3.1.3.3 Active to Precharge Delay

The options are 5, 6, 7 and 8.

3.1.3.4 DRAM RAS# to CAS# Delay

The options are 2, 3 and 4.

3.1.3.5 DRAM RAS# Precharge

This field controls RAS# precharge (in local memory clocks).

3.1.3.6 Memory Frequency For

This field is used to select the memory clock speed of the DIMM.

The system board supports DDR266, DDR333 or DDR400 when using 800MHz FSB CPU.

DDR333 will run at 320MHz memory frequency when used with 800MHz FSB CPU. Under such circumstance, make sure this field is set to Auto or DDR320.

Refer to chapter 1 (System Memory section) for detailed specification of the memory supported by the system board.

3.1.3.7 System Bandwidth

The options are HPS3, MPS1, MPS2, LPS1, LPS2 and LPS3.

LPS denotes Low Bandwidth for overclocking.
MPS denotes Middle Bandwidth for overclocking.
HPS denotes High Bandwidth for overclocking.

3.1.3.8 System BIOS Cacheable

When this field is enabled, accesses to the system BIOS ROM addressed at F0000H-FFFFFH are cached, provided that the cache controller is enabled. The larger the range of the Cache RAM, the higher the efficiency of the system.

3.1.3.9 Video BIOS Cacheable

As with caching the system BIOS, enabling the Video BIOS cache will allow access to video BIOS addressed at C0000H to C7FFFH to be cached, if the cache controller is also enabled. The larger the range of the Cache RAM, the faster the video performance.

3.1.3.10 Memory Hole At 15M-16M

In order to improve system performance, certain space in memory can be reserved for ISA cards. This memory must be mapped into the memory space below 16MB. When enabled, the CPU assumes the 15-16MB memory range is allocated to the hidden ISA address range instead of the actual system DRAM. When disabled, the CPU assumes the 15-16MB address range actually contains DRAM memory. If more than 16MB of system memory is installed, this field must be disabled to provide contiguous system memory.

3.1.3.11 AGP Aperture Size (MB)

This field is relevant to the memory-mapped graphics data of the AGP card installed in your system. Leave this in its default setting.

3.1.3.12 Init Display First

This field is used to select whether to initialize the AGP or PCI first when the system boots.

- AGP* When the system boots, it will first initialize the AGP.
- PCI Slot* When the system boots, it will first initialize PCI.

3.1.3.13 DRAM Data Integrity Mode

The ECC (Error Checking and Correction) function is supported only in x72 (72-bit) PC SDRAM DIMMs. If you are using x64 (64-bit) PC SDRAM DIMMs, set this field to Non-ECC.

- Non-ECC* Uses x64 PC SDRAM DIMM.
- ECC* This option allows the system to recover from memory failure. It detects single-bit and multiple-bit errors, then automatically corrects single-bit error.

3.1.4 Integrated Peripherals

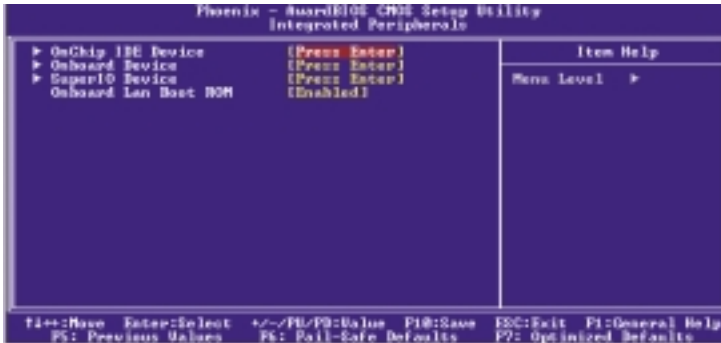

The settings on the screen are for reference only. Your version may not be identical to this one.

3.1.4.1 OnChip IDE Device

Move the cursor to this field and press <Enter>. The following screen will appear.

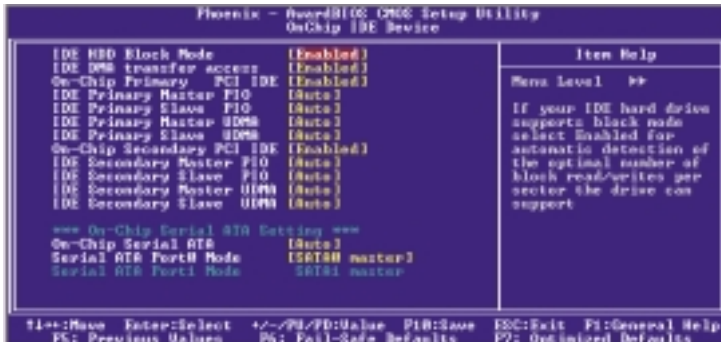

The settings on the screen are for reference only. Your version may not be identical to this one.

IDE HDD Block Mode

Enabled The IDE HDD uses the block mode. The system BIOS will check the hard disk drive for the maximum block size the system can transfer. The block size will depend on the type of hard disk drive.

Disabled The IDE HDD uses the standard mode.

IDE DMA Transfer Access

This field, when Enabled, will enhance the IDE DMA transfer of an IDE hard disk drive.

On-Chip Primary PCI IDE and On-Chip Secondary PCI IDE

These fields allow you to enable or disable the primary and secondary IDE controller. Select Disabled if you want to add a different hard drive controller.

IDE Primary Master/Slave PIO and IDE Secondary Master/Slave PIO

PIO means Programmed Input/Output. Rather than have the BIOS issue a series of commands to effect a transfer to or from the disk drive, PIO allows the BIOS to tell the controller what it wants and then let the controller and the CPU perform the complete task by themselves. Your system supports five modes, 0 (default) to 4, which primarily differ in timing. When Auto is selected, the BIOS will select the best available mode after checking your drive.

Auto The BIOS will automatically set the system according to your hard disk drive's timing.

Mode 0-4 You can select a mode that matches your hard disk drive's timing. Caution: Do not use the wrong setting or you will have drive errors.

IDE Primary Master/Slave UDMA and IDE Secondary Master/Slave UDMA

These fields allow you to set the Ultra DMA in use. When Auto is selected, the BIOS will select the best available option after checking your hard drive or CD-ROM.

- Auto* The BIOS will automatically detect the settings for you.
- Disabled* The BIOS will not detect these categories.

On-Chip Serial ATA

- Disabled* Disables the onboard SATA.
- Auto* The system will detect the existing SATA and IDE drives then automatically set them to the available master/slave mode.
- Combined Mode* This option allows you to use both IDE and SATA drives; allowing a maximum of 4 drives. You must manually set the SATA drives' master/slave mode in the "Serial ATA Port0 Mode" and "Serial ATA Port1 Mode" fields.
- Enhanced Mode* This option allows you to use both IDE and SATA drives; allowing a maximum of 6 drives.
- SATA Only* This option automatically sets the SATA drives to Primary Master and Secondary Master modes. Since both drives are in master mode, you cannot set the IDE drives to Master mode. The "Serial ATA Port0 Mode" and "Serial ATA Port1 Mode" fields will not be configurable.

Serial ATA Port0 Mode and Serial ATA Port1 Mode

These fields are used to select the master/slave mode of the serial ATA drives. Make sure they do not conflict with the settings of the IDE hard drives.

3.1.4.2 Onboard Device

Move the cursor to this field and press <Enter>. The following screen will appear.

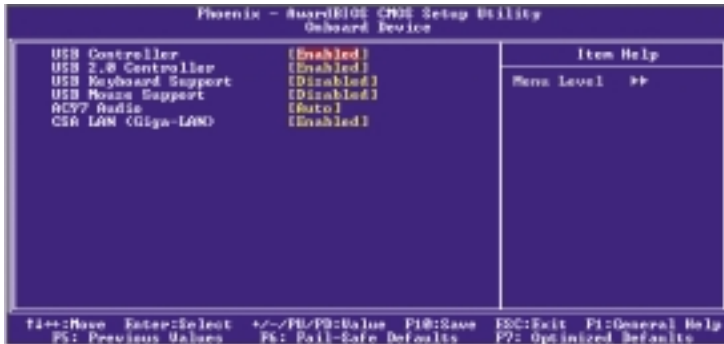

The settings on the screen are for reference only. Your version may not be identical to this one.

USB Controller

Enabled Enables the onboard USB.

Disabled Disables the onboard USB.

USB 2.0 Controller

If you are using a USB 2.0 device, this field must be set to Enabled.

USB Keyboard Support

By default, this field is Disabled. However, if you are using a USB keyboard under DOS, make sure to enable this function.

USB Mouse Support

This field is used to enable or disable the USB mouse.

AC97 Audio

Auto Select this option when using the onboard AC97 codec.

Disabled Select this option when using a PCI sound card.

CSA LAN (Giga-LAN) - G4H875-N only

This field is used to enable or disable the onboard CSA Gigabit LAN.

3.1.4.3 Super IO Device

Move the cursor to this field and press <Enter>. The following screen will appear.



The settings on the screen are for reference only. Your version may not be identical to this one.

Power On Function

This field allows you to use the keyboard or PS/2 mouse to power-on the system.

- Button only* Default setting. Uses the power button to power on the system.
- Password* When this option is selected, set the password you would like to use to power-on the system in the "KB Power On Password" field.
- Hot Key* When this option is selected, select the function key you would like to use to power-on the system in the "Hot Key Power On" field.
- Mouse Left* When this option is selected, double-click the left button of the mouse to power-on the system.
- Mouse Right* When this option is selected, double-click the right button of the mouse to power-on the system.
- Any Key* Press any key to power-on the system.

Keyboard 98 When this option is selected, press the “wake up” key of the Windows® 98 compatible keyboard to power-on the system.

KB Power On Password

Move the cursor to this field and press <Enter>. Enter your password. You can enter up to 5 characters. Type in exactly the same password to confirm, then press <Enter>.

The power button will not function once a keyboard password has been set in this field. You must type the correct password to power-on the system. If you forgot the password, power-off the system and remove the battery. Wait for a few seconds and install it back before powering-on the system.

Hot Key Power On

This field is used to select a function key that you would like to use to power-on the system.

Onboard FDC Controller

Enabled Enables the onboard floppy disk controller.

Disabled Disables the onboard floppy disk controller.

Onboard Serial Port 1 and Onboard Serial Port 2

Auto The system will automatically select an I/O address for the onboard serial port 1 and serial port 2.

3F8/IRQ4, 2F8/IRQ3, 3E8/IRQ4, 2E8/IRQ3 Allows you to manually select an I/O address for the onboard serial port 1 and serial port 2.

Disabled Disables the onboard serial port 1 and/or serial port 2.

UART Mode Select

This field is used to select the type of IrDA standard supported by your IrDA device. For better transmission of data, your IrDA peripheral device must be within a 30° angle and within a distance of 1 meter.

RxD, TxD Active

The options are Hi, Lo; Lo, Hi; Lo, Lo; and Hi, Hi.

IR Transmission Delay

If this field is Enabled, transmission of data will be slower. This is recommended when you encounter transmission problem with your device. The options are: Enabled and Disabled.

UR2 Duplex Mode

Half Data is completely transmitted before receiving data.

Full Transmits and receives data simultaneously.

Use IR Pins

The options are IR-Rx2Tx2 and RxD2TxD2.

Onboard Parallel Port

378/IRQ7, 3BC/IRQ7, 278/IRQ5 Selects the I/O address and IRQ for the onboard parallel port.

Disabled Disables the onboard parallel port.

Parallel Port Mode

The options are SPP, EPP, ECP and ECP+EPP. These apply to a standard specification and will depend on the type and speed of your device. Refer to your peripheral's manual for the best option.

SPP

Allows normal speed operation but in one direction only.

“ECP (Extended Capabilities Port)”

Allows parallel port to operate in bidirectional mode and at a speed faster than the normal mode's data transfer rate.

“EPP (Enhanced Parallel Port)”

Allows bidirectional parallel port operation at maximum speed.

If you selected EPP, the “EPP Mode Select” field is selectable. If you selected ECP, the “ECP Mode Use DMA” field is selectable. If you selected ECP+EPP, both “EPP Mode Select” and “ECP Mode Use DMA” are selectable.

EPP Mode Select

This field is used to select the EPP mode of the parallel port.

ECP Mode Use DMA

This is used to select a DMA channel of the parallel port.

PWRON After Power-Fail

- Off* When power returns after an AC power failure, the system's power is off. You must press the Power button to power-on the system.
- On* When power returns after an AC power failure, the system will automatically power-on.
- Former-Sts* When power returns after an AC power failure, the system will return to the state where you left off before power failure occurs. If the system's power is off when AC power failure occurs, it will remain off when power returns. If the system's power is on when AC power failure occurs, the system will power-on when power returns.

Game Port Address

This field is used to select the game port's address.

Midi Port Address

This field is used to select the midi port's address. If you have selected the midi port's address, you may select its IRQ in the “Midi Port IRQ” field.

Midi Port IRQ

This field is used to select the midi port's IRQ.

Onboard Serial Port 3 (G4H875-N only)

This field is used to select the serial port 3's I/O address.

Onboard Serial Port 3 IRQ (G4H875-N only)

This field is used to select the serial port 3's IRQ address. This field is not configurable if the "Onboard Serial Port 3" field is set to Disabled.

Onboard Serial Port 4 (G4H875-N only)

This field is used to select the serial port 4's I/O address.

Onboard Serial Port 4 IRQ (G4H875-N only)

This field is used to select the serial port 4's IRQ address. This field is not configurable if the "Onboard Serial Port 4" field is set to Disabled.

3.1.4.4 Onboard LAN Boot ROM

Enable this field if you wish to use the boot ROM (instead of a disk drive) to boot-up the system and access the local area network directly.

If you wish to change the boot ROM's settings, type the <Shift> and <F10> keys simultaneously when prompted during boot-up. Take note: you will be able to access the boot ROM's program (by typing <Shift> + <F10>) only when this field is enabled.

3.1.5 Power Management Setup

The Power Management Setup allows you to configure your system to most effectively save energy.

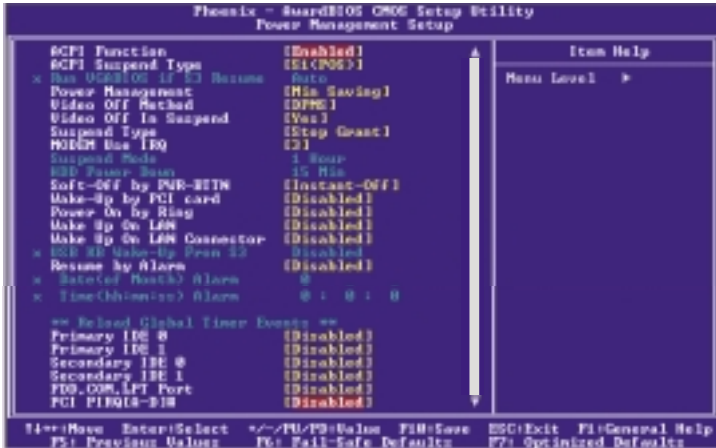

The screen above list all the fields available in the Power Management Setup submenu, for ease of reference in this manual. In the actual CMOS setup, you have to use the scroll bar to view the fields. The settings on the screen are for reference only. Your version may not be identical to this one.

3.1.5.1 ACPI Function

This function should be enabled only in operating systems that support ACPI. Currently, only Windows® 98SE/2000/ME/XP supports this function. If you want to use the Suspend to RAM function, make sure this field is enabled then select “S3(STR)” in the “ACPI Suspend Type” field.

3.1.5.2 ACPI Suspend Type

This field is used to select the type of Suspend mode.

- S1(POS)* Enables the Power On Suspend function.
- S3(STR)* Enables the Suspend to RAM function.

3.1.5.3 Run VGABIOS if S3 Resume

When this field is set to Auto, the system will initialize the VGA BIOS when it wakes up from the S3 state. This can be configured only if the "ACPI Suspend Type" field is set to "S3(STR)".

3.1.5.4 Power Management

This field allows you to select the type (or degree) of power saving by changing the length of idle time that elapses before the Suspend mode and HDD Power Down fields are activated.

- Min Saving* Minimum power saving time for the Suspend Mode (1 hour) and HDD Power Down (15 min.)
- Max Saving* Maximum power saving time for the Suspend Mode and HDD Power Down = 1 min.
- User Define* Allows you to set the power saving time in the "Suspend Mode" and "HDD Power Down" fields.

3.1.5.5 Video Off Method

This determines the manner in which the monitor is blanked.

- V/H SYNC + Blank* This selection will cause the system to turn off the vertical and horizontal synchronization ports and write blanks to the video buffer.
- Blank Screen* This option only writes blanks to the video buffer.
- DPMS* Initializes display power management signaling. Use this option if your video board supports it.

3.1.5.6 Video Off In Suspend

This field is used to activate the video off feature when the system enters the Suspend mode. The options are Yes and No.

3.1.5.7 Suspend Type

The options are Stop Grant and PwrOn Suspend.

3.1.5.8 MODEM Use IRQ

This field is used to set an IRQ channel for the modem installed in your system.

3.1.5.9 Suspend Mode

This is selectable only when the Power Management field is set to User Define. When the system enters the Suspend mode according to the power saving time selected, the CPU and onboard peripherals will be shut off.

3.1.5.10 HDD Power Down

This is selectable only when the Power Management field is set to User Define. When the system enters the HDD Power Down mode according to the power saving time selected, the hard disk drive will be powered down while all other devices remain active.

3.1.5.11 Soft-Off by PWR-BTTN

This field allows you to select the method of powering off your system.

Delay 4 Sec. Regardless of whether the Power Management function is enabled or disabled, if the power button is pushed and released in less than 4 sec, the system enters the Suspend mode. The purpose of this function is to prevent the system from powering off in case you accidentally "hit" or pushed the power button. Push and release again in less than 4 sec to restore. Pushing the power button for more than 4 seconds will power off the system.

Instant-Off Pressing and then releasing the power button at once will immediately power off your system.

3.1.5.12 Wake-Up by PCI Card

Enabled This field should be set to Enabled only if your PCI card such as LAN card or modem card uses the PCI PME (Power Management Event) signal to remotely wake up the system. Access to the LAN card or PCI card will cause the system to wake up. Refer to the card's documentation for more information.

Disabled The system will not wake up despite access to the PCI card.

3.1.5.13 Power On by Ring

Set this field to Enabled to use the modem ring-on function. This will allow your system to power-on to respond to calls coming from an external modem.

3.1.5.14 Wake Up On LAN

Set this field to Enabled to allow the network to remotely wake up a Soft Power Down (Soft-Off) PC. However, if your system is in the Suspend mode, you can wake up the system only through an IRQ or DMA interrupt.

3.1.5.15 Wake Up On LAN Connector

If you are using a LAN card that supports the remote wake up function, set this field to Enabled.

3.1.5.16 USB KB WakeUp From S3(S4)

This field, when enabled, allows you to use a USB keyboard to wake up a system that is in the S3 (STR - Suspend To RAM) state. This can be configured only if the "ACPI Suspend Type" field is set to "S3(STR)".

3.1.5.17 Resume By Alarm

Enabled When Enabled, you can set the date and time you would like the Soft Power Down (Soft-Off) PC to power-on in the "Date (of Month) Alarm" and "Time (hh:mm:ss) Alarm" fields. However, if the system is being accessed by incoming calls or the network (Resume On Ring/LAN) prior to the date and time set in these fields, the system will give priority to the incoming calls or network.

Disabled Disables the automatic power-on function. (default)

3.1.5.18 Date (of Month) Alarm

0 The system will power-on everyday according to the time set in the "Time (hh:mm:ss) Alarm" field.

1-31 Select a date you would like the system to power-on. The system will power-on on the set date, and time set in the "Time (hh:mm:ss) Alarm" field.

3.1.5.19 Time (hh:mm:ss) Alarm

This is used to set the time you would like the system to power-on. If you want the system to power-on everyday as set in the "Date (of Month) Alarm" field, the time set in this field must be later than the time of the RTC set in the Standard CMOS Features submenu.

3.1.5.20 Reload Global Timer Events

When enabled, access to the specified field (Primary IDE 0/1, Secondary IDE 0/1, FDD/COM/LPT Port or PCI PIRQ[A-D]#) will cause the system to wake up completely from the power management mode. When disabled, the system will not wake up from the power management mode despite access to the specified field.

3.1.6 PnP/PCI Configurations

This section describes configuring the PCI bus system. It covers some very technical items and it is strongly recommended that only experienced users should make any changes to the default settings.

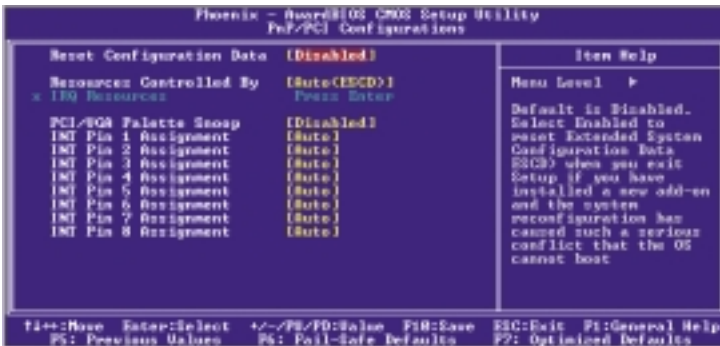

The settings on the screen are for reference only. Your version may not be identical to this one.

3.1.6.1 Reset Configuration Data

Enabled The BIOS will reset the Extended System Configuration Data (ESCD) once automatically. It will then recreate a new set of configuration data.

Disabled The BIOS will not reset the configuration data.

3.1.6.2 Resources Controlled By

The Award Plug and Play BIOS has the capability to automatically configure all of the boot and Plug and Play compatible devices.

Auto The system will automatically detect the settings for you.

Manual Choose the specific IRQ in the "IRQ Resources" field respectively.

3.1.6.3 IRQ Resources

Move the cursor to this field and press <Enter>. The “IRQ-3” to “IRQ-15” fields will appear. Set each system interrupt to either PCI Device or Reserved.

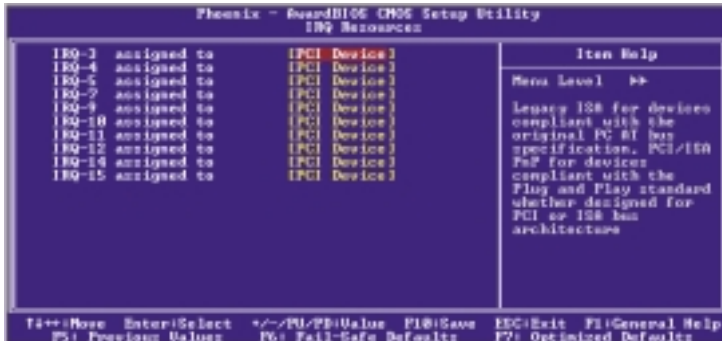

The settings on the screen are for reference only. Your version may not be identical to this one.

3.1.6.4 PCI/VGA Palette Snoop

This field determines whether the MPEG ISA/VESA VGA cards can work with PCI/VGA or not. The default value is Disabled.

Enabled MPEG ISA/VESA VGA cards work with PCI/VGA.

Disabled MPEG ISA/VESA VGA cards does not work with PCI/VGA.

3.1.6.5 INT Pin 1 Assignment to INT Pin 8 Assignment

By default, an IRQ is automatically assigned to the PCI devices that are installed in the PCI slots.

If a PCI device has not been assigned an IRQ, you must manually assign an IRQ for the device. During system boot-up, you will see “NA” for the device that does not have an IRQ assigned.

3.1.7 PC Health Status

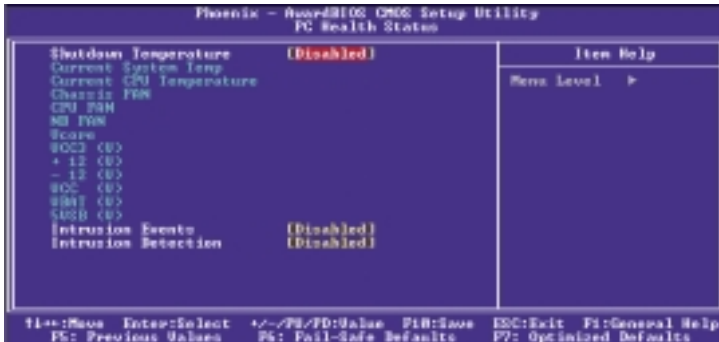

The settings on the screen are for reference only. Your version may not be identical to this one.

3.1.7.1 Shutdown Temperature

You can prevent the system from overheating by selecting a temperature in this field. If the system detected that its temperature exceeded the one set in this field, it will automatically shutdown.

3.1.7.2 Current System Temperature, Current CPU Temperature, Chassis Fan, CPU Fan and NB Fan

These fields show the internal temperature of the system, current temperature of the CPU, and the current fan speed of the chassis, CPU and NB fans in RPM (Revolutions Per Minute).

3.1.7.3 Vcore

These fields show the voltage of the processor.

3.1.7.4 VCC3(V), +12(V), -12(V), VCC(V), VBAT(V) and 5VSB(V)

These fields show the output voltage of the power supply.



Note:

The onboard hardware monitor function is capable of detecting “system health” conditions but if you want a warning message to pop-up or a warning alarm to sound when an abnormal condition occurs, you must install the Hardware Doctor utility. This utility is included in the CD that came with the system board. Refer to the Hardware Doctor section in chapter 4 for more information.

3.1.7.5 Intrusion Events

When the system detected an intrusion event, a beeping alarm will sound alerting you of an intrusion event. Determine and settle the problem then perform the following steps to clear the intrusion event.

1. Restart the system.
2. Press to enter the BIOS setup.
3. Move the cursor to “PC Health Status” then press <Enter>.
4. Select the “Reset” option in the “Intrusion Events” field.
5. Press <Esc> to return to the main menu of the BIOS setup.
6. Move the cursor to “Save & Exit Setup” then press <Enter>.
7. Type “Y” and press <Enter>.
8. The system will restart with the intrusion event already cleared.

3.1.7.6 Intrusion Detection

The system board provides real-time detection of any chassis intrusion events. To use this function, set this field to Enabled.

3.1.8 Frequency/Voltage Control

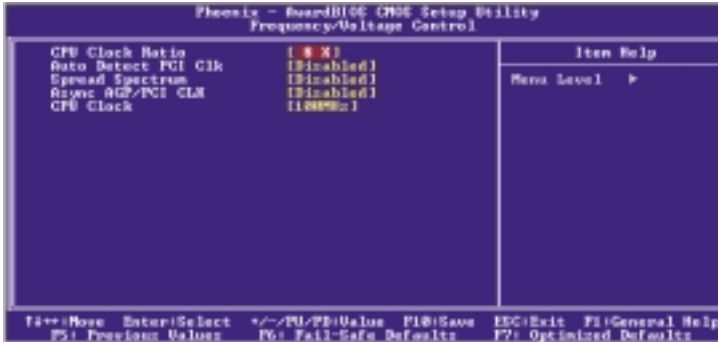

The settings on the screen are for reference only. Your version may not be identical to this one.

3.1.8.1 CPU Clock Ratio

This field is used to select the CPU's frequency ratio.



Important:

The frequency ratio of some processors may have been locked by the manufacturer. If you are using this kind of processor, setting an extended ratio for the processor will have no effect. The system will instead use its factory default ratio.

3.1.8.2 Auto Detect PCI Clk

When enabled, the system will automatically send clock signals to existing PCI devices.

3.1.8.3 Spread Spectrum

Leave this field in its default setting. Do not alter this setting unless advised by an engineer or technician.

3.1.8.4 Async AGP/PCI CLK

This field is used to select the bus clock of the AGP and PCI.

3.1.8.5 CPU Clock

This field provides several options for selecting the external system bus clock of the processor. The available options allow you to adjust the processor's bus clock by 1MHz increment.



Important:

Selecting an external bus clock other than the default setting may result to the processor's or system's instability and are not guaranteed to provide better system performance.

3.1.9 Load Fail-Safe Defaults

The “Load Fail-Safe Defaults” option loads the troubleshooting default values permanently stored in the ROM chips. These settings are not optimal and turn off all high performance features. You should use these values only if you have hardware problems. Highlight this option in the main menu and press <Enter>.



If you want to proceed, type <Y> and press <Enter>. The default settings will be loaded.

3.1.10 Load Optimized Defaults

The “Load Optimized Defaults” option loads optimized settings from the BIOS ROM. Use the default values as standard values for your system. Highlight this option in the main menu and press <Enter>.



Type <Y> and press <Enter> to load the Setup default values.

3.1.11 Set Supervisor Password

If you want to protect your system and setup from unauthorized entry, set a supervisor's password with the "System" option selected in the Advanced BIOS Features. If you want to protect access to setup only, but not your system, set a supervisor's password with the "Setup" option selected in the Advanced BIOS Features. You will not be prompted for a password when you cold boot the system.

Use the arrow keys to highlight "Set Supervisor Password" and press <Enter>.



Type in the password. You are limited to eight characters. When done, the message below will appear:

Confirm Password:

You are asked to verify the password. Type in exactly the same password. If you type in a wrong password, you will be prompted to enter the correct password again. To delete or disable the password function, highlight "Set Supervisor Password" and press <Enter>, instead of typing in a new password. Press the <Esc> key to return to the main menu.

3.1.12 Set User Password

If you want another user to have access only to your system but not to setup, set a user's password with the "System" option selected in the Advanced BIOS Features. If you want a user to enter a password when trying to access setup, set a user's password with the "Setup" option selected in the Advanced BIOS Features.

Using user's password to enter Setup allows a user to access only "Set User Password" that appears in the main menu screen. Access to all other options is denied.

Use the arrow keys to highlight "Set User Password" and press <Enter>.



Type in the password. You are limited to eight characters. When done, the message below will appear:

Confirm Password:

You are asked to verify the password. Type in exactly the same password. If you type in a wrong password, you will be prompted to enter the correct password again. To delete or disable the password function, highlight "Set User Password" and press <Enter>, instead of typing in a new password. Press the <Esc> key to return to the main menu.

3.1.13 Save & Exit Setup

When all the changes have been made, highlight "Save & Exit Setup" and press <Enter>.

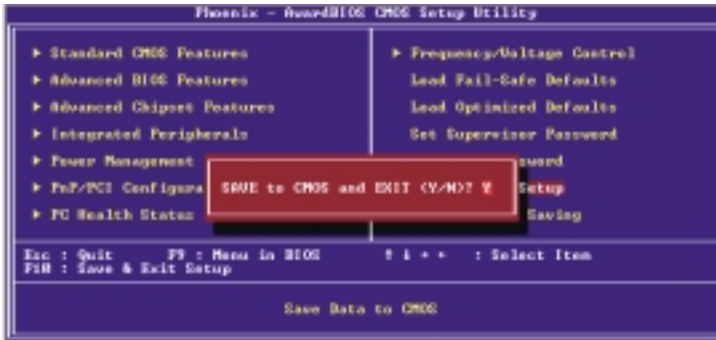

Type "Y" and press <Enter>. The modifications you have made will be written into the CMOS memory, and the system will reboot. You will once again see the initial diagnostics on the screen. If you wish to make additional changes to the setup, press <Ctrl> <Alt> <Esc> simultaneously or after memory testing is done.

3.1.14 Exit Without Saving

When you do not want to save the changes you have made, highlight "Exit Without Saving" and press <Enter>.



Type "Y" and press <Enter>. The system will reboot and you will once again see the initial diagnostics on the screen. If you wish to make any changes to the setup, press <Ctrl> <Alt> <Esc> simultaneously or after memory testing is done.

3.2 Updating the BIOS

To update the BIOS, you will need the new BIOS file and a flash utility, AWDFLASH.EXE. Please contact technical support or your sales representative for the files.



Note:

AWDFLASH.EXE works only in DOS mode.

1. Save the new BIOS file along with the flash utility AWDFLASH.EXE to a floppy disk.
2. Reboot the system and enter the Award BIOS Setup Utility to set the first boot drive to "Floppy".
3. Save the setting and reboot the system.
4. After the system booted from the floppy disk, execute the flash utility by typing AWDFLASH.EXE. The following screen will appear.

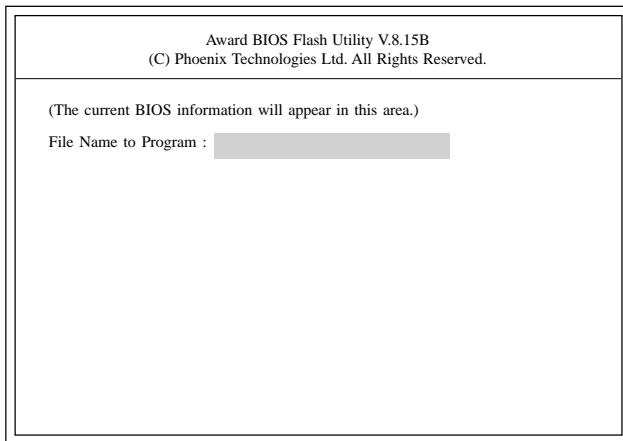

5. Type the new BIOS file name onto the gray area that is next to "File Name to Program" then press <Enter>.

- The following will appear.

Do You Want to Save BIOS (Y/N)

This question refers to the current existing BIOS in your system. We recommend that you save the current BIOS and its flash utility; just in case you need to reinstall the BIOS. To save the current BIOS, press <Y> then enter the file name of the current BIOS. Otherwise, press <N>.

- The following will then appear.

Press "Y" to Program or "N" to Exit

- Press <Y> to flash the new BIOS.

Chapter 4 - Supported Software

4.1 Desktop Management Interface (DMI)

The system board comes with a DMI built into the BIOS. DMI, along with the appropriately networked software, is designed to make inventory, maintenance and troubleshooting of computer systems easier. With DMI, a network administrator or MIS engineer can remotely access some information about a particular computer system without physically going to it. Quite often a service call may be unnecessary as the problem can be solved remotely.

The DMI utility in the BIOS automatically records various information about your system configuration. Information about the type and speed of CPU, type and amount of memory for each memory slot, BIOS revision level, types of add-in PCI boards and components, certain revision numbers of hardware installed, etc. are automatically detected and stored in the DMI pool, which is a part of the system board's Plug and Play BIOS. Additional information, such as ISA based peripherals, which may not be automatically detected, can be manually recorded in the DMI pool by using the Add DMI menu. The DMI pool data is then verified or updated whenever the system hardware or setup is altered.

4.1.1 Running the DMI Utility

To run the DMI utility, type: DMICFG.EXE. Please contact technical support or your sales representative for the utility.

The DMI utility must run in real mode with at least 180K of base memory. Memory managers like HIMEM.SYS (required by Windows) must not be installed. You may do this by using one of the 3 methods listed below.

1. Boot up from a system diskette without the AUTOEXEC.BAT and CONFIG.SYS files,
2. "REM" HIMEM.SYS in the CONFIG.SYS, or
3. Press <F5> during bootup to bypass your AUTOEXEC.BAT and CONFIG.SYS files.

4.1.2 Using the DMI Utility

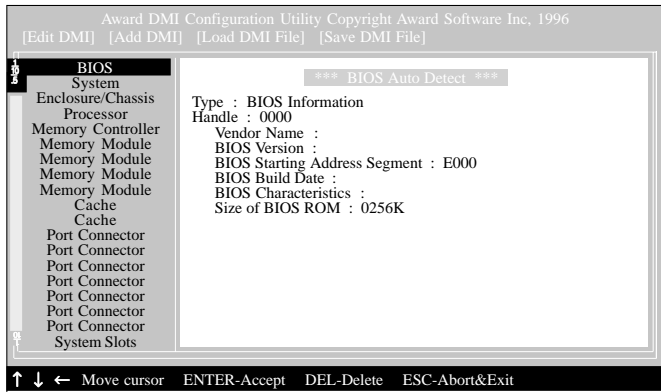

The four menus located on top of the DMI Configuration Utility screen are Edit DMI, Add DMI, Load DMI File and Save DMI File. Use the ← or → (left or right) arrow keys to select a menu from the Menu bar.

On the left side of the screen is a list of the system configuration items. Use the ↑ or ↓ (up or down) arrow keys to select an item.

The commands at the bottom of the screen will allow you to navigate through the various setup menus.

Edit DMI

1. Use the ← or → arrow keys to select the Edit DMI menu.
2. Highlight the item on the left screen that you would like to edit by using the ↑ or ↓ arrow keys, then press <Enter>.
3. The cursor will move to the screen you select allowing you to edit information. The screen will also display the auto-detected information.
4. Press <F10> to update the edited information into the flash ROM.

Add DMI

1. Use the ← or → arrow keys to select the Add DMI menu.
2. Highlight the item on the left screen that you would like to add by using the ↑ or ↓ arrow keys, then press <Enter>.
3. The cursor will move to the screen you select allowing you to enter information about the added item.
4. Press <F10> to save information into the flash ROM.

To view information about the added items, go to the Edit DMI menu.

Load DMI File

1. Use the ← or → arrow keys to select the Load DMI File menu.
2. The following message will appear.

Press [Enter] to select DMI file for load

Press <Enter>.

3. The DMI files will appear on the screen. Select the file you would like to load and press <Enter>.
4. The following message will appear.

Do you want to execute? (Y/N)

Type <Y>. All previous DMI structures will be destroyed and the new file will be saved into the flash ROM.

Save DMI File

1. Use the ← or → arrow keys to select the Save DMI File menu.
2. The following message will appear.

Press [Enter] to select DMI file for save

Press <Enter>.

3. Enter the directory and filename under which you would like the DMI file saved.

4.2 Drivers, Utilities and Software Applications

The CD that came with the system board contains drivers, utilities and software applications required to enhance the performance of the system board.

Insert the CD into a CD-ROM drive. The autorun screen (Main Board Utility CD) will appear. If after inserting the CD, "Autorun" did not automatically start (which is, the Main Board Utility CD screen did not appear), please go directly to the root directory of the CD and double-click "Setup".



4.2.1 Intel 875 INF Update Utility

The Intel 875 INF Update Utility is used for updating Windows® 98SE/2000/ME/XP's INF files so that the Intel chipset can be recognized and configured properly in the system.

To install the utility, please follow the steps below.

1. Click "Intel 875 INF Update Utility" on the main menu. The following screen will appear.

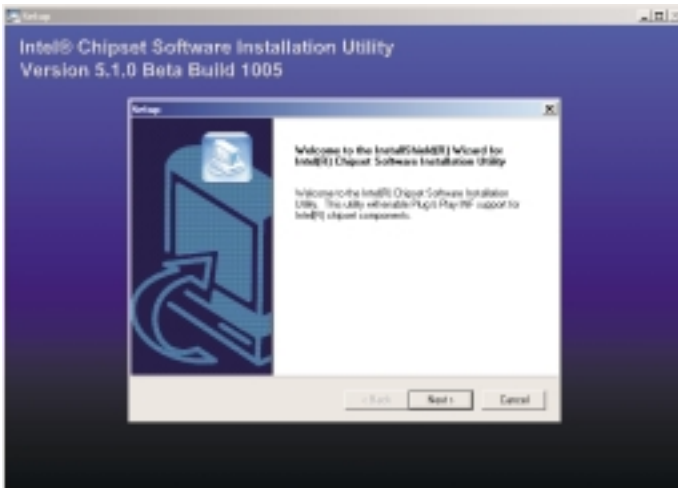

2. Follow the prompts on the screen to complete installation.
3. Reboot the system for the utility to take effect.

4.2.2 Intel LAN Drivers

To install the driver, please follow the steps below.

1. Click "Intel LAN Drivers" on the main menu.
2. Click "Wired LAN Adapters". The following screen will appear.

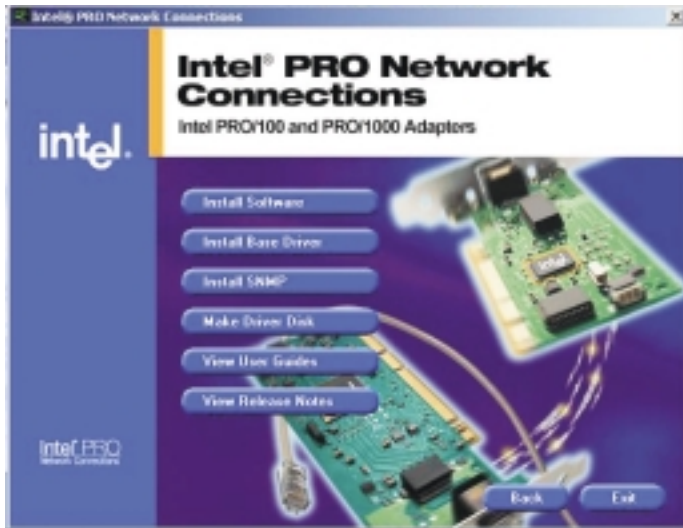

3. Click "Install Software". This will install the LAN application software. After installing the software, run the application software by double-clicking the icon on the lower right of the taskbar. The "Intel(R) PROSet II" screen will appear. For more information about using the utility, click "View User Guide" on the screen above.
4. Go back to the screen above to install the LAN driver. Click "Install Base Driver".
5. Follow the prompts on the screen to complete installation.
6. Reboot the system for the driver to take effect.

4.2.3 Intel USB 2.0 Drivers

If you are using a USB 2.0 device, you must install the USB 2.0 driver. The drivers are supported in the following operating systems: Windows® 98 SE, Windows® ME and Windows® 2000.

To install the driver, please follow the steps below.

1. Click “Intel USB 2.0 Drivers” on the main menu. If you are using Windows® 98 SE or Windows® ME, the following screen will appear.

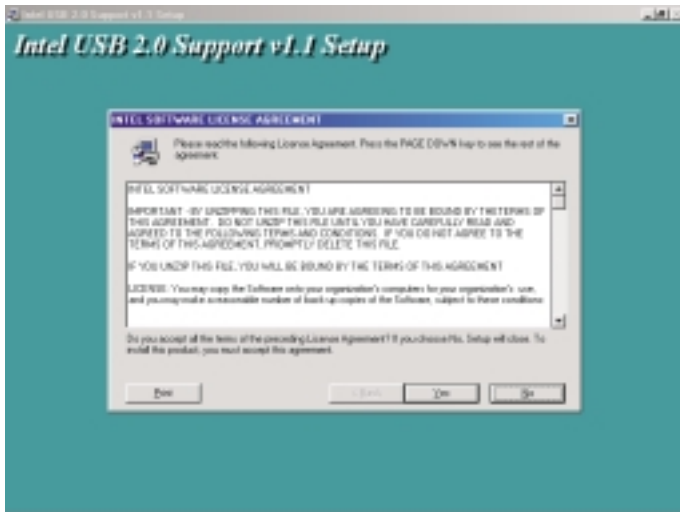

Windows® 2000 does not support auto-installation of the USB 2.0 driver. When you click “Intel USB 2.0 Drivers”, the “readme” screen will appear.

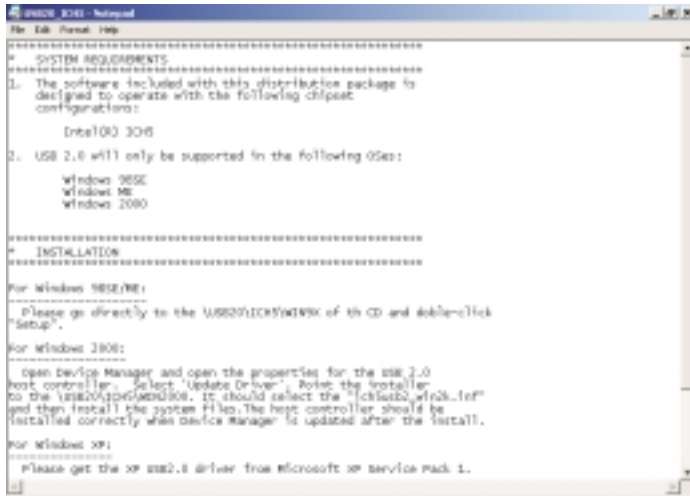

2. Follow the installation instructions shown on the screen.
3. Reboot the system for the driver to take effect.



Important:

If you are using Windows® XP, you must install the Windows Service Pack 1 USB 2.0 driver which comes available after you have installed the operating system.

4.2.4 Audio Drivers

The audio drivers are supported in the following operating systems: Windows® 98SE, Windows® ME, Windows NT® 4.0, Windows® 2000 and Windows® XP.

To install the driver, please follow the steps below.

1. Click "Audio Drivers". The following screen will appear.



2. Follow the prompts on the screen to complete installation.
3. Reboot the system for the driver to take effect.

4.2.5 Microsoft DirectX 9

To install, please follow the steps below.

1. Click "Microsoft DirectX 9" on the main menu. The following screen will appear.

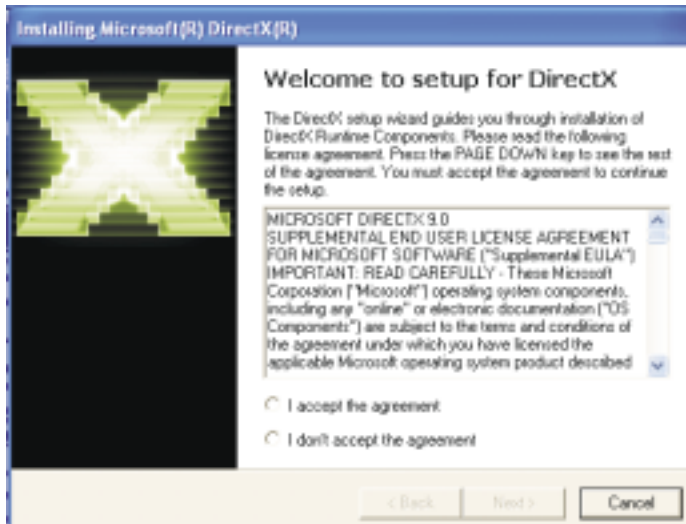

2. Click "I accept the agreement" then click "Next".
3. Follow the prompts on the screen to complete installation.
4. Reboot the system for the driver to take effect.

4.2.6 Hardware Doctor

Hardware Doctor is capable of monitoring the system's hardware conditions such as the temperature of the CPU and system, voltage, and speed of the cooling fans. It also allows you to manually set a range to the items being monitored. If the values are over or under the set range, a warning message will pop-up. The utility can also be configured so that a beeping alarm will sound whenever an error occurs. We recommend that you use the "Default Setting" which is the ideal setting that would keep the system in good working condition.



Note:

Use this utility only in Windows® 98SE, Windows® ME, Windows® 2000, Windows NT® 4.0 or Windows® XP operating system.

To install the utility, please follow the steps below.

1. Click "Hardware Doctor". The screen below will appear.

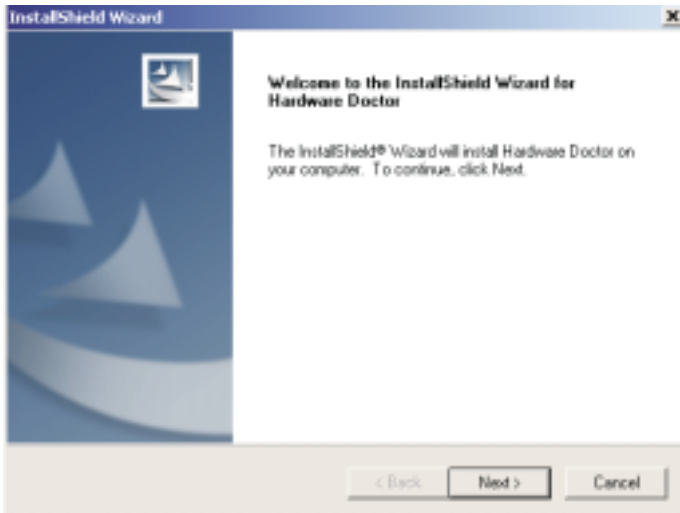

2. Follow the prompts on the screen to complete installation.
3. Restart the system.

4.3 Installation Notes

1. "Autorun" ONLY supports the Windows® 98 SE, Windows® ME, Windows® 2000, Windows NT® 4.0 and Windows® XP operating systems. If after inserting the CD, "Autorun" did not automatically start (which is, the Main Board Utility CD screen did not appear), please go directly to the root directory of the CD and double-click "Setup".
2. All steps or procedures to install software drivers are subject to change without notice as the softwares are occasionally updated. Please contact technical support or your sales representative for the latest version of the drivers or software applications.

Appendix A - Enabling Hyper-Threading Technology

A.1 Enabling Hyper-Threading Technology

To enable the functionality of the Hyper-Threading Technology, please follow the requirements and steps below. Basically, the following presumes that you have already installed an Intel® Pentium® 4 Processor with Hyper-Threading Technology.

1. The system requires a minimum of 300 Watt ATX 12V power supply.
2. Aside from installing a CPU fan on the Intel® Pentium® 4 Processor with Hyper-Threading Technology, make sure to install cooling fans. The system requires adequate airflow throughout the chassis to prevent overheating the processor.
3. The "CPU Hyper-Threading" field in the Advanced BIOS Features submenu of the Award BIOS setup will appear. Make sure this field is set to Enabled.
4. Currently, only Windows® XP supports the Hyper-Threading Technology. If this OS has been previously installed, you must **REINSTALL** it.
5. After installing Windows® XP, please check the following to ensure that the operating system has been properly installed.
 - a. Click Start, point to Settings then click Control Panel.
 - b. Double-click the System icon. The System Properties dialog box will appear.

Enabling Hyper-Threading Technology

- c. Click the General tab. The processor shown under Computer should resemble the one shown below.

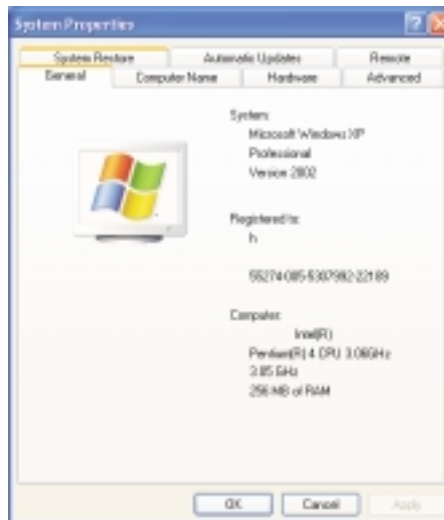

- d. Now click the Hardware tab then click Device Manager. The items shown under Computer and Processors should resemble the ones shown below.

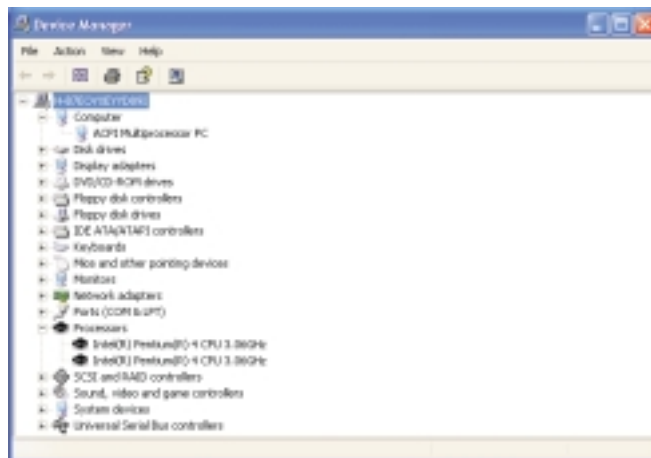

- e. Lastly, press the <Ctrl> <Alt> and keys simultaneously. The Windows Task Manager dialog box will appear. Click the Performance tab. The diagram under CPU Usage History should resemble the one shown below.

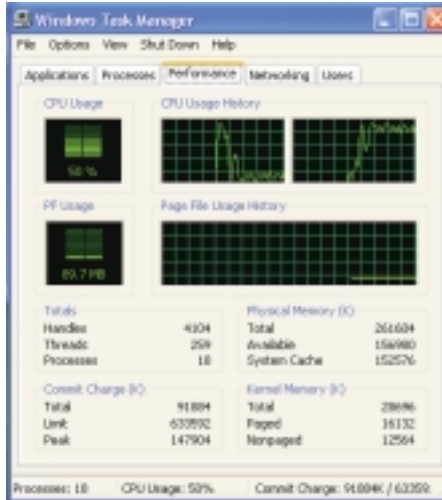

Appendix B - CPU Fan Protection

The CPU must be kept cool by using a CPU fan with heat sink. Without sufficient air circulation across the CPU and heat sink, the CPU will overheat damaging both the CPU and system board.

The system board supports the CPU Fan Protection function. It has the capability of monitoring the CPU fan when the system boots. Once it has detected that the CPU fan did not rotate, 5 warning beeps will sound then the system will automatically power-off. This preventive measure has been added to protect the CPU from damage and insure a safe computing environment.

To use the CPU Fan Protection function, please follow the steps below.

1. Before you power-on the system, make sure the heat sink and CPU fan are correctly installed onto the CPU. The system is capable of monitoring the CPU fan, therefore you must use a fan with sense pin to support this function. Connect the CPU fan to the CPU fan connector on the system board.
2. The "CPU Fan Protection" field in the PC Health Status submenu of the BIOS must be set to "Enabled".
3. You may now power-on the system.

Three circumstances may occur causing the system to detect CPU fan failure.

1. The CPU fan is not connected to the CPU fan connector on the system board.
2. The CPU fan may be damaged. Replace it with a new fan.
3. The CPU fan did not rotate immediately upon system boot-up or it took some time before the CPU fan rotated. Check whether the heat sink and fan are mounted properly onto the CPU then restart the system. If the same problem occurs, you must replace it with a good quality fan - one that will rotate immediately once power comes in and also one that will dissipate heat more efficiently, otherwise, you have to disable this function in the BIOS.

Appendix C - CPU Temperature Protection

The CPU Temperature Protection function has the capability of monitoring the CPU's temperature during system boot-up.

To use the CPU Temperature Protection function, please follow the steps below.

1. Select the "PC Health Status" submenu in the BIOS.
2. Set the "CPU Temp. Prot. Function" field to "Enabled".
3. Select the CPU temperature limit in the "CPU Temp. Prot. Alarm" field.
4. Press <Esc> to return to the main menu then save the settings by selecting "Save & Exit Setup".

Once the system has detected that the CPU's temperature exceeded the temperature limit defined in the BIOS, 5 warning beeps will sound then the system will automatically power-off.

Check whether the heat sink and fan are mounted properly onto the CPU because high CPU temperature may be due to incorrect fan / heat sink installation. Now restart the system. If the same problem persists, it may be the CPU fan is damaged or it is not rotating properly. Try replacing it with a new fan. If it is due to other contributing factors that resulted to high CPU temperature, you may need to set a lower CPU temperature limit.

CPU Temperature References

When you power-up a system, the BIOS message appears on the screen and the memory count begins. After the memory test, the CPU temperature range is normally between 32°C and 35°C. When you run an operating system then tried to reboot the system, the CPU temperature range at this time is between 40°C and 45°C. These temperature references serve as a guide when you select the CPU temperature limit.

Appendix D - System Error Message

When the BIOS encounters an error that requires the user to correct something, either a beep code will sound or a message will be displayed in a box in the middle of the screen and the message, PRESS F1 TO CONTINUE, CTRL-ALT-ESC or DEL TO ENTER SETUP, will be shown in the information box at the bottom. Enter Setup to correct the error.

D.1 POST Beep

There are two kinds of beep codes in the BIOS. One code indicates that a video error has occurred and the BIOS cannot initialize the video screen to display any additional information. This beep code consists of a single long beep followed by three short beeps. The other code indicates that a DRAM error has occurred. This beep code consists of a single long beep.

D.2 Error Messages

One or more of the following messages may be displayed if the BIOS detects an error during the POST. This list indicates the error messages for all Awards BIOSes:

CMOS BATTERY HAS FAILED

The CMOS battery is no longer functional. It should be replaced.



Caution:

Danger of explosion if battery incorrectly replaced. Replace only with the same or equivalent type recommended by the manufacturer. Dispose of used batteries according to the battery manufacturer's instructions.

CMOS CHECKSUM ERROR

Checksum of CMOS is incorrect. This can indicate that CMOS has become corrupt. This error may have been caused by a weak battery. Check the battery and replace if necessary.

DISPLAY SWITCH IS SET INCORRECTLY

The display switch on the motherboard can be set to either monochrome or color. This indicates the switch is set to a different

setting than indicated in Setup. Determine which setting is correct, either turn off the system and change the jumper or enter Setup and change the VIDEO selection.

FLOPPY DISK(S) fail (80)

Unable to reset floppy subsystem.

FLOPPY DISK(S) fail (40)

Floppy type mismatch.

Hard Disk(s) fail (80)

HDD reset failed.

Hard Disk(s) fail (40)

HDD controller diagnostics failed.

Hard Disk(s) fail (20)

HDD initialization error.

Hard Disk(s) fail (10)

Unable to recalibrate fixed disk.

Hard Disk(s) fail (08)

Sector Verify failed.

Keyboard is locked out - Unlock the key

The BIOS detects that the keyboard is locked. Keyboard controller is pulled low.

Keyboard error or no keyboard present

Cannot initialize the keyboard. Make sure the keyboard is attached correctly and no keys are being pressed during the boot.

Manufacturing POST loop

System will repeat POST procedure infinitely while the keyboard controller is pull low. This is also used for the M/B burn in test at the factory.

BIOS ROM checksum error - System halted

The checksum of ROM address F0000H-FFFFFH is bad.

Memory test fail

The BIOS reports memory test fail if the memory has error(s).

Appendix E - Troubleshooting

E.1 Troubleshooting Checklist

This chapter of the manual is designed to help you with problems that you may encounter with your personal computer. To efficiently troubleshoot your system, treat each problem individually. This is to ensure an accurate diagnosis of the problem in case a problem has multiple causes.

Some of the most common things to check when you encounter problems while using your system are listed below.

1. The power switch of each peripheral device is turned on.
2. All cables and power cords are tightly connected.
3. The electrical outlet to which your peripheral devices are connected is working. Test the outlet by plugging in a lamp or other electrical device.
4. The monitor is turned on.
5. The display's brightness and contrast controls are adjusted properly.
6. All add-in boards in the expansion slots are seated securely.
7. Any add-in board you have installed is designed for your system and is set up correctly.

Monitor/Display

If the display screen remains dark after the system is turned on:

1. Make sure that the monitor's power switch is on.
2. Check that one end of the monitor's power cord is properly attached to the monitor and the other end is plugged into a working AC outlet. If necessary, try another outlet.
3. Check that the video input cable is properly attached to the monitor and the system's display adapter.
4. Adjust the brightness of the display by turning the monitor's brightness control knob.

The picture seems to be constantly moving.

1. The monitor has lost its vertical sync. Adjust the monitor's vertical sync.
2. Move away any objects, such as another monitor or fan, that may be creating a magnetic field around the display.
3. Make sure your video card's output frequencies are supported by this monitor.

The screen seems to be constantly wavering.

1. If the monitor is close to another monitor, the adjacent monitor may need to be turned off. Fluorescent lights adjacent to the monitor may also cause screen wavering.

Power Supply

When the computer is turned on, nothing happens.

1. Check that one end of the AC power cord is plugged into a live outlet and the other end properly plugged into the back of the system.
2. Make sure that the voltage selection switch on the back panel is set for the correct type of voltage you are using.
3. The power cord may have a "short" or "open". Inspect the cord and install a new one if necessary.

Floppy Drive

The computer cannot access the floppy drive.

1. The floppy diskette may not be formatted. Format the diskette and try again.
2. The diskette may be write-protected. Use a diskette that is not write-protected.
3. You may be writing to the wrong drive. Check the path statement to make sure you are writing to the targeted drive.
4. There is not enough space left on the diskette. Use another diskette with adequate storage space.

Hard Drive

Hard disk failure.

1. Make sure the correct drive type for the hard disk drive has been entered in the BIOS.
2. If the system is configured with two hard drives, make sure the bootable (first) hard drive is configured as Master and the second hard drive is configured as Slave. The master hard drive must have an active/bootable partition.

Excessively long formatting period.

1. If your hard drive takes an excessively long period of time to format, it is likely a cable connection problem. However, if your hard drive has a large capacity, it will take a longer time to format.

Parallel Port

The parallel printer doesn't respond when you try to print.

1. Make sure that your printer is turned on and that the printer is on-line.
2. Make sure your software is configured for the right type of printer attached.
3. Verify that the onboard LPT port's I/O address and IRQ settings are configured correctly.
4. Verify that the attached device works by attaching it to a parallel port that is working and configured correctly. If it works, the printer can be assumed to be in good condition. If the printer remains inoperative, replace the printer cable and try again.

Serial Port

The serial device (modem, printer) doesn't output anything or is outputting garbled characters.

1. Make sure that the serial device's power is turned on and that the device is on-line.
2. Verify that the device is plugged into the correct serial port on the rear of the computer.
3. Verify that the attached serial device works by attaching it to a serial port that is working and configured correctly. If the serial device does not work, either the cable or the serial device has a problem. If the serial device works, the problem may be due to the onboard I/O or the address setting.
4. Make sure the COM settings and I/O address are configured correctly.

Keyboard

Nothing happens when a key on the keyboard was pressed.

1. Make sure the keyboard is properly connected.
2. Make sure there are no objects resting on the keyboard and that no keys are pressed during the booting process.

System Board

1. Make sure the add-in card is seated securely in the expansion slot. If the add-in card is loose, power off the system, re-install the card and power up the system.
2. Check the jumper settings to ensure that the jumpers are properly set.
3. Verify that all memory modules are seated securely into the memory sockets.
4. Make sure the memory modules are in the correct locations.
5. If the board fails to function, place the board on a flat surface and seat all socketed components. Gently press each component into the socket.
6. If you made changes to the BIOS settings, re-enter setup and load the BIOS defaults.

Free Manuals Download Website

<http://myh66.com>

<http://usermanuals.us>

<http://www.somanuals.com>

<http://www.4manuals.cc>

<http://www.manual-lib.com>

<http://www.404manual.com>

<http://www.luxmanual.com>

<http://aubethermostatmanual.com>

Golf course search by state

<http://golfingnear.com>

Email search by domain

<http://emailbydomain.com>

Auto manuals search

<http://auto.somanuals.com>

TV manuals search

<http://tv.somanuals.com>