

L440GX+ Server Board Product Guide

Order Number: 722077-005

Disclaimer

Intel Corporation (Intel) makes no warranty of any kind with regard to this material, including, but not limited to, the implied warranties of merchantability and fitness for a particular purpose. Intel assumes no responsibility for any errors that may appear in this document. Intel makes no commitment to update nor to keep current the information contained in this document. No part of this document may be copied or reproduced in any form or by any means without prior written consent of Intel.

An Intel® product, when used in accordance with its associated documentation, is "Year 2000 Capable" when, upon installation, it accurately stores, displays, processes, provides, and/or receives date data from, into, and between the twentieth and twenty-first centuries, including leap year calculations, provided that all other technology used in combination with said product properly exchanges date data with it.

† Third party brands and trademarks are the property of their respective owners.

Copyright © 1998, 1999 Intel Corporation.

Contents

1 Description

Server Board Features.....	7
Back Panel Connectors.....	8
Server Board Connector and Component Locations.....	9
Processor.....	10
Memory	10
440GX Host Bridge / Memory Controller	11
Peripherals.....	11
Super I/O Chip	11
Add-in Board Slots	12
Video	13
SCSI Controller	13
IDE Controller	13
Network Controller	14
Keyboard and Mouse.....	14
ACPI	14
Server Management	15
Baseboard Management Controller (BMC).....	15
Emergency Management Port Console.....	16
Platform Event Paging.....	16
Security.....	17
Security with Mechanical Locks and Monitoring	17
Software Locks.....	17

2 Upgrading

Tools and Supplies Needed	21
Warnings and Cautions.....	21
Server Board.....	22
Installing the Server Board	22
Removing the Server Board	23
Memory.....	24
Installing DIMMs.....	24
Removing DIMMs.....	25
Processors.....	26
Removing a Processor	26
Installing a Processor	28
Replacing the Back up Battery	30

3 Configuration Software and Utilities

Hot Keys	33
Power On Self Test (POST).....	34
Using BIOS Setup.....	35
Record Your Setup Settings	35
If You Cannot Access Setup.....	35
Starting Setup	36

Setup Menu	36
Main Menu	37
Advanced Menu	40
Security Menu	43
Server Menu.....	44
Boot Menu.....	48
Exit Menu	50
Using the System Setup Utility	50
When to Run the System Setup Utility	51
What You Need to Do	51
Running the SSU	52
Customizing the SSU	54
Launching a Task.....	54
Resource Configuration Add-in (RCA) Window	55
Multiboot Options Add-in	56
Security Add-in.....	57
SEL Manager Add-in	58
FRU Manager Add-in	59
SDR Manager Add-in	60
Exiting the SSU	60
Platform Event Paging	61
Using Platform Event Paging.....	61
Emergency Management Port Console.....	62
How EMP Console Works	63
Requirements.....	65
Setting up the Server for the EMP	66
Main EMP Console Window	67
Server Control Operations.....	68
Phonebook.....	71
Management Plug-ins	72
FRUSDR Load Utility	75
When to Run the FRUSDR Load Utility	75
What You Need to Do	75
How You Use the FRUSDR Load Utility	76
Upgrading the BIOS.....	79
Preparing for the Upgrade	79
Upgrading the BIOS	80
Recovering the BIOS.....	81
Changing the BIOS Language.....	81
Using the Firmware Update Utility	82
Running the Firmware Update Utility	82
Installing Video Drivers	82
Using the Adaptec SCSI Utility	83
Running the SCSI Utility	83

4 Solving Problems

Resetting the System	85
Fault Resilient Booting	85
Initial System Startup	85
Checklist	86
Running New Application Software	86
Checklist	86
After the System Has Been Running Correctly	87
Checklist	87
More Problem Solving Procedures	88
Preparing the System for Diagnostic Testing	88
Monitoring POST	88
Verifying Proper Operation of Key System Lights	88
Confirming Loading of the Operating System	88
Specific Problems and Corrective Actions	89
Power Light Does Not Light	89
No Characters Appear on Screen	89
Characters Are Distorted or Incorrect	90
System Cooling Fans Do Not Rotate Properly	90
Diskette Drive Activity Light Does Not Light	91
Hard Disk Drive Activity Light Does Not Light	91
CD-ROM Drive Activity Light Does Not Light	91
Cannot Connect to a Server	92
Problems with Network	92
PCI Installation Tips	93
Problems with Application Software	93
Bootable CD-ROM Is Not Detected	93
Error and Informational Messages	94
Port-80 Codes and Countdown Codes	94
POST Error Codes and Messages	94

5 Technical Reference

Connectors	96
ATX Style Front Panel Connector	97
Main Power Connector	98
Fan Interface	98
Server Board Jumpers	99
General Procedure to Change Jumper Setting	100
CMOS Jumper	101
Password Jumper	101
Recovery Boot Jumper	102
Boot Block Write Protect Jumper	102
FRB Timer Enable Jumper	103
Chassis Intrusion Detection Jumper	103

6 Regulatory and Integration Information

Regulatory Compliance	105
Installation Instructions	106
Ensure EMC	106

Ensure Host Computer and Accessory Module Certifications.....	107
Prevent Power Supply Overload.....	107
Place Battery Marking on Computer.....	108
Use Only for Intended Applications	108
Installation Precautions.....	108

7 Equipment Log and Power Consumption Worksheets

Equipment Log.....	109
Current Usage.....	111
Calculating Power Consumption.....	111

Index	115
--------------------	-----

Figures

1. Back Panel Connectors.....	8
2. Server Board Connector and Component Locations	9
3. Server Board Screw Hole Locations.....	23
4. Installing DIMMs.....	25
5. Installing a Processor	27
6. Removing a Termination Board.....	28
7. Replacing the Lithium Battery.....	31
8. System Setup Utility Main Window.....	53
9. EMP Console in Command State.....	63
10. EMP Console in Redirect State.....	64
11. Connect Dialog.....	69
12. Power On/Off Dialog	70
13. Reset Dialog	70
14. Phonebook Dialog.....	71
15. Connector Locations	96
16. ATX Style Front Panel Connector.....	97
17. Jumper Locations.....	99

Tables

1. Server Board Features.....	7
2. NIC LEDs.....	8
3. Software Security Features	19
4. Configuration Utilities	33
5. Hot Keys	33
6. EMP Console Access Modes (Server configured for console redirection)	64
7. EMP Console Access Modes (Server not configured for console redirection)	65
8. ATX Style Front Panel Connector Pinout.....	97
9. Main Power Connector Pinout.....	98
10. Fan Connector Pinout	98
11. Server Board Jumper Summary	99
12. Safety Regulations	105
13. EMC Regulations	105
14. Power Usage Worksheet 1.....	112
15. Power Usage Worksheet 2.....	113

1 Description

Server Board Features

Table 1. Server Board Features

Feature	Description
Processor	Installed: Up to two Intel® Pentium® II or Pentium III processors (with 100 MHz system bus) operating at 1.8 V to 3.5 V. The server board's voltage regulator is automatically programmed by the processor's VID pins to provide the required voltage.
Memory (DRAM)	Four 72 bit sockets for 168-pin, gold contact, 100 MHz, PC/100 compliant, ECC or non-ECC, registered or unbuffered, SDRAM dual inline memory modules (DIMM).
Video Memory	Installed: 2 MB of video memory.
PCI bus	Four standard PCI (PCI-33/32 bit) expansion slots for add-in boards. 1x32 bit PCI bus. Embedded devices: Video Controller, Network Interface Controller (NIC), and SCSI controller. Two PCI-66 MHz 32 bit 5 Volt expansion slots (backward compatible to PCI-33 MHz 32 bit).
ISA bus	One ISA expansion slot for an add-in board. Embedded PC-compatible support (serial, parallel, mouse, keyboard, diskette, and Plug and Play features).
Server Management	Thermal/voltage monitoring and error handling. Real time clock/calendar (RTC). Front panel controls and indicators (LEDs). System Setup Utility (SSU). Basic Input/Output System (BIOS), Power On Self Test (POST), and Setup stored in flash memory.
Graphics	Integrated onboard Cirrus Logic† CL-GD5480 super video graphics array (SVGA) controller.
SCSI	Adaptec† AIC-7896, supporting onboard Ultra2 (LVD) wide and Ultra-wide SCSI interfaces. Support for the Adaptec ARO-1130U2 RAIDport† III card is built into PCI slot 4.
Network	Integrated onboard NIC, an Intel® 82559 single chip PCI LAN controller for 10 or 100 Mbps TX Fast Ethernet networks. RJ-45 Ethernet connector and indicator LEDs at I/O back panel.
System I/O	PS/2-compatible keyboard and mouse ports, 6 pin DIN. Advanced parallel port, supporting Enhanced Parallel Port (EPP) level 1.7 and 1.9, ECP, compatible 25 pin. VGA video port, 15 pin. Two serial ports, 9 pin. RJ-45 Ethernet port. Two USB ports.
Form Factor	Server ATX form factor, 12 × 13 inches, ATX 2.01 compliant I/O.

Back Panel Connectors

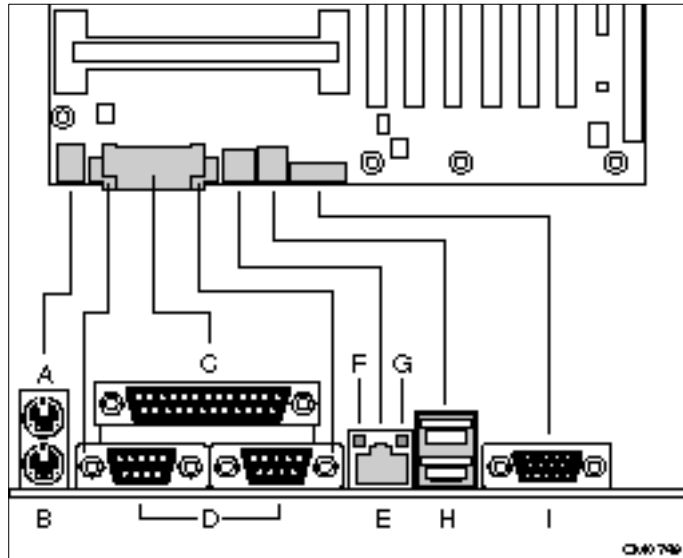

Figure 1. Back Panel Connectors

- A. Mouse connector
- B. Keyboard connector
- C. Parallel Port connector
- D. Serial Port connectors
- E. Network connector
- F. Green NIC LED
- G. Orange NIC LED
- H. USB connectors
- I. Video connector

Table 2. NIC LEDs

NIC LED Color	If it's on	If it's blinking	If it's off
Orange	100 Mbps network connection.	NA	10 Mbps network connection.
Green	Linked to network, no network traffic.	Linked to network, sending or receiving data.	Not linked to network.

Server Board Connector and Component Locations

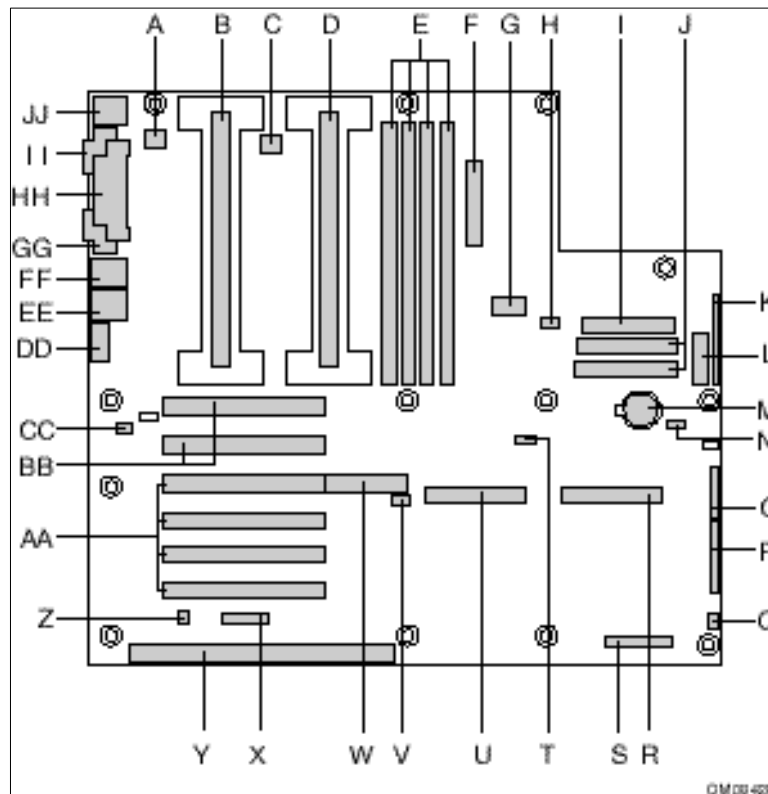

Figure 2. Server Board Connector and Component Locations

- | | |
|---|--|
| A. Fansink connector 2 | S. Server monitor module (SMM) connector |
| B. Secondary processor | T. External Wake on LAN [†] connector |
| C. Fansink connector 1 | U. Ultra2/LVDS SCSI connector |
| D. Primary processor | V. Hard drive LED connector |
| E. DIMM slots | W. Adaptec ARO-1130U2 RAID Port III connector/PCI slot 4 |
| F. Main power connector | X. Intelligent Chassis Management Bus (ICMB) header |
| G. ATX Aux power connector | Y. ISA connector |
| H. Fan connector FAN2A | Z. Chassis intrusion connector |
| I. Floppy connector | AA. PCI-33/32 connectors |
| J. IDE connectors | BB. PCI-66/32 connectors |
| K. ATX front panel connector | CC. Fan connector FAN2B |
| L. Front panel connector, 16 pin | DD. Video connector |
| M. Battery | EE. USB connectors |
| N. Isolated Server Management (ISOL) IMB (Intelligent Management Bus) connector | FF. NIC connector |
| O. Jumper block | GG. Serial port connector (default COM 1) |
| P. Jumper block | HH. Parallel port connector |
| Q. Fan connector 1 | II. Serial port connector (default COM 2) |
| R. Ultra Wide SCSI connector | JJ. Mouse/keyboard connectors |

Processor

Each Pentium II or Pentium III processor is packaged in a cartridge. The cartridge includes the processor core with an integrated 16 KB primary (L1) cache, the secondary (L2) cache, and a back cover.

The processor implements the MMX™ technology and maintains full backward compatibility with the 8086, 80286, Intel386™, Intel486™, Pentium, Pentium Pro and previous Pentium II processors. The processor's numeric coprocessor significantly increases the speed of floating point operations and complies with ANSI/IEEE standard 754-1985.

Each processor cartridge connects to the server board through a 242 pin edge connector. The cartridge is secured by a retention mechanism attached to the server board. Depending on configuration, your server may have one or two processors.

The processor external interface is MP (Multi-Processor) ready and operates at 100 MHz. The processor contains a local APIC (Advanced Programmable Interrupt Controller) section for interrupt handling in MP and UP (Uni-Processor) environments.

The second level cache is located on the substrate of the S.E.C. cartridge. The cache includes burst pipelined synchronous static RAM (BSRAM). The L2 cache is offered in 512 KB configurations only, with error correcting code (ECC) that operates at half the core clock rate.

NOTE

If you install a processor that is 550 MHz or faster, and you use the server management feature board, you must run the FRUSDR update utility.

Memory

Only 100 MHz PC/100 ECC or Non-ECC SDRAM is supported by the server board. Memory is partitioned as four banks of SDRAM DIMMs, each providing 72 bits of noninterleaved memory (64 bit main memory plus ECC):

- Install from 64 MB to 2 GB of memory, using registered DIMMs.
- Install from 32 MB to 1 GB of memory, using unbuffered DIMMs.

Memory should be added in order from slot 1 to slot 4.

NOTE

Do not mix registered and unbuffered memory. Non ECC memory may be installed but ECC memory is recommended in a server environment. Mixing Non-ECC memory and ECC memory causes all ECC features to be disabled.

The controller automatically detects, sizes, and initializes the memory array, depending on the type, size, and speed of the installed DIMMs, and reports memory size and allocation to the server via configuration registers.

⇒ NOTE

Use DIMMs that have been tested for compatibility with the server board. Contact your sales representative or dealer for a current list of approved memory modules. Check the Intel Customer Support website for the latest tested memory list:

<http://support.intel.com/support/motherboards/server/l440gx/compat.htm>

440GX Host Bridge / Memory Controller

The L440GX+ is designed around the Intel[®] 82440GX AGPSet (440GX). This device provides 100MHz processor host bus interface support, DRAM controller, PCI bus interface, AGP interface (used on L440GX+ for PCI-66/5V), and power management functions. The host bus/memory interface in the 440GX is optimized for 100MHz operation, using 100MHz SDRAM main memory. The PCI interface is PCI 2.1-compliant, providing a 33 MHz / 5V signaling environment for embedded controllers and slots in the single PCI segment on L440GX+. The 440GX memory controller supports up to 2 GB of ECC or Non-ECC memory, using PC/100 compliant Synchronous DRAM (SDRAM) devices on DIMM plug-in modules. ECC can detect and correct single-bit errors, and detect multiple-bit errors.

Peripherals

Super I/O Chip

The National[†] 87309 device supports two serial ports, one parallel port, diskette drive, PS/2-compatible keyboard and mouse. The server board provides a connector interface for each port.

Serial Ports

Each serial port can be set to one of four different COMx ports and can be enabled separately. When enabled, each port can be programmed to generate edge or level sensitive interrupts. When disabled, serial port interrupts are available to add-in boards.

Parallel Port

The 87309 provides one IEEE 1284-compatible 25 pin bidirectional EPP (supporting levels 1.7 and 1.9). BIOS programming of the 87309 registers enable the parallel port and determine the port address and interrupt. ECP mode is supported with 2 possible DMA channels. When disabled, the interrupt is available to add-in boards.

Add-in Board Slots

The server board has one full length ISA bus connector. ISA features:

- Bus speed up to 8.33 MHz
- 16 bit memory addressing
- Type A transfers at 5.33 Mbps
- Type B transfers at 8 Mbps
- 8 or 16 bit data transfers
- Plug and Play ready

The server board has four full length standard PCI (PCI-33/32 bit) connectors. PCI features:

- Bus speed up to 33 MHz
- 32 bit memory addressing
- 5 V signaling environment
- Burst transfers of up to 133 Mbps
- 8, 16, or 32 bit data transfers
- Plug and Play ready
- Parity enabled

The server board has two full length PCI-66 universal connectors (5 volt/3.3 volt cards designed for the 3.3v connector -cards with only one notch- will not fit). PCI features:

- Bus speed up to 66 MHz
- 32 bit memory addressing
- 5 V/3.3 V signaling environment
- Burst transfers of up to 266 Mbps
- 8, 16, or 32 bit data transfers
- Plug and Play ready
- Parity enabled

NOTE

If you install a PCI-33 card into one of the PCI-66 slots, the bus speed for both slots will be lowered to 33 MHz.

The components on some full length cards installed in slot 6 may interfere with the DIMM connector latches.

Video

The onboard, integrated Cirrus Logic CL-GD5480 64 bit VGA chip contains an SVGA controller that is fully compatible with these video standards: CGA, EGA, Hercules† Graphics, MDA, and VGA. The standard configuration comes with 2 MB of 10 ns onboard Synchronous Graphics Memory (SGRAM). The video controller supports pixel resolutions of up to 1600 x 1200 and up to 16.7 Million colors.

The SVGA controller supports analog VGA monitors (single and multiple frequency, interlaced and noninterlaced) with a maximum vertical retrace noninterlaced frequency of 100 Hz.

You cannot add video memory to the server board. Depending on the environment, the controller displays up to 16.7 M colors in some video resolutions. It also provides hardware accelerated bit block transfers (BITBLT) of data.

SCSI Controller

The embedded Adaptec AIC-7896 dual function SCSI controller provides both Ultra2 (LVDS) wide and Ultra wide SCSI interfaces as two independent PCI functions. PCI slot 4 is RAID-upgradeable, providing additional support for the ARO1130U2 RAID*port* III controller by Adaptec.

The SCSI bus is terminated on the server board with active terminators that cannot be disabled. The onboard device must always be at one end of the bus. The device at the end of the cable must be terminated. LVDS devices generally do not have termination capabilities. Non-LVDS devices generally are terminated through a jumper or resistor pack. The SCSI cable (Intel Part Number 745854-003) included with your server board (or integrator's kit) has been modified to include active termination. The cable is capable of supporting both Ultra-2 and non-Ultra-2 SCSI devices. Proper termination of the SCSI bus is required for stable operation of SCSI devices. When attaching any SCSI device to the cable, verify that they are **not** terminated. This is usually a configurable option using a jumper or terminator block on the device. Check the documentation that came with your SCSI device to verify this option. Termination of the SCSI bus is implemented using the active termination on the server board along with the active termination at the end of the SCSI cable.

IDE Controller

IDE is a 16 bit interface for intelligent disk drives with disk controller electronics onboard. The PCI/ISA/IDE Accelerator, also known as PIIX4e, is a multifunction device on the server board that acts as a PCI based Fast IDE controller. The device controls:

- PIO and IDE DMA/bus master operations
- Mode 4 timings
- Transfer rates up to 33 MB/s
- Buffering for PCI/IDE burst transfers
- Master/slave IDE mode
- Up to two devices per channel; two channels, IDE0 and IDE1

⇒ NOTE

18 inch maximum length of IDE cable on each channel: You can connect an IDE signal cable, up to a maximum of 18 inches each, to each IDE connector on the server board. Each cable can support two devices, one at the end of the cable and one 6 inches from the end of the cable.

Network Controller

The server board includes a 10BASE-T/100BASE-TX network solution based on the Intel 82559 single chip Fast Ethernet PCI Bus Controller. As a PCI bus master, the controller can burst data at up to 132 MB/s. The controller contains two receive and transmit FIFO buffers that prevent data overruns or underruns while waiting for access to the PCI bus. The controller has the following:

- 32 bit PCI bus master interface (direct drive of bus), compatible with PCI Bus Specification, Revision 2.1
- Chained memory structure with improved dynamic transmit chaining for enhanced performance
- Programmable transmit threshold for improved bus utilization
- Early receive interrupt for concurrent processing of receive data
- Onchip counters for network management
- Autodetect and autoswitching for 10 or 100 Mbps network speeds
- Support for both 10 Mbps and 100 Mbps networks, capable of full or half duplex, with back-to-back transmit at 100 Mbps

The network status LEDs on the server board indicate:

- Transmit/receive activity on the LAN
- Valid link to the LAN
- 10/100 Mbps transfer mode

Keyboard and Mouse

The keyboard/mouse controller is PS/2-compatible. The server may be locked automatically if there is no keyboard or mouse activity for a predefined length of time, if specified through the System Setup Utility (SSU). Once the inactivity (lockout) timer has expired, the keyboard and mouse do not respond until the previously stored password is entered.

ACPI

The L440GX+ supports the Advanced Configuration and Power Interface (ACPI) as defined by the ACPI 1.0 and PC97 specifications. An ACPI aware operating system can put the system into a state where the hard drives spin down, the system fans stop, and all processing is halted. However, the power supply will still be on and the processors will still be dissipating some power, so the power supply fan and processor fans will still run.

The L440GX+ supports sleep states s0, s1, s4, and s5. With future versions of Microsoft Windows[†] 9X that support ACPI, the BIOS will only support sleep states s0, s1, and s5. With

future versions of Microsoft Windows NT[†]x that support ACPI, the BIOS will support sleep states s0, s1, s4, and s5.

- s0: Normal running state.
- s1: Processor sleep state. No context will be lost in this state and the processor caches will maintain coherency.
- s4: Hibernate or Save to Disk: The memory and machine state are saved to disk. Pressing the power button or other wakeup event will restore the system state from the disk and resume normal operation. This assumes that no hardware changes have been made to the system while it was off.
- s5: Soft off: Only the RTC section of the PIIX4 and the BMC are running in this state.



CAUTION

The system is off only when the AC power is disconnected.

Server Management

Server Management features are implemented using one microcontroller.

Baseboard Management Controller (BMC)

All server management functionality is concentrated in the BMC. The BMC and associated circuitry are powered from +5V_Standby, which remains active when server power is switched off and the server is still plugged into AC power.

One major function of the BMC is to autonomously monitor system management events, and log their occurrence in the nonvolatile System Event Log (SEL). These include events such as overtemperature and overvoltage conditions, fan failure, or chassis intrusion. To enable accurate monitoring, the BMC maintains the nonvolatile Sensor Data Record (SDR), from which sensor information can be retrieved. The BMC provides an ISA host interface to SDR sensor information, so software running on the server can poll and retrieve the server's current status.

SEL contents can be retrieved after system failure, for analysis by field service personnel using server management software tools such as Intel Server Control available on the CD-ROM that ships with the L440GX+ server board or from the Intel Customer Support website:

<http://support.intel.com/support/motherboards/server/l440gx>

Because the BMC is powered by 5V_Standby, SEL and SDR information are also available via the IMB (Intelligent Management Bus). An Emergency Management Card, such as the Intel[®] LANDesk[®] SMM (Server Monitor Module) card available with the LANDesk Server Manager Pro package, can obtain the SEL and make it remotely accessible using a LAN or telephone line connection. While it receives the proper current, the BMC does the following:

- Monitors server board temperature and voltage
- Monitors processor presence and controls FRB
- Detects and indicates baseboard fan failure
- Manages the SEL interface
- Manages the SDR Repository interface

- Monitors the SDR/SEL timestamp clock
- Manages the server board Field Replaceable Unit (FRU) information interface
- Monitors the system management watchdog timer
- Monitors the periodic SMI timer
- Manages front panel NMI handling
- Monitors the event receiver
- Manages the ISA host and IMB interface
- Controls secure mode, including video blanking, floppy write-protect monitoring, and front panel lock/unlock initiation
- Manages the sensor event initialization agent
- Controls Wake on LAN via Magic Packet[†] support

Emergency Management Port Console

The Emergency Management Port (EMP) Console provides an interface to the Emergency Management Port (EMP). This interface allows remote server management via a modem or direct (serial port to serial port) connection.

The server control operations available with EMP Console are:

- Connecting to remote servers
- Powering the server on or off
- Resetting the server

The EMP Console uses three management plug-ins to monitor the server:

- SEL Viewer
- SDR Viewer
- FRU Viewer

The EMP Console also has Phonebook plug-in that can be used to create and maintain a list of servers and their phone numbers.

NOTE

EMP and PEP (Platform Event Paging) share your modem. PEP has priority over all applications except EMP. If an alert occurs, PEP will reset your modem and page you.

Platform Event Paging

With Platform Event Paging (PEP), your server can be configured to automatically dial up a paging service and page you when a platform event occurs. Platform events include temperature out-of-range, voltage out-of-range, chassis intrusion, fan failure, etc.

If PEP is enabled and the BMC receives or detects a new event, it automatically sends a page. It can send a page if the processors are down or if the system software is unavailable.

PEP needs an external modem connected to the server's EMP (Emergency Management Port) serial connection. This is typically the COM2 serial connector.

Security

To help prevent unauthorized entry or use of the server, Intel Server Control server management software monitors the system intrusion switch.

Security with Mechanical Locks and Monitoring

If installed, you can activate the chassis intrusion alarm switch. When the side door is opened, the switch transmits an alarm signal to the server board, where BMC firmware and server management software process the signal. The system can be programmed to respond to an intrusion by powering down or by locking the keyboard, for example.

Software Locks

The BIOS Setup and the System Setup Utility (SSU) provide a number of security features to prevent unauthorized or accidental access to the system. Once the security measures are enabled, you can access the system only after you enter the correct password(s). For example:

- Enable the keyboard lockout timer so that the server requires a password to reactivate the keyboard and mouse after a specified time out period—1 to 120 minutes.
- Set and enable an administrative password.
- Set and enable a user password.
- Set secure mode to prevent keyboard or mouse input and to prevent use of the front panel reset and power switches.
- Activate a hot key combination to enter secure mode quickly.
- Disable writing to the diskette drive when secure mode is set.
- Disable access to the boot sector of the operating system hard disk drive.

Using Passwords

You can set either the user password, the administrator password, or both passwords. If only the user password is set, you:

- Must enter the user password to enter BIOS Setup or the SSU.
- Must enter the user password to boot the server if Password on Boot is enabled in either the BIOS Setup or SSU.
- Must enter the user password to exit secure mode.

If only the administrator password is set, you:

- Must enter the administrator password to enter BIOS Setup or the SSU.
- Must enter the administrator password to boot the server if Password on Boot is enabled in either the BIOS Setup or SSU.
- Must enter the administrator password to exit secure mode.

If both passwords are set, you:

- May enter the user password to enter BIOS Setup or the SSU. However, you will not be able to change many of the options.
- Must enter the administrator password if you want to enter BIOS Setup or the SSU and have access to all of the options.

- May enter either password to boot the server if Password on Boot is enabled in either the BIOS Setup or SSU.
- May enter either password to exit secure mode.

Secure Mode

Configure and enable the secure boot mode by using the SSU. When secure mode is in effect:

- You can boot the server and the operating system will run, but you must enter the user password to use the keyboard or mouse.
- You cannot turn off system power or reset the server from the front panel switches.

Secure mode has no effect on functions enabled via the Server Manager Module or power control via the real time clock.

Taking the server out of secure mode does not change the state of system power. That is, if you press and release the power switch while secure mode is in effect, the system will not be powered off when secure mode is later removed. However, if the front panel power switch remains depressed when secure mode is removed, the server will be powered off.

Summary of Software Security Features

The table below lists the software security features and describes what protection each offers. In general, to enable or set the features listed here, you must run the SSU and go to the Security Subsystem Group, menu. The table also refers to other SSU menus and to the Setup utility.

Table 3. Software Security Features

Feature	Description
Secure mode	<p>How to enter secure mode:</p> <ul style="list-style-type: none"> Setting and enabling passwords automatically places the system in secure mode. If you set a hot-key combination (through the SSU or Setup), you can secure the system simply by pressing the key combination. This means you do not have to wait for the inactivity time-out period. <p>When the system is in secure mode: The server can boot and run the operating system, but mouse and keyboard input is not accepted until the user password is entered. At boot time, if a CD is detected in the CD-ROM drive or a diskette in drive A, the system prompts for a password. When the password is entered, the server boots from CD or diskette and disables the secure mode. If there is no CD in the CD-ROM drive or diskette in drive A, the server boots from drive C and automatically goes into secure mode. All enabled secure mode features go into effect at boot time. To leave secure mode: Enter the correct password(s).</p>
Disable writing to diskette	<p>In secure mode, the server will not boot from or write to a diskette unless a password is entered. To set this feature, use the SSU Security Subsystem Group. To write protect access to diskette whether the server is in secure mode or not, use the Setup main menu, Floppy Options, and specify Floppy Access as read only.</p>
Disable the power and reset buttons	<p>Enable the feature through the SSU. Then the power and reset buttons are disabled when the server is in secure mode.</p>
Set a time out period so that keyboard and mouse input are not accepted Also, screen can be blanked, and writes to diskette can be inhibited	<p>Specify and enable an inactivity time out period of from 1 to 120 minutes. If no keyboard or mouse action occurs for the specified period, attempted keyboard and mouse input will not be accepted. The monitor display will go blank, and the diskette drive will be write protected (if these security features are enabled through Setup or the SSU). To resume activity: Enter the correct password(s).</p>
Control access to using the SSU: set administrative password	<p>To control access to setting or changing the system configuration, set an administrative password and enable it through Setup or the SSU. If both the administrative and user passwords are enabled, either can be used to boot the server or enable the keyboard and/or mouse, but only the administrative password will allow Setup and the SSU to be changed. To disable a password, change it to a blank entry or press CTRL-D in the Change Password menu of the Administrative Password Option menu found in the Security Subsystem Group. To clear the password if you cannot access Setup or the SSU, change the Clear Password jumper (see Chapter 5).</p>

continued

Table 3. Software Security Features (continued)

Feature	Description
Control access to the system other than SSU: set user password	To control access to using the system, set a user password and enable it through Setup or the SSU. To disable a password, change it to a blank entry or press CTRL-D in the Change Password menu of the User Password Option menu found in the Security Subsystem Group. To clear the password if you cannot access Setup or the SSU, change the Clear Password jumper (see Chapter 5).
Boot without keyboard	The system can boot with or without a keyboard. During POST, before the system completes the boot sequence, the BIOS automatically detects and tests the keyboard if it is present and displays a message. There is no entry in the SSU to enable or disable a keyboard.
Specify the boot sequence	The sequence that you specify on the menu in the SSU MultiBoot Group will determine the boot order. If secure mode is enabled (a user password is set), then you will be prompted for a password before the server fully boots. If secure mode is enabled and the "Secure Boot Mode" option is also enabled, the server will fully boot but will require a password before accepting any keyboard or mouse input.

2 Upgrading

Tools and Supplies Needed

- Phillips (cross head) screwdriver (#1 bit and #2 bit)
- Jumper removal tool or needle nosed pliers
- Pen or pencil
- Antistatic wrist strap and conductive foam pad (recommended)

Warnings and Cautions

These warnings and cautions apply throughout this chapter. Only a technically qualified person should configure the server board.



WARNINGS

System power on/off: The power button **DOES NOT** turn off the system AC power. To remove power from system, you must unplug the AC power cord from the wall outlet. Make sure the AC power cord is unplugged before you open the chassis, add, or remove any components.

Hazardous conditions, devices & cables: Hazardous electrical conditions may be present on power, telephone, and communication cables. Turn off the server and disconnect the power cord, telecommunications systems, networks, and modems attached to the server before opening it. Otherwise, personal injury or equipment damage can result.



CAUTIONS

Electrostatic discharge (ESD) & ESD protection: ESD can damage disk drives, boards, and other parts. We recommend that you perform all procedures in this chapter only at an ESD workstation. If one is not available, provide some ESD protection by wearing an antistatic wrist strap attached to chassis ground—any unpainted metal surface—on your server when handling parts.

ESD and handling boards: Always handle boards carefully. They can be extremely sensitive to ESD. Hold boards only by their edges. After removing a board from its protective wrapper or from the server, place the board component side up on a grounded, static free surface. Use a conductive foam pad if available but not the board wrapper. Do not slide board over any surface.

Installing or removing jumpers: A jumper is a small plastic encased conductor that slips over two jumper pins. Some jumpers have a small tab on

top that you can grip with your fingertips or with a pair of fine needle nosed pliers. If your jumpers do not have such a tab, take care when using needle nosed pliers to remove or install a jumper; grip the narrow sides of the jumper with the pliers, never the wide sides. Gripping the wide sides can damage the contacts inside the jumper, causing intermittent problems with the function controlled by that jumper. Take care to grip with, but not squeeze, the pliers or other tool you use to remove a jumper, or you may bend or break the stake pins on the board.

Server Board

Installing the Server Board



CAUTION

The server board can be extremely sensitive to ESD and always requires careful handling. After removing it from the server, place it component side up on a nonconductive, static free surface to prevent shorting out the battery leads. If you place the board on a conductive surface, the battery leads may short out. If they do, this will result in a loss of CMOS data and will drain the battery. Do not slide the server board over any surface.

1. Observe the safety and ESD precautions at the beginning of this chapter.
2. Insert screws through the mounting holes and into the threaded standoffs. Make sure the board is properly seated, and then tighten all the screws firmly.
3. Connect all internal cables to the server board.



NOTE

The floppy cable (Intel Part Number 738992-002) has been modified to support all floppy drives. The floppy drive connector on the cable (see connector label) is **not** keyed. Care should be taken to match pin 1 of the cable, indicated with a red stripe on the cable, with pin 1 of the floppy drive.

4. Reinstall add-in boards.
5. Connect all internal cables to add-in boards. Make sure you connect the power cables to the correct power connectors.
6. Connect all peripheral device cables to the I/O panel on the rear of the server.
7. Run the SSU to configure the server.

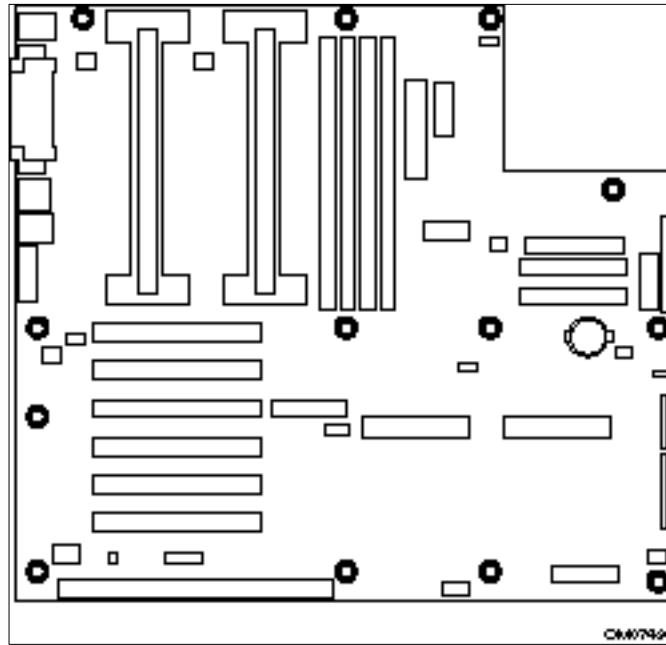

Figure 3. Server Board Screw Hole Locations

Removing the Server Board



CAUTION

The server board can be extremely sensitive to ESD and always requires careful handling. After removing it from the server, place it component side up on a nonconductive, static free surface to prevent shorting out the battery leads. If you place the board on a conductive surface, the battery leads may short out. If they do, this will result in a loss of CMOS data and will drain the battery. Do not slide the server board over any surface.

1. Observe the safety and ESD precautions at the beginning of this chapter.
2. Open the server and remove peripherals and components blocking access to the server board. See your chassis manual for more information.
3. Label and disconnect all internal cables connected to add-in boards.
4. Remove all add-in boards.
5. Label and disconnect all internal cables connected to the server board.
6. Remove the server board retaining screws and set them aside.
7. Remove the server board, and place it component side up on a nonconductive, static free surface or in an antistatic bag.
8. If present, remove and save the EMI gasket that covers the I/O connectors on the board.

Memory

Installing DIMMs



CAUTIONS

Use extreme care when installing a DIMM. Applying too much pressure can damage the socket. DIMMs are keyed and can be inserted in only one way.

Mixing dissimilar metals may cause later memory failures resulting in data corruption. Only install DIMMs with gold-plated edge connectors in gold-plated sockets.

See Chapter 1 for memory size and requirements.

1. Observe the safety and ESD precautions at the beginning of this chapter.
2. Open your server.
3. Holding the DIMM only by its edges, remove it from its antistatic package.
4. Orient the DIMM so that the two notches in the bottom edge of the DIMM align with the keyed socket.
5. Insert the bottom edge of the DIMM into the socket, and press down firmly on the DIMM until it seats correctly.
6. Gently push the plastic ejector levers on the socket ends to the upright position.
7. Repeat the steps to install each DIMM.
8. Close the server.
9. Connect all external cables and the power cord to the server.
10. Turn on the monitor and then the server.

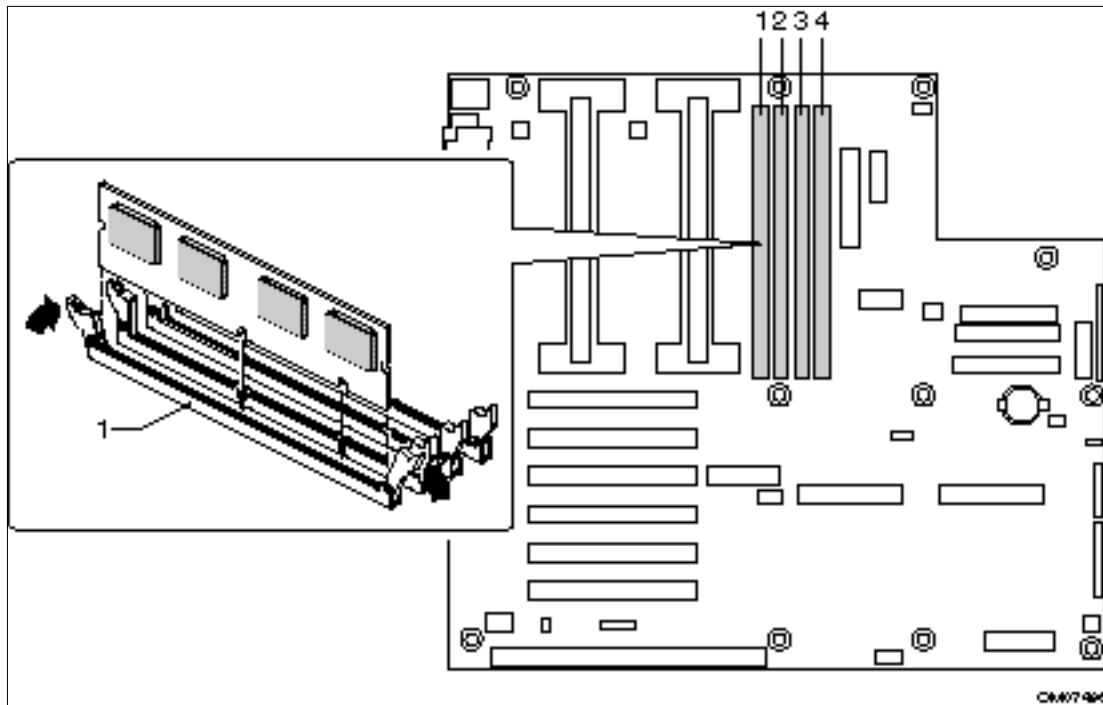

Figure 4. Installing DIMMs

Removing DIMMs



CAUTION

Use extreme care when removing a DIMM. Too much pressure can damage the socket slot. Apply only enough pressure on the plastic ejector levers to release the DIMM.

1. Observe the safety and ESD precautions at the beginning of this chapter.
2. Open the server.
3. Gently push the plastic ejector levers out and down to eject a DIMM from its socket.
4. Hold the DIMM only by its edges, being careful not to touch its components or gold edge connectors. Carefully lift it away from the socket, and store it in an antistatic package.
5. Repeat to remove other DIMMs as necessary.
6. Close the server.
7. Connect all external cables and the power cord to the server.
8. Turn on the monitor and then the server.

Processors



WARNING

If the server has been running, any installed processor and heat sink on the processor board(s) will be hot. To avoid the possibility of a burn, be careful when removing or installing server board components that are located near processors.



CAUTIONS

Processor must be appropriate: You may damage the server if you install a processor that is inappropriate for your server. Make sure your server can handle a newer, faster processor (thermal and power considerations). For exact information about processor interchangeability, contact your customer service representative or visit the Intel Customer Support website:

<http://support.intel.com/support/motherboards/server/l440gx>

Heat sink must be appropriate: Depending on your configuration, the existing processor may have a passive heat sink. If you REPLACE the processor with a faster one, it must have a fan heat sink (powered fan instead of a passive heat sink). If you ADD a second processor, it must have a fan heat sink. When adding a processor, you must leave the existing one in the primary connector (closest to the center of the server board).

ESD and handling processors: Reduce the risk of electrostatic discharge (ESD) damage to the processor by doing the following: (1) Touch the metal chassis before touching the processor or server board. Keep part of your body in contact with the metal chassis to dissipate the static charge while handling the processor. (2) Avoid moving around unnecessarily.

Removing a Processor

1. Observe the safety and ESD precautions at the beginning of this chapter and the additional cautions given here. If the processor has a fan heat sink, disconnect the power wire from the slot on the server board.
2. As you work, place boards and processors on a grounded, static free surface or conductive foam pad.
3. Carefully pull back the tab of the retention mechanism (B in figure 5) with your left hand until the processor can be rotated out of the slot. With your right hand, grasp the processor on the side closest to the retention mechanism tab you are pulling back on, and rotate the one side of the processor out of the slot. Once that side is free, you can pull the other side out of the slot.



CAUTION

This is a difficult process. Do not pull the tab of the retention mechanism back too far, as damage to either the retention mechanism or server board can occur. Pull the tab of the retention mechanism back just far enough for the retention lock to free the processor.

4. Put the processor in a piece of conductive foam and store in an antistatic package.

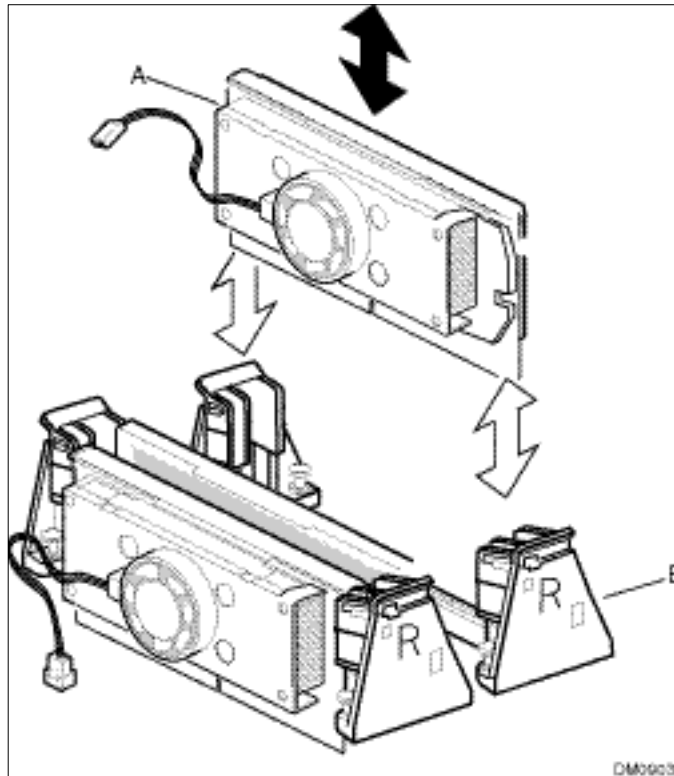

Figure 5. Installing a Processor

- A. Processor in Single Edge Contact cartridge
- B. Retention mechanism

Installing a Processor

1. Observe the safety and ESD precautions at the beginning of this chapter and the additional cautions given here.
2. If your server has one processor and you are **ADDING** a second, then you must remove the termination card from the secondary processor slot. Carefully pull back the tab of the retention mechanism with your left hand until the processor can be rotated out of the slot. With your right hand, grasp the processor on the side closest to the retention mechanism tab you are pulling back on, and rotate the one side of the processor out of the slot. Once that side is free, you can pull the other side out of the slot.



CAUTION

This is a difficult process. Do not pull the tab of the retention mechanism back too far, as damage to either the retention mechanism or server board can occur. Pull the tab of the retention mechanism back just far enough for the retention lock to free the processor.



NOTE

The processor Grounded Retention Mechanisms (GRM) are not compatible with SECC type processor packaging. The new GRMs only support SECC2 type processors. If you plan on using SECC type processors, you must use the Universal Retention Mechanism (URM). URMs can be ordered through your distributor.

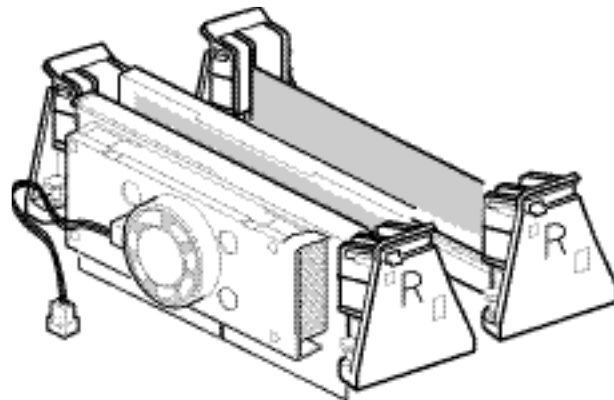

CM02024

Figure 6. Removing a Termination Board

3. If your server has one processor and you are REPLACING it, leave the termination board intact in the empty secondary slot. Remove the processor you want to replace. See “Removing a Processor” on page 26.
4. If your server has two processors and you are REPLACING one or both, remove the appropriate one(s). See “Removing a Processor” on page 26.
5. Remove the new processor from its antistatic package and place it on a grounded, static free surface or conductive foam pad.
6. Orient the processor so that the heat sink faces the I/O connectors. Slide the processor into the retention mechanism. Push down firmly, with even pressure on both sides of the top, until the processor is seated.
7. Attach the small end of the power cable to the fan connector on the S.E.C. cartridge, then attach the large end to the 3-pin connector on the server board.
8. After you have installed the processor, you must configure its speed in BIOS set-up.

Replacing the Back up Battery

The lithium battery on the server board powers the real time clock (RTC) for up to 10 years in the absence of power. When the battery starts to weaken, it loses voltage, and the server settings stored in CMOS RAM in the RTC (for example, the date and time) may be wrong. Contact your customer service representative or dealer for a list of approved devices.



WARNING

Danger of explosion if battery is incorrectly replaced. Replace only with the same or equivalent type recommended by the equipment manufacturer. Discard used batteries according to manufacturer's instructions.



ADVARSEL!

Lithiumbatteri - Eksplosjonsfare ved feilagtig håndtering. Utskiftning må kun ske med batteri af samme fabrikat og type. Levér det brugte batteri tilbage til leverandøren.



ADVARSEL

Lithiumbatteri - Eksplosjonsfare. Ved utskifting benyttes kun batteri som anbefalt av apparatfabrikanten. Brukt batteri returneres apparatleverandøren.



WARNING

Explosionsfara vid felaktigt batteribyte. Använd samma batterityp eller en ekvivalent typ som rekommenderas av apparattillverkaren. Kassera använt batteri enligt fabrikantens instruktion.



VAROITUS

Paristo voi räjähtää, jos se on virheellisesti asennettu. Vaihda paristo ainoastaan laitevalmistajan suosittelemaan tyyppiin. Hävitä käytetty paristo valmistajan ohjeiden mukaisesti.

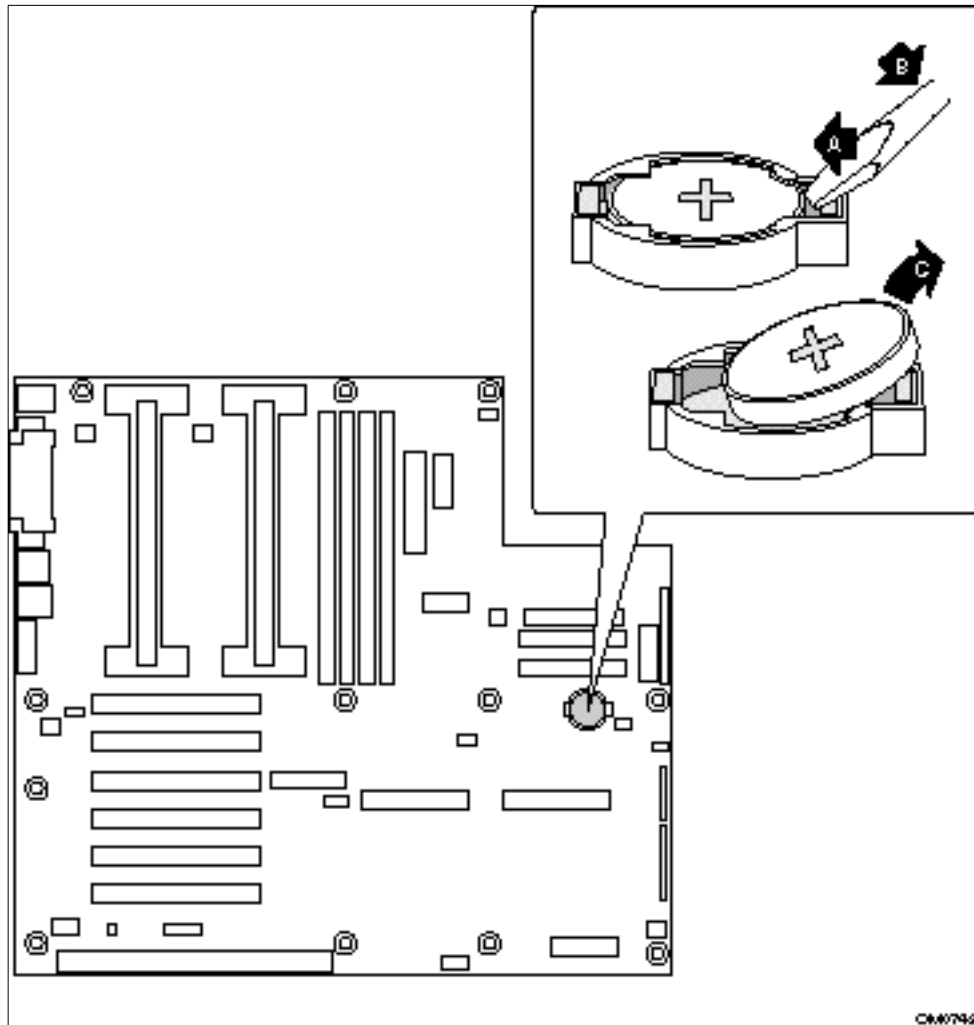

Figure 7. Replacing the Lithium Battery

1. Observe the safety and ESD precautions at the beginning of this chapter.
2. Open the chassis.
3. Insert the tip of a small flat bladed screwdriver, or equivalent, under the tab in the plastic retainer.
4. Gently push down on the screwdriver to lift the battery.
5. Remove the battery from its socket.
6. Dispose of the battery according to local ordinance.
7. Remove the new lithium battery from its package, and, being careful to observe the correct polarity, insert it in the battery socket.
8. Reinstall the plastic retainer on the lithium battery socket.
9. Close the chassis.
10. Run the SSU to restore the configuration settings to the RTC.

3 Configuration Software and Utilities

This chapter describes the Power On Self Test (POST) and server configuration utilities. The table below briefly describes the utilities.

Table 4. Configuration Utilities

Utility	Description and brief procedure	Page
BIOS Setup	If the system does not have a diskette drive, or the drive is disabled or misconfigured, use Setup to enable it. Or, you can move the CMOS jumper on the server board from the default setting (Protect CMOS memory) to the Clear setting; this will allow most server configurations to boot. For the procedure to do this, see the section "CMOS Jumper" in Chapter 5 in this manual. Then run the SSU to configure the server.	35
System Setup Utility (SSU)	Use for extended system configuration of onboard resources and add-in boards, and for viewing the system event log, setting boot device priority, or setting system security options. The SSU may be run from either the Server Configuration CD or from a DOS-bootable diskette. Information entered via the SSU overrides information entered via BIOS Setup.	50
EMP Console	Use to access and monitor the server remotely.	62
FRUSDR Load Utility	Use to update the Field Replacement Unit (FRU), Sensor Data Record (SDR), and Desktop Management Interface (DMI) flash components.	75
BIOS Update Utility	Use to update the BIOS or recover from a corrupted BIOS update.	79
Firmware Update Utility	Use to update BMC flash ROM.	82
Using the Adaptec SCSI Utility	Use to configure or view the settings of the SCSI host adapters and onboard SCSI devices in the server.	83

Hot Keys

Use the keyboard's numeric pad to enter numbers and symbols.

Table 5. Hot Keys

To do this:	Press these keys
Clear memory and reload the operating system—this is a system reset.	<Ctrl+Alt+Del>
Secure your system immediately.	<Ctrl+Alt>+hotkey (Set your hot key combination with the SSU or Setup.)

Power On Self Test (POST)

Each time you turn on the system, POST starts running. POST checks the server board, processor, memory, keyboard, and most installed peripheral devices. During the memory test, POST displays the amount of memory that it is able to access and test. The length of time needed to test memory depends on the amount of memory installed. POST is stored in flash memory.

1. Turn on your video monitor and server. After a few seconds POST begins to run.
2. After the memory test, these screen prompts and messages appear:

```
Press <F2> key if you want to run SETUP
```

```
Keyboard.....Detected
```

```
Mouse.....Detected
```

3. If you do not press <F2> and do NOT have a device with an operating system loaded, the above message remains for a few seconds while the boot process continues, and the system beeps once. Then this message appears:

```
Operating system not found
```

If you do not press <F2> and DO have an operating system loaded, the boot process continues, and this message appears:

```
Press <Ctrl><A> to enter SCSI Utility
```

4. Press <Ctrl+A> if there are SCSI devices installed. When the utility opens, follow the displayed instructions to configure the onboard SCSI host adapter settings and to run the SCSI utilities. Also see “Using the Adaptec SCSI Utility” on page 83. If you do not enter the SCSI utility, the boot process continues.
5. Press <Esc> during POST to pop up a boot menu when POST finishes. From this menu you can choose the boot device or enter BIOS Setup.

After POST completes, the system beeps once.

What appears on the screen after this depends on whether you have an operating system loaded and if so, which one.

If the system halts before POST completes running, it emits a beep code indicating a fatal system error that requires immediate attention. If POST can display a message on the video display screen, it causes the speaker to beep twice as the message appears.

Note the screen display and write down the beep code you hear; this information is useful for your service representative. For a listing of beep codes and error messages that POST can generate, see the “Solving Problems” chapter in this manual.

Using BIOS Setup

This section describes the BIOS Setup options. Use Setup to change the server configuration defaults. You can run Setup with or without an operating system being present. Setup stores most of the configuration values in battery backed CMOS; the rest of the values are stored in flash memory. The values take effect when you boot the server. POST uses these values to configure the hardware; if the values and the actual hardware do not agree, POST generates an error message. You must then run Setup to specify the correct configuration.

Run Setup: You may run Setup to modify such server board feature as:

- Select diskette drive
- Select parallel port
- Select serial port
- Set time/date (to be stored in RTC)
- Configure IDE hard drive
- Specify boot device sequence
- Enable SCSI BIOS
- Specify processor speed

Run SSU, not Setup: You must run the SSU instead of Setup to do the following:

- Add or remove any ISA board that is not Plug and Play-compatible
- Enter or change information about a board
- Alter server resources (such as interrupts, memory addresses, I/O assignments) to user selected choices instead of choices selected by the BIOS resource manager

Record Your Setup Settings

If the default values ever need to be restored (after a CMOS clear, for example), you must run Setup again. Referring to the worksheets could make your task easier.

If You Cannot Access Setup

If the diskette drive is misconfigured so that you cannot access it to run a utility from a diskette, you may need to clear CMOS memory. You will need to open the server, change a jumper setting, use Setup to check and set diskette drive options, and change the jumper back. For a step-by-step procedure, see Chapter 5, under the heading, "CMOS Jumper."

Starting Setup

You can enter and start Setup under several conditions:

- When you turn on the server, after POST completes the memory test
- When you reboot the server by pressing <Ctrl+Alt+Del> while at the DOS operating system prompt
- When you have moved the CMOS jumper on the server board to the “Clear CMOS” position (enabled); for the procedure, see Chapter 5, under the heading “CMOS Jumper”

In the three conditions listed above, after rebooting, you will see this prompt:

```
Press <F2> to enter SETUP
```

In a fourth condition, when CMOS/NVRAM has been corrupted, you will see other prompts but not the <F2> prompt:

```
Warning:  cmos checksum invalid
Warning:  cmos time and date not set
```

In this condition, the BIOS will load default values for CMOS and attempt to boot.

Setup Menus

To:	Press
Get general help	<F1> or <Alt+H>
Move between menus	← →
Go to the previous item	↑
Go to the next Item	↓
Change the value of an item	+ or -
Select an item or display a submenu	<Enter>
Leave a submenu or exit Setup	<Esc>
Reset to Setup defaults	<F9>
Save and exit Setup	<F10>

When you see this:	What it means
On screen, an option is shown but you cannot select it or move to that field.	You cannot change or configure the option in that menu screen. Either the option is autoconfigured or autodetected, or you must use a different Setup screen, or you must use the SSU.
On screen, the phrase Press Enter appears next to the option.	Press <Enter> to display a submenu that is either a separate full screen menu or a popup menu with one or more choices.

The rest of this section lists the features that display onscreen after you press <F2> to enter Setup. Not all of the option choices are described, because (1) a few are not user selectable but are displayed for your information, and (2) many of the choices are relatively self explanatory.

Main Menu

You can make the following selections on the Main Menu itself. Use the submenus for other selections.

Feature	Choices	Description
System Time	HH:MM:SS	Sets the system time.
System Date	MM/DD/YYYY	Sets the system date.
Legacy Diskette A:	Disabled 360KB 1.2 MB 720KB 1.44/1.25 MB 2.88 MB	Selects the diskette type.
Legacy Diskette B:	Disabled 360KB 1.2 MB 720KB 1.44/1.25 MB 2.88 MB	
Primary IDE Master		Enters submenu.
Primary IDE Slave		Enters submenu.
Secondary IDE Master		Enters submenu.
Secondary IDE Slave		Enters submenu.
Keyboard Features		Enters submenu.
Processor Settings		Enters submenu.
Language	English (US) Français Español Deutsch Italiano	Selects which language BIOS displays.

Primary/Secondary IDE Master and Slave Submenu

Feature	Choices	Description
Type	Auto None CD-ROM IDE Removable ATAPI Removable User	Auto forces the server to attempt autodetection of the drive type. None informs the server to ignore this drive. CD ROM allows the manual entry of some fields described below. IDE Removable allows the manual entry of some fields described below. ATAPI Removable allows the manual entry of some fields described below. User allows the manual entry of all fields described below.
CHS Format		
Cylinders	0 to 65535	Number of Cylinders on Drive. This field is changeable only for Type User.
Heads	1 to 16	Number of read/write heads on drive. This field is available only for Type User.
Sectors	0 to 63	Number of sectors per track. This field is available only for Type User.
Maximum Capacity	N/A	Computed size of drive from cylinders, heads, and sectors entered. This field is informational only.
LBA Format		
Total Sectors	N/A	This field is informational only.
Maximum Capacity	N/A	This field is informational only.
Multi-Sector Transfer	Disabled 2, 4, 8, or 16 sectors	Determines the number of sectors per block for multi-sector transfers. This field is informational only for Type Auto.
LBA Mode Control	Disabled Enabled	Enabling LBA causes logical block addressing to be used in place of cylinders, heads, and sectors. This field is informational only for Type Auto.
32 Bit I/O	Disabled Enabled	Enabling allows 32 bit IDE data transfers.
Transfer Mode	Standard Fast PIO 1 Fast PIO 2 Fast PIO 3 Fast PIO 4 FPIO 3 / DMA 1 FPIO 4 / DMA 2	Selects the method for moving data to and from the drive. This field is informational only for Type Auto.
Ultra DMA Mode	Disabled Mode 0 Mode 1 Mode 2	Selects the Ultra DMA mode used for moving data to/from the drive.

Keyboard Submenu

Feature	Choices	Description
Num Lock	On Off	Selects the power on state for Num Lock.
Key Click	Disabled Enabled	Enables or disables the audible key click.
Keyboard auto-repeat rate	30/sec 26.7/sec 21.8/sec 18.5/sec 13.3/sec 10/sec 6/sec 2/sec	Sets the numbers of time per second a key will repeat while it is held down.
Keyboard auto-repeat delay	1/4 sec 1/2 sec 3/4 sec 1 sec	Sets the delay before a key starts to repeat when it is held down.

Processor Settings Submenu

Feature	Choices	Description
CPU Speed Setting	350 MHz 400 MHz 450 MHz 500 MHz 550 MHz 600 MHz	Sets the speed for the installed processor(s).  CAUTION Attempting to set this higher than the proper speed for the installed processor(s) may cause damage to the processor(s) or prevent the server from booting until a CMOS clear is preformed.
CPU POST Speed Settings	N/A	This field is informational only.
Processor Retest	Yes No	Yes tells BIOS to clear the historical processor status and retest all processors on the next boot. BIOS automatically resets to No in next boot.
Memory Cache	Enabled Disabled	Enables processor cache.
Processor 1 Stepping ID	N/A	This field is informational only.
Processor 1 L2 Cache Size	N/A	This field is informational only.
Processor 2 Stepping ID	N/A	This field is informational only.
Processor 2 L2 Cache Size	N/A	This field is informational only.

Advanced Menu

You can make the following selections on the Advanced Menu itself. Use the submenus for the three other selections that appear on the Advanced Menu.

Feature	Choices	Description
Installed OS	Other Win95	Select Win95 if you are booting a Plug and Play capable operating system.
Reset Configuration Data	No Yes	Select Yes if you want to clear the server configuration data during next boot. System automatically resets to No in next boot.
PCI Configuration		Enters submenu.
Integrated Peripherals Configuration		Enters submenu.
Advanced Chipset Control		Enters submenu.
Use Multiprocessor Specification	1.1 1.4	Selects the version of multiprocessor specification to use. Some operating systems do not support version 1.4.
Large Disk Access Mode	CHS LBA	Select CHS if your OS is DOS. A large disk has more than 1024 cylinders, more than 16 heads, or more than 63 tracks per sector.
Delay on Option ROMs	Disabled Enabled	Forces a short delay at the end of each Option ROM scan.

PCI Configuration Submenu

The PCI Configuration Menu contains selections that access other submenus.

PCI Device, Embedded SCSI Submenu

Feature	Choices	Description
Option ROM Scan	Enabled Disabled	Enables option ROM scan of the onboard SCSI chip. There are 2 SCSI channels that are controlled by the same option ROM.
Enable Master	Enabled Disabled	Enabled selects the device as a PCI bus master.
Latency Timer	Default 0020h 0040h 0060h 0080h 00A0h 00C0h 00E0h	<p>Minimum guaranteed time, in units of PCI bus clocks, that a device may be master on a PCI bus.</p> <p> CAUTION Do not change this setting unless you fully understand the priority of this device on the PCI bus.</p>

PCI Device, Slot 1 - Slot 6 Submenus

Feature	Choices	Description
Enable Master	Enabled Disabled	Enables selected device as a PCI bus master.
Latency Timer	Default 020h 040h 060h 080h 0A0h 0C0h 0E0h	Minimum guaranteed time, in units of PCI bus clocks, that a device may be master on a PCI bus.  CAUTION Do not change this setting unless you fully understand the priority of this device on the PCI bus.

Integrated Peripheral Configuration Submenu

Feature	Choices	Description
COM1	Disabled Enabled Auto OS Controlled	Auto forces BIOS to configure the port. OS Controlled Forces the OS to configure the port.
Base I/O Address	3F8 2F8 3E8 2E8	Selects the base I/O address for COM 1.
Interrupt	IRQ 3 IRQ 4	Selects the IRQ for COM1.
COM2	Disabled Enabled Auto PnP OS	Auto forces BIOS to configure the port. PnP OS forces OS configures the port.
Base I/O Address	3F8 2F8 3E8 2E8	Selects the base I/O address for COM2.
Interrupt	IRQ 3 IRQ 4	Selects the IRQ for COM2.
Parallel Port	Disabled Enabled Auto PnP OS	Auto forces BIOS to configure the port. PnP OS forces OS configures the port.
Mode	Output only Bi-directional EPP ECP	Selects parallel port mode.
Base I/O Address	378 278	Selects the base I/O address for LPT port.

continued

Integrated Peripheral Configuration Submenu (continued)

Feature	Choices	Description
Interrupt	IRQ 5 IRQ 7	Selects the IRQ for LPT port.
DMA channel	DMA 1 DMA 3	Selects the DMA for LPT port (only used for ECP mode).
Floppy disk controller	Disabled Enabled	Enables onboard diskette controller.

Advanced Chipset Control

Feature	Choices	Description
640-768K Memory Region	Enabled Disabled	Enabled forwards ISA Master and DMA cycles to the PCI bus. Disabled forwards these cycles to memory.
Delayed Transaction	Enabled Disabled	Enables the delayed transaction mechanism when the PIIX4e is the target of a PCI transaction.
Passive Release	Enabled Disabled	Enables the passive release mechanism on the PHOLD# signal when the PIIX4 is a PCI Master.

Security Menu

You can make the following selections on the Security Menu itself. Enabling the Supervisor Password field requires a password for entering Setup. The passwords are not case-sensitive.

Feature	Choices	Description
User Password is	Clear Set	Status only; user cannot modify. Once set, this can be disabled by setting it to a null string, or by clearing password jumper on server board.
Supervisor Password is	Clear Set	Status only; user cannot modify.
Set User Password	Press Enter	When the <Enter> key is pressed, you are prompted for a password; press ESC key to abort. Once set, this can be cleared by setting it to a null string, or by clearing password jumper on server board (see Server Board Jumpers in Chapter 5).
Set Supervisor Password	Press Enter	When the <Enter> key is pressed, you are prompted for a password; press ESC key to abort. Once set, this can be cleared by setting it to a null string, or by clearing password jumper on server board (see Server Board Jumpers in Chapter 5).
Password on Boot	Disabled Enabled	Requires password entry before boot. System will remain in secure mode until password is entered. Password on Boot takes precedence over Secure Mode Boot.
Fixed Disk Boot Sector	Normal Write Protect	Write protects boot sector on hard disk to protect against viruses.
Secure Mode Timer	Disabled 1 min 2 min 5 min 10 min 20 min 1 hr 2 hr	Period of key/PS/2 mouse inactivity specified for secure mode to activate. A password is required for secure mode to function. Cannot be enabled unless at least one password is enabled.
Secure Mode Hot Key (Ctrl-Alt-)	[] [A, B, ..., Z]	Key assigned to start the Quicklock feature. Cannot be enabled unless at least one password is enabled.
Secure Mode Boot	Disabled Enabled	System will boot in secure mode. You must enter a password to unlock the system. Cannot be enabled unless at least one password is enabled.
Video Blanking	Disabled Enabled	Blank video when secure mode is activated. You must enter a password to unlock the system. Cannot be enabled unless at least one password is enabled.
Floppy Write Protect	Disabled Enabled	When secure mode is activated, the diskette drive is write protected. You must enter a password to disable. Cannot be enabled unless at least one password is enabled.
Front Panel Lockout	Disabled Enabled	When secure mode is activated, the reset and power switches are locked. You must enter a password to unlock the system. Cannot be enabled unless at least one password is enabled.

Server Menu

You can make the following selections on the Server Menu itself.

Feature	Choices	Description
System Management		Enters submenu.
Console Redirection		Enters submenu.
PEP Management		Enters submenu.
Enable Sleep Button	Disabled Enabled	
PCI IRQs to IO-APIC mappings	Disabled Enabled	Enabled - BIOS can describe all 24 IO APIC pins in the MP table for PCI interrupts. Not all MP operating systems and drivers can understand this description of the interrupts in the MP table. Disabled - BIOS will only use 16 IO APIC pins in the MP table for PCI interrupts. All PCI interrupts are routed to a standard ISA IRQ pins on IO APIC. All operating systems will work with standard ISA IRQ entries.
Processor Retest	Yes No	Yes tells BIOS to clear the historical processor status and retest all processors on the next boot. BIOS automatically resets to No in next boot.
Assert NMI on PERR	Disabled Enabled	Enabled generates an NMI on a parity error (PERR). To activate this feature, the system error (SERR) option must be enabled.
Assert NMI on SERR	Disabled Enabled	Enabled generates an NMI on SERR.

System Management Submenu

Feature	Choices	Description
Server Management Info		Enters submenu.
System Event Logging	Disabled Enabled	When enabled, system events will be logged by BIOS and BMC in system event log.
Clear Event Log	No Yes	Yes clears the system event log (SEL) in BMC. BIOS automatically resets to NO for next boot.
EMP Password switch	Disabled Enabled	Sets the EMP password.
EMP Password	[A..Z, 0..9]	This field only shows up when the EMP password switch is enabled. Entering a password and pressing return will send the password immediately to the BMC. If a beep is heard the password was not accepted. If no password is entered, anyone has access to the server through the EMP Console.
EMP Escape sequence	+++	Sets the escape sequence for the modem being used for EMP. This will force the modem to command mode. This is only used if the EMP direct connect/modem mode is set to modem.

continued

System Management Submenu (continued)

Feature	Choices	Description
EMP Hangup Line String	ATH	Sets the Hangup Line Sequence for the modem being used for EMP. Used in EMP modem mode.
Modem Init String	AT&F0S0=1S14=0&D	Sets the initialization string for the modem being used for EMP. Used in EMP modem mode. This field is only 16 characters long. The High Modem Init String field is a continuation of the Modem Init string so you can enter in another 4 characters.
High Modem Init String	0	This is a continuation of the Modem Init String. When 16 characters are typed into the Modem Init String field, this field will appear to allow another 4 characters to be typed in.
EMP Access Mode	Pre-boot Only Always Active Disabled	Pre-boot Only - EMP is only enabled during power down through end of POST. COM2 is returned to system use at the end of Post when operating system boots. Always Active - EMP is always enabled. COM2 cannot be used by operating system. It is now dedicated for EMP use. Disabled – EMP is disabled. COM2 is always available for system use by console redirection or operating system.
EMP Restricted Mode Access	Disabled Enabled	If set to Enabled, Power on/off and Reset server controls via EMP are no longer available.
EMP Direct Connect/Modem Mode	Direct Connect Modem Mode	Sets how EMP connects to the server. Direct Connect means a null modem serial cable directly connects COM2 connector port to the EMP console machine. Modem mode indicates that a modem is connected on COM2 for EMP use.

Server Management Information Submenu

Items on this menu are set when the server board is manufactured and cannot normally be changed. The last two items refer to the firmware level of the BMC on the server board and HSC (Hot Swap Controller) from the Astor II server chassis. If circumstances require a change in the L440GX+ server board's firmware, specific direction will be provided by Intel Customer Support.

Feature	Choices	Description
Board Part Number	N/A	Information field only
Board Serial Number	N/A	Information field only
System Part Number	N/A	Information field only
System Serial Number	N/A	Information field only
Chassis Part Number	N/A	Information field only
Chassis Serial Number	N/A	Information field only
BMC Revision	N/A	Information field only
Primary HSB Revision	N/A	Information field only

Console Redirection Submenu

Feature	Choices	Description
COM Port Address	Disabled 3F8 2F8 3E8	When enabled, console redirection uses the I/O port specified. 3F8 - typically is COM1 2F8 - typically is COM2 All keyboard/mouse and video will be directed to this port. This is designed to be used only under DOS in text mode.
IRQ #	N/A	This field is informational only.
Baud Rate	9600 19.2k 38.4k 115.2k	When console redirection is enabled, specifies the baud rate to be used.
Flow Control	No Flow Control CTS/RTS XON/XOFF CTS/RTS + CD	None disallows flow control. CTS/RTS is hardware-flow control. XON/XOFF is software-flow control. CTS/RTS +CD is hardware plus carrier-detect flow control.

PEP Management Submenu

Verify in BIOS Setup of your server board whether or not your system BIOS includes PEP. If not, when it becomes available, you can download it from the Intel Customer Support website:

<http://support.intel.com/support/motherboards/server/l440gx>

Feature	Choices	Description
PEP Filter Events		Enters submenu.
PEP Enable	Disable Enable	Enables Platform Event Paging.
PEP Blackout Period	[0...9]	Sets the amount of time between pages in minutes. Valid range is from 0 to 10.
PEP Page String		Sets the string used to page you. Generally this is the attention command for your modem, followed by the number of your paging service, followed by the message you want to appear on your pager, followed by a modem hangup command. Use commas for 1second pauses. This field is only 16 characters long. The 16-31, 32-47, and 48-63 fields are a continuation of the PEP Page String Field so you can enter in another 48 characters for 64 characters total.
16-31		This is a continuation of the PEP Page String Field. When 16 characters are typed into the Modem Init String field, this field will appear to allow another 16 characters to be typed in.
32-47		This is a continuation of the PEP Page String Field. When 16 characters are typed into the Block #1 field, this field will appear to allow another 16 characters to be typed in.
48-63		This is a continuation of the PEP Page String Field. When 16 characters are typed into the Block #2 field, this field will appear to allow another 16 characters to be typed in.
Send Test Page	Press Enter Send Test Page Now	To send a test page, select "Send Test Page Now" from the popup menu.

PEP Filter Submenu

This submenu allows you to set which events or error conditions cause the system to page you.

Feature	Choices	Description
PEF Enable	Disable Enable	Enables the Platform Event Filtering. If this is enabled, and one of the events you enable below occurs, the server will page you using the Page String (NV) information.
Temperature Sensor	Disable Enable	
Voltage Sensor	Disable Enable	
Fan Sensor	Disable Enable	
Chassis Sensor	Disable Enable	
Power Supply	Disable Enable	
BIOS (SMI Handle)	Disable Enable	
BIOS POST	Disable Enable	
FRB Sensor	Disable Enable	
Fatal NMI	Disable Enable	
Watchdog Timer Reset	Disable Enable	
System Restart	Disable Enable	

Boot Menu

You can make the following selections on the Boot Menu itself.

Feature	Choices	Description
Boot-time Diagnostic Screen	Disabled Enabled	
Extended RAM Step		Enters submenu.
Boot Device Priority		Enters submenu.
Hard Drive		Enters submenu.
Removable Devices		Enters submenu.

Extended RAM Step

Choice	Description
1 MB	Tests extended memory once per MegaByte
1 KB	Tests extended memory once per KiloByte
Every Location	Tests all extended memory
No Memory test	No extended memory is tested

Boot Device Priority

Use the up or down arrow keys to select a device; then press the <+> or <-> keys to move the device higher or lower in the boot priority list.

Boot Priority	Device	Description
1.	Removable Devices	Attempts to boot from a removable media device.
2.	Hard Drive	Attempts to boot from a hard drive device.
3.	ATAPI CD-ROM Drive	Attempts to boot from an ATAPI CD-ROM drive.
4.	LANDesk (R) Service Agent II	Attempts to boot from the local area network.

Hard Drive

For options on this menu, use the up or down arrow keys to select a device; then press the <+> or <-> keys to move the device higher or lower in the boot priority list.

Option	Description
1. Hard Drive #1 (or actual drive string)	IDE drives will have a suffix attached to the drive ID string. PM - hard drive on Primary Master Channel PS - hard drive on Primary Slave Channel SM - hard drive on Secondary Master Channel SS - hard drive on Secondary Slave Channel SCSI CD-ROMs will be displayed here because the onboard SCSI BIOS treats CD-ROMs as hard drives. SCSI ZIP or removable drives will also appear here. Removable IDE ZIP drives will only show up if the removable media is formatted as a hard drive.
2. Other Bootable Device	Covers all the boot devices that are not reported to the system BIOS through the BIOS boot specification mechanism. This includes all PCI cards that are not BIOS boot compliant (legacy) as well as ISA cards that are not PnP compliant. ISA legacy cards will boot first before non BIOS boot compliant PCI cards (in scan order from lowest slot to highest).

Removable Devices

For options on this menu, use the up or down arrow keys to select a device, then press the <+> or <-> keys to move the device higher or lower in the boot priority list.

Option	Description
1. Legacy Floppy Drive	Refers to the onboard 3.5" floppy drive. Removable IDE media may also show up here if the removable media was formatted in floppy emulation.

Exit Menu

You can make the following selections on the Exit Menu. Select an option using the up or down arrow keys; then press <Enter> to execute the option. Pressing <Esc> does not exit this menu. You must select one of the items from the menu or menu bar to exit.

Choices	Description
Exit Saving Changes	Exits after writing all modified Setup item values to NVRAM.
Exit Discarding Changes	Exits leaving NVRAM unmodified.
Load Setup Defaults	Loads values of all Setup items from previously saved custom defaults.
Load Custom Defaults	Loads default values for all Setup items.
Save Custom Defaults	Saves present Setup values to custom defaults.
Discard Changes	Reads previous values of all Setup items from NVRAM.
Save Changes	Writes all Setup item values to NVRAM.

Using the System Setup Utility

The System Setup Utility (SSU) is on the L440GX+ Server Board Resource software CD shipped with the server board. The SSU provides a graphical user interface (GUI) over an extensible framework for server configuration. For the L440GX+ systems, the SSU framework supports the following functions and capabilities:

- assigns resources to baseboard devices and add-in cards prior to loading the operating system (OS)
- allows you to specify boot device order and system security options
- permits viewing and clearing of the system's critical event log
- allows troubleshooting of the server when the OS is not operational
- provides a system level view of the server's I/O devices

When to Run the System Setup Utility

The SSU is a DOS-based utility that supports extended system configuration operations for onboard resources and add-in boards. You can also view the system event log and to set system boot and security options. Use the SSU when you need to

- add and remove boards affecting the assignment of resources (ports, memory, IRQs, DMA)
- modify the server's boot device order or security settings
- change the server configuration settings
- save the server configuration
- view or clear the system event log

If you install or remove an ISA add-in board, you must run the SSU to reconfigure the server. Running the SSU is optional for PCI and Plug and Play ISA add-in boards.

The SSU is PCI aware, and it complies with the ISA Plug and Play specifications. The SSU works with any compliant configuration (.CFG) files supplied by the peripheral device manufacturer.

The I/O baseboard comes with a .CFG file. The .CFG file describes the characteristics of the board and the system resources that it requires. The configuration registers on PCI and ISA Plug and Play add-in boards contain the same type of information that is in a .CFG file. Some ISA boards also come with a .CFG file.

The SSU uses the information provided by .CFG files, configuration registers, FLASH, and the information that you enter, to specify a system configuration. The SSU writes the configuration information to flash memory.

The SSU stores configuration values in FLASH memory. These values take effect when you boot the server. POST checks the values against the actual hardware configuration; if they do not agree, POST generates an error message. You must then run the SSU to specify the correct configuration before the server boots.

The SSU always includes a checksum with the configuration data so the BIOS can detect any potential data corruption before the actual hardware configuration takes place.

What You Need to Do

The SSU may be run directly from the Server Resource CD by booting the server system to the CD and selecting "Utilities" or from a set of DOS diskettes.

If you choose to run the SSU from a set of DOS diskettes, you must create the SSU diskettes from the Server Resource CD by booting to the CD and selecting "Create Diskettes." Alternatively, if you have a Windows 95 or Windows NT workstation, you can insert the CD into that system and create diskettes from the "Utilities" menu of the graphical user interface.

If your diskette drive is disabled, or improperly configured, you must use the flash resident Setup utility to enable it so that you can use the SSU. If necessary, you can disable the drive after you exit the SSU. Information entered using the SSU overrides any entered using Setup.

Running the SSU

- **Running the SSU Locally**

Running the ssu.bat file provided on the SSU media starts the SSU. If the server boots directly from the SSU media, the ssu.bat file is automatically run. If it boots from a different media, the SSU can be started manually or by another application. When the SSU starts in the local execution mode (the default mode), the SSU accepts input from the keyboard and/or mouse. The SSU presents a VGA based Graphical User Interface (GUI) on the primary monitor.

The SSU runs from writable, nonwritable, removable, and nonremovable media. If the SSU is run from nonwritable media, user preference settings (such as screen colors) can not be saved.

The SSU supports the ROM-DOS V6.22 operating system. It may run on other ROM-DOS-compatible operating systems but they are not supported. The SSU will not operate from a “DOS box” running under an operating system such as Windows.

- **Running the SSU Remotely**

Running the SSU remotely requires a remote server with a LANDesk Server Monitor Module 2 (SMM2) card and a local system with Remote Control software available.

The SMM2 card provides video memory, keyboard, and mouse redirection support for the remote server. The Remote Control console of the local system displays and sends video memory and user input to the remote server through either a modem or an Ethernet link.

Because the SSU runs exclusively on the remote server, any files required for the SSU to run must be available on the remote server (on removable or nonremovable media).

If you connect the local system to the remote server through a network or modem you can see the console, control the mouse, and control the keyboard of the remote server.

Starting the SSU

SSU consists of a collection of task oriented modules plugged into a common framework called the Application Framework (AF). The Application Framework provides a launching point for individual tasks and a location for setting customization information. For full functionality the SSU requires the availability of the AF.INI, AF.HLP, plus any .ADN files and their associated .HLP and .INI files.

1. Turn on your video monitor and your system.
2. There are two ways to start the SSU.
 - a. **After creating set of three SSU diskettes from the CD:** Insert the first SSU diskette in drive A, and press the reset button or <Ctrl+Alt+Del> to reboot your server from the diskette.
 - b. **Directly from the Server Resource CD:** Insert the Server Resource CD into your CD ROM drive and press the reset button or <Ctrl-Alt-Del> to reboot. When prompted to do so, press <F2> to enter BIOS Setup. From the Boot Menu, select the Boot Device Priority option and then select CD-ROM as your primary boot device. Save those settings and exit BIOS Setup. The server will boot from the CD-ROM and display a menu of options. Follow the instructions in the menu to start the SSU.
3. When the SSU title appears on the screen, press <Enter> to continue.
4. The mouse driver loads if it is available; press <Enter> to continue.

5. This message appears:
Please wait while the Application Framework loads....
6. When the main window of the SSU appears, you can customize the user interface before continuing.

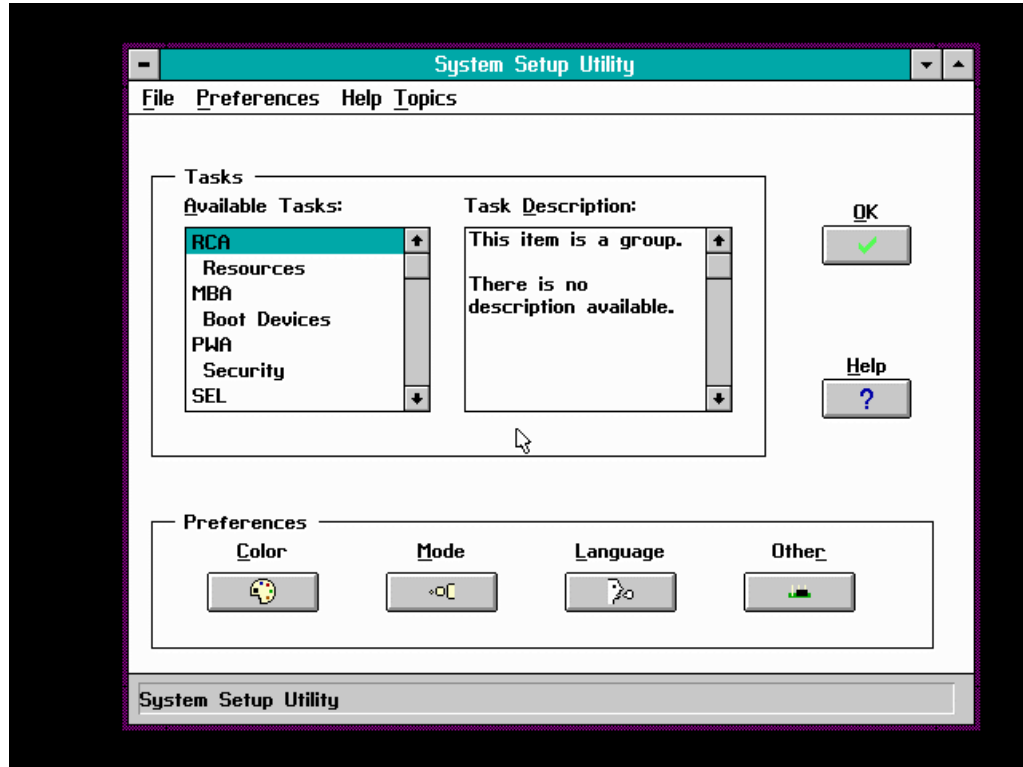

Figure 8. System Setup Utility Main Window

Customizing the SSU

The SSU lets you customize the user interface according to your preferences. The AF sets these preferences and saves them in the AF.INI file so that they take effect the next time you start the SSU. There are four user customizable settings:

- **Color** - this button lets you change the default colors associated with different items on the screen with predefined color combinations. The color changes are instantaneous.
- **Mode** - this button lets you set the desired expertise level.
 - novice
 - intermediate
 - expert

The expertise level determines which tasks are visible in the Available Tasks section and what actions each task performs. For a new mode setting to take effect, you must exit the SSU and restart it.

- **Language** - this button lets you change the strings in the SSU to strings of the appropriate language. For a new language setting to take effect, you must exit the SSU and restart it.
- **Other** - this button lets you change other miscellaneous options in the SSU. The changes take effect immediately.

To change the interface default values:

Use the mouse to click on the proper button in the Preferences section of the SSU Main window.

or

Use the tab and arrow keys to highlight the desired button, and press the spacebar or <Enter>.

or

Access the menu bar with the mouse or hot keys (Alt + underlined letter).

⇒ NOTE

If you run the SSU from nonwritable media (like a CD-ROM), these preferences will be lost when you exit the SSU.

Launching a Task

It is possible to have many tasks open at the same time, although some tasks may require complete control to avoid possible conflicts. The tasks achieve complete control by keeping the task as the center of operation until you close the task window.

To launch a task:

In the SSU Main window, double click on the task name under Available Tasks to display the main window for the selected task.

or

Highlight the task name, and click on OK.

or

Use the tab and arrow keys to highlight the desired button, and press the spacebar or <Enter>.

Resource Configuration Add-in (RCA) Window

The RCA provides three major functions:

- Creates representations of devices that cannot be discovered by the system (ISA cards)
- Modifies the contents of the system by adding and removing devices
- Modifies the resources used by devices

You can use the RCA window to define an ISA card or add an ISA card by clicking on the appropriate button. Removing an ISA card requires that the card be highlighted in the Devices section of the screen before clicking on the button. You can only add as many ISA cards as you have ISA slots available.

1. From the SSU main window, launch the RCA by selecting the “Resources” task under the RCA heading in the task box.
2. When the RCA window appears, it displays messages similar to the following:

```
Baseboard:  Server board Server board
PCI Card:  Bus 00 dev 00 -- Host Processor Bridge
PCI Card:  Bus 00 dev 0D -- Multifunction Controller
PCI Card:  Bus 00 dev 0F -- Ethernet Controller
PCI Card:  Bus 00 dev 12 -- Multifunction Controller
PCI Card:  Bus 00 dev 14 -- VGA Controller
```

3. To configure a device, select its name in the Devices section of the RCA window, and press the spacebar or <Enter>, or click on it.
4. It is possible to close the RCA window and return to the AF by clicking on the Close button. Any changes made will be kept in memory for use by the RCA when it is rerun.
5. Save all the changes made by clicking on the Save button. Saving writes your current configuration to nonvolatile storage where it will be available to the system after every reboot.
6. Closing the window by clicking on the system menu, the dash in the upper left corner, discards all changes.

Defining an ISA Card

An ISA card usually comes with a vendor created .CFG file that specifies the resources the card requires to function properly. If the .CFG file is unavailable, you must manually create it or define the card through the SSU. Defining an ISA card consists of specifying the name of the card and the resources it consumes. This allows the RCA to consider the ISA card resource requirements when the RCA tries to resolve conflicts. The information is also used by the system BIOS to configure the hardware when the system is booted.

1. To add or remove ISA card resources, click on the appropriate resource buttons, select the desired value, and click on Add or Remove.
2. After you complete the necessary information, click on Save.
3. To edit a card, click on Load to retrieve the card information. After making changes, click on Save.
4. To create a card, click on New.
5. To remove a current definition of a card, click on Delete.

Adding and Removing ISA Cards

Adding and removing cards through the RCA provides a way for the RCA to run its conflict detection algorithms on the resources requested by the cards. This alerts you to any possible problems with that particular card in the current configuration.

- **To add an ISA card:**
 1. Click on Add ISA Card in the RCA window.
 2. Specify the directory for the .CFG file.
 3. Select the file and click on Ok.
- **To remove an ISA card:**
 1. Select a valid ISA card in the Devices section of the RCA window.
 2. Click on Remove ISA Card.

Modifying Resources

Modifying the resources of a device may be necessary to accommodate certain operating systems, applications, and drivers. It may also be necessary to modify resources to resolve a conflict.

- **To modify the resources associated with a device:**
 1. Highlight the device in the Devices section of the RCA window.
 2. Press the spacebar or <Enter>, or double click on the entry.
This displays the functions of the selected device along with possible choices and the resources associated with those choices.
- **To make a modification:**
 1. Highlight the function in the Configuration window.
 2. Press the spacebar or <Enter>, or double click on the entry (this updates the Choice and resource lists).
 3. Press the tab key to get to the Choice list, and press <Enter>.
 4. Use the arrow keys to select a proper choice, and press <Enter> again.
 5. If the choice allows multiple possible values for a particular resource, use the hot key to select a resource, and press the spacebar or double click on the resource.
 6. Select the desired resource, and click on Ok.

System Resource Usage

Clicking on the Resource Use button in the Configuration window displays the System Resource Usage window. This window shows what resources each device is consuming. This information is useful for choosing resources if a conflict occurs. Devices can be organized according to the resources you want to examine using the options in the Resource section of the screen. The resource information can also be written to a plain text file through this window.

Multiboot Options Add-in

Under this window you can change the boot priority of a device.

1. Select a device.
2. Press the + button to move it up in the list. Press the - button to move it down.

Security Add-in

Under this window, you can set the User and Administrator passwords, and security options.

To Set the User Password

1. Click on the user password button.
2. Enter the password in the first field.
3. Confirm the password by entering it again in the second field.

To Change or Clear the User Password

1. Click on the User password button.
2. Enter the old password in the first field.
3. Enter the new password in the second field (or leave blank to clear).
4. Confirm the password by entering it again in the second field (or leave blank to clear).

To Set the Administrator Password

1. Click on the Administrator password button.
2. Enter the password in the first field.
3. Confirm the password by entering it again in the second field.

To Change or Clear the Administrator Password

1. Click on the Administrator password button.
2. Enter the old password in the first field.
3. Enter the new password in the second field (or leave blank to clear).
4. Confirm the password by entering it again in the second field (or leave blank to clear).

Security Options

Under this window, you can set the other security options:

- **Hot Key** - Set a key sequence that, when pressed, will drop the server into secure mode.
- **Lock-Out Timer** - Set an interval that, if no activity takes place during it, will drop the server into secure mode.
- **Secure Boot Mode** - Force the server to boot directly into secure mode.
- **Video Blanking** - Turn off the video when the server is in secure mode.
- **Floppy Write** - Control access to the diskette drive while the server is in secure mode.
- **Reset/Power Switch Locking** - Control the power and reset buttons while the server is in secure mode.

SEL Manager Add-in

Clicking on the SEL Manager Add-in task brings up the Server Event Log (SEL) viewer. You can load and view the current SEL data stored in the BMC, save the currently loaded SEL data to a file, view previously saved SEL data, or clear the SEL. The SEL Viewer has the following menus:

File

The File menu has the following options:

- **Load SEL...** View data from a previously saved SEL file.
- **Save SEL...** Save the currently loaded SEL data to a file.
- **Clear SEL** Clears the SEL data from the BMC.
- **Exit** Quits the SEL Viewer.

View

The View menu has the following options:

- **SEL Info** Displays information about the SEL. These fields are display only.
- **All Events** Displays the current SEL data from the BMC.
- **By Sensor** Brings up a pop-up menu that allows you to view only the data from a certain sensor type.
- **By Event** Brings up a pop-up menu that allows you to view only the data from a certain event type.

Settings

The Settings menu has the following options:

- **Display HEX/Verbose** Toggles between the Hex/interpreted mode of displaying the SEL records.
- **Output Text/Binary** Determines whether SEL data will be saved to the file (as under File - Save) in binary format or verbose format.

Help

The Help menu has the following option:

- **About** Displays the SEL Viewer version information.

FRU Manager Add-in

Clicking on the FRU Manager Add-in task brings up the Field Replaceable Unit (FRU) viewer. You can load and view the current FRU data stored in the BMC, save the currently loaded FRU data to a file, view previously saved FRU data. The FRU Viewer has the following menus:

File

The File menu has the following options:

- **Load...** View data from a previously saved FRU file.
- **Save...** Saves the currently loaded FRU data to a file.
- **Save As...** Saves the currently loaded FRU data to a file.
- **Exit** Quits the FRU Viewer.

View

The View menu has the following options:

- **FRU Info** Displays information about the FRU. These fields are display only.
- **All FRU Areas** Displays the current FRU data from the BMC.
- **By Device Type** Brings up a pop-up menu that allows you to view only the data from a certain device type.

Settings

The Settings menu has the following options:

- **Display HEX/Verbose** Toggles between the Hex/interpreted mode of displaying the FRU records.
- **Output Text/Binary** Determines whether FRU data will be saved to the file (as under File - Save) in binary format or verbose format.

Help

The Help menu has the following option:

- **About** Displays the FRU Viewer version information.

SDR Manager Add-in

Clicking on the SDR Manager Add-in task brings up the Sensor Data Record (SDR) viewer. You can load and view the current SDR data stored in the BMC, save the currently loaded SDR data to a file, view previously saved SDR data. The SDR Viewer has the following menus:

File

The File menu has the following options:

- **Load...** View data from a previously saved SDR file.
- **Save...** Saves the currently loaded SDR data to a file.
- **Save As...** Saves the currently loaded SDR data to a file.
- **Exit** Quits the SDR Viewer.

View

The View menu has the following options:

- **SDR Info** Displays information about the SDR. These fields are display only.
- **All Records** Displays the current SDR data from the BMC.
- **By Record Type** Brings up a pop-up menu that allows you to view only the data from a certain record type.

Settings

The Settings menu has the following options:

- **Display HEX/Verbose** Toggles between the Hex/interpreted mode of displaying the SDR records.
- **Output Text/Binary** Determines whether SDR data will be saved to the file (as under File - Save) in binary format or verbose format.

Help

The Help menu has the following option:

- **About** Displays the SDR Viewer version information.

Exiting the SSU

Exiting the SSU causes all windows to close.

1. Exit the SSU by opening the menu bar item File in the SSU Main window.
2. Click on Exit.
or
Highlight Exit, and press <Enter>.

Platform Event Paging

With Platform Event Paging (PEP), your server can be configured to automatically dial up a paging service and page you when a server management related event occurs. Platform events include temperature out-of-range, voltage out-of-range, chassis intrusion, and fan failure.

If PEP is enabled and the BMC receives or detects a new event, it automatically sends a page. It can send a page if the processors are down or if the system software is unavailable.

PEP needs an external modem connected to the server's EMP (Emergency Management Port) serial connection. This is typically the COM2 serial connector.

Verify in BIOS Setup of your server board whether or not your system BIOS includes PEP. If not you can download it from the Intel Customer Support website when it becomes available.

<http://support.intel.com/support/motherboards/server/1440gx>

Using Platform Event Paging

1. Enter Setup.
2. Enter the PEP Management submenu from the Server Menu.
3. Set the PEP Enable field to Enable.
4. Enter your page string in the PEP Page String field. This consists of the attention command for you modem (generally ATDT), the number of your paging service, several commas (each comma is a 1 second pause), the number/message you wish to appear on your pager, and the hangup command for your modem (generally ATH). You will need to experiment with the timing to ensure you are paged properly. Set the Send Test Page field to Send Test Page Now to generate a test page.
5. If you wish to filter events so that only certain events will originate a page, enter the PEP Filter submenu.
 - a. Set the PEF Enable field to Enable.
 - b. Enable all of the events about which you want to be paged.
 - c. Escape out of the PEP Filter submenu.
6. Set the time between pages with the Page Blackout Field. If you want to be paged every five minutes, set it to 5. The range is from 0 to 10 minutes.
7. Exit BIOS Setup.

Emergency Management Port Console

The Emergency Management Port (EMP) Console is a software application designed to run on a Windows 95 or Windows NT 4.0 workstation and provides a server administrator's interface to the Emergency Management Port (EMP) of the L440GX+ server. This interface allows remote server management via a modem or direct connection.

The server control operations available with EMP Console are:

- Connecting to remote servers
- Powering the server on or off
- Resetting the server

The EMP Console uses three management plug-ins to monitor the server:

- SEL Viewer
- SDR Viewer
- FRU Viewer

The EMP Console also has Phonebook plug-in that can be used to create and maintain a list of servers and their phone numbers.

The EMP Console software utility is on the L440GX+ resource CD that ships with the product. It can be installed directly from the CD onto a workstation or from diskettes that can be created by booting to the ROM-DOS operating system, also on the CD, and selecting Create Diskettes.

How EMP Console Works

The EMP shares use of the COM2 port with the system on the server. When the EMP has control of the port, the port operates in command mode. When the system has control, the port operates in console redirect mode. When connecting to a server, the EMP Console checks to determine the mode of the COM2 port. The following discussion covers how EMP Console functions in each mode:

- *Command mode* is the default COM2 state. In this state, EMP Console communicates with the server's firmware, allowing the client to remotely reset or power the server up or down. The client can also view the server's System Event Log (SEL), Field Replaceable Unit (FRU) information, or Sensor Data Record (SDR) table.
- In *console redirect mode*, EMP Console serves as a PC ANSI terminal window for BIOS console redirection. Commands typed in this terminal window are transmitted through BIOS to the server's console, and text displayed on the server console is displayed on the EMP Console's terminal window. In this mode, you can remotely view boot messages, access BIOS setup, and run DOS text mode applications through the EMP Console's terminal window.

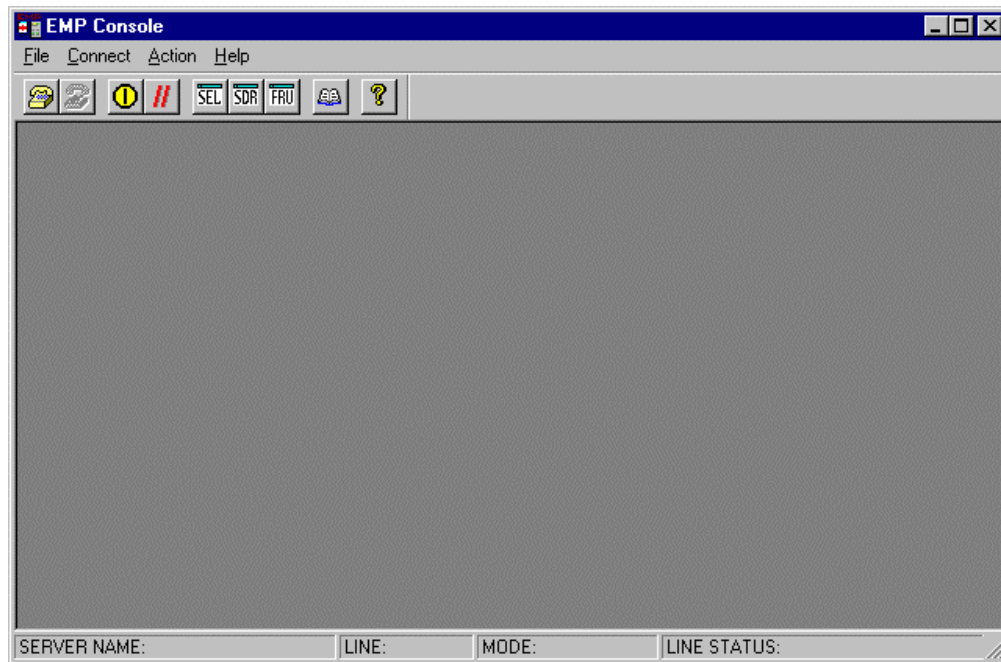

Figure 9. EMP Console in Command State

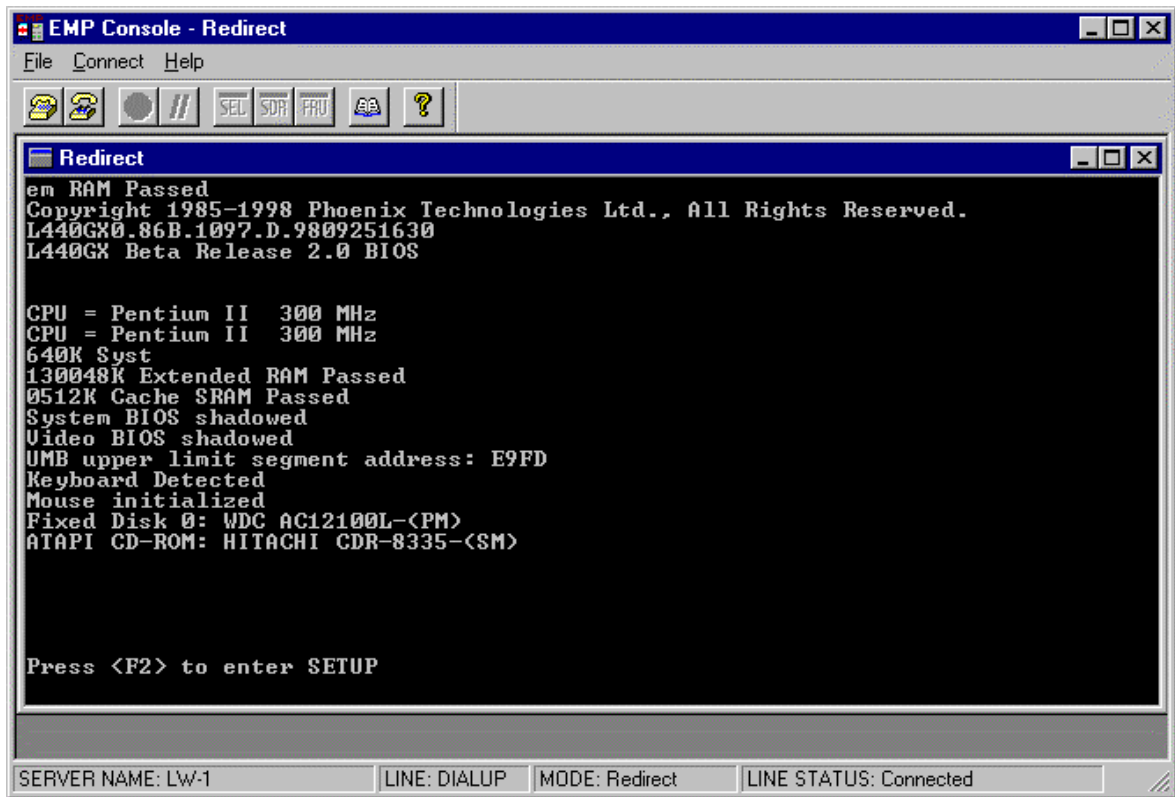

Figure 10. EMP Console in Redirect State

Figure 10 shows EMP Console window in redirect mode with the terminal window. The text that appears on the server monitor displays in the Redirect window.

Availability of the various EMP Console features are determined by two factors: the BIOS EMP access mode and if the server's COM2 port is configured for console redirection. The three EMP access modes are disabled, pre-boot, and always active.

Table 6. EMP Console Access Modes (Server configured for console redirection)

Mode	Server is powered off	During BIOS POST	After OS boots
Disabled	Redirect window appears, but is blank	Redirect window	Redirect window
Pre-boot	EMP commands available	Redirect window*	Redirect window
Always Active	EMP commands available	Redirect window*	EMP commands available

* The operation mode can be modified by selections in the Reset and Power on/off dialogs. These are server control dialogs available in EMP Console.

Table 7. EMP Console Access Modes (Server not configured for console redirection)

Mode	Server is powered off	During BIOS POST	After OS boots
Disabled	Redirect window appears, but is blank	Redirect window appears, but is blank	Redirect window appears, but is blank
Pre-boot	EMP commands available	EMP commands available	Redirect window appears, but is blank
Always Active	EMP commands available	EMP commands available	EMP commands available

Requirements

This section outlines the requirements and configurations necessary for using EMP Console.

Operating Systems:

- Windows 95 or Windows 98
 - 16 MB of RAM, 32 MB recommended
 - 20 MB disk space
- Windows NT
 - Windows NT 4.0
 - 24 MB of RAM, 32 MB recommended
 - 20 MB disk space

Client Configuration: EMP Console supports all COM ports on the client system, along with any Windows NT/95 compatible modem.

Server Configuration: EMP Console requires the server's COM2 port to be connected to an external modem or directly connected to a serial cable.

Direct Connect Configuration: A null modem serial cable is needed. Connect one end of the cable to the COM2 port of server and the other to a port on the client machine.

Modem Configuration: On the client, EMP Console uses the Windows Application Program Interface (API) to determine if a modem is connected and available. The EMP Console does not configure the modem; it should be preconfigured through Windows.

For modem support, the server must use a Hayes compatible modem that supports a baud rate of 19.2k. The modem must be on the Windows 95 or NT Hardware Compatibility List provided by Microsoft. The server modem must be set in auto-answer mode for EMP Console to be able to connect to it.

Setting up the Server for the EMP

To use the EMP, you must configure the server's BIOS with specific settings. These settings are found in two submenus of the BIOS Server menu, the System Management Submenu and the Console Redirection submenu. The BIOS settings section, found earlier in this document, shows all the available options. This section focuses on the settings that must be configured in order to use the EMP.

System Management Submenu

All EMP related settings occur in the Server main menu. Change only the items below; all other default settings should remain the same.

EMP Password Switch & EMP Password: Anytime an attempt to initiate a connection is made, a prompt for the user password appears. If no EMP password is setup, then anyone can access the EMP by clicking OK.

In the EMP Password area of the Server menu, the EMP Password Switch option must be set to enable. Then type in a password of up to eight alphanumeric characters. If a beep is heard, the password was accepted.

EMP Access Modes: Choose either Disabled, Pre-boot, or Always Active, depending on the type of EMP access needed. The tables above show what is available with a given setting.

EMP Restricted Mode Access: Set Restricted Mode to either enabled or disabled as needed. If in enabled mode, this means that EMP Console's server control options, Power off and Reset, are unavailable, except power on. In disabled mode, these same server control options are available.

EMP Direct Connect/Modem Mode: Select Direct Connect if a null modem serial cable directly connects the server's COM2 port to the EMP Console client machine. If they are connected via a modem, select Modem Mode.

Console Redirection Submenu

The settings in the Console Redirection Submenu of the Server menu must be set exactly as noted to be able to use the EMP.

COM Port Address: Select 2F8. This is the COM2 port that must be used by the EMP. The IRQ# setting is automatically populated with the correct number based on the COM Port Address choice.

Baud Rate: Select 19.2k.









Flow Control: Choose CTS/RTS + CD.

Main EMP Console Window

The main EMP Console window provides a graphical user interface (GUI) to access server control operations and to launch the management plug-ins. At the top of the window is the menu and tool bar. These provide the options to initiate plug-ins and other support features. A status bar at the bottom displays connection information such as server name, line status, and mode.

Toolbar

The tool bar buttons of the EMP Console main window combine server control and management plug-in commands available from both the Connect and Action menus as follows:

	Displays the Connect dialog to allow connection to a selected server.
	Disconnects from the currently connected server.
	Displays the Power On/Off dialog.
	Displays the Reset dialog.
	Launches the SEL Viewer.
	Launches the SDR Viewer.
	Launches the FRU Viewer.
	Displays the Phonebook Dialog.
	Displays the online help.

Status Bar

The status bar is displayed at the bottom of the main window. It contains the following status information:

- **SERVER NAME:** The name of the connected server when connecting via modem.
- **LINE:** The type of line connection. This is either direct or modem.
- **MODE:** Either Redirect of EMP, depending on whether the EMP has control of the COM2 port.
- **LINE STATUS:** Gives status information about the server connection. For example, if a server is connected, the status bar says "Connected." Otherwise, the line is blank.

EMP Console Main Menu

- **File**
 - **Exit** - exits EMP Console.
- **Connect**
 - **Disconnect** - disconnects the server connection.
 - **[Re]Connect** - displays the connect dialog.
 - A list of the five most recent modem connections. Click on one of these server names to initiate a connection.
- **Action**
 - **Power On/Off** - displays the Power on/off dialog.
 - **Reset** - displays the Reset dialog.
 - **SEL Viewer** - displays the SEL Viewer.
 - **SDR Viewer** - displays the SDR Viewer.
 - **FRU Viewer** - displays the FRU Viewer.
 - **Phonebook** - displays the Phonebook dialog.
- **Help**
 - **Help Topics** - help topics for EMP Console.
 - **Help About** - provides version information.

Server Control Operations

Three server control operations are available from the menu or toolbar in EMP Console: remote server connection, powering the server on and off, and resetting the server. The server console mode can also be switched between EMP active and BIOS redirect modes through post-power-up and reset options.

Connect

When [Re]Connect is selected from the Connect menu, the Connect dialog in Figure 11 is displayed. This dialog allows you to connect to a server. If the client machine is already connected to a server, initiating connection generates a warning message. The message indicates that the existing connection will be terminated if you continue trying to initiate the new connection. You are prompted to enter the EMP password whenever a connection is attempted.

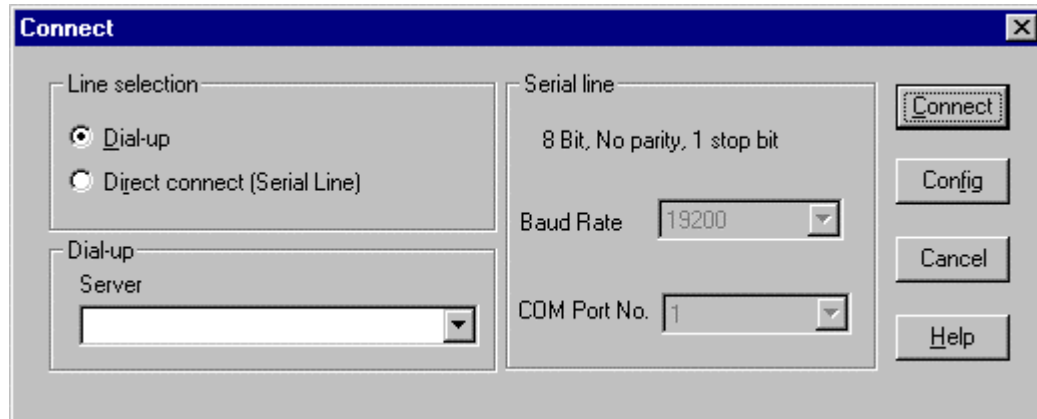

Figure 11. Connect Dialog

Options available in the dialog are:

- **Line Selection** - you can specify whether to use a direct connection or dial-up modem connection to the server.
 - **Dial-up** - connects to a selected server with a modem.
 - **Direct connect (Serial Line)** - connects to the selected server directly using a null modem serial cable.
- **Server** - a server name can be selected from the dropdown list of available servers. A server must be selected when the line selection is Dial-up.
- **Serial Line** - These options are enabled when the line selection is set to Direct connect (Serial Line).
 - **Baud Rate** - must be 19200 for EMP to connect properly.
 - **COM Port No.** - set the COM Port number to the port which the null modem serial cable is connected to.
- **Connect** - initiates the connection to the connected server. When this button is clicked, you are prompted for the EMP password.
- **Config** - displays the Phonebook dialog.
- **Cancel** - exits the Connect dialog without taking any action.
- **Help** - displays the help information for this dialog.

Power On/Off

Selecting Power On/Off from the Action menu displays the Power on/off dialog. This dialog provides commands to remotely power on or power off the server.

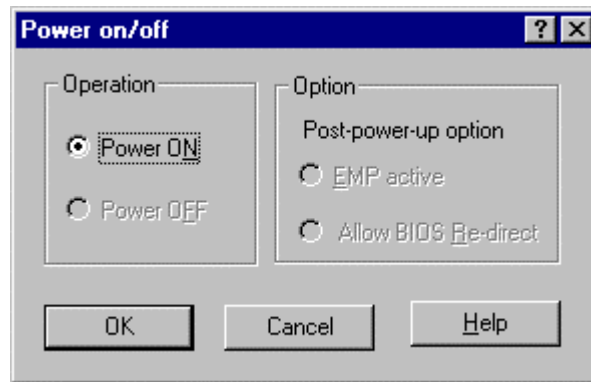

Figure 12. Power On/Off Dialog

Options available in the dialog are:

- **Power ON** - powers on the server.
- **Power OFF** - powers off the server. This option is not allowed if the server is configured in RESTRICTED mode for EMP operations.
- **Post-power-up option** - sets the mode selection of the server to EMP active or BIOS redirection. The setting is available after the next power-up. The default selection is EMP active.
- **Cancel** - exits the Connect dialog without taking any action.
- **Help** - displays the help information for this dialog.

Reset

Selecting Reset from the Action menu displays the Reset dialog. This dialog provides the ability to remotely reset the server with post-reset options.

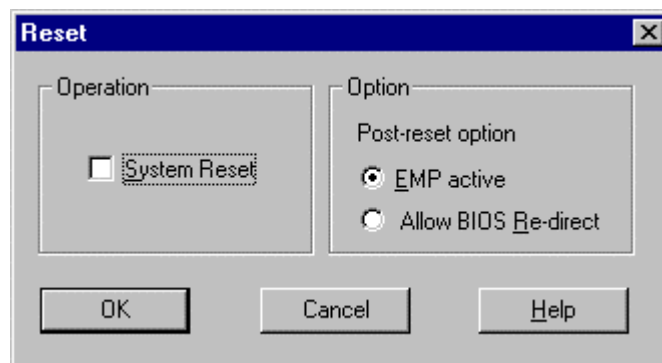

Figure 13. Reset Dialog

Options available in the dialog are:

- **System Reset** - resets the server with the selected post-reset options. This operation is not allowed if the server is configured in RESTRICTED mode for EMP operations.
- **Post-reset option** - sets the post-reset option that will be in effect after reset. The options are EMP active or BIOS redirection. The default selection is EMP active.
- **Cancel** - exits the Connect dialog without taking any action.
- **Help** - displays the help information for this dialog.

Phonebook

EMP Console provides a support plug-in known as the Phonebook. The Phonebook stores names and numbers of servers in a list that can be updated by adding, modifying or deleting entries. The Phonebook can be opened from the main menu and toolbar, or launched from the Connect dialog by clicking the Config button.

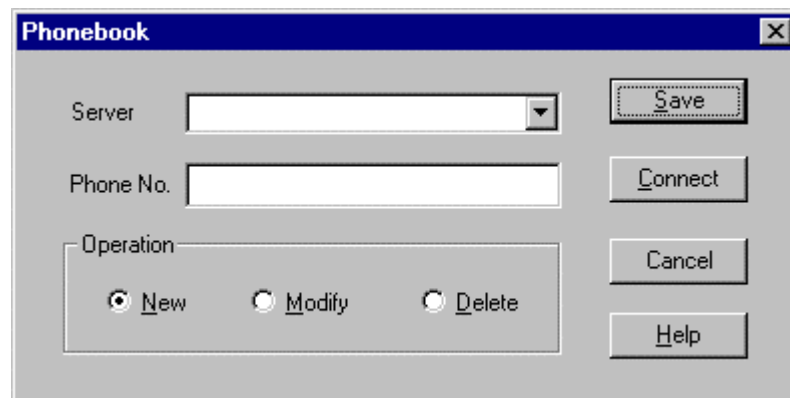

Figure 14. Phonebook Dialog

Options available in the dialog are:

- **Server** - a dropdown list of server names stored in the Phonebook. If the New radio button is selected in the Operation area, this area is cleared.
- **Phone No.** - the number of the selected server. If the New radio button is selected in the Operation area, this area is cleared.
- **Operation**
 - **New** - lets you add a new entry in the Phonebook. Selecting this option clears the Server and Phone No. fields. You must click Save for the entry to be added to the Phonebook.
 - **Modify** - lets you edit an existing entry. You must select an existing entry from the Server dropdown list box and modify the existing phone number before selecting this option. Click Save in order to update the entry in the phonebook.
 - **Delete** - lets you delete an entry from the Phonebook. You must first select an existing server from the Server dropdown list box before selecting this option. You must click Save for the entry to be deleted.
- **Save** - saves a new or modified Phonebook entry, or deletes an entry if the Delete radio button is selected.

- **Connect** - displays the Connect dialog with the server from the Phonebook's Server dropdown list box already populating the Connect dialog's Server field.
- **Cancel** - exits the Connect dialog without taking any action.
- **Help** - displays the help information for this dialog.

Management Plug-ins

SEL Viewer

The SEL Viewer provides access to the System Event Log on the server and can display records in either hexadecimal or text (verbose) form. Options available through the SEL Viewer are:

- View the SEL from a saved file
- Save the SEL to a file
- View SEL summary info
- View all SEL entries
- View SEL entries by sensor type
- View SEL entries by event type
- Set SEL display mode to either Hex or verbose mode
- Set the SEL output file format to either text or binary format
- Close the SEL Viewer
- Exit the EMP Console

SEL Viewer Menu Options

The following menu options are found on the SEL Viewer menu bar:

- **File**
 - **Open** - views SEL data from a previously saved file if it was stored in binary format. Selecting the Open menu item allows you to specify a filename under which the data is found. If the file cannot be opened, the program displays an error message.
 - **Close** - closes the SEL Viewer.
 - **Save** - saves the SEL events to a file in either binary raw or verbose text format. The binary file may be retrieved later. Once data has been saved to a file, selecting this option will save the data to the previously saved file. If no SEL events have been retrieved, then this menu option is not available.
 - **Save As** - saves the SEL events to a new file in either binary raw or verbose text format. The binary file may be retrieved later. Selecting this option lets you specify a filename to which the data will be saved. If no SEL events have been retrieved, then this menu option is not available.
 - **Exit** - exits the EMP Console.
- **View**
 - **SEL Information** - displays SEL summary information as returned by the server.
 - **All Events** - displays all events in the SEL.
 - **By Sensor Type** - displays all events in the SEL generated by a specific sensor type such as voltage, temperature, etc. A submenu lets you select the sensor type to be displayed.

- **By Event** - displays all the events in the SEL of a particular event type; for example, threshold, digital, or discrete. A pop-up menu lets you select the event type to be displayed.
- **Settings** - changes several operating parameters for the SEL Viewer. This menu displays the following suboptions:
 - **Display HEX/Verbose** - toggles between HEX mode and interpreted mode of displaying SEL records.
 - **Output Text/Binary** - toggles between whether the SEL events will be saved to the file in binary format or verbose format.
- **Window** - gives options for displaying currently open windows.
- **Help**
 - **Help Topics** - help topics for EMP Console.
 - **Help About** - provides version information.

SDR Viewer

The SDR Viewer lets you view the Sensor Data Records from the SDR repository. Options available through the SDR Viewer are:

- View all SDR records
- View SDR entries by SDR type
- View SDR summary info
- Set SDR display mode to either HEX or verbose mode
- Close the SDR Viewer
- Exit the EMP Console

SDR Viewer Menu Options

The following menu options are found on the SDR Viewer menu bar:

- **File**
 - **Close** - closes the SDR Viewer.
 - **Exit** - exits the EMP Console.
- **View**
 - **Display all Records** - displays all records from the SDR repository.
 - **SDR Type** - displays the records of a particular SDR type. Select an SDR type from a pop-up menu that displays all the SDR types available for the given hardware.
 - **SDR Information** - displays the SDR summary information as returned by the server.
- **Settings** - changes the operating parameters for the SDR Viewer. This menu displays the following suboption:
 - **Display HEX/Verbose** - toggles between HEX mode and interpreted mode of displaying SDR records.
- **Window** - gives options for displaying currently open windows.
- **Help**
 - **Help Topics** - help topics for EMP Console.
 - **Help About** - provides version information.

FRU Viewer

The FRU Viewer allows you to view the server's FRU (Field Replaceable Unit) data from the server's Front Panel FRU information area. The options available in the FRU Viewer are:

- View all FRU records
- View FRU summary info
- Set FRU display mode to either Hex or verbose mode
- Close the FRU Viewer
- Exit EMP Console

FRU Viewer Menu Options

The following menu options are found on the FRU Viewer menu bar:

- **File**
 - **Close** - closes the FRU Viewer.
 - **Exit** - exits EMP Console.
- **View**
 - **Display all Records** - displays all FRU data, which consists of chassis, board, and product information.
 - **FRU Information** - displays the FRU summary information as returned by the server.
- **Settings** - changes operating parameters for the FRU Viewer. This menu displays the following options:
 - **Display HEX/Verbose** - toggles between HEX mode and interpreted mode of displaying FRU records.
- **Window** - gives options for displaying currently open windows.
- **Help**
 - **Help Topics** - help topics for EMP Console.
 - **Help About** - provides version information.

FRUSDR Load Utility

The Field Replacement Unit (FRU) and Sensor Data Record (SDR) Load Utility is a DOS-based program used to update the server management subsystem's product level FRU, SDR, and the Desktop Management Interface (DMI) nonvolatile storage components (EEPROMs). The load utility

- discovers the product configuration based on instructions in a master configuration file
- displays the FRU information
- updates the nonvolatile storage device (EEPROM) associated with the Baseboard Management Controller (BMC) that holds the SDR and FRU area
- updates the DMI area located in the BIOS nonvolatile storage device
- generically handles FRU devices that may not be associated with the BMC

When to Run the FRUSDR Load Utility

You should run the FRUSDR Load Utility each time you upgrade or replace the hardware in your server, excluding add-in boards, hard drives, and RAM. For example, if you replace an array of fans, you need to run the utility. It programs the sensors that need to be monitored for server management.

Because the firmware must reload to properly initialize the sensors after programming, turn the server off and remove the AC power cords from the server. Wait approximately 30 seconds, and reconnect the power cords.

What You Need to Do

The FRUSDR Load Utility may be run directly from the Configuration Software CD or from a diskette you create from the CD. It can be extracted from the CD by booting to the CD and selecting "Make Diskettes" or by inserting the CD into a PC running Windows 95 or NT and selecting the "Utilities" section.

NOTE

If your diskette drive is disabled, or improperly configured, you must use BIOS Setup to enable it. If necessary, you can disable the drive after you are done with the FRUSDR utility.

How You Use the FRUSDR Load Utility

This utility is compatible with ROM-DOS Ver. 6.22, MS-DOS[†] Ver. 6.22, and later versions. The utility accepts CFG, SDR and FRU load files. The executable file for the utility is frusdr.exe. The utility requires the following supporting files:

- one or more .fru files describing the system's field replaceable units
- a .cfg file describing the system configuration
- a .sdr file describing the sensors in the system

Command Line Format

The basic command line format is

```
frusdr [/?] [/h] [/d {dmi, fru, sdr}] [/cfg filename.cfg] /p
```

Command	Description
frusdr	Is the name of the utility.
/? or /h	Displays usage information.
/d {dmi, fru, sdr}	Only displays requested area.
/cfg filename.cfg	Uses custom CFG file.
/p	Pause between blocks of data.

Parsing the Command Line

The FRUSDR Load Utility allows only one command line function at a time. A command line function may consist of two parameters; for example, cfg filename.cfg. Any invalid parameters result in displaying an error message and exiting the program. You can use either a slash (/) or a minus sign (-) to specify command line options. The /p flag may be used in conjunction with any of the other options.

Displaying Usage Information

When the utility is run with the /? or /h command line flags, the following message is displayed:

```
FRU & SDR Load Utility Version 3.0
Usage:  frusdr           Is the name of the utility.
        /? Or /h       Displays usage information.
        /d {dmi,fru,sdr} Only displays requested area.
        /cfg filename.cfg Uses custom CFG file.
        /p             Pause between blocks of data.
```

Displaying a Given Area

When the utility is run with the /d DMI, /d FRU, or /d SDR command line flag, the indicated area is displayed. Each area represents a sensor; one sensor for each instrumented device in the server. If the given display function fails because of an inability to parse the data present or a hardware failure, the utility displays an error message and exits.

Displaying DMI Area

The DMI area is displayed in ASCII format when the field is ASCII or as a number when the field is a number. Each DMI area displayed is headed with the DMI area designated name. Each field has a field name header followed by the field in ASCII or as a number.

Displaying FRU Area

The FRU area is displayed in ASCII format when the field is ASCII or as a number when the field is a number. Each FRU area displayed is headed with the FRU area designated name. Each field has a field name header followed by the field in ASCII or as a number. The Board, Chassis, and Product FRU areas end with an END OF FIELDS CODE that indicates there is no more data in this area. The Internal Use area is displayed in hex format, 16 bytes per line.

Displaying SDR Area

The SDR nonvolatile storage area is displayed in the following hex format. The data is separated by a Sensor Record Number X header, where X is the number of that sensor record in the SDR area. The next line after the header is the sensor record data in hex format delineated by spaces. Each line holds up to 16 bytes. The data on each line is followed by the same data in ASCII format; nonprintable characters are substituted by a period (.).

Using Specified CFG File

The utility can be run with the command line parameter of `-cfg filename.cfg`. The filename can be any DOS accepted, eight-character filename string. The utility loads the specified CFG file and uses the entries in the configuration file to probe the hardware and to select the proper SDRs to load into nonvolatile storage.

Displaying Utility Title and Version

The utility displays its title :

```
FRU & SDR Load Utility, Version 3.0
```

Where X.XX is the revision number for the utility.

Configuration File

The configuration file is in ASCII text. The utility executes commands formed by the strings present in the configuration file. These commands cause the utility to perform various tasks needed to ultimately load the proper SDRs into the nonvolatile storage of the BMC and possibly generic FRU devices. Some of the commands may be interactive and require you to make a choice.

Prompting for Product Level FRU Information

Through the use of a Configuration File, the utility may prompt you for FRU information.

Filtering Sensor Data Record From the SDR File

The MASTER.SDR file has all the possible SDRs for the system. These records may need to be filtered based on the current product configuration. The configuration file directs the filtering of the SDRs.

Updating the SDR Nonvolatile Storage Area

After the utility validates the header area of the supplied SDR file, it updates the SDR repository area. Before programming, the utility clears the SDR repository area. The SDR file is loaded via the .cfg File. Then the utility filters all tagged SDRs depending on the product configuration set in the Configuration File. Nontagged SDRs are automatically programmed. The utility also copies all written SDRs to the SDR.TMP file. It contains an image of what was loaded, and the TMP file is also useful for debugging the server.

Updating FRU Nonvolatile Storage Area

After the configuration is determined, the utility updates the FRU nonvolatile storage area. First it verifies the Common Header area and checksum from the specified FRU file. The Internal Use Area is read out of the specified .FRU file and is programmed into the nonvolatile storage. The Chassis, Board, Product and MultiRecord areas are read out of the specified .FRU file, if they exist, then those areas are programmed into the FRU nonvolatile storage. All the areas are also written to the FRU.TMP file, which is useful for debugging the server.

Updating DMI FRU Nonvolatile Storage Area

After programming the BMC FRU area, the utility then programs the following Chassis, Board, and Product FRU information to the DMI fields, but only when dictated by the Configuration File.

If a failure occurs, the utility displays an error message and exits.

Cleaning Up and Exiting

If an update was successfully performed, the utility displays an appropriate message and then exits with a DOS exit code of zero.

If the utility fails, it immediately exits with an error message and a non-zero DOS exit code.

Upgrading the BIOS

Preparing for the Upgrade

Before you upgrade the BIOS, prepare for the upgrade by recording the current BIOS settings, obtaining the upgrade utility, and making a copy of the current BIOS.

Recording the Current BIOS Settings

1. Boot the computer and press <F2> when you see the message:
Press <F2> Key if you want to run SETUP
2. Write down the current settings in the BIOS Setup program.

NOTE

Do not skip step 2. You will need these settings to configure your computer at the end of the procedure.

Obtaining the Upgrade Utility

You can upgrade to a new version of the BIOS using the new BIOS files and the BIOS upgrade utility, iFLASH.EXE. You can obtain the BIOS upgrade file and the iFLASH.EXE utility through your computer supplier or from the Intel Customer Support website:

<http://support.intel.com/support/motherboards/server/l440gx>

NOTE

Please review the instructions distributed with the upgrade utility before attempting a BIOS upgrade.

This upgrade utility allows you to:

- Upgrade the BIOS in flash memory.
- Update the language section of the BIOS.

The following steps explain how to upgrade the BIOS.

Creating a Bootable Floppy Diskette

1. Use a DOS or Windows 95 system to create the floppy disk.
2. Insert a floppy disk in floppy drive A.
3. At the C:\ prompt, for an unformatted floppy disk, type:
`format a: /s`
or, for a formatted floppy disk, type:
`sys a:`
4. Press <Enter>

Creating the BIOS Upgrade Floppy Diskette

The BIOS upgrade file is a compressed self-extracting archive that contains the files you need to upgrade the BIOS.

1. Copy the BIOS upgrade file to a temporary directory on your hard disk.
2. From the C:\ prompt, change to the temporary directory.
3. To extract the file, type the name of the BIOS upgrade file, for example:
10006BI1.EXE
4. Press <Enter>. The extracted file contains the following files:
LICENSE.TXT
README.TXT
BIOS.EXE
5. Read the LICENSE.TXT file, which contains the software license agreement and the README.TXT file, which contains the instructions for the BIOS upgrade.
6. Insert the bootable floppy disk into drive A.
7. To extract the BIOS.EXE file to the floppy disk, change to the temporary directory that holds the BIOS.EXE file and type:
BIOS A:
8. Press <Enter>.
9. The floppy disk now holds the BIOS upgrade and recovery files.

Upgrading the BIOS

1. Boot the computer with the floppy disk in drive A. The BIOS upgrade utility screen appears.
2. Select Update Flash Memory From a File.
3. Select Update System BIOS. Press <Enter>.
4. Use the arrow keys to select the correct .bio file. Press <Enter>.
5. When the utility asks for confirmation that you want to flash the new BIOS into memory, select Continue with Programming. Press <Enter>.
6. When the utility displays the message upgrade is complete, remove the floppy disk. Press <Enter>.
7. As the computer boots, check the BIOS identifier (version number) to make sure the upgrade was successful.
8. To enter the Setup program, press <F2> when you see the message:
Press <F2> Key if you want to run SETUP
9. For proper operation, load the Setup program defaults. To load the defaults, press <F9>.
10. To accept the defaults, press <Enter>.
11. Set the options in the Setup program to the settings you wrote down before the BIOS upgrade.
12. To save the settings, press <F10>.
13. To accept the settings, press <Enter>.
14. Turn off the computer and reboot.

Recovering the BIOS

It is unlikely that anything will interrupt the BIOS upgrade; however, if an interruption occurs, the BIOS could be damaged. The following steps explain how to recover the BIOS if an upgrade fails. The following procedure use recovery mode for the Setup program.

⇒ NOTE

Because of the small amount of code available in the nonerasable boot block area, there is no video support. You will not see anything on the screen during the procedure. Monitor the procedure by listening to the speaker and looking at the floppy drive LED.

1. Turn off all peripheral devices connected to the computer. Turn off the computer.
2. Remove the computer cover.
3. Locate jumper block J3J2.
4. Move the Recovery Boot jumper from pins 9-10 to pins 10-11 (see Figure 17 on page 99).
5. Insert the bootable BIOS upgrade floppy disk into floppy drive A.
6. Replace the cover, turn on the computer, and allow it to boot. The recovery process will take a few minutes.
7. Listen to the speaker.
8. Two beeps and the end of activity in drive A indicate successful BIOS recovery.
9. A series of continuous beeps indicates failed BIOS recovery.
10. If recovery fails, return to step 1 and repeat the recovery process.
11. If recovery is successful, turn off the computer. Remove the computer cover and continue with the following steps.
12. Move the Recovery Boot jumper back to pins 9-10.
13. Replace the computer cover. Leave the upgrade disk in drive A and turn on the computer.
14. Continue with the BIOS upgrade (see page 80).

Changing the BIOS Language

You can use the BIOS upgrade utility to change the language the BIOS uses for messages and the Setup program. Use a bootable floppy disk containing the Intel flash utility and language files.

1. Boot the computer with the bootable floppy disk in drive A. The BIOS upgrade utility screen appears.
2. Select `Update Flash Memory From a File`.
3. Select `Update Language Set`. Press `<Enter>`.
4. Select drive A and use the arrow keys to select the correct `.lng` file. Press `<Enter>`.
5. When the utility asks for confirmation that you want to flash the new language into memory, select `Continue with Programming`. Press `<Enter>`.
6. When the utility displays the message `upgrade is complete`, remove the floppy disk. Press `<Enter>`.
7. The computer will reboot and the changes will take effect.

Using the Firmware Update Utility

The Firmware Update Utility is a DOS-based program used to update the Baseboard Management Controller's firmware code. You only need to run the Firmware Update Utility if new firmware code becomes necessary.

Running the Firmware Update Utility

1. Create a DOS bootable diskette. The version of DOS must be 6.0 or higher.
2. Place the firmware update utility (FWUPDATE.EXE) and the *.hex file on the diskette. Make a note of the *.hex file name, you will need it later.
3. Insert the diskette into the drive and boot to it.
4. At the DOS prompt, run the executable file (FWUPDATE.EXE).
5. The utility will display a menu screen. Select "Upload Flash."
6. The utility will ask for a file name. Enter the name of the *.hex file.
7. The program will load the file and then ask if it should "Upload Boot Block." Press "N" to continue.
8. The program will next ask if it should "Upload Operational Code." Press "Y" to continue.
9. Once the operational code has been updated and verified, press any key to continue. Then press the "ESC" key to exit the program.
10. Shut the system down and remove any floppy disks that may be in the system.
11. Disconnect the AC power cord from the system and wait 60 seconds.
12. Connect the AC power cord and power up the system.

Installing Video Drivers

After configuring the system, you need to install video drivers to take full advantage of the features of the onboard Cirrus Logic CL-GD5480 super VGA video controller.

- The L440GX+ Resource CD includes video drivers for use with DOS and Windows NT. Check the README.TXT file on the CD for information on installing these drivers.
- For other operating systems, see your OS instructions for installing device drivers.

Using the Adaptec SCSI Utility

The Adaptec SCSI utility detects the SCSI host adapters on the server board. The utility runs out of BIOS and is used to

- Change default values
- Check and/or change SCSI device settings that may conflict with those of other devices in the server

Running the SCSI Utility

1. When this message appears on the video monitor:

Press Ctrl-A to run SCSI Utility...

2. Press <Ctrl+A> to run this utility. When it appears, choose the host adapter that you want to configure.

Another Adaptec utility that is available on the L440GX+ Resource CD is the Adaptec EZ SCSI utility. It is designed to be installed from diskettes on to a DOS or Windows operating system.

4 Solving Problems

This chapter helps you identify and solve problems that might occur while you are using the system.

Resetting the System

To do this:	Press:
Soft boot reset, which clears system memory and reloads the operating system.	<Ctrl+Alt+Del>
Clear system memory, restart POST, and reload the operating system.	Reset button
Cold boot reset. Turn the system power off and then on. This clears system memory, restarts POST, reloads the operating system, and halts power to all peripherals.	Power off/on

Fault Resilient Booting

Fault resilient booting insures the system will not stop from a boot problem. Two sets of timers are implemented in the BMC that will automatically reset the system if the system should halt for some reason.

- FRB 2 - 5 sec timer. If the primary processor does not come up in 5 seconds the system will automatically reset and switch to the secondary processor (if installed). If a second processor is not installed, the system will try to restart off the primary processor.
- FRB 3 - 7 minute timer. If the system does not make it up to the end of POST in 7 minutes, the system will automatically reset and try again. It is assumed that the processor failed regardless of what may have caused the system to hang. The primary processor is taken off line and the system will boot off the secondary (if installed otherwise it will try to restart again off of the primary). Bad memory or a bad plug in card may cause an FRB 3 failure.

All failures are logged to the system event log.

The system will remember all FRB errors and display them at the end of POST until you select the Processor Retest option from the BIOS Setup utility.

Initial System Startup

Problems that occur at initial system startup are usually caused by incorrect installation or configuration. Hardware failure is a less frequent cause.

Checklist

- Are all cables correctly connected and secured?
- Are the processors or processor termination board fully seated in their slots on the server board?
- Are all add-in ISA and PCI boards fully seated in their slots on the server board?
- Are all switch and jumper settings on the server board correct?
- Are all jumper and switch settings on add-in boards and peripheral devices correct? To check these settings, refer to the manufacturer's documentation that comes with them. If applicable, ensure that there are no conflicts—for example, two add-in boards sharing the same interrupt.
- Are all SDRAM DIMMs installed correctly?
- Are all peripheral devices installed correctly?
- If the system has a hard disk drive, is it properly formatted or configured?
- Are all device drivers properly installed?
- Are the configuration settings made with the SSU correct?
- Is the operating system properly loaded? Refer to the operating system documentation.
- Did you press the system power on/off switch on the front panel to turn the server on (power on light should be lit)?
- Is the system power cord properly connected to the system and plugged into a NEMA 5-15R outlet for 100-120 V~ or a NEMA 6-15R outlet for 200-240 V~?
- Is AC power available at the wall outlet?
- Are all integrated components from the tested components lists? Check the tested memory, and chassis lists, as well as the supported hardware and operating system list on the Intel Customer Support website:

<http://support.intel.com/support/motherboards/server/1440gx/compat.htm>

Running New Application Software

Problems that occur when you run new application software are usually related to the software. Faulty equipment is much less likely, especially if other software runs correctly.

Checklist

- Does the system meet the minimum hardware requirements for the software? See the software documentation.
- Is the software an authorized copy? If not, get one; unauthorized copies often do not work.
- If you are running the software from a diskette, is it a good copy?
- If you are running the software from a CD-ROM disk, is the disk scratched or dirty?
- If you are running the software from a hard disk drive, is the software correctly installed? Were all necessary procedures followed and files installed?
- Are the correct device drivers installed?
- Is the software correctly configured for the system?
- Are you using the software correctly?

If the problems persist, contact the software vendor's customer service representative.

After the System Has Been Running Correctly

Problems that occur after the system hardware and software have been running correctly often indicate equipment failure. Many situations that are easy to correct, however, can also cause such problems.

Checklist

- If you are running the software from a diskette, try a new copy of the software.
- If you are running the software from a CD-ROM disk, try a different disk to see if the problem occurs on all disks.
- If you are running the software from a hard disk drive, try running it from a diskette. If the software runs correctly, there may be a problem with the copy on the hard disk drive. Reinstall the software on the hard disk, and try running it again. Make sure all necessary files are installed.
- If the problems are intermittent, there may be a loose cable, dirt in the keyboard (if keyboard input is incorrect), a marginal power supply, or other random component failures.
- If you suspect that a transient voltage spike, power outage, or brownout might have occurred, reload the software and try running it again. (Symptoms of voltage spikes include a flickering video display, unexpected system reboots, and the system not responding to user commands.)

NOTE

Random errors in data files: If you are getting random errors in your data files, they may be getting corrupted by voltage spikes on your power line. If you are experiencing any of the above symptoms that might indicate voltage spikes on the power line, you may want to install a surge suppressor between the power outlet and the system power cord.

More Problem Solving Procedures

This section provides a more detailed approach to identifying a problem and locating its source.

Preparing the System for Diagnostic Testing



CAUTION

Turn off devices before disconnecting cables: Before disconnecting any peripheral cables from the system, turn off the system and any external peripheral devices. Failure to do so can cause permanent damage to the system and/or the peripheral devices.

1. Turn off the system and all external peripheral devices. Disconnect all of them from the system, except the keyboard and video monitor.
2. Make sure the system power cord is plugged into a properly grounded AC outlet.
3. Make sure your video display monitor and keyboard are correctly connected to the system. Turn on the video monitor. Set its brightness and contrast controls to at least two thirds of their maximum ranges (see the documentation supplied with your video display monitor).
4. If the operating system normally loads from the hard disk drive, make sure there is no diskette in drive A. Otherwise, place a diskette containing the operating system files in drive A.
5. Turn on the system. If the power LED does not light, see “Power Light Does Not Light” on page 89.

Monitoring POST

See Chapter 3.

Verifying Proper Operation of Key System Lights

As POST determines the system configuration, it tests for the presence of each mass storage device installed in the system. As each device is checked, its activity light should turn on briefly. Check for the following:

- Does the diskette drive activity light turn on briefly? If not, see “Diskette Drive Activity Light Does Not Light” on page 91.
- If a second diskette drive is installed, does its activity light turn on briefly? If not, see “Diskette Drive Activity Light Does Not Light” on page 91.
- If there is a hard disk drive or SCSI devices installed in the system, does the hard disk drive activity light on the control panel turn on briefly? If not, see “Hard Disk Drive Activity Light Does Not Light” on page 91.

Confirming Loading of the Operating System

Once the system boots up, the operating system prompt appears on the screen. The prompt varies according to the operating system. If the operating system prompt does not appear, see “Initial System Startup” on page 85.

Specific Problems and Corrective Actions

This section provides possible solutions for these specific problems:

- Power light does not light.
- There is no beep or an incorrect beep pattern.
- No characters appear on screen.
- Characters on the screen appear distorted or incorrect.
- System cooling fans do not rotate.
- Diskette drive activity light does not light.
- Hard disk drive activity light does not light.
- CD-ROM drive activity light does not light.
- There are problems with application software.
- The bootable CD-ROM is not detected.

Try the solutions in the order given. If you cannot correct the problem, contact your service representative or authorized dealer for help.

Power Light Does Not Light

Check the following:

- Is the system operating normally? If so, the power LED is probably defective or the cable from the front panel to the server board is loose.
- Are there other problems with the system? If so, check the items listed under “System Cooling Fans Do Not Rotate Properly.”

If all items are correct and problems persist, contact your service representative or authorized dealer for help.

No Characters Appear on Screen

Check the following:

- Is the keyboard functioning? Check to see that the “Num Lock” light is functioning.
- Is the video monitor plugged in and turned on?
- Are the brightness and contrast controls on the video monitor properly adjusted?
- Are the video monitor switch settings correct?
- Is the video monitor signal cable properly installed?
- Is the onboard video controller enabled?

If you are using an add-in video controller board, do the following:

1. Verify that the video controller board is fully seated in the server board connector.
2. Reboot the system for changes to take effect.

3. If there are still no characters on the screen after you reboot the system and POST emits a beep code, write down the beep code you hear. This information is useful for your service representative. See “Port-80 Codes and Countdown Codes” on page 94.
4. If you do not receive a beep code and characters do not appear, the video display monitor or video controller may have failed. Contact your service representative or authorized dealer for help.

Characters Are Distorted or Incorrect

Check the following:

- Are the brightness and contrast controls properly adjusted on the video monitor? See the manufacturer’s documentation.
- Are the video monitor signal and power cables properly installed?

If the problem persists, the video monitor may be faulty or it may be the incorrect type. Contact your service representative or authorized dealer for help.

System Cooling Fans Do Not Rotate Properly

If the system cooling fans are not operating properly, system components could be damaged.

Check the following:

- Is AC power available at the wall outlet?
- Is the system power cord properly connected to the system and the wall outlet?
- Did you press the power button?
- Is the power on light lit?
- Have any of the fan motors stopped (use the server management subsystem to check the fan status)?
- Are the fan power connectors properly connected to the server board?
- Is the cable from the front panel board connected to the server board?
- Are the power supply cables properly connected to the server board?
- Are there any shorted wires caused by pinched cables or power connector plugs forced into power connector sockets the wrong way?

If the switches and connections are correct and AC power is available at the wall outlet, contact your service representative or authorized dealer for help.

Diskette Drive Activity Light Does Not Light

Check the following:

- Are the diskette drive power and signal cables properly installed?
- Are all relevant switches and jumpers on the diskette drive set correctly?
- Is the diskette drive properly configured?
- Is the diskette drive activity light always on? If so, the signal cable may be plugged in incorrectly.

If you are using the onboard diskette controller, use the SSU to make sure that “Onboard Floppy” is set to “Enabled.” If you are using an add-in diskette controller, make sure that “Onboard Floppy” is set to “Disabled.” To run the SSU, see Chapter 3.

If the problem persists, there may be a problem with the diskette drive, server board, or drive signal cable. Contact your service representative or authorized dealer for help.

Hard Disk Drive Activity Light Does Not Light

If you have installed one or more hard disk drives in your system, check the following:

- Are the power and signal cables to the drive properly installed?
- Are all relevant switches and jumpers on the hard drive and adapter board set correctly?
- Is the onboard IDE controller enabled? (IDE hard drives only)
- Is the hard disk drive properly configured?

NOTE

Front panel hard disk LED indicates IDE and SCSI devices: The hard disk drive activity light on the front panel lights when either an IDE hard disk drive, or a SCSI device controlled by the onboard SCSI host controller, is in use. This LED does not display CD-ROM activity.

CD-ROM Drive Activity Light Does Not Light

Check the following:

- Are the power and signal cables to the CD-ROM drive properly installed?
- Are all relevant switches and jumpers on the drive set correctly?
- Is the drive properly configured?
- Is the onboard IDE controller enabled?

⇒ NOTE

Front panel hard disk LED indicates IDE and SCSI devices: The hard disk drive activity light on the front panel lights when either an IDE hard disk drive, or a SCSI device controlled by the onboard SCSI host controller, is in use. This LED does not display CD-ROM activity.

Cannot Connect to a Server

- Make sure you are using the drivers that are shipped on the system Configuration Software CD for the onboard network controller.
- Make sure the driver is loaded and the protocols are bound.
- Make sure the network cable is securely attached to the connector at the system back panel and that the network controller Link LED is on (visible at back panel). If the cable is attached but the problem persists, try a different cable.
- Make sure the hub port is configured for the same duplex mode as the network controller.
- Check with your LAN administrator about the correct networking software that needs to be installed.
- If you are directly connecting two servers (no hub), you will need a crossover cable (see your hub documentation for more information on crossover cables).
- Check the network controller LEDs that are visible through an opening at the system back panel.

Problems with Network

The server hangs when the drivers are loaded.

- Change the PCI BIOS interrupt settings. Try the “PCI Installation Tips” below.

Diagnostics pass, but the connection fails.

- Make sure the network cable is securely attached.
- Make sure you specify the correct frame type in your NET.CFG file.

The Link LED doesn't light.

- Make sure you have loaded the network drivers.
- Check all cable connections.
- Try another port on the hub.
- Make sure you have the correct type of cable between the adapter and the hub. Some hubs require a crossover cable while others require a straight through cable (for more information on crossover cabling, see your hub documentation).

The Activity LED doesn't light.

- Make sure you've loaded the correct network drivers.
- Network may be idle. Try accessing a server.

The controller stopped working when an add-in adapter was installed.

- Make sure the cable is connected to the port from the onboard network controller.
- Make sure your PCI BIOS is current. Try the “PCI Installation Tips” below.
- Make sure the other adapter supports shared interrupts. Also, make sure your operating system supports shared interrupts; OS/2[†] does not.
- Try reseating the add in adapter.

The add-in adapter stopped working without apparent cause.

- Try reseating the adapter first; then try a different slot if necessary.
- The network driver files may be corrupt or deleted. Delete and then reinstall the drivers.
- Run the diagnostics.

PCI Installation Tips

Some common PCI tips are listed here.

- Reserve interrupts (IRQs) and/or memory addresses specifically for ISA adapters. This prevents PCI cards from trying to use the same settings ISA cards are using. Use the SSU to keep track of ISA adapter resources.
- Certain drivers may require interrupts that are not shared with other PCI drivers. The SSU can be used to adjust the interrupt numbers for PCI devices. For certain drivers, it may be necessary to alter settings so that interrupts are not shared.

Problems with Application Software

If you have problems with application software, do the following:

- Verify that the software is properly configured for the system. See the software installation and operation documentation for instructions on setting up and using the software.
- Try a different copy of the software to see if the problem is with the copy you are using.
- Make sure all cables are installed correctly.
- Verify that the server board jumpers are set correctly. See Chapter 5.
- If other software runs correctly on the system, contact your vendor about the failing software.

If the problem persists, contact the software vendor’s customer service representative for help.

Bootable CD-ROM Is Not Detected

Check the following:

- Is the BIOS set to allow the CD-ROM to be the first bootable device?

Error and Informational Messages

When you turn on the system, POST displays messages that provide information about the system. If a failure occurs, POST emits beep codes that indicate errors in hardware, software, or firmware. If POST can display a message on the video display screen, it causes the speaker to beep twice as the message appears.

Port-80 Codes and Countdown Codes

After the video adapter has been successfully initialized, the BIOS indicates the current testing phase during POST after the video adapter has been successfully initialized by outputting a 2-digit hex code to I/O location 80h. If a port-80h ISA POST card is installed, it displays the 2-digit code on a pair of hex display LEDs.

POST Error Codes and Messages

The following error codes and messages are representative of various conditions BIOS identifies. The exact strings and error numbers may be different from those listed here.

5 Technical Reference

This chapter includes the following:

- Environmental specifications
- Board interrupts
- Electromagnetic Compatibility (EMC) notices

Connectors

The figure shows connector locations on the server board. This section provides pin information about the connectors.

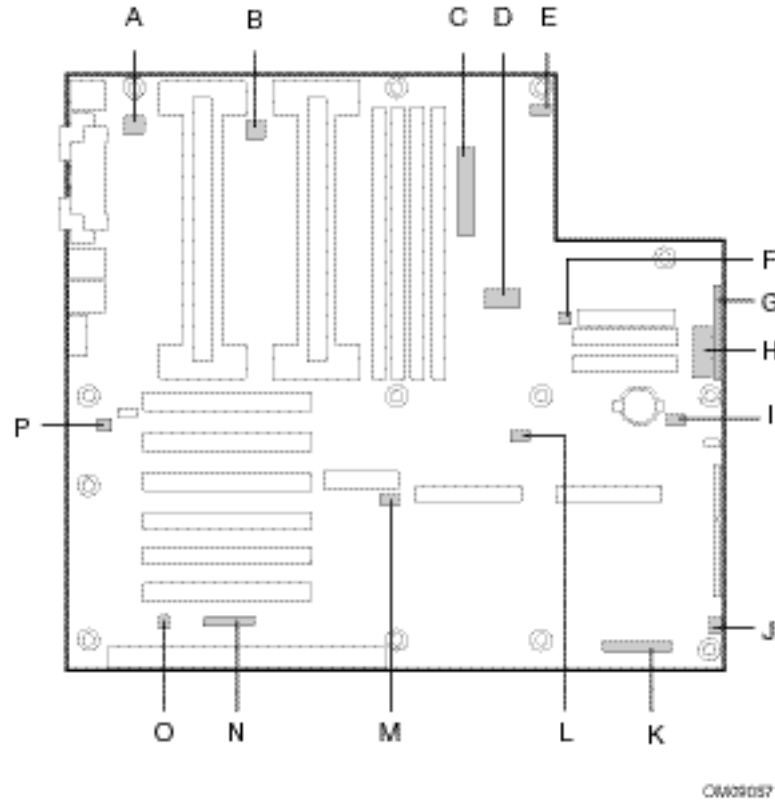

Figure 15. Connector Locations

- | | |
|----------------------------------|--|
| A. Fansink connector 2 | I. ISOL IMB |
| B. Fansink connector 1 | J. Fan connector 1 |
| C. Main power connector | K. Server monitor module (SMM) connector |
| D. ATX Aux power connector | L. External Wake on LAN connector |
| E. SM IMB | M. Hard drive LED connector |
| F. Fan connector 2A | N. ICMB header |
| G. ATX front panel connector | O. Chassis intrusion connector |
| H. Front panel connector, 16 pin | P. Fan connector 2B |

ATX Style Front Panel Connector

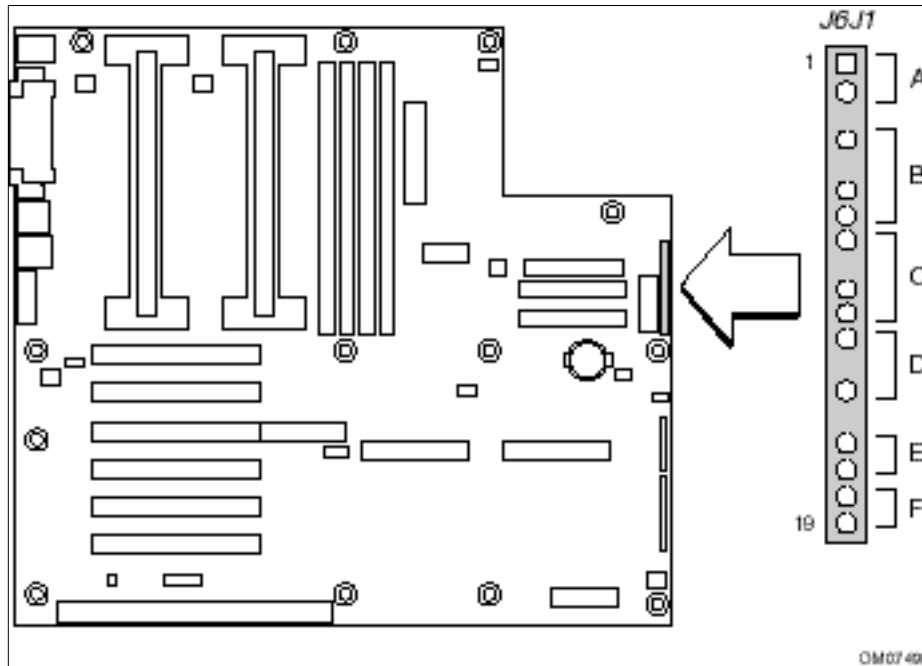

Figure 16. ATX Style Front Panel Connector

Table 8. ATX Style Front Panel Connector Pinout

Connector	Pin	Signal
A. Power switch	1	Power switch
	2	GND
	3	N/C
B. Hard drive activity LED	4	Current limited +5V
	5	Key
	6	HD activity LED
	7	Current limited +5V
C. Speaker	8	GND
	9	N/C
	10	PIEZO_IN
	11	SPKR_HDR
D. Power LED	12	Current limited +5V
	13	N/C
	14	GND
	15	N/C
E. Reset switch	16	GND
	17	Reset switch
F. Sleep switch	18	GND
	19	Sleep switch

Main Power Connector

Table 9. Main Power Connector Pinout

Pin	Signal	Pin	Signal
1	+3.3V	13	+3.3V
2	+3.3V	14	-12V
3	COM	15	COM
4	+5V	16	PS_ON
5	COM	17	COM
6	+5V	18	COM
7	COM	19	COM
8	PWR_OK	20	-5V
9	+5VSB	21	+5V
10	+12V	22	+5V
11	+12V	23	+5V
12	+3.3V	24	COM

Fan Interface

The server board has five 3-pin fan connectors that are shrouded and keyed. Two are located next to the processor sockets (one for each processor); each is intended to be used for a tachometer fan heat sink.

NOTE

Fan connectors 2A and 2B can not be used simultaneously. If you plug fans into both connectors, the fans will not operate properly.

Table 10. Fan Connector Pinout

Pin	Signal
1	GND
2	+12V
3	Fan Sensor

Server Board Jumpers

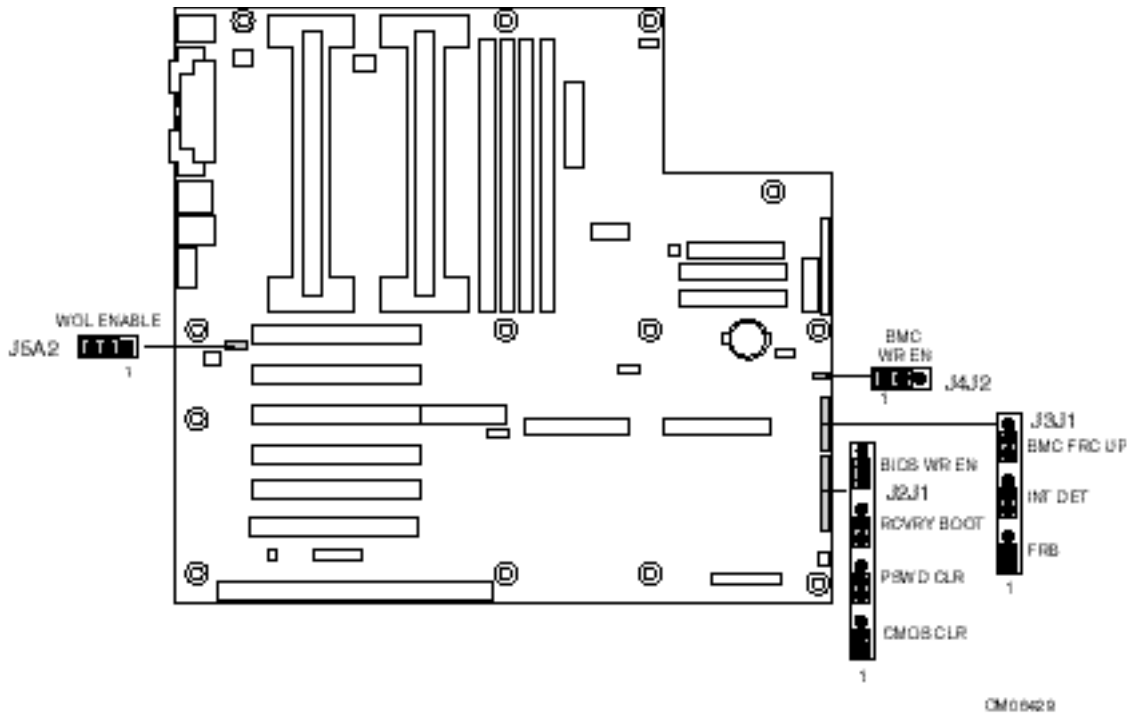

Figure 17. Jumper Locations

Table 11. Server Board Jumper Summary

Jumper Block	Jumper Name	Pins (default in bold)	What it does at system reset
J5A2	WOL ENABLE	1-2, Disabled 2-3, Enabled	Disables Wake On LAN. If your power supply does not provide 0.8 A of +5 V Standby current, you must move the WOL Enable jumper to this position. Enables Wake On LAN.
J4J2	BMC WR EN	1-2, Protect 2-3, Erase/Program	BMC boot block is write protected. BMC boot block is erasable and programmable.
J3J1	FRB	1-2, Enable 2-3, Disable	FRB operation is enabled (system boots from processor 1 if processor 0 does not respond). FRB is disabled.
J3J1	INT DET	5-6, Enable 6-7, Disable	Switch installed on chassis indicates when cover has been removed. Chassis intrusion switch is bypassed.
J3J1	BMC FRC UP	9-10, Normal 10-11, Program	System boots normally. System attempts to update BMC firmware.

continued

Table 11. Server Board Jumper Summary (continued)

Jumper Block	Jumper Name	Pins (default in bold)	What it does at system reset
J2J1	CMOS CLR	1-2, Protect 2-3, Erase	Preserves the contents of NVRAM. Replaces the contents of NVRAM with the manufacturing default settings.
J2J1	PSWD CLR	5-6, Protect 6-7, Erase	Maintains the current system password. Clears the password.
J2J1	RCVRY BOOT	9-10, Normal 10-11, Recovery	System attempts to boot using the BIOS stored in flash memory. BIOS attempts a recovery boot, loading BIOS code from a floppy diskette into the flash device. This is typically used when the BIOS code has been corrupted.
J2J1	BIOS WR EN	13-14, Protect 14-15, Erase/Program	BIOS boot block is write-protected. BIOS boot block is erasable and programmable.

General Procedure to Change Jumper Setting

The short general procedure for changing a configuration setting is the same for most of the jumper functions, so we will describe it here.

1. Observe the safety and ESD precautions at the beginning of this chapter.
2. Turn off all connected peripherals, turn off system power, and disconnect the AC power cord.
3. Remove the side cover. You do not need to remove the server board from the chassis, and you probably do not need to remove any add-in boards.
4. Locate the configuration jumpers at the edge of the server board toward the front of the system.
5. Move jumper to pins specified for the desired setting.
6. Reinstall the side cover, connect the power cord, and turn on the system for the change to take effect.
7. You may need to repeat these steps to move the jumper back to its original setting, depending on the jumper function.

CMOS Jumper

The jumper at pins 1, 2, and 3 controls whether settings stored in CMOS nonvolatile memory (NVRAM) are retained during a system reset.

Procedure to restore the system's CMOS and RTC to default values:

1. See "General Procedure to Change Jumper Setting" on page 100.
2. Move the CMOS jumper from pins 1 and 2 to pins 2 and 3 (the Clear CMOS memory position).
3. Reinstall the side cover for your safety, and connect the power cord to the system.
4. Turn the system on. Wait for POST to complete and for the messages "NVRAM cleared by jumper" and "Press F2 to enter Setup" to appear. This automatically reprograms CMOS and RTC to their default settings.
5. Enter Setup and make any changes necessary (for example, changing the boot device). Press F10 to save the new Setup configuration and exit Setup.
6. Turn off the system, and disconnect the power cord from the system.
7. Again remove the side cover.
8. Move the jumper from pins 2 and 3 back to pins 1 and 2 (the Protect CMOS memory position).
9. Reinstall the side cover, and connect the power cord to the system.
10. Run BIOS Setup or the SSU to verify the correct settings. See Chapter 3.

Password Jumper

The jumper at pins 5, 6, and 7 controls whether the user and administrative passwords are retained or cleared during a system reset.

Procedure to clear the current password and then enter a new one:

1. See "General Procedure to Change Jumper Setting" on page 100.
2. Move the Password jumper from pins 5 and 6 to pins 6 and 7.
3. Reinstall the side cover for your safety, and connect the power cord to the system.
4. Turn the system on, and wait for POST to complete. This automatically clears the password.
5. Turn off the system, and disconnect the power cord.
6. Again remove the side cover.
7. Move the jumper from pins 6 and 7 back to pins 5 and 6.
8. Reinstall the side cover, and connect the power cord to the system.
9. Run the SSU to specify a new password. See Chapter 3.

Recovery Boot Jumper

The jumper at pins 9, 10, and 11 controls whether the system attempts to boot using the BIOS programmed in the boot block area of the FLASH memory. This should be used only if the operational area of the BIOS is corrupted or needs to be upgraded. Contact your local service representative before doing this.

Procedure to disable recovery booting:

1. See “General Procedure to Change Jumper Setting” on page 100.
2. Move the recovery boot jumper from pins 9 and 10 to pins 10 and 11.
3. Reinstall the side cover for your safety, connect the power cord to the system.
4. Turn the system on, and insert the Flash Memory Update Utility diskette in drive A. After the system boots, the speaker emits a single beep and the recovery process starts. This takes about three minutes. When the recovery process completes, the speaker emits two beeps.

While in the recovery mode, there is no screen display on the monitor. The keyboard is disabled as the system automatically recovers the BIOS. The following beep codes describe the recovery status.

Beep Code	Message
2	Successful completion, no errors.
4	The system could not boot from the diskette. The diskette may not be bootable.
Continuous series of low beeps	The wrong BIOS recovery files are being used and/or the flash memory jumper is in the wrong position.

5. Turn the system off, disconnect the power cord(s) from the system, and remove the left side cover.
6. Move the jumper from pins 9 and 10 to pins 10 and 11 to enable the normal boot mode.
7. Replace the left side cover, remove the diskette from drive A, and connect the power cord(s) to the system.
8. After running the special recovery mode, run the SSU to specify a new password. See Chapter 3.

Boot Block Write Protect Jumper

The jumper at pins 13, 14, and 15 controls whether the BIOS boot block is protected from being erased and reprogrammed.



CAUTION

Leave boot block jumper at factory default setting: Programming the boot block incorrectly will prevent the system from booting. Programming *should be done only* by a technically qualified person. The procedure requires a special “Boot Block Update Utility.” Contact your dealer or sales representative for more information.

Procedure to permit boot block erasing and programming:

1. See “General Procedure to Change Jumper Setting” on page 100.
2. Move the boot block jumper from pins 13 and 14 to pins 14 and 15 to erase and program the BIOS boot block.
3. Reinstall the side cover for your safety, and connect the power cord to the system.
4. Run the Boot Block Update Utility.
5. Turn off the system, and disconnect the power cord from the system.
6. Remove the side cover.
7. Move the jumper from pins 14 and 15 back to pins 13 and 14 to write protect the BIOS boot block.
8. Reinstall the side cover, and connect the power cord to the system.

FRB Timer Enable Jumper

The jumper at pins 5, 6, and 7 controls the FRB timers. See page 85.

Procedure to disable FRB timer:

1. See “General Procedure to Change Jumper Setting” on page 100.
2. Move the recovery boot jumper from pins 5 and 6 to pins 6 and 7.
3. Reinstall the side cover for your safety, and connect the power cord to the system.
4. Turn the system on, and wait for POST to complete.
5. Run the SSU to configure the system. See Chapter 3.

Chassis Intrusion Detection Jumper

The chassis contains an alarm switch that sends a notification signal to the server management software if a cover is removed. The jumper at pins 9, 10, and 11 controls whether this alarm feature is enabled or disabled.

Procedure to disable (bypass) the chassis intrusion switch:

1. See “General Procedure to Change Jumper Setting” on page 100.
2. Move the chassis intrusion detection jumper from pins 9 and 10 to pins 10 and 11 to disable the alarm switch.
3. Reinstall the side cover for your safety, and connect the power cord to the system.
4. Turn the system on, and wait for POST to complete.
5. Run the SSU to configure the system. See Chapter 3.

To enable the intrusion switch, do the above steps but move the jumper back to pins 9 and 10.

6 Regulatory and Integration Information

Regulatory Compliance

This server baseboard complies with the following safety and EMC regulations when correctly installed in a compatible host system.

Table 12. Safety Regulations

Regulation	Title
UL 1950/CSA950, 3 rd edition, Dated 07-28-95	Bi-National Standard for Safety of Information Technology Equipment including Electrical Business Equipment. (USA and Canada)
EN 60950, 2 nd Edition, 1992 (with Amendments 1, 2, 3, and 4)	The Standard for Safety of Information Technology Equipment including Electrical Business Equipment. (European Community)
IEC 950, 2 nd edition, 1991 (with Amendments 1, 2, 3, and 4)	The Standard for Safety of Information Technology Equipment including Electrical Business Equipment. (International)
EMKO-TSE (74-SEC) 207/94	Summary of Nordic deviations to EN 60950. (Norway, Sweden, Denmark, and Finland)

Table 13. EMC Regulations

Regulation	Title
FCC Class B	Title 47 of the Code of Federal Regulations, Parts 2 and 15, Subpart B, pertaining to unintentional radiators. (USA)
CISPR 22, 2 nd Edition, 1993 (Class B)	Limits and methods of measurement of Radio Interference Characteristics of Information Technology Equipment. (International)
VCCI Class B (ITE)	Implementation Regulations for Voluntary Control of Radio Interference by Data Processing Equipment and Electronic Office Machines. (Japan)
EN55022 (1994) (Class B)	Limits and methods of measurement of Radio Interference Characteristics of Information Technology Equipment. (Europe)
EN50082-1 (1992)	Generic Immunity Standard; Currently compliance is determined via testing to IEC 801-2, -3, and -4. (Europe)
ICES-003 (1997)	Interference-Causing Equipment Standard, Digital Apparatus, Class B (Including CRC c.1374). (Canada)

This printed circuit assembly has the following product certification markings

- UL Joint Recognition Mark: Consists of small c followed by a stylized backward UR and followed by a small US (Component side)
- Manufacturer's recognition mark: Consists of a unique UL recognized manufacturer's logo, along with a flammability rating (94V-0) (Solder side)
- UL File Number for motherboards: E139761 (Component side)
- PB Part Number: Intel bare circuit board part number XXXXXX-ZZZ (Solder side)
- Battery "+" marking: located on the component side of the board in close proximity to the battery holder
- CE Mark: (Component side) The CE mark should also be on the shipping container
- Australian C-Tick Mark: Consists of solid circle with white check mark and supplier code N232

Installation Instructions



CAUTION

Follow these guidelines to meet safety and regulatory requirements when installing this board assembly.

Read and adhere to all of these instructions and the instructions supplied with the host computer and associated modules. If the instructions for the host computer are inconsistent with these instructions or the instructions for associated modules, contact the supplier's technical support to find out how you can ensure that your computer meets safety and regulatory requirements. If you do not follow these instructions and the instructions provided by host computer and module suppliers, you increase safety risk and the possibility of noncompliance with regional laws and regulations.

Ensure EMC

Before computer integration, make sure that the host chassis, power supply, and other modules have passed EMC certification testing.

In the installation instructions for the host chassis, power supply, and other modules pay close attention to the following:

- Certifications (See "Ensure Host Computer and Accessory Module Certifications" on page 107.)
- External I/O cable shielding and filtering
- Mounting, grounding, and bonding requirements
- Keying connectors when mismating of connectors could be hazardous

If the host chassis, power supply, and other modules have not passed applicable EMC certification testing before integration, EMC testing must be conducted on a representative sample of the newly completed computer.

Ensure Host Computer and Accessory Module Certifications

Make sure that the host computer, any added subassembly (such as a board or drive assembly, including internal or external wiring), are certified for the region(s) where the end product will be used. Marks on the product are proof of certification. Certification marks are as follows:

In Europe

The CE marking signifies compliance with all relevant European requirements. If the host computer does not bear the CE marking, obtain a supplier's Declaration of Conformity to the appropriate standards required by the European EMC Directive and Low Voltage Directive. Other directives, such as the Machinery and Telecommunications Directives, may also apply depending on the type of product. No regulatory assessment is necessary for low voltage DC wiring used internally or wiring used externally when provided with appropriate overcurrent protection. Appropriate protection is provided by a maximum 8 Amp current limiting circuit or a maximum 5 Amp fuse or positive temperature coefficient (PTC) resistor. This Intel server board has PTCs on all external ports that provide DC power externally.

In the United States

A certification mark by a Nationally Recognized Testing Laboratory (NRTL) such as UL, CSA, or ETL signifies compliance with safety requirements. External wiring must be UL Listed and suitable for the intended use. Internal wiring must be UL Listed or Recognized and rated for applicable voltages and temperatures. The FCC mark (Class A for commercial or industrial only or Class B for residential) signifies compliance with electromagnetic interference requirements.

In Canada

A nationally recognized certification mark such as CSA or cUL signifies compliance with safety requirements. No regulatory assessment is necessary for low voltage DC wiring used internally or wiring used externally when provided with appropriate overcurrent protection. Appropriate protection is provided by a maximum 8 Amp current limiting circuit or a maximum approved 5 Amp fuse or positive temperature coefficient (PTC) resistor. This server board has PTCs on all external ports that provide DC power externally.

Prevent Power Supply Overload

Do not overload the power supply output. To avoid overloading the power supply, make sure that the calculated total current load of all the modules within the computer is less than the maximum output current rating of the power supply. If you do not do this, the power supply may overheat, catch fire, or damage the insulation that separates hazardous AC line circuitry from low voltage user accessible circuitry and result in a shock hazard. If the load drawn by a module cannot be determined by the markings and instructions supplied with the module, contact the module supplier's technical support.

Place Battery Marking on Computer

There is insufficient space on this server board to provide instructions for replacing and disposing of the battery. The following warning must be placed permanently and legibly on the host computer as near as possible to the battery.



WARNING

Danger of explosion if battery is incorrectly replaced.

Replace with only the same or equivalent type recommended by the manufacturer. Dispose of used batteries according to the manufacturer's instructions.

Use Only for Intended Applications

This product was evaluated for use in ITE computers that will be installed in offices, schools, computer rooms and similar locations. The suitability of this product for other product categories other than ITE applications, (such as medical, industrial, alarm systems, and test equipment) may require further evaluation.

Installation Precautions

When you install and test the server board, observe all warnings and cautions in the installation instructions.

To avoid injury, be careful of:

- Sharp pins on connectors
- Sharp pins on printed circuit assemblies
- Rough edges and sharp corners on the chassis
- Hot components (like processors, voltage regulators, and heat sinks)
- Damage to wires that could cause a short circuit

Observe all warnings and cautions that instruct you to refer computer servicing to qualified technical personnel.



WARNING

Do not open the power supply. Risk of electric shock and burns from high voltage and rapid overheating. Refer servicing of the power supply to qualified technical personnel.

7 Equipment Log and Power Consumption Worksheets

Equipment Log

Use the blank equipment log provided here to record information about your system. You will need some of this information when you run the SSU.

Item	Manufacturer Name and Model Number	Serial Number	Date Installed
System			
Server board			
Primary Processor speed and cache			
Secondary Processor speed and cache			
Video display			
Keyboard			
Mouse			
Diskette drive A			
Diskette drive B			
Tape drive			
CD-ROM drive			
Hard disk drive 1			
Hard disk drive 2			
Hard disk drive 3			
Hard disk drive 4			
Hard disk drive 5			

continued

Current Usage

As an overall current usage limitation on the power supply, do not exceed a combined power output of 167 watts for the +5 and +3.3 volt outputs.

The ISA slots on the server board are rated at a maximum of 4.5 amperes per slot. The ISA specification recommends supporting an average of 2.0 amperes per slot. The average current usage should not exceed 3.0 amperes per slot; that is, 15 watts.

The PCI slots on the server board are rated at a maximum of 5 amperes per slot. The maximum power allowed for each slot is 20 watts at +5 volts. The average current usage per slot should not exceed 3.0 amperes per slot; that is, 15 watts.

The cooling efficiency varies per slot; therefore, ensure that adequate cooling is available in the target slot—especially in an expansion slot drawing more than 2.0 amperes.

Calculating Power Consumption

The total combined wattage for the system configuration must be less than the output of your power supply. Use the two worksheets in this section to calculate the power used by your server boards. For current and voltage requirements of add-in boards and peripherals, see your vendor documents.

Worksheet, Total Combined Power Used by the System

1. From the previous worksheet, enter the total current for each column.
2. Multiply the voltage by the total current to get the total wattage for each voltage level.
3. Add the total wattage for each voltage level to arrive at a total combined power usage on the power supply.

Table 15. Power Usage Worksheet 2

Voltage level and total current (V X A = W)	Total Watts for each voltage level
(+3.3 V) X (_____ A)	_____ W
(+5 V) X (_____ A)	_____ W
(-5 V) X (_____ A)	_____ W
(+12 V) X (_____ A)	_____ W
(-12 V) X (_____ A)	_____ W
Total Combined Wattage	_____ W

Index

A

- Add-in boards
 - IDE bus slots, 12
 - ISA, 51
 - ISA slots, 12
 - PCI, 51
- administrative password, 17
 - limiting access to SCU, 19
- Advanced Menu, configuring in Setup, 40
- audible beep error codes, 34

B

- Back Panel Connectors, 8
- battery
 - disposing of safely, 30
 - installing, 31
 - removing, 30
- beep codes, 34
- BIOS
 - changing the language, 81
 - recovering, 81
 - upgrading, 79
- BIOS update utility, 33
- BMC, 15
- boot block write protect default jumper, 102
- Boot Device Priority menu, configuring, Setup, 49
- Boot menu, configuring, Setup, 48
- boot sequence
 - booting without keyboard, 20
 - setting in Setup, 20
- bootable media, required by POST, 34
- booting cold, 85
- bus termination requirements, SCSI devices, 13

C

- cables, IDE bus length limit, 14
- Caution
 - avoid damaging jumpers when changing, 22
 - avoid touching processor pins, 26

- DIMM types, matching, 24
- DIMMs, use extreme care when installing, 24
- ESD protection, 22, 23
- leave boot block protect jumper at default, 102
- selecting correct heat sink, 26
- selecting correct processor, 26
- CFG files, 51
- chassis intrusion detection default jumper, 103
- CMOS
 - clear to reconfigure diskette drive, 35
 - retaining settings, 101
- configuration, limiting access to system with administrative password, 19
- configuring server board jumpers
 - boot block protect, 102
 - chassis intrusion detection, 103
 - FRB timer, enabling or disabling, 103
 - general procedure to change, 100
 - location on server board, 99
 - retaining CMOS settings, 101
 - retaining stored password, 101
- configuring system
 - SCU, 33
 - Setup, 33
- connector
 - fan, 98
 - front panel, 97
 - locations on server board, 96
- Console Redirection menu, configuring in Setup, 46, 47, 48
- controller
 - baseboard management (BMC), 15
 - diskette (floppy), 13
 - IDE, 13
 - keyboard/mouse, 14
 - network, 7, 14
 - SCSI, 13
 - video, 7, 13
- cooling, heat sink for processor, 26
- current ratings for add-in board slots, 111

D

- diagnostics, preparing system for testing, 88
- DIMM (memory)
 - installing, 24
 - removing, 25
- diskette
 - drive controller, 13
 - enabling/disabling floppy writes, 19
 - no booting in secure mode without password, 19
 - reconfiguring if cannot enter Setup, 35
 - running SCU from, 33, 34

E

- Emergency Management Port
 - FRU viewer, 74
 - main console window, 67
 - phonebook, 71
 - requirements, 65
 - SDR viewer, 73
 - server control operations, 68
- Emergency Management Port Console, 16, 62
- EMI, gasket for I/O connectors, 23
- EMP. *See* Emergency Management Port Console. *See* Emergency Management Port Console
- equipment log, 109
- error
 - codes and messages, 94
 - messages, 34, 94
- ESD
 - add-in boards, 21
 - avoiding damage to product, 21
 - do not touch processor pins, 26
 - server board sensitive to, 22, 23
- Exit menu, configuring, Setup, 50
- expanded video memory, 13
- Extended RAM Step menu, 49

F

- fan
 - connectors on server board, 98
 - heat sink, disconnecting, 26
- feature summary
 - back panel connectors, 8
 - board, 7
- Firmware update utility, 33

- Firmware Update Utility, 82
- form factor, 7
- FRB timer enable default jumper, 103
- front panel control board
 - connector on server board, 97
- FRUSDR load utility, 33
 - when to run, 75
- FRUSDR Load Utility, 75

G - H

- gasket, EMI protection at I/O connectors, 23
- Hard Drive menu, configuring, Setup, 49, 50
- heat sink, fan, 26
- hot key option, quick reference, 33

I

- I/O
 - ISA expansion slots, 7
 - PCI expansion slots, 7
 - ports provided, 7
- I2C bus for monitoring status, 15
- IDE
 - bus length limit, 14
 - controller, 13
 - feature summary, 12
 - primary, master and slave, configuring, Setup, 38
- Integrated Peripheral Configuration menu, configuring in Setup, 41
- intrusion detection, 15, 17
- ISA
 - embedded device support, 7
 - expansion slots, 7
 - feature summary, 12
 - slot current ratings, 111

J - K - L

- jumpers, do not damage when changing, 22
- keyboard
 - compatibility, 14
 - features, configuring, Setup, 39
 - lockout timer, setting in SCU, 14
- language, changing in BIOS, 81
- lithium backup battery
 - disposing of safely, 30
 - installing, 31
 - removing, 30

M - N

- Main power supply, connector, 98
- memory
 - amount tested, POST, 34
 - capacity, 7
 - DIMM requirements, 11
 - DIMM size, 10
 - expansion, 10
 - installing DIMM, 24
 - removing DIMM, 25
 - video amount, 7
 - video size, 13
 - what type to install, 7
- messages, error and informational, 94
- monitoring server status, 15
- mouse
 - compatibility, 14
 - inactivity timer, 14
- network, controller, 7, 14

P

- password, 17
 - administrative, 17
 - administrator, 18
 - entering to unblank screen, 19
 - retaining at system reset, 101
 - user, 17
 - using to reactivate keyboard/mouse, 19
 - using to reactivate keyboard/mouse, 14
- PCI
 - embedded devices, 7
 - expansion slots, 7
 - slot current ratings, 111
- PCI Configuration Menu, configuring in Setup, 40
- PCI Device, Embedded SCSI menu, configuring in Setup, 40, 42
- PCI Device, Slot 1 - Slot 4 menu, configuring in Setup, 41
- PEP. See Platform Event Paging
- PEP Filter Submenu, 48
- PEP Management Submenu, 47
- Platform Event Paging, 17, 61

POST

- bootable media required, 34
- countdown codes, 94
- error codes and messages, 94
- error messages, 34
- memory, amount tested, 34
- power on/off, locking on/off switch, Setup, 19
- power supply
 - calculating power usage, 111
 - current usage, 111
 - main connector pins, 98
 - monitoring power state, 15
 - worksheet, calculating DC power, 112
- problems
 - after running new application software, 86
 - after system has been running
 - correctly, 87
 - application software, 93
 - bootable CD-ROM not detected, 93
 - cannot connect to network server, 92
 - CD-ROM drive activity light, 91
 - confirm OS loading, 88
 - diskette drive light, 91
 - hard drive light, 91
 - initial system startup, 85
 - network, 92
 - no characters on screen, 89
 - PCI installation tips, 93
 - power light, 89
 - preparing system for diagnostic testing, 88
 - random error in data files, 87
 - screen characters incorrect, 90
 - system cooling fans do not rotate, 90
 - system lights, 88
- processor, 26
 - installing, 28
 - removing, 26
 - selecting the correct processor, 26
 - use grounded, static free surface, 26
- processor description, 10

R

- real time clock, running SCU to configure settings, 31
- recovery boot jumper, retaining settings, 102
- removing termination board, 28
- reset system, 33, 85

S

- SCI files, 51
- SCSI, bus termination requirements, 13
- SCSI controller, 13
- SCU
 - administrative password limits access to, 19
 - changing configuration, 33
 - diskette drive required to run SCU, 33
 - inactivity (lockout) timer, 14
 - software locking feature, 17
- secure mode, 18
 - affects boot sequence, 20
 - enter by setting passwords, 19
 - locking reset and power on/off switches, 19
 - no booting from diskette without password, 19
 - using hot keys to enter, 33
- security, 17, 19
 - alarm switches, 17
 - boot sequence, 20
 - enabling/disabling floppy writes, 19
 - locking mouse, keyboard with timer, 14, 19
 - locking reset and power on/off switches, Setup, 19
 - password, 19
 - secure mode, 19
 - secure mode, setting in SCU, 18
 - software lock, SCU, 17
 - unattended start, 20
 - using hot key combination, 33
 - video blanking, 19
- Security menu, configuring, Setup, 43
- server board
 - boot block protect, jumper, 102
 - chassis intrusion detection, jumper, 103
 - CMOS settings, jumper, 101
 - component locations, figure, 9
 - configuration jumpers, 100
 - configurations, 99
 - fan connectors, 98
 - FRB timer enable, jumper, 103
 - front panel connector, 97
 - installing, 22
 - password jumper, 101
 - recovery boot settings, jumper, 102
 - removing, 23
- server management
 - BMC, 15
 - features, 15
 - intrusion detection, 17
- Server Management, 7
- Server Management Information menu, configuring in Setup, 45
- Server menu, configuring in Setup, 44
- Setup
 - Advanced menu, 40
 - Boot Device Priority menu, 49
 - Boot menu, 48
 - cannot enter, need to reconfigure diskette, 35
 - changing configuration, 33
 - Console Redirection menu, 46, 47, 48
 - description, 36
 - Exit menu, 50
 - Hard Drive menu, 49, 50
 - Integrated Peripheral Configuration menu, 41
 - keyboard features menu, 39
 - locking reset and power on/off switches, 19
 - Main menu, 37
 - PCI Configuration menu, 40
 - PCI Device, Embedded SCSI menu contents, 40, 42
 - PCI Device, Slot 1 - Slot 4 menu, 41
 - primary IDE master and slave menu, 38
 - recording settings, 35
 - security menu contents, 43
 - Server Management Information menu contents, 45
 - server menu contents, 44
- soft boot, 85
- SSU. See system setup utility
- switches
 - alarm, 17
 - locking reset and power on/off, Setup, 19
- Switches
 - DC power, 85
 - reset, 85
- System Configuration Utility. See SCU

System setup utility
CFG files, 51
customizing, 54
defining an ISA card, 55
exiting, 60
launching a task, 54
location, 50
removing an ISA card, 56
running, 52
 locally, 52
 remotely, 52
SCI files, 51
when to run, 51

T - U

termination board, removing, 28
timer
 keyboard or mouse inactive, 14
 lockout (inactivity), setting in SCU, 14
upgrade Flash utility, 79
user password, 17
 limit access to using system, 20
utilities
 BIOS update, 33
 Emergency Management Port Console,
 16, 62
 Firmware update, 33, 82
 FRUSDR load, 33
 SCSI, 33
 SCU, 33
 Setup, 33, 35
Utilities, FRUSDR load utility, 75

V

video
 blanking for security, 19
 controller, 13
 expansion, 13
 memory, 7
 resolutions supported, 13
video controller, 7
video memory, 13

W

Warning
 components may be hot, 26
 dispose of lithium battery safely, 30
 ESD can damage product, 21
worksheet, calculating DC power usage, 112
write protect boot block, jumper, 102
write to diskette, disabling, 19

Free Manuals Download Website

<http://myh66.com>

<http://usermanuals.us>

<http://www.somanuals.com>

<http://www.4manuals.cc>

<http://www.manual-lib.com>

<http://www.404manual.com>

<http://www.luxmanual.com>

<http://aubethermostatmanual.com>

Golf course search by state

<http://golfingnear.com>

Email search by domain

<http://emailbydomain.com>

Auto manuals search

<http://auto.somanuals.com>

TV manuals search

<http://tv.somanuals.com>