



STL2 Server Board

Technical Product Specification



Revision 1.0

September 22, 2000

Enterprise Platforms Group

Revision History

Date	Revision Number	Modifications
6/15/00	0.5	Initial release.
6/20/00	0.6	Updated connector reference designators
7/7/00	0.61	Updated silkscreen reference designators to agree with STL2 FAB2. Removed figure 2-3, IB6566 IRQ routing diagram. Added BIOS recovery jumper information. Corrected grammar / spelling errors. Updated table 5-1, STL2 Hardware Sensors, per recent information
8/24/00	0.7	Updated Section 5: Jumpers and Connectors, per modifications to the STL2 Fab3 Silver boards. Updated Section 4.2: BIOS Setup, per modifications included in BIOS Release 1.1. Added power consumption information to Section 6.
9/22/00	1.0	Released version

Disclaimers

Information in this document is provided in connection with Intel® products. No license, express or implied, by estoppel or otherwise, to any intellectual property rights is granted by this document. Except as provided in Intel's Terms and Conditions of Sale for such products, Intel assumes no liability whatsoever, and Intel disclaims any express or implied warranty, relating to sale and/or use of Intel products including liability or warranties relating to fitness for a particular purpose, merchantability, or infringement of any patent, copyright or other intellectual property right. Intel products are not intended for use in medical, life saving, or life sustaining applications. Intel may make changes to specifications and product descriptions at any time, without notice.

Designers must not rely on the absence or characteristics of any features or instructions marked "reserved" or "undefined." Intel reserves these for future definition and shall have no responsibility whatsoever for conflicts or incompatibilities arising from future changes to them.

This document contains information on products in the design phase of development. Do not finalize a design with this information. Revised information will be published when the product is available. Verify with your local sales office that you have the latest datasheet before finalizing a design.

The STL2 platform may contain design defects or errors known as errata which may cause the product to deviate from published specifications. Current characterized errata are available on request.

Copyright © Intel Corporation 2000. *Other brands and names are the property of their respective owners.

Table of Contents

1. Introduction	1-1
1.1 Purpose	1-1
1.2 Audience	1-1
1.3 STL2 Server Board Feature Overview.....	1-1
1.4 STL2 Server Board Block Diagram.....	1-2
2. STL2 Server Board Architecture Overview	2-5
2.1 Intel® Pentium® III Processor Subsystem	2-5
1.1.1 Supported Processor Types.....	2-5
1.1.2 Dual Processor Operation	2-6
1.1.3 PGA370 Socket.....	2-6
1.1.4 Processor Bus Termination / Regulation / Power	2-6
1.1.5 Termination Package	2-6
1.1.6 APIC Bus.....	2-6
1.1.7 Boxed Processors	2-6
1.2 ServerWorks ServerSet III LE Chipset.....	2-7
1.3 Memory.....	2-7
1.4 PCI I/O Subsystem	2-8
1.4.1 64-bit / 66 MHz PCI Subsystem.....	2-8
1.4.2 32-bit/33 MHz PCI Subsystem.....	2-10
1.5 Chipset Support Components	2-15
1.5.1 Legacy I/O (Super I/O) National* PC97317VUL.....	2-15
1.5.2 BIOS Flash.....	2-17
1.1.3 External Device Connectors.....	2-17
1.6 Interrupt Routing.....	2-17
1.6.1 Default I/O APIC.....	2-17
1.6.2 Extended I/O APIC	2-17
1.6.3 PCI Ids.....	2-20
1.6.4 Relationship between PCI IRQ and PCI Device	2-20
3. Server Management	3-23
3.1 Baseboard Management Controller.....	3-23
3.2 Hardware Sensors.....	3-24
3.3 ACPI	3-27
3.4 AC Link Mode	3-28

3.5	Wake On LAN Function.....	3-28
4.	Basic Input Output System (BIOS).....	4-29
4.1	BIOS Overview	4-29
4.1.1	System BIOS.....	4-30
4.1.2	Flash Update Utility	4-30
4.2	Setup Utility	4-31
4.2.1	Configuration Utilities Overview.....	4-31
4.2.2	Setup Utility Operation	4-31
4.3	CMOS Memory Definition	4-42
4.4	CMOS Default Override.....	4-43
4.5	Flash Update Utility	4-43
4.5.1	Loading the System BIOS.....	4-43
4.5.2	OEM Customization.....	4-44
4.5.3	Language Area.....	4-47
4.5.4	Recovery Mode	4-47
4.6	Error Messages and Error Codes	4-48
4.6.1	POST Codes	4-48
4.6.2	POST Error Codes and Messages	4-52
4.7	Identifying BIOS and BMC Revision Levels.....	4-55
4.7.1	BIOS Revision Level Identification	4-55
4.7.2	BMC Revision Level Identification	4-55
4.8	Adaptec SCSI Utility	4-56
4.8.1	Running the SCSI Utility	4-56
4.8.2	Adaptec SCSI Utility Configuration Settings.....	4-56
4.8.3	Exiting Adaptec SCSI Utility	4-58
5.	Jumpers and Connectors	5-61
5.1	Jumper Blocks	5-63
5.1.1	Setting CMOS/Password Clear Jumper Block 1J15.....	5-63
5.1.2	Setting Configuration Jumper Block 1L4	5-66
5.1.3	Setting Configuration Jumper Block 6A.....	5-67
5.2	Connectors	5-67
5.2.1	Main ATX Power Connector (P33)	5-68
5.2.2	Auxiliary ATX Power Connector (P34)	5-68
5.2.3	I ² C Power Connector (P37)	5-68
5.2.4	System Fan Connectors (P29, P27, P11)	5-69
5.2.5	Processor Connectors (P12, P36).....	5-69

5.2.6 Speaker Connector (P31).....	5-69
5.2.7 Speaker Connector (P25).....	5-69
5.2.8 Diskette Drive Connector (P20).....	5-70
5.2.9 SVGA Video Port	5-70
5.2.10 Keyboard and Mouse Connectors.....	5-71
5.2.11 Parallel Port	5-71
5.2.12 Serial Ports COM1 and COM2	5-71
5.2.13 RJ-45 LAN Connector	5-72
5.2.14 USB Connectors	5-72
5.2.15 Ultra SCSI Connector (P9)	5-73
5.2.16 Ultra160 SCSI Connector (P8).....	5-73
5.2.17 IDE Connector (P19).....	5-74
5.2.18 32-Bit PCI Connector	5-75
5.2.19 64-Bit PCI Connector	5-76
5.2.20 Front Panel 24-pin Connector Pinout (P23)	5-77
6. Power Consumption.....	6-81
6.1 Calculated Power Consumption	6-81
6.2 Measured Power Consumption	6-82
7. Mechanical Specifications	7-83
8. Regulatory and Integration Information.....	8-85
8.1 Regulatory Compliance	8-85
8.2 Installation Instructions	8-86
8.2.1 Ensure EMC	8-86
8.2.2 Ensure Host Computer and Accessory Module Certifications	8-86
8.2.3 Prevent Power Supply Overload	8-87
8.2.4 Place Battery Marking on Computer.....	8-87
8.2.5 Use Only for Intended Applications	8-88
8.2.6 Installation Precautions	8-88
8.3 Environmental Limits	8-88
8.3.1 System Office Environment.....	8-88
8.3.2 System Environmental Testing.....	8-89

List of Figures

Figure 1-1. STL2 Server Board Block Diagram	1-3
Figure 2-1. Embedded NIC PCI Signals	2-11
Figure 2-2. Video Controller PCI Signals	2-12
Figure 2-3. STL2 Baseboard Interrupt Routing Diagram (PIC mode)	2-18
Figure 2-4. STL2 Baseboard Interrupt Routing Diagram (Symmetric mode)	2-19
Figure 5-1. STL2 Server Board Jumper and Connector Locations	5-61
Figure 5-2. I/O Back Panel Connectors	5-62
Figure 5-3. Diskette Drive Connector Pin Diagram	5-70
Figure 5-4. IDE Connector Pin Diagram	5-74

List of Tables

Table 2-1. STL2 Server Board Supported Processors	2-5
Table 2-2. SCSI Transfer Speeds	2-9
Table 2-3. Embedded SCSI Supported PCI Commands	2-9
Table 2-4. Video Controller Supported PCI Commands	2-13
Table 2-5. Standard VGA Modes	2-13
Table 2-6. STL2 PCI IDs.....	2-20
Table 4-1. Setup Utility Screen.....	4-31
Table 4-2. Main Menu Selections	4-34
Table 4-3. Primary Master and Slave Adapters Submenu Selections	4-35
Table 4-4. Processor Settings Submenu Selections	4-35
Table 4-5. Advanced Menu Selections.....	4-36
Table 4-6. Memory Reconfiguration Submenu Selections.....	4-36
Table 4-7. Peripheral Configuration Submenu Selections.....	4-37
Table 4-8. PCI Device Submenu Selections.....	4-38
Table 4-9. Option ROM Submenu Selections.....	4-38
Table 4-10. Numlock Submenu Selections.....	4-38
Table 4-11. Security Menu Selections	4-39
Table 4-12. Secure Mode Submenu Selections	4-40
Table 4-13. Server Menu Selections	4-40
Table 4-14. Wake On Events Submenu Selections	4-40
Table 4-15. Console Redirection Submenu Selections	4-41
Table 4-16. Boot Menu Selections	4-41
Table 4-17. Boot Device Priority Selections	4-41
Table 4-18. Hard Drive Selections.....	4-42
Table 4-19. Removable Devices Selections	4-42
Table 4-20. Exit Menu Selections.....	4-42
Table 4-21. User Binary Area Scan Point Definitions	4-46
Table 4-22. Format of the User Binary Information Structure	4-47
Table 4-23. Port-80h Code Definition	4-48
Table 4-24. Standard BIOS Port-80 Codes	4-49
Table 4-25. Recovery BIOS Port-80 Codes.....	4-52

Table 4-26. POST Error Messages and Codes	4-52
Table 4-27. Adaptec SCSI Utility Setup Configurations.....	4-57
Table 5-1. Jumper Block 1J15 Settings	5-64
Table 5-2. Jumper Block 5E1 Settings	5-66
Table 5-3. Jumper Block 1J15 Default Settings.....	5-66
Table 5-4. Jumper Block 1L4 Settings.....	5-67
Table 5-5. Jumper Block 6A Settings	5-67
Table 5-6. Main ATX Power Connector Pinout	5-68
Table 5-7. Auxiliary ATX Power Connector Pinout	5-68
Table 5-8. I ² C Power Connector Pinout.....	5-68
Table 5-9. Board Fan Connector Pinout.....	5-69
Table 5-10. Processor Fan Connector Pinout	5-69
Table 5-11. Speaker Connector Pinout	5-69
Table 5-12. Speaker Connector Pinout	5-69
Table 5-13. Diskette Drive Connector Pinout	5-70
Table 5-14. Video Port Connector Pinout.....	5-70
Table 5-15. Keyboard and Mouse Connector Pinouts.....	5-71
Table 5-16. Parallel Port Connector Pinouts	5-71
Table 5-17. Serial Ports COM1 and COM2 Connector Pinouts	5-71
Table 5-18. RJ-45 LAN Connector Signals.....	5-72
Table 5-19. USB Connectors.....	5-72
Table 5-20. Ultra SCSI Connector Pinout.....	5-73
Table 5-21. Ultra160 SCSI Connector	5-73
Table 5-22. IDE Connector Pinout.....	5-74
Table 5-23. 32-Bit PCI Connector Pinout	5-75
Table 5-24. 64-Bit PCI Connector Pinout	5-76
Table 5-25. Front Panel 24-pin Connector Pinout	5-77
Table 6-1. STL2 Server Board Calculated Power Consumption.....	6-81
Table 6-2. STL2 Server Board Measured Power Consumption.....	6-82
Table 8-1. Safety Regulations	8-85
Table 8-2. Office System Environment Summary.....	8-88

1. Introduction

1.1 Purpose

This document provides an architectural overview of the STL2 server board, including the board layout of major components and connectors, and an overview of the server board's feature set.

1.2 Audience

This document is written for technical personnel who want a technical overview of the STL2 server board. Familiarity with the personal computer, Intel server architecture and the PCI local bus architecture is assumed.

1.3 STL2 Server Board Feature Overview

The STL2 server board provides the following features:

- Dual Intel® Pentium® III processor support.
 - Support for one or two identical Intel Pentium III processors for the PGA370 socket, which utilizes a new package technology called the Flip Chip Pin Grid Array (FC-PGA) package.
 - One embedded VRM for support of the primary processor, and one VRM connector for support of the secondary processor.
- ServerWorks* ServerSet* III LE chipset.
 - 133 MHz Front Side Bus Capability.
 - NB6635 North Bridge 3.0 LE.
 - IB6566 South Bridge.
- Support for four 3.3V, registered ECC SDRAM DIMMs that are compliant with the JEDEC PC133 specification.
 - Support for DIMM sizes 64 MB to 1GB. Four DIMM slots allow a maximum installed memory of 4GB.
 - ECC single-bit correction, and multiple-bit detection.
- 64-bit, 66 MHz, 3.3V keyed PCI segment with two expansion connectors and one embedded device.
 - Two 64-bit, 66 MHz, 3.3V keyed PCI expansion slots.
 - Integrated on-board Adaptec* AIC7899 PCI dual-port SCSI controller that provides separate Ultra160 and Ultra Wide SCSI channels.

- 32-bit, 33 MHz, 5V keyed PCI segment with four expansion connectors and three embedded devices.
 - Four 32-bit, 33 MHz, 5V keyed PCI expansion slots.
 - IB6566 South Bridge, which provides IDE and USB controller functions.
 - Integrated on-board Intel® EtherExpress™ PRO100+ 10/100megabit PCI Ethernet controller (Intel® 82559) with an RJ-45 Ethernet connector.
 - Integrated on-board ATI Rage* IIC video controller with 4 MB of on-board SGRAM video memory.
- Compatibility bus segment with three embedded devices.
 - Super I/O Controller (PC97317) that provides all PC-compatible I/O (floppy, parallel, serial, keyboard, mouse, and Real-Time Clock).
 - Baseboard Management Controller (BMC) (DS80CH11) that provides monitoring, alerting, and logging of critical system information including thermal, voltage, fan, and chassis intrusion information obtained from embedded sensors on the server board.
 - 8 MB Flash device for system BIOS.
- Dual Universal Serial Bus (USB) ports.
- One IDE connector.
- Flash BIOS support for all of the above.
- Extended ATX board form factor (12" x 13").

1.4 STL2 Server Board Block Diagram

The STL2 server board offers a “flat” design, with the processors and memory subsystems residing on the board. The following figure shows the major functional blocks of the STL2 server board. The following section describes the major components of the server board.

STL2 Server Board Block Diagram

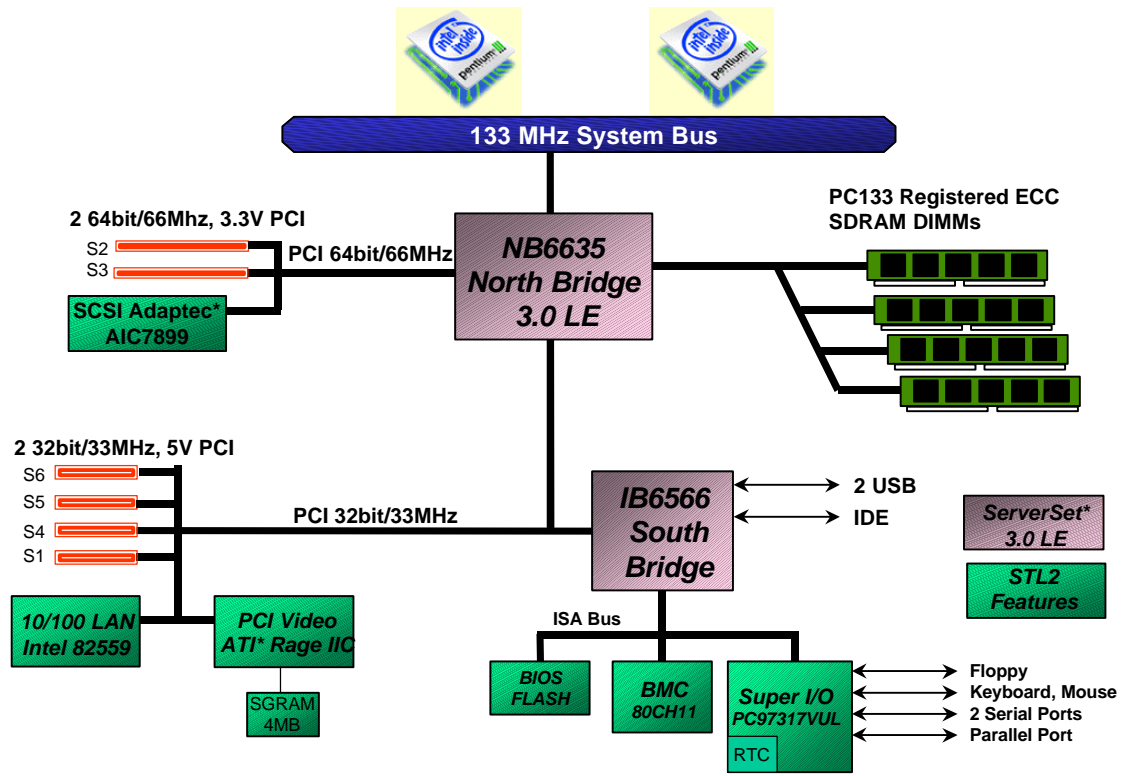

Figure 1-1. STL2 Server Board Block Diagram

< This page intentionally left blank >

2. STL2 Server Board Architecture Overview

The architecture of the STL2 server board is based on a design that supports dual-processor operation with Intel Pentium III processors and the ServerWorks ServerSet III LE chipset.

The STL2 server contains embedded devices for video, NIC, SCSI, and IDE. The STL2 server board also provides support for server management and monitoring hardware, and interrupt control that supports dual-processor and PC/AT compatible operation.

The section provides an overview of the following STL2 subsystems:

- Pentium III processor subsystem
- ServerWorks ServerSet III LE chipset
- Memory
- PCI Subsystem
- Chipset Support Components
- BMC server management controller

2.1 Intel® Pentium® III Processor Subsystem

The STL2 server board is designed to accommodate one or two Intel Pentium III processors for the PGA370 socket. The Pentium III processor for the PGA370 socket is the next member of the P6 family in the Intel IA-32 processor line. This processor uses the same core and offers the same performance as the Intel Pentium III processor for the SC242 connector, but utilizes a new package technology called flip chip pin grid array, or FC-PGA. This package utilizes the same 370-pin zero-insertion force socket (PGA370) used by the Intel® Celeron™ processor.

The STL2 server board utilizes Pentium III PGA370 socket processors, which interface with the front side bus at 133 MHz.

2.1.1 Supported Processor Types

The table below summarizes the processors that are planned to be supported on the STL2 server board:

Table 2-1. STL2 Server Board Supported Processors

Speed	FSB Frequency	Cache Size	Core
1 GHz	133 MHz	256K	CuMine
933 MHz	133 MHz	256K	CuMine
866 MHz	133 MHz	256K	CuMine
800 MHz	133 MHz	256K	CuMine
733 MHz	133 MHz	256K	CuMine
667 MHz	133 MHz	256K	CuMine

2.1.2 Dual Processor Operation

The Pentium III processor interface is designed to be MP-ready. Each processor contains a local APIC section for interrupt handling. When two processors are installed, both processors must be of identical revision, core voltage, and bus/core speeds.

2.1.3 PGA370 Socket

The STL2 server board provides two PGA370 sockets. These are 370-pin zero-insertion force (ZIF) sockets that a flip chip pin grid array (FC-PGA) package technology processor plugs into.

2.1.4 Processor Bus Termination / Regulation / Power

The termination circuitry required by the Intel Pentium III processor bus (AGTL+) signaling environment, and the circuitry to set the AGTL+ reference voltage, are implemented directly on the processor. The STL2 server board provides VRM 8.4 compliant DC-to-DC converters to provide processor power (VCCP) at each PGA370 socket. The server board provides an embedded VRM for the primary processor and a VRM socket for the secondary processor. These are powered from the +5V supply.

2.1.5 Termination Package

If a processor is not installed in a PGA370 socket, a termination package must be installed in the vacant socket to ensure reliable termination.

2.1.6 APIC Bus

Interrupt notification and generation for the processors is done using an independent path between local APICs in each processor and the I/O APIC located in the IB6566 South Bridge component.

2.1.7 Boxed Processors

The Intel Pentium III processor for the PGA370 socket is offered as an Intel boxed processor. Intel boxed processors are intended for system integrators who build systems from a server board and standard components.

2.1.7.1 Boxed Process Fan Heatsinks

The boxed Pentium III processor for the PGA370 socket will be supplied with an unattached fan heatsink that has an integrated clip. Clearance is required around the fan heatsink to ensure unimpeded airflow for proper cooling. Note that the airflow of the fan heatsink is into the center and out of the sides of the fan heatsink. The boxed processor thermal solution must be installed by a system integrator to secure the thermal cooling solution to the processor after it is installed in the 370-pin ZIF socket.

The boxed processor's fan heatsink requires a +12V power supply. A fan power cable is attached to the fan and connects to processor fan headers on the STL2 server board.

The boxed processor fan heatsink will keep the processor core at the recommended junction temperature, as long as airflow through the fan heatsink is unimpeded. It is recommended that the air temperature entering the fan inlet be below 45°C (measured at 0.3 inches above the fan hub).

2.2 ServerWorks ServerSet III LE Chipset

The ServerWorks ServerSet III LE chipset provides an integrated I/O bridge and memory controller and a flexible I/O subsystem core (PCI), targeted for multiprocessor systems and standard high-volume servers that are based on the Intel Pentium III processor. The ServerWorks ServerSet III LE chipset consists of two components:

- **NB6635 North Bridge 3.0LE**

The NB6635 North Bridge 3.0LE is responsible for accepting access requests from the host (processor) bus and for directing those accesses to memory or to one of the PCI buses. The NB6635 North Bridge 3.0LE monitors the host bus, examining addresses for each request. Accesses may be directed to a memory request queue for subsequent forwarding to the memory subsystem, or to an outbound request queue for subsequent forwarding to one of the PCI buses. The NB6635 North Bridge 3.0LE is responsible for controlling data transfers to and from the memory. The NB6635 North Bridge 3.0LE provides the interface for both the 64-bit/66 MHz, Revision 2.2-compliant PCI bus and the 32-bit/33 MHz, Revision 2.2-compliant PCI bus. The NB6635 North Bridge 3.0LE is both a master and target on both PCI buses.
- **IB6566 South Bridge**

The IB6566 South Bridge controller has several components. It can be both a master and a target on the 32-bit/33 MHz PCI bus. The IB6566 South Bridge also includes a USB controller and an IDE controller. The IB6566 South Bridge is responsible for many of the power management functions, with ACPI control registers built in. The IB6566 South Bridge provides a number of GPIO pins.

2.3 Memory

The STL2 server board contains four 168-pin DIMM sockets. Memory is partitioned as four banks of registered SDRAM DIMMs, each of which provides 72 bits of noninterleaved memory (64-bit main memory plus ECC).

The STL2 server board supports up to four 3.3V, registered ECC SDRAM DIMMs that are compliant with the JEDEC PC133 specification. A wide range of DIMM sizes are supported, including 64 MB, 128 MB, 256 MB, 512 MB, and 1GB DIMMs. The minimum supported memory configuration is 64 MB using one DIMM. The maximum configurable memory size is 4 GB using four DIMMs.

Note: Neither PC100 DIMMs nor non-ECC DIMMs can be used.

DIMMs may be installed in one, two, three, or four DIMM slots and must be populated starting with the lowest numbered slot and filling the slots in consecutive order. Empty memory slots between DIMMs are not supported. Although the STL2 server board architecture allows the user to mix various sizes of DIMMs, Intel recommends that module and DRAM vendors not be mixed in the same server system.

System memory begins at address 0 and is continuous (flat addressing) up to the maximum amount of DRAM installed (exception: system memory is noncontiguous in the ranges defined as memory holes using configuration registers). The server board supports both base (conventional) and extended memory.

2.4 PCI I/O Subsystem

The expansion capabilities of the STL2 server board meet the needs of file and application servers for high performance I/O by providing two PCI bus segments in the form of one 64-bit / 66 MHz bus segment and one 32-bit / 33 MHz bus segment. Each of the PCI buses comply with Revision 2.2 of the *PCI Local Bus Specification*.

2.4.1 64-bit / 66 MHz PCI Subsystem

The 64-bit, 66 MHz, 3.3V keyed PCI segment includes the following embedded devices and connectors:

- Two 64-bit, 66 MHz, 3.3V keyed PCI expansion slots that can support 66 MHz, 64/32-bit cards or 33 MHz, 64/32-bit cards.
- Integrated Adaptec AIC-7899 PCI dual-port SCSI controller providing separate Ultra160 and Ultra Wide SCSI channels

64-bit PCI features include:

- Bus speed up to 66 MHz
- 3.3 V signaling environment
- Burst transfers up to a peak of 528 Megabytes per second (MBps)
- 8-, 16-, 32-, or 64-bit data transfers
- Plug-and-Play ready
- Parity enabled

Note: If a 33 MHz PCI board is installed into one of the 64-bit PCI slots, the bus speed for the 66 MHz PCI slots and SCSI controller is decreased to 33 MHz.

2.4.1.1 Ultra160 / Ultra WideSCSI Controller

The STL2 server board includes an Adaptec AIC7899. This is an embedded dual-function, PCI SCSI host adapter on the 64-bit/66 MHz PCI bus. The AIC7899 contains two independent SCSI controllers that share a single PCI bus master interface as a multi-function device. Internally, each controller is identical, capable of operations using either 16-bit SE or LVD SCSI providing 40 MBps (Ultra-wide SE) or 160 MBps (Ultra160). The STL2 server board provides the ability to disable the embedded Ultra160 SCSI Controller in the BIOS Setup option. When disabled, it will not be visible to the operating system.

Table 2-2. SCSI Transfer Speeds

SCSI Port	Asynchronous	Fast-5	Fast-10	Fast-20	Fast-40	Fast-80/Ultra160
SE	Yes	yes	yes	yes	no	no
LVD	Yes	yes	yes	yes	yes	yes

In the STL2 server board implementation, channel A provides a 68-pin, 16-bit LVD Ultra160 SCSI interface. Channel B provides a 68-pin, 16-bit Single Ended Ultra Wide SCSI interface. Each controller has its own set of PCI configuration registers and SCSI I/O registers. As a PCI 2.1/2.2 bus master, the AIC-7899 supports burst data transfers on PCI up to the maximum rate of 133 MBps using on-chip buffers.

Refer to the *AIC-7899 PCI-Dual Channel SCSI Multi-Function Controller Data Manual* for more information on the internal operation of this device and for descriptions of SCSI I/O registers.

2.4.1.1.1 AIC-7899 Supported PCI Commands

The AIC-7899 supports PCI commands as shown in the following table:

Table 2-3. Embedded SCSI Supported PCI Commands

C/BE [3::0] _L	Command	AIC-7899 Support	
		Target	Master
0000	Interrupt Acknowledge	No ¹	No
0001	Special Cycle	No ¹	No
0010	I/O Read	Yes ²	No
0011	I/O Write	Yes ²	No
0100	Reserved	No ¹	No
0101	Reserved	No ¹	No
0110	Memory Read	Yes ^{2,3}	Yes ⁴
0111	Memory Write	Yes ²	Yes ⁴
1000	Reserved	No ¹	No
1001	Reserved	No ¹	No
1010	Configuration Read	Yes	No
1011	Configuration Write	Yes	No
1100	Memory Read Multiple	Yes ⁵	Yes ⁴
1101	Dual Address Cycle	Yes ⁶	Yes
1110	Memory Read Line	Yes ⁵	Yes ⁴
1111	Memory Write and Invalidate	Yes ⁷	Yes

Notes:

1. Ignored after checking address parity.
2. Support for 8-bit transfers only for all registers in its device register space.
3. Support for 32-bit transfers only for the external ROM/ EEPROM.
4. Support for transfers from system memory.
5. Defaults to Memory Read.
6. Will respond to DAC if PCI Address matches the MBAR[63:12].

7. Defaults to Memory Write.

The extensions to memory commands (memory read multiple, memory read line, and memory write and invalidate) work with the cache line size register to give the cache controller advance knowledge of the minimum amount of data to expect. The decision to use either the memory read line or memory read multiple commands is determined by a bit in the configuration space command register for this device.

2.4.1.1.2 SCSI Bus

The SCSI data bus is 8 or 16 bits wide with odd parity generated per byte. SCSI control signals are the same for either bus width. To accommodate 8-bit devices on the 16-bit Wide SCSI connector, the AIC-7899 assigns the highest arbitration priority to the low byte of the 16-bit word. This way, 16-bit targets can be mixed with 8-bit if the 8-bit devices are placed on the low data byte. For 8-bit mode, the unused high data byte is self-terminated and does not need to be connected. During chip power-down, all inputs are disabled to reduce power consumption.

2.4.2 32-bit/33 MHz PCI Subsystem

The 32-bit, 33 MHz, 5V keyed PCI includes the following embedded devices and connectors:

- Four 32-bit, 33 MHz, 5V keyed PCI expansion slots
- Integrated Intel® EtherExpress™ PRO100+ 10/100 megabit PCI Ethernet controller (Intel® 82559)
- Integrated ATI Rage* IIC video controller with 4 MB of on-board SGRAM
- IB6566 South Bridge I/O APIC, PCI-to-ISA bridge, IDE controller, USB controller, and power management.

32-bit PCI features include:

- Bus speed up to 33 MHz
- 5 V signaling environment
- Burst transfers up to a peak of 132 MBps
- 8-, 16-, or 32-bit data transfers
- Plug-and-Play ready
- Parity enabled

2.4.2.1 Network Interface Controller (NIC)

The STL2 server board includes a 10Base-T / 100Base-TX network controller that is based on the Intel® 82559 Fast Ethernet PCI Bus Controller. This device is similar in architecture to its predecessor (Intel® 82558). No external devices are required to implement an embedded network subsystem, other than TX/RX magnetics, two status LEDs, and a connector.

Status LEDs are not included on the external NIC connector, but there is a jumper head (6A) where status LEDs may be connected. The STL2 server board provides the ability to disable the embedded NIC in the BIOS Setup option. When disabled it is not visible to the operating system.

The 82559 is a highly integrated PCI LAN controller for 10 or 100 Mbps Fast Ethernet networks. As a PCI bus master, the 82559 can burst data at up to 132 MBps. This high-performance bus master interface can eliminate the intermediate copy step in RX/TX frame copies, resulting in faster frame processing.

The network OS communicates with the 82559 using a memory-mapped I/O interface, PCI interrupt connected directly to the ICH, and two large receive and transmit FIFOs. The receive and transmit FIFOs prevent data overruns or underruns while waiting for access to the PCI bus, and also enable back-to-back frame transmission within the minimum 960ns inter-frame spacing. The figure below shows the PCI signals supported by the 82559:

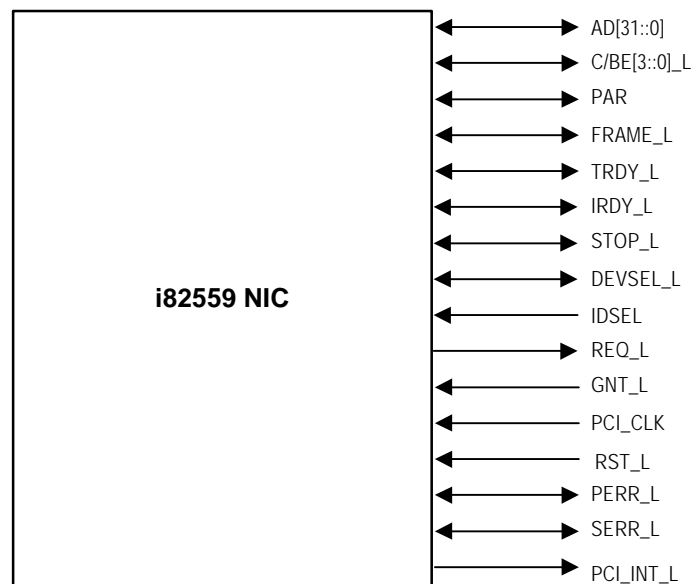

Figure 2-1. Embedded NIC PCI Signals

2.4.2.1.1 Supported Network Features

The 82559 contains an IEEE MII compliant interface to the components necessary to implement an IEEE 802.3 100Base TX network connection. The STL2 supports the following features of the 82559 controller:

- Glueless 32-bit PCI Bus Master Interface (Direct Drive of Bus), compatible with PCI Bus Specification, revision 2.1 / 2.2.
- Chained memory structure, with improved dynamic transmit chaining for enhanced performance.
- Programmable transmit threshold for improved bus utilization.
- Early receive interrupt for concurrent processing of receive data.
- On-chip counters for network management.
- Autodetect and autoswitching for 10 or 100 Mbps network speeds.
- Support for both 10 Mbps and 100 Mbps networks, full or half duplex-capable, with back-to-back transmit at 100 Mbps.

- Integrated physical interface to TX magnetics.
- The magnetics component terminates the 100Base-TX connector interface. A flash device stores the network ID.
- Support for Wake-on-LAN (WOL).

2.4.2.2 Video Controller

The STL2 server board includes an ATI Rage IIC video controller, 4 MB video SGRAM, and support circuitry for an embedded SVGA video subsystem. The Rage IIC, 64-bit VGA Graphics Accelerator contains a SVGA video controller, clock generator, BitBLT engine, and RAMDAC. Two 512K x 32 SGRAM chips provide 4 MB of 10ns video memory.

The SVGA subsystem supports a variety of modes: up to 1280 X 1024 resolution, and up to 16.7 Million colors. It also supports analog VGA monitors, single- and multi-frequency, interlaced and non-interlaced, up to 100 Hz vertical refresh frequency. The STL2 server board provides a standard 15-pin VGA connector, and external video blanking logic for server management console redirection support.

2.4.2.2.1 Video Controller PCI Signals

The Rage IIC supports a minimal set of 32-bit PCI signals because it never acts as a PCI master. As a PCI slave, the device requires no arbitration or interrupts.

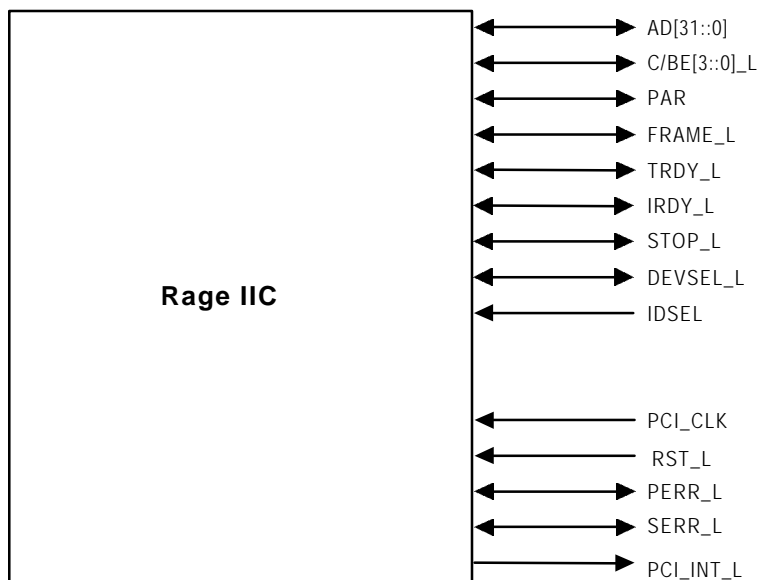

Figure 2-2. Video Controller PCI Signals

2.4.2.2.2 Video Controller PCI Commands

The Rage IIC supports the following PCI commands:

Table 2-4. Video Controller Supported PCI Commands

C/BE[3::0]_L	Command Type	Rage IIC Support	
		Target	Master
0000	Interrupt Acknowledge	No	No
0001	Special Cycle	No	No
0010	I/O Read	Yes	No
0011	I/O Write	Yes	No
0100	Reserved	No	No
0101	Reserved	No	No
0110	Memory Read	Yes	No
0111	Memory Write	Yes	No
1000	Reserved	No	No
1001	Reserved	No	No
1010	Configuration Read	Yes	No
1011	Configuration Write	Yes	No
1100	Memory Read Multiple	No	No
1101	Dual Address Cycle	No	No
1110	Memory Read Line	No	No
1111	Memory Write and Invalidate	No	No

2.4.2.2.3 Video Modes

The Rage IIC supports all standard IBM VGA modes. The following tables show the standard resolutions that this implementation supports, including the number of colors and the refresh rate.

Table 2-5. Standard VGA Modes

Resolution	Refresh Rate (Hz)	Colors
640x480	200	256
800x600	200	256
1024x768	150	256
1152x864	120	256
1280x1024	100	256
1600x1200	76	256
640x480	200	65K
800x600	200	65K
1024x768	150	65K
1152x864	120	65K
640x480	200	16.7M
800x600	160	16.7M

2.4.2.3 IB6566 South Bridge

The IB6566 South Bridge is a PCI device that provides multiple PCI functions in a single package: PCI-to-ISA bridge, PCI IDE interface, PCI USB controller, and power management controller. Each function within the IB6566 South Bridge has its own set of configuration registers. Once configured, each appears to the system as a distinct hardware controller sharing the same PCI bus interface.

On the STL2 baseboard, the primary role of the IB6566 South Bridge is to provide the gateway to all PC-compatible I/O devices and features. The STL2 server board uses the following IB6566 South Bridge features:

- PCI interface
- IDE interface
- USB interface
- PC-compatible timer/counters and DMA controllers
- Baseboard Plug-and-Play support
- General purpose I/O
- Power management
- APIC and 82C59 interrupt controller
- Host interface for AT compatible signaling
- Internal only ISA bus (no ISA expansion connectors) bridge for communication with Super I/O, BIOS flash and BMC

The following sections describe each supported feature as used on the STL2 server board.

2.4.2.3.1 PCI Interface

The IB6566 South Bridge fully implements a 32-bit PCI master/slave interface, in accordance with Revision 2.2 of the *PCI Local Bus Specification*. On the STL2 server board, the PCI interface operates at 33 MHz, using the 5V-signaling environment.

2.4.2.3.2 PCI Bus Master IDE Interface

The IB6566 South Bridge acts as a PCI-based enhanced IDE 32-bit interface controller for intelligent disk drives that have disk controller electronics on-board. The server board includes a single IDE connector, featuring 40 pins (2 x 20) that support a master and a slave device. The IDE controller provides support for an internally mounted CD-ROM.

The IDE controller has the following features:

- PIO and DMA transfer modes
- Mode 4 timings
- Transfer rates up to 33 MBps
- Buffering for PCI/IDE burst transfers
- Master/slave IDE mode
- Support for up to two devices

2.4.2.3.3 **USB Interface**

The IB6566 South Bridge contains a USB controller and USB hub. The USB controller moves data between main memory and the two USB connectors provided.

The STL2 server board provides a dual external USB connector interface. Both ports function identically and with the same bandwidth. The external connector is defined by Revision 1.0 of the *USB Specification*.

2.4.2.4 **Compatibility Interrupt Control**

The IB6566 South Bridge provides the functionality of two 82C59 Programmable Interrupt Controller (PIC) devices, for ISA-compatible interrupt handling.

2.4.2.5 **APIC**

The IB6566 South Bridge integrates a 16-entry I/O APIC that is used to distribute 16 PCI interrupts. It also includes an additional 16-entry I/O APIC for distribution of legacy ISA interrupts.

2.4.2.6 **Power Management**

One of the embedded functions of IB6566 South Bridge is a power management controller. The STL2 server board uses this to implement ACPI-compliant power management features. STL2 supports sleep states s0, s1, s4, and s5.

2.5 **Chipset Support Components**

2.5.1 **Legacy I/O (Super I/O) National* PC97317VUL**

The National* PC97317VUL Super I/O Plug-and-Play Compatible with ACPI-Compliant Controller/Extender is used on the STL2 server board. This device provides the system with:

- Real-time Clock (RTC)
- Two serial ports
- One parallel port
- Floppy disk controller (FDC)
- PS/2-compatible keyboard and mouse controller
- General purpose I/O pins
- Plug-and-Play functions
- A power management controller

The STL2 server board provides the connector interface for the floppy, dual serial ports, parallel port, PS/2 mouse and the PS/2 keyboard. Upon reset, the SIO reads the values on strapping pins to determine the boot-up address configuration.

2.5.1.1 Serial Ports

Two 9-pin connectors in D-Sub housing are provided for serial port A and serial port B. Both ports are compatible with 16550A and 16450 modes, and both are re-locatable. Each serial port can be set to one of four different COM-x ports, and each can be enabled separately. When enabled, each port can be programmed to generate edge- or level-sensitive interrupts. When disabled, serial port interrupts are available to add-in cards.

2.5.1.2 Parallel Port

The STL2 baseboard provides a 25-pin parallel port connector. The SIO provides an IEEE 1284-compliant 25-pin bi-directional parallel port. BIOS programming of the SIO registers enables the parallel port and determines the port address and interrupt. When disabled, the interrupt is available to add-in cards.

2.5.1.3 Floppy Port

The FDC in the SIO is functionally compatible with floppy disk controllers CMOS 765B and 82077AA. The baseboard provides the 24- MHz clock, termination resistors, and chip selects. All other FDC functions are integrated into the SIO, including analog data separator and 16-byte FIFO.

2.5.1.4 Keyboard and Mouse Connectors

The keyboard controller is functionally compatible with the 8042A. The keyboard and mouse connectors are PS/2-compatible.

2.5.1.5 Real-time Clock

The PC97317VUL contains an MC146818-compatible real-time clock with external battery backup. The device also contains 242 bytes of general purpose battery-backed CMOS RAM. The real-time clock provides system clock and calendar information stored in non-volatile memory.

2.5.1.6 Plug-and-Play Functions / ISA Data Transfers

The PC97317VUL contains all signals for ISA compatible interrupts and DMA channels. It also provides ISA control, data, and address signals to transfer data to/from the BMC and the BIOS flash device. This ISA subsystem transfers all SIO peripheral control data to the IB6566 South Bridge as well.

2.5.1.7 Power Management Controller

The PC97317VUL component contains functionality that allows various events to allow the power-on and power-off of the system. This can be from PCI Power Management Events, the BMC, or the front panel. This circuitry is powered from stand-by voltage, which is present anytime the system is plugged into the AC outlet.

2.5.2 BIOS Flash

The STL2 baseboard incorporates an Intel® 5V FlashFile™ 28F008SA Flash Memory component. The 28F008SA is a high-performance 8 Mbit memory that is organized as 1 MB of 8 bits each. There are 16 64-KB blocks.

The 8-bit flash memory provides 1024K x 8 of BIOS and nonvolatile storage space. The flash device is directly addressed as 8-bit ISA memory. For more information, see the *5 Volt FlashFile™ Memory (28F008SA x8) Datasheet*.

2.5.3 External Device Connectors

The external I/O connectors provide support for a PS/2 compatible mouse and keyboard, an SVGA monitor, two serial port connectors, a parallel port connector, a LAN port, and two USB connections.

2.6 Interrupt Routing

The STL2 server board interrupt architecture implements two I/O APICs and two PICs through the use of the integrated components in the IB6566 South Bridge component. The STL2 server board interrupt architecture allows first and second PCI interrupts to be mapped to compatible interrupt through the PCI Interrupt Address Index Register (I/O Address 0C00h) in the IB6566 South Bridge.

The STL2 server board supports three interrupt modes:

- PIC Mode
- Virtual Wire Mode
- Symmetric Mode

The IB6566 South Bridge uses integrated logic to map 16 PCI interrupts to EISA/ISA. In default or Extended APIC configurations, each PCI interrupt can be independently routed to one of the 11 EISA interrupts. The interrupt mapping logic for PCI interrupts is disabled when the make bit in the corresponding I/O APIC redirection table entry is disabled (clear). This interrupt routing mechanism allows a clean transition from PIC mode to an APIC during operating system boot.

2.6.1 Default I/O APIC

The IB6566 South Bridge integrates a 16-entry I/O APIC which is used to distribute 16 PCI interrupts.

2.6.2 Extended I/O APIC

An additional 16-entry I/O APIC is integrated in the IB6566 South Bridge to distribute EISA/ISA interrupts. This additional I/O APIC is enabled only when the IB6566 South Bridge is configured to the Extended APIC configuration.

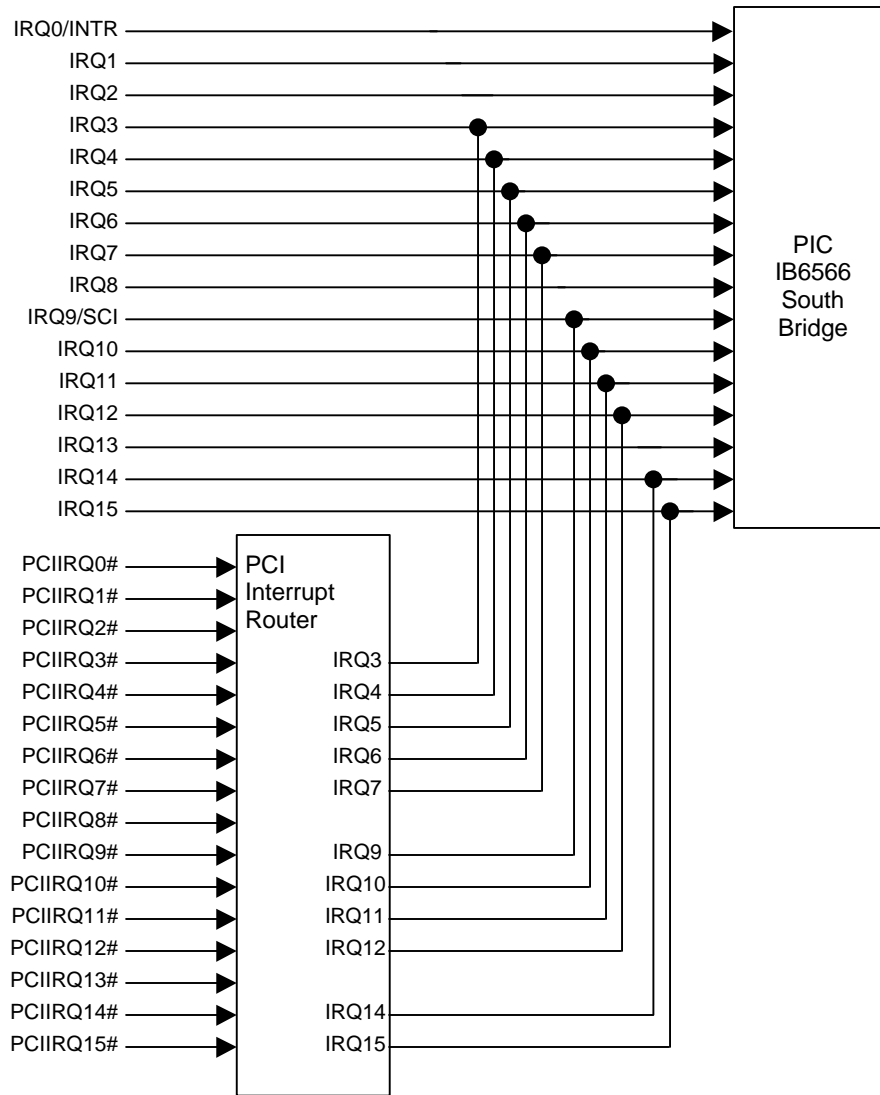

Figure 2-3. STL2 Baseboard Interrupt Routing Diagram (PIC mode)

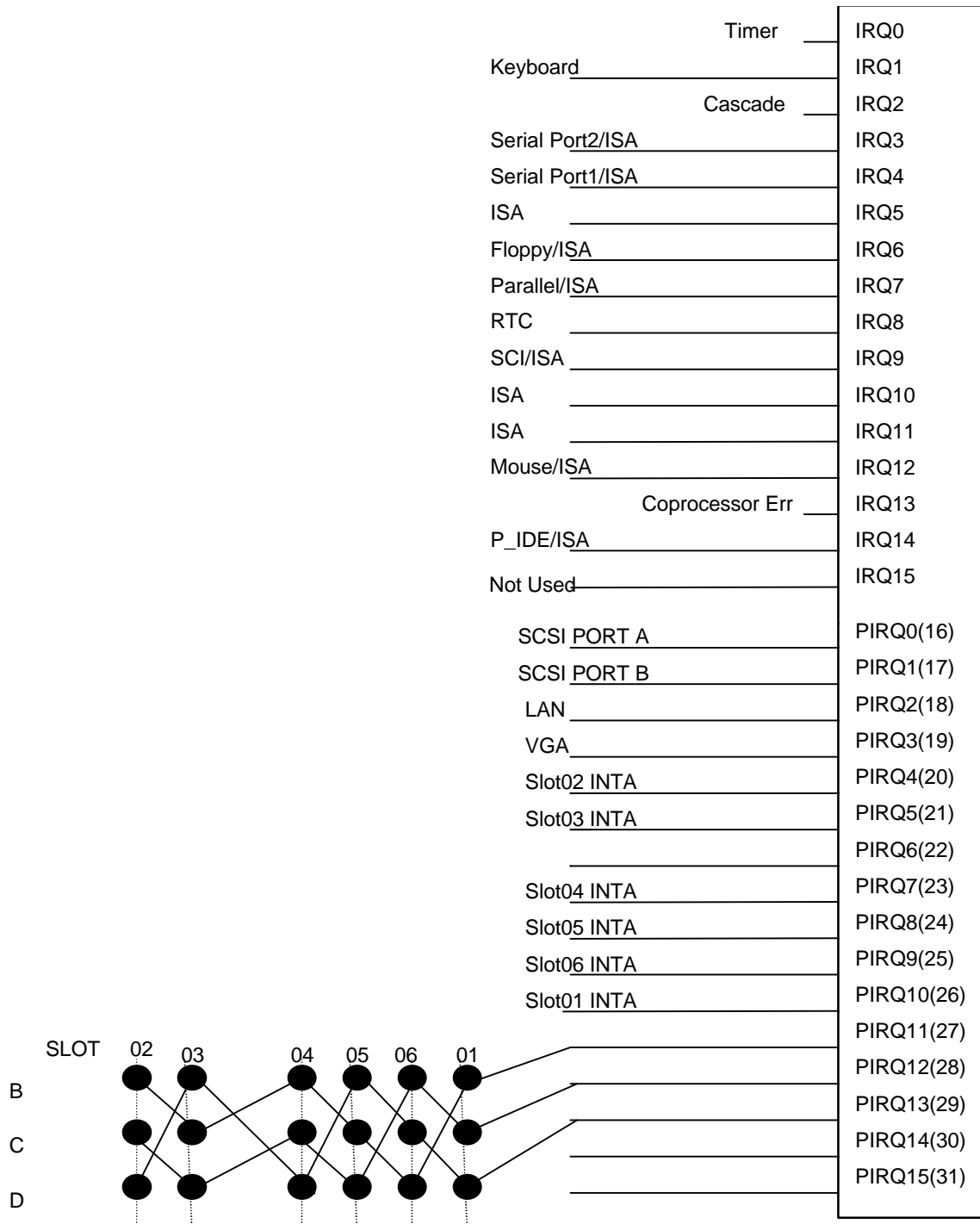

Figure 2-4. STL2 Baseboard Interrupt Routing Diagram (Symmetric mode)

2.6.3 PCI Ids

The STL2 server board PCI Ids are defined as follows:

Table 2-6. STL2 PCI IDs

Device	Bus Number [23:16]	Device Number [15:11]	Slot ID Signal
NB6635 North Bridge 3.0LE	00h	00000b	
ATI* Rage IIC	00h	00010b	P32_AD18
Intel 82559	00h	00011b	P32_AD19
Adaptec* AIC-7899	00h	00100b	P32_AD20
Slot 1 (32 bit)	00h	00110b	P32_AD22
Slot 2 (32 bit)	00h	00111b	P32_AD23
Slot 2 (32 bit)	00h	01000b	P32_AD24
Slot 2 (32 bit)	00h	01001b	P32_AD25
IB6566 South Bridge	00h	01111b	P32_AD31
Slot 2 (32 bit)	00h	01010b	P32_AD26
Slot 2 (32 bit)	00h	01011b	P32_AD27

Note:

Do not change the BUSNUM register (Offset 44h) in the NB6635 North Bridge 3.0LE from the default value.

2.6.4 Relationship between PCI IRQ and PCI Device

The relationship between PCI IRQ and PCI devices are defined as follows on the STL2 server board:

PCI IRQ	PCI Device
PCI IRQ 0	Adaptec AIC-7899 SCSI Channel A
PCI IRQ 1	Adaptec AIC-7899 SCSI Channel B
PCI IRQ 2	Intel 82559
PCI IRQ 3	ATI Rage IIC
PCI IRQ 4	PCI Slot 2 (INTA)
PCI IRQ 5	PCI Slot 3 (INTA)
PCI IRQ 6	Not Used
PCI IRQ 7	PCI Slot 4 (INTA)
PCI IRQ 8	PCI Slot 5 (INTA)
PCI IRQ 9	PCI Slot 6 (INTA)
PCI IRQ 10	PCI Slot 1 (INTA)
PCI IRQ 11	PCI Slot 1 (INTB), PCI Slot 2 (INTB), PCI Slot 3 (INTC), PCI Slot 4 (INTB), PCI Slot 5 (INTC), PCI Slot 6 (INTD)
PCI IRQ 12	PCI Slot 1 (INTC), PCI Slot 2 (INTC), PCI Slot 3 (INTD), PCI Slot 4 (INTC), PCI Slot 5 (INTD), PCI Slot 6 (INTB)
PCI IRQ 13	PCI Slot 1 (INTD), PCI Slot 2 (INTD), PCI Slot 3 (INTB), PCI Slot 4 (INTC), PCI Slot 5 (INTD), PCI Slot 6 (INTB)

3. Server Management

This section describes the features of the server management subsystem for the STL2 server board. The server management subsystem consists of the BIOS, hardware, and firmware features built into the server board. These features provide hardware monitoring, control, and logging to improve the reliability, availability, and serviceability of the server system.

The server management subsystem conforms to the IPMI (Intelligent Platform Management Interface) v1.0 specification. IPMI defines a standardized, abstracted, message-based interface between system management software and the platform management hardware.

The following comprise the major elements of the server management architecture for the STL2 server board.

- Baseboard Management Controller (BMC)
- Sensors
- Sensor Data Record (SDR) Repository & System Event Log (SEL)
- Field Replaceable Unit (FRU) Information

3.1 Baseboard Management Controller

The STL2 server management functionality is concentrated in the Baseboard Management Controller (BMC). The BMC is comprised of a Dallas* Semiconductor DS80CH11 (or equivalent) microcontroller and associated circuitry located on the STL2 server board. The BMC and associated circuits are powered from a 5V DC standby voltage, which remains active when system power is switched off, but the AC power source is still on and connected.

A major function of the BMC is to autonomously monitor system management events and log the occurrence in the nonvolatile System Event Log (SEL). The events being monitored include over/under temperature and over/under voltage conditions, fan failure, or chassis intrusion. To enable accurate monitoring, the BMC maintains the nonvolatile Sensor Data Record (SDR) from which sensor information can be retrieved. The BMC provides an ISA host interface to SDR sensor information, so that software running on the server can poll and retrieve the server's current status. The BMC also provides the interface to the monitored information and SEL that System Management Software, such as Intel® Server Control, uses to poll and retrieve the platform status.

The BMC performs the following functions:

- Monitors server board temperature and voltage
- Monitors processor presence and controls Fault Resilient Boot (FRB)
- Detects and indicates baseboard fan failure
- Manages the SEL interface
- Manages the SDR Repository interface
- Monitors the SDR/SEL timestamp clock
- Monitors the system management watchdog timer
- Monitors the periodic SMI timer

- Monitors the event receiver
- Controls secure mode, including video blinding, diskette write-protect monitoring, and front panel lock/unlock initiation
- Controls Wake-on-Lan via Magic Packet* support

3.2 Hardware Sensors

The following table lists the hardware sensors present on the STL2 server board.

Sensor Number	Sensor Type	Monitoring Device
01h	Temperature	ADM1024 Temperature
02h		Processor 1 internal
03h		Processor 2 internal
20h	Voltage	3.3V
21h		5V
22h		12V
23h		3.3V Standby
24h		Processor 1
25h		Processor 2
29h		1.5V
2Ah		2.5V
2Ch		SCSI-A 2.85V
2Dh		SCSI-B 2.85V
2Eh		SCSI-A Vref1
2Fh		SCSI-A Vref2
30h		SCSI-A Vref3
31h		SCSI-B Vref1
32h		SCSI-B Vref2
33h		SCSI-B Vref3
34h	Voltage (Discrete)	Performance Lags
40h	Fan	Baseboard Fan 1
41h		Baseboard Fan 2
42h		Baseboard Fan 3
60h	Processor	Processor 1 State
61h		Processor 2 State
70h	Power Distribution Board	Soft Power Control Failure (bit 5) Interlock Power
71h	Power Distribution Board Supply 1	Power supply Failure detected (bit 1)
72h	Power Distribution Board Supply 2	Power supply Failure detected (bit 1)
7Fh	Power Redundancy Lost	Redundancy Lost (bit 1) Redundancy Regained (bit 0)
90h	Chassis Intrusion ID	Drive Bay Intrusion (bit 1) LAN Leash Lost (bit 4)
91h	Security Violation	Secure Mode Violation Attempt (bit 0)
92h	Memory Error	ECC multiple bit error (bit 1) ECC single bit error (bit 0)
93h	POST Memory Resize	

Sensor Number	Sensor Type	Monitoring Device
94h	BIOS POST (Error) Code	
95h	Log Disable	Log Area Reset / Cleared (bit 2) ECC single bit Error Disable (bit 0)
96h	System Event	OEM System Event (Hard Reset) (bit 1) System
97h	Critical Interrupt	PCI SERR (bit 5) PCI PERR (bit 4) Front Panel NMI (Dump SW) (bit 0)
98h	Button	Reset Button (bit 2) Sleep Button (bit 1) Power Button (bit 0)
99h	No Processor or Termination Board	
9Ah	Boot Init	User requested PXE boot (bit 3) Initiated by power up (bit 0)
9Bh	Boot Error	PXE Server not found (bit 2) No bootable media (bit 0)
9Ch	OS Boot	
9Dh	OS Stop	
9Eh	ACPI State	Sleeping in S1 state (bit 8) G3/Mechanical Off (bit 7) S5 / G2 Soft Off (bit 5) S4 (bit 4)
A0h	BMC Watchdog	BMC WDT Timeout
C0h	Chassis Intrusion ID (Disable)	Processor Area Intrusion (bit 4)
C1h	Chassis Intrusion ID	Drive Bay Intrusion (bit 1)
F3h	SMI State	SMI Stall State

The following table provides a list of System Event Log (SEL) events supported by the STL2 server board.

Sensor Type	Sensor Type Code	Sensor-Specific Offset	Event	Remarks
Reserved	00h	–	Reserved	
Temperature	01h	–	Temperature	An error occurred at thermal sensors
Voltage	02h	–	Voltage	An error occurred at voltage sensors
		01h	Performance Lags	In the single-end event mode, even if SCSI is available for a different mode event.
Fan	04h	–	Fan	An error occurred at fan sensors.
Physical Security	05h	01h	Drive Bay Intrusion	Front cover has been opened or closed
		03h	Processor area intrusion	Side (Chassis) cover has been opened or closed.
		04h	LAN Connection Lost	
(System has been unplugged from LAN)	LAN cable has been plugged in or unplugged.			

Sensor Type	Sensor Type Code	Sensor-Specific Offset	Event	Remarks
Platform Security Violation Attempt	06h	00h	Secured Mode Violation Attempt	Power/sleep switch has been activated while in Secure Mode
		03h	Pre-boot Password Violation (network boot Password)	Bad Password at PXE Boot
Processor	07h	00h	IERR	CPU IERR has occurred
		01h	Thermal Trip	CPU Thermal Trip has occurred
		02h	FRB1/BIST Failure	BIST Error has occurred
		04h	FRB3/Processor Startup/Initialization failure (CPU didn't start)	FRB3 Timeout has been detected
		08h	Processor disabled	A processor has been Disabled
Memory	0Ch	00h	Correctable ECC	ECC 1-bit error occurred
		01h	Uncorrectable ECC	ECC 2-bit error occurred
POST Memory Resize	0Eh		POST Memory Resize	Displays the total amount of memory after memory failure
POST Error	0Fh		POST Error	POST Error occurred
Event Logging Disabled	10h	00h	Correctable Memory Error Logging Disabled	Displays ECC single bit error monitoring disabled
		01h	Event 'Type' Logging Disabled	Monitoring of a certain event type has been disabled
		02h	Log Area Reset/Cleared	Displays the SEL area cleared.
		03h	All Event Logging Disabled	Monitor for the entire BMC has been disabled.
System Event	12h	00h	System Reconfigured	Setup change has occurred
		01h	OEM System Boot Event (Hard Reset)	Cold reset has been issued
Critical Interrupt	13h	00h	Front Panel NMI Dump Switch	Dump switch has been activated
		02h	I/O channel check NMI	ISA I/O Check has occurred.
		04h	PCI SERR	PCI SERR occurred
		05h	PCI PERR	PCI PERR occurred
Button	14h	00h	Power Button	Power switch has been activated
		01h	Sleep Button	Sleep switch has been activated
		02h	Reset Button	Reset switch has been activated
Module / Board	15h		CPU / Terminator Missing	CPU / Terminator is not mounted correctly
System Boot Initiated	1Dh	03h	User requested PXE boot	PXE (Network) Booted
		04h	Automatic boot to diagnostic	When the maintenance Utility Booted
Boot Error	1Eh	00h	No bootable media	Boot Media does not exist.
		02h	PXE Server not found	PXE Server is not found
		00h	C: boot completed	ESM Pro installed OS has been booted
		02h	PXE boot completed	PXE boot for the express server is finished (not supported)
		03h	Diagnostic boot completed	Maintenance Utility has been booted (not supported)

Sensor Type	Sensor Type Code	Sensor-Specific Offset	Event	Remarks
		04h	CD-ROM boot completed	The server has been booted (not supported)
OS Critical Stop	20h	00h	Stop during OS load / Initialization	OS stalled during startup
		01h	Run-time Stop	OS stalled during startup
System ACPI Power State	22h	00h	S0 / G0 Working	DC is ON
		01h	S1 "sleeping with system H/W & processor context Maintained"	S1 Sleep State
		04h	S4 "non-volatile sleep / suspend-to disk"	S4 Sleep State
		05h	S5 / G2 "soft-off"	DC is OFF
		07h	G3 / Mechanical Off	AC is OFF
		08h	Sleeping (cannot differentiate between S1-S3)	SUSC# OS has been asserted without the instruction to sleep
Watchdog 2	23h	01h	Hard Reset	POST/Boot monitor timed out
		02h	Power Down	OS WDT shut down after the monitor timeout
		08h	Timer Interrupt	OS WDT monitor timed out
SMI Timeout	F3h		SMI Timeout	SMI# has been asserted for more than ten seconds
EMP	F5h	00h	Communication Error	Communication is unavailable even though the BMC is in communication status
Sensor Failure	F6h	00h	I ² C Bus Device Address Not Acknowledged	SMBus Device does not answer.
		01h	I ² C Bus Device Error Detected	Other access errors
		02h	I ² C Bus Timeout	SMBus Timeout error
OEM Reserved	F7h - FFh			

3.3 ACPI

The Advance Configuration and Power Interface (ACPI)-aware operating system can place the system into a state where the hard drives spin down, the system fans stop, and all processing is halted. In this state the power supply is still on and the processors still dissipate some power, such that the power supply fan and processor fans are still running.

Note: ACPI requires an operating system that supports this feature.

The ACPI sleep states discussed below are defined as:

- s0: Normal running state
- s1: Processor sleep state. No content is lost in this state and the processor caches maintain coherency.

- s4: Hibernate or Save to Disk. The memory and machine state are saved to disk. Pressing the power button or another wakeup event restores the system state from the disk and resumes normal operation. This assumes that no hardware changes were made to the system while it was off.
- s5: Soft off. Only the RTC section of the chip set and the BMC are running in this state.

The STL2 server board supports sleep states s0, s1, s4, and s5. When the server board is operating in ACPI mode, the OS retains control of the system and the OS policy determines the entry methods and wake up sources for each sleep state – sleep entry and wake up event capabilities are provided by the hardware but are enabled by the OS.

With future versions of Microsoft* Windows* 9X that support ACPI, the system BIOS supports only sleep states s0, s1, and s5. With future versions of Microsoft Windows NT* that support ACPI, the system BIOS will support sleep states s0, s1, s4, and s5.

3.4 AC Link Mode

The AC link mode allows the system to monitor its AC input power so that if AC input power is lost and then restored, the system returns to one of the following preselected settings:

- Power On
- Last State (Factory Default Setting)
- Stay Off

The AC link mode settings can be changed by running the BIOS Setup Utility.

3.5 Wake On LAN Function

The remote power-on function turns on the system power by way of a network or modem. If the system power is set to Off, it can be turned on remotely by sending a specific packet from the main computer to the remote system.

Note: The standard default value of the remote power-on function is “Disabled”. The Wake-on-LAN / Ring function can be changed by setting the option to “Enabled” in the BIOS Setup Utility.

4. Basic Input Output System (BIOS)

This section describes BIOS embedded software for the STL2 board set. The BIOS contains standard PC-compatible basic input/output (I/O) services, standard Intel® server features, plus the STL2 system-specific hardware configuration routines and register default settings, embedded in Flash read-only memory (ROM). This section also describes BIOS support utilities (not ROM-resident) that are required for system configuration and flash ROM update.

The BIOS is implemented as firmware that resides in the flash ROM. Support for applicable baseboard peripheral devices (SCSI, NIC, and video adapters), which is also loaded into the baseboard flash ROM, is not specified in this document. Hooks are provided to support adding BIOS code for these adapters; the binaries must be obtained from the peripheral device manufacturers and loaded into the appropriate locations.

4.1 BIOS Overview

The term BIOS, as used in the context of this section, refers to the system BIOS, the BIOS Setup and option ROMs for on-board peripheral devices that are contained in the system flash. System BIOS controls basic system functionality using stored configuration values. The terms flash ROM, system flash, and BIOS flash may be used interchangeably in this section.

The term BIOS Setup refers to the flash ROM-resident setup utility that provides the user with control of configuration values stored in battery-backed CMOS configuration RAM. The System Setup Utility (SSU), which also provides this functionality, is discussed in a separate document. BIOS Setup is closely tied with the system BIOS and is considered a part of BIOS.

Phoenix Pflash* (PHLASH.EXE) is used to load predefined areas of flash ROM with Setup, BIOS, and other code/data.

The following is the break-down of the STL2 product ID string:

- 4 byte board ID, 'STL2'
- 1 byte board revision, starting from '0'
- 3 byte OEM ID, '86B' for standard BIOS
- 4 byte build number
- 1-3 byte describing build type (D for development, A for Alpha, B for Beta, Pxx for production version xx)
- 6 byte build date in yymmdd format
- 4 bytes time in hhmm format

4.1.1 System BIOS

The system BIOS is the core of the flash ROM-resident portion of the BIOS. The system BIOS provides standard PC-BIOS services and support for some new industry standards, such as the *Advanced Configuration and Power Interface Specification*, Revision 1.0 and *Wired For Management Baseline Specification*, Revision 2.0. In addition, the system BIOS supports certain features that are common across all the Intel servers. These include:

- Security
- MPS support
- Server management and error handling
- CMOS configuration RAM management
- OEM customization
- PCI and Plug and Play (PnP) BIOS interface
- Console redirection
- Resource allocation support

BIOS setup is embedded in flash ROM and provides the means to configure on-board hardware devices and add-in cards. For more information, refer to Section 4.2, Setup Utility.

4.1.2 Flash Update Utility

The system BIOS and the setup utility are resident in partitioned flash ROM. The device is in-circuit reprogrammable. On the STL2 platform, 1 MB of flash ROM is provided. The STL2 BIOS does not support a SecureBIOS feature like some server products from Intel. This is because the addition of SecureBIOS increases boot time, and complexities, and does not provide compelling benefits for the STL2 platform.

The Phoenix Phlash Utility may be used to reprogram the BIOS operational code located in the flash ROM. A BIOS image is provided on a diskette in the form of a binary file that is read by the Phoenix Phlash Utility. Baseboard revisions may create hardware incompatibilities and may require different BIOS code.

4.1.2.1 System Flash ROM Layout

The flash ROM contains system initialization routines, BIOS strings, BIOS Setup, and run-time support routines. The exact layout is subject to change, as determined by Intel. A 16 KB user block is available for user ROM code and another 128KB block is available for custom logos. The flash ROM also contains compressed initialization code for on-board peripherals such as SCSI, NIC, and video controllers. The BIOS image contains all the BIOS components at appropriate locations. The Phoenix Phlash Utility can be used to reprogram the BIOS operational code areas.

At run time, none of the flash blocks is visible at the aliased addresses below 1 MB due to shadowing. Intel reserves the right to change the flash map without notice.

A 64 KB parameter block in the flash ROM is dedicated to storing configuration data that controls extended system configuration data (ESCD), on-board SCSI configuration, OEM configuration areas, etc. The block is partitioned into separate areas for logically different data.

Application software must use standard advanced programmable interrupts (APIs) to access these areas and may not access the data directly.

4.2 Setup Utility

This section describes the ROM resident setup utility that provides the means to configure the platform. The setup utility is part of the system BIOS and allows limited control over on-board resources such as the parallel port and mouse. The following topics are covered below:

- Setup utility operation
- Configuration CMOS RAM definition
- Function of the CMOS clear jumper

4.2.1 Configuration Utilities Overview

Configuration of on-board devices is done using the setup utility that is embedded in flash ROM. Setup provides sufficient configuration functionality to boot a system diskette or CDROM. The SSU, which is discussed in a separate document, is released on diskette or CDROM. Setup is always provided in flash for basic system configuration.

The configuration utilities modify CMOS RAM and NVRAM under direction of the user. The BIOS POST routines and the BIOS Plug-N-Play Auto-configuration Manager accomplish the actual hardware configuration. The configuration utilities always update a checksum for both areas, so that any potential data corruption is detectable by the BIOS before the hardware configuration takes place. If data is corrupted, the BIOS requests that the user reconfigure the system and reboot.

4.2.2 Setup Utility Operation

The ROM-resident setup utility configures only on-board devices. The setup utility screen is divided into four functional areas. Table 4-1 describes each area:

Table 4-1. Setup Utility Screen

Functional Area	Description
Keyboard Command Bar	Located at the bottom of the screen. This bar displays the keyboard commands supported by the setup utility.
Menu Selection Bar	Located at the top of the screen. Displays the various major menu selections available to the user. The server setup utility major menus are: Main Menu, Advanced Menu, Security Menu, System Menu, Boot Menu, and the Exit Menu.
Options Menu	Each Option Menu occupies the left and center sections of the screen. Each menu contains a set of features. Selecting certain features within a major Option Menu drops you into submenus.
Item Specific Help Screen	Located at the right side of the screen is an item-specific Help screen.

4.2.2.1 Entering Setup Utility

During POST operation, the user is prompted to enter Setup using the F2 function key as follows:

Press <F2> to enter Setup

After the F2 key is pressed, a few seconds might pass before Setup is entered while POST finishes test and initialization functions that must be completed before Setup can be entered. When Setup is entered, the Main Menu options page is displayed.

4.2.2.2 Keyboard Command Bar

The bottom portion of the screen provides a list of commands that are used for navigating the Setup utility. These commands are displayed at all times, for every menu and submenu.

Each Setup menu page contains a number of features. Except those used for informative purposes, each feature is associated with a value field. This field contains user-selectable parameters. Depending on the security option chosen and in effect via password, a menu feature's value can be changeable or not. If a value is cannot be changed due to insufficient security privileges or other reasons, the feature's value field is inaccessible. The Keyboard Command Bar supports the following:

F1 Help

Pressing F1 on any menu invokes the general Help window. This window describes the Setup key legend. The up arrow, down arrow, Page Up, Page Down, Home, and End keys scroll the text in this window.

Enter Execute Command

The Enter key is used to activate submenus when the selected feature is a submenu, or to display a pick list if a selected feature has a value field, or to select a subfield for multi-valued features like time and date. If a pick list is displayed, the Enter key will undo the pick list, and allow another selection in the parent menu.

ESC Exit

The ESC key provides a mechanism for backing out of any field. This key will undo the pressing of the Enter key. When the ESC key is pressed while editing any field or selecting features of a menu, the parent menu is re-entered. When the ESC key is pressed in any submenu, the parent menu is re-entered. When the ESC key is pressed in any major menu, the exit confirmation window is displayed and the user is asked whether changes can be discarded.

↑ Select Item

The up arrow is used to select the previous value in a pick list, or the previous feature in a menu item's option list. The selected item must then be activated by pressing the Enter key.

↓ Select Item

The down arrow is used to select the next value in a menu item's option list, or a value field's pick list. The selected item must then be activated by pressing the Enter key.

← → Select Menu

The left and right arrow keys are used to move between the major menu pages. The keys have no effect if a submenu or pick list is displayed.

F5/- Change Value

The minus key and the F5 function key are used to change the value of the current item to the previous value. These keys scroll through the values in the associated pick list without displaying the full list.

F6/+ Change Value

The plus key and the F6 function key are used to change the value of the current menu item to the next value. These keys scrolls through the values in the associated pick list without displaying the full list. On 106-key Japanese keyboards, the plus key has a different scan code than the plus key on the other keyboard, but it still has the same effect.

F9 Setup Defaults

Pressing the F9 key causes the following to appear:

Setup Confirmation
Load default configuration now? [<u>Yes</u>] [No]

If “Yes” is selected and the Enter key is pressed, all Setup fields are set to their default values. If “No” is selected and the Enter key is pressed, or if the ESC key is pressed, the user is returned to where s/he was before the F9 key was pressed, without affecting any existing values.

F10 Save and Exit

Pressing F10 causes the following message to appear:

Setup Confirmation
Save Configuration changes and exit now? [<u>Yes</u>] [NO]

If “Yes” is selected and the Enter key is pressed, all changes are saved and Setup is exited. If “No” is selected and the Enter key is pressed, or the ESC key is pressed, the user is returned to where s/he was before the F10 key was pressed, without affecting any existing values.

4.2.2.3 Menu Selection Bar

The Menu Selection Bar is located at the top of the screen. It displays the various major menu selections available to the user:

- Main Menu
- Advanced Menu
- Security Menu

- System Menu
- Boot Menu
- Exit Menu

These and associated submenus are described below.

4.2.2.4 Main Menu Selections

The following tables describe the available functions on the Main Menu, and associated submenus. Default values are highlighted.

Table 4-2. Main Menu Selections

Feature	Choices or Display Only	Description	User Setting
System Time	HH:MM:SS	Sets the system time (hour, minutes, seconds, on 24 hour clock).	
System Date	MM/DD/YYYY	Sets the system date (month, day, year).	
Diskette A	1.44 / 1.25 MB 3.5" / Disabled	Selects the diskette type. Note: 1.25 MB, 3.5 inch references a 1024 byte/sector Japanese media format. To support this type of media format requires a 3.5 inch, 3-mode diskette drive.	
Diskette B	1.44 / 1.25 MB 3.5" / Disabled	Selects the diskette type. Note: 1.25 MB, 3.5 inch references a 1024 byte/sector Japanese media format. To support this type of media format requires a 3.5 inch, 3-mode diskette drive.	
Hard Disk Pre-Delay	Disabled 3 Seconds 6 Seconds 9 Seconds 12 Seconds 15 Seconds 21 Seconds 30 Seconds	Delays first access to disk to ensure the disk is initialized by the BIOS before any accesses.	
Primary Master		Displays IDE device selection. Enters submenu if selected.	
Primary Slave		Displays IDE device selection. Enters submenu if selected.	
Processor		Enters Processor Settings submenu if selected.	
Language	English (US) French German Spanish Italian	Selects which language BIOS displays. Note: This feature immediately changes to the language BIOS selected.	

Table 4-3. Primary Master and Slave Adapters Submenu Selections

Feature	Choices or Display Only	Description	User Setting
Type	Auto None CD-ROM ATAPI Removable IDE Removable Other ATAPI User	Select the type of device that is attached to the IDE channel If User is selected, the user will need to enter the parameters of the IDE device (cylinders, heads and sectors).	
Multi-Sector Transfers	Disable 2 Sectors 4 Sectors 8 Sectors 16 Sectors	Specifies the number of sectors that are transferred per block during multiple sector transfers.	
LBA Mode Control	Disabled Enabled	Enable/Disable Logical Block Addressing instead of cylinder, head, sector addressing.	
32 Bit I/O	Disabled Enabled	Enable/Disable 32Bit IDE data transfers	
Transfer Mode	Standard Fast PIO 1 Fast PIO 2 Fast PIO 3 Fast PIO 4 FPIO 3/ DMA 1 FPIO 4 / DMA 2	Select the method of moving data to and from the hard drive. (If Type: Auto is select, optimum transfer mode will be selected)	
Ultra DMA Mode	Disabled Enabled	Enable/Disable Ultra DMA mode (If Type: Auto is select, optimum transfer mode will be selected)	

Table 4-4. Processor Settings Submenu Selections

Feature	Choices or Display Only	Description	User Setting
Processor Speed	XXX	(Display Only). Indicates the processor speed.	
Processor 1 Type	XXX	(Display Only). Indicates the CUID of the installed processor.	
Cache Ram	XXXKB	(Display Only). Indicates the cache RAM size.	
Processor 2 Type	XXX	(Display Only). Indicates the CUID of the installed processor.	
Cache Ram	XXXKB	(Display Only). Indicates the cache RAM size.	
Processor #1 Status	Normal ¹	(Display Only)	
Processor #2 Status	Normal ¹	(Display Only)	
Clear Processor Errors	Press Enter	Clears the processor error information.	
Processor Error Pause	Enabled Disabled	If enabled, the POST operation pauses if a processor error occurs.	
Processor Serial Number	Disabled Enabled	Disables/Enables Processor Serial Number.	

Note:

1. Possible Values: Normal, None, or Error.

4.2.2.5 Advanced Menu Selections

The following tables describe the menu options and associated submenus available on the Advanced Menu. Please note that MPS 1.4 / 1.1 selection is no longer configurable. The BIOS will always build MPS 1.4 tables.

Table 4-5. Advanced Menu Selections

Feature	Choices or Display Only	Description	User Setting
Memory Reconfiguration		Refer to Memory Reconfiguration Submenu.	
Peripheral Configuration		Refer to Peripheral Reconfiguration Submenu.	
PCI Device		Refer to PCI Device Submenu.	
Option ROM		Refer to Option ROM Submenu. It Disables/Enables the Option ROM BIOS on the PCI Bus.	
Numlock		Refer to Numlock Submenu.	
Reset Configuration Data	No Yes	Clears the Extended System Configuration Data if selected.	
Installed O/S	Other PnP O/S	Selects the type of operating system that will be used most.	

Table 4-6. Memory Reconfiguration Submenu Selections

Feature	Choices or Display Only	Description	User Setting
System Memory	XXX KB	(Display Only). Indicates the total capacity of the basic memory.	
Extended Memory	XXXXXX KB	(Display Only). Indicates the total capacity of the extended memory.	
DIMM #1 Status	Normal ¹	(Display Only)	
DIMM #2 Status	Normal ¹	(Display Only)	
DIMM #3 Status	Normal ¹	(Display Only)	
DIMM #4 Status	Normal ¹	(Display Only)	
Clear DIMM Errors	Press Enter	Clears the DIMM group error status information.	
DIMM Error Pause	Enabled Disabled	If enabled, the POST operation pauses if a DIMM error occurs.	

Note:

1. Possible Values: Normal, None, or Error (DIMM Row Error).

Table 4-7. Peripheral Configuration Submenu Selections

Feature	Choices or Display Only	Description	User Setting
Serial Port 1: (COM 1)	Disabled 3F8, IRQ3 3F8, IRQ4 2F8, IRQ3 2F8, IRQ4 3E8, IRQ3 3E8, IRQ4 2E8, IRQ3 2E8, IRQ4 Auto	Disables serial port 1 or selects the base address and interrupt (IRQ) for serial port 1.	
Serial Port 2: (COM 2)	Disabled 3F8, IRQ3 3F8, IRQ4 2F8, IRQ3 2F8, IRQ4 3E8, IRQ3 3E8, IRQ4 2E8, IRQ3 2E8, IRQ4 Auto	Disables serial port 2 or selects the base address and interrupt (IRQ) for serial port 2.	
Parallel Port	Disabled 378, IRQ5 378, IRQ7 278, IRQ5 278, IRQ7 3BC, IRQ5 3BC, IRQ7 Auto	Disables the parallel port or selects the base address and interrupt (IRQ) for the Parallel port.	
Parallel Mode	Output only Bi-directional EPP ECP, DMA1 ECP, DMA3	Selects the parallel port operation mode.	
Diskette Controller	Disabled Enabled	Disables/Enables the floppy disk controller.	
Mouse	Disabled Enabled Auto Detect	<i>Disabled</i> prevents any installed PS/2 mouse from functioning, but frees up IRQ12. <i>Enabled</i> forces the PS/2 mouse port to be enabled regardless if a mouse is present. <i>Auto Detect</i> enables the PS/2 mouse only if present. <i>OS Controlled</i> is displayed if the OS controls the mouse.	
SCSI Controller	Disabled Enabled	Disables/Enables on-board SCSI controller. Frees resources.	
LAN Controller	Disabled Enabled	Disables/Enables on-board LAN controller. Frees resources.	
VGA Controller	Enabled Disabled	Disables/Enables on-board Video controller. Frees resources.	
USB Controller	Disabled Enabled	Enables/Disables on-board USB controller. Frees resources.	

Table 4-8. PCI Device Submenu Selections

Feature	Choices or Display Only	Description	User Setting
PCI IRQ1 through PCI IRQ14	Disabled Auto Select IRQ3 IRQ4 IRQ5 IRQ6 IRQ7 IRQ9 IRQ10 IRQ11 IRQ12	Specify which PIC IRQ a certain PCI IRQ maps to.	

Table 4-9. Option ROM Submenu Selections

Feature	Choices or Display Only	Description	User Setting
Onboard SCSI	Enabled Disabled	Disables/Enables option ROM expansion for the on-board SCSI option ROM. This must be enable if a boot device is connected to the on-board device.	
Onboard LAN	Enabled Disabled	Disables/Enables option ROM expansion for the on-board LAN option ROM.	
PCI Slot 1	Enabled Disabled	Disables/Enables the expansion of the option ROM for devices in PCI slot 1	
PCI Slot 2	Enabled Disabled	Disables/Enables the expansion of the option ROM for devices in PCI slot 2	
PCI Slot 3	Enabled Disabled	Disables/Enables the expansion of the option ROM for devices in PCI slot 3	
PCI Slot 4	Enabled Disabled	Disables/Enables the expansion of the option ROM for devices in PCI slot 4	
PCI Slot 5	Enabled Disabled	Disables/Enables the expansion of the option ROM for devices in PCI slot 5	
PCI Slot 6	Enabled Disabled	Disables/Enables the expansion of the option ROM for devices in PCI slot 6	
PCI Slot 7	Enabled Disabled	Disables/Enables the expansion of the option ROM for devices in PCI slot 7	

Table 4-10. Numlock Submenu Selections

Feature	Choices or Display Only	Description	User Setting
Numlock	Auto On Off	Selects the power-on state for Numlock.	
Key Click	Disabled Enabled	Disables or enables keyclick.	

Feature	Choices or Display Only	Description	User Setting
Keyboard Auto-repeat Rate	2/sec 6/sec 10/sec 13.3/sec 18.5/sec 21.8/sec 26.7/sec 30/sec	Selects key repeat rate.	
Keyboard Auto-repeat Delay	0.25 sec 0.5 sec 0.75 sec 1 sec	Selects delay before key repeat.	

4.2.2.6 Security Menu Selections

Table 4-11. Security Menu Selections

Feature	Choices or Display Only	Description	User Setting
Supervisor Password is	Clear	(Display only). Once set, this can be disabled by setting it to a null string, or by clearing password jumper on system board.	
User Password is	Clear	(Display only). Once set, this can be disabled by setting it to a null string, or by clearing password jumper on system board	
Set Supervisor Password	Press Enter	Supervisor password controls access to the setup utility. When the <Enter> key is pressed, the user is prompted for a password; press ESC key to abort. Once set, this can be disabled by setting it to a null string, or by clearing password jumper on system board.	
Set User Password	Press Enter	When the <Enter> key is pressed, the user is prompted for a password; press ESC key to abort. Once set, this can be disabled by setting it to a null string, or by clearing password jumper on system board.	
Password on Boot	Disabled Enabled	Disables or enables password entry on boot.	
Fixed Disk Boot Sector	Normal Write Protect	Write protects boot sector on hard disk.	
Diskette Access	User Supervisor	Controls access to diskette drives.	
Secure Mode		See Secure Mode Submenu. Submenu can only be entered if supervisor and user password is set.	
Power Switch Mask	Masked Unmasked	Determines whether power switch will function from front panel	
Option ROM Menu Mask	Unmasked Masked	Determines whether on-board SCSI Option ROM will allow the user to enter adapter configuration with <CTRL>-A	

Table 4-12. Secure Mode Submenu Selections

Feature	Choices or Display Only	Description	User Setting
Secure Mode Timer	Disabled 1 Min 2 Min 5 Min 10 min 30 min 1 hr 2 hr	Period of keyboard and mouse inactivity before secure mode is activated and a password is required gain access.	
Secure Mode HotKey	Disabled Enabled	Enables/Disables the ability to lock the system with a <CTRL>+<ALT> + <key> combination. The key can be selected and submenu appears when enabled. A password is required to gain access.	
Secure Mode Boot	Disabled Enabled	Enables/Disables secure boot. The system will boot as normal, but a password is required to access the system using any PS/2 device	
Floppy Write Protect	Disabled Enable	Enables/Disables floppy drive write protection. If enabled, a password is required to write to a floppy.	

4.2.2.7 System Hardware Menu Selections

Table 4-13. Server Menu Selections

Feature	Choices or Display Only	Description	User Setting
Wake On Events		See Wake On Events submenu.	
AC Link	Power On Last State Stay Off	Selects power retention mode if AC power is lost a regained.	
Error Log Initialization	Press Enter	Select to clear the system Error Log. If Clear OK, then display "System Event Log Cleared!" If Clear failed, then display "System Event Log Not Cleared!"	
Console Redirection		See Console Redirection Submenu.	
Assert NMI on PERR	Disabled Enabled	Enables PCI PERR support.	

Table 4-14. Wake On Events Submenu Selections

Feature	Choices or Display Only	Description	User Setting
Wake On LAN	Enabled Disabled	Enables/Disables Wake-on-LAN support.	
Wake On Ring	Enabled	Enables/Disables Wake-on-Ring support.	

	Disabled		
--	----------	--	--

Table 4-15. Console Redirection Submenu Selections

Feature	Choices or Display Only	Description	User Setting
Serial Port Address	Disabled Serial Port 2 (3F8h/IRQ4) Serial Port 2 (2F8h/IRQ3)	If enabled, the console will be redirected to this port. If console redirection is enabled, this address must match the settings of serial port 2.	
Baud Rate	57.6K 19.2K	Enables the specified baud rate.	
Flow Control	No Flow Control XON/OFF	Selects flow control.	
Console Connection	Direct Via Modem	Indicate whether the console is connected directly to the system or if a modem is used to connect.	

4.2.2.8 Boot Menu Selections

Boot Menu options allow the user to select the boot device. The following table is an example of a list of devices ordered in priority of the boot invocation. Items can be re-prioritized by using the up and down arrow keys to select the device. Once the device is selected, use the plus (+) key to move the device higher in the boot priority list. Use the minus (-) key to move the device lower in the boot priority list.

Table 4-16. Boot Menu Selections

Feature	Choices or Display Only	Description	User Setting
Boot-Time Diagnostic Screen	Disabled		
Enabled	Enable/Disable boot-time diagnostic screen. Splash screen is displayed over the diagnostic screen when is option is Disabled.		
Boot Device Priority		See Boot Device Priority Submenu	
Hard Drive		See Hard Drive Submenu	
Removable Devices		See Removable Devices Submenu	

Table 4-17. Boot Device Priority Selections

Boot Priority	Device	Description	User Setting
1	ATAPI CD-ROM Drive	Attempts to boot from an ATAPI CD-ROM drive.	
2	Removable Devices	Attempts to boot from a removable device.	

3	Hard Drive	Attempts to boot from a hard drive device.	
4	Intel UNDI, PXE-2.0	Attempts to boot from a PXE server.	

Table 4-18. Hard Drive Selections

Boot Priority	Device	Description	User Setting
1	AIC-7899, CH B ID 1 ¹	Select the order in which each drive is attempted to be used as the boot device.	
2	AIC-7899, CH A, ID 9 ¹		
3	AIC-7899, CH B, ID 4 ¹		
4	Bootable Add-in Cards		

Note:

1. These selections will change depending on the system configuration

Table 4-19. Removable Devices Selections

Boot Priority	Device	Description	User Setting
1	Legacy Floppy Drives	Select the order in which each removable device is attempted to be used as the boot device. ¹	

Note:

1. These selections will change depending on the system configuration

4.2.2.9 Exit Menu Selections

The following menu options are available on the Exit menu. Use the up and down arrow keys to select an option, then press the Enter key to execute the option.

Table 4-20. Exit Menu Selections

Option	Description
Exit Saving Changes	Exit after writing all modified Setup item values to NVRAM.
Exit Discarding Changes	Exit leaving NVRAM unmodified. User is prompted if any of the setup fields were modified.
Load Setup Defaults	Load default values for all SETUP items.
Discard Changes	Read previous values of all Setup items from NVRAM.
Save Changes	Write all Setup item values to NVRAM.

4.3 CMOS Memory Definition

Only the BIOS needs to know the CMOS map. The CMOS map is not defined in the BIOS EPS. The CMOS map is available in the NVRAM.LST file generated for every BIOS release. The CMOS map is subject to change without notice.

4.4 CMOS Default Override

The BIOS detects the state of the CMOS default switch. If the switch is set to "CMOS Clear" prior to power-on or a hard reset, the BIOS changes the CMOS and NVRAM settings to a default state. This guarantees the system's ability to boot from floppy.

Password settings are not affected by CMOS clear. The BIOS clears the ESCD parameter block and loads a null ESCD image. The boot order information is also cleared when CMOS is cleared via jumper. The configuration data for the on-board SCSI controllers is not cleared during a clear CMOS event as each device controls its own default settings

If the Reset Configuration Data option is enabled in Setup, ESCD data and BIOS Boot specification data is cleared and reinitialized in next boot.

4.5 Flash Update Utility

The BIOS update utility (Phoenix* Phlash.exe) loads a fresh copy of the BIOS into flash ROM. The loaded code and data include the following:

- On-board video BIOS, network controller BIOS, and SCSI BIOS.
- BIOS Setup utility.
- User-definable flash area (user binary area).
- OEM logo (splash screen).

When running Phoenix* Phlash in interactive mode, the user may choose to update a particular flash area. Updating a flash area takes a file or series of files from a hard or floppy disk, and loads it in the specified area of flash ROM.

Note: The Phoenix Phlash utility must be run without the presence of a 386 protected mode control program, such as Windows* or EMM386*. Phoenix* Phlash uses the processor's flat addressing mode to update the flash part.

4.5.1 Loading the System BIOS

The BIOS update utility (PHLASH) loads a new copy of the BIOS into Flash ROM. The loaded code and data include the following:

- On-board Video BIOS and SCSI BIOS
- BIOS Setup Utility
- Quiet Boot Logo Area

When running PHLASH in interactive mode, the user may choose to update a particular Flash area. Updating a flash area loads a file or a series of files from a hard or floppy disk into the specified area of Flash ROM.

To manually load a portion of the BIOS, the user must specify which data file(s) to load. The choices include

- PLATCBLU.BIN
- PLATCXLU.BIN
- PLATCXXX.BIN
- PLATCXLX.BIN
- PLATCXXU.BIN

The last three letters specify the functions to perform during the flash process:

- C = Rewrite BIOS
- B = Rewrite Bootblock
- L = Clear LOGO area
- U = Clear user binary
- X = place hold

This file is loaded into the PHLASH program with the `/b=<bin file>`.

The disk created by the BIOS.EXE program will automatically run `phlash /s /b=PLATCXLU.BIN` command in non-interactive mode. For a complete list of phlash switches, run `phlash /h`.

Once an update of the system BIOS is complete, the user is prompted for a reboot. The user binary area is also updated during a system BIOS update. User binary can be updated independently of the system BIOS. CMOS is cleared when the system BIOS is updated.

4.5.2 OEM Customization

An OEM can customize the STL2 BIOS for product differentiation. The extent of customization is limited to what is stated in this section. OEMs can change the BIOS look and feel by adding their own splash screen/logo. OEMs can manage OEM-specific hardware, if any, by executing their own code during POST by using the "User-supplied BIOS Code Support."

4.5.2.1 User-supplied BIOS Code Support

A 16 KB region of flash ROM is available to store a user binary. The Phoenix* Phlash utility allows the OEM or end user to update the user binary region with OEM supplied code and/or data. At several points throughout POST, control is passed to this user binary. Intel provides tools and reference code to help OEMs create a user binary. The user binary must adhere to the following requirements:

- To allow detection by BIOS and protection from run time memory managers, the user binary must have an option ROM header (i.e., 55AAh, size).
- The system BIOS performs a scan of the user binary area at predefined points during POST. Mask bits must be set within the user binary to inform the BIOS which entry points exist.

- The system state must be preserved by the user binary (all registers, including extended and MMX, stack contents, and nonuser binary data space, etc.).
- The user binary code must be relocatable. The user binary is located within the first 1 MB of memory. The user binary code must not make any assumptions about the value of the code segment.
- The user binary code is always executed from RAM and never from flash.
- The user binary must not hook critical interrupts, must not reprogram the chip set, and must not take any action that affects the correct functioning of the system BIOS.
- The user binary ROM must be checksummed. The checksum byte must be placed in the last byte position of the 16K ROM.

The BIOS copies the user binary into system memory before the first scan point. If the user binary reports that it does not contain run time code, it is located in conventional memory (0-640 KB). Reporting that the user binary has no run time code has the advantage of not using limited option ROM space (therefore, more option ROMs may be executed in a large system configuration). If user binary code is required at run time, it is copied into and executed from option ROM space (0C8000H – 0E7fffH).

At each scan-point during POST, the system BIOS determines if the scan-point has a corresponding user binary entry point to transfer control to the user binary. Presence of a valid entry point in the user binary is determined by examining the bitmap at byte 4 of the user binary header; each entry point has a corresponding “presence” bit in this bitmap. If the bitmap has the appropriate bit set, an entry point ID is placed in the “AL” register and execution is passed to the address computed by $(ADR(\text{Byte } 5)+5*\text{scan sequence \#})$.

During execution, the user binary may access 11 bytes of extended BIOS data area RAM (EBDA). The segment of EBDA can be found at address 40:0e. Offset 18h through offset 22h is available for the user binary. The BIOS also reserves 8 CMOS bits for the user binary. These bits are in an unchecksummed region of CMOS with default values of zero, and will always be located in the first bank of CMOS. These bits are contiguous, but are not in a fixed location. Upon entry into the user binary, DX contains a ‘token’ that points to the reserved bits. This token is of the following format:

MSB												LSB		
15			12	11										0
# of bit available –1				Bit offset from start of CMOS of first bit										

The most significant four bits are equal to the number of CMOS bits available minus one. This field is equal to seven, since eight CMOS bits are available. The 12 least significant bits define the position of the CMOS bit in the real-time clock (RTC). This is a bit address rather than a byte address. The CMOS byte location is 1/8th of the 12-bit number, and the remainder is the starting bit position within that byte. For example, if the 12-bit number is 0109h, user binary can use bit 1 of CMOS byte 0108h/8 or 021h. It should be noted that the bits available to the user binary may span more than one byte of CMOS (i.e., a value of 07084h indicates that the upper nibble of byte 10h and the lower nibble of byte 11h are reserved for the user binary).

The following code fragment shows the header and format for a user binary:

```

        db      55h, 0AAh, 20h      ; 16KB USER Area

MyCode  PROC   FAR                  ; MUST be a FAR procedure
        db      CBh                ; Far return instruction

        db      04h                ; Bit map to define call points, a 1
                                   ; in any bit specifies
                                   ; that the BIOS is called at that
                                   ; scan point in POST
        db      CBh                ; First transfer address used to
                                   ; point to user binary extension
                                   ; structure
        dw      ?                  ; Word Pointer to extension
                                   ; structure
        dw      0                  ; Reserved

        JMP     ErrRet             ; This is a list of 7 transfer
                                   ; addresses, one for each
        JMP     ErrRet             ; bit in the bitmap.
                                   ; 5 Bytes must be used for each
        JMP     Start              ; JMP to maintain proper offset for
                                   ; each entry. Unused entry JMP's
                                   ; should be filled with 5 byte
                                   ; filler or JMP to a RETF

        JMP     ErrRet             ;
        JMP     ErrRet
        JMP     ErrRet
        JMP     ErrRet

```

4.5.2.2 Scan Point Definitions

The table below defines the bitmap for each scan point, indicating when the scan point occurs and which resources are available (RAM, stack, binary data area, video, and keyboard).

Table 4-21. User Binary Area Scan Point Definitions

Scan Point	Mask	RAM/Stack/BDA	Video/Keyboard
Near pointer to the user binary extension structure, mask bit is 0 if this structure is not present. Instead of a jump instruction the scan address (offset 5) contains an 0CB followed by a near pointer.	01h	Not applicable	Not applicable
Obsolete. No action taken.	02h	NA	NA
This scan occurs immediately <u>after</u> video initialization.	04h	Yes	Yes
This scan occurs immediately <u>before</u> video initialization.	08h	Yes	No
This scan occurs on POST error. On entry, BX contains the number of the POST error.	10h	Yes	Yes
This final scan occurs immediately <u>prior</u> to the INT 19 for normal boot and allows one to completely circumvent the normal INT 19 boot if desired.	20h	Yes	Yes
This scan occurs immediately <u>before</u> the normal option ROM scan.	40h	Yes	Yes
This scan occurs immediately <u>following</u> the option ROM area	80h	Yes	Yes

scan.			
-------	--	--	--

Table 4-22. Format of the User Binary Information Structure

Offset	Bit Definition
0	<p>Bit 0 = 1 if mandatory user binary, 0 if not mandatory. If a user binary is mandatory, it will always be executed. If a platform supports a disabling of the user binary scan through Setup, this bit will override Setup setting.</p> <p>Bit 1 - 1 if runtime presence required (other than SMM user binary portion, SMM user binary will always be present in runtime irrespective of setting of this bit). 0, if not required in runtime, and can be discarded at boot time.</p> <p>Bit 7:2 – reserved for future expansion.</p>
1 - 0fh	Reserved for future expansion.

If this structure is not present (bit 0 of the scan point structure is not set), the system BIOS assumes that the user binary is not mandatory (bit 0 in User Binary Information Structure assumed cleared), and it is required in run time (bit 1 in User Binary Information Structure assumed set).

4.5.2.3 OEM Splash Screen

A 128 KB region of Flash ROM is available to store the OEM logo in compressed format. The BIOS will contain the standard Intel logo. Using the Phoenix Phlash utility, this region can be updated with an OEM supplied logo image. The OEM logo must fit within 640 X 480 size. If an OEM logo is flashed into the system, it will override the built in Intel logo.

Intel supplies utilities that will compress and convert a 16 color bitmap file into a logo file suitable for Phoenix8 Phlash.

4.5.3 Language Area

The system BIOS language area can be updated only by updating the entire BIOS. The STL2 platform supports English, Spanish, French, German, and Italian. Intel provides translations for all the strings in five languages. These languages are selectable using Setup.

4.5.4 Recovery Mode

In the case of a corrupt or an unsuccessful update of the system BIOS, the STL2 can boot in recovery mode. To place STL2 into recovery mode, move the boot option jumper (jumper block 1J15 pins 9-10) to the recovery boot position. By default and for normal operation, pins 9 and 10 are not jumpered.

Recovery mode requires at least 8 MB of RAM in the first DIMM socket, and drive A: must be set up to support a 3.5" 1.44 MB floppy drive. (**Note:** the system requires 64 MB to boot). This is the mode of last resort, used only when the main system BIOS will not come up. In recovery

mode operation, PHLASH (in non-interactive mode only) automatically updates only the main system BIOS. PHLASH senses that STL2 is in recovery mode and automatically attempts to update the system BIOS

Before powering up the system, the user must obtain a bootable diskette that contains a copy of the BIOS recovery files. This is created by running the "crisdisk.bat" from the compressed recovery file distributed with the BIOS.

Note: During recovery mode, video will not be initialized and many high-pitched beep tones will be heard. The entire process takes two to four minutes. When the process is completed, the tones will stop. The user may see a "Checksum error" on the first boot after updating the BIOS. This is normal and should correct itself after the first boot.

If a failure occurs, it is most likely that of the system BIOS .ROM file is corrupt or missing.

After a successful update, power down the system and remove the jumper from pins 9-10. Power up the system. Verify that the BIOS version number matches the version of the entire BIOS used in the original attempt to update.

4.6 Error Messages and Error Codes

The system BIOS displays error messages on the video screen. Prior to video initialization, beep codes inform the user of errors. POST error codes are logged in the event log. The BIOS displays POST error codes on the video monitor.

Following are definitions of POST error codes, POST beep codes, and system error messages.

4.6.1 POST Codes

The BIOS indicates the current testing phase during POST after the video adapter has been successfully initialized by writing a 2-digit hex code to I/O location 80h. If a Port-80h card (Postcard*) is installed, it displays this 2-digit code on a pair of hex display LEDs.

Table 4-23. Port-80h Code Definition

Code	Meaning
CP	Phoenix* check point (port-80) code

The table below contains the port-80 codes displayed during the boot process. A beep code is a series of individual beeps on the PC speaker, each of equal length. The following table describes the error conditions associated with each beep code and the corresponding POST check point code as seen by a 'port 80h' card. For example, if an error occurs at checkpoint 22h, a beep code of 1-3-1-1 is generated. The "-" means there is a pause between the sequence that delimits the sequence.

Some POST codes occur prior to the video display being initialized. To assist in determining the fault, a unique beep-code is derived from these checkpoints as follows:

- The 8-bit test point is broken down to four 2-bit groups.
- Each group is made one-based (1 through 4)
- One to four beeps are generated based on each group's 2-bit pattern.

Example:

Checkpoint 04Bh will be broken down to: 01 00 10 11

And the beep code will be: 2 – 1 – 3 – 4

Table 4-24. Standard BIOS Port-80 Codes

CP	Beeps	Reason
02		Verify Real Mode
04		Get Processor type
06		Initialize system hardware
08		Initialize chipset registers with initial POST values
09		Set in POST flag
0A		Initialize Processor registers
0B		Enable Processor cache
0C		Initialize caches to initial POST values
0E		Initialize I/O
0F		Initialize the local bus IDE
10		Initialize Power Management
11		Load alternate registers with initial POST values
12		Restore Processor control word during warm boot
14		Initialize keyboard controller
16	1-2-2-3	BIOS ROM checksum
18		8254 timer initialization
1A		8237 DMA controller initialization
1C		Reset Programmable Interrupt Controller
20	1-3-1-1	Test DRAM refresh
22	1-3-1-3	Test 8742 Keyboard Controller
24		Set ES segment register to 4GB
28	1-3-3-1	Autosize DRAM, system BIOS stops execution here if the BIOS does not detect any usable memory DIMMs
2A		Clear 8 MB base RAM
2C	1-3-4-1	Base RAM failure, BIOS stops execution here if entire memory is bad
32		Test Processor bus-clock frequency
34		Test CMOS
35		RAM Initialize alternate chipset registers
36		Warm start shut down
37		Reinitialize the chipset
38		Shadow system BIOS ROM
39		Reinitialize the cache
3A		Autosize cache

CP	Beeps	Reason
3C		Configure advanced chipset registers
3D		Load alternate registers with CMOS values
40		Set Initial Processor speed new
42		Initialize interrupt vectors
44		Initialize BIOS interrupts
46	2-1-2-3	Check ROM copyright notice
47		Initialize manager for PCI Option ROMs
48		Check video configuration against CMOS
49		Initialize PCI bus and devices
4A		Initialize all video adapters in system
4B		Display QuietBoot screen
4C		Shadow video BIOS ROM
4E		Display copyright notice
50		Display Processor type and speed
52		Test keyboard
54		Set key click if enabled
55		USB initialization
56		Enable keyboard
58	2-2-3-1	Test for unexpected interrupts
5A		Display prompt "Press F2 to enter SETUP"
5C		Test RAM between 512 and 640k
60		Test extended memory
62		Test extended memory address lines
64		Jump to UserPatch1
66		Configure advanced cache registers
68		Enable external and processor caches
6A		Display external cache size
6B		Load custom defaults if required
6C		Display shadow message
6E		Display non-disposable segments
70		Display error messages
72		Check for configuration errors
74		Test real-time clock
76		Check for keyboard errors
7A		Test for key lock on
7C		Set up hardware interrupt vectors
7D		Intelligent system monitoring
7E		Test coprocessor if present
82		Detect and install external RS232 ports
85		Initialize PC-compatible PnP ISA devices
86		Re-initialize on board I/O ports
88		Initialize BIOS Data Area
8A		Initialize Extended BIOS Data Area

CP	Beeps	Reason
8C		Initialize floppy controller
90		Initialize hard disk controller
91		Initialize local bus hard disk controller
92		Jump to UserPatch2
93		Build MPTABLE for multi-processor boards
94		Disable A20 address line
95		Install CD-ROM for boot
96		Clear huge ES segment register
98	1-2	Search for option ROMs. One long, two short beeps on checksum failure
9A		Shadow option ROMs
9C		Set up Power Management
9E		Enable hardware interrupts
A0		Set time of day
A2		Check key lock
A4		Initialize typematic rate
A8		Erase F2 prompt
AA		Scan for F2 key stroke
AC		Enter SETUP
AE		Clear in-POST flag
B0		Check for errors
B2		POST done – prepare to boot Operating System
B4	1	One short beep before boot
B5		Display MultiBoot menu
B6		Check password, password is checked before option ROM scan
B7		ACPI initialization
B8		Clear global descriptor table
BC		Clear parity checkers
BE		Clear screen (optional)
BF		Check virus and backup reminders
C0		Try to boot with INT 19
C8		Forced shutdown
C9		Flash recovery
DO		Interrupt handler error
D2		Unknown interrupt error
D4		Pending interrupt error
D6		Initialize option ROM error
D8		Shutdown error
DA		Extended Block Move
DC		Shutdown 10 error

Table 4-25. Recovery BIOS Port-80 Codes

CP	Beeps	Reason
E0		Initialize chip set
E1		Initialize bridge
E2		Initialize processor
E3		Initialize timer
E4		Initialize system I/O
E5		Check forced recovery boot
E6		Validate checksum
E7		Go to BIOS
E8		Initialize processors
E9		Set 4 GB segment limits
EA		Perform platform initialization
EB		Initialize PIC and DMA
EC		Initialize memory type
ED		Initialize memory size
EE		Shadow boot block
EF		Test system memory
F0		Initialize interrupt services
F1		Initialize real time clock
F2		Initialize video
F3		Initialize beeper
F4		Initialize boot
F5		Restore segment limits to 64 KB
F6		Boot mini DOS
F7		Boot full DOS

4.6.2 POST Error Codes and Messages

The following table defines POST error codes and their associated messages. The BIOS prompts the user to press a key in case of a serious error. Some error messages are preceded by the string "Error" to highlight that the system might be malfunctioning. All POST errors and warnings are logged in the system event log unless it is full.

Table 4-26. POST Error Messages and Codes

Code	Error Message	Failure Description
0200:	Failure Fixed Disk	hard disk error
0210:	Stuck Key	Keyboard connection error
0211:	Keyboard error	Keyboard failure
0212:	Keyboard Controller Failed	Keyboard Controller Failed
0213:	Keyboard locked– Unlock key switch	Keyboard locked
0220:	Monitor type does not match CMOS– Run SETUP	Monitor type does not match CMOS

Code	Error Message	Failure Description
0230:	System RAM Failed at offset	System RAM error Offset address
0231:	Shadow RAM Failed at offset	Shadow RAM Failed Offset address
0232:	Extend RAM Failed at address line	Extended RAM failed Offset address
0233:	Memory type mixing detected	Memory type mixing detected
0234:	Single – bit ECC error	Memory 1 bit error detected
0235:	Multiple- bit ECC error	Memory multiple-bit error detected
0250:	System battery is dead – Replace and run SETUP	NVRAM battery dead
0251:	System CMOS checksum bad – Default configuration used	CMOS checksum error
0252:	Password checksum bad - Passwords cleared	
0260:	System timer error	System timer error
0270:	Real time clock error	RTC error
0271:	Check date and time setting	RTC time setting error
02B0:	Diskette drive A error	
02B2:	Incorrect Drive A type – run SETUP	Incorrect Drive A type
02D0:	System cache error – Cache disabled	CPU cache error
0B00:	Rebooted during BIOS boot at Post Code	
0B1B:	PCI System Error on Bus/Device/Function	PCI system error in Bus/device/Function
0B1C:	PCI Parity Error in Bus/Device/Function	PCI system error in Bus/device/Function
0B50:	CPU#1 with error taken offline	Failed CPU#1 because an error was detected
0B51:	CPU#2 with error taken offline	Failed CPU#2 because an error was detected
0B5F:	Forced to use CPU with error	An error detected in the entire CPU
0B60:	DIMM group #1 has been disabled	Memory error, memory group #1 failed
0B61:	DIMM group #2 has been disabled	Memory error, memory group #2 failed
0B62:	DIMM group #3 has been disabled	Memory error, memory group #3 failed
0B63:	DIMM group #4 has been disabled	Memory error, memory group #4 failed
0B6F:	DIMM group with error is enabled	An error detected in all the memory
0B70:	The error occurred during temperature sensor reading	Error while detecting a temperature failure.
0B71:	System temperature out of the range	Temperature error detected.
0B74:	The error occurred during voltage sensor reading	Error while detecting voltage
0B75:	System voltage out of the range	System voltage error
0B7C:	The error occurred during redundant power module confirmation	The error occurred while retrieving the power information
0B80:	BMC Memory Test Failed	BMC device (chip) failed
0B81:	BMC Firmware Code Area CRC check failed	
0B82:	BMC core Hardware failure	
0B83:	BMC IBF or OBF check failed	Access to BMC address failed
0B90:	BMC Platform Information Area corrupted.	BMC device(chip) failed
0B91:	BMC update firmware corrupted.	
0B92:	Internal Use Area of BMC FRU corrupted.	SRAM storing chassis information failed (Available for use except for FRU command and EMP function)

Code	Error Message	Failure Description
0B93:	BMC SDR Repository empty.	BMC device (chip) failed
0B94:	IPMB signal lines do not respond.	SMC(Satellite Management Controller) failed (Available for use except for the access function to SMC via IPMB)
0B95	BMC FRU device failure.	SROM storing chassis information failed (Available for use except for FRU command and EMP function.)
0B96	BMC SDR Repository failure.	BMC device (chip) failed
0B97	BMC SEL device failure.	
0BB0:	SMBIOS – SROM data read error	SROM data read error
0BB1:	SMBIOS – SROM data checksum bad	Bad checksum of SROM data
0BD0:	1st SMBus device address not acknowledged.	Some SMBus device (chip) failed
0BD1:	1st SMBus device Error detected.	
0BD2:	1st SMBus timeout.	
	Expansion ROM not initialized.	PCI Expansion ROM card not initialized
	Invalid System Configuration Data	System configuration data destroyed
	System Configuration Data Read Error	System configuration data read error
	Resource Conflict	PCI card resource is not mapped correctly.
	System Configuration Data Write error	System configuration data write error
	Warning: IRQ not configured	PCI interrupt is not configured correctly.
8503:	Incorrect memory speed in location: XX, XX, ...	Non-PC133 DIMMs have been installed in slots XX, XX, ...

A beep code is a series of individual beeps on the PC speaker, each of equal length. The following table describes the error conditions associated with each beep code and the corresponding POST check point code as seen by a port 80h card. For example, if an error occurs at checkpoint 22h, a beep code of 1-3-1-1 is generated. The beep codes 1-1-1-1, 1-5-1-1, 1-5-2-1 and 1-5-3-1 are reserved for BMC usage.

Beeps	Error	Cause	Recommended Action
1-2-2-3	ROM Checksum Error	—	Change system board
1-3-1-1	DRAM Refresh Test Error	—	Change memory DIMM's
1-3-1-3	Keyboard Controller Test Error	—	Change system board
1-3-3-1	Memory Not Detected	No memory. Can not write to memory	Verify DIMM installation. Change memory DIMM's
	Memory Capacity Check Error	No memory. Can not write to memory	Verify DIMM installation. Change memory DIMM's
1-3-4-1	DRAM Address Test Error	Memory address signal failure	Change DIMM or M/B
1-3-4-3	DRAM Test low byte Error	Memory data signal failure (low)	Change DIMM or M/B
1-4-1-1	DRAM Test high byte Error	Memory data signal failure (high)	Change DIMM or M/B
1-4-3-3	All Memory Group Errors	—	—
2-1-2-3	BIOS ROM Copy-Write Test Error	Error with Shadow RAM	Change system board
2-2-3-1	Unexpected Interrupt Test Error	Unexpected interrupt	Change CPU or system board
2-3-1-3	All Memory Group Errors	Memory address signal failure	Change DIMM or M/B

3-3-1-4	Memory Not Detected	—	—
1-2	Option ROM Initialization Error	Failure to initialize Option ROM BIOS	Change system board or option board
1-2	Video configuration fails	Failure to initialize VGA BIOS	Change option video board or system board
1-2	OPTION ROM Checksum Error	Failure to initialize Option BIOS	Change M/B or option board

4.7 Identifying BIOS and BMC Revision Levels

The following sections provide information to help identify a system's current BIOS and BMC revision levels.

4.7.1 BIOS Revision Level Identification

During system POST, which runs automatically when the system is powered on, the monitor displays several messages, one of which identifies the BIOS revision level currently loaded on the system (see the following example).

```
Phoenix BIOS 4.0 Release 6.0.250A
```

In the example above, BIOS 6.0.250A is the current BIOS revision level loaded on the system.

Note: Press the **Esc** key to see the diagnostic messages.

Note: The BIOS Revision Level stated in the example might not reflect the actual BIOS setting in any particular system.

4.7.2 BMC Revision Level Identification

During system POST, which runs automatically when the system is powered on, system diagnostics are run. Following the memory test diagnostic, several messages appear to inform the user that the mouse was detected and system configuration data updated. The BMC messages follow these.

To identify the system's current BMC revision level, see the following example.

```
Base Board Management Controller
Device ID :01 Device Revision :00
IPMI Version :1.0 Firmware Revision :00.60
Self Test Result:
```

In the example above, Firmware Revision 00.60 is the current BMC revision level loaded on the system.

Note: Press the **Esc** key to see the diagnostic messages.

Note: The Firmware Revision level in the example might not reflect the actual BMC revision level in any particular system.

4.8 Adaptec SCSI Utility

The Adaptec SCSI Utility detects the SCSI host adapters on the server board. The Adaptec SCSI Utility is used to:

- Change default values
- Check and/or change SCSI device settings that may conflict with those of other devices in the server.

4.8.1 Running the SCSI Utility

The user can access the Adaptec SCSI Utility when the system is powered on or rebooted. To run the Adaptec SCSI utility, perform the following procedure.

1. Power-on or reboot the system.
2. At the message to “Press Ctrl-A to run SCSI Utility”, press Ctrl+A.
3. Choose the host adapter that needs to be configured.
4. The SCSI utility starts. When the Adaptec SCSI Utility detects more than one AIC-78xx host adapter, it displays a selection menu listing the bus and device number of each adapter. When the selection menu appears, select the channel that should be configured as follows.

Bus: Device: Channel	Selected SCSI Adapter
01: 04: A ¹	AIC7899
01: 04: B	AIC7899

Note:

Internal SCSI Connector

When the adapter is selected, the following options display.

Menu	Description
Configure/View Host Adapter Settings	Configure host adapter and device settings.
SCSI Disk Utilities	The utility scans the SCSI bus for SCSI devices and reports a description of each device. Run these utilities before configuring SCSI devices.

To format a disk, verify disk media, or display a list of devices and their SCSI IDs, select “SCSI Disk Utilities”. To configure the adapter or a device, select “Configure/View Host Adapter Settings.”

4.8.2 Adaptec SCSI Utility Configuration Settings

The following keys are active for all Adaptec SCSI Utility screens.

Key	Action
Arrows	Up and down arrows move from one parameter to another within a screen.
ENTER	Displays options for a configurable parameter. Selects an option.
ESC	Moves back to previous screen or parameter or EXIT if at the Main menu.
F5	Switches between color and monochrome.
F6	Resets to host adapter defaults.

The following table shows the normal settings for the Adaptec SCSI Utility and provides a place to record any changes made to these settings.

Table 4-27. Adaptec SCSI Utility Setup Configurations

Option	Recommended Setting or Display Only	User Setting
SCSI Bus Interface Definitions		
Host Adapter SCSI ID	7	
SCSI Parity Checking	Enabled	
Host Adapter SCSI Termination	Enabled	
Additional Options		
Boot Device Options	Press Enter for menu	
Boot Channel	A First	
Boot SCSI ID	0	
Boot LUN Number	0	
SCSI Device Configuration	Press Enter for menu	
Sync Transfer Rate (MBps)	160	
Initiate Wide Negotiation	Yes	
Enable Disconnection	Yes	
Send Start Unit Command	Yes	
Enable Write Back Cache	No	
BIOS Multiple LUN Support	No ¹	
Include in BIOS Scan	Yes ¹	
Advanced Configuration Options	Press Enter for menu.	
Plug-and-Play SCAM Support	Disabled	
Reset SCSI Bus at IC Initialization	Enabled	
Display <Ctrl-A> Messages During BIOS Initialization	Enabled	
Extended BIOS Translation for DOS Drives >1 Gbyte	Enabled	
Verbose/Silent Mode	Verbose	
Host Adapter BIOS (Configuration Utility Reserves BIOS Space)	Enabled ¹	
Domain Validation	Enabled	
Support Removable Disks Under BIOS as Fixed Disks	Disabled ^{1,2}	
BIOS Support for Int13 Extensions	Enabled ¹	

Notes:

1. No effect if BIOS is disabled.

2. Do not remove media from a removable media drive if it is under BIOS control.

4.8.3 Exiting Adaptec SCSI Utility

To exit the Adaptec SCSI Utility, the user presses the **Esc** key several times, until a message prompts him / her to exit. If changes have been made, the user is prompted to save them before exiting.

< This page intentionally left blank >

5. Jumpers and Connectors

STL2 Server Board Jumper and Connector Locations

The following figure shows the location of the jumper blocks and connectors on the STL2 Server board.

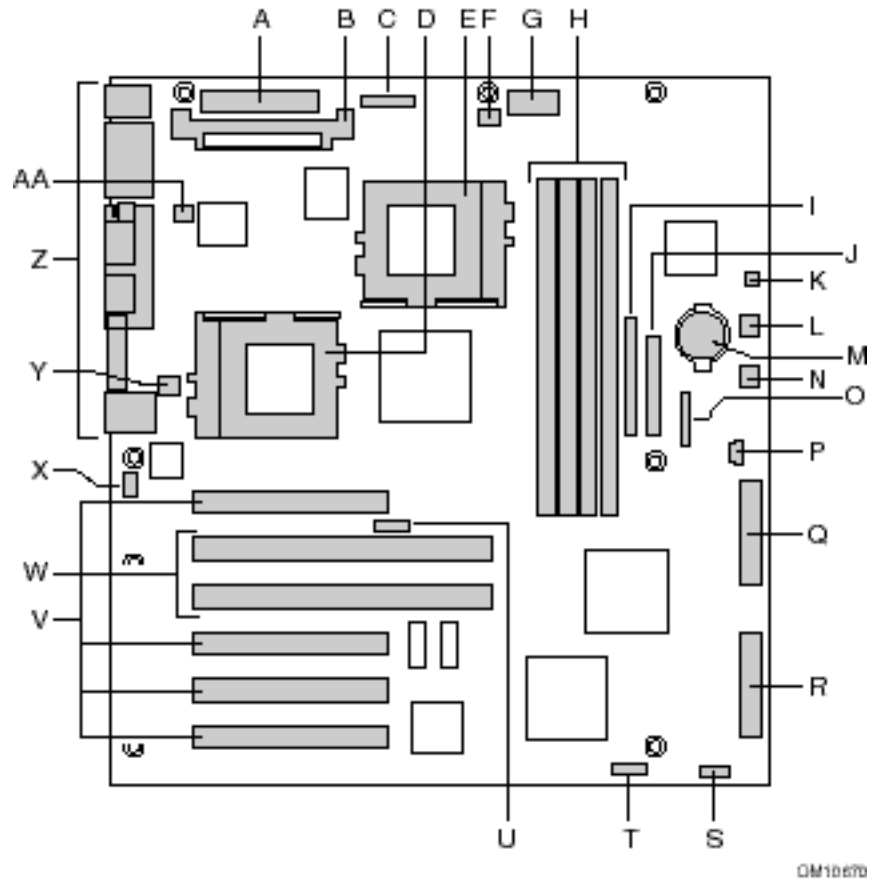

Figure 5-1. STL2 Server Board Jumper and Connector Locations

Jumper and connector location key for Figure 5-1:

- A. Main power connector (P33)
- B. VRM socket (P32)
- C. Auxiliary power connector (P34)
- D. Primary processor (P13)
- E. Secondary processor (P14)
- F. Secondary processor heatsink fan connector (P36)
- G. Power supply signal connector (P37)
- H. DIMM slots (P15-P18)
- I. IDE connector (P19)
- J. Floppy drive connector (P20)
- K. Two pin speaker connector (P31)

- L. System fan connector FAN3A (P29)
- M. Battery
- N. System fan connector FAN2A (P27)
- O. Front panel connector(P23)
- P. Four pin speaker connector (P25)
- Q. Ultra Single Ended (SE) SCSI connector (P9)
- R. Ultra160 LVD SCSI connector (P8)
- S. Configuration jumper block (1L4)
- T. Configuration jumper block (1J15)
- U. CPU speed jumper block (5E1)
- V. 33 MHz/32-bit PCI connectors
- W. 66 MHz/64-bit PCI connectors
- X. Chassis intrusion connector (pins 1-2 of 6A)
- Y. System fan connector FAN1 (P11)
- Z. I/O ports
- AA. Primary processor heatsink fan connector (P12)

The following diagram shows the location of the connectors on the STL2 server board I/O panel.

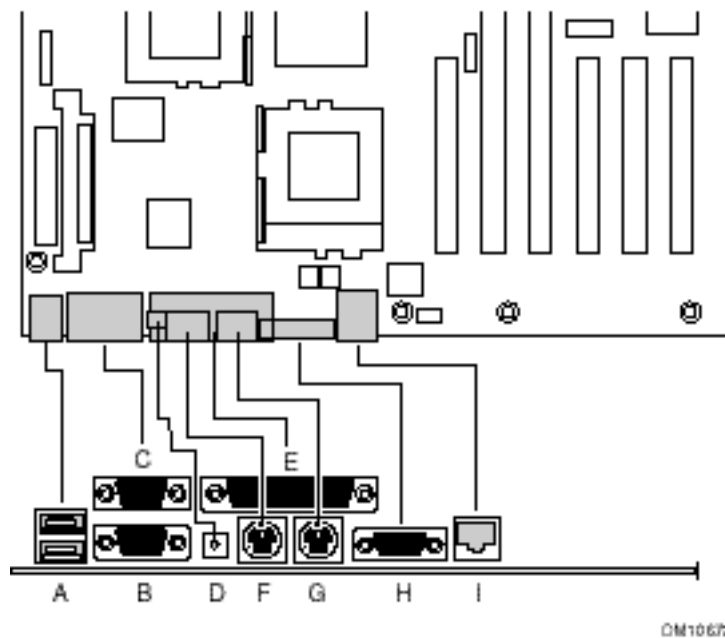

Figure 5-2. I/O Back Panel Connectors

I/O Back Panel location key for Figure 5-1:

- A. USB connectors
- B. Serial port 2 connector
- C. Serial port 1 connector
- D. NMI switch

- E. Parallel port connector
- F. Keyboard connector
- G. Mouse connector
- H. Video connector
- I. Network connector

5.1 Jumper Blocks

Jumpers on several jumper blocks of the STL2 server board are used to set the system configuration. The jumpers are small plastic-encased conductors (shorting plugs) that slip over two jumper pins on a jumper block.

On the STL2 server board, the following jumper blocks are user-configurable. The figure below shows the default settings for the STL2 jumper blocks.

- 1J15 (CMOS and Password Clear)
- 5E1 (Processor Frequency)
- 1L4 (Configuration)
- 6A (Chassis Intrusion)

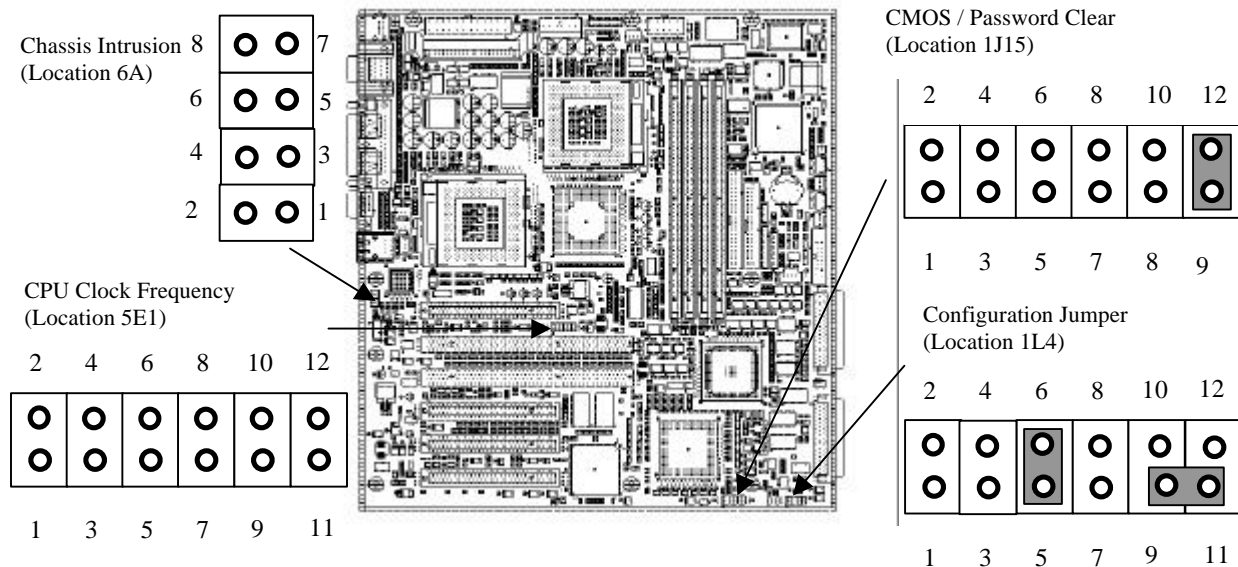

5.1.1 Setting CMOS/Password Clear Jumper Block 1J15

Setting a jumper on system board jumper block 1J15 enables the user to clear the CMOS or to clear a forgotten password. See the above figure for the location of the jumper block location. The following table lists the factory default settings for jumper block 1J15, which are indicated in bold typeface. Procedures for setting the jumper on the block follow the table.

Table 5-1. Jumper Block 1J15 Settings

Jumper Pin Numbers	Function	Jumper Position	What it does at system reset
1 - 2	CMOS clear	Open, Protect	Preserves the contents of CMOS
		Closed, Erase	Clears CMOS
3 - 4	Password protected	Open, Normal	Preserves the password
		Closed, Disable	Disables the password
5 - 6	Reserved	Open, Not Used	No function
7 - 8	Reserved	Open, Not Used	No function
9 - 10	BIOS Recovery Boot	Open, Normal	BIOS Recovery Boot disabled. Normal operation.
		Closed, Recovery Boot	If this jumper is set, BIOS recovery will be attempted from a bootable BIOS recovery floppy diskette.
11 - 12	Spare	Closed, Spare	Provides a spare jumper

5.1.1.1 Clearing and Changing a Password

Clear and change a password as follows.

1. Power off the system, unplug the power cord, and remove the chassis panel.
2. Use needle nose pliers or your fingers to remove the spare jumper from pins 11-12 on jumper block 1J15.
3. Reinstall the jumper on pins 3-4 (Password Disable) of jumper block 1J15.
4. Reinstall the chassis panel, plug in the power cord(s), and power on the system.
5. While waiting for POST to complete, press the **F2** key to enter BIOS setup.
6. This automatically clears all passwords, provided you save and exit the BIOS setup.
7. Power off the system, unplug the power cord(s), and remove the chassis panel.
8. Remove the Password Disable jumper from pins 3-4 and store the jumper on pins 11-12.
9. Replace the chassis panel, plug in the power cord(s), and power on the system.
10. To specify a new password run the BIOS Setup Utility as described earlier in this section.

5.1.1.2 Clearing CMOS

Clear CMOS as follows.

1. Power off the system, unplug the power cord, and remove the chassis panel.
2. Use needle-nose pliers or your fingers to remove the spare jumper from pins 11-12 on jumper block 1J15.
3. Position the jumper over pins 1-2 on jumper block 1J15.
4. Replace the chassis panel, plug in the power cable(s), and power on the system.

5. After POST completes, power down the system, unplug the power cable(s), and remove the chassis panel.
6. Remove the jumper from pins 1-2 and store the jumper on pins 11-12.
7. Replace the chassis panel and connect system cables.
8. Power on the system, press **F2** at the prompt to run the BIOS Setup utility, and select "Get Default Values" at the Exit menu.

5.1.1.3 Performing a BIOS Recovery Boot

In the event of BIOS corruption, the following procedure may be used to perform a BIOS Recovery.

1. Obtain the BIOS update file package from Intel's iBL or <http://support.intel.com> web site.
2. A file called "crisis.zip" is one of the files included with each STL2 BIOS release file package. Unzip the "crisis.zip" file to a directory on your hard drive.
3. Obtain a blank formatted floppy diskette (the floppy diskette should not be a bootable DOS diskette). Insert the blank formatted floppy diskette in the floppy drive.
4. From a MS-DOS prompt or from the MS-DOS prompt window, run the "crisdisk.bat" file from the directory you created on your hard drive. Follow the instructions on the screen to create the BIOS recovery floppy diskette.
5. Power off the STL2 system, unplug the power cord, and remove the chassis panel.
6. Remove the spare jumper from pins 11-12 on jumper block 1J15.
7. Reinstall the jumper on pins 9-10 (BIOS Recovery) of jumper block 1J15.
8. Insert the BIOS recovery floppy diskette into the diskette drive.
9. Reinstall the chassis panel, plug in the power cord(s), and power on the system.
10. The screen will remain blank while the BIOS Recovery is performed. A number of beeps will occur during the BIOS update. The floppy drive access light will not turn off when the BIOS recovery is completed. Allow four minutes for the BIOS recovery to complete. If a POST card is installed in a PCI slot during the BIOS recovery, you can tell that the BIOS recovery is complete when code "EC" is displayed. When the BIOS Recovery is complete, it is safe to power off the system.
11. Power off the system, unplug the power cord(s), and remove the chassis panel.
12. Remove the BIOS Recovery jumper from pins 9-10 and store the jumper on pins 11-12.
13. Replace the chassis panel, plug in the power cord(s), and power on the system.
14. Perform a CMOS clear following the BIOS recovery.

5.1.1.4 Setting Processor Frequency Jumper Block 5E1

The jumpers on block 5E1 set the processor speed for the installed processor(s). The following table lists the settings for jumper block 5E1. Procedures for setting the jumpers follow the table.

Table 5-2. Jumper Block 5E1 Settings

Processor Frequency (MHz)	Jumper Settings			
	1-2	3-4	5-6	7-8
667	Not Jumpered	Not Jumpered	Jumpered	Jumpered
733	Not Jumpered	Not Jumpered	Jumpered	Not Jumpered
800	Jumpered	Jumpered	Not Jumpered	Jumpered
867	Jumpered	Jumpered	Not Jumpered	Not Jumpered
933	Jumpered	Not Jumpered	Not Jumpered	Jumpered
1000	Jumpered	Not Jumpered	Not Jumpered	Not Jumpered

Set the processor frequency jumpers as follows.

1. Power off the system, unplug the power cord.
2. From the “Jumper Block 5E1 Settings” table, select the processor frequency matching the installed processor.
3. Move the jumpers to the settings shown in the “Jumper Block 5E1 Settings” table.
4. Reinstall the left panel, plug in the power cord(s), and power on the system.

The following table lists the factory default settings for jumper block 5E1, which are indicated in bold typeface.

Table 5-3. Jumper Block 1J15 Default Settings

Jumper Pin Numbers	Function	Jumper Position	What it does at system reset
1 - 2	Processor Frequency Select	Open	
3 - 4	Processor Frequency Select	Open	
5 - 6	Processor Frequency Select	Open	
7 - 8	Processor Frequency Select	Open	
9 - 10	133 MHz FSB	Open, Enabled	Enables 133 MHz FSB
		Closed, Disabled	Disables 133 MHz FSB
11 - 12	Spread Spectrum	Open, Disabled	Disables FCC (Spread Spectrum)
		Closed, Enabled	Enables FCC (Spread Spectrum)

5.1.2 Setting Configuration Jumper Block 1L4

Setting the jumpers on system board jumper block 1L4 enables the user to configure chassis intrusion sensors, or enable/disable BMC FRB (see the above figure for jumper block location). The following table lists the factory default settings for jumper block 1L4.

Table 5-4. Jumper Block 1L4 Settings

Jumper Pin Numbers	Function	Jumper Position	Function
1 – 2	FRB	Open, Enabled	Enables FRB
		Closed, Disabled	Disables FRB
3 – 4	Front Cover Chassis Intrusion Sensor	Open, Enabled	Enables Chassis Intrusion sensing. This jumper may be under as a chassis intrusion switch connector.
		Closed, Disabled	Disables Chassis Intrusion sensing
5 – 6	Side Cover Chassis Intrusion Sensor	Closed, Disabled	Disables Chassis Intrusion sensing
		Open, Enabled	Enables Chassis Intrusion sensing
7 – 8	No Function	Open, Not Used	No Function
9 – 10	Reserved	Open, Not Used	No Function
11 – 12	No Function	Open, Not Used	No Function
9 – 11	Spare	Closed, Spare	Provides a spare jumper

5.1.3 Setting Configuration Jumper Block 6A

Setting the jumpers on system board jumper block 6A enables the user to configure the front cover chassis intrusion sensing. Jumper 6A pins 1-2 may also be used as a chassis intrusion switch connector. The following table lists the factory default settings for jumper block 6A.

Table 5-5. Jumper Block 6A Settings

Jumper Pin Numbers	Function	Jumper Position	Function
1 – 2	Front Cover Chassis Intrusion Sensor	Open, Enabled	Enables Chassis Intrusion sensing. This jumper may be under as a chassis intrusion switch connector.
		Closed, Disabled	Disables Chassis Intrusion sensing
3 – 4	Reserved	Open, Enabled	Enables Chassis Intrusion sensing
5 – 6	No Function	Closed, Disabled	Disables Chassis Intrusion sensing
7 – 8	Reserved	Open, Not Used	No Function

5.2 Connectors

This section provides pin information about the connectors on the STL2 server board.

5.2.1 Main ATX Power Connector (P33)

Table 5-6. Main ATX Power Connector Pinout

Pin	Signal	Wire color	Pin	Signal	Wire Color
1	+3.3 VDC	Orange	13	+3.3 VDC	Orange
2	+3.3 VDC	Orange	14	-12 VDC	Blue
3	COM	Black	15	COM	Black
4	+5 VDC	Red	16	PS-ON_L	Green
5	COM	Black	17	COM	Black
6	+5 VDC	Red	18	COM	Black
7	COM	Black	19	COM	Black
8	PWR-GD	Grey	20	N.C.	N.C.
9	5 VSB	Purple	21	+5 VDC	Red
10	+12 VDC	Yellow	22	+5 VDC	Red
11	+12 VDC	Yellow	23	+5 VDC	Red
12	+3.3 VDC	Orange	24	COM	Black

5.2.2 Auxiliary ATX Power Connector (P34)

Table 5-7. Auxiliary ATX Power Connector Pinout

Pin	Signal	Wire Color
1	+5 VDC	Red
2	+3.3 VDC	Orange
3	+3.3 VDC	Orange
4	COM	Black
5	COM	Black
6	COM	Black

5.2.3 I²C Power Connector (P37)

Table 5-8. I²C Power Connector Pinout

Pin	Signal	Pin	Signal
1	N.C.	6	N.C.
2	N.C.	7	N.C.
3	+3.3 VDC	8	N.C.
4	N.C.	9	I ² C Data
5	N.C.	10	I ² C Clock

5.2.4 System Fan Connectors (P29, P27, P11)

- System Fan 1: P11
- System Fan 2: P27
- System Fan 3: P29

Table 5-9. Board Fan Connector Pinout

Pin	Signal
1	Fan Sense
2	+ 12 VDC
3	COM

5.2.5 Processor Connectors (P12, P36)

- Primary Processor Fan 1: P36
- Secondary Processor Fan 2: P12

Table 5-10. Processor Fan Connector Pinout

Pin	Signal
1	N.C.
2	+ 12 VDC
3	COM

5.2.6 Speaker Connector (P31)

Table 5-11. Speaker Connector Pinout

Pin	Signal
1	SPEAKER
2	GND

5.2.7 Speaker Connector (P25)

Table 5-12. Speaker Connector Pinout

Pin	Signal
1	SPEAKER
2	GND
3	N.C.
4	GND

5.2.8 Diskette Drive Connector (P20)

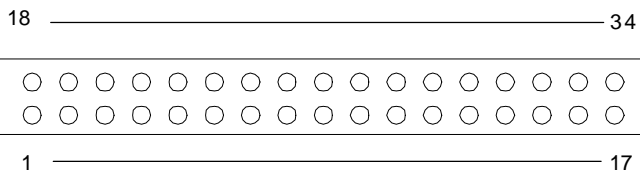

Figure 5-3. Diskette Drive Connector Pin Diagram

Table 5-13. Diskette Drive Connector Pinout

Pin	Signal	Pin	Signal
1	GND	18	FD_DENSEL
2	GND	19	No Connection
3	GND	20	FD_MDAID
4	GND	21	FD_INDEX_L
5	GND	22	FD_MON0_L
6	GND	23	FD_SEL1_L
7	GND	24	FD_SEL0_L
8	GND	25	FD_MON1_L
9	GND	26	FD_DIR_L
10	GND	27	FD_STEP_L
11	GND	28	FD_WDATA_L
12	GND	29	FD_WGATE_L
13	GND	30	FD_TRK0_L
14	GND	31	FD_WPT_L
15	GND	32	FD_RDATA_L
16	GND	33	FD_SIDE_L
17	GND	34	FD_DCHG_L

5.2.9 SVGA Video Port

Table 5-14. Video Port Connector Pinout

Pin	Signal	Pin	Signal
1	Red	9	NC
2	Green	10	GND
3	Blue	11	NC

Pin	Signal	Pin	Signal
4	NC	12	DDCDAT
5	GND	13	HSYNC
6	GND	14	VSYNC
7	GND	15	DDCCLK
8	GND		

5.2.10 Keyboard and Mouse Connectors

The keyboard and mouse connectors are functionally equivalent.

Table 5-15. Keyboard and Mouse Connector Pinouts

Pin	Keyboard Signal	Pin	Mouse Signal
1	KEYDAT	1	MSEDAT
2	GND	2	NC
3	GND	3	GND
4	FUSED_VCC (+5 V)	4	FUSED_VCC (+5 V)
5	KEYCLK	5	MSECLK
6	NC	6	NC

5.2.11 Parallel Port

Table 5-16. Parallel Port Connector Pinouts

Pin	Signal	Pin	Signal
1	STROBE_L	10	ACK_L
2	Data bit 0	11	Busy
3	Data bit 1	12	PE
4	Data bit 2	13	SLCT
5	Data bit 3	14	AUTO_L
6	Data bit 4	15	ERROR_L
7	Data bit 5	16	INIT_L
8	Data bit 6	17	SLCTIN_L
9	Data bit 7	18-25	GND

5.2.12 Serial Ports COM1 and COM2

Table 5-17. Serial Ports COM1 and COM2 Connector Pinouts

Pin	Signal	Description
1	DCD	Data carrier detected

Pin	Signal	Description
2	RXD	Receive data
3	TXD	Transmit data
4	DTR	Data terminal ready
5	GND	Ground
6	DSR	Data set ready
7	RTS	Return to send
8	CTS	Clear to send
9	RIA	Ring indication active

5.2.13 RJ-45 LAN Connector

Table 5-18. RJ-45 LAN Connector Signals

Pin	Signal	Description
1	TX+	Transmit data plus—the positive signal for the TD differential pair contains the serial output data stream transmitted onto the network
2	TX-	Transmit data minus—the negative signal for the TD differential pair contains the same output as pin 1
3	RX+	Receive data plus—the positive signal for the RD differential pair contains the serial input data stream received from the network
4	NC	
5	NC	
6	RX-	Receive data minus—the negative signal for the RD differential pair contains the same input as pin 3
7	NC	
8	NC	

5.2.14 USB Connectors

Table 5-19. USB Connectors

USB 1 Pin	Signal	USB 2 Pin	Signal
1	+5 VDC	1	+5 VDC
2	USB_P1_N	2	USB_P0_N
3	USB_P1_P	3	USB_P0_P
4	GND	4	GND

5.2.15 Ultra SCSI Connector (P9)

Table 5-20. Ultra SCSI Connector Pinout

Pin	Signal	Pin	Signal
1-16	GND	49-50	GND
17	TERMPWR	51	TERMPWR
18	TERMPWR	52	TERMPWR
19	NC	53	NC
20-34	GND	54	GND
35	SCD12_L	55	SATN_L
36	SCD13_L	56	GND
37	SCD14_L	57	SBSY_L
38	SCD15_L	58	SACK_L
39	SCDPH_L	59	RESET_L
40	SCD0_L	60	SMSG_L
41	SCD1_L	61	SSEL_L
42	SCD2_L	62	SCD_L
43	SCD3_L	63	SREQ_L
44	SCD4_L	64	SI/O_L
45	SCD5_L	65	SCD8_L
46	SCD6_L	66	SCD9_L
47	SCD7_L	67	SCD10_L
48	SCDP_L	68	SCD11_L

5.2.16 Ultra160 SCSI Connector (P8)

Table 5-21. Ultra160 SCSI Connector

Pin	Signal	Pin	Signal
1	SCDAP12	35	SCDAN12_L
2	SCDAP13	36	SCDAN13_L
3	SCDAP14	37	SCDAN14_L
4	SCDAP15	38	SCDAN15_L
5	SCDAPHP	39	SCDAPHN_L
6	SCDAP0	40	SCDAN0_L
7	SCDAP1	41	SCDAN1_L
8	SCDAP2	42	SCDAN2_L
9	SCDAP3	43	SCDAN3_L
10	SCDAP4	44	SCDAN4_L
11	SCDAP5	45	SCDAN5_L
12	SCDAP6	46	SCDAN6_L
13	SCDAP7	47	SCDAN7_L
14	SCDAPLP	48	SCDAPLN_L

Pin	Signal	Pin	Signal
15	GND	49	GND
16	DIFFSENSA	50	GND
17	TRMPWRA	51	TRMPWRA
18	TRMPWRA	52	TRMPWRA
19	No Connection	53	No Connection
20	GND	54	GND
21	ATNAP	55	ATNAN_L
22	GND	56	GND
23	BSY	57	BSYAN_L
24	ACK	58	ACKAN_L
25	RSTAP	59	RSTAN_L
26	MSGAP	60	MSGAN_L
27	SELAP	61	SELAN_L
28	CDAP	62	CDAN_L
29	REQAP	63	REQAN_L
30	IOAP	64	IOAN_L
31	SCDAP8	65	SCDAN8_L
32	SCDAP9	66	SCDAN9_L
33	SCDAP10	67	SCDAN10_L
34	SCDAP11	68	SCDAN11_L

5.2.17 IDE Connector (P19)

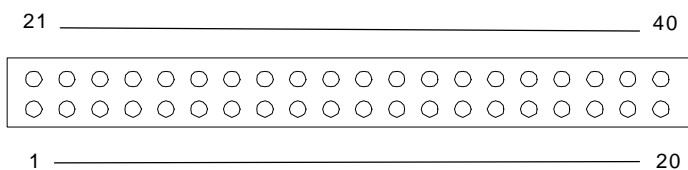

Figure 5-4. IDE Connector Pin Diagram

If no IDE drives are present, no IDE cable should be connected. If a single IDE drive is installed, it must be connected at the end of the cable.

Table 5-22. IDE Connector Pinout

Pin	Signal	Pin	Signal
1	RESET_L	21	GND
2	DD7	22	DD8
3	DD6	23	DD9
4	DD5	24	DD10

Pin	Signal	Pin	Signal
5	DD4	25	DD11
6	DD3	26	DD12
7	DD2	27	DD13
8	DD1	28	DD14
9	DD0	29	DD15
10	GND	30	No Connection
11	IDEDRQ	31	GND
12	DIOW_L	32	GND
13	DIOR_L	33	GND
14	IORDY	34	GND
15	IDEDAK_L	35	GND
16	IDEIRQ	36	No Connection
17	IDESA1	37	No Connection
18	IDESA0	38	IDESA2
19	IDECS0_L	39	IDECS1_L
20	Keyed	40	GND

5.2.18 32-Bit PCI Connector

Table 5-23. 32-Bit PCI Connector Pinout

Pin	Signal	Pin	Signal	Pin	Signal	Pin	Signal
A1	TRST_L	B1	-12 V	A32	AD16	B32	AD17
A2	+12 V	B2	TCK	A33	+3.3 V	B33	CBE2_L
A3	TMS	B3	GND	A34	FRAME_L	B34	GND
A4	TDI	B4	TD0 (NC)	A35	GND	B35	IRDY_L
A5	+5 V	B5	+5 V	A36	TRDY_L	B36	+3.3 V
A6	INTA_L	B6	+5 V	A37	GND	B37	DEVSEL_L
A7	INTC_L	B7	INTB_L	A38	STOP_L	B38	GND
A8	+5 V	B8	INTD_L	A39	+3.3 V	B39	LOCK_L
A9	Reserved	B9	PRSNT1_L	A40	SDONE	B40	PERR_L
A10	+5 V	B10	Reserved	A41	SBO_L	B41	+3.3 V
A11	Reserved	B11	PRSNT2_L	A42	GND	B42	SERR_L
A12	GND	B12	GND	A43	PARITY	B43	+3.3 V
A13	GND	B13	GND	A44	AD15	B44	CBE1_L
A14	Reserved	B14	Reserved	A45	+3.3 V	B45	AD14
A15	RST_L	B15	GND	A46	AD13	B46	GND
A16	+5 V	B16	PCICLK	A47	AD11	B47	AD12
A17	GNT_L	B17	GND	A48	GND	B48	AD10
A18	GND	B18	REQ_L	A49	AD9	B49	GND
A19	PME_L	B19	+5 V	A50	KEY	B50	KEY
A20	AD30	B20	AD31	A51	KEY	B51	KEY

A21	+3.3 V	B21	AD29	A52	CBE0_L	B52	AD8
A22	AD28	B22	GND	A53	+3.3 V	B53	AD7
A23	AD26	B23	AD27	A54	AD6	B54	+3.3 V
A24	GND	B24	AD25	A55	AD4	B55	AD5
A25	AD24	B25	+3.3 V	A56	GND	B56	AD3
A26	IDSEL	B26	CBE3_L	A57	AD2	B57	GND
A27	+3.3 V	B27	AD23	A58	AD0	B58	AD1
A28	AD22	B28	GND	A59	+5 V	B59	+5 V
A29	AD20	B29	AD21	A60	REQ64_L	B60	ACK64_L
A30	GND	B30	AD19	A61	+5 V	B61	+5 V
A31	AD18	B31	+3.3 V	A62	+5 V	B62	+5 V

5.2.19 64-Bit PCI Connector

Table 5-24. 64-Bit PCI Connector Pinout

Pin	Signal	Pin	Signal	Pin	Signal	Pin	Signal
A1	TRST_L	B1	-12 V	A48	GND	B48	AD10
A2	+12 V	B2	TCK	A49	AD9	B49	M66EN
A3	TMS	B3	GND	A50	KEY	B50	KEY
A4	TDI	B4	TD0 (NC)	A51	KEY	B51	KEY
A5	+5 V	B5	+5 V	A52	CBE0_L	B52	AD8
A6	INTA_L	B6	+5 V	A53	+3.3 V	B53	AD7
A7	INTC_L	B7	INTB_L	A54	AD6	B54	+3.3 V
A8	+5 V	B8	INTD_L	A55	AD4	B55	AD5
A9	Reserved	B9	PRSNT1_L	A56	GND	B56	AD3
A10	+5 V	B10	Reserved	A57	AD2	B57	GND
A11	Reserved	B11	PRSNT2_L	A58	AD0	B58	AD1
A12	GND	B12	GND	A59	+5 V	B59	+5 V
A13	GND	B13	GND	A60	REQ64_L	B60	ACK64_L
A14	Reserved	B14	Reserved	A61	+5 V	B61	+5 V
A15	RST_L	B15	GND	A62	+5 V	B62	+5 V
A16	+5 V	B16	PCICLK	A63	GND	B63	Reserved
A17	GNT_L	B17	GND	A64	CBE7_L	B64	GND
A18	GND	B18	REQ_L	A65	CBE5_L	B65	CBE6_L
A19	PME_L	B19	+5 V	A66	+3.3 V	B66	CBE4_L
A20	AD30	B20	AD31	A67	Parity	B67	GND
A21	+3.3 V	B21	AD29	A68	AD62	B68	AD63
A22	AD28	B22	GND	A69	GND	B69	AD61
A23	AD26	B23	AD27	A70	AD60	B70	+3.3 V
A24	GND	B24	AD25	A71	AD58	B71	AD59
A25	AD24	B25	+3.3 V	A72	GND	B72	AD57
A26	IDSEL	B26	CBE3_L	A73	AD56	B73	GND

Pin	Signal	Pin	Signal	Pin	Signal	Pin	Signal
A27	+3.3 V	B27	AD23	A74	AD54	B74	AD55
A28	AD22	B28	GND	A75	+3.3 V	B75	AD53
A29	AD20	B29	AD21	A76	AD52	B76	GND
A30	GND	B30	AD19	A77	AD50	B77	AD51
A31	AD18	B31	+3.3 V	A78	GND	B78	AD49
A32	AD16	B32	AD17	A79	AD48	B79	+3.3 V
A33	+3.3 V	B33	CBE2_L	A80	AD46	B80	AD47
A34	FRAME_L	B34	GND	A81	GND	B81	AD45
A35	GND	B35	IRDY_L	A82	AD44	B82	GND
A36	TRDY_L	B36	+3.3 V	A83	AD42	B83	AD43
A37	GND	B37	DEVSEL_L	A84	+3.3 V	B84	AD41
A38	STOP_L	B38	GND	A85	AD40	B85	GND
A39	+3.3 V	B39	LOCK_L	A86	AD38	B86	AD39
A40	SDONE	B40	PERR_L	A87	GND	B87	AD37
A41	SBO_L	B41	+3.3 V	A88	AD36	B88	+3.3 V
A42	GND	B42	SERR_L	A89	AD34	B89	AD35
A43	PARITY	B43	+3.3 V	A90	GND	B90	AD33
A44	AD15	B44	CBE1_L	A91	AD32	B91	GND
A45	+3.3 V	B45	AD14	A92	Reserved	B92	Reserved
A46	AD13	B46	GND	A93	GND	B93	Reserved
A47	AD11	B47	AD12	A94	Reserved	B94	GND

5.2.20 Front Panel 24-pin Connector Pinout (P23)

Table 5-25. Front Panel 24-pin Connector Pinout

Pin	Description
1	Power LED Anode
2	Reserved
3	Key
4	Fan Fault LED Anode
5	Power LED Cathode
6	Fan Fault LED Cathode
7	Hard Drive Activity LED Anode
8	Power Fault LED Anode
9	Hard Drive Activity LED Cathode
10	Power Fault LED Cathode
11	Power Switch (Low True)
12	NIC Activity LED Anode
13	Power Switch (GND)
14	NIC Activity LED Cathode
15	Reset Switch (Low True)

16	Reserved
17	Reset Switch (GND)
18	Reserved
19	ACPI Sleep Switch (Low True)
20	Chassis Intrusion
21	ACPI Sleep Switch (GND)
22	Reserved
23	NMI to CPU Switch (Low True)
24	Reserved

< This page intentionally left blank >

6. Power Consumption

6.1 Calculated Power Consumption

The following table shows the calculated power consumption for each of the power supply voltage rails for the STL2 server board. These values were calculated using the specifications for the on-board components and processors. Assumptions for add-in card power and other peripherals powered from the server board are included in the table. Customers will need to modify the calculated power consumption numbers based on their anticipated usage – watts per PCI slot, etc.

Note: The following numbers are provided only as an example. Actual power consumption will vary depending on the exact configuration, temperature, voltage level, etc. Refer to the appropriate system chassis document for more information.

Table 6-1. STL2 Server Board Calculated Power Consumption

Device(s)	3.3V	+5V	+12V	-12V	5V Standby	Totals
Server Board	4.6A	12.5A	0.06A	0.0A	0.18A	
Processors (87% VRM efficiency, 100% utilization)						
1 x 667 MHz/256K processor		4.02A				
1 x 733 MHz/256K processor		4.21A				
1x 800EB MHz/256K processor		4.78A				
1x 866 MHz/256K processor		5.26A				
1x 933 MHz/256K processor		5.63A				
1x 1 GHz/256K processor		6.0A				
Memory (Four PC133 Registered GB SDRAM DIMMs)	5.5A					
PCI Connectors						
32 bit PCI slots (10W per slot on 5V)		8.0A			0.4A	
64 bit PCI slots (10W per slot on 3.3V)	6.06A				0.2A	
USB (500mA per connector)		1.00A				
Keyboard/Mouse		0.50A				
SCSI term power		Included in board spec.				
Fans (3 chassis and 2 processor)			1.32A			
Total Current	16.16A	34.0A	1.38A	0.0A	0.78A	Total
Total Power	53.33W	170.0W	16.6W	0.0W	3.9W	243.83W

The total power calculation assumes a system configuration containing dual Pentium® III 1 GHz processors with the VRM for both processors supplied by the 5V source, four 1 GHz DIMMs, all PCI slots containing 10W cards, two USB devices, keyboard & mouse, three chassis fans, and two processor fan heat sinks.

6.2 Measured Power Consumption

A STL2 FAB 2 server board was configured with dual 866 MHz processors, both supplied by the 5V voltage regulation modules (VRMs), and four 1GB PC133 SDRAM DIMMs (Infineon part number HYS72V128320GR).

The system was configured with Microsoft Windows NT 4.0. Test software utilized during the power consumption measurement consisted of the Hipower test suite, used to simulate medium processor activity, and the WinMTA memory stress test suite, used to simulate high memory activity.

The STL2 server board measured power consumption including the memory and processor power is listed in the following table.

Table 6-2. STL2 Server Board Measured Power Consumption

Device(s)	3.3V	+5V	+12V	Total Wattage
Server Board	6.0A	8.5A	0.01A	63.5W

7. Mechanical Specifications

The diagram on the following page shows the mechanical specifications of the STL2 server board. All dimensions are in inches. Connectors are dimensioned to pin 1.

< This page intentionally left blank >

8. Regulatory and Integration Information

8.1 Regulatory Compliance

The STL2 server board complies with the following safety standard requirements.

Table 8-1. Safety Regulations

Regulation	Title
UL 1950/CSA950	Bi-National Standard for Safety of Information Technology Equipment including Electrical Business Equipment. (USA and Canada)
EN 60950	The Standard for Safety of Information Technology Equipment including Electrical Business Equipment. (European Community)
IEC60 950	The Standard for Safety of Information Technology Equipment including Electrical Business Equipment. (International)
EMKO-TSE (74-SEC) 207/94	Summary of Nordic deviations to EN 60950. (Norway, Sweden, Denmark, and Finland)
EU Low Voltage Directive 73/23/ECC	Compliance to EU LV Directive via EN60 950 / IEC 60950

The STL2 server board has been tested and verified to comply with the following EMC regulations when installed in a compatible Intel host system. For information on Intel compatible host system(s), refer to Intel's Server Builder website, or contact your local Intel representative.

Regulation	Title
FCC – Class A	Title 47 of the Code of Federal Regulations, Parts 2 and 15, Subpart B, pertaining to unintentional radiators. (USA)
ICES-003 – Class A	Interference-Causing Equipment Standard, Digital Apparatus, Class A (including CRC c. 1374) (Canada).
CISPR 22	Limits and methods of measurement of Radio Interference Characteristics of Information Technology Equipment. (International)
VCCI – Class A	Implementation Regulations for Voluntary Control of Radio Interference by Data Processing Equipment and Electronic Office Machines. (Japan)
EN55022	Limits and methods of measurement of Radio Interference Characteristics of Information Technology Equipment. (Europe)
EN55024	Generic Immunity Standard; currently compliance is determined via testing to IEC 801-2, -3, and -4. (Europe)
EU EMC Directive	
89/336/EEC	Compliance to EU EMC Directive via EN55022 & EN55024
BSMI (CNS13438) – Class A	Taiwan EMC Regulations based on CISPR 22
C-tick (AS/NZS 3548)	Australia & New Zealand EMS Regulations based on CISPR 22

This server board assembly has the following required certification type markings:

- UL Joint Recognition Mark: Consists of small c (for Canada) followed by a stylized backward UR and followed by a small US (USA) (on component side).

- Intel's UL File Number E139761 (Component side).
- Battery "+" marking: located on the component side of the board in close proximity to the battery holder.
- CE Mark: (Component side)
- Australian C-Tick Mark: Consists of solid circle with white check mark and supplier code N232.
- Russian GOST (Open letter "C" with the letter "P" inside the "C" and the letter "T" in the mouth of the "C").
- Taiwan BSMI Certification mark. Two Chinese characters and an 8 digit number.

8.2 Installation Instructions

CAUTION: Follow these guidelines to meet safety and regulatory requirements when installing this board assembly.

Read and adhere to these instructions and to the instructions supplied with the host computer and associated modules. If the instructions for the host computer are inconsistent with these instructions or the instructions for associated modules, contact the supplier's technical support to find out how to ensure that the system meets safety and regulatory requirements. If the instructions are not followed, the user increases safety risk and the possibility of noncompliance with regional laws and regulations.

8.2.1 Ensure EMC

Before computer integration, the host chassis, power supply, and other modules should pass EMC certification testing.

In the installation instructions for the host chassis, power supply, and other modules, pay close attention to the following:

- Certifications.
- External I/O cable shielding and filtering.
- Mounting, grounding, and bonding requirements.
- Keying connectors when mismatching of connectors could be hazardous.

If the host chassis, power supply, and other modules have not passed applicable EMC certification testing before integration, EMC testing must be conducted on a representative sample of the newly completed computer.

8.2.2 Ensure Host Computer and Accessory Module Certifications

The host computer and any added subassembly (such as a board or drive assembly, including internal or external wiring) should be certified for the region(s) where the end product will be used. Marks on the product are proof of certification. Certification marks are as follows:

8.2.2.1 In Europe

The CE marking signifies compliance with all relevant European requirements. If the host computer does not bear the CE marking, obtain a supplier's Declaration of Conformity to the appropriate standards required by the European EMC Directive and Low Voltage Directive. Other directives, such as the Machinery and Telecommunications Directives, may also apply depending on the type of product. No regulatory assessment is necessary for low voltage DC wiring used internally or wiring used externally when provided with appropriate overcurrent protection. Appropriate protection is provided by a maximum 8 Amp current limiting circuit or a maximum 5 Amp fuse or positive temperature coefficient (PTC) resistor. This Intel server board has PTCs on all external ports that provide DC power externally.

8.2.2.2 In the United States

A certification mark by a Nationally Recognized Testing Laboratory (NRTL) such as UL, CSA, or ETL signifies compliance with safety requirements. External wiring must be UL Listed and suitable for the intended use. Internal wiring must be UL Listed or Recognized and rated for applicable voltages and temperatures. The FCC mark (Class A for commercial or industrial only or Class B for residential) signifies compliance with electromagnetic interference requirements.

8.2.2.3 In Canada

A nationally recognized certification mark such as CSA or cUL signifies compliance with safety requirements. No regulatory assessment is necessary for low voltage DC wiring used internally or wiring used externally when provided with appropriate overcurrent protection. Appropriate protection is provided by a maximum 8 Amp current limiting circuit or a maximum approved 5 Amp fuse or positive temperature coefficient (PTC) resistor. This server board has PTCs on all external ports that provide DC power externally.

8.2.3 Prevent Power Supply Overload

The power supply output must not be overloaded. To avoid overloading the power supply, the calculated total current load of all the modules within the computer should be less than the maximum output current rating of the power supply. If this is not adhered to, the power supply may overheat, catch fire, or damage the insulation that separates hazardous AC line circuitry from low voltage user accessible circuitry and result in a shock hazard. If the load drawn by a module cannot be determined by the markings and instructions supplied with the module, contact the module supplier's technical support.

8.2.4 Place Battery Marking on Computer

There is insufficient space on this server board to provide instructions for replacing and disposing of the battery. The following warning must be placed permanently and legibly on the host computer as near as possible to the battery.

WARNING: Danger of explosion if battery is incorrectly replaced.

Replace with only the same or equivalent type recommended by the manufacturer. Dispose of used batteries according to the manufacturer's instructions.

8.2.5 Use Only for Intended Applications

This product was evaluated for use in ITE computers that will be installed in offices, schools, computer rooms and similar locations. The suitability of this product for other product categories other than ITE applications, (such as medical, industrial, alarm systems, and test equipment) may require further evaluation.

8.2.6 Installation Precautions

During the installation and testing of the board, the user should observe all warnings and cautions in the installation instructions. To avoid injury, be aware of the following:

- Sharp pins on connectors.
- Sharp pins on printed circuit assemblies.
- Rough edges and sharp corners on the chassis.
- Hot components (like processors, voltage regulators, and heat sinks).
- Damage to wires that could cause a short circuit.
- Observe all warnings and cautions that instruct you to refer computer servicing to qualified technical personnel.

WARNING: Do not open the power supply. There is risk of electric shock and burns from high voltage and rapid overheating. Refer servicing of the power supply to qualified technical personnel.

8.3 Environmental Limits

8.3.1 System Office Environment

Table 8-2. Office System Environment Summary

Operating Temperature	+10°C to +35°C with the maximum rate of change not to exceed 10°C per hour
Non-Operating Temperature	-40°C to +70°C
Non-Operating Humidity	95%, non-condensing @ 30°C
Altitude De-rate	0.5° per 1000 feet
Acoustic noise	< 47 dBA with one power supply @ 28+-2°C
< 50 dBA with two power supplies @ 28+-2°C	
< 55 dBA with three power supplies @ 28+-2°C	
Operating Shock	No errors with a half sine wave shock of 2G (with 11 millisecond duration)
Package Shock	System operational after a 30" free fall, cosmetic damage may be present
ESD	20KV per Intel Environmental Test Specification

8.3.2 System Environmental Testing

The system environmental tests include the following:

- Temperature Operating and Non-Operating
- Humidity Non-Operating
- Shock Packaged and Unpackaged
- Vibration Packaged and Unpackaged
- AC Voltage, Freq. & Source Interrupt
- AC Surge
- Acoustics
- ESD

< This page intentionally left blank >

Glossary

Term	Definition
ASIC	Application Specific Integrated Circuit
ASR	Asynchronous Reset
BMC	Baseboard Management Controller
BSP	Bootstrap Processor
EMP	Emergency Management Port
ESCD	Extended System Configuration Data
FRB	Fault Resilient Booting
FRU	Field Replaceable Unit
HPIB	Hot-plug Indicator Board
IMB	Intra Module Bus
IPMB	Intelligent Platform Management Bus
MADP	Memory Address and Data Path
MBE	Multiple Bit Error
MEC	Memory Expansion Card
MECC	Memory Expansion Card Connector
MP	Multiprocessor
MSR	Model Specific Register
MTTR	Mean Time To Repair
NIC	Network Interface Card
NMI	Non-maskable Interrupt
OS	Operating System
PHP	PCI Hot-plug
PHPC	PCI Hot-plug Controller
PME	Power Management Event
POST	Power On Self Test
RAMDAC	Random Access Memory Digital-to-Analog Converter
RTC	Real Time Clock
SBE	Single Bit Error
SEC	Single Edge Contact
SEL	System Event Log
SGRAM	Synchronous Graphics RAM
SHV	Standard High Volume
SM	Server Management
SMM	Server Management Module
SSU	System Setup Utility
TAP	Test Access Port
TBD	To Be Determined
USB	Universal Serial Bus
ZCR	Zero Channel RAID

Reference Documents

- *ServerWorks ServerSet* III LE North Bridge Specification.*
- *ServerWorks ServerSet* III LE South Bridge Specification.*
- *PCI Local Bus Specification, Revision 2.2.*
- *USB Specification, Revision 1.0.*
- *5-Volt Flash File (28F008SAx8) Datasheet.*
- *AIC-7899 PCI-Dual Channel SCSI Multi-function Controller Data Manual.*
- *ATI Rage IIC Technical Reference Manual.*
- *I²C Bus Specification.*
- *Intelligent Platform Management Bus Communications Protocol Specification.*
- *VRM 8.4 DC-DC Converter Specification.*
- *Adaptec AIC-7899 PCI Bus Master Dual-channel Ultra160 SCSI Host Adapter Chip Data Book.*
- *Intel[®] 82559 Fast Ethernet Multifunction PCI/CardBus Controller Datasheet.*
- *Intelligent Platform Management Interface (IPMI) Specification.*

Index

A

ACPI, 2-7, 3-23, 3-25, 3-26, 4-49, 5-73
 Adaptec* AIC7899, 1-1, 2-8
 Address, 2-9, 2-13, 2-17, 3-25, 4-39, 4-52
 AIC-7899, 2-8, 2-9, 2-10, 2-20, 4-40
 APIC, 2-6, 2-10, 2-14, 2-15, 2-17
 Architecture, 2-5
 ATI* Rage IIC, 2-12, 2-13, 2-20

B

Baseboard Management Controller. *See* BMC
 BIOS, 1-2, 2-8, 2-10, 2-14, 2-16, 2-17, 3-21, 3-22, 3-26,
 4-27, 4-28, 4-29, 4-32, 4-34, 4-40, 4-41, 4-42, 4-43,
 4-44, 4-45, 4-46, 4-47, 4-48, 4-49, 4-50, 4-51, 4-52,
 4-53, 4-55, 5-60, 5-61
 BIST, 3-24
 BMC, 1-2, 2-5, 2-14, 2-16, 3-21, 3-23, 3-24, 3-25, 4-51,
 4-52, 4-53, 5-62, I
 Bridge, 1-1, 2-6, 2-7, 2-10, 2-14, 2-15, 2-17, 2-20
 Built-in Self Test, 3-24

C

Certification, 8-80
 Chassis Intrusion, 3-22, 3-23, 5-59, 5-63, 5-73
 Checksum, 4-46, 4-52
 CMOS, 2-16, 4-27, 4-28, 4-29, 4-40, 4-41, 4-42, 4-43,
 4-47, 4-48, 4-50, 5-59, 5-60, 5-61
 CMOS Clear Jumper, 5-59
 Configuration, 2-9, 2-13, 3-25, 4-28, 4-29, 4-31, 4-34,
 4-35, 4-41, 4-52, 4-54, 4-55, 5-58, 5-59, 5-62, 5-63
 Connection, 3-23, 4-39, 5-66, 5-69, 5-70, 5-71
 Connector, Drive, 5-66
 Connector, Fan, 5-65
 Connector, PCI, 5-71, 5-72, 6-75
 Connector, Power, 5-64
 Console Redirect, 4-38, 4-39
 Console Redirection, 4-28, 4-38, 4-39
 Controller, 1-2, 2-8, 2-9, 2-10, 2-12, 2-13, 2-15, 3-21,
 4-35, 4-47, 4-50, 4-52
 Core Component, 2-5

D

DC-to-DC converter, 2-6
 DIMM, 1-1, 2-7, 4-34, 4-45, 4-51, 4-52, 5-57

E

ECC, 1-1, 2-7, 3-22, 3-23, 3-24, 4-50, 8-79
 EEPROM, 2-9
 Emergency Management Port, *See* EMP
 EMP, 3-25, 4-51
 Environmental Limits, 8-82
 Error, 3-22, 3-23, 3-24, 3-25, 4-33, 4-34, 4-38, 4-46, 4-50,
 4-51, 4-52
 ESM, *See* Enterprise System Management Console, 3-24
 Ethernet, 1-2, 2-10
 Exit Menu, 4-29, 4-32, 4-40

F

Fan, 3-23, 6-75
 Fan, 2-6, 3-22, 3-23, 5-65, 5-73
 Fan, System, 5-65
 Fault Resilient Booting, *See* FRB
 FC-PGA, 1-1, 2-5, 2-6
 Field Replaceable Unit, *See* FRU
 Flash ROM, 4-28, 4-41, 4-45
 Flip Chip Pin Grid Array, 1-1
 FRB, 3-21, 5-62, 5-63
 Front Panel, 3-23, 3-24, 5-73
 Front Panel reset, 3-23, 3-24, 3-25, 4-34, 4-41, 4-47, 4-55,
 5-73
 Front Side Bus, 1-1
 FRU, 3-21, 4-51

G

GPIO, 2-7

I

I²C, 3-25, 5-64
 IB6566 South Bridge, 1-1, 1-2, 2-6, 2-7, 2-10, 2-14, 2-15,
 2-16, 2-17, 2-20
 ICH, 2-11
 Initialization, 3-24, 4-38, 4-52, 4-55
 Install, 4-48
 Intel® 82559, 1-2, 2-10, 2-11, 2-20
 Intel® Celeron™ processor, 2-5
 Intelligent Platform Management Bus, *See* IPMB
 Interrupt Controller, 2-15, 4-47
 IPMB, 4-51
 IRQ 12, 2-20

ISA, 2-14, 2-15, 2-16, 2-17, 3-21, 3-24, 4-48

J

JEDEC, 1-1, 2-7

L

LED, 5-73
Legacy, 2-15, 4-40
Logo, 4-41
LUN, 4-55

M

Magic Packet, 3-22
Main Menu, 4-29, 4-30, 4-31, 4-32
Management Controller, 4-51, 4-53
Memory, 2-5, 2-7, 2-9, 2-13, 2-17, 3-22, 3-24, 4-34, 4-40, 4-50, 4-51, 4-52, 6-75
Message, 4-50
Modem, 4-39
MPS, 4-28, 4-34
Multi-Processor Specification, 4-28, 4-34

N

NB6635 North Bridge, 1-1, 2-7, 2-20
NMI, 3-23, 3-24, 4-38, 5-58, 5-73
North Bridge, 1-1, 2-7, 2-20
NVRAM, 4-29, 4-40, 4-41, 4-50

P

Password, 3-23, 4-37, 4-41, 4-51, 5-59, 5-60
Password Clear, 5-59
PERR, 3-23, 3-24, 4-38, 5-71, 5-72
PGA370, 1-1, 2-5, 2-6
PIC, 2-15, 2-17, 2-18, 4-36, 4-50
POST, 3-22, 3-24, 3-25, 4-29, 4-30, 4-33, 4-34, 4-42, 4-43, 4-44, 4-46, 4-47, 4-49, 4-50, 4-52, 4-53, 5-60, 5-61
POST Code, 4-46
Power Button, 3-23, 3-24
Power Control, 3-22
Power Distribution Board, 3-22
Power Down, 3-25
Power state, 3-25
Power Supply, 3-22, 5-57
Power-on Self-Test
 See POST, 3-22, 3-24, 3-25, 4-29, 4-30, 4-33, 4-34,

4-42, 4-43, 4-44, 4-46, 4-47, 4-49, 4-50, 4-52, 4-53, 5-60, 5-61
PXE, 3-23, 3-24, 4-39

R

Real Time Clock, *See* RTC
Recovery, 4-45, 4-49, 5-60, 5-61
Redirection, 4-38
Reset Button, 3-23, 3-24
RTC, 2-15, 3-25, 4-43, 4-51

S

SC242, 2-5
SC242 connector, 2-5
SCSI, 1-1, 2-5, 2-8, 2-9, 2-10, 2-20, 3-23, 4-27, 4-28, 4-35, 4-36, 4-37, 4-41, 4-53, 4-54, 4-55, 5-58, 5-68, 5-69, 6-75
SCSI Connector, 4-54, 5-68, 5-69
SDR, 3-21, 4-51
SDR Repository, 3-21, 4-51
SDRAM, 1-1, 2-7, 6-75, 6-76
Secure Mode, 3-22, 3-23, 4-37, 4-38
SecureBIOS, 4-28
Security, 3-22, 3-23, 4-28, 4-29, 4-31, 4-37
Processor, 2-5, 2-6, 3-22, 3-23, 3-24, 3-25, 4-32, 4-33, 4-47, 4-48, 5-59, 5-61, 5-62, 5-65
SEL, 3-21, 3-23, 3-24, 4-51
Sensor, 3-21, 3-22
Sensor Data Record, *See* SDR
Sensor Event, 3-21, 3-23, 3-24, 4-38
Sensor, Chassis Intrusion, 5-58
Sensor, Fan, 2-6, 3-22, 3-23, 5-65, 5-73
Sensor, Processor, 2-5, 2-6, 3-22, 3-23, 3-24, 3-25, 4-32, 4-33, 4-47, 4-48, 5-59, 5-61, 5-62, 5-65
Sensor, Temperature, 3-22, 3-23, 4-51, 8-82
Sensor, Type, 3-22, 3-23
Sensor, Type Code, 3-23
Sensor, Voltage, 3-22, 3-23, 8-79, 8-80, 8-82
Serial, 1-2, 2-16, 4-33, 4-35, 4-39, 5-58, 5-67
SERR, 3-23, 3-24, 5-71, 5-73
Server Management, 3-21
Server Menu, 4-38
ServerWorks ServerSet III LE chipset, 1-1, 2-5, 2-7
Setup Utility, 3-26, 4-27, 4-28, 4-29, 4-30, 4-41, 5-60
SGRAM, 1-2, 2-10, 2-12
Shadow, 4-47, 4-48, 4-49, 4-50, 4-52
Shutdown, 4-49
SMBIOS, 4-51
SMI, 3-21, 3-23, 3-25
SMM, 4-45
South Bridge, 1-1, 1-2, 2-6, 2-7, 2-10, 2-14, 2-15, 2-17, 2-20
Speaker, 5-65
SSU, 4-27, 4-29

Super I/O Controller, 1-2
System Event Log, *See* SEL
System Management Software, 3-21
System Setup Utility, *See* SSU

T

Temperature, 3-22, 3-23, 4-51, 8-82
termination circuitry, 2-6
Third-party instrumentation, 1-1, 2-8, 2-20, 4-53, 4-54,
4-55
Timeout, 3-23, 3-24, 3-25
Transfer Mode, 4-33
Type Code 3-23

U

Ultra160 LVD, 5-58
Universal Serial Bus, 1-2, 2-7, 2-10, 2-14, 2-15, 2-17,
4-35, 4-48, 5-58, 5-68, 6-75, 6-76

USB, 1-2, 2-7, 2-10, 2-14, 2-15, 2-17, 4-35, 4-48, 5-58,
5-68, 6-75, 6-76
User Binary, 4-44, 4-45

V

Voltage, *See also* Sensor, Voltage, 3-22, 3-23, 8-79, 8-80,
8-82
VRM, 1-1, 2-6, 5-57, 6-75, 6-76

W

Warning, 4-52
Windows NT, 3-26, 6-76

Z

zero-insertion force socket, 2-5, 2-6
ZIF socket, 2-6

Free Manuals Download Website

<http://myh66.com>

<http://usermanuals.us>

<http://www.somanuals.com>

<http://www.4manuals.cc>

<http://www.manual-lib.com>

<http://www.404manual.com>

<http://www.luxmanual.com>

<http://aubethermostatmanual.com>

Golf course search by state

<http://golfingnear.com>

Email search by domain

<http://emailbydomain.com>

Auto manuals search

<http://auto.somanuals.com>

TV manuals search

<http://tv.somanuals.com>