

**Express 5800 TM700**

	■	■	■	■	■	■	■
	■	■	■	■	■	■	■
	■	■	■	■	■	■	■
	■	■	■	■	■	■	■
	■	■	■	■	■	■	■
	■	■	■	■	■	■	■
	■	■	■	■	■	■	■
	■	■	■	■	■	■	■
	■	■	■	■	■	■	■
	■	■	■	■	■	■	■
	■	■	■	■	■	■	■
	■	■	■	■	■	■	■
	■	■	■	■	■	■	■
	■	■	■	■	■	■	■
	■	■	■	■	■	■	■
	■	■	■	■	■	■	■
	■	■	■	■	■	■	■
	■	■	■	■	■	■	■
	■	■	■	■	■	■	■
	■	■	■	■	■	■	■
	■	■	■	■	■	■	■
<b>User's Guide</b>	■	■	■	■	■	■	■



# Table of Contents

Table of Contents	i
Using This Guide	iii
Text Conventions	iv
Related Documents	v
Safety Notices	vi
Safety Notices for Users Outside of the U.S.A. and Canada	vii
Care and Handling	viii
<b>System Overview</b>	<b>1-1</b>
Overview	1-2
System Features	1-3
System Chassis Features	1-4
Front View	1-4
Rear View	1-5
<i>System Connectors</i>	1-6
<i>RJ45 Leds</i>	1-6
<i>Expansion Board Slots</i>	1-6
Internal View	1-7
Motherboard	1-8
Standard Features	1-10
PCI Slots	1-10
Peripheral Bays	1-11
Optional Features	1-12
CD-ROM Drive	1-12
DVD-ROM Drive	1-12
DVD-ROM CD-RW Combination Drive	1-13
Intel Pro 1000 MT LAN Board	1-14
E-IDE Hard Disk Drive	1-14
S-ATA Hard Disk Drive	1-15
Video Board	1-15
<i>nVidia Quadro FX 500</i>	1-15
<i>nVidia Quadro4 8x 380 XGL</i>	1-15
<i>PCI Video Board</i>	1-16
Sony AIT1 Tape Backup Unit	1-16
EXPRESSBUILDER CD-ROM	1-18
With the EXPRESSBUILDER CD you can:	1-18
What is on the CD that you may need to use	1-18
Software End-User License Agreement	1-18
LICENSE	1-19
TERM	1-19
LIMITED WARRANTY	1-19
LIMITATIONS OF REMEDIES	1-20
<b>Setting Up the System</b>	<b>2-1</b>
Overview	2-2
Selecting a Site	2-3

Unpacking the System	2-4
Making Connections	2-5
Connecting the Power Cord	2-6
Using the System	2-7
Powering On Your System	2-8
Powering Off the Server System	2-9
Forcing a Power Shutdown	2-9
<b>Configuring Your System</b>	<b>3-1</b>
Configuring Your System	3-2
BIOS Setup Utility	3-3
Using the BIOS Setup Utility	3-3
BIOS Setup Configuration Settings	3-4
Main Menu	3-5
<i>Primary and Secondary Master and Slave IDE Submenus</i>	3-5
<i>IDE Configuration Submenu</i>	3-6
<i>System Information Submenu</i>	3-7
Advanced Menu	3-8
<i>CPU Configuration Submenu</i>	3-8
<i>Chipset Submenu</i>	3-9
<i>Onboard Devices Configuration Submenu</i>	3-9
<i>PCIPnP Submenu</i>	3-10
<i>USB Configuration Submenu</i>	3-10
<i>Power Up Control Submenu</i>	3-11
Boot Menu	3-12
<i>Boot Device Priority Submenu</i>	3-12
<i>Boot Settings Configuration Submenu</i>	3-12
<i>Security Submenu</i>	3-12
Exit Menu	3-14
Configuring MotherBoard Jumpers	3-15
Clear CMOS Jumper (CLRTC)	3-15
USB Power Jumpers (USBPW78/ USBPW56/ USBPW34/ USBPW12)	3-15
Keyboard Power Jumper (KBPW)	3-16
<b>Upgrading Your System</b>	<b>4-1</b>
General Information	4-2
Static Precautions	4-2
Equipment Log	4-3
Tools Recommended for Upgrading Your System	4-3
Preparing Your System for Upgrade	4-3
Shifting from Tower to Desktop	4-4
Shifting from Desktop to Tower	4-5
Removing or Installing the Right Side Door	4-6
Removing the Right Side Door:	4-6
Replacing the Right Side Door:	4-6
Removing and Replacing the Front Panel	4-8
Removing the Front Panel:	4-8
Replacing the Front Panel:	4-8
Removing and Replacing the 3.5/5.25-inch Bracket	4-9

Removing the 3.5/5.25-inch Bracket:	4-9
Replacing the 3.5/5.25-inch Bracket:	4-11
Installing or Removing a 5.25-inch Device	4-12
Adding a 5.25-inch Device	4-12
Removing a 5.25-inch device	4-13
Installing or Removing a 3.5-inch Floppy Disk Drive	4-14
Removing a 3.5-inch Floppy Disk Drive	4-14
Installing a 3.5-inch Floppy Disk Drive	4-15
Adding a Floppy Disk Drive	4-15
Installing or Removing Hard Disk Drives	4-18
Removing a Hard Disk Drive	4-18
Installing a Hard Disk Drive	4-20
Upgrading Microprocessor	4-23
Upgrading Random Access Memory (RAM)	4-26
Recommended Memory Configuration	4-26
Checking System Memory	4-26
<i>Windows® 2000</i>	4-26
<i>Windows® XP</i>	4-26
<i>Windows® 2003</i>	4-27
Removing a DDR module	4-27
Installing a DDR module	4-27
Installing and Removing an Adapter Card	4-29
Installing an Adapter Card	4-29
Removing an Adapter Card from Your System	4-29
Expansion Cards Resources	4-30
Replacing the Battery	4-31
Cabling the Device	4-32
The IDE Cable	4-32
The S-ATA Cable	4-32
System Power Cables	4-33
Cabling a CD/DVD-ROM or CD-RW Drive	4-33
Cabling a Hard Disk Drive	4-34
<i>E-IDE Hard Disk Drive</i>	4-34
<i>S-ATA Hard Disk Drive</i>	4-35
Cabling a Floppy Disk Drive	4-36
Preparing the Device	4-37
Preparing a CD-ROM or DVD-ROM Drive	4-37
Preparing an IDE Hard Disk Drive	4-38
Preparing a S-ATA Hard Disk Drive	4-38
Preparing a Tape Drive	4-38
IDE Device Configuration	4-39
<b>Problem Solving</b>	<b>5-1</b>
Problem Solving	5-2
Static Precautions	5-2
Resetting the Server	5-3
Troubleshooting Guide	5-4
Problems at initial System Start-up	5-5
Problems After the System Has Been Running Correctly	5-6

Problems Running New Application Software _____	5-7
Problems and Suggestions _____	5-8
If You Need Assistance _____	5-9
Error Messages: Beep Codes _____	5-10
How to Identify BIOS Revision Level _____	5-11
Updating BIOS _____	5-12
Recovering BIOS _____	5-13
Appendix A _____	A-1
Specifications _____	A-1
Appendix B _____	B-1
Interrupt Requests _____	B-1
Appendix C _____	C-1
Product Configuration Record Table _____	C-1
Glossary _____	E-1
INDEX _____	F-1

## **Proprietary Notice and Liability Disclaimer**

The information disclosed in this document, including all designs and related materials, is the valuable property of NEC Computers International and/or its licensors. NEC Computers International and/or its licensors, as appropriate, reserve all patent, copyright and other proprietary rights to this document, including all design, manufacturing, reproduction, use, and sales rights thereto, except to the extent said rights are expressly granted to others.

The NEC Computers International product(s) discussed in this document are warranted in accordance with the terms of the Warranty Statement accompanying each product. However, actual performance of each product is dependent upon factors such as system configuration, customer data, and operator control. Since implementation by customers of each product may vary, the suitability of specific product configurations and applications must be determined by the customer and is not warranted by NEC Computers International.

To allow for design and specification improvements, the information in this document is subject to change at any time, without notice. Reproduction of this document or portions thereof without prior written approval of NEC Computers International is prohibited.

### **Trademarks**

Adobe, and Adobe Acrobat are registered trademarks of Adobe Systems, Incorporated.

Microsoft, Microsoft Windows, Windows NT, Windows 95, Windows 98 and Windows Storage Server 2003 are all registered trademarks of Microsoft Corporation.

MS-DOS is a registered trademark of Microsoft Corporation.

Intel and Pentium are registered trademarks of Intel Corporation.

All other product, brand, or trade names used in this publication are the trademarks or registered trademarks of their respective trademark owners.

**January 2004**

Copyright 2004  
NEC Computers International B.V.  
Nieuweweg 279  
6603 BN Wijchen  
The Netherlands  
All Rights Reserved





## ***Using This Guide***

Welcome to the EXPRESS 5800 TM700 User Guide. This user's guide provides a quick reference to information about your server system. Its goal is to familiarize you with your system and the tasks necessary for system configuring and upgrading.

This guide contains the following information:

- Chapter 1, contains information about the front, back and internal features of your system and about the motherboard. It also lists the standard and optional features of your system and provides details about the EXPRESSBUILDER CD-ROM.
- Chapter 2, helps you installing the server in an appropriate place, make connections and start using your system.
- Chapter 3, shows you how to configure your system and helps you set up the various options.
- Chapter 4, provides all the information you need to remove components from your system and install new ones. You will find in this chapter how to upgrade memory, processor... etc.
- Chapter 5, gives you information about how to solve the various issues you may encounter with your system.
- “Glossary” lists the main vocabulary used in this guide.

## Text Conventions

This guide uses the following text conventions.

Warnings, cautions, and notes have the following meanings:

---

### **WARNING**

Warnings alert you to situations that could result in serious personal injury or loss of life.

---

---

### **CAUTION**

Cautions indicate situations that can damage the system hardware or software.

---

---

**Note:** *Notes give important information about the material being described.*

---

- Names of keyboard keys are printed as they appear on the keyboard. For example, **Ctrl**, **Alt**, or **Enter**.
- Text or keystrokes that you enter appear as boldface type. For example, type **abc123** and press **ENTER**.
- File names are printed in uppercase letters. For example, **AUTOEXEC.BAT**.

## ***Related Documents***

In addition to this guide, the following system documentation may be included with your system either as electronic files (on the EXPRESSBUILDER CD-ROM) or as paper copy shipped with your server.

- *System Release Notes*

Release Notes provide you with the latest information about your system. This information was not available to be included in your user's guide at the time it was developed and released.

## Safety Notices



- **Caution:** To reduce the risk of electric shock which could cause personal injury, follow all safety notices. The symbols shown are used in your documentation and on your equipment to indicate safety hazards.
- **Warning:** Lithium batteries can be dangerous. Improper handling of lithium batteries may result in an explosion. Dispose of lithium batteries as required by local ordinance or as normal waste if no local ordinance exists.
- **Warning:** The detachable power supply cord is intended to serve as the disconnect device.
- **Warning:** This equipment has a 3-wire, grounded power cord. To prevent electrical hazards, do not remove or defeat the ground prong on the power cord. Replace the power cord if it gets damaged. Contact your dealer for an exact replacement.
- **Warning:** The DC push-button on/off switch on the front panel does not turn off the system AC power. Also, +5vdc is present on the system board whenever the AC power cord is connected between the system and an AC outlet. Before doing the procedures in this manual, make sure that your system is powered off and unplug the AC power cord from the back of the chassis. Failure to disconnect power before opening your system can result in personal injury and equipment damage.

In the U.S.A. and Canada, the power cord must be a UL-listed detachable power cord (in Canada, CSA-certified), type ST or SJT, 16 AWG, 3-conductor, provided with a molded-on NEMA type 5-15 P plug cap at one end and a molded-on cord connector body at the other end. The cord length must not exceed 9 feet (2.7 meters).

Outside the U.S.A. and Canada, the plug must be rated for 250 VAC, 10 amp minimum, and must display an international agency approval marking. The cord must be suitable for use in the end-user country. Consult your dealer or the local electrical authorities if you are unsure of the type of power cord to use in your country. The voltage change occurs via a switch in the power supply.

- **Warning:** Under no circumstances should the user attempt to disassemble the power supply. The power supply has no user-replaceable parts. Inside the power supply are hazardous voltages that can cause serious personal injury. A defective power supply must be returned to your dealer.

## **Safety Notices for Users Outside of the U.S.A. and Canada**

- **PELV (Protected Extra-Low Voltage) Integrity:** To ensure the extra-low voltage integrity of the equipment, connect only equipment with mains-protected electrically-compatible circuits to the external ports.
- **Remote Earths:** To prevent electrical shock, connect all local (individual office) computers and computer support equipment to the same electrical circuit of the building wiring. If you are unsure, check the building wiring to avoid remote earth conditions.
- **Earth Bonding:** For safe operation, only connect the equipment to a building supply that is in accordance with current wiring regulations in your country. In the U.K., those regulations are the IEE.

## Care and Handling

Use the following guidelines to properly handle and care for your system.

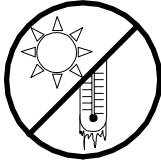

Protect the system from extremely low or high temperatures. Let the system warm (or cool) to room temperature before using it.



Keep the system away from magnetic forces.



Keep the system dry. Do not wash the system with a wet cloth or pour fluid into it.

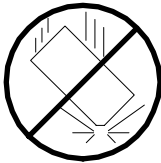

Protect the system from being bumped or dropped.



Check the system for condensation. If condensation exists, allow it to evaporate before powering on the system.



Keep the system away from dust, sand, and dirt.

# 1

## System Overview

- Overview
- System Features
- System Chassis Features
- Standard Features
- Optional Features
- EXPRESSBUILDER CD-ROM

## Overview

The Express 5800 TM700 server is based on the Intel<sup>®</sup> 875P MCH and Intel<sup>®</sup> ICH5-R chipsets and designed for the Intel<sup>®</sup> Pentium<sup>®</sup> 4 processor.

It offers essential features for entry-level server applications, such as:

- Web hosting
- Domain name server
- File and print services
- E-mail
- Firewall
- Proxy
- Virtual private network

This server is also conveniently housed in a convertible chassis that you can use as a tower or as a desktop.

To get comfortable with your computer, take a tour around your system by reading the sections hereafter.



## System Features

Your system features the following major components:

- Intel® Pentium® or Intel® Celeron® processor.
- Five 32-bit PCI 2.2 expansion slots for bus master PCI cards like LAN cards with 133MB/s maximum throughput.
- Embedded PC-compatible support (serial, diskette, USB, LAN, audio).
- RAID/S-ATA controller providing high performance RAID0/RAID1 functionality.
- Onboard Ethernet LAN.
- 3 ½-inch diskette drive.
- Two slot, 3.5-inch media device bay.
- Two slot, 5,25-inch media device bay.
- Six integrated Universal Serial Bus (USB) ports, two located on the front panel and four located on the rear panel.
- Convertible chassis that can be installed as a tower or as a desktop.

# System Chassis Features

## Front View

The following figure shows the location of the front system features

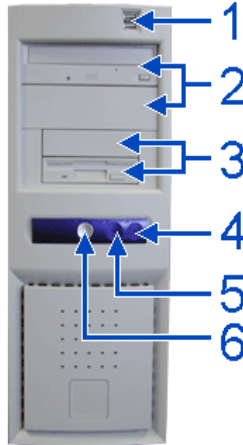

**Figure 1 - 1 : Front View**

**1 USB ports**

Two Universal Serial Bus (USB) ports allow you to connect USB-equipped peripheral devices such as printers.

**2 5.25-inch bays**

Two 5.25-inch bays, one of which may include a tape backup unit, CD-ROM drive, DVD-ROM drive or COMBO DVD-ROM CD-RW drive.

**3 3.5-inch bays**

Two 3.5-inch bays, one of which may include a 3.5-inch floppy disk drive.

**4 IDE device lamp**

Lights up when a hard disk drive or an optical drive is active, reading or retrieving data.

**5 Status lamp**

Indicates whether the computer is on or off. A steady green lamp indicates the computer is on. The lamp lights amber when the computer is in stand-by mode.

**6 Power button**

Press this switch to turn on/off the power. Refer to the 'Powering On Your System', 'Powering Off the Server System' and 'Forcing a Power Shutdown' sections hereafter for details.

---

 **Caution**

When the system is in stand-by mode, make sure that the total USB and PS/2 peripheral consumption does not exceed 2A.

Otherwise, the power supply can be severely damaged.

---

## Rear View

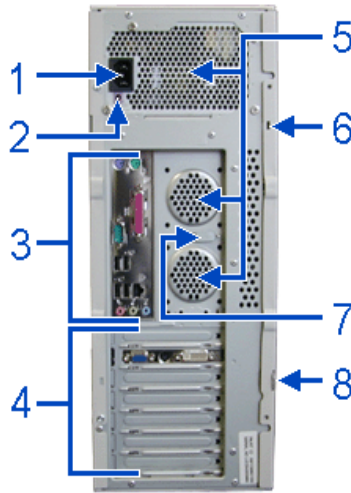

**Figure 1 - 2 : Rear View**

- 1 AC power connector**  
Connect the power cord to this socket.
- 2 DC-12V power connector**  
12V power connector that you can use to connect speakers for example.
- 3 Connectors**  
Refer to the 'System Connectors' section hereafter for details.
- 4 Expansion boards slots**  
Refer to the 'Expansion Boards Slots' section hereafter for details
- 5 Venting holes**  
Keep the area near the venting holes clear for proper ventilation.
- 6 Kensington lock slot**  
Security feature that allows you to secure your computer to your desk with a cable.
- 7 Keyboard and mouse anti-theft device**  
Security feature that you can use to ensure that your mouse and keyboard cannot be easily removed from your system.
- 8 Anti-theft ring**  
Security feature that allows you to secure your chassis' cover with a padlock.

System Connectors

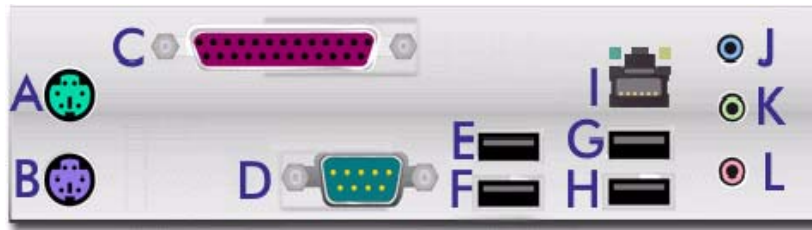

Figure 1 - 3 : System Connectors

Table 1 - 1: System Connectors

Key to the diagram	Name of the Port	Description
A	PS/2 mouse port	6 Pin Mini-DIN
B	PS/2 keyboard port	6 Pin Mini-DIN
C	Printer/ EPP/ ECP & BPP port	25 pin SUB D
D	Serial port COM1	9 pin SUB D
E	USB port 1	
F	USB port 2	
G	USB port 3	
H	USB port 4	
I	RJ45 LAN connector and LEDs. Refer to the RJ45 Leds section below for details.	RJ45
J	Stereo line in	Jack socket
K	Stereo line out	Jack socket
L	Mono microphone in	Jack socket

RJ45 Leds

Table 1 - 2: RJ45 Leds Activity

Speed	Led A Activity	Led B Activity
10	Always ON (orange)	OFF
100	Lights OFF when active	ON (orange)
1000		ON (green)

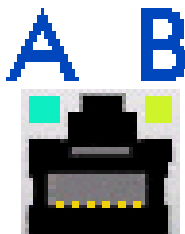
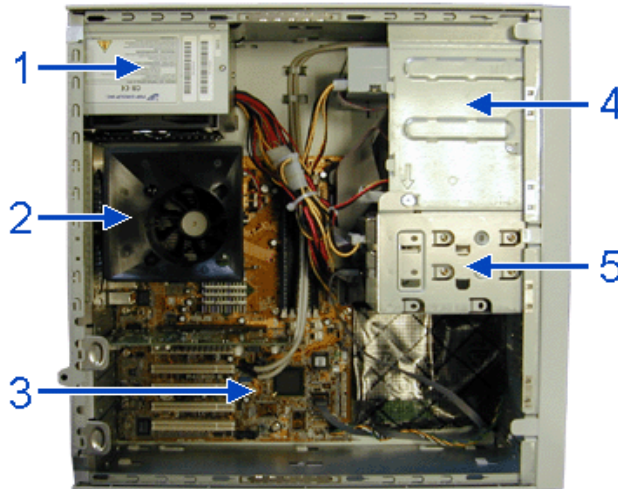

Figure 1 - 4 : RJ45 Leds

Expansion Board Slots

Five PCI expansion slots are available enabling you to install additional Video Boards and LAN board. Refer to the ‘Optional Features’ section for details about the components that may be installed in the expansion slots.

## Internal View



**Figure 1 - 5 : Internal View**

- 1 Power supply slot
- 2 Processor air duct
- 3 Motherboard
- 4 5.25-inch and 3.5-inch devices slots
- 5 Hard disk drives slots

## Motherboard

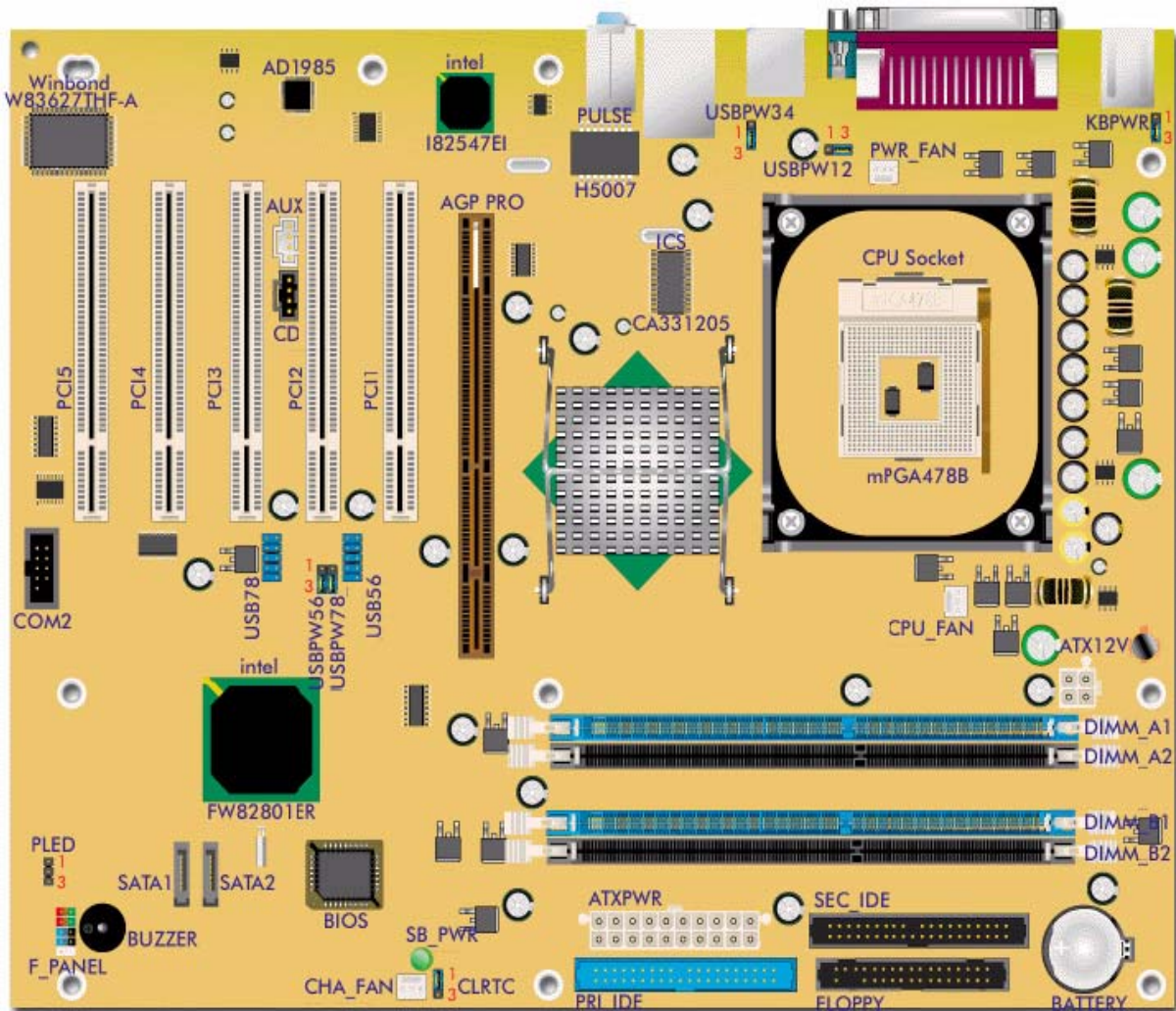
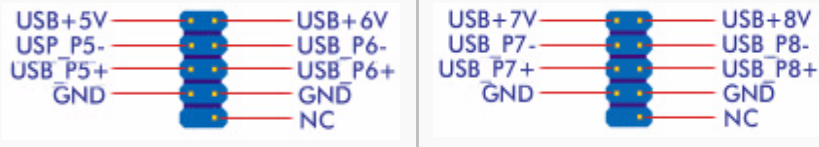
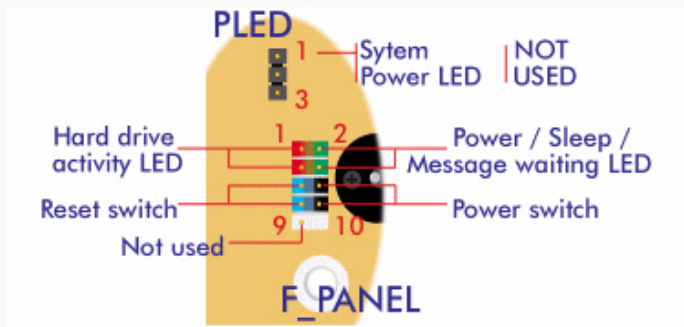

Figure 1 - 6 : TM700 Motherboard

Table 1 - 3: TM700 Motherboard Internal Connectors

Denomination on drawing	Name	Type
ATXPWR	Power connector	20 pin keyed connector
ATX12V	Power connector	4 pin keyed connector
CPU_FAN	CPU fan connector	3 pin header (white)
CHA_FAN	System fan connector	3 pin header (white)
PWR_FAN	Power fan connector	3 pin header (white)
FLOPPY	Floppy drive connector	34 (2x17) pin shrouded header
PRI_IDE	Primary IDE connector	40 (2x20) pin header (blue)
SEC_IDE	Secondary IDE connector	40 (2x20) pin header (black)
PCI 1, 2, 3, 4 & 5	PCI connectors	Standard PCI expansion slots
AGP PRO	Accelerated Graphics Port Pro	Pro AGP connector
SOCKET	CPU connector	mPGA 478B socket
DIMM_A1, A2, B1 & B2	DDR sockets	184 pin standard sockets
CD	CD-ROM audio line in	4 pin header (black)

Table 1 - 3: TM700 Motherboard Internal Connectors (Continued)

Denomination on drawing	Name	Type
CLRTC	Clear CMOS/ normal jumper	3 pin jumper
KBPWR	Keyboard power jumper	3 pin jumper
AUX	Auxiliary in	4 pin header (white)
USBPW12/34/56/78	USB power jumper	3 pin jumper
USB56/78	USB56 connector	USB78 connector (not used)
		
BATTERY	CMOS battery socket	
COM2	Serial port header	10 pin dual row header (-1 key)
F_PANEL	Front panel connector	5 pin dual row header (-1 key)
		

## Standard Features

- Convertible chassis
- 280W power supply
- 3.5-inch 1.44MB floppy disk drive
- On-board LAN ethernet
- Intel Pentium 4 processor support
- Dual channel memory architecture support
- P-ATA and S-ATA hard disk drives support
- CD-ROM, DVD-ROM, COMBO DVD-ROM/ CD-RW support
- AGP and PCI video boards support
- 5.25-inch tape backup unit support

### Processor

The system board may accommodate one Intel Pentium 4 processor with up to 1MB cache.

### Memory

The system board contains four 168-pin DIMM slots each supporting DDR400 ECC unbuffered memory. You may install a minimum of 256 MB and as much as 4 GB.

---

 **Note:** When all four sockets are populated with 1GB DIMMs (total 4GB), the system may detect only 3+GB (a little less than 4GB) due to ICH5R resource allocation.

---

Your system supports dual-channed memory architecture. Refer to “Recommended Memory Configuration” on page 26 for details.

### PCI Slots

The motherboard has five PCI expansion slots that you can use to add a video board or a LAN board for example.

### Network Controller

---

 **Note:** To ensure EMC product regulation compliance, the system must be used with a shielded LAN cable.

---



The motherboard uses one Intel® 82547EI Gigabit Ethernet Controller and supports 10Base-T/100Base-TX/1000Base-T network systems.

The 82547EI controller supports the following features:

- Full-duplex Gigabit throughput and higher platform performance with Communication Streaming Architecture (CSA)
- System health monitoring and authenticated remote power control with ASF 2.0

## ACPI

The motherboard supports the Advanced Configuration and Power Interface (ACPI) as defined by the ACPI 2.0 specifications. An ACPI aware operating system can put the system into a state where the hard drives spin down, the system fans stop, and all processing is halted. However, the power supply will still be on and the processors will still be dissipating some power, so the power supply fans will still run.

The system board supports sleep states s0, s1, s4, and s5:

- s0: Normal running state.
- s1: Processor sleep state. No context will be lost in this state and the processor caches will maintain coherency.
- s4: Hibernate or Save to Disk: The memory and machine state are saved to disk. Pressing the power button or other wakeup event will restore the system state from the disk and resume normal operation. This assumes that no hardware changes have been made to the system while it was off.
- s5: Soft off: Only the RTC section of the CSB are running in this state. No context is saved by the OS or hardware.

---

 **Note:** The system is off only when the AC power cord is disconnected.

---

## Keyboard and Mouse

The keyboard/mouse controller is PS/2-compatible.

## Peripheral Bays

Your Storage server features two 5.25-inch bays that you can use with either a hard disk drive, an optical device such as a CD-ROM, DVD-ROM or COMBO DVD-ROM CD-RW, or a tape backup unit. See “Optional Features” on page 1-12.

## Optional Features

You will find hereafter information about the optional components that may be installed in your system.

### CD-ROM Drive

- Rotation Speed: 48x max
- Buffer: 128 kBytes
- Emergency Eject: Pin-hole on front panel to release tray.
- Form Factor: 5.25" half height.
- Compatibility: Mixed Mode (Audio and Data combined), CD-DA, Photo-CD, CD-XA Ready, CD-I Ready, CD-Plus, CD-Extra, CD-RW
- Transfer rate (max): 48x (7200Kbytes/s)
- ATA Interface (burst): 16.67 Mbytes/s (PIO Mode 4/ MULTI-DMA Mode 2)
- Environmental Specifications:

**Table 1 - 4: CD-ROM Drive Environmental Specifications**

	Operating	Non-operation
Temperature	5°C to 50°C	-40°C to +60°C
Humidity (% relative humidity)	5% to 90%	5% to 90%
Vibration	0.35 G (10 - 500 Hz)	2.0 G (10 - 500 Hz)

- Random Access time: 75ms (typical), 100ms (max)

### DVD-ROM Drive

- High Speed DVD: 16X max & High Speed CD: 40X max.
- Buffer: 256 kBytes
- Emergency Eject: Pin-hole on front panel to release tray.
- Software Ejection/ Loading and Volume Control
- Form Factor: 5.25" half height.
- Compatibility: DVD-ROM (single-layered and dual-layered), DVD-R 3.95GB & 4.7GB, DVD+R, DVD-RW (rev 1.0 & 1.1), DVD+RW, DVD-RAM 2.6GB & 4.7 GB, CD-ROM Mode1 and Mode2 data disc, CD-R,CD-RW,CD-ROM XA, CD-I, Photo-CD Multi-session, CD-Extra, CD TEXT, CD Audio disc, Mixed mode CD-ROM disc.
- Transfer rate (max):
  - CD-ROM: 6000Kbytes/s
  - DVD-ROM: 22.1 Mbytes/s
- CD-ROM ATA Interface (burst):

- 16.6 Mbytes/s (PIO Mode 4/ MULTI word DMA Mode 2)
- 8.3 Mbytes/s (Single word DMA Mode 2)
- 66.7 Mbytes/s (Ultra DMA Mode 4)
- **Rotation Speed:**
  - CD-ROM: 8780 rpm
  - DVD-ROM: 9420 rpm
- **Full Stroke:**
  - CD-ROM: 160 ms
  - DVD-ROM: 180 ms
- **Environmental Specifications:**

**Table 1 - 5: DVD-ROM Drive Environmental Specifications**

	<b>Operating</b>	<b>Non-operation</b>
Temperature	5°C to 45°C	-40°C to +60°C
Humidity (% relative humidity)	15% to 85%	10% to 90%
Vibration	0.25 G (zero to peak)	50 G (zero to peak)

### ***DVD-ROM CD-RW Combination Drive***

- **Emergency Eject:** Pin-hole on front panel to release tray.
- **Volume Control:** headphones volume control knob.
- **Headphone jack:** 3.5 mm. stereo headphone output on the front panel.
- **Form Factor:** 5.25" half height
- **Enhanced IDE Interface**
- **Multifunction device:**
  - 48x CD-ROM reader (Read only)
  - 48x CD-Recorder (Write once, read many)
  - 24x CD-ReWritable device (Rewritable, read many)
  - 16x DVD reader
- **Data buffer:** 2MB
- **Compatibility:**
  - Reads data in each CD-ROM, CD-ROM XA, CD-I, Video CD, CD-Extra, CD-Text , Photo CD (Single and Multi session ), DVD-ROM, DVD-R(Ver.1.0, Ver. 2.0 for Authoring), CD-DA
  - Reads and writes CD-R, CD-RW, DVD-R (Ver. 2.0), DVD-RW, DVD+R and DVD+RW
- **Access time (max):**

- CD-ROM: 120ms
- DVD-ROM: 140ms

■ Performance:

**Table 1 - 6: Combo Drive Performance**

	CD-ROM	CD-R	DVD	CD-RW	DVD+R/+RW
Reading Speed	48x	48x	16x	16x ~40x	1,7x ~8x
Writing Speed		21x ~48x		4x, 8x, 12x, 16x, 24x	

■ Environmental Specifications:

**Table 1 - 7: Combo Drive Environmental Specifications**

	Operating	Non-operation
Temperature	5°C to 45°C	-30°C to +60°C
Humidity (% relative humidity)	15% to 80%	15% to 95%
Vibration	0.30 G (5-500 Hz)	2.0 G (5-500 Hz)

**Intel Pro 1000 MT LAN Board**

- IEEE Standard
- 10BASE-T, 100BASE-TX, 1000BASE-T
- Intel® SingleDriver™ Technology
- Plug and Play Specification Support
- Easy Installation, Intel® PROSet Utility and Intel® PRO Intelligent Install
- Auto-negotiation, Full-duplex capable
- Full height bracket
- Wired for Management (WfM) Baseline 2.0 Enabled for servers
- DMI 2.0 support, WMI & SNMP-manageable
- Offline diagnostics
- Intel® Boot Agent
- ACPI Power Management
- PXE 2.0

**E-IDE Hard Disk Drive**

- Capacity: 80gb minimum
- 7200RPM

## S-ATA Hard Disk Drive

- Capacity: 80gb minimum
- 7200RPM
- RAID0 and RAID1 support. Refer to RAID Application documentation for details.

---

### **Caution**

You may use either E-IDE or S-ATA hard disk drives.  
However, mixing E-IDE and S-ATA hard disk drives is not supported.

---

## Video Board

---

 **Note:** Your system may feature a video board of a different type than those presented hereafter.

---

### *nVidia Quadro FX 500*

- 128MB DDR2
- 128-bit precision graphics pipeline
- 128MB frame-buffer memory
- Full IEEE 128-bit floating point precision
- 32-bit floating point precision per color component
- 12-bit sub-pixel precision
- Hardware 8x/16x Full-Scene Anti-aliasing (FSAA)
- AGP 8x interface
- OpenGL and DX9.0 programmability
- nView multi-display technology
- Unified Driver Architecture

### *nVidia Quadro4 8x 380 XGL*

- 128-bit DDR memory interface
- 64MB DDR SDRAM
- NVIDIA Lightspeed Memory Architecture II

- Hardware overlay
- Hardware antialiased lines
- Two-sided lighting
- Full-scene antialiasing
- 2nd-generation occlusion culling
- Dual 350MHz RAMDACs
- Maximum Resolution 2048x1536 @ 75Hz
- OpenGL quad-buffered stereo
- NVIDIA Unified Driver Architecture (UDA)
- AGP 8X/4X/2X and AGP Texturing Support
- Microsoft DirectX 8.1, OpenGL 1.4 Optimizations and Support (with vertex and pixel programmability)

#### *PCI Video Board*

- Memory configuration: 8MB
- Bus specifications: PCI bus/ PCI 2.2
- Output: CRT
- Resolution support:
  - 2D/3D resolution : 1600x1200 max
  - Color depth: 16,7m colors max

#### ***Sony AIT1 Tape Backup Unit***

- Capacity:
  - 25 GBytes with 170 meter tape AIT-1 cassette (65 Gbytes with 2.6:1 data compression ratio)
  - 35 Gbytes with 230 meter tape AIT-1 cassette (91 Gbytes with 2.6:1 data compression ratio)
- Sustained transfer rate: 4 Mbytes/sec (10.4 Mbytes/sec with 2.6:1 data compression ratio)
- Supported format: AIT-1
- Not compatible with the DDS and EXABYTES format tapes
- Burst transfer rate: 66 Mbytes/sec Ultra DMA (mode 4)
- Large 10 MB buffer memory
- ATA/ATAPI-5 interface
- Supports Fixed record length only

- Read After Write (RAW) On and Off capability
- Read Retry On and Off capability
- Frame rewrite function
- Three levels of Error Correction Code (ECC)
- High speed search (120 times nominal Read/Write speed)
- Random read, Append write
- Repeat write function
- MIC support (Automatic reliability and performance enhancement - read and write capability for MIC user data area)

## **EXPRESSBUILDER CD-ROM**

### **With the EXPRESSBUILDER CD you can:**

- Create diskettes (third party software drivers).
- Do Windows 2000, Windows XP or Windows Server 2003 Hard Disk Preload Recovery.

### **What is on the CD that you may need to use**

Third Party Software Drivers, Server Documentation, Others:

- \DRIVERS All drivers of the TM700 machine.
- \DOCS All the Express5800 TM700 documentation which is shipped with each server.
- \Apps\Adobe\Acrobat5.0 Adobe Acrobat Reader 5.0
- \Apps\DirectX9.0a DirectX 9.0b
- Apps\ESMPRO NEC ESMPRO Agent

Windows 2000/XP or Windows Server 2003 Hard Disk Preload Recovery:

Should the system crash, and the operating system or pre-installed applications are lost or damaged, the initial configuration can be reinstalled by simply reloading it from the recovery CD. This added security protects the customer's investment, and helps to lessen total cost of ownership by reducing downtime.

Do as follows :

1. Place the EXPRESSBUILDER CD in the CD drive and boot the server.
2. Select the Windows operating system you wish to install.
3. Select the partition type (FAT32 or NTFS) and the size.
4. Insert the Windows CD when requested.
5. The installation starts automatically.

### **Software End-User License Agreement**

Carefully read the following terms and conditions before installing the software in this package. Opening this package indicates your understanding and acceptance of all of the following terms and conditions. If you do not agree with them, you may promptly return the package and any associated documentation (collectively herein referred to as SOFTWARE) to your local NEC Computers International representative.

**IMPORTANT:** This software is a proprietary product and is protected by copyright laws. It is licensed (not sold) for use on a single machine (as defined in the installation instructions), and is licensed only on the condition that you agree to the terms of this



END-USER LICENSE AGREEMENT. You assume responsibility for the selection of the SOFTWARE to achieve your intended results, and for the installation, use and results obtained from the software.

## **LICENSE**

- 1. Use.** You may use the SOFTWARE on the machines intended for its use.
- 2. Copy, Modify and Merge.** You may copy the SOFTWARE into any machine-readable or printed form for backup or modification purposes in support of your use of the SOFTWARE.
- 3. Transfer.** You may transfer this SOFTWARE together with this license to another party, but only if the other party agrees to accept the terms and conditions of this Agreement. If you transfer the SOFTWARE and license, you must at the same time either transfer all copies (either in printed or machine readable form) to the same party or destroy any copies not transferred, including all modifications and portions of the SOFTWARE contained or merged into other programs. If the SOFTWARE is an update, any transfer must include the update and all prior versions. Any such transfer of the SOFTWARE and license to another party terminates your license. Any attempt to transfer the SOFTWARE and license, other than as set forth herein, shall be null and void.
- 4. Other Restrictions.** You may not reverse engineer, decompile or disassemble this SOFTWARE. EXCEPT AS EXPRESSLY PROVIDED IN THIS AGREEMENT, ANY USE, COPYING, MODIFICATION, OR MERGING OF THE SOFTWARE, INCLUDING DOCUMENTATION, OR TRANSFER OF THE SOFTWARE OR LICENSE, IS PROHIBITED.

## **TERM**

The license is effective until terminated. You may terminate it at any other time by destroying the SOFTWARE together with all copies, modifications, and merged portions in any form. It will also terminate upon conditions set forth elsewhere in this Agreement, or if you fail to comply with any term or condition of the Agreement. You agree upon such termination to destroy the SOFTWARE together with all copies, modifications and merged portions in any form.

## **LIMITED WARRANTY**

THE SOFTWARE IS PROVIDED "AS IS" WITHOUT WARRANTY OF ANY KIND, EITHER EXPRESSED OR IMPLIED, INCLUDING, BUT NOT LIMITED TO THE IMPLIED WARRANTIES OR MERCHANTABILITY AND FITNESS FOR A PARTICULAR PURPOSE. THE ENTIRE RISK AS TO THE QUALITY AND PERFORMANCE OF THE SOFTWARE IS WITH YOU AND NEITHER NEC COMPUTERS INTERNATIONAL, ITS SUPPLIERS, OR AUTHORIZED RESELLERS ASSUME THE ENTIRE COST OF ALL NECESSARY SERVICING, REPAIR OR CORRECTION.

Some states do not allow the exclusion of implied warranties, so the above exclusion may not apply to you. This warranty gives you specific legal rights and you may also have other rights which vary from state to state.

Neither NEC Computers International nor its suppliers warrant that the functions contained in the SOFTWARE will meet your requirements or that the operation of the SOFTWARE will be uninterrupted or error free. NEC Computers International warrants the media on which the SOFTWARE is furnished to be free from defects in materials and workmanship under normal use for a period of (90) days from the date of delivery to you, as evidenced by a copy of your purchase invoice.

### **LIMITATIONS OF REMEDIES**

NEC Computers International and its suppliers entire liability and your exclusive remedy shall be the replacement of any media not meeting NEC Computers International's "Limited Warranty" which is returned to NEC Computers International at the address below with a copy of your invoice.

IN NO EVENT WILL NEC COMPUTERS INTERNATIONAL OR ITS SUPPLIERS BE LIABLE TO YOU FOR ANY DAMAGES, INCLUDING ANY LOST PROFITS, LOSS OF BUSINESS INFORMATION, BUSINESS INTERRUPTION, LOST SAVINGS OR OTHER INCIDENTAL OR CONSEQUENTIAL DAMAGES ARISING OUT OF THE USE OR INABILITY TO USE SUCH SOFTWARE, EVEN IF NEC COMPUTERS INTERNATIONAL, ITS SUPPLIERS OR ANY AUTHORIZED RESELLER HAS BEEN ADVISED OF THE POSSIBILITY OF SUCH DAMAGES, OR FOR ANY CLAIM BY ANY OTHER PARTY.

# 2

## Setting Up the System

- Overview
- Selecting a Site
- Unpacking the System
- Making Connections
- Connecting the Power Cord
- Using the System

## **Overview**

This chapter describes how to select a site, unpack the system, make cable connections, and power on the system units. Information on front and rear panel features, switches and LEDs are also included in this chapter.

## Selecting a Site

The system operates reliably in a typical office environment. Choose a site that is:

- Near grounded, three-pronged power outlets.

---

 **Note:** For the United States and Canada, this means a NEMA 6-15R outlet for 200-240 VAC. The system cannot be used on a NEMA 5-15R outlet for 100-120 VAC. For other international sites, this means three-pronged power outlets applicable for the electrical code of the region.

---

---

### WARNING

Be sure the power service connection is through a properly grounded outlet.

---

---

### CAUTION

When two power supplies are installed in the system the power plug from each of the power supplies must be plugged into the same common ground power outlets.

---

- Clean, dust-free, and well ventilated. Every side ventilating openings kept free of obstructions. Away from sources of heat, vibration or physical shock.
- Isolated from strong electromagnetic fields and electrical noise produced by electrical devices (such as air conditioners, large fans, large electric motors, radio and TV transmitters, and high-frequency security devices)
- Spacious enough to provide at least ten inches (25 centimeters) in front of the system, five inches (13 centimeters) behind the system and three inches (eight centimeters) on each side of the system for proper cooling, airflow, and cable clearance.
- Easily accessible for system maintenance and installation of system upgrades.

## ***Unpacking the System***

When you receive your system, inspect the shipping containers prior to unpacking. If the shipping boxes are damaged, note the damage, and if possible, photograph it for reference. After removing the contents of the containers, keep the cartons and the packing materials. If the contents appear damaged when you unpack the boxes, file a damage claim with the carrier immediately.

## **Making Connections**

Connect your keyboard, monitor, and mouse. Also connect any external peripheral devices such as a printer or scanner by following the instructions included with these devices.



### **Caution**

Damage to the system may result if the keyboard/ mouse cable is inserted or removed when power is applied to the system.

Inserting a telephone line connector into a LAN RJ-45 port may result in personal injury and equipment damage.

---

## Connecting the Power Cord

Plug the female end of the AC power cord into the input receptacle on the rear of the power supply cage. Plug the male end of the power cord into NEMA 5-15R outlet for 100-120 VAC or NEMA 6-15R outlet for 200-240 VAC.

If the power cord(s) supplied with the system is not compatible with the AC wall outlet in your region, obtain a suitable power cord that meets the following criteria.

- The power cord must be rated for the available AC voltage and have a current rating that is at least 125% of the current rating of the system.
- The power cord connector that plugs into the wall outlet must be terminated in a grounding-type male plug designed for use in your region. It must have certification marks showing certification by an agency acceptable in your region.
- The power cord connector that plugs into the system must be an IEC- type CEE-22 female connector.
- The power cord must be less than 1.8 meters (6.0 feet) long.

---

### **Warning**

Your system shipped with a power cord for each power supply.  
Do not attempt to modify or use the supplied AC power cord if it is not the exact type required.

---



## Using the System

The following subsections describe how to use this server system properly and safely, including an explanation of the server system power on/off sequences, what the POST program checks in the server, and how to perform a forced power shutdown.

When using the server system the following precautions should be observed.

- Make sure you power off the server before connecting or disconnecting cables between the server and peripheral devices. Connecting or disconnecting the cables while the server is powered on may cause malfunction or failures within the server.
- Verify that the access lamp on the diskette drive is unlit before turning off the server or ejecting the floppy disk. Turning off the server or ejecting the floppy disk while the access lamp is lit may damage data being stored on the floppy disk.
- After turning off the server, wait at least 10 seconds before turning it on again. Cycling the power immediately may cause malfunction or failures of the server.
- Before relocating the server, turn off the power and unplug the power cord from the outlet. Moving the server when it is powered may cause malfunction or failures of the server.
- Some software includes a command to eject the CD-ROM tray or a media in a device mounted in the 5.25-inch device bay. Make sure that the front door of the tower-based cabinet is open before running the command. Running this command with the front door closed may cause the CD-ROM tray or the media to hit against the front door, resulting in a possible failure of the CD-ROM.
- Clean the server regularly. Regular cleaning prevents failures of the server and its components.
- Lightning may cause a momentary voltage drop. To prevent this problem, an uninterruptible power supply unit is recommended.
- Only use options qualified for the server. A non-qualified option may be mounted or connected to the server, but it may fail to operate normally or even cause failures. These types of failures are not covered under warranty.

## Powering On Your System

---

 **CAUTION:**

- If the power cord is connected to a power control device such as a UPS (Uninterruptive Power Supply), make sure that the power control device is powered.
  - Do not turn off the server until characters following the Boot-BIOS logo appears on the screen.
- 

Power on your system as follows.

1. Make sure all external devices, such as a video display, keyboard, and mouse (optional) have been connected, and the power cords are connected.
2. Power on the video display and any other external devices.

---

 **Note:** If the server power cord(s) is connected to a power control unit such as an UPS (Uninterruptible Power Supply) make sure that the power control unit is powered on.

---

3. Press the POWER switch on the front of the computer chassis to power on the system. The POWER lamp lights green. If it is not lit, ensure the ac power cord is connected to a functional ac power source.

After a few seconds your system begins the internal Power-On Self Tests (POST). POST automatically checks the system board, CPU(s), memory, keyboard, mouse, and most installed peripheral devices. POST also displays the start messages of the BIOS setup utility during execution.

The POST check results should be checked in the following cases:

- When the server is being used for the first time.
- When the server appears to fail.
- When the server beeps many times between power-on and OS start-up.
- When an error message appears on the screen.

---

 **Note:** For error messages that appear on the display unit, refer to subsection POST Error Codes and Messages in Chapter 5 of this Guide.

---

---

 **CAUTION**

Always allow POST to complete before powering down your system.

---

If you have problems powering on your system, refer to *Problem Solving* in Chapter 5 of this User's Guide.

After you have successfully powered on your system, insert the EXPRESSBUILDER CD-ROM into the CD-ROM device, reboot the system and follow the screen prompts to run EXPRESSBUILDER.

### **Powering Off the Server System**

When server system power is on, pressing the power on/off switch on the front panel of the server turns the power off.

To turn the server system power off:

1. Shutdown the operating system (OS).
2. If necessary, press the POWER switch on the front of the computer chassis again to power off the system. The POWER lamp lights off.
3. Power off the peripheral devices.

---

**Note:** If the server power cord is connected to a power control unit such as an UPS (Uninterruptible Power Supply), refer to the UPS user's guide for proper power-off procedures.

---

### **Forcing a Power Shutdown**

A forced power shutdown can be used when the power on/off switch does not power off the server or the reset functions do not work.

To perform a forced power shutdown:

- Press in on the power on/off switch located on the front panel of the server for at least 4 seconds to force the server power off.

To power on after a forced shutdown, wait 10 seconds and then power on again.



# 3

## Configuring Your System

- Configuring Your System
- BIOS Setup Utility
- Configuring MotherBoard Jumpers

## **Configuring Your System**

Configuration and setup utilities are used to change your system configuration. You can configure your system, as well as option boards you may add to your system, using the BIOS Setup Utility. Several unique system parameters are configured using the BIOS Setup, which is stored in the system FLASH memory.

If your system has been factory configured, the BIOS Setup Utility does not need to be run unless you want to change the password or security features, add certain types of option boards or devices, or upgrade your system board.

This chapter also provides information on several system configuration parameters that are set by jumpers on the system board. However, these parameters do not usually require change.

# BIOS Setup Utility

The BIOS Setup Utility is used to change system configuration parameters. The utility is resident in the system FLASH memory and does not require a diskette or an operating system present to run.

## Using the BIOS Setup Utility

You access the BIOS Setup utility when you turn on or reboot your system. To run the BIOS Setup Utility, perform the following procedure:

1. Power-on or reboot the system. “Press <DEL> to enter SETUP” displays.
2. Press **DEL**. The BIOS Setup Utility starts and the Main Menu is displayed. The menu bar at the top of the Main Menu lists the following selections:

**Table 3 - 1: Main Menu**

Menu	Use
Main	Use this menu for basic system configuration.
Advanced	Use this menu for setting the Advanced Features available on your system.
Power	Use this menu for configuring power management features and power on options.
Boot	Use this menu to configure Boot Device priority and to set User and Supervisor Passwords.
Exit	Exits the current menu.

Use the arrow keys to select a menu or an item on a displayed menu. Press the value keys (listed in the table below) to cycle through the allowable values for the selected field. Use the Exit menu’s “Save Values” selection to save the current values on all the menus.

To display a submenu, position the cursor on a selection that has a submenu and press **ENTER**. An arrow precedes selections with submenus.

Refer to the following table for information on the keys that you use with BIOS Setup. These keys are also listed at the bottom of the Setup menu.

**Table 3 - 2: BIOS Setup Keys**

Key	Function in Setup Menu
F1 or Alt-H	Get Help about an item.
ESC	Exit the current menu and return to the previous menu.
Left or right arrow keys	Move between menus.
Up or down arrow keys	Move cursor up and down. The cursor moves only to the settings that you can change.
HOME or END	Move cursor to top or bottom of window.
PAGE UP or PAGE DOWN	Move cursor to next or previous page.
F5	Load default configuration values for this menu.
F10	Save configuration values and exit.
ENTER	Execute command or Select * submenu.

## **BIOS Setup Configuration Settings**

The BIOS Setup Configuration tables show the default settings for the BIOS Setup Utility and provide a place for you to record any changes you make to these settings. Recommended values are bold in the following tables.



## Main Menu

**Table 3 - 3: Main Menu**

Feature	Choices or Display Only	Description	Your Setting
System Time	HH:MM:SS	Set the System Time.	
System Date	MM/DD/YYYY	Set the System Date.	
Legacy Diskette A	Disabled <b>1.44/1.25 Mb 3½"</b>	Hidden if not detected.	
Primary IDE Master	Selects sub-menu		
Primary IDE Slave	Selects sub-menu		
Secondary IDE Master	Selects sub-menu		
Secondary IDE Slave	Selects sub-menu		
IDE Configuration	Selects sub-menu		
System Information	Selects sub-menu		

### Primary and Secondary Master and Slave IDE Submenus

**Table 3 - 4: Primary And Secondary Master And Slave IDE Submenus**

Feature	Choices or Display Only	Description	Your Setting
Type	<b>Auto</b> Not Installed	Select Auto if a device is attached to the IDE channel.	
LBA (Large Mode)	Disabled <b>Auto</b>	LBA stands for "logical block addressing". Instead of referring to locations by passing to the disk a cylinder, head and sector number (CHS addressing), the sectors are serialized so that each just has an integer number; 0, 1, 2, etc. up to the total number of sectors on the disk. Disabled will disable the LBA mode, Auto will enable it if the IDE device supports it. This field is informational only, for Type Auto.	
Block (Multi-Sector Transfer)	Disabled <b>Auto</b>	Enables or disables multiple sector transfers. This field is informational only, for Type Auto.	
PIO Mode	<b>Auto</b> 0 1 2 <b>3</b> 4	Select the method for moving data to/from the drive. This field is informational only, for Type Auto. This field is updated to display only the modes supported by the attached device.	

Table 3 - 4: Primary And Secondary Master And Slave IDE Submenus (Continued)

Feature	Choices or Display Only	Description	Your Setting
DMA Mode	Auto SWDMA0 SWDMA1 SWDMA2 MWDMA0 MWDMA1 MWDMA2 UDMA0 UDMA1 UDMA2 UDMA3 UDMA4 UDMA5 UDMA6	Selects the DMA mode used for moving data to/from the drive. This field is informative only for Type Auto.	
SMART Monitoring	Auto <b>Disabled</b> Enabled	Enables or disables the Self Monitoring, Analysis and Reporting Technology (S.M.A.R.T.)	
32Bit Data Transfer	<b>Disabled</b> Enabled	This option allows you to enable or disable 32 bit IDE transfers.	

IDE Configuration Submenu

Table 3 - 1: IDE Configuration Submenu

Feature	Choices or Display Only	Description	Your Setting
Onboard IDE Operate Mode	Compatible Mode <b>Enhanced Mode</b>	Set this feature to <i>Compatible Mode</i> when using a legacy operating system (i.e. Windows 98, Millennium, NT). Set it to <i>Enhanced Mode</i> when using native operating system (i.e. Windows 2000 or XP)	
Enhanced Mode Support On	P-ATA+S-ATA <b>S-ATA</b> P-ATA	Leave this feature set to default S-ATA to be able to use the EXPRESSBUILDER or CD	
Configure S-ATA as RAID	No <b>Yes</b>	Allows you to configure S-ATA channels to function either as standard IDE or as RAID. See RAID Application documentation for details.	
Serial-ATA BOOTROM	Disabled <b>Enabled</b>	Only if Configure S-ATA as RAID is set to Yes. Allows you to enable or disable the S-ATA boot ROM.	
IDE Detect Time Out (Sec)	0, 5, 10, 15, 20, 25, 30, <b>35</b>	Allows you to set the time out value for detecting ATA/ATAPI devices.	

System Information Submenu

Table 3 - 5: System Information Submenu

Feature	Choices or Display Only	Description	Your Setting
<b>AMIBIOS</b>			
Version	Information only	e.g. 10.13.02	
Build Date	Information only	e.g. 01/16/04	
ID	Information only	e.g. A0037100	
<b>Processor</b>			
Type	Information only	e.g. Intel(R) Celeron(R) CPU 2.80GHz	
Speed	Information only	e.g. 2800MHz	
Count	Information only	e.g. 1	
<b>System Memory</b>			
Size	Information only	e.g. 512MB	

---

 **Note:** The BIOS may display more options than presented here.

---

## Advanced Menu

Table 3 - 6: Advanced Menu

Feature	Choices or Display Only	Description	Your Setting
CPU Configuration	Select submenu		
Chipset	Select submenu		
Onboard Devices Configuration	Select submenu		
PCI/PnP	Select submenu		
USB Configuration	Select submenu		

### CPU Configuration Submenu

Table 3 - 2: CPU Configuration Submenu

Feature	Choices or Display Only	Description	Your Setting
Manufacturer	Information only	e.g. Intel	
Brand String	Information only	e.g. Intel(R) Celeron(R) CPU 2.80GHz	
Frequency	Information only	e.g. 2200MHz	
Ratio Status	Information only	Locked	
Ratio Actual Value	Information only	e.g. 22	
Hyper-Threading Technology	Disabled <b>Enabled</b>	Only if Pentium 4 CPU. Enables or disables the Hyper-Threading technology. See note below.	

#### Notes:

1. This motherboard supports Intel Pentium 4 CPUs with Hyper-Threading Technology
2. Hyper-Threading Technology is supported under Windows 2003, Windows XP and Linux 2.4x (kernel) and later versions only. Under Linux, use the Hyper-Threading compiler to compile code. If you are using any other operating system, disable the Hyper-Threading Technology in this submenu to ensure system stability and performance.
3. It is recommended that you install Windows XP Service Pack 1.
4. Make sure to enable the Hyper-Threading Technology in BIOS before installing a supported operating system.
5. For more information on Hyper-Threading Technology, visit [www.intel.com/info/hyperthreading](http://www.intel.com/info/hyperthreading).

Chipset Submenu

Table 3 - 3: Chipset Submenu

Feature	Choices or Display Only	Description	Your Setting
<b>WARNING: Setting wrong values in below sections may cause system to malfunction.</b>			
Configure DRAM Timing by SPD	Disabled <b>Enabled</b>	When this feature is enabled, the DRAM timing are set according to the DRAM SPD (Serial Presence Detect). When disabled, you can manually set the DRAM timing parameters through the DRAM sub-features	
DRAM ECC Capability	Disabled <b>Enabled</b>	Allows you to enable or disable the DRAM ECC (Error Correction Code) capability.	
Graphics Aperture Size	4, 8, 16, 32, 64, <b>128</b> , 256MB	Allows you to set the size of mapped memory for AGP graphic data.	

Onboard Devices Configuration Submenu

Table 3 - 4: Onboard Devices Configuration Submenu

Feature	Choices or Display Only	Description	Your Setting
Onboard AC'97 Audio	<b>Auto</b> Disabled	Allows you to configure the onboard audio.	
Onboard LAN	Disabled <b>Enabled</b>	This option allows you to enable or disable the onboard LAN controller	
Onboard LAN Boot ROM	Disabled <b>Enabled</b>	Only if Onboard LAN is enabled.	
Serial Port1 Address	Disabled <b>3F8/IRQ4</b> 3E8/IRQ4 2E8/IRQ3	Allows you to select the Serial port 1 base address.	
Serial Port2 Address	<b>Disabled</b> 2F8/IRQ3 3E8/IRQ4 2E8/IRQ3	Allows you to select the Serial port 2 base address.	
Parallel Port Address	Disabled <b>378</b> 278 3BC	Allows you to select the Parallel port base address.	
Parallel Port Mode	Normal <b>Bi-Directional</b> EPP ECP	Allows you to select the Parallel port mode.	
EPP Version	<b>1.9</b> 1.7	Only if Parallel Port Mode set to EPP.	
ECP Mode DMA Channel	DMA0 DMA1 <b>DMA3</b>	Only if Parallel Port Mode set to ECP.	
Parallel Port IRQ	IRQ5 <b>IRQ7</b>	Allows you to select the Parallel port IRQ	

PCIPnP Submenu

Table 3 - 7: PCIPnP Submenu

Feature	Choices or Display Only	Description	Your Setting
<b>WARNING: Setting wrong values in below sections may cause system to malfunction.</b>			
Plug And Play O/S	No Yes	The BIOS will initialise any add-on cards if <i>No</i> is selected. Selecting <i>Yes</i> will mean that the operating system will be left to do this.	

USB Configuration Submenu

Table 3 - 8: USB Configuration Submenu

Feature	Choices or Display Only	Description	Your Setting
USB Function	Disabled Enabled	Enables or disables the USB function	

**Power Menu**

**Table 3 - 9: Security Menu**

Feature	Choices or Display Only	Description	Your Setting
Suspend-to-RAM	Disabled <b>Enabled</b>	When set to <i>Enabled</i> , ACPI sleeping state is Suspend-To-RAM. When set to <i>Disabled</i> , ACPI sleeping state is Suspend-To-Disk	
ACPI APIC support	Disabled <b>Enabled</b>	Used to enable or disable the Advanced Programmable Interrupt Controller (APIC) for PC2001 compliance. Enabling APIC mode will expand available IRQs resources for the system.	
Power Up Control	Select submenu		

**Power Up Control Submenu**

**Table 3 - 10: Power Up Control Submenu**

Feature	Choices or Display Only	Description	Your Setting
Restore on AC Power Loss	<b>Power Off</b> Power On Last State	This option allows you to select how the system will react following a loss of power. <i>Last State</i> means that the system will be restored to the state which it was in previous to the power loss. <i>Power Off</i> means that you will have to restart your system with the power on button and <i>Power On</i> means the system will reboot itself automatically.	
Power On By PCI Devices	<b>Disabled</b> Enabled	This allows you to select whether or not your system will react to PCI Power Management Enabled wake up events.	

## Boot Menu

**Table 3 - 11: Boot Menu**

Feature	Choices or Display Only	Description	Your Setting
Boot Device Priority	Select sub-menu.		
Boot Settings Configuration	Select sub-menu.		
Security	Select sub-menu.		

### Boot Device Priority Submenu

**Table 3 - 12: Boot Device Submenu**

Feature	Choices or Display Only	Description	Your Setting
1st Boot Device	Floppy Disk Drive Hard Disk Drive <b>ATAPI CD-ROM</b> Disabled	Attempts to boot from an ATAPI CD-ROM drive.	
2nd Boot Device	Floppy Disk Drive <b>Hard Disk Drive</b> ATAPI CD-ROM Disabled	Attempts to boot from a hard disk drive device.	
3rd Boot Device	<b>Floppy Disk Drive</b> Hard Disk Drive ATAPI CD-ROM Disabled	Attempts to boot from a floppy disk drive device.	

### Boot Settings Configuration Submenu

**Table 3 - 13: Boot Settings Configuration Submenu**

Feature	Choices or Display Only	Description	Your Setting
Bootup Num-Lock	Off <b>On</b>	This setting, when enabled, automatically turns on your numeric keypad when the system is booted. This item is a matter of personal taste.	

### Security Submenu

**Table 3 - 14: Security Submenu**

Feature	Choices or Display Only	Description	Your Setting
Supervisor Password	Installed Not Installed	Display only	
User Password	Installed Not Installed	Display only	
Change Supervisor Password	[Enter]	Press <b>Enter</b> to set/change supervisor password. You will be asked to confirm password by re-typing it. Pressing Enter instead of a password will set it as Not Installed.	



Table 3 - 14: Security Submenu (Continued)

Feature	Choices or Display Only	Description	Your Setting
User Access Level	No Access View Only Limited <b>Full Access</b>	Only if supervisor password installed	
Change User Password	[Enter]	Only if supervisor password installed  Press <b>Enter</b> to set/change user password. You will be asked to confirm password by re-typing it. Pressing Enter instead of a password will set it as Not Installed.	
Clear User Password	[Enter]	Only if supervisor password installed  Immediately clears the user password after a confirmation message.	
Password Check	<b>Setup</b> Always	Only if supervisor password installed  Setup: check password when entering setup. Always: check password when entering setup as well as on each boot.	

## Exit Menu

You can make the following selections on the Exit Menu. Select an option using the up or down arrow keys, then press <Enter> to execute the option. Pressing <Esc> does not exit this menu. You must select one of the items from the menu or menu bar to exit.

**Table 3 - 15: Exit Menu**

Choices	Description
Exit & Save Changes	Exit after writing all modified Setup item values to NVRAM. F10 key can be used for this operation.
Exit & Discard Changes	Exit leaving NVRAM unmodified. User is prompted if any of the setup fields were modified. Esc key can be used for this operation.
Discard Changes	Read previous values of all Setup items from NVRAM. F7 key can be used for this operation.
Load Setup Defaults	Load default values for all SETUP items. F5 key can be used for this operation.

## Configuring MotherBoard Jumpers

Your system's motherboard has 6 jumper settings:

- Clear CMOS jumper
- USB POWER jumper (x4)
- KBPW jumper

### Clear CMOS Jumper (CLRTC)

1. Power off the system and unplug the AC power cord.
2. Set position as 2-3 (Clear CMOS).
3. Wait 2 seconds.
4. Set position as 1-2 (Normal [Default]).
5. Power on the system. The message 'CMOS checksum bad' displays.
6. Press F2 to enter setup.

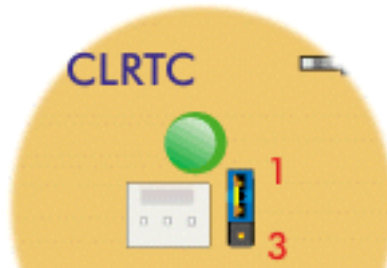

Figure 3 - 1 : Clear CMOS Jumper

### USB Power Jumpers (USBPW78/ USBPW56/ USBPW34/ USBPW12)

- 1-2 position: USB power with 5V.
- 2-3 position: USB power with 5V standby (default).

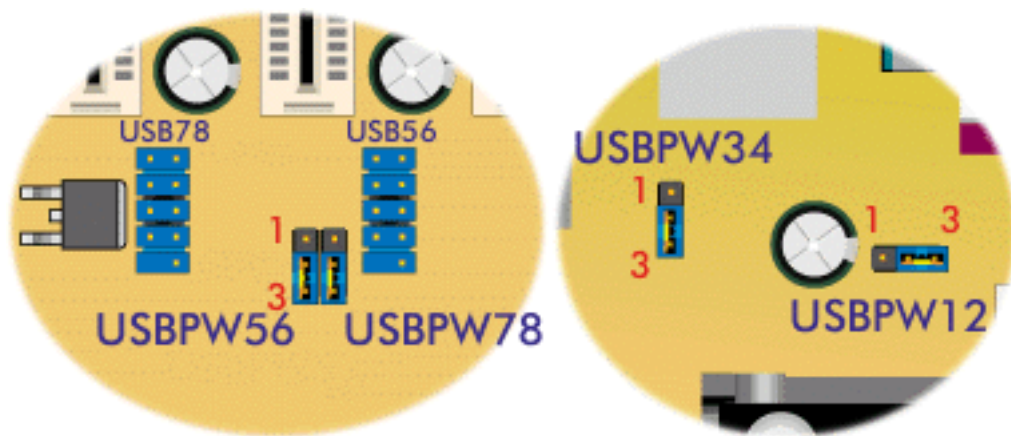

Figure 3 - 2 : USB Power Jumpers

### **Keyboard Power Jumper (KBPW)**

- 1-2 position: Keyboard power.
- 2-3 position: Keyboard power with 5V standby (default).



**Figure 3 - 3 : Keyboard Power Jumper**

# 4

## Upgrading Your System

- General Information
- Static Precautions
- Equipment Log
- Tools Recommended for Upgrading Your System
- Preparing Your System for Upgrade
- Shifting from Tower to Desktop
- Shifting from Desktop to Tower
- Removing or Installing the Right Side Door
- Removing and Replacing the Front Panel
- Removing and Replacing the 3.5/5.25-inch Bracket
- Installing or Removing a 5.25-inch Device
- Installing or Removing a 3.5-inch Floppy Disk Drive
- Installing or Removing Hard Disk Drives
- Upgrading Microprocessor
- Upgrading Random Access Memory (RAM)
- Installing and Removing an Adapter Card
- Replacing the Battery
- Cabling the Device
- Preparing the Device

## General Information



### WARNING

The DC push-button on/off switch on the front panel does not turn off the system AC power. Also, +5vdc is present on the system board whenever the AC power cord is connected between the system and an AC outlet. Before doing the procedures in this manual, make sure that your system is powered off and unplug the AC power cord from the back of the chassis. Failure to disconnect power before opening your system can result in personal injury and equipment damage.

---

### CAUTION

Operating your system with the side access panels removed can damage your system components. For proper cooling and airflow, always replace the side access panels before powering on your system.

---

### WARNING

Avoid burns: If the system has been running, any installed processor and heat sink on the processor board(s) will be hot. To avoid the possibility of a burn, be careful when removing or installing components that are located near processors.

---

Contact your sales representative or dealer for a list of approved optional peripheral devices.

## Static Precautions

An electrostatic discharge (ESD) can damage disk drives, option boards, and other components. You can provide some ESD protection by wearing an antistatic wrist strap attached to chassis ground when handling system components.

Electronic devices can be easily damaged by static electricity. To prevent damage, keep them in their protective packaging when they are not installed in your system.

## Equipment Log

Use the equipment log form located at the end of this manual to record the model and serial number of your system, all installed options, and any other pertinent information specific to your system. You will need this information when configuring your system.

## Tools Recommended for Upgrading Your System

Depending on the upgrade, you will need one or more of the following tools:

- Phillips screwdriver (#1 bit and #2 bit)
- Flat-head screwdriver
- Small needle nose pliers
- Pen or pencil
- ESD workstation or antistatic wrist strap (recommended)

## Preparing Your System for Upgrade

To prepare your system for installation or removal of system components perform the following procedure:

1. Observe the safety and ESD precautions listed under *General Information* and *Static Precautions* at the beginning of this chapter.
2. Shutdown the operating system (OS).
3. If necessary, press the power on/off switch on the front panel of the server (see See “Powering On Your System” on page 8.). The power-on LED goes out.
4. Power off the peripheral devices.
5. Unplug the system power cord(s) from the AC wall outlet(s).

---

 **Note:** If the system power cord is connected to a power control unit such as an UPS (Uninterruptible Power Supply), refer to the UPS user's guide for proper power-off procedures.

---

6. Unplug all the I/O cables connected to the rear panel of your system.

## Shifting from Tower to Desktop

Your Express5800 TM is equipped with a convertible chassis, which allows you to set up your computer either as a tower, or as a desktop. Please find below the instructions needed to turn your tower computer into a desktop system

1. Remove the right side door. See “Removing the Right Side Door:” on page 4-6.
2. Lay the chassis on its left side.
3. Remove the front panel. See “Removing the Front Panel:” on page 4-8.
4. Remove the 3.5/5.25-inch bracket. See “Removing the 3.5/5.25-inch Bracket:” on page 4-9.
5. Replace the 3.5/5.25-inch bracket in the desktop position. See “Replacing the 3.5/5.25-inch Bracket:” on page 4-11..

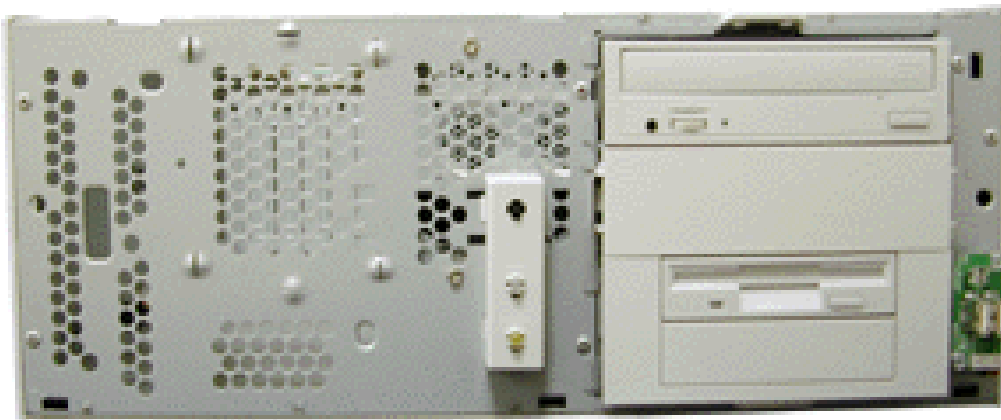

**Figure 4 - 1 : 3.5/5.25-inch Bracket Desktop Position**

6. Look on the inside of the front panel for the back of the logo plate. Press on the four pegs to release the logo plate, and, holding the front panel horizontally, replace the plate according to the desktop configuration.
7. Replace the front panel. See “Replacing the Front Panel:” on page 4-8.
8. Replace the right side door. See “Replacing the Right Side Door:” on page 4-6.

---

 **Caution**

Do not place any object on the venting holes in order to cool internal temperature down properly.

---

Congratulations, your Express5800 TM is now ready to be used as a desktop system!



## Shifting from Desktop to Tower

Your Express5800 TM is equipped with a convertible chassis, which allows you to set up your computer either as a tower, or as a desktop. Please find below the instructions needed to turn your desktop computer into a tower system.

1. Remove the right side door. See “Removing the Right Side Door:” on page 4-6.
2. Lay the chassis on its left side.
3. Remove the front panel. See “Removing the Front Panel:” on page 4-8.
4. Remove the 3.5/5.25-inch bracket. See “Removing the 3.5/5.25-inch Bracket:” on page 4-9.
5. Replace the 3.5/5.25-inch bracket in the tower position. See “Replacing the 3.5/5.25-inch Bracket:” on page 4-11.

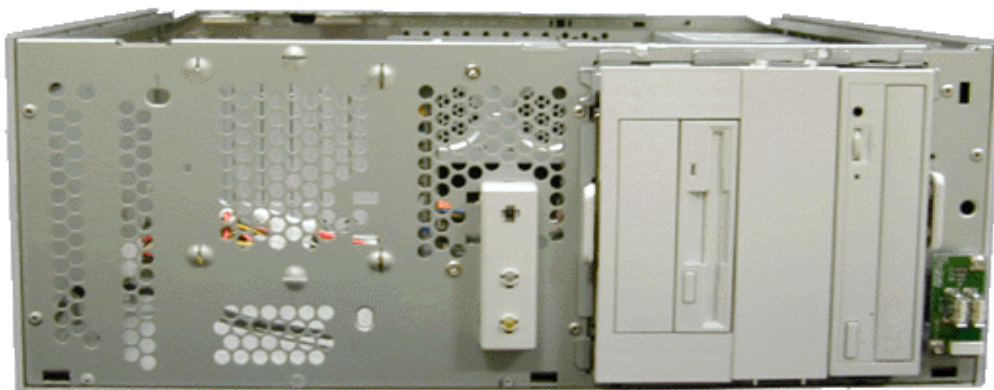

**Figure 4 - 2 : 3.5/5.25-inch Bracket Tower Position**

6. Look on the inside of the front panel for the back of the logo plate. Press on the four pegs to release the logo plate, and, holding the front panel horizontally, replace the plate according to the tower configuration.
7. Replace the front panel. See “Replacing the Front Panel:” on page 4-8.
8. Replace the right side door. See “Replacing the Right Side Door:” on page 4-6.

Congratulations, your Express5800 TM is now ready to be used as a tower system!

## Removing or Installing the Right Side Door

The right side door (tower configuration), also known as top cover (desktop configuration) provides access to the disk drive bays, to the motherboard and to the 5.25 and 3.5-inch bays. The left side cover (tower configuration) only provides access to the power supply. Only a qualified technician should remove the left side cover of this chassis.

### Removing the Right Side Door:

1. Make sure the power switches for the computer, video monitor and any peripheral devices are turned OFF and unplug the power cord (see the 'Safety Precautions' chapter).
2. Disconnect the monitor and peripheral devices (printers, for instance) from the system.
3. Remove the two thumb screws located on the back of your system.
4. Carefully slide the cover about two centimetres towards the back of the unit; a handle is provided to aid with this process. Please note that you may find this procedure easier to follow if you lay the unit on the left side..



**Figure 4 - 3 : Removing the Right Side Door**

5. Lift the cover away from the computer

### Replacing the Right Side Door:

Avoid damaging your system - before replacing the cover, make sure no cables or other devices protrude from the chassis.

---

 **Note:** If you have previously removed the front panel, be sure to fasten it securely to the chassis before restoring the cover. The front panel must be securely connected to the chassis before you replace the cover.

---

1. Take a few moments to examine the interior side of the cover, and notice the 4 metal hooks located on two opposite edges, and the 6 bigger hooks located on a third edge.
2. Leaving about 1 centimetre to slide the cover forward, lay the cover on the chassis, and check that the metal hooks are ready to be inserted into their corresponding slots. You may find this procedure easier to follow if you lay the unit on the left side.
3. Make sure the cover is properly inserted; the cover, the chassis and the front panel should fit squarely together.
4. Secure the two thumb screws in their respective holes.

## Removing and Replacing the Front Panel

### Removing the Front Panel:

1. Remove the right side door, and lay the chassis on its left side. See “Removing the Right Side Door:” on page 4-6.
2. The front panel is secured by 6 pop-in tabs. Press upwards on the three upper tabs (A) to free them.

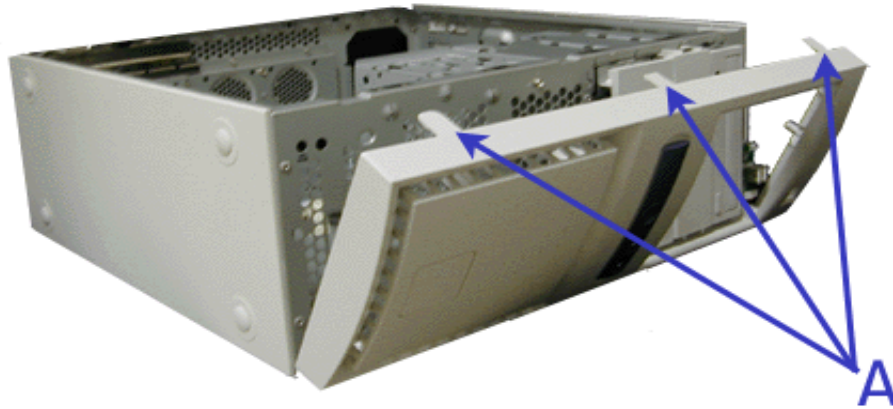

**Figure 4 - 4 : Pop-in Tabs**

3. Gently pull the right side of the front panel toward you in order to free two more pop-in tabs.
4. Once the right side is free, pivot the front panel toward you until it is totally released. Be careful not to damage the switches and LEDs board when pulling.

### Replacing the Front Panel:

1. Insert the two tabs located on the bottom left and middle of the front panel into their respective slots. You may have to slightly pivot the front panel to aid the process.
2. Gently press on the upper and right parts of the front panel until the 4 remaining tabs are securely inserted into their slots.
3. Replace the right side door. See “Replacing the Right Side Door:” on page 4-6.

## Removing and Replacing the 3.5/5.25-inch Bracket

This section of the chapter describes how to remove and replace the 3.5/5.25-inch bracket containing the two 5.25-inch bays and the two 3.5-inch bays.

### Removing the 3.5/5.25-inch Bracket:

1. Remove the screw securing the HDD bracket and the 3.5/5.25-inch bracket together.



**Figure 4 - 5 : HDD Bracket Screw**

2. Disconnect all cables (power, data, and others, if applicable) from the installed 3.5- and 5.25-inch devices.

---

### **Caution**

Be careful when working around the cables connected to the already installed drives.

If necessary disconnect these cables, but be sure to note which device each cable or power lead was attached to.

---

3. Press the two tabs on top and bottom of the 3.5/5.25-inch bracket.

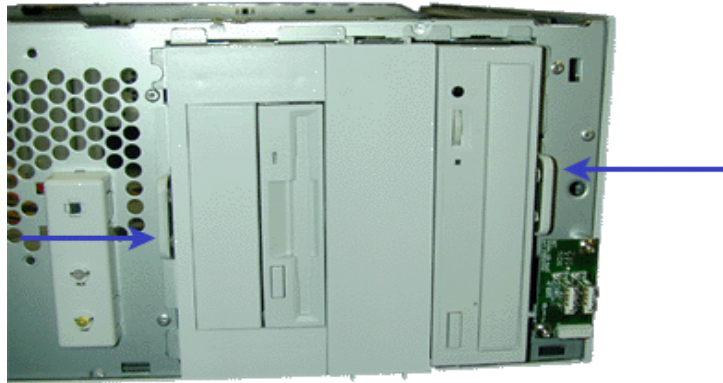

**Figure 4 - 6 : 3.5/5.25-inch Bracket Tabs**

4. Gently pull the entire bracket with the installed devices out of the chassis.

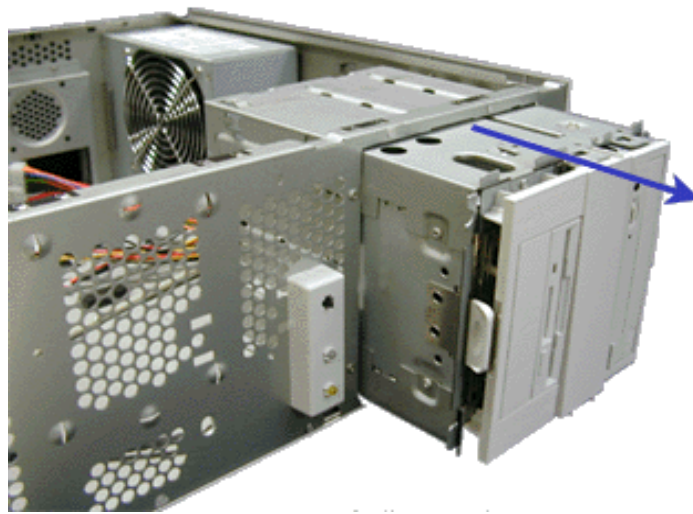
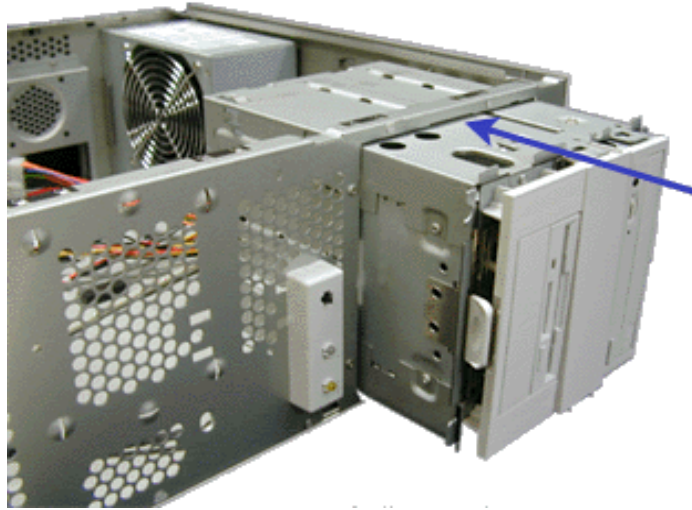

**Figure 4 - 7 : Pulling the Bracket**



### **Replacing the 3.5/5.25-inch Bracket:**

1. Slide the 3.5/5.25-inch bracket inside the chassis until it clicks in position.



**Figure 4 - 8 : Replacing the Bracket**

2. Replace the screw securing the HDD bracket and the 3.5/5.25-inch bracket together.



**Figure 4 - 9 : Replacing the Screw**

3. Re-connect all cables (power, data, and others, if applicable) to the installed 3.5- and 5.25-inch devices. See “Cabling the Device” on page 4-32.

## Installing or Removing a 5.25-inch Device

This section of the chapter describes how to add and remove 5.25-inch devices. You can install a CD-ROM/ DVD-ROM/ COMBO DVD-ROM CD-RW Drive, tape backup unit, or other 5-25 inch devices in the additional 5.25-inch bay. See the installation instructions included with those items for specific installation information. Before installing a 5.25-inch device, read section “Preparing the Device” on page 37.

### Adding a 5.25-inch Device

1. Remove the right side door. See “Removing the Right Side Door:” on page 6.
2. Remove the front panel. See “Removing the Front Panel:” on page 8.
3. Remove the 3.5/5.25-inch bracket. See “Removing the 3.5/5.25-inch Bracket:” on page 9.
4. Gently pull on the desired slot cache to remove it, then pull on the metallic shield to remove it.
5. Slide the 5.25-inch device through the front of the 3.5/5.25-inch bracket, connectors first. Please check that the front of the device is perfectly aligned with the other installed devices.

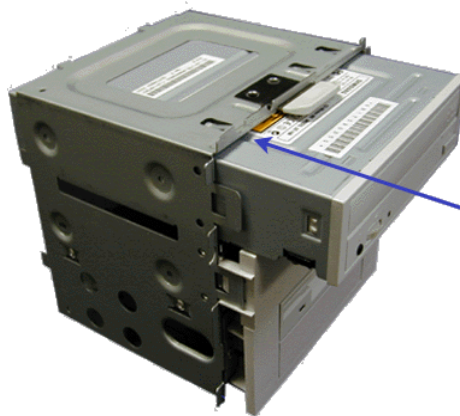

**Figure 4 - 10 : Adding a 5.25-inch Device**

6. Secure the four screws (two on each side).
7. Replace the 3.5/5.25-inch bracket. See “Replacing the 3.5/5.25-inch Bracket:” on page 11.
8. Connect the data cable to the device with the marked edge toward pin 1 of the drive. See “Cabling the Device” on page 32.
9. Connect the power cable to the drive. See “Cabling the Device” on page 32.
10. Replace the front panel. See “Replacing the Front Panel:” on page 8.
11. Replace the right side door. See “Replacing the Right Side Door:” on page 6.

---

 **Note:** Modify the BIOS Setup program to recognise the additional device. For additional information, refer to the ‘Configuring your system’ chapter.

---



## Removing a 5.25-inch device

1. Remove the right side door. See “Removing the Right Side Door:” on page 6.
2. Remove the front panel. See “Removing the Front Panel:” on page 8.
3. Remove the 3.5/5.25-inch bracket. See “Removing the 3.5/5.25-inch Bracket:” on page 9.
4. Remove the four screws (two on each side) securing the 5.25-inch device.
5. Slide the 5.25-inch device gently outwards, through the front of the chassis, and set it aside.

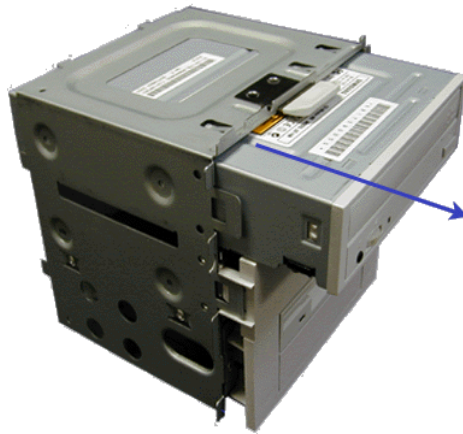

**Figure 4 - 11 : Removing a 5.25-inch Device**

6. Use a plastic slot cache to close the available 5.25-inch bay. Simply push it into the bay until it clicks into place.
7. Replace the 3.5/5.25-inch bracket. See “Replacing the 3.5/5.25-inch Bracket:” on page 11.
8. Replace the front panel. See “Replacing the Front Panel:” on page 8.
9. Replace the right side door. See “Replacing the Right Side Door:” on page 6.

## Installing or Removing a 3.5-inch Floppy Disk Drive

This section describes how to remove, replace and add 3.5-inch Floppy Disk Drives (FDDs). Two 3.5-inch floppy disk drives can be installed in the FDD bracket. If a floppy disk drive was installed into your system at the factory, it is located in the upper slot of the bracket.

### Removing a 3.5-inch Floppy Disk Drive

To remove the floppy disk drive from the upper 3.5-inch slot of the 3.5/5.25-inch bracket:

1. Remove the right side door. See “Removing the Right Side Door:” on page 6.
2. Remove the front panel. See “Removing the Front Panel:” on page 8.
3. Remove the 3.5/5.25-inch bracket. See “Removing the 3.5/5.25-inch Bracket:” on page 9.
4. Remove the three screws (*A*) securing the floppy disk drive to the bracket (two on the left side and one on the right side)

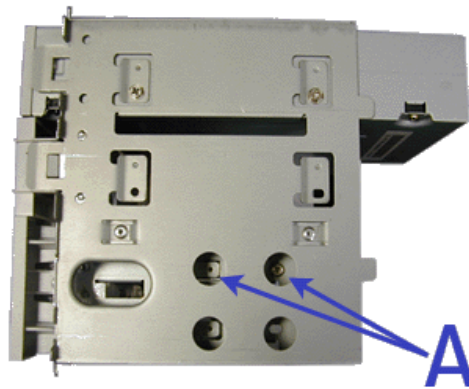

**Figure 4 - 12 : Removing the Screws**

5. Slide the floppy disk drive out of the bracket.



**Figure 4 - 13 : Sliding the Floppy Disk Drive out**

6. Set the floppy disk drive aside.

## Installing a 3.5-inch Floppy Disk Drive

To install a 3.5-inch floppy disk drive in the upper 3.5-inch slot of the 3.5/5.25-inch bracket:

1. Remove the right side door. See “Removing the Right Side Door:” on page 6.
2. Remove the front panel. See “Removing the Front Panel:” on page 8.
3. Remove the 3.5/5.25-inch bracket. See “Removing the 3.5/5.25-inch Bracket:” on page 9.
4. Slide the floppy disk drive into the upper slot of the bracket until the three screw holes (*A* - two on the left side and one on the right side) are lined up, and secure three screws.

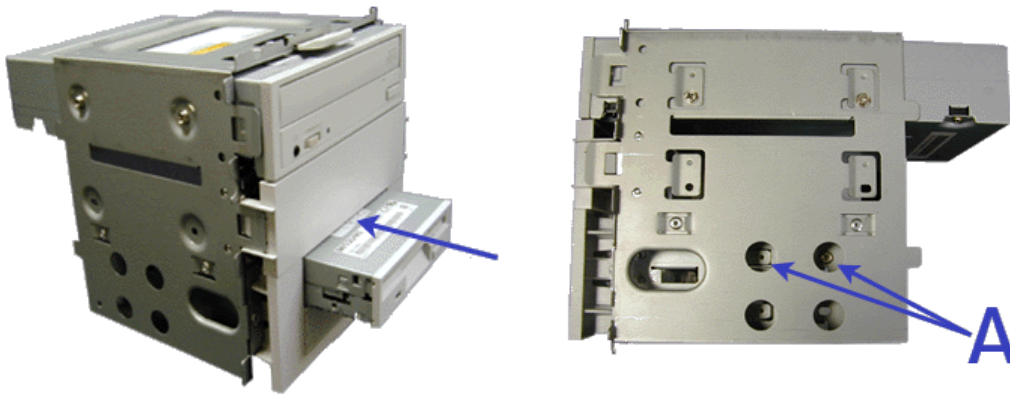

**Figure 4 - 14 : Installing a 3.5-inch Floppy Disk Drive**

5. Replace the 3.5/5.25-inch bracket. See “Replacing the 3.5/5.25-inch Bracket:” on page 11.
6. Connect the data cable to the floppy disk drive with the marked edge toward pin 1 of the drive. See “Cabling the Device” on page 32.
7. Connect the power cable to the drive. See “Cabling the Device” on page 32.
8. Replace the front panel. See “Replacing the Front Panel:” on page 8.
9. Replace the right side door. See “Replacing the Right Side Door:” on page 6.

---

 **Note:** Modify the BIOS Setup program to set up drive A as a 3.5-inch, 1.44M. For additional information refer to the BIOS Setup chapter.

---

## Adding a Floppy Disk Drive

If your motherboard supports 2 floppy disk drives, you can add an additional floppy disk drive in the second 3.5-inch slot of the 3.5/5.25-inch bracket.

To add a floppy disk drive in the lower 3.5-inch slot of the 3.5/5.25-inch bracket:

1. Remove the right side door. See “Removing the Right Side Door:” on page 6.

2. Remove the front panel. See “Removing the Front Panel:” on page 8.
3. Remove the 3.5/5.25-inch bracket. See “Removing the 3.5/5.25-inch Bracket:” on page 9.
4. Through the holes (*A* - one on each side of the bracket) gently pull the tabs (*B*) to remove the 5.25-inch plastic adaptation kit. Pull on the 3.5-inch plastic slot cache to remove it, and proceed the same way with the corresponding metallic shield on the FDD bracket. Replace the 5.25-inch plastic adaptation kit.

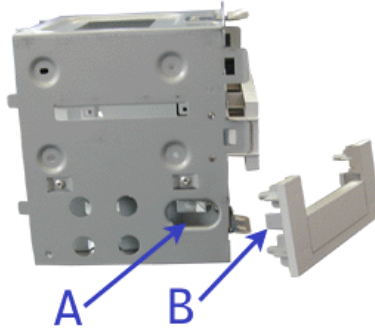

**Figure 4 - 15 : Removing the Plastic Kit**

5. Slide the floppy disk drive into the lower slot of the bracket until the three screw holes (*A* - two on the left side and one on the right side) are lined up, and secure three screws.

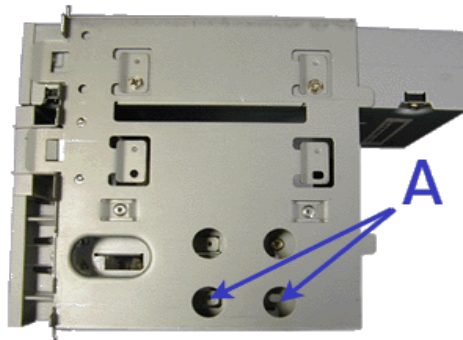

6. Replace the 3.5/5.25-inch bracket. See “Replacing the 3.5/5.25-inch Bracket:” on page 11.
7. Connect the data cable to the floppy disk drive with the marked edge toward pin 1 of the drive and all cables to the installed 3.5- and 5.25-inch devices. See “Cabling the Device” on page 32.

---

 **Note:** The installation of a second diskette drive requires the replacement of the existing diskette drive data cable with a three-connector cable in order to plug both floppy disk drives to the floppy disk drive connector on the motherboard.

---

8. Connect the power cable to the drive. See “Cabling the Device” on page 32.
9. Replace the front panel. See “Replacing the Front Panel:” on page 8.
10. Replace the right side door. See “Replacing the Right Side Door:” on page 6.

---

 **Note:** Modify the BIOS Setup program to recognise the additional FDD. For additional information, refer to the BIOS Setup chapter.

---

## Installing or Removing Hard Disk Drives

This section describes how to remove, replace and add Hard Disk Drives.

### Removing a Hard Disk Drive

1. Remove the right side door. See “Removing the Right Side Door:” on page 4-6.
2. Remove the front panel. See “Removing the Front Panel:” on page 4-8.
3. Remove the screw (A) securing the HDD bracket and the 3.5/5.25-inch bracket together. See “Removing the 3.5/5.25-inch Bracket:” on page 4-9.

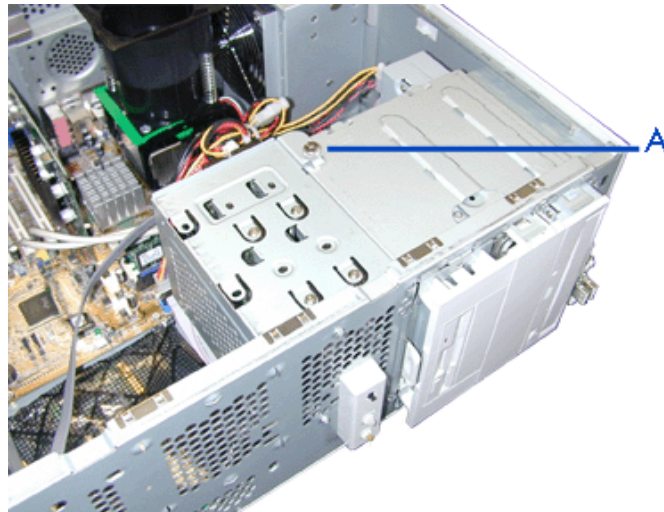

**Figure 4 - 16 : HDD Bracket Screw**

4. Disconnect the DATA cable and the power cable from each hard disk drive installed.

---

### **Caution**

Be careful when working around the cables connected to the already installed drives.

If necessary disconnect these cables, but be sure to note which device each cable or power lead was attached to.

---

5. Remove the two screws (B) holding the HDD bracket to the front of the chassis.

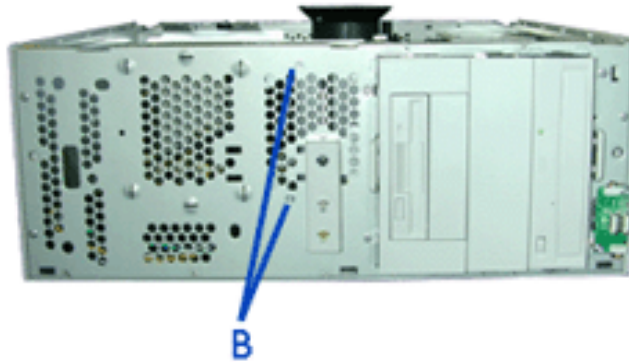

**Figure 4 - 17 : HDD Bracket Screws**

6. Slide the HDD bracket backwards, and set it aside.
7. The hard disk drive is secured to the bracket with 4 screws located either on both sides (slot C) or on top of the hard disk drive (slot A). Remove these screws, and slide the hard disk drive out of the bracket.
8. Set the hard disk drive aside.



## Installing a Hard Disk Drive

---

### Warning

Make sure to install hard disk drives in either slot A or slot C.

**DO NOT use Slot B.** Doing so may damage the system and result in serious burns.

---

1. Refer to the information provided with the hard disk drive for pre-installation instructions and master/slave/cable select pin configurations. See “Preparing the Device” on page 4-37.
2. Remove the right side door. See “Removing the Right Side Door:” on page 4-6.
3. Remove the front panel. See “Removing the Front Panel:” on page 4-8.
4. If applicable, disconnect the data and power cables of the installed hard disk drives.
5. Remove the screw (*A*) securing the HDD bracket and the 3.5/5.25-inch bracket together.



**Figure 4 - 18 : HDD Bracket Screw**



6. Remove the two screws (B) holding the HDD bracket to the front of the chassis, slide the HDD bracket backwards, and set it aside.

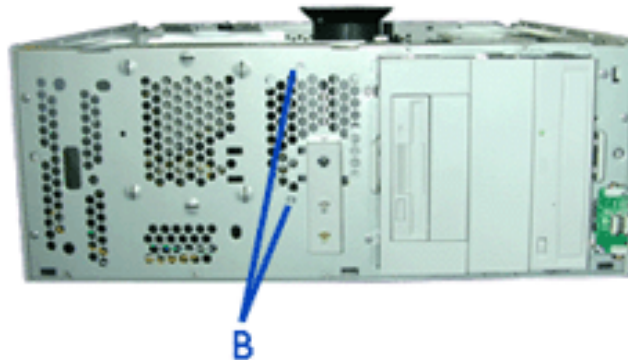

Figure 4 - 19 : HDD Bracket Screws

---

 **Caution**

Be careful when working around the cables connected to the already installed drives.

If necessary disconnect these cables, but be sure to note which device each cable or power lead was attached to.

---

7. Notice the screw holes located on each side of the HDD bracket (B & C) and under the HDD bracket (A), and the corresponding screw holes located on the hard disk drive you mean to install. Making sure the screw holes will line up, slide the hard disk drive into one of the available slots, connectors last.

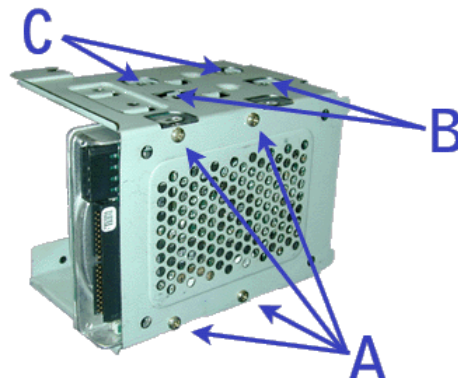

8. If in slot C, secure screws into the four side screw holes of the hard disk drive.
9. If in slot A, secure screws into the four top screw holes of the hard disk drive.
10. Slide the HDD bracket along the 3.5/5.25-inch bracket. Make sure that the four tabs located on the open side of the HDD bracket are fully inserted into their slots, and that the two screw holes located on the front of the chassis are lined

up. If the HDD bracket is correctly inserted, the top and back of the HDD and 3.5/5.25-inch bracket should fit squarely together.

11. Secure two screws in the screw holes (*B*) located on the front of the chassis.

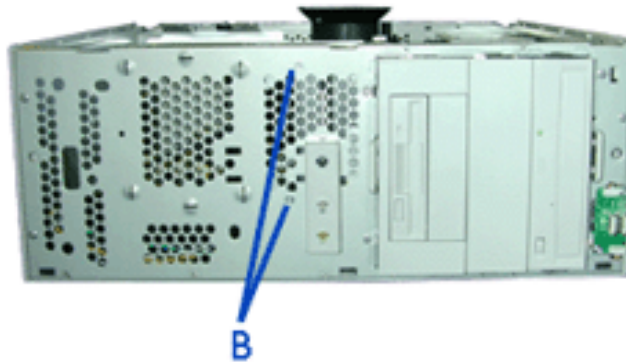

**Figure 4 - 20 : HDD Bracket Screws**

12. Secure the screw (*A*) securing the HDD bracket and the 3.5/5.25-inch bracket together.

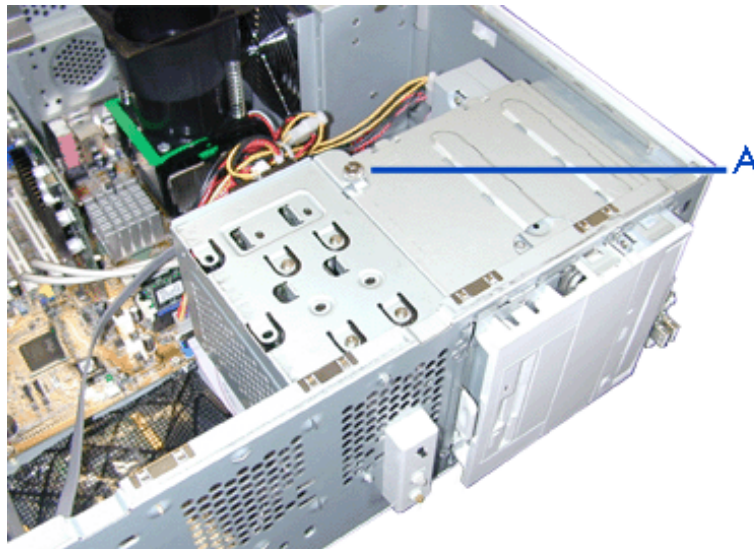

**Figure 4 - 21 : HDD Bracket Screw**

13. Connect the DATA and power cables to their respective hard disk drives. See “Preparing the Device” on page 4-37.
14. Replace the front panel.
15. Replace the right side door.

---

 **Note:** Modify the BIOS Setup program to automatically recognise the hard disk drive. For additional information, refer to the BIOS Setup chapter.

---

## Upgrading Microprocessor

Your system is fitted with a Pentium™ 4 processor. That processor is installed in a Socket mPGA 478B.

Install a CPU according to the following procedure.

1. Remove the side access panel. See “Removing the Right Side Door:” on page 4-6.
2. Remove the processor air duct:
  - remove the two screws (A) securing the air duct or unclip the air duct.

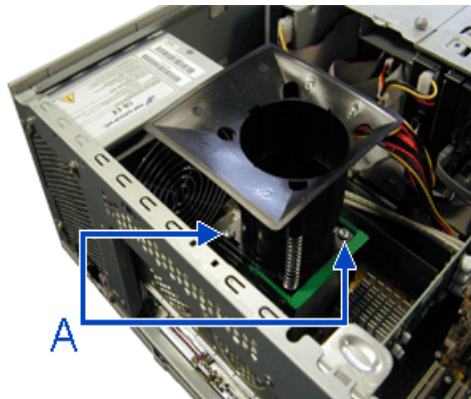

- Gently pull on the air duct and set it aside.
3. Lift the handle.
  4. Unconnect the fan cable from the the CPU fan connector on the motherboard.
  5. Unclip the heatsink starting with the two mobile arms located on the Power Supply Unit side.
  6. Set the heatsink aside.
  7. Locate the processor socket.
  8. Lift the lever on the socket and remove the CPU.

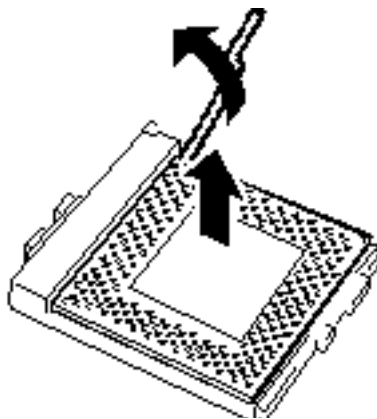

9. Remove the new processor from its antistatic package and place it on a grounded, static-free surface or conductive foam pad.
10. Position the processor over the processor socket so that its pins align with the socket holes.



---

 **Note:** Be aware of CPU direction. Pin layouts on two corners among four differ from others to prevent an incorrect insertion. Confirm the pin mark and pin layout on the socket, and insert the CPU correctly.

---

11. Gently apply pressure equally over the top surface of the processor until it seats in the socket. The processor should fit, do not force the processor into the socket. Push the socket lever down until it snaps into the locked position.

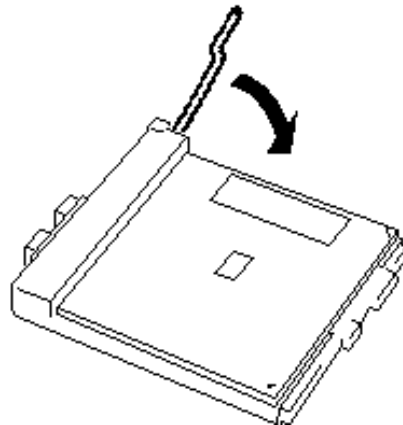

12. Position the heat sink on the processor.
13. Install both heat sink clips as follows:
  - Hook one end of the clip over the tab on the retention (facing the power supply unit).
  - Align the clip with the slot in the heat sink ; press down on the front part of the clip while hooking the other end of the clip over the tab on the retention (facing the AGP connector) .
  - Install the other clip.

---

 **Note:** Make sure that the heatsink is level.

---

14. Push the handle down.
15. Connect the fan cable to the CPU fan connector on the motherboard.
16. Replace the air duct:
  - Make sure the arrow on the air duct points towards the Power Supply Unit.
  - Replace the two screws removed in step 2 or clip the air duct.
17. Replace the side access panel. See “Replacing the Right Side Door:” on page 4-6.

# Upgrading Random Access Memory (RAM)

## Recommended Memory Configuration

The table hereafter shows the recommended memory configurations.

**Table 4 - 1: Recommended Memory Configurations**

Mode		Sockets			
		DIMM_A1 (blue)	DIMM_A2 (black)	DIMM_B1 (blue)	DIMM_B2 (black)
Single-channel	(1)	Populated*	–	–	–
	(2)	–	Populated	–	–
	(3)	–	–	Populated	–
	(4)	–	–	–	Populated
Dual-channel	(1)	Populated	–	Populated	–
	(2)	–	Populated	–	Populated
	(3)**	Populated	Populated	Populated	Populated

\* If only slot A1 is populated, slot B1 can be populated with same size DIMM. Doing so automatically switches to dual-channel mode.

\*\* For dual-channel configuration (3), you need to install identical DIMM pair in DIMM\_A1 and DIMM\_B1 (blue sockets) and identical DIMM pair in DIMM\_A2 and DIMM\_B2 (black sockets).

## Checking System Memory

If you do not know how much memory is installed in your system, check the amount by using the relevant following procedure.

---

 **Note:** The maximum memory size supported in your system is 4 GB.

---

### Windows® 2000

1. On the Windows desktop, point to **My Computer** and click the right mouse button.
2. With the left mouse button, click **Properties**. The **General** tab shows the random access memory (RAM). This is the amount of system memory in your computer.

### Windows® XP

1. On the Windows desktop, click on **Start**, and select **Control Panel**.

2. Click on **Switch to classic view**.
3. Double click on the **System** icon, and click on the **General** tab. This tab shows the random access memory (RAM). This is the amount of system memory in your computer.

### Windows® 2003

1. On the Windows desktop, click on **Start**, and select **Control Panel**.
2. Click on **Switch to classic view**.
3. Double click on the **System** icon, and click on the **General** tab. This tab shows the random access memory (RAM). This is the amount of system memory in your computer.

## Removing a DDR module

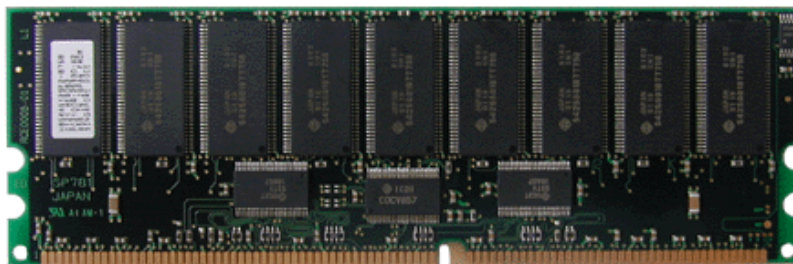

**Figure 4 - 22 : DDR Memory Module Sample**

If your memory configuration requires the removal of a module, perform the following steps:

1. Remove the computer right side door. See “Removing the Right Side Door:” on page 4-6.
2. Locate the memory upgrade sockets on the motherboard.
3. Press the plastic clips at the outer edge of the socket away from the memory module. This ejects the memory module from the socket. Don't touch the module's metal "fingers." Store the module in an anti-static bag (available at electronic supply stores) or a cardboard box.

## Installing a DDR module

1. Remove the computer right side door. See “Removing the Right Side Door:” on page 4-6.
2. If you need to remove a currently installed memory module, refer to the above section.
3. Align the new module with an empty memory socket. Make sure the notch on the module aligns with the key in the socket. The module is designed to install into the socket in only one way.
4. Press the module firmly into the socket. If you have difficulty installing a module, do not force it! Carefully remove the module, then check the alignment of the module's notch with the one in the socket. Then re-install the module.

5. Make sure the locking clips at either end of the module click closed. If the brackets do not secure themselves to the module, carefully remove the module, then reinstall it.
6. Replace the computer right side door. See “Replacing the Right Side Door:” on page 4-6.

---

 **Note:** *The amount of installed memory will be automatically detected by the system.*

---



## Installing and Removing an Adapter Card

Your computer's motherboard features several expansion slots that can accommodate accessory adapter cards, such as a sound card or TV card. Please refer to section Expansion Cards Resources hereafter for details.

### Installing an Adapter Card

1. Push the two tabs (A) and remove the metallic bracket that holds the expansion slots covers and the expansion cards in place. Choose the slot that you want to install your adapter card into and remove its cover from the chassis. Set both items aside. Save the expansion slot cover in a safe place in case you ever need to replace it.
2. Remove your adapter card from its protective packaging. Do not touch the metal “fingers” on the edge of the card.
3. Check the adapter card's documentation for any switches or jumpers that may need to be set, and set them now.
4. Carefully, but firmly, press the adapter card into the connector.
5. After installation, replace the metallic bracket that you removed in step one.

### Removing an Adapter Card from Your System

1. Push the two tabs (A) and remove the metallic bracket that holds the expansion card in place.

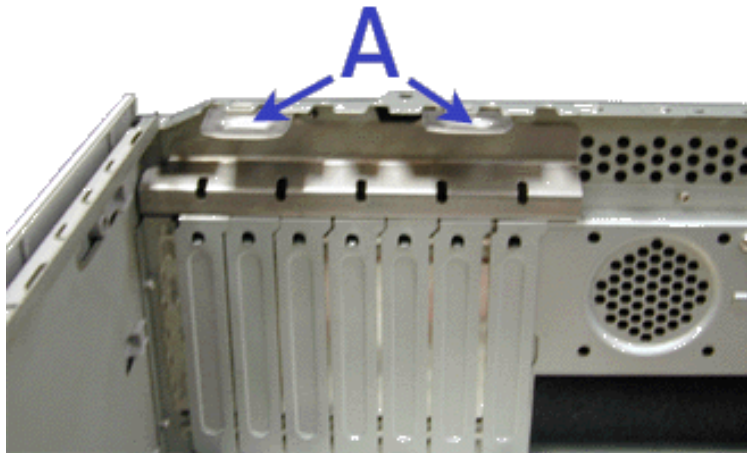

**Figure 4 - 23 : Metallic Bracket Tabs**

2. Do not touch any components on the card - handle it only by its edges, to avoid risk of damage from electrostatic discharge. Without flexing the motherboard, carefully unplug the card from its connector on the motherboard, and remove it from the expansion slot on the chassis' rear panel.
3. Store the adapter card in an anti-static bag (available from electronic supply stores) or a cardboard box.
4. Place an expansion slot cover in the space left by the expansion card you removed.
5. Secure the cover into the rear of the chassis with the metallic bracket (that you removed in Step 1).

For more details on the location and availability of the adapter card slots on your system's motherboard, see the section entitled *Motherboard*.

### **Expansion Cards Resources**

We advise you to install any optional adapter cards accordingly to the following order:

- If an AGP board is installed, PCI slots are available in this order: 4, 1, 5, 2, 3.
- If a PCI board is installed, remaining PCI slots are available in this order: 1, 5, 2, 3.



### **Caution**

Do not mix AGP and PCI video boards.

---

## Replacing the Battery

All motherboards use a battery to maintain system configuration information. If it fails to maintain system configuration, replace it with an identical rated battery from the same manufacturer.

Remove the battery from the motherboard as follows:

---

### **Caution**

Removing the battery from the motherboard causes the computer to lose system configuration information. Before removing it, run Setup and record the system configuration settings.

Use this information to restore the system after replacing the battery.

---

1. Turn off and unplug the system unit and any external options connected to the system.
2. Remove the cover. See “Removing the Right Side Door:” on page 4-6.
3. Locate the battery on the motherboard. See “Motherboard” on page 1-8.
4. Use your finger to carefully remove the battery from the battery socket on the motherboard.

---

### **Warning**

The battery may explode if it is incorrectly replaced or improperly discarded.

Use only an identical rated battery from the same manufacturer.

---

5. With the positive (+) side facing up, press the new battery into the socket.
6. Replace the system unit cover.
7. Connect external peripherals and power cables.
8. Run Setup to reconfigure system parameters.

## Cabling the Device

### The IDE Cable

Depending on your configuration, your system may come with two three-connector IDE interface cables, one joining your hard disk drive to the primary IDE connector on the system board, the other joining your CD or DVD-ROM drive to the secondary IDE connector on the system board.

Each IDE connector on the motherboard supports two devices.

The addition of a device to an IDE connector does not require the replacement of the existing IDE cable.

The following figure shows a typical three-connector IDE cable. If the IDE cable is not keyed with a connector tab, align the coloured edge (Pin 1) of the cable with the pin 1 side of the drive connector.

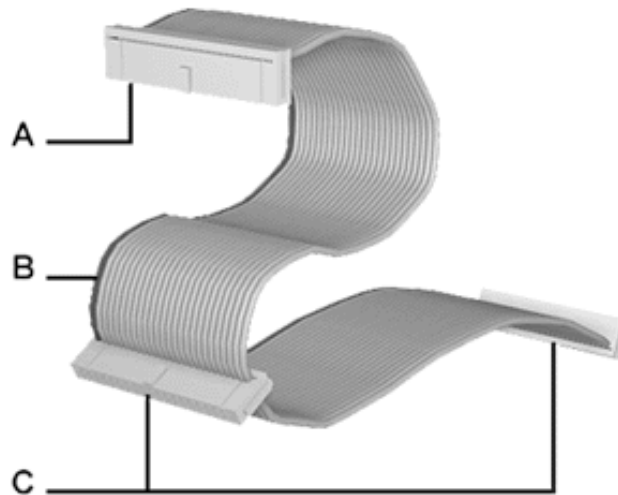

- A - Connects to the motherboard IDE port
- B - Red edge (Pin 1)
- C - Connects to IDE devices

**Figure 4 - 24 : Three-connector IDE Cable**

### The S-ATA Cable

Depending on your configuration, your system may come equipped with a S-ATA cable.

The following picture shows a S-ATA cable. Black side goes to hard disk drive; blue side goes to motherboard.



**Figure 4 - 25 : S-ATA Cable**

## **System Power Cables**

Power cables come from the power supply and are attached to standard storage devices. System power cables vary in length and provide connector sizes to accommodate a variety of supported storage configurations. Power cable connectors are keyed to fit only in the correct position. The following figures respectively show the power cable connector for an IDE storage device and the power cable adaptor for a S-ATA device.

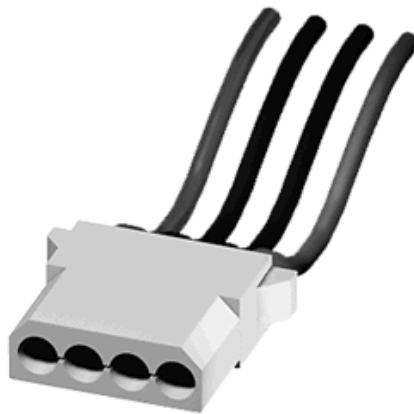

**Figure 4 - 26 : IDE Storage Device Power Cable Connector**



**Figure 4 - 27 : S-ATA Storage Device Power Cable Adaptor**

## **Cabling a CD/DVD-ROM or CD-RW Drive**

All storage devices require power and IDE cable connections. Devices shipped with the system are already connected.

The following procedure explains how to attach the cables to a CD/DVD-ROM or CD-RW drive.

1. Connect the IDE cable connector (B) to the matching pins on the storage device.

- Take care to prevent bending drive connector pins.
  - Align the cable connector to the matching pins on the drive.
2. Locate an available power connector coming from the power supply.
  3. Connect the appropriate power cable (D) to the power connector on the storage device.

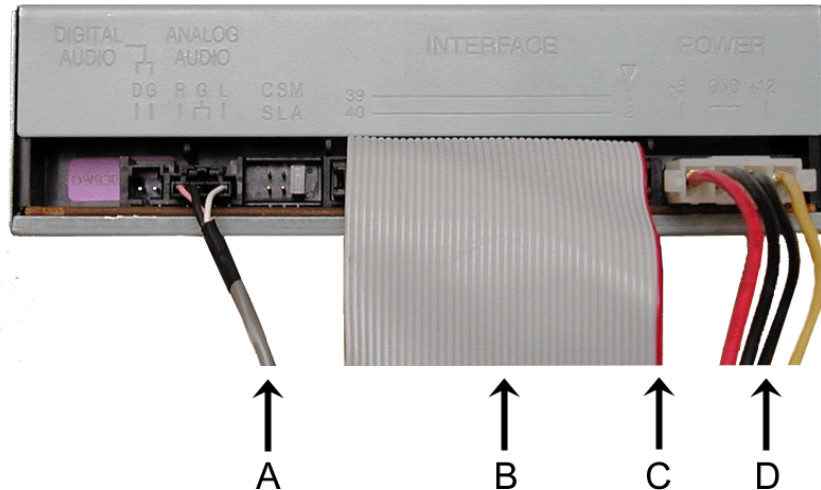

**Figure 4 - 28 : Cabling an Optical Device**

- A - Audio Cable - N/A
- B - IDE cable
- C - Red edge (Pin 1)
- D - Power cable

---

 **Note:** Audio Cable is not available on this system.

---

## **Cabling a Hard Disk Drive**

All storage devices require power and DATA cable connections. Devices shipped with the system are already connected.

The following procedures explain how to attach the cables to a hard disk drive.

### **E-IDE Hard Disk Drive**

1. Connect the IDE cable connector (A) to the matching pins on the storage device.
  - Take care to prevent bending drive connector pins.
  - Align the cable connector to the matching pins on the drive.

2. Locate an available power connector coming from the power supply.
3. Connect the appropriate power cable (B) to the power connector on the storage device.

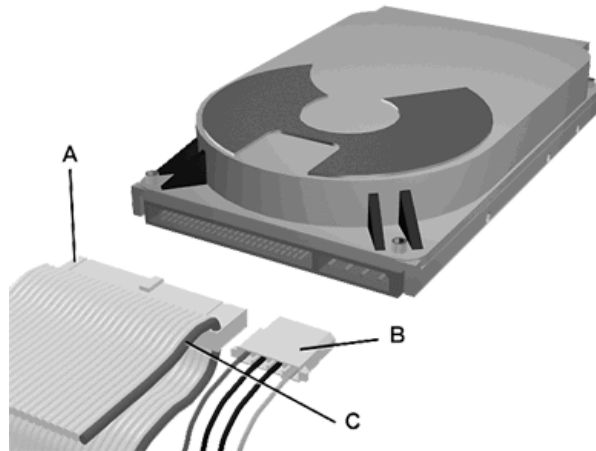
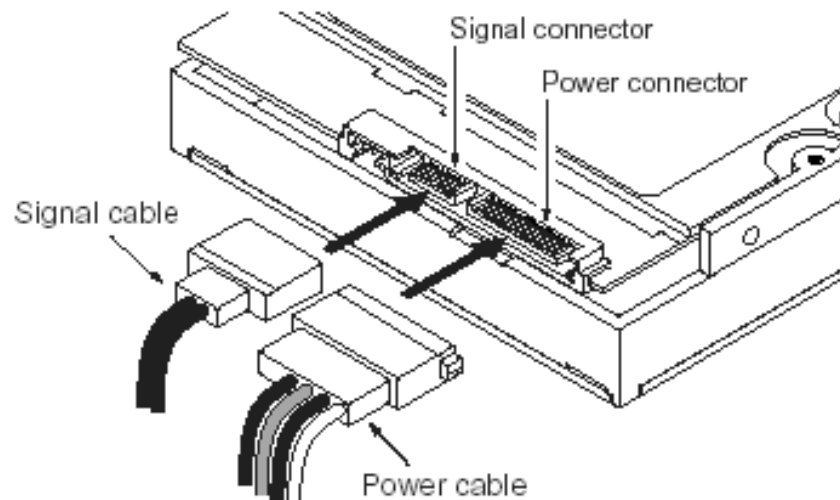

**Figure 4 - 29 : Cabling an IDE Hard Disk Drive**

- A - IDE cable
- B - Power cable
- C - Red edge (Pin 1)

#### S-ATA Hard Disk Drive

1. Connect the S-ATA cable connector to the matching pins on the storage device.
  - Take care to prevent bending drive connector pins.
  - Align the cable connector to the matching pins on the drive. Black side goes to hard disk drive; blue side goes to motherboard. Refer to S-ATA Hard Disk Drive picture hereafter.
2. Locate an available power connector coming from the power supply.
3. Connect the appropriate power cable to the cable power adaptor.
4. Connect the power cable adaptor to the connector on the storage device.



**Figure 4 - 30 : S-ATA Hard Disk Drive**

## Cabling a Floppy Disk Drive

All storage devices require power and data cable connections. Devices shipped with the system are already connected.

The following procedure explains how to attach the cables to a floppy disk drive.

1. Connect the data cable connector (A) to the matching pins on the storage device.
  - Take care to prevent bending drive connector pins.
  - Align the cable connector to the matching pins on the drive.
2. Locate an available power connector coming from the power supply.
3. Connect the appropriate power cable (C) to the power connector on the storage device.

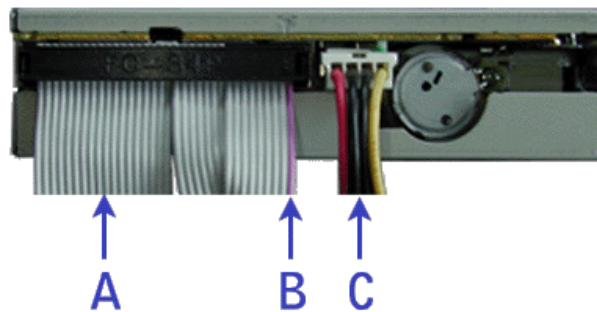

**Figure 4 - 31 : Cabling a Floppy Disk Drive**

- A - Data cable
- B - Purple edge (Pin 1)
- C - Power cable



## Preparing the Device

**Note:** Please note that in normal operation mode, the 'cable select' position is recommended for all IDE devices.

### Preparing a CD-ROM or DVD-ROM Drive

Before installing a CD/DVD-ROM drive in the system, the jumper on the back of the drive must be set as "cable select". Refer to the 'IDE Device Configuration' hereafter for details about configuring IDE drives as master or slave. Refer to the instructions printed on the device for further jumper setting information.

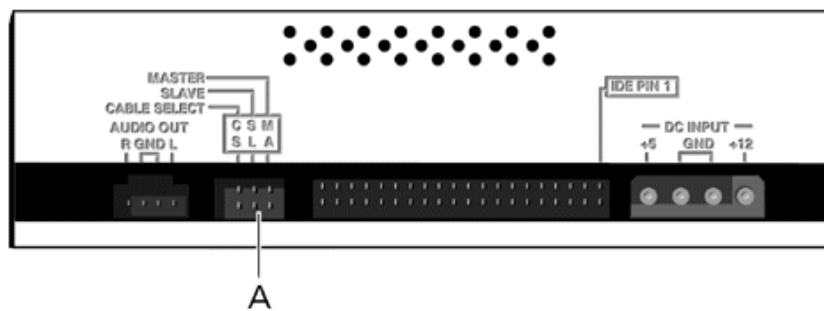

■ A - Jumper block

Figure 4 - 32 : Connectors on the back of a CD/DVD-ROM or CD-RW drive (example)

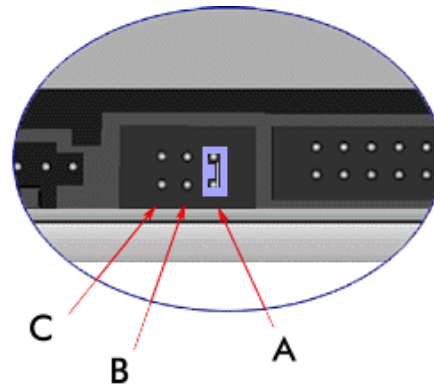

■ A - Master

■ B - Slave

■ C - Cable select

Figure 4 - 33 : Jumper settings (example)

## Preparing an IDE Hard Disk Drive

Before installing a hard disk drive in the system, it should be set as a master or a slave device using the drive select jumper on the back of the drive. Refer to the 'IDE Device Configuration' hereafter for details about configuring IDE drives as master or slave. Refer to the instructions printed on the device for further jumper setting information.

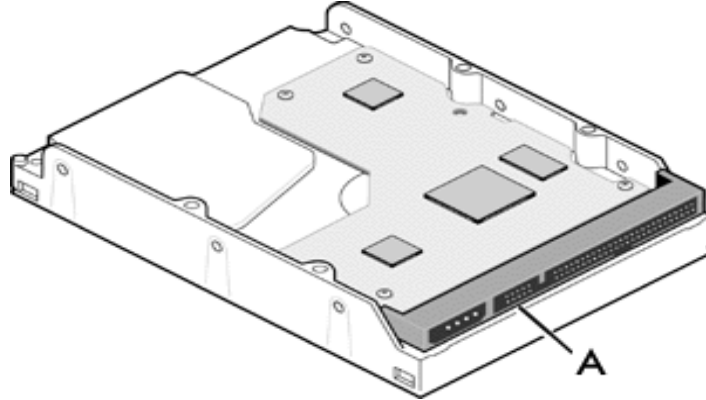

■ A - Jumper block

**Figure 4 - 34 : Connectors on the back of a hard disk drive (example)**

## Preparing a S-ATA Hard Disk Drive

S-ATA hard disk drives do not need being prepared.

## Preparing a Tape Drive

Before installing a tape drive in the system, it should be set as a master or a slave device using the drive select jumper at the back of the drive. Refer to the 'IDE Device Configuration' hereafter for details about configuring IDE drives as master or slave. Refer to the instructions printed on the device for further jumper setting information.

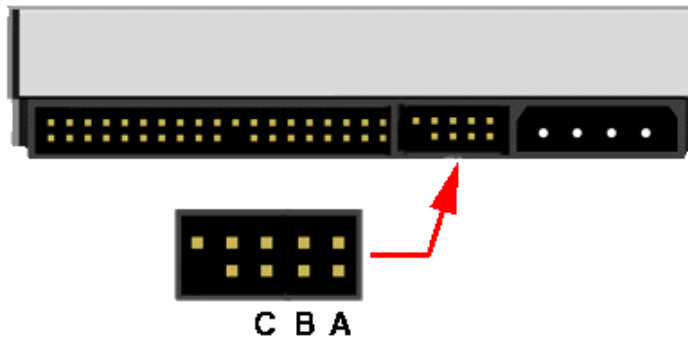

- Master Setting
- Slave Setting
- Cable Select

**Figure 4 - 35 : Connectors on the Back of a Tape Drive (example)**

## IDE Device Configuration

Follow the instructions hereafter when configuring IDE drives as master or slave on the primary and secondary IDE connectors on the motherboard (recommended configurations).

**Table 4 - 2: IDE Device Configuration**

Device	Position	Connector
2 hard disk drives	Master / Slave	Primary IDE
1 hard disk drive	Master	
You may install a maximum of two hard disk drives in your system.		
1 CD-ROM or 1 DVD-ROM or 1 Combo	Master CD-ROM	Secondary IDE
1 DVD-ROM or 1 Combo or 1 CD-ROM +	Master CD-ROM	
1 tape	Slave CD-ROM	
1 DVD-ROM or 1 Combo 1 CD-ROM +	Slave CD-ROM	
1 DVD-ROM or 1 Combo 1 CD-ROM +	Master CD-ROM	Secondary IDE
1 DVD-ROM or 1 Combo	Slave CD-ROM	
1 CD-ROM		



# 5

## Problem Solving

- Problem Solving
- Static Precautions
- Resetting the Server
- Troubleshooting Guide
- Problems at initial System Start-up
- Problems After the System Has Been Running Correctly
- Problems Running New Application Software
- Problems and Suggestions
- If You Need Assistance
- Error Messages: Beep Codes
- How to Identify BIOS Revision Level

## Problem Solving

This chapter helps you identify and solve problems that may occur during system installation or while using your system. The first section of this chapter tells you how to reset your system in the event of problems. The next few sections provide troubleshooting checklists and procedural steps that help you isolate specific system problems. The last section includes BIOS and system user information.

---

### **WARNING**

The DC push-button on/off switch on the front panel does not turn off the system AC power. Also, +5vdc is present on the system board whenever the AC power cord is connected between the system and an AC outlet. Before doing the procedures in this manual, make sure that your system is powered off and unplug the AC power cords from the back of the chassis. Failure to disconnect power before opening your system can result in personal injury and equipment damage

---

---

### **CAUTION**

Operating your system with the cover removed can damage your system components. For proper cooling and airflow, always replace the right side panel before powering on your system.

---

## Static Precautions

An electrostatic discharge (ESD) can damage disk drives, option boards, and other components. You can provide some ESD protection by wearing an antistatic wrist strap attached to chassis ground when handling system components.

Electronic devices can be easily damaged by static electricity. To prevent damage, keep them in their protective packaging when they are not installed in your system.

## Resetting the Server

There are two ways to reset the server.



### CAUTION

Resetting the server clears the DIMM memory and the data in process. To reset the server when it is not frozen, make sure that no processing is in progress.

---

#### ■ Hard reset

Press the power switch at the front of the server. (see See “Forcing a Power Shutdown” on page 2-9.)

#### ■ Soft reset

If the server halts before starting the OS, press and hold **Ctrl** and **Alt** and press **Delete**. This restarts the server.

## Troubleshooting Guide

This section provides a guide to help you identify a problem and locate its source.

---

### Warning

The system power and any peripheral devices should be turned off before connecting or disconnecting peripheral devices to or from the system.

Otherwise, you could permanently damage the system or peripheral devices.

---

1. Turn off the system and any peripheral devices. Disconnect all external peripherals from the system, except for the keyboard and monitor. The system's power cord must be plugged into a grounded electrical outlet.
2. Make sure your keyboard and monitor are properly connected to the system. Turn the monitor on, then adjust its brightness and contrast controls to suit your preference (see your monitor's documentation).
3. Turn the system on. If the power indicator does not light up, but the system seems to be operating normally, the indicator may need replacement.
4. Monitor the power-on self test (POST) execution. Each time you turn on the system, the POST checks the system board, memory, keyboard, and certain peripheral devices.
5. Check the following during the POST:
  - (Error Message Line 1)
  - (Error Message Line 2)
  - Press <F2> to resume,
  - <F1> to enter Setup
  - You should note the error and press **F2** to resume the boot-up process, or **F1** to enter Setup.
6. Errors that prevent the boot process from continuing (fatal errors) are communicated by a series of audible beeps. If this type of error occurs, record the information and refer to the Error Messages: Beep Codes section.



## ***Problems at initial System Start-up***

Problems that occur at initial system start-up are often caused by incorrect installation of components or incorrect configuration. Hardware failure is a less frequent cause.

- Are all cables properly connected and secure?
- Is AC power available at the wall outlet?
- Are the configuration settings correct in Setup? Are all drivers properly installed?
- Are all the expansion cards fully seated in their slots on the motherboard?
- Are all DIMMs installed correctly?
- Is the processor fully seated in its slot on the motherboard?
- Are switches and jumpers on the system board correct (if they have been changed from their original default settings)?
- Are all jumper and switch settings on optional add-on cards and peripheral devices set correctly? Check the documentation included with these devices for details. Ensure that there are no system resource conflicts between hardware components. (For example, two add-on cards could inadvertently share the same interrupt, resulting in a conflict.)
- Are adapter cards and disk drives correctly installed?
- Is the keyboard properly connected to the system and is it connected in the right PS/2 port?
- Is a bootable diskette installed in your system's floppy drive A: ?
- Is the hard disk properly formatted or defined?
- Is the operating system properly loaded? Check the operating system documentation.

## ***Problems After the System Has Been Running Correctly***

After the system hardware and software have been running correctly, problems can indicate equipment failure. Use the checklist below to try and correct the situation.

If the problem recurs after you have checked these items, refer to the Troubleshooting Guide section earlier in this chapter.

- If you are running software from a diskette or CD, try using a new copy.
- If you are running software from a hard disk drive, make sure that all of the necessary files are installed. There may be a problem with the copy on the hard disk. Reinstall the software on the hard disk and try again.
- If problems appear intermittently, there may be a loose cable, dirt in the keyboard (if keyboard input is incorrect), or other random component failures.
- A transient voltage spike, power cut, or brownout may have occurred. Symptoms of voltage spikes include a flickering video display, unexpected system reboots, and the system not responding to user commands. If necessary, exit any open applications and shut down your system power. Reboot the system, then load the software and try again.
- Voltage spikes can occasionally cause the heads of the disk drive to contact the disk. This can corrupt or destroy data files. If you are experiencing voltage spikes on the AC electrical power line, install an uninterruptible power supply between the power outlet and the system's power cord.

## ***Problems Running New Application Software***

Problems occurring when you run new application software are usually related to the software. Faulty equipment is much less likely, especially if other software runs correctly. Use the checklist below to see if the situation may be easily corrected. If the problem persists after you have checked these items, contact the software vendor's customer service.

- Does the system meet the minimum hardware requirements for the software? Refer to the software documentation.
- Is the software an authorised copy? Unauthorised copies often do not work. Obtain an authorised copy of the software.
- If you are running the software from a CD or diskette, is it a good copy?
- If you are running the software from a CD, is the disc scratched or dirty?
- Is the software correctly installed? Were all necessary procedures followed and files installed?
- Are the correct device drivers installed?
- Is the software correctly configured for the system?
- Are you using the software correctly?

## Problems and Suggestions

Contact your Authorised Service Representative if the suggested actions do not solve the problem.

**Table 5 - 1: Problems and Suggestions**

What to do	What to do
Application software problems	<p>Make sure all cables are installed correctly.</p> <p>Verify that your system hardware configuration is set correctly. In Setup, check the values against the system settings that you previously recorded. If an error is evident (wrong type of drive specified, for example), make the change in Setup and reboot the system. Record your change.</p> <p>Make sure the software is properly configured for the system. Refer to the software documentation for information. Try a different copy of the software to see if the problem is with the copy you are using.</p> <p>If other software runs correctly on the system, contact the vendor of the failing software.</p>
Characters on screen are distorted or incorrect	<p>Make sure the brightness and contrast controls are properly adjusted. Make sure the monitor's video signal cable and power cables are properly installed. (Shut down system power before reconnecting cables.) Make sure your monitor is compatible with the video mode you have selected. (Check your monitor's documentation.)</p>
Characters do not appear on screen	<p>Make sure the monitor is plugged in and turned on. Are the brightness and contrast controls properly adjusted? Make sure that the video signal cable is properly connected. (Turn the system power off before reconnecting cables). Make sure your system's video adapter card is installed, enabled. Reboot the system.</p>
CMOS RAM settings are wrong	<p>If system settings stored in CMOS RAM change for no apparent reason (for example, the time of day develops an error), the backup battery may no longer have enough power to maintain the settings. Replace the battery.</p>
Diskette drive light does not go on when drive is in use or is tested by POST.	<p>Make sure the power and signal cables for the drive are properly installed. Check that the drive is properly configured and enabled in Setup.</p>
Hard drive light does not go on when drive is in use or is tested by POST.	<p>Make sure the power and signal cables for the drive are properly installed. Make sure the front panel connector is securely attached to the system board headers. Check that the drive is properly configured and enabled in Setup. Check the drive manufacturer's manual for proper configuration for remote hard disk drive activity.</p>
Power on light does not go on	<p>If the system is operating normally, check the connector between the system board and the front panel. If OK, the light may be defective.</p>

## ***If You Need Assistance***

If you have a problem with your computer, first review the sections of Problem Solving.

---

 **Note:** Refer to the warranty booklet delivered with your system to find out how to contact the local office in your country.

---

For technical support such as BIOS upgrades, consult our Web site at the following address: **<http://www.nec-online.com>**.

## Error Messages: Beep Codes

If an error occurs during the POST, the server beeps, indicating the type of error. Each number indicates the number of short beeps.

**Table 5 - 2: POST Error Beep Codes**

Beeps	Error	Recommended Action
2	Parity error	Check if the DIMM cards are mounted correctly. If the error still occurs when the check result is normal, contact your service representative.
3	Main memory read/write test error	
4	Motherboard timer not operational	Contact your service representative.
6	Keyboard controller BAT test error	Check if the keyboard is connected correctly. Check that there is no stuck key. Contact your service representative.
7	General exception error	Contact your service representative.
8	Display memory error	Contact your service representative.
10	CMOS Shutdown register read/write error	Contact your service representative.

## ***How to Identify BIOS Revision Level***

To identify your system's current BIOS revision level, perform either one or the other of the following procedures:

1. Power-on or reboot the system.
2. When logo displays, press the **TAB** key.
3. The BIOS revision level is displayed. Press **Pause** to have time to read the BIOS version.

or

1. Power-on or reboot the system. "Press <DEL> to enter SETUP" displays.
2. Press **DEL**.
3. In the **Main** menu, select **System Information** and press **ENTER**. The BIOS revision level is displayed.

## Updating BIOS

The EZ Flash feature allows you to easily update the BIOS. The EZ Flash feature is built in the BIOS firmware so it is accessible by simply pressing **Alt + F2** during the Power-On Self Tests (POST).

To update the BIOS with EZ Flash, proceed as follows:

1. Consult our Web site at the following address: <http://www.nec-online.com> to download the latest BIOS file for your motherboard and rename it to **P4C800EI.ROM**. Save the BIOS file on a floppy disk.
2. Reboot the system.
3. To launch EZ Flash, press **Alt + F2** during POST to display the following:

```
User recovery requested. Starting BIOS recovery...
Checking for floppy...
```

---

 **Note:** If there is no floppy disk found in the drive, the message '**Floppy not found!**' displays. If the correct BIOS file is not found in the floppy disk, the error message '**P4C800EI.ROM not found!**' displays.

---

4. Insert the floppy disk that contains the BIOS file. If the P4C800EI.ROM file is found in the floppy disk, EZ Flash performs the BIOS update process and automatically reboots the system when done.

---

### Caution

Do not shutdown or reset the system while updating the BIOS!  
Doing so may cause system boot failure!

---

```
User recovery requested. Starting BIOS recovery...
Checking for floppy...
Floppy found!
Reading file "P4C800EI.rom". Completed.
Start flashing...
Flashed successfully. Rebooting.
```



## Recovering BIOS

The CrashFree BIOS 2 auto recovery tool allows you to restore BIOS from a floppy disk that contains the BIOS file, in case the current BIOS on the motherboard fails or gets corrupted.

To recover the BIOS, proceed as follows:

1. Prepare a floppy disk that contains the motherboard BIOS (P4C800EI.ROM). See "Updating BIOS" on page 12.
2. Boot the system.
3. When a corrupted BIOS is detected, the following message displays:

```
Bad BIOS checksum. Starting BIOS recovery...
Checking for floppy...
```

4. Insert a floppy disk that contains the original, or the latest, BIOS file for this motherboard (P4C800EI.ROM). The BIOS update process continues when the P4C800EI.ROM file is found.

```
Bad BIOS checksum. Starting BIOS recovery...
Checking for floppy...
Floppy found!
Reading file "P4C800EI.rom". Completed.
Start flashing...
```

---

### **Caution**

Do not shutdown or reset the system while updating the BIOS!  
Doing so may cause system boot failure!

---

5. When the BIOS update process is complete, reboot the system.



# Appendix A

## Specifications

**Table A - 1: TM700 Specifications**

Express 5800 TM700					
Cabinet design		ATX form factor 30.5cm x 24.5cm - convertible to tower or desktop			
Chipset	Intel® 875P	400-/533-/800MHz system bus			
		Intel® Hyper-Threading technology			
		Intel® Performance celeration technology			
		Intel® Hub architecture			
		Dual-Channel DDR 266/333/400 SDRAM memory with ECC support			
		AGP 8x interface			
		Integrated Hi-Speed USB 2.0			
		Dual Independant Serial ATA Controllers			
		Integrated Intel® RAID technology			
		Ultra ATA/100			
		AC '97 controller			
		Intel® Communication Streaming architecture			
		Low-Power Sleep mode			
CPU	Type	Intel® Celeron®	Intel® Pentium® 4 Northwood	Intel® Pentium® 4 Prescott	
	L2 Che	128KB on Die (ECC)	512 KB on Die (ECC)	1 MB on Die (ECC)	
	FSB	400 MHz	533 MHz 800 MHz	533 MHz	800 MHz
	Number of processors	1 (max: 1)			
	Pkaging	Socket mPGA 478			
Memory	Minimum	256 MB			
	Maximum	4 GB			
	Architecture	Dual Channel support. Dual or single channel configuration is defined at boot time depending on number and type of DIMMs installed. See "Standard Features" on page 10.			
	Connectors	4 memory connectors 168-pin wide			
	Memory module	DDR400			
	Error check	Un-buffered ECC PC3200			
Floppy Disk Drive (standard)		3.5-inch drive × 1			
External ccessible bays	5.25-inch bay	2 slots			
	3.5-inch bay	2 slots			
Hard Disk Drive bays		2 slots			

**Table A - 1: TM700 Specifications (Continued)**

<b>Express 5800 TM700</b>		
Internal slots	PCI (32-bit/33MHz)	5 slots (1 slot may already be used for PCI video board)
	USB 2.0	4 slots
	IDE connector	2 slots
	S-ATA connector	2 slots
	Aux in	1 slot
	Floppy connector	1 slot
	Panel connector	1 slot
	AGP Pro connector	1 slot
LAN	On board LAN	LAN 10/100/1000 Ethernet
		Intel® CSA 82547EI Gigabit Ethernet controller
Audio	On board	AC '97 controller
External interface	Keyboard	PS/2 (1 port)
	Mouse	PS/2 (1 port)
	USB	2.0 (6 ports)
	Serial	FIFO compatible (1 port)
	Network	RJ-45 (1 port)
	Parallel	SPP (Standard Parallel Port)/ EPP (Enhanced Parallel Port) / ECP (Extended Capabilities Port) support (1 port)
	Audio	3 ports (microphone in, stereo line in, stereo line out)
Backup storage		SONY AIT 1 IDE backup Tape Unit support
BIOS	AMI BIOS	ISA Flash ROM 4 MB
		Power On Self Test (POST)
	Supports:	Plug n Play
		Advanced Configuration and Power Interface (PI) 1.0
		Advanced Power Management (APM) 1.2
		S3 mode
		Y2K
		PC2001
		Desktop Management Interface
External dimensions		460 (width) × 450 (height) × 175 (depth) mm
Weight		11 kg (Max.)
Power supply		200 to 240 V 10%, 50/60 Hz ±1 Hz
Power consumption (maximum)		280W
Environmental requirements	Temperature	10 to 35°C
	Humidity	20 to 80% RH (no condensation)

# Appendix B

## Interrupt Requests

The factory-set interrupt requests (IRQs) are listed below. Find an appropriate one to install an optional device.

**Table B - 1: Interrupt Requests**

	A	B	C	D	E	F	G	H
PCI slot 1	–	–	–	–	–	shared	–	–
PCI slot 2	–	–	–	–	–	–	shared	–
PCI slot 3	–	–	–	–	–	–	–	shared
PCI slot 4	–	–	–	–	used	–	–	–
PCI slot 5	–	–	–	–	–	shared	–	–
AGP Pro slot	shared	used	–	–	–	–	–	–
Onboard USB controller HC0	shared	–	–	–	–	–	–	–
Onboard USB controller HC1	–	–	–	used	–	–	–	–
Onboard USB controller HC2	–	–	used	–	–	–	–	–
Onboard USB controller HC3	shared	–	–	–	–	–	–	–
Onboard USB 2.0 controller	–	–	–	–	–	–	–	shared
Onboard LAN	–	–	–	–	–	–	shared	–
Onboard S-ATA	–	–	–	–	–	–	–	shared

---

### Caution

When using PCI cards on shared slots, ensure that the drivers support “Share IRQ” or that the cards do not need IRQ assignments.

Otherwise, conflicts will arise between the two PCI groups, making the system unstable and the card inoperable.

---



# Appendix C

## **Product Configuration Record Table**

Use these tables to record pertinent information about your system. You will need some of this information to run the System Setup Utility. Be sure to update these tables when you add options.

Record the model and serial numbers of the system components, dates of component removal or replacement, and the name of the vendor from whom the component was purchased. Be sure to record the same information for any components added to the system, such as a power supply, hard disk drives, add-in boards, or printers.

Record the model and serial numbers of the unit and system board. The model and serial numbers of the system unit are recorded on a label attached to the rear of the unit.

The location of serial numbers on add-in boards, hard disk drives, and external equipment, such as video displays or printers, varies from one manufacturer to another. Literature accompanying these products should illustrate or describe the location of model and serial numbers.

**Table C - 2: Hardware Product Configuration Record Table**

Main Unit						
	Model name		Serial No.		Date Installed	
CPU						
	Clock		Serial No.		Date Installed	
Memory						
#A1	Size		Serial No.		Date Installed	
#A2	Size		Serial No.		Date Installed	
#B1	Size		Serial No.		Date Installed	
#B2	Size		Serial No.		Date Installed	
Monitor						
	Type		Model name		Serial No.	
					Date Installed	
Hard disk drive						
	Type			Serial No.		
	Capacity					
	Type number					
	Type			Serial No.		
	Capacity					
	Type number					
5.25-inch External Accessible Bay						
	Type		Model name		Serial No.	
					Date Installed	
	Type		Model name		Serial No.	
					Date Installed	
3.5-inch External Accessible Bay						
Floppy Disk Drive	Type		Model name		Serial No.	
					Date Installed	
	Type		Model name		Serial No.	
					Date Installed	
PCI Slot #1						
	Model name				Serial No.	
					Date installed	
PCI Slot #2						
	Model name				Serial No.	
					Date installed	
PCI Slot #3						
	Model name				Serial No.	
					Date installed	
PCI Slot #4						
	Model name				Serial No.	
					Date installed	
PCI Slot #5						



**Table C - 2: Hardware Product Configuration Record Table (Continued)**

	Model name				Serial No.	
					Date installed	
<b>Printer</b>						
	Model name				Serial No.	
	Manufacturer				Date installed	
<b>External Peripheral Device 1</b>						
	Model name				Serial No.	
	Manufacturer				Date installed	
<b>External Peripheral Device 2</b>						
	Model name				Serial No.	
	Manufacturer				Date installed	
<b>External Peripheral Device 3</b>						
	Model name				Serial No.	
	Manufacturer				Date installed	
<b>External Peripheral Device 4</b>						
	Model name				Serial No.	
	Manufacturer				Date installed	

**Table C - 3: Software Product Configuration Record Table**

Firmware version	
OS	Name:                      Version: Name:                      Version:
File system	FAT                              FAT32 NTFS                            Others
Bundled software installed	
Licensed software installed	
Application running when a failure occurred	



# Glossary

## A

### AC

(Alternating Current) The type of current available in wall outlets. All computers must convert alternating current to direct current to operate. See also DC.

### address

A label, name, or number that identifies a location in computer memory.

## B

### backup

A copy of data for safe-keeping. The data is copied from computer memory or disk to a floppy disk, magnetic tape, or other media.

### base memory

An area of memory between 0 and 640 kilobytes.

### baud rate

The speed with which data is transmitted during serial communication. The computer's operating system and software program must be configured for the same baud rate as the communication device, such as a serial printer. See also bps.

### BIOS

(Basic Input/Output System) A program stored in flash EPROM or ROM that controls the keyboard, disk drives, video monitor, and other devices. See also flash EPROM, EPROM, and ROM.

### bit

Derived from BInary digiT, a bit is the smallest unit of information a computer handles. See also byte.

### boot

The process of loading the operating system into memory.

### byte

A group of eight bits.

## C

### cache memory

A very fast, limited portion of RAM set aside for temporary storage of data for direct access by the microprocessor.

### CD-ROM drive

(Compact Disk ROM drive) A type of mass storage device that reads information from a compact disk.

**CMOS**

(Complimentary Metal-Oxide Semiconductor) A type of low-power integrated circuit used in computers. See also TTL.

**COM1 or COM2**

The name you can assign a serial port to set or change its address. See also serial port.

**command**

An instruction that directs the computer to perform a particular operation.

**configuration**

The way in which a computer is set up to operate. Some configurable options include CPU speed, serial port designation, and memory allocation.

**CPU**

(Central Processing Unit) See microprocessor.

**D**

**DC**

(Direct Current) The type of current available in the rechargeable battery packs used in portable computers. See also AC.

**default**

The factory setting your computer uses unless you instruct it otherwise. For example, when powering up, the computer will boot from the default drive.

**device driver**

A software program that a computer must use to recognize and operate certain hardware, such as a mouse or a video monitor.

**disk drive**

A device that stores data on a hard or floppy disk. A floppy disk drive requires a floppy disk to be inserted; a hard disk drive has a permanently encased hard disk.

**DOS**

(Disk Operating System) See operating system.

**E**

**ECC**

(Error Checking and Correction) A method of detecting and correcting errors.

**expansion slot**

A connector on the backplane board in desktop computers and expansion boxes that allows you to install circuit cards.

**extended memory**

The protected memory above 1M that is directly accessible by the microprocessor through certain utilities and operating systems.

## F

### **floppy disk drive**

See disk drive.

### **format**

The process used to organize a hard or floppy disk into sectors so it can accept data. Formatting destroys all previous data on the disk.

### **FRB (Fault Resilient Boot)**

A server management feature. FRB attempts to boot the system using the alternate processor or DIMM.

## H

### **hard disk drive**

See disk drive.

### **hardware**

The physical parts of your computer, including the keyboard, monitor, disk drives, cables, and circuit cards.

### **hot swap**

A method used to insert or remove SCSI disk drives into or from an operating bus. This method is typically used in RAID subsystems. When used in non-RAID subsystems the operating system must typically be restarted.

## I

### **IC**

(Integrated Circuit) An electronic device that contains miniaturized circuitry.

### **IDE**

(Integrated Drive Electronics) A type of hard disk drive with the control circuitry located inside the disk drive rather than on a drive controller card.

### **interface**

A connection between the computer and a peripheral device that enables them to exchange data. See also parallel port and serial port.

### **ISA**

(Industry Standard Architecture) An industry standard for computers and circuit cards that transfer 16 bits of data at a time.

## J

### **jumper**

A small electrical connector used for configuration on some computer hardware.

## **L**

### **LAN**

(Local Area Network) A group of computers linked together within a limited area to exchange information.

### **LED**

(Light-Emitting Diode) A small electronic device that glows when current flows through it.

### **LPT1 or LPT2**

The name you can assign a parallel port to specify its address. See also parallel port.

### **LVD**

Super-fast Ultra 2 SCSI Low Voltage Differential (LVD) Parallel SCSI Interface. A new SCSI interface that provides greater I/O bandwidth, device connectivity, data reliability, and longer cable lengths for Ultra2 SCSI hard disk drives. Note that in order to achieve LVD performance all devices including cable, controller, and drive must support LVD.

## **M**

### **memory**

The circuitry in your computer that stores data and programs. See also EMS, extended memory, RAM, and ROM.

### **microprocessor**

The integrated circuit that processes data and controls the basic functions of the computer.

### **modem**

A device used to exchange information with other computers over telephone or data lines.

### **module**

A circuit board that plugs into a dedicated connector on the system board in your computer.

### **mouse**

A small input device that you guide on a flat surface to control the cursor movement and operation of the computer when using certain software programs.

## **N**

### **NVRAM**

(Nonvolatile RAM) A type of RAM that retains its contents even after the computer is powered off. This memory stores EISA configuration information. See also RAM and SRAM.

## O

### **operating system**

A set of programs that provides the interface between other software programs and the computer.

## P

### **parallel port**

The connector on the back of your computer that allows the transfer of data between the computer and a parallel device, such as a parallel printer.

### **partition**

The process of dividing the storage space on a hard disk into separate areas so that the operating system treats them as separate disk drives.

### **password**

A security feature that prevents an unauthorized user from operating your computer. See also EEPROM.

### **PCI**

Peripheral Component Interconnect. PCI is a high-performance peripherals I/O bus supporting data transfers of up to 528MB per second.

### **Pentium**

A type of microprocessor, with a built-in math coprocessor, cache memory, and memory and bus controllers, that processes and communicates 32 bits of data at a time. This microprocessor also contains power management capabilities.

### **peripheral**

A device connected to and controlled by the computer, such as an external disk drive or a printer.

### **POST**

Power-On-Self-Test.

## R

### **real-time clock**

The IC in your computer that maintains the time and date.

### **ROM**

(Read-Only Memory) A type of memory device that usually is used to store system BIOS code. This code cannot be altered and is not lost when the computer is powered off. See also BIOS, EPROM, and flash EPROM.

## S

### **S-ATA**

Serial Advanced Technology Attachment: standard for connecting hard drives into computer systems. An evolution of the Parallel ATA physical storage interface, SATA is based on serial signalling technology, a single cable with a minimum of four wires creating a point-to-point connection between devices.

### **save**

To store information on a floppy disk, hard disk, magnetic tape, or some other permanent storage device.

### **SEL**

(System Event Log) A record of system management events. The information stored includes the name of the event, the date and time the event occurred and data pertinent to the event. Event data may include POST error codes that reflect hardware errors or software conflicts within the system.

### **serial port**

The connector on the back of your computer that allows the transfer of data between the computer and a serial device, such as a mouse, a modem, or a serial printer.

### **software**

Programs with specific functions, such as word processing, data base management, communications, and operating system.

### **system board**

The main circuit board in your computer. It contains most of the connectors and ports.

## T

### **tape drive**

A type of storage device using magnetic tape.

## V

### **VGA**

(Video Graphics Array) A type of video display system that provides high-resolution text and graphics on analog color monitors.



# INDEX

## Numerics

3.5/5.25-inch Bracket .....	4-9
3.5-inch bay .....	1-4
5.25-inch	
Bay .....	1-4
Device .....	4-12

## A

AC Power Connector .....	1-5
ACPI .....	1-11
Adapter Card .....	4-29
Advanced Menu .....	3-8
Air Duct .....	1-7
Anti-theft Device .....	1-5

## B

Battery .....	4-31
Bays	
3.5-inch .....	1-4
5.25 inch .....	1-4
Beep Codes .....	5-10
BIOS Revision Level .....	5-11
BIOS Setup Utility .....	3-3
Boot Menu .....	3-12

## C

Cable	
IDE .....	4-32
S-ATA .....	4-32
System Power .....	4-33
CD-ROM Drive .....	1-12
Combination Drive .....	1-13
Configuring	
MotherBoard Jumpers .....	3-15

## D

DC-12V power connector .....	1-5
Desktop .....	4-4
DVD-ROM Drive .....	1-12

## E

Exit Menu .....	3-14
Expansion Board Slots .....	1-6
EXPRESSBUILDER CD-ROM .....	1-18

## F

Features .....	1-3
Optional Features .....	1-12
Standard Features .....	1-10
Floppy Disk Drive .....	4-14
Front Panel .....	4-8
Front View .....	1-4

## H

Hard Disk Drive .....	4-18
E-IDE HDD .....	1-14
HDD Slots .....	1-7
S-ATA HDD .....	1-15

## I

IDE Device Lamp .....	1-4
Interrupt Requests .....	B-1

## K

Kensington lock .....	1-5
Keyboard .....	1-11

## L

Lamp	
IDE Device .....	1-4
Status .....	1-4
LAN Board .....	1-14

## M

Main Menu .....	3-5
Memory .....	1-10
RAM .....	4-26
Motherboard .....	1-7, 1-8
MotherBoard Jumpers	
Configuring .....	3-15
Mouse .....	1-11

## N

Network Controller .....	1-10
--------------------------	------

## P

PCI Slots .....	1-10
Ports	
USB .....	1-4
Power	

Button .....	1-4
Connecting Power Cord .....	2-6
Forced Power Off .....	2-9
Off .....	2-9
On .....	2-8
Power Menu .....	3-11
Power Supply .....	1-7
Problem Solving .....	5-5, 5-6, 5-7, 5-8
Processor .....	1-10, 4-23

## R

Rear View .....	1-5
Record Table .....	C-1
Resetting .....	5-3
Server .....	5-3
Right Side Door .....	4-6

## S

Server	
Resetting .....	5-3
Specifications .....	A-1
Status Lamp .....	1-4
System	
Configuring .....	3-2
forcing a power shutdown .....	2-9
Powering Off .....	2-9
Powering On .....	2-8
System Connectors .....	1-6

## T

Tape Backup Unit .....	1-16
Tower .....	4-5
Troubleshooting .....	5-4

## U

USB ports .....	1-4
-----------------	-----

## V

Video Board .....	1-15
-------------------	------



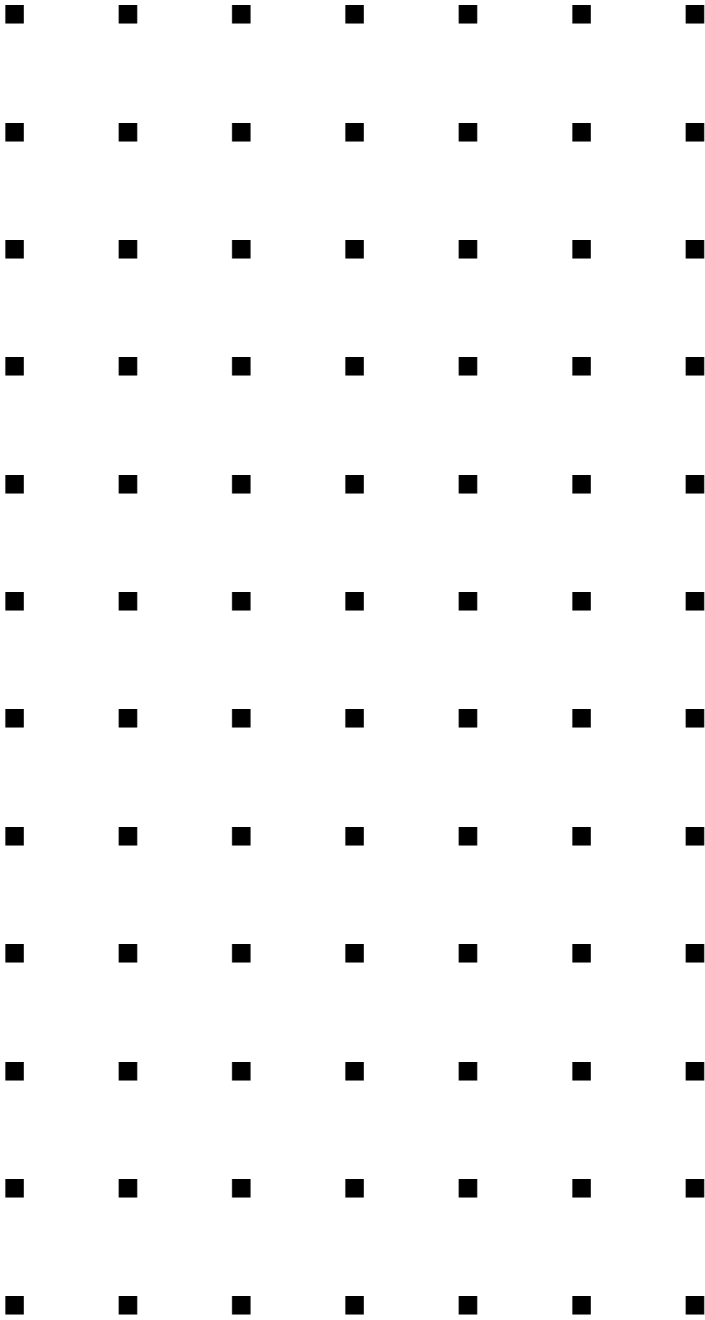

## Free Manuals Download Website

<http://myh66.com>

<http://usermanuals.us>

<http://www.somanuals.com>

<http://www.4manuals.cc>

<http://www.manual-lib.com>

<http://www.404manual.com>

<http://www.luxmanual.com>

<http://aubethermostatmanual.com>

Golf course search by state

<http://golfingnear.com>

Email search by domain

<http://emailbydomain.com>

Auto manuals search

<http://auto.somanuals.com>

TV manuals search

<http://tv.somanuals.com>