

# Intel<sup>®</sup> 82575EB Gigabit Ethernet Controller Software Developer's Manual and EEPROM Guide

---

LAN Access Division

324632-003  
Revision: 2.1  
January 2011



## Legal

---

INFORMATION IN THIS DOCUMENT IS PROVIDED IN CONNECTION WITH INTEL® PRODUCTS. NO LICENSE, EXPRESS OR IMPLIED, BY ESTOPPEL OR OTHERWISE, TO ANY INTELLECTUAL PROPERTY RIGHTS IS GRANTED BY THIS DOCUMENT. EXCEPT AS PROVIDED IN INTEL'S TERMS AND CONDITIONS OF SALE FOR SUCH PRODUCTS, INTEL ASSUMES NO LIABILITY WHATSOEVER, AND INTEL DISCLAIMS ANY EXPRESS OR IMPLIED WARRANTY, RELATING TO SALE AND/OR USE OF INTEL PRODUCTS INCLUDING LIABILITY OR WARRANTIES RELATING TO FITNESS FOR A PARTICULAR PURPOSE, MERCHANTABILITY, OR INFRINGEMENT OF ANY PATENT, COPYRIGHT OR OTHER INTELLECTUAL PROPERTY RIGHT. Intel products are not intended for use in medical, life saving, life sustaining, critical control or safety systems, or in nuclear facility applications.

Intel may make changes to specifications and product descriptions at any time, without notice.

Intel Corporation may have patents or pending patent applications, trademarks, copyrights, or other intellectual property rights that relate to the presented subject matter. The furnishing of documents and other materials and information does not provide any license, express or implied, by estoppel or otherwise, to any such patents, trademarks, copyrights, or other intellectual property rights.

Designers must not rely on the absence or characteristics of any features or instructions marked "reserved" or "undefined." Intel reserves these for future definition and shall have no responsibility whatsoever for conflicts or incompatibilities arising from future changes to them.

Intel processor numbers are not a measure of performance. Processor numbers differentiate features within each processor family, not across different processor families. See [http://www.intel.com/products/processor\\_number](http://www.intel.com/products/processor_number) for details.

Hyper-Threading Technology requires a computer system with an Intel® Pentium® 4 processor supporting HT Technology and a HT Technology enabled chipset, BIOS and operating system. Performance will vary depending on the specific hardware and software you use. See [http://www.intel.com/products/ht/Hyperthreading\\_more.htm](http://www.intel.com/products/ht/Hyperthreading_more.htm) for additional information.

Contact your local Intel sales office or your distributor to obtain the latest specifications and before placing your product order.

Copies of documents which have an order number and are referenced in this document, or other Intel literature may be obtained by calling 1-800-548-4725 or by visiting Intel's website at <http://www.intel.com>.

Intel and Intel logo are trademarks or registered trademarks of Intel Corporation or its subsidiaries in the United States and other countries.

\*Other names and brands may be claimed as the property of others.

Copyright © 2006,2007,2008,2010,2011; Intel Corporation. All Rights Reserved.



## Revisions

Revision	Date	Description
.25	2/2006	Initial release (Intel Secret).
1.1	1/2008	<ul style="list-style-type: none"> <li>Updated Section 13.4.8.15 (bit 15 description).</li> <li>Updated Table 61 (bit 13 bit description).</li> </ul>
.5	6/2006	Major revisions all sections.
1.0	6/2007	Final release (Intel Confidential).
1.2	6/2008	<ul style="list-style-type: none"> <li>Updated Section 5.6.1.5 (changed default device ID to 10A7h).</li> <li>Updated Section 5.6.1.1 (removed note concerning MAC addresses).</li> <li>Removed table note from Sections 13.7.4 through 13.7.6.</li> <li>Updated Sections 13.4.65 and 14.7 concerning COLD field values.</li> <li>Updated Section 13.4.8.15 (revised bit 15 description).</li> <li>Updated Section 13.4.8.19 (removed statement that D0LPLU can be loaded from the EEPROM).</li> <li>Updated Section 5.6.9 (added new PHY values).</li> </ul>
.75	6/2006	Initial release (Intel Confidential).
1.3	9/2008	<ul style="list-style-type: none"> <li>Updated Section 13.4.2 (updated SPEED field description; bits 7:6).</li> <li>Replaced device ID table with note to refer to the spec update for supported device IDs.</li> </ul>
2.0	12/14/2010	<ul style="list-style-type: none"> <li>Section 4.1, EEPROM Device - EEPROM size data updated.</li> <li>Section 4.5.1.29, PXE Words (Words 30h:3Eh) - Section updated. Specific field information exposed.</li> <li>Section 4.6.4, NC-SI Configuration Structure - Hardware default values added.</li> <li>Section 4.7.2, PBA Number (Words 08h, 09h) - Section updated to address new methodology.</li> <li>Section 5.4.1.3, Association through VLAN tag ID - Added.</li> <li>Section 5.4.1.4, Association through VLAN tag ID +RSS - Added.</li> <li>Section 10.2.1, Adding 802.1q Tags on Transmits - Section updated.</li> <li>Section 14.3.34, Interrupt Cause Read Register - ICR (000C0H; R) - Note located in OUTSYNC description updated.</li> <li>ASF references removed.</li> </ul>
2.1	1/28/2011	<ul style="list-style-type: none"> <li>Updated brand strings. Updated title.</li> </ul>



## Content

---

<b>1.0</b>	<b>Introduction</b>	19
1.1	Register and Bit References	19
1.2	Byte and Bit Designations	19
1.3	References	19
1.4	Memory Alignment Terminology	20
<b>2.0</b>	<b>Architectural Overview</b>	21
2.1	External Architecture	21
2.1.1	Integrated 10/100/1000 Mb/s PHY	22
2.1.2	System Interface	22
2.1.3	EEPROM Interface	22
2.1.4	Flash Memory Interface	23
2.1.5	Management Interfaces	23
2.1.5.1	Software Watchdog	23
2.1.6	General-Purpose I/O (Software-Definable Pins)	23
2.1.7	LEDs	24
2.1.8	Network Interfaces	24
2.2	DMA Addressing	24
2.3	Ethernet Addressing	25
2.4	Interrupt Control and Tuning	26
2.5	Hardware Acceleration Capability	26
2.5.1	Jumbo Frame Support	27
2.5.2	Receive and Transmit Checksum Offloading	27
2.5.3	TCP Segmentation	27
2.5.4	Receive Fragmented UDP Checksum Offloading	27
2.6	Buffer and Descriptor Structure	27
2.7	Multiple Transmit Queues	28
2.8	iSCSI Boot	28
<b>3.0</b>	<b>General Initialization and Reset Operation</b>	29
3.1	Power Up State	29
3.2	Initialization Sequence	29
3.3	Interrupts During Initialization	29
3.4	Global Reset and General Configuration	30
3.5	Receive Initialization	30
3.5.1	Initialize the Receive Control Register	31
3.5.2	Dynamic Queue Enabling and Disabling	31
3.6	Transmit Initialization	31
3.6.1	Dynamic Queue Enabling and Disabling	32
3.7	Link Setup Mechanisms and Control/Status Bit Summary	32
3.7.1	PHY Initialization	32
3.7.2	MAC/PHY Link Setup (CTRL_EXT.LINK_MODE = 00b)	32
3.7.3	MAC/SerDes Link Setup (CTRL_EXT.LINK_MODE = 11b)	34
3.7.4	MAC/SGMII Link Setup (CTRL_EXT.LINK_MODE = 10b)	35
3.8	Reset Operation	37
3.8.1	PHY Behavior During a Manageability Session:	41
3.9	Initialization of Statistics	42
<b>4.0</b>	<b>EEPROM and Flash Interface</b>	43
4.1	EEPROM Device	43
4.1.1	Software Accesses	43
4.1.2	Signature and CRC Fields	44
4.1.3	EEPROM Recovery	44
4.1.4	Protected EEPROM Space	45
4.1.5	Initial EEPROM Programming	45
4.1.6	Activating the Protection Mechanism	46
4.1.7	Non Permitted Accesses to Protected Areas in the EEPROM	46
4.1.8	EEPROM-Less Support	46



4.2	Flash Interface Operation .....	49
4.2.1	Flash Write Control .....	50
4.2.2	Flash Erase Control .....	50
4.3	Shared EEPROM .....	50
4.3.1	EEPROM Deadlock Avoidance .....	50
4.3.2	EEPROM Map Shared Words .....	51
4.4	Shared FLASH .....	51
4.4.1	Flash Access Contention .....	52
4.4.2	Flash Deadlock Avoidance .....	52
4.5	EEPROM Map .....	52
4.5.1	Hardware Accessed Words .....	54
4.5.1.1	Ethernet Address (Words 00h – 02h) .....	56
4.5.1.2	Initialization Control 1 (Word 0Ah) .....	56
4.5.1.3	Subsystem ID (Word 0Bh) .....	57
4.5.1.4	Subsystem Vendor ID (Word 0Ch) .....	57
4.5.1.5	Device ID (Word 0Dh, 11h) .....	57
4.5.1.6	Dummy Device ID (Word 1Dh) .....	57
4.5.1.7	Initialization Control 2 (Word 0Fh) .....	57
4.5.1.8	Software Defined Pins Control (Word 10h) .....	59
4.5.1.9	EEPROM Sizing & Protected Fields (Word 12h) .....	60
4.5.1.10	Initialization Control 3 (Word 14h, 24h) .....	61
4.5.1.11	NC-SI and PCIe* Completion Timeout Configuration (Word 15h) .....	63
4.5.1.12	MSI-X Configuration (Word 16h) .....	64
4.5.1.13	PLL/Lane/PHY Initialization Pointer (Word 17h) .....	64
4.5.1.14	PCIe* Initialization Configuration 1 (Word 18h) .....	64
4.5.1.15	PCIe* Initialization Configuration 2 (Word 19h) .....	64
4.5.1.16	Software Defined Pins Control (Word 20h) .....	65
4.5.1.17	PCIe* Initialization Configuration 3 (Word 1Ah) .....	66
4.5.1.18	PCIe* Control (Word 1Bh) .....	68
4.5.1.19	LED 1, 3 Configuration Defaults (Word 1Ch) .....	69
4.5.1.20	Device Revision ID (Word 1Eh) .....	70
4.5.1.21	LED 0, 2 Configuration Defaults (Word 1Fh) .....	70
4.5.1.22	Functions Control (Word 21h) .....	72
4.5.1.23	LAN Power Consumption (Word 22h) .....	72
4.5.1.24	Management Hardware Configuration Control (Word 23h) .....	72
4.5.1.25	End of RO Area (Word 2Ch) .....	74
4.5.1.26	Start of RO Area (Word 2Dh) .....	74
4.5.1.27	Watchdog Configuration (Word 2Eh) .....	74
4.5.1.28	VPD Pointer (Word 2Fh) .....	74
4.5.1.29	PXE Words (Words 30h:3Eh) .....	74
4.5.1.29.1	Main Setup Options PCI Function 0 (Word 30h) .....	74
4.5.1.29.2	Configuration Customization Options PCI Function 0 (Word 31h) .....	76
4.5.1.29.3	PXE Version (Word 32h) .....	77
4.5.1.29.4	IBA Capabilities (Word 33h) .....	77
4.5.1.29.5	Setup Options PCI Function 1 (Word 34h) .....	77
4.5.1.29.6	Configuration Customization Options PCI Function 1 (Word 35h) .....	78
4.5.1.29.7	iSCSI Option ROM Version (Word 36h) .....	78
4.5.1.29.8	Alternate MAC Address Pointer (Word 37h) .....	78
4.5.1.29.9	Setup Options PCI Function 2 (Word 38h) .....	78
4.5.1.29.10	Configuration Customization Options PCI Function 2 (Word 39h) .....	78
4.5.1.29.11	Setup Options PCI Function 3 (Word 3Ah) .....	78
4.5.1.29.12	Configuration Customization Options PCI Function 3 (Word 3Bh) .....	78
4.5.1.29.13	iSCSI Boot Configuration Offset (Word 3Dh) .....	78
4.5.1.29.13.1	iSCSI Module Structure .....	78
4.5.1.29.14	Checksum Word (Word 3Fh) .....	80
4.6	Manageability Control Sections .....	81
4.6.1	Sideband Configuration Structure .....	81
4.6.1.1	Section Header - (Offset 0h) .....	81
4.6.1.2	SMBus Max Fragment Size - (Offset 01h) .....	81
4.6.1.3	SMBus Notification Timeout and Flags - (Offset 02h) .....	81

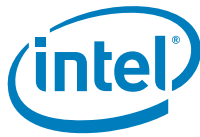

4.6.1.4	SMBus Slave Addresses - (Offset 03h).....	81
4.6.1.5	SMBus Fail-Over Register (Low Word) - (Offset 04h) .....	83
4.6.1.6	SMBus Fail-Over Register (High Word) - (Offset 05h) .....	83
4.6.1.7	NC-SI Configuration (Offset 06h).....	83
4.6.2	Flex TCO Filter Configuration Structure.....	83
4.6.2.1	Section Header - (Offset 0h) .....	83
4.6.2.2	Flex Filter Length and Control - (Offset 01h) .....	85
4.6.2.3	Flex Filter Enable Mask - (Offset 02 - 09h) .....	85
4.6.2.4	Flex Filter Data - (Offset 0Ah - Block Length) .....	85
4.6.3	NC-SI Microcode Download Structure.....	85
4.6.3.1	Data Patch Size (Offset 0h) .....	85
4.6.3.2	Rx and Tx Code Size (Offset 1h) .....	85
4.6.3.3	Download Data (Offset 2h - Data Size).....	85
4.6.4	NC-SI Configuration Structure.....	86
4.6.4.1	Section Header - (Offset 0h) .....	86
4.6.4.2	Rx Mode Control1 (RR_CTRL[15:0]) (Offset 01h).....	86
4.6.4.3	Rx Mode Control2 (RR_CTRL[31:16]) (Offset 02h).....	86
4.6.4.4	Tx Mode Control1 (RT_CTRL[15:0]) (Offset 03h) .....	86
4.6.4.5	Tx Mode Control2 (RT_CTRL[31:16]) (Offset 04h) .....	87
4.6.4.6	MAC Tx Control Reg1 (TxCtrlReg1 (15:0]) (Offset 05h) .....	87
4.6.4.7	MAC Tx Control Reg2 (TxCtrlReg1 (31:16]) (Offset 06h) .....	87
4.6.5	Common Firmware Pointer .....	87
4.6.5.1	Manageability Capability/Manageability Enable (Word 54h) .....	88
4.6.6	Pass Through Pointers.....	88
4.6.6.1	PT LAN0 Configuration Pointer (Word 56h) .....	88
4.6.6.2	SMBus Configuration Pointer (Word 57h).....	88
4.6.6.3	Flex TCO Filter Configuration Pointer (Word 58h).....	88
4.6.6.4	PT LAN1 Configuration Pointer (Word 59h) .....	90
4.6.6.5	NC-SI Microcode Download Pointer (Word 5Ah).....	90
4.6.6.6	NC-SI Configuration Pointer (Word 5Bh).....	90
4.6.7	PT LAN Configuration Structure .....	90
4.6.7.1	Section Header (Offset 0h) .....	90
4.6.7.2	LAN0 IPv4 Address 0 LSB, MIPAF0 (Offset 01h).....	90
4.6.7.3	LAN0 IPv4 Address 0 LSB, MIPAF0 (Offset 02h).....	90
4.6.7.4	LAN0 IPv4 Address 1; MIPAF1 (Offset 03h:04h) .....	90
4.6.7.5	LAN0 IPv4 Address 2; MIPAF2 (Offset 05h:06h) .....	91
4.6.7.6	LAN0 IPv4 Address 3; MIPAF3 (Offset 07h:08h) .....	91
4.6.7.7	LAN0 MAC Address 0 LSB, MMAL0 (Offset 09h) .....	91
4.6.7.8	LAN0 MAC Address 0 LSB, MMAL0 (Offset 0Ah) .....	91
4.6.7.9	LAN0 MAC Address 0 MSB, MMAH0 (Offset 0Bh).....	91
4.6.7.10	LAN0 MAC Address 1; MMAL/H1 (Offset 0Ch:0Eh) .....	91
4.6.7.11	LAN0 MAC Address 2; MMAL/H2 (Offset 0Fh:11h).....	91
4.6.7.12	LAN0 MAC Address 3; MMAL/H3 (Offset 12h:14h) .....	91
4.6.7.13	LAN0 UDP Flex Filter Ports 0:15; MFUTP Registers (Offset 15h:24h).....	92
4.6.7.14	LAN0 VLAN Filter 0:7; MAVTV Registers (Offset 25h:2Ch).....	92
4.6.7.15	LAN0 Manageability Filters Valid; MFVAL LSB (Offset 2Dh).....	92
4.6.7.16	LAN0 Manageability Filters Valid; MFVAL MSB (Offset 2Eh) .....	92
4.6.7.17	LAN0 MAC Value MSB (Offset 2Fh) .....	93
4.6.7.18	LAN0 MANC Value LSB (Offset 30h).....	93
4.6.7.19	LAN0 Receive Enable 1(Offset 31h) .....	93
4.6.7.20	LAN0 Receive Enable 2 (Offset 32h) .....	93
4.6.7.21	LAN0 MANC2H Value LSB (Offset 33h).....	95
4.6.7.22	LAN0 MANC2H Value MSB (Offset 34h) .....	95
4.6.7.23	Manageability Decision Filters; MDEF0,1 (Offset 35h).....	95
4.6.7.24	Manageability Decision Filters; MDEF0, 2 (Offset 36h).....	96
4.6.7.25	Manageability Decision Filters; MDEF1:6, 1:2 (Offset 37h:42h) .....	96
4.6.7.26	ARP Response IPv4 Address 0 LSB (Offset 43h) .....	97
4.6.7.27	ARP Response IPv4 Address 0 MSB (Offset 44h).....	97
4.6.7.28	LAN0 IPv6 Address 0 LSB; MIPAF (Offset 45h).....	97
4.6.7.29	LAN0 IPv6 Address 0 MSB; MIPAF (Offset 46h) .....	97



- 4.6.7.30 LAN0 IPv6 Address 0 LSB; MIPAF (Offset 47h) ..... 97
- 4.6.7.31 LAN0 IPv6 Address 0 MSB; MIPAF (Offset 48h) ..... 97
- 4.6.7.32 LAN0 IPv6 Address 0 LSB; MIPAF (Offset 49h) ..... 98
- 4.6.7.33 LAN0 IPv6 Address 0 MSB; MIPAF (Offset 4Ah) ..... 98
- 4.6.7.34 LAN0 IPv6 Address 0 LSB; MIPAF (Offset 4B) ..... 98
- 4.6.7.35 LAN0 IPv6 Address 0 MSB; MIPAF (Offset 4Ch) ..... 98
- 4.6.7.36 LAN0 IPv6 Address 1; MIPAF (Offset 4Dh) ..... 98
- 4.6.7.37 LAN0 IPv6 Address 2; MIPAF (Offset 55h:5Ch) ..... 98
- 4.7 Software Owned EEPROM Words ..... 98
  - 4.7.1 Compatibility Fields (Word 03h:07h) ..... 99
  - 4.7.2 PBA Number (Words 08h, 09h) ..... 99
- 5.0 Receive and Transmit Description ..... 101**
- 5.1 82575 Data Flows ..... 101
  - 5.1.1 Transmit Data Flow ..... 101
- 5.2 Receive Data Flow ..... 102
- 5.3 Receive Functionality ..... 102
  - 5.3.1 Packet Address Filtering ..... 103
  - 5.3.2 Receive Data Storage ..... 103
  - 5.3.3 Legacy Receive Descriptor Format ..... 104
    - 5.3.3.1 Length Field ..... 104
    - 5.3.3.2 Packet Checksum ..... 104
    - 5.3.3.3 Receive Descriptor Status Field ..... 105
    - 5.3.3.4 Receive Descriptor Errors Field ..... 107
    - 5.3.3.5 VLAN Tag Field ..... 109
  - 5.3.4 Advanced Receive Descriptors ..... 109
    - 5.3.4.1 Packet Buffer Address ..... 109
    - 5.3.4.2 Header Buffer Address ..... 109
    - 5.3.4.3 Packet Type ..... 111
    - 5.3.4.4 RSS Type ..... 111
    - 5.3.4.5 Split Header ..... 111
    - 5.3.4.6 Packet Checksum ..... 112
    - 5.3.4.7 RSS Hash Value ..... 113
    - 5.3.4.8 Extended Status ..... 113
    - 5.3.4.9 Extended Errors ..... 114
    - 5.3.4.10 Packet Buffer (Number of Bytes Exists in the Host Packet Buffer) ..... 115
    - 5.3.4.11 VLAN Tag Field ..... 116
  - 5.3.5 Receive UDP Fragmentation Checksum ..... 116
  - 5.3.6 Receive Descriptor Fetching ..... 116
  - 5.3.7 Receive Descriptor Write-Back ..... 117
    - 5.3.7.1 Receive Descriptor Packing ..... 117
  - 5.3.8 Receive Descriptor Ring Structure ..... 117
- 5.4 Multiple Receive Queues ..... 119
  - 5.4.1 Queuing for Virtual Machine Devices (VMDq) ..... 120
    - 5.4.1.1 Association Through MAC Address ..... 120
    - 5.4.1.2 Association Through MAC Address + RSS ..... 121
    - 5.4.1.3 Association through VLAN tag ID ..... 121
    - 5.4.1.4 Association through VLAN tag ID +RSS ..... 121
  - 5.4.2 Multiple Receive Queues & Receive-Side Scaling (RSS) ..... 122
    - 5.4.2.1 RSS Hash Function ..... 122
      - 5.4.2.1.1 Hash for IPv4 with TCP ..... 124
      - 5.4.2.1.2 Hash for IPv4 with UDP ..... 125
      - 5.4.2.1.3 Hash for IPv4 without TCP ..... 125
      - 5.4.2.1.4 Hash for IPv6 with TCP ..... 125
      - 5.4.2.1.5 Hash for IPv6 with UDP ..... 125
      - 5.4.2.1.6 Hash for IPv6 without TCP ..... 125
    - 5.4.2.2 Indirection Table ..... 125
    - 5.4.2.3 Support for Multiple Processors ..... 126
  - 5.4.3 RSS Verification Suite ..... 126
    - 5.4.3.1 IPv4 ..... 126
    - 5.4.3.2 IPv6 ..... 126



5.5	Header Splitting and Replication .....	127
5.5.1	Receive Packet Checksum Offloading .....	130
5.5.1.1	MAC Address Filter .....	131
5.5.1.2	SNAP/VLAN Filter .....	131
5.5.1.3	IPv4 Filter .....	131
5.5.1.4	IPv6 Filter .....	131
5.5.1.5	IPv6 Extension Headers .....	132
5.5.1.6	UDP/TCP Filter .....	133
5.6	Packet Transmission .....	133
5.6.1	Transmit Data Storage .....	134
5.6.2	Transmit Contexts .....	134
5.6.3	Transmit Descriptors .....	135
5.6.4	Legacy Transmit Descriptor Format .....	135
5.6.5	Transmit Descriptor Write Back Format .....	136
5.6.5.1	Length .....	136
5.6.5.2	Checksum Offset and Start (CSO and CSS) .....	136
5.6.5.3	Command Byte (CMD) .....	137
5.6.5.4	Transmit Descriptor Status Field Format .....	139
5.6.6	Transmit Descriptor Special Field Format .....	139
5.6.7	Advanced Transmit Context Descriptor .....	140
5.6.7.1	Maximum Segment Size (MSS) Control .....	141
5.6.8	Advanced Transmit Data Descriptor .....	142
5.6.8.1	Address .....	142
5.6.8.2	DTALEN .....	142
5.6.8.3	DTYP .....	142
5.6.8.4	DCMD .....	143
5.6.8.5	STA .....	144
5.6.8.6	IDX .....	144
5.6.8.7	POPTS .....	144
5.6.8.8	PAYLEN .....	144
5.7	Transmit Descriptor Ring Structure .....	144
5.7.1	Transmit Descriptor Fetching .....	146
5.7.2	Transmit Descriptor Write-Back .....	146
5.8	TCP Segmentation .....	147
5.8.1	Assumptions .....	148
5.8.2	Transmission Process .....	148
5.8.2.1	TCP Segmentation Data Fetch Control .....	148
5.8.3	TCP Segmentation Performance .....	148
5.8.4	Packet Format .....	149
5.8.5	TCP Segmentation Indication .....	149
5.8.6	IP and TCP/UDP Headers .....	151
5.8.7	IP/TCP/UDP Header Updating .....	156
5.8.7.1	TCP/IP/UDP Header for the First Frame .....	157
5.8.7.2	TCP/IP/UDP Header for the Subsequent Frames .....	157
5.8.7.3	TCP/IP/UDP Header for the Last Frame .....	158
5.9	IP/TCP/UDP Transmit Checksum Offloading .....	158
5.10	IP/TCP/UDP Transmit Checksum Offloading in Non-Segmentation Mode .....	159
5.10.1	IP Checksum .....	159
5.10.2	TCP Checksum .....	160
5.11	Multiple Transmit Queues .....	160
5.12	Tx Completions Head Write-Back .....	161
5.13	Interrupts .....	162
5.13.1	Interrupt Cause Register (ICR) .....	162
5.13.2	Interrupt Cause Set Register (ICS) .....	163
5.13.3	Interrupt Mask Set/Read Register (IMS) .....	163
5.13.4	Interrupt Mask Clear Register (IMC) .....	163
5.13.5	Interrupt Acknowledge Auto-mask register (IAM) .....	163
5.13.6	Extended Interrupt Cause Registers (EICR) .....	163
5.13.7	Extended Interrupt Cause Set Register (EICS) .....	164





5.13.8	Extended Interrupt Mask Set and Read Register (EIMS)/Extended Interrupt Mask Clear Register (EIMC)	164
5.13.9	Extended Interrupt Auto Clear Enable Register (EIAC)	164
5.13.10	Extended Interrupt Auto Mask Enable Register (EIAM)	164
5.13.11	Interrupt Modes Setting Bits	165
5.14	Interrupt Moderation	165
5.15	Clearing Interrupt Causes	168
5.15.1	Auto-Clear	168
5.15.2	Write to Clear	169
5.15.3	Read to Clear	169
5.16	Dynamic Interrupt Moderation	169
5.16.1	TCP Timer Interrupt	170
5.17	Memory Error Correction and Detection	170
<b>6.0</b>	<b>PCIe* Local Bus Interface</b>	<b>173</b>
6.1	General Functionality	173
6.1.1	Message Handling (Receive Side)	173
6.1.2	Message Handling (Transmit Side)	173
6.1.3	Data Alignment	174
6.1.3.1	4 KB Boundary	174
6.1.4	Transaction Attributes	174
6.1.4.1	Traffic Class and Virtual Channels	174
6.1.4.2	Relaxed Ordering	175
6.1.4.3	Snoop Not Required	175
6.1.4.3.1	No Snoop and Relaxed Ordering for LAN Traffic	175
6.1.4.3.2	No Snoop Option for Payload	175
6.2	Flow Control	176
6.2.1	Flow Control Rules	176
6.2.2	Upstream Flow Control Tracking	176
6.2.3	Flow Control Update Frequency	177
6.2.4	Flow Control Timeout Mechanism	177
6.2.5	Error Forwarding	177
6.3	Host Interface	177
6.3.1	Tag IDs	177
6.3.2	Completion Timeout Mechanism	181
6.4	Error Events and Error Reporting	182
6.4.1	Error Events	182
6.4.2	Error Pollution	184
6.4.3	Unsuccessful Completion Status	184
6.4.4	Error Reporting Changes	184
6.5	Link Layer	185
6.5.1	ACK/NAK Scheme	185
6.5.2	Supported DLLPs	185
6.5.3	Transmit EDB Nullifying	186
6.6	Physical Layer	186
6.6.1	Link Width	186
6.6.1.1	Polarity Inversion	187
6.6.1.2	L0s Exit latency	187
6.6.1.3	Lane-to-Lane De-Skew	187
6.6.1.4	Lane Reversal	187
6.6.1.5	Reset	188
6.6.1.6	Scrambler Disable	188
6.6.2	Performance Monitoring	188
6.6.3	Configuration Registers	188
6.6.3.1	PCI Compatibility	188
6.6.4	Mandatory PCI Configuration Registers	189
6.6.5	PCI Power Management Registers	195
6.6.5.1	Message Signaled Interrupt (MSI) Configuration Registers	197
6.6.5.2	MSI-X Configuration	198
6.6.5.3	PCIe* Configuration Registers	201
6.6.5.3.1	PCIe* Extended Configuration Space	210



6.6.5.3.2	Advanced Error Reporting Capability .....	211
6.6.5.3.3	Device Serial Number .....	211
<b>7.0</b>	<b>Power Management .....</b>	<b>215</b>
7.1	Power States .....	215
7.2	Auxiliary Power .....	216
7.3	Form Factor Power Limits .....	216
7.4	Power Management Interconnects .....	217
7.4.0.1	PCIe* Link Power Management .....	217
7.4.0.2	NC-SI Clock Control .....	219
7.4.0.3	PHY Power Management .....	219
7.4.0.3.1	Link Speed Control .....	219
7.4.0.3.2	D0a State .....	220
7.4.0.3.3	Non-D0a State.....	221
7.4.0.3.4	Link Energy Detect .....	221
7.4.0.3.5	PHY Power-Down State .....	221
7.4.0.3.6	SerDes/SGMII Power-Down State.....	222
7.4.1	Power States .....	222
7.4.1.1	Dr State .....	222
7.4.1.1.1	Dr Disable Mode .....	222
7.4.1.1.2	Entry to Dr State .....	223
7.4.1.2	D0 Uninitialized State .....	223
7.4.1.2.1	Entry to D0u State .....	223
7.4.1.3	D0 Active State.....	224
7.4.1.3.1	Entry to D0a State .....	224
7.4.1.4	D3 State.....	224
7.4.1.4.1	Entry to D3 State.....	224
7.4.1.4.2	Master Disable.....	225
7.4.1.5	Link-Disconnect .....	225
7.4.2	Power-State Transitions Timing .....	226
7.4.2.1	Power Up (Off to Dup to D0u to D0a).....	226
7.4.2.2	Transition from D0a to D3 and Back without PE_RST_N.....	227
7.4.2.3	Transition from D0a to D3 and Back with PE_RST_N .....	228
7.4.2.4	D0a to Dr and Back without Transition to D3 .....	229
7.4.2.5	Timing Requirements.....	229
7.4.2.6	Timing Guarantees .....	230
7.4.3	82575 and SerDes Power-Down State .....	230
7.4.3.1	SerDes Power-Down State.....	230
7.4.3.2	82575 Power-Down State.....	231
7.5	Wake Up .....	231
7.5.1	Advanced Power Management Wakeup.....	231
7.5.2	PCIe Power Management Wakeup.....	232
7.5.3	Wake-Up Packets .....	233
7.5.3.1	Pre-Defined Filters .....	233
7.5.3.1.1	Directed Exact Packet .....	233
7.5.3.1.2	Directed Multicast Packet .....	233
7.5.3.1.3	Broadcast .....	234
7.5.3.1.4	Magic Packet* .....	234
7.5.3.1.5	ARP/IPv4 Request Packet .....	235
7.5.3.1.6	Directed IPv4 Packet .....	235
7.5.3.1.7	Directed IPv6 Packet .....	236
7.5.3.2	Flexible Filter.....	236
7.5.3.2.1	IPX Diagnostic Responder Request Packet .....	237
7.5.3.2.2	Directed IPX Packet.....	237
7.5.3.2.3	IPv6 Neighbor Discovery Filter .....	238
7.5.3.3	Wake Up Packet Storage .....	238
<b>8.0</b>	<b>DCA .....</b>	<b>239</b>
8.1	Implementation Details .....	239
8.1.1	PCIe* Message Format for DCA (MWr Mode) .....	239



<b>9.0</b>	<b>Ethernet Interface</b> .....	241
9.1	Internal MAC/PHY 10/100/1000Base-T Interface.....	242
9.1.1	MDIO/MDC .....	242
9.2	Duplex Operation for Copper PHY Operation .....	243
9.2.1	Full Duplex .....	243
9.2.2	Half Duplex .....	244
9.2.3	Gigabit Physical Coding Sub-Layer (PCS) for SerDes .....	244
9.2.3.1	8B10B Encoding/Decoding .....	244
9.2.3.2	Code Groups and Ordered Sets .....	245
9.2.4	SGMII Encoding in 10/100 Mb/s .....	245
9.3	Auto-Negotiation and Link Setup .....	246
9.3.1	SerDes Link Configuration .....	246
9.3.1.1	SerDes Mode Auto-Negotiation .....	246
9.3.1.2	PCS Hardware Auto-Negotiation .....	247
9.3.1.3	Forcing Link .....	247
9.3.1.4	Hardware Detection of Non-Auto-Negotiation Partner.....	248
9.3.1.5	SGMII Auto-Negotiation .....	248
9.3.2	Copper PHY Link Configuration .....	249
9.3.2.1	PHY Auto-Negotiation (Speed, Duplex, and Flow Control) .....	249
9.3.2.2	MAC Speed Resolution .....	249
9.3.2.2.1	Forcing MAC Speed .....	249
9.3.2.2.2	Using Internal PHY Direct Link-Speed Indication.....	250
9.3.2.3	MAC Full/Half Duplex Resolution .....	250
9.3.2.4	Using PHY Registers .....	250
9.3.2.5	Comments Regarding Forcing Link.....	251
9.3.3	Loss of Signal/Link Status Indication.....	251
9.3.4	Flow Control .....	251
9.3.4.1	MAC Control Frames and Reception of Flow Control Packets.....	252
9.3.5	Discard PAUSE Frames and Pass MAC Control Frames .....	254
9.3.6	Transmission of PAUSE Frames .....	254
9.3.7	Software Initiated PAUSE Frame Transmission.....	255
9.4	Loopback Support.....	255
9.4.1	MAC Loopback .....	256
9.4.1.1	Setting the 82575 to MAC Loopback Mode .....	256
9.4.2	Internal PHY Loopback .....	256
9.4.2.1	Setting the 82575 to Internal PHY Loopback Mode.....	256
9.4.3	Internal SerDes Loopback.....	257
9.4.3.1	Setting Internal SerDes Loopback Mode .....	257
9.4.4	External PHY Loopback.....	257
9.4.4.1	Setting External PHY Loopback Mode .....	258
<b>10.0</b>	<b>802.1q VLAN Support</b> .....	259
10.1	802.1q VLAN Packet Format.....	259
10.1.1	802.1q Tagged Frames .....	259
10.2	Transmitting and Receiving 802.1q Packets.....	260
10.2.1	Adding 802.1q Tags on Transmits.....	260
10.2.2	Stripping 802.1q Tags on Receives .....	261
10.3	802.1q VLAN Packet Filtering .....	261
10.4	Double VLAN Support.....	262
<b>11.0</b>	<b>PHY Functionality and Features</b> .....	263
11.1	Auto MDIO Register Initialization .....	263
11.1.1	General Register Initialization .....	263
11.1.2	Visible Mirror Bit Initialization.....	263
11.2	Determining Link State.....	264
11.2.1	False Link.....	264
11.2.2	Forced Operation.....	265
11.2.3	Auto Negotiation .....	265
11.2.4	Parallel Detection .....	266
11.2.5	Auto Cross-Over .....	266
11.2.5.1	Support for Different Board Layouts .....	266



11.3	Link Criteria .....	267
11.3.1	1000BASE-T .....	267
11.3.2	100BASE-TX .....	267
11.3.3	10BASE-T.....	267
11.4	Link Enhancements.....	267
11.4.1	SmartSpeed .....	267
11.4.1.1	Using SmartSpeed .....	268
11.4.2	Flow Control .....	268
11.5	Management Data Interface .....	269
11.6	Low Power Operation .....	269
11.7	Power Down via the PHY Register .....	269
11.8	1000 Mb/s Operation .....	269
11.8.1	Transmit Functions .....	270
11.8.1.1	Scrambler .....	270
11.8.2	Transmit FIFO.....	271
11.8.2.1	Transmit Phase-Locked Loop PLL.....	271
11.8.2.2	Trellis Encoder .....	271
11.8.2.3	4DPAM5 Encoder.....	271
11.8.2.4	Spectral Shaper .....	271
11.8.2.5	Low-Pass Filter .....	272
11.8.2.6	Line Driver .....	272
11.8.2.7	Transmit/Receive Flow.....	272
11.8.3	Receive Functions.....	273
11.8.3.1	Hybrid .....	273
11.8.3.2	Automatic Gain Control .....	273
11.8.3.3	Timing Recovery .....	273
11.8.3.4	Analog-to-Digital Converter.....	273
11.8.3.5	Digital Signal Processor.....	273
11.8.3.6	Descrambler.....	273
11.8.3.7	Viterbi Decoder/Decision Feedback Equalizer (DFE).....	274
11.8.3.8	4DPAM5 Decoder .....	274
11.9	100 Mb/s Operation .....	274
11.10	10 Mb/s Operation .....	274
11.10.1	Link Test.....	274
11.10.2	10Base-T Link Failure Criteria and Override .....	275
11.10.3	Jabber .....	275
11.10.4	Polarity Correction.....	275
11.10.5	Dribble Bits .....	275
<b>12.0</b>	<b>Configurable LED Outputs .....</b>	<b>277</b>
<b>13.0</b>	<b>Dual Port Characteristics .....</b>	<b>279</b>
13.1	Features of Each MAC .....	279
13.1.1	PCIe* Interface.....	279
13.1.2	MAC Configuration Register Space .....	281
13.1.3	SDP, LED, INT# Output.....	281
13.2	Shared EEPROM .....	281
13.3	Shared FLASH .....	281
13.3.1	FLASH Access Contention .....	281
13.4	Link Mode/Configuration .....	282
13.5	LAN Disable .....	282
13.5.1	Overview .....	282
13.5.2	Multi-Function Advertisement.....	283
13.5.3	Legacy Interrupt Use .....	283
13.5.4	Power Reporting.....	283
13.6	Device Disable .....	283
13.6.1	BIOS Handling of Device Disable .....	284
13.7	Copper/Fiber Switch.....	284
<b>14.0</b>	<b>Register Descriptions.....</b>	<b>287</b>
14.1	Register Conventions .....	287



14.1.1	Memory and I/O Address Decoding .....	289
14.1.1.1	Memory-Mapped Access to Internal Registers and Memories .....	289
14.1.1.2	Memory-Mapped Access to FLASH .....	289
14.1.1.3	Memory-Mapped Access to MSI-X Tables.....	289
14.1.1.4	Memory-Mapped Access to Expansion ROM.....	290
14.1.2	I/O-Mapped Internal Register, Internal Memory, and Flash .....	290
14.1.2.1	IOADDR.....	290
14.1.2.2	IODATA .....	291
14.1.2.3	Undefined I/O Offsets .....	292
14.2	Register Summary.....	292
14.3	Main Register Descriptions .....	298
14.3.1	Device Control Register - CTRL (00000h; R/W).....	299
14.3.2	Device Status Register - STATUS (00008h; R).....	302
14.3.3	EEPROM/Flash Control Register - EEC (00010h; R/W).....	303
14.3.4	EEPROM Read Register - EERD (00014h; RW) .....	305
14.3.5	Extended Device Control Register - CTRL_EXT (00018h, R/W).....	306
14.3.6	Flash Access - FLA (0001Ch; R/W).....	309
14.3.7	MDI Control Register - MDIC (00020h; R/W).....	310
14.3.8	PHY Registers .....	311
14.3.8.1	PHY Control Register - PCTRL (00d; R/W).....	312
14.3.8.2	PHY Status Register - PSTATUS (01d; R).....	313
14.3.8.3	PHY Identifier Register 1 (LSB) - PHY ID 1 (02d; R).....	314
14.3.8.4	PHY Identifier Register 2 (MSB) - PHY ID 2 (03d; R) .....	314
14.3.8.5	Auto-Negotiation Advertisement Register - ANA (04d; R/W) .....	314
14.3.8.6	Auto-Negotiation Base Page Ability Register - (05d; R).....	315
14.3.8.7	Auto-Negotiation Expansion Register - ANE (06d; R).....	316
14.3.8.8	Auto-Negotiation Next Page Transmit Register - NPT (07d; R/W).....	316
14.3.8.9	Auto-Negotiation Next Page Ability Register - LPN (08d; R).....	317
14.3.8.10	1000BASE-T/100BASE-T2 Control Register - GCON (09d; R/W).....	317
14.3.8.11	1000BASE-T/100BASE-T2 Status Register - GSTATUS (10d; R).....	318
14.3.8.12	Extended Status Register - ESTATUS (15d; R) .....	319
14.3.8.13	Port Configuration Register - PCONF (16d; R/W) .....	319
14.3.8.14	Port Status 1 Register - PSTAT (17d; RO).....	320
14.3.8.15	Port Control Register - PCONT (18d; R/W).....	321
14.3.8.16	Link Health Register - LINK (19d; RO) .....	322
14.3.8.17	1000Base-T FIFO Register - PFIFO (20d; R/W).....	323
14.3.8.18	Channel Quality Register - CHAN (21d; RO).....	324
14.3.8.19	PHY Power Management - (25d; R/W) .....	324
14.3.8.20	Special Gigabit Disable Register - (26d; R/W) .....	324
14.3.8.21	Misc Cntrl Register 1 - (27d; R/W) .....	325
14.3.8.22	Misc Cntrl Register 2 - (28d; RO) .....	325
14.3.8.23	Page Select Core Register - (31d; WO) .....	326
14.3.9	SERDES ANA - SERDESCTL (00024h; R/W).....	326
14.3.10	Copper/Fiber Switch Control - CONNSW (00034h; R/W) .....	326
14.3.11	VLAN Ether Type - VET (00038h; R/W) .....	327
14.3.12	Fuse Register - UFUSE (5B78h; RO).....	327
14.3.13	Flow Control Address Low - FCAL (00028h; R/W).....	328
14.3.14	Flow Control Address High - FCAH (0002Ch; R/W) .....	328
14.3.15	Flow Control Type - FCT (00030h; R/W).....	329
14.3.16	Flow Control Transmit Timer Value - FCTTV (00170h; R/W) .....	329
14.3.17	LED Control - LEDCTL (00E00h; RW) .....	329
14.3.17.1	MODE Encodings for LED Outputs.....	330
14.3.18	Packet Buffer Allocation - PBA (01000h; R/W).....	331
14.3.19	Packet Buffer Size - PBS (01008h; R/W).....	332
14.3.20	SFP 12C Command - I2CCMD (01028h; R/W) .....	332
14.3.21	SFP 12C Parameters - I2CPARAMS (0102Ch; R/W) .....	333
14.3.22	Flash Opcode - FLASHOP (0103Ch; R/W).....	334
14.3.23	EEPROM Diagnostic - EEDIAG (01038h; RO) .....	334
14.3.24	Manageability EEPROM Control Register - EEMNGCTL (01010h; RO) .....	335
14.3.25	Manageability EEPROM Read/Write Data - EEMNGDATA (1014h; RO).....	336



14.3.26	Manageability Flash Control Register - FLMNGCTL (1018h; R/W).....	336
14.3.27	Manageability Flash Read Data - FLMNGDATA (101Ch; R/W).....	336
14.3.28	Manageability Flash Read Counter - FLMNGCNT (1020h; R/W).....	337
14.3.29	EEPROM Auto Read Bus Control - EEARBC (01024h; R/W).....	337
14.3.30	Watchdog Setup - WDSTP (01040h; R/W).....	338
14.3.31	Watchdog SW Device Status - WDSWSTS (01044h; R/W).....	338
14.3.32	Free Running Timer - FRTIMER (01048h; R/W).....	339
14.3.33	TCP Timer - TCPTIMER (0104Ch; R/W).....	339
14.3.34	Interrupt Cause Read Register - ICR (000C0h; R).....	340
14.3.35	Interrupt Cause Set Register - ICS (000C8h; WO).....	341
14.3.36	Interrupt Mask Set/Read Register - IMS (000D0h; R/W).....	342
14.3.37	Interrupt Mask Clear Register - IMC (000D8h; W).....	343
14.3.38	Interrupt Acknowledge Auto Mask Register - IAM (000E0h; R/W).....	344
14.3.39	Extended Interrupt Cause - EICR (01580h; RC/W1C).....	345
14.3.40	Extended Interrupt Cause Set - EICS (01520h; WO).....	345
14.3.41	Extended Interrupt Mask Set/Read - EIMS (01524h; RWS).....	346
14.3.42	Extended Interrupt Mask Clear - EIMC (01528h; WO).....	346
14.3.43	Extended Interrupt Auto Clear - EIAC (0152Ch; R/W).....	347
14.3.44	Extended Interrupt Auto Mask Enable - EIAM (01530h; R/W).....	347
14.3.45	Interrupt Throttle - EITR (01680h + 4*n [n = 0..9]; R/W).....	348
14.3.46	Immediate Interrupt Rx - IMIR (05A80h + 4*n [n = 0..7]; R/W).....	349
14.3.47	Immediate Interrupt Rx Extended - IMIREXT (05AA0h + 4*n [n = 0..7]; R/W).....	350
14.3.48	Immediate Interrupt Rx VLAN Priority - IMIRVP (05AC0h; R/W).....	350
14.3.49	MSI-X Allocation - MSIXBM (01600h + 4*n [n = 0..9]; R/W).....	351
14.3.50	Receive Control Register - RCTL (00100h; R/W).....	351
14.3.51	Split and Replication Receive Control - SRRCTL (0280Ch + 100*n [n=0..3]; R/W).....	354
14.3.52	Packet Split Receive Type - PSRTYPE (05480h + 4*n [n=0..3]; R/W).....	355
14.3.53	Flow Control Receive Threshold Low - FCRTL (02160h; R/W).....	356
14.3.54	Flow Control Receive Threshold High - FCRTH (02168h; R/W).....	357
14.3.55	Flow Control Refresh Threshold Value - FCRTV (02460h; R/W).....	357
14.3.55.1	Receive Descriptor Base Address Low - RDBAL (02800h + 100*n [n=0..3]; R/W).....	358
14.3.56	Receive Descriptor Base Address High - RDBAH (02804h + 100*n [n=0..3]; R/W).....	358
14.3.57	Receive Descriptor Length - RDLEN (02808h + 100*n [n=0..3]; R/W).....	358
14.3.58	Receive Descriptor Head - RDH (02810h + 100*n [n=0..3]; R/W).....	359
14.3.59	Receive Descriptor Tail - RDT (02818h + 100*n [n=0..3]; R/W).....	359
14.3.60	Receive Descriptor Control - RXDCTL (02828h + 100*n [n=0..3]; R/W).....	360
14.3.61	Receive Checksum Control - RXCSUM (05000h; R/W).....	361
14.3.62	Receive Long Packet Maximum Length - RLPML (05004; R/W).....	362
14.3.63	Receive Filter Control Register - RFCTL (05008h; R/W).....	362
14.3.64	Transmit Control Register - TCTL (00400h; R/W).....	363
14.3.65	Transmit Control Extended - TCTL_EXT (00404;R/W).....	364
14.3.66	Transmit IPG Register - TIPG (00410;R/W).....	365
14.3.67	DMA Tx Control - DTXCTL (03590h; R/W).....	365
14.3.68	Transmit Descriptor Base Address Low - TDBAL (03800h + 100*n [n=0..3]; R/W).....	366
14.3.69	Transmit Descriptor Base Address High - TDBAH (03804h + 100*n [n=0..3]; R/W).....	366
14.3.70	Transmit Descriptor Length - TDLEN (03808h + 100*n [n=0..3]; R/W).....	367
14.3.71	Transmit Descriptor Head - TDH (03810h + 100*n [n=0..3]; R/W).....	367
14.3.72	Transmit Descriptor Tail - TDT (03818h + 100*n [n=0..3]; R/W).....	367
14.3.73	Transmit Descriptor Control - TXDCTL (03828h + 100*n [n=0..3]; R/W).....	368
14.3.74	Tx Descriptor Completion Write-Back Address Low - TDWBAL (03838h + 100*n [n=0..3]; R/W) ..	369
14.3.75	Tx Descriptor Completion Write-Back Address High - TDWBAH (0383Ch + 100*n [n=0..3]; R/W)	370
14.3.76	PCS Configuration 0 - PCS_CFG (04200h; R/W).....	370
14.3.77	PCS Link Control - PCS_LCTL (04208h; R/W).....	371
14.3.78	PCS Link Status - PCS_LSTS (0420Ch; R/W).....	372
14.3.79	AN Advertisement - PCS_ANADV (04218h; R/W).....	373
14.3.80	Link Partner Ability - PCS_LPAB (0421Ch; RO).....	374
14.3.81	Next Page Transmit - PCS_NPTX (04220h; RO).....	375
14.3.82	Link Partner Ability Next Page - PCS_LPABNP (04224h; RO).....	376
14.4	DCA Registers.....	376
14.4.1	Rx DCA Control Registers - RXCTL (02814h 100h *n [n=0..3]; R/W).....	376





14.4.2	Tx DCA Control Registers - TXCTL (03814h + 100h *n [n=0..3]; R/W) .....	378
14.5	Filter Registers .....	378
14.5.1	Multicast Table Array - MTA (05200h + 4*n [n..127]; R/W) .....	379
14.5.2	Receive Address Low - RAL (05400h + 8*n [n=0..15]; R/W) .....	380
14.5.3	Receive Address High - RAH (05404h + 8*n [n=0..15]; R/W) .....	380
14.5.4	VLAN Filter Table Array - VFSA (05600h + 4*n [n=0..127]; R/W) .....	381
14.5.5	Multiple Receive Queues Command Register - MRQC (05818h; R/W) .....	382
14.5.6	Redirection Table - RETA (05C00h + 4*n [n=0..31]; R/W) .....	383
14.5.7	RSS Random Key Register - RSSRK (05C80h + 4*n [n=0..9]; R/W) .....	384
14.5.8	VMDq Control - VMD_CTRL (0581Ch; R/W) .....	384
14.5.9	VLAN Filter Queue Array 0 - VFQA0 (0B100h + 4*n [n=0..127]; R/W) .....	385
14.5.10	VLAN Filter Queue Array 1 - VFQA1 (0B200h + 4*n [n=0..127]; R/W) .....	385
14.6	WakeUp Registers .....	385
14.6.1	WakeUp Control Register - WUC (05800h; R/W) .....	385
14.6.2	WakeUp Filter Control Register - WUFC (05808h; R/W) .....	386
14.6.3	WakeUp Status Register - WUS (05810h; R/W1C) .....	387
14.6.4	IP Address Valid - IPAV (5838h; R/W) .....	387
14.6.5	IPv4 Address Table - IP4AT (05840h + 8*n [n=0..3]; R/W) .....	388
14.6.6	IPv6 Address Table - IP6AT (05880h + 4*n[n=0..3]; R/W) .....	388
14.6.7	WakeUp Packet Length - WUPL (05900h; RC) .....	389
14.6.8	WakeUp Packet Memory (128 Bytes) - WUPM (05A00h + 4*n [n=0..31]; RC) .....	389
14.6.9	Flexible Filter Mask Table - FFMT (09000h + 8*n [n=0..127]; R/W) .....	389
14.6.10	Flexible Filter Value Table - FFVT (09800h + 8*n [n=0..127]; R/W) .....	390
14.6.11	Flexible Filter Length Table - FFLT (05F00h + 8*n [n=0..3]; R/W) .....	390
14.7	Manageability Registers .....	391
14.7.1	Management VLAN TAG Value - MAVTV (5010h + 4*n [n=0..7]; R/W) .....	391
14.7.2	Management Flex UDP/TCP Ports - MFUTP (5030h + 4*n [n=0..7]; R/W) .....	392
14.7.3	Management Control Register - MANC (05820h; R/W) .....	392
14.7.4	Manageability Filters Valid - MFVAL (5824h; R/W) .....	393
14.7.5	Management Control to Host Register - MANC2H (5860h; R/W) .....	394
14.7.6	Manageability Decision Filters- MDEF (5890h + 4*n [n=0..7]; R/W) .....	394
14.7.7	Manageability IP Address Filter - MIPAF (0x58B0-0x58EC; RW) .....	395
14.7.8	Manageability MAC Address Low - MMAL (5910h + 8*n[n=0..3]; RW) .....	398
14.7.9	Manageability MAC Address High - MMAH (0x5914 + 8*n[n=0..3]; RW) .....	398
14.7.10	Flexible TCO Filter Table Registers - FTFT (09400h-097FCh; RW) .....	398
14.7.11	Legacy Sensor Polling Mask 1...8 Register (F8h:FFh) .....	400
14.8	PCIe* Registers .....	400
14.8.1	PCIe* Control - GCR (05B00h; R) .....	400
14.8.2	Function Tag - FUNCTAG (05B08h; R/W) .....	403
14.8.3	PCIe* Statistics Control #1 - GSCL_1 (05B10h; R) .....	403
14.8.4	PCIe* Statistics Control #2 - GSCL_2 (05B14h; R) .....	403
14.8.5	PCIe* Statistics Control #3 - GSCL_3 (05B18h; R/W) .....	407
14.8.6	PCIe* Statistics Control #4 - GSCL_4 (05B1Ch; R/W) .....	407
14.8.7	PCIe* Counter #0 - GSCN_0 (05B20h; R/W) .....	407
14.8.8	PCIe* Counter #1 - GSCN_1 (05B24h; R/W) .....	407
14.8.9	PCIe* Counter #2 - GSCN_2 (05B28h; R/W) .....	408
14.8.10	PCIe* Counter #3 - GSCN_3 (05B2Ch; R/W) .....	408
14.8.11	Function Active and Power State to MNG - FACTPS (05B30h; R) .....	408
14.8.12	SerDes/CCM/PCIe* CSR - GIOANACTL0 (05B34h; R/W) .....	409
14.8.13	SerDes/CCM/PCIe* CSR - GIOANACTL1 (05B38h; R/W) .....	409
14.8.14	GIOANACTL2 (05B3Ch; R/W) .....	409
14.8.15	GIOANACTL3 (05B40h; R/W) .....	410
14.8.16	SerDes/CCM/PCIe* CSR - GIOANACTLALL (05B44h; R/W) .....	410
14.8.17	SerDes/CCM/PCIe* CSR - CCMCTL (05B48h; R/W) .....	410
14.8.18	SerDes/CCM/PCIe* CSR - SCCTL (05B4Ch; R/W) .....	410
14.8.19	Software Semaphore - SWSM (05B50h; R/W) .....	411
14.8.20	Firmware Semaphore - FWSM (05B58h; R/WS) .....	411
14.8.21	Software-Firmware Synchronization - SW_FW_SYNC (05B5Ch; R/WS) .....	413
14.8.21.1	Using the Software-Firmware Synchronization Register .....	413
14.8.22	Mirrored Revision ID - MREVID (05B64h; R/W) .....	415

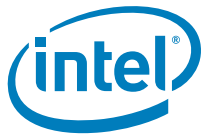

14.8.23	MSI-X PBA Clear - PBACL (05B68h; R/W1C).....	415
14.8.24	DCA Requester ID Information - DCA_ID (05B70h; R/W).....	415
14.8.25	DCA Control - DCA_CTRL (05B74h; R/W) .....	416
14.9	Statistics Registers .....	416
14.9.1	CRC Error Count - CRCERRS (04000h; RC) .....	416
14.9.2	Alignment Error Count - ALGNERRC (04004h; RC) .....	417
14.9.3	Symbol Error Count - SYMERRS (04008h; RC).....	417
14.9.4	RX Error Count - RXERRC (0400Ch; RC) .....	417
14.9.5	Missed Packets Count - MPC (04010h; RC) .....	417
14.9.6	Single Collision Count - SCC (04014h; RC) .....	418
14.9.7	Excessive Collisions Count - ECOL (04018h; RC).....	418
14.9.8	Multiple Collision Count - MCC (0401Ch; RC).....	418
14.9.9	Late Collisions Count - LATECOL (04020h; RC) .....	418
14.9.10	Collision Count - COLC (04028h; RC) .....	418
14.9.11	Defer Count - DC (04030h; RC).....	419
14.9.12	Transmit with No CRS - TNCRS (04034h; RC) .....	419
14.9.13	Receive Length Error Count - RLEC (04040h; RC) .....	419
14.9.14	XON Received Count - XONRXC (04048h; RC) .....	419
14.9.15	XON Transmitted Count - XONTXC (0404Ch; RC).....	420
14.9.16	XOFF Received Count - XOFFRXC (04050h; RC).....	420
14.9.17	XOFF Transmitted Count - XOFFTXC (04054h; RC).....	420
14.9.18	FC Received Unsupported Count - FCRUC (04058h; RC) .....	420
14.9.19	Packets Received (64 Bytes) Count - PRC64 (0405Ch; RC).....	421
14.9.20	Packets Received (65-127 Bytes) Count - PRC127 (04060h; RC) .....	421
14.9.21	Packets Received (128-255 Bytes) Count - PRC255 (04064h; RC).....	421
14.9.22	Packets Received (256-511 Bytes) Count - PRC511 (04068h; RC).....	421
14.9.23	Packets Received (512-1023 Bytes) Count - PRC1023 (0406Ch; RC) .....	422
14.9.24	Packets Received (1024 to Max Bytes) Count - PRC1522 (04070h; RC) .....	422
14.9.25	Good Packets Received Count - GPRC (04074h; RC).....	422
14.9.26	Broadcast Packets Received Count - BPRC (04078h; RC) .....	423
14.9.27	Multicast Packets Received Count - MPRC (0407Ch; RC) .....	423
14.9.28	Good Packets Transmitted Count - GPTRC (04080h; RC) .....	423
14.9.29	Good Octets Received Count - GORCL (04088h; RC)/GORCH (0408Ch; RC).....	424
14.9.30	Good Octets Transmitted Count - GOTCL (04090h; RC)/ GOTCH (04094; RC).....	424
14.9.31	Receive No Buffers Count - RNBC (040A0h; RC) .....	424
14.9.32	Receive Undersize Count - RUC (040A4h; RC) .....	425
14.9.33	Receive Fragment Count - RFC (040A8h; RC).....	425
14.9.34	Receive Oversize Count - ROC (040ACh; RC) .....	425
14.9.35	Receive Jabber Count - RJC (040B0h; R) .....	425
14.9.36	Management Packets Received Count - MNGPRC (040B4h; RC) .....	426
14.9.37	Management Packets Dropped Count - MPDC (040B8h; RC) .....	426
14.9.38	Management Packets Transmitted Count - MNGPTC (040BCh; RC) .....	426
14.9.39	Total Octets Received - TORL (040C0h; RC) / TORH (040C4h; RC).....	427
14.9.40	Total Octets Transmitted - TOTL (040C8h; RC / TOTH (040CCh; RC) .....	427
14.9.41	Total Packets Received - TPR (040D0h; RC) .....	427
14.9.42	Total Packets Transmitted - TPT (040D4h; RC) .....	428
14.9.43	Packets Transmitted (64 Bytes) Count - PTC64 (040D8h; RC) .....	428
14.9.44	Packets Transmitted (65-127 Bytes) Count - PTC127 (040DCh; RC) .....	428
14.9.45	Packets Transmitted (128-255 Bytes) Count - PTC255 (040E0h; RC).....	429
14.9.46	Packets Transmitted (256-511 Bytes) Count - PTC511 (040E4h; RC).....	429
14.9.47	Packets Transmitted (512-1023 Bytes) Count - PTC1023 (040E8h; RC) .....	429
14.9.48	Packets Transmitted (1024 Bytes or Greater) Count - PTC1522 (040ECh; RC) .....	429
14.9.49	Multicast Packets Transmitted Count - MPTC (040F0h; RC) .....	430
14.9.50	Broadcast Packets Transmitted Count - BPTC (040F4h; RC) .....	430
14.9.51	TCP Segmentation Context Transmitted Count - TSCTC (040F8h; RC) .....	430
14.9.52	Interrupt Assertion Count - IAC (04100h; RC) .....	431
14.9.53	Rx Packets to Host Count - RPTHC (04104h; RC) .....	431
14.9.54	Transmit Queue Empty Count - TXQEC (04118h; RC).....	431
14.9.55	Receive Descriptor Minimum Threshold Count - RXDMTC (04120h; RC) .....	431
14.9.56	Interrupt Cause Receiver Overrun Count - ICRXOC (04124h; RC) .....	431





14.9.57	SerDes/SGMII Code Violation Packet Count - SCVPC (04228h; R/WS)	432
14.10	Diagnostics Registers	432
14.10.1	Receive Data FIFO Head Register - RDFH (02410h; RO)	432
14.10.2	Receive Data FIFO Tail Register - RDFT (02418h; RO)	432
14.10.3	Receive Data FIFO Head Saved Register - RDFHS (02420h; RO)	433
14.10.4	Receive Data FIFO Tail Saved Register - RDFTS (02428h; RO)	433
14.10.5	Receive Data FIFO Packet Count - RDFPCQ (02430h + 4 *n [n=0..3]; RO)	433
14.10.6	PB Descriptor Read Pointers - PBDESCRP (02454h; RO)	434
14.10.7	Packet Buffer Diagnostic - PBDIAG (02458h; R/W)	434
14.10.8	Transmit Data FIFO Head Register - TDFH (03410h; RO)	434
14.10.9	Transmit Data FIFO Tail Register - TDFT (03418h; R/WS)	435
14.10.10	Transmit Data FIFO Head Saved Register - TDFHS (03420h; R/WS)	435
14.10.11	Transmit Data FIFO Tail Saved Register - TDFTS (03428h; R/WS)	435
14.10.12	Transmit Data FIFO Packet Count - TDFPC (03430h; RO)	436
14.10.13	Packet Buffer ECC Error Inject - PBEEI (03438h; RO)	436
14.10.14	Tx Descriptor Handler ECC Error Inject - TDHEEI (035F8h; R/W)	437
14.10.15	Rx Descriptor Handler ECC Error Inject - RDHEEI (025F8h; R/W)	437
14.10.16	Packet Buffer Memory - PBM (10000h - 10FFCh; R/W)	438
14.10.17	Packet Buffer Memory Page NPBMPN Register Bit Description	438
14.10.18	Rx Descriptor Handler Memory Page Number - RDHMP (025FCh; R/W)	438
14.10.19	Tx Descriptor Handler Memory Page Number - TDHMP (035FCh; R/W)	439
14.10.20	Packet Buffer ECC Status - PBECCTS (0245Ch; R/W)	440
14.10.21	Rx Descriptor Handler ECC Status - RDHESTS (02468h; R/W)	440
14.10.22	Tx Descriptor Handler ECC Status - TDHESTS (0246Ch; R/W)	441
14.11	Packet Generator Registers	441
14.11.1	Packet Generator Destination Address Low - PGDAL (04280h; R/W)	441
14.11.2	Packet Generator Destination Address High - PGDAH (04284h; R/W)	441
14.11.3	Packet Generator Source Address Low - PGSAL (04288h; R/W)	442
14.11.4	Packet Generator Source Address High - PGSAH (0428Ch; R/W)	442
14.11.5	Packet Generator Inter Packet Gap - PGIPG (04290h; R/W)	442
14.11.6	Packet Generator Packet Length - PGPL (04294h; R/W)	443
14.11.7	Packet Generator Number of Packets - PGNP (04298h; R/W)	443
14.11.8	Packet Generator StaPGSTS Bit Description	444
14.11.9	Packet Generator ContPGCTL Bit Description	444
14.12	MSI-X Registers	445
14.12.1	MSI-X Table Entry Lower Address - MSIXTADD (00000h - 00090h; R/W)	446
14.12.2	MSI-X Table Entry Upper Address - MSIXTUADD (BAR3: 0004h + n*10h [n=0..9]; RW)	446
14.12.3	MSI-X Table Entry Message - MSIXMSG (BAR3: 0008h + n*10h [n=0..9]; RW)	446
14.12.4	MSI-X Table Entry Vector Control - MSIXVCTRL (BAR3: 000Ch + n*10h [n=0..9]; RW)	446
14.12.5	MSI-X Pending Bit Array - MSIXPBA Bit Description	447
15.0	Diagnostics and Testability	449
15.1	Diagnostics	449
15.1.1	FIFO Pointer Accessibility	449
15.1.2	FIFO Data Accessibility	449
15.1.3	Loopback Operations	449
15.2	Testability	450
15.2.1	EXTEST Instruction	450
15.2.2	SAMPLE/PRELOAD Instruction	450
15.2.3	IDCODE Instruction	450
15.2.4	BYPASS Instruction	451
16.0	Statistics	453
16.1	IEEE 802.3 Clause 30 Management	453
16.2	OID_GEN_STATISTICS	454
16.3	RMON	455
16.4	Linux net_device_stats	455



NOTE: This page intentionally left blank.



## 1.0 Introduction

---

This document describes the external architecture (including device operation, register definitions, etc.) for the 82575, a Gigabit Ethernet (GbE) network interface controller.

For introduction to the 82575EB and for an overview, see the Intel® 82575EB GbE Controller Datasheet.

### 1.1 Register and Bit References

This document refers to device register names with all capital letters. To refer to a specific bit in a register the convention REGISTER.BIT is used. For example CTRL.FD refers to the *Full Duplex Mode* bit in the Device Control Register (CTRL).

### 1.2 Byte and Bit Designations

This document uses "B" to abbreviate quantities of bytes. For example, a 4 KB represents 4096 bytes. Similarly, "b" is used to represent quantities of bits. For example, 100 Mb/s represents 100 Megabits per second.

### 1.3 References

Intel references include the following manuals:

- Intel® 82575EB Gigabit Ethernet Controller Datasheet
- Intel® 82575EB Gigabit Ethernet Controller Design Guide
- Intel® 82575EB Gigabit Ethernet Controller Manageability
- Intel® 82575EB Gigabit Ethernet Controller Software Developer's Manual and EEPROM Guide
- Intel® 82575EB Gigabit Ethernet Controller Thermal Design Considerations
- Intel® 82575EB Gigabit Ethernet Controller Specification Update

Industry references include:

- IEEE standard 802.3, 2002 Edition (Ethernet). Incorporates various IEEE Standards previously published separately. Institute of Electrical and Electronic Engineers (IEEE).
- IEEE standard 1149.1, 2001 Edition (JTAG). Institute of Electrical and Electronics Engineers (IEEE)
- PCI Express\* Base Specification, Rev.1.1RD, November 2004



- PCI Express\* Card Electromechanical Specification, Rev 1.1RD, November 2004
- PICMG3.1 Ethernet/Fiber Channel Over PICMG 3.0 Draft Specification, September 4, 2002, Version 0.90.
- Advanced Configuration and Power Interface Specification, Rev 2.0b, October 2002
- PCI Bus Power Management Interface Specification, Rev. 1.2, March 2004
- PCI Local Bus Specification Revision 2.3 MSI-X ECN

## 1.4 Memory Alignment Terminology

Some 82575 data structures have special memory alignment requirements. This implies that the starting physical address of a data structure must be aligned as specified in this manual. The following terms are used for this purpose:

- **BYTE** alignment: Implies that the physical addresses can be odd or even. Examples: 0FECBD9A1h, 02345ADC6h.
- **WORD** alignment: Implies that physical addresses must be aligned on even boundaries. For example, the last nibble of the address can only end in 0, 2, 4, 6, 8, Ah, Ch, or Eh (0FECBD9A2h).
- **DWORD** (Double-Word) alignment: Implies that the physical addresses can only be aligned on 4-byte boundaries. For example, the last nibble of the address can only end in 0, 4, 8, or Ch (0FECBD9A8h).
- **QWORD** (Quad-Word) alignment: Implies that the physical addresses can only be aligned on 8-byte boundaries. For example, the last nibble of the address can only end in 0 or 8 (0FECBD9A8h).
- **PARAGRAPH** alignment: Implies that the physical addresses can only be aligned on 16-byte boundaries. For example, the last nibble must be a 0 (02345ADC0h).

§ §



## 2.0 Architectural Overview

---

This section provides an overview of the 82575. The following sections give detailed information about the 82575's functionality, register description, and initialization sequence. All major interfaces of the 82575 is described in detail.

The following principles shaped the design of the 82575:

1. Provide an Ethernet interface containing a 10/100/1000Mb/s PHY that also supports 1000 Base-X implementations.
2. Provide the highest performance solution possible, based on the following:
  - Provide direct access to all memory without using mapping registers
  - Minimize the PIO accesses required to manage the 82575
  - Minimize the interrupts required to manage the 82575
  - Off-load the host processor from simple tasks such as TCP checksum calculations
  - Maximize PCIe\* efficiency and performance
3. Provide a simple software interface for basic operations.
4. Provide a highly configurable design that can be used effectively in different environments.

### 2.1 External Architecture

Figure 1 shows the external interfaces to the 82575.

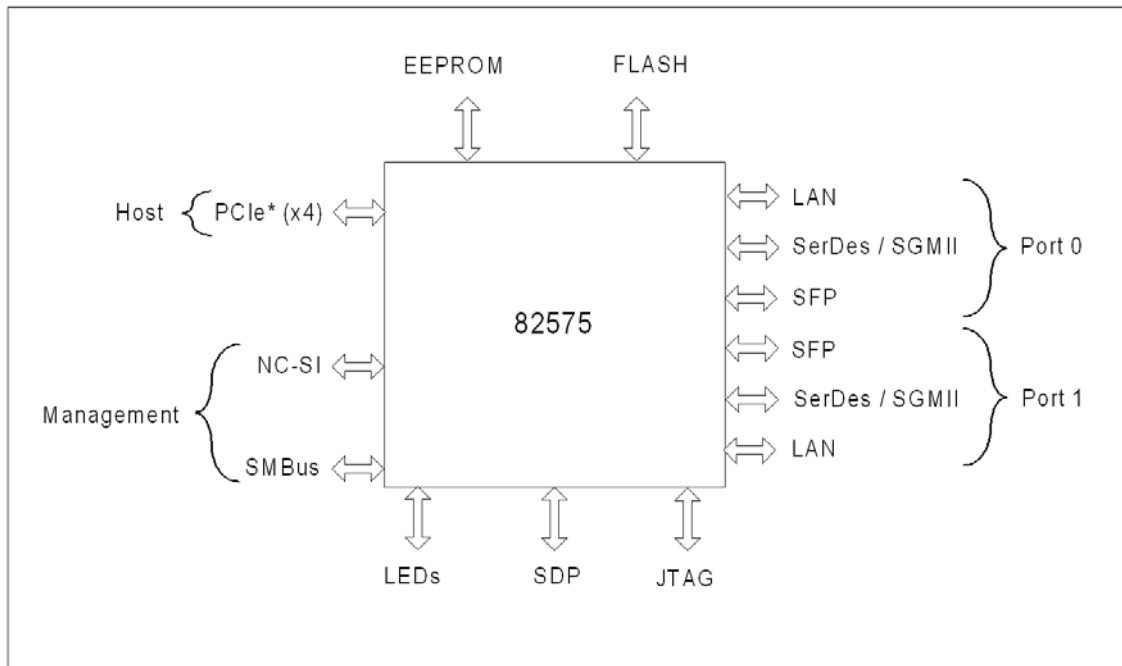

Figure 1. 82575 External Interfaces

## 2.1.1 Integrated 10/100/1000 Mb/s PHY

The 82575 contains integrated 10/100/1000 Mb/s-capable Copper PHY's. Each of these PHY's communicate with its MAC controllers using a standard 10/100/1000Base-T interface internal to the component to transfer transmit and receive data. A standard MDIO interface, accessible to software via MAC control registers, is also used to configure and monitor each PHY operation.

## 2.1.2 System Interface

The 82575 provides 4 lanes of PCIe\* bus interface working at 2.5 GHz each, this should provide sufficient bandwidth to support sustained dual port of 1000 Mb/s transfer rates. 48 KB of on-chip buffering mitigates instantaneous receive bandwidth demands and eliminates transmit under-runs by buffering the entire outgoing packet prior to transmission.

## 2.1.3 EEPROM Interface

The 82575 provides a four-wire direct interface to a serial EEPROM device such as the 93C46 or compatible for storing product configuration information. Several words of the data stored in the EEPROM are automatically accessed by the 82575, after reset, to provide pre-boot configuration data to the 82575 before it is accessible by the host software. The remainder of the stored information is accessed by various software modules to report product configuration, serial number and other parameters.

**Note:** An EEPROM is required for normal operation.



## 2.1.4 Flash Memory Interface

The 82575 provides an external serial interface to a FLASH device. Accesses to the FLASH are controlled by the 82575 and are accessible to software as normal PCIe\* reads or writes to the FLASH memory mapping area. The 82575 supports FLASH devices with up to 512 KB of memory

## 2.1.5 Management Interfaces

The 82575 contains two possible interfaces to an external BMC.

- SMBus
- NC-SI

Since the manageability sideband throughput is lower than the network link throughput, the 82575 allocates an 8 KB internal buffer for incoming network packets prior to being send over the sideband interface. Refer to the *82575 System Management Bus Interface Application Note* for detailed information about the management interface.

### 2.1.5.1 Software Watchdog

In some situations it might be useful to give an indication to the manageability firmware or to external devices that the 82575 hardware or the driver is not functional. In order to provide this functionality, a watchdog mechanism is used. This mechanism can be enabled by default, according to the EEPROM configuration. Once the host driver is up and it determines hardware is functional, it might reset the watchdog timer to indicate the device is functional. The software device driver then should re-arm the timer periodically. If the timer is not re-armed after a pre-programmed timeout, an interrupt is given to firmware and a pre-programmed SDP is raised. The SDP indication is shared between the ports.

The register controlling this feature is WDSSETUP. This register enables setting the timeout period and the activation of this mode. Both get their default from the EEPROM.

The re-arming of the timer is done by setting the WDSWSTS.Dev\_functional.

If software needs to trigger the watchdog immediately because it suspects hardware is stuck, it can set the WDSWSTS.Force\_WD bit. It can also give firmware an indication if the watchdog reason using the WDSWSTS.stuck\_reason field.

The SDP that provides the watchdog indication is set using the CTRL.SDP0\_WDE. In this mode the CTRL.SDP0\_IODIR should be set to output. The CTRL.SDP0\_DATA bit indicates the polarity of the indication. Setting this bit in one of the cores causes the watchdog indications of both cores to be indicated on this SDP.

## 2.1.6 General-Purpose I/O (Software-Definable Pins)

The 82575 has four software-defined pins (SDP pins) per port that can be used for miscellaneous hardware or software-controllable purposes. These pins and their function are bound to a specific LAN device (for example, eight SDP pins might not be associated with a single LAN device). These pins can each be individually configurable to act as either input or output pins. The default direction of each of



the four pins is configurable via EEPROM as well as the default value of any pins configured as outputs. To avoid signal contention, all four pins are set as input pins until after the EEPROM configuration is loaded.

The use, direction, and values of SDP pins are controlled and accessed using fields in the Device Control register (CTRL) and Extended Device Control register (CTRL\_EXT).

### 2.1.7 LEDs

The 82575 provides four LEDs per port that can be used to indicate different traffic status. The default setup of the LEDs is done via the EEPROM words 1Ch and 1Fh. The default setup for both ports is the same. This setup is reflected in the LEDCTL register of each port. Each software device driver can change its setup individually. For each of the LEDs the following parameters can be defined:

- Mode: Defines which information is reflected by this LED. The encoding is described in the LEDCTL register.
- Polarity: Defines the polarity of the LED.
- Blink mode: should the LED blink or be stable.

In addition, the blink rate of all LEDs can be defined. The possible rates are 200 ms or 83 ms for each phase. There is one rate for all LEDs.

### 2.1.8 Network Interfaces

The 82575 MAC provides a complete CSMA/CD function that supports IEEE 802.3 (10 Mb/s), 802.3u (100 Mb/s), 802.3z and 802.3ab (1000 Mb/s) implementations. The 82575 performs all of the functions required for transmission, reception, and collision handling called out in the standards.

Each 82575 MAC can be configured to be used as a different media interface. While the most likely application is expected to be based on use of the internal copper PHY, the 82575 supports the following potential configurations:

- Internal copper PHY
- External SerDes device such as an optical SerDes (SFP or onboard) or backplane connections.
- External SGMII device. This mode is used for SFP connections or external SGMII PHYs.

Selection between the various configurations is programmable via each MAC's Extended Device Control register (CTRL\_EXT.LINK\_MODE bits) and defaulted via EEPROM settings.

## 2.2 DMA Addressing

In appropriate systems, all addresses mastered by the 82575 are 64 bits in order to support systems that have larger than 32-bit physical addressing. Providing 64-bit addresses eliminates the need for special segment registers.

**Note:** Descriptor accesses are not byte swapped.

The following example illustrates data-byte ordering. Bytes for a receive packet arrive in the order shown from left to right.



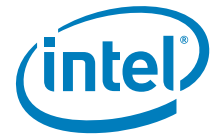

01 02 03 04 05 06 07 08 09 0a 0b 0c 0d 0e 0f 10 11 12 13 14 15 16 17 18 19 1a 1b 1c 1d 1e

### Example 1. Byte Ordering

There are no alignment restrictions on packet-buffer addresses. The byte address for the major words is shown on the left. The byte numbers and bit numbers for the PCIe\* bus are shown across the top.

**Table 1. Little Endian Data Ordering**

Byte	63							0
Address	7	6	5	4	3	2	1	0
0	08	07	06	05	04	03	02	01
8	10	0f	0e	0d	0c	0b	0a	09
10	18	17	16	15	14	13	12	11
18	20	1f	1e	1d	1c	1b	1a	19

## 2.3 Ethernet Addressing

Several registers store Ethernet addresses in the 82575. Two 32-bit registers make up the address: one is called “high”, and the other is called “low”. For example, the Receive Address Register is comprised of Receive Address High (RAH) and Receive Address Low (RAL). The least significant bit of the least significant byte of the address stored in the register (for example, bit 0 of RAL) is the multicast bit. The LS byte is the first byte to appear on the wire. This notation applies to all address registers, including the flow control registers.

Figure 2 shows the bit/byte addressing order comparison between what is on the wire and the values in the unique receive address registers.

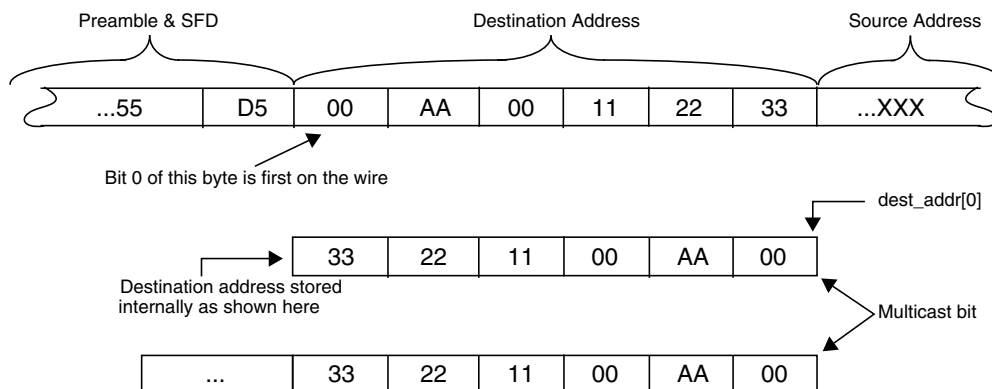

**Figure 2. Example of Address Byte Ordering**

The address byte order numbering shown in Figure 2 maps to Table 2. Byte #1 is first on the wire.



Table 2. Intel® Architecture Byte Ordering

IA Byte #	1 (LSB)	2	3	4	5	6 (MSB)
Byte Value (Hex)	00	AA	00	11	22	33

**Note:** The notation in this manual follows the convention shown in Table 2. For example, the address in Table 2 indicates 00\_AA\_00\_11\_22\_33h, where the first byte (00h\_) is the first byte on the wire, with bit 0 of that byte transmitted first.

## 2.4 Interrupt Control and Tuning

The 82575 provides a complete set of interrupts that allow for efficient software management. The interrupt structure is designed to accomplish the following:

- Make accesses “thread-safe” by using ‘set’ and ‘clear-on-read’ rather than ‘read-modify-write’ operations.
- Correlate between related bits in different registers (for example, ICR)
- Minimize the number of interrupts needed relative to work accomplished.
- Minimize the processing overhead associated with each interrupt.

The interrupt logic consists of the interrupt registers that are described in sections 14.3.34 through 14.3.37.

Two actions minimize the number of interrupts:

1. Reducing the frequency of all interrupts
2. Accepting multiple receive packets before signaling an interrupt.

One interrupt register consolidates all interrupt information eliminating the need for multiple accesses.

**Note:** The 82575 supports Message Signaled Interrupts per the PCI 2.2, 2.3, and PCIe\* specifications. See Section 4.7.5.1 for details.

## 2.5 Hardware Acceleration Capability

The 82575 provides the ability to offload IP, TCP, and UDP checksum for transmit. The functionality provided by these features can significantly reduce processor utilization by shifting the burden of the functions from the driver to the hardware. Features include:

- Jumbo frame support
- Receive and transmit checksum offloading
- TCP segmentation
- Receive fragmented UDP checksum offload
- These features are briefly outlined in the following sections.



## 2.5.1 Jumbo Frame Support

The 82575 supports jumbo frames to increase performance and decrease CPU utilization. By default, the 82575 might receive packets with a maximum size of 1522 bytes. If large frame reception is enabled by the RCTL register, the 82575 supports jumbo packet reception of up to 9018 bytes (including CRC and headers). On the transmit size, jumbo packets are always supported by the 82575. It is the responsibility of the software device driver to initiate jumbo packets only when it is configured to do so.

## 2.5.2 Receive and Transmit Checksum Offloading

The 82575 provides the ability to offload the IP, TCP, and UDP checksum requirements from the software device driver. For common frame types, the hardware automatically calculates, inserts, and checks the appropriate checksum values normally handled by software.

For transmits where the 82575 is doing non-TCP segmentation, every transmitted Ethernet packet can have two checksums calculated and inserted by the 82575. Typically these would be the IPv4 and either TCP or UDP checksums. The software device driver specifies which portions of the packet are included in the checksum calculations, and where the calculated values are inserted, via descriptor(s).

For receives, the hardware recognizes the packet type and performs the checksum calculations as well as error checking automatically. Checksum and error information is provided to software via the receive descriptor(s). Refer to [Section 5.5.1](#) for details.

## 2.5.3 TCP Segmentation

The 82575 implements a TCP segmentation capability for transmits that enables the software device driver to offload packet segmentation and encapsulation to the hardware. The software device driver can send the 82575 the entire IP (IPv4 or IPv6), TCP or UDP message sent down by the Network Operating System (NOS) for transmission. The 82575 segments the packet into legal Ethernet frames and transmit them on the wire. By handling the segmentation tasks, the hardware alleviates the software from handling some of the framing responsibilities. This reduces the overhead on the CPU for the transmission process thus reducing overall CPU utilization.

## 2.5.4 Receive Fragmented UDP Checksum Offloading

The 82575 provides the ability to offload inbound fragmented UDP packet reassembly. The 82575 provides the partial checksum calculation for each incoming UDP fragment so that the software device driver is required to sum the partial checksum words for each fragment to produce the complete checksum. The fragmented UDP checksum offload is provided to IPv4 packets.

## 2.6 Buffer and Descriptor Structure

Software allocates the transmit and receive buffers, and also forms the descriptors that contain pointers to, and the status of, those buffers. A conceptual ownership boundary exists between the driver software and the hardware of the buffers and descriptors.



The software gives the hardware ownership of a queue of buffers for receives. These receive buffers store data that the software then owns once a valid packet arrives.

For transmits, the software maintains a queue of buffers. The driver software owns a buffer until it is ready to transmit. The software then commits the buffer to the hardware; the hardware then owns the buffer until the data is loaded or transmitted in the transmit FIFO.

Descriptors store the following information about the buffers:

- The physical address
- The length
- Status and command information about the referenced buffer

Descriptors contain an end-of-packet field that indicates the last buffer for a packet. Descriptors also contain packet-specific information indicating the type of packet, and specific operations to perform in the context of transmitting a packet, such as those for VLAN or checksum offload.

## 2.7 Multiple Transmit Queues

The 82575 supports four transmit descriptor rings (this matches the expected number of processors on most server platforms).

The priority between the queues can be set and specified in the memory space. Multiple transmit queues are intended for the following usage models.

**Note:** If there are more processors than queues, then one queue can be used to service more than one processor.

## 2.8 iSCSI Boot

This feature consists of adding an iSCSI class code to potentially replace the LAN class code of the ports. When the system is booting, the BIOS detects this class code and runs SCSI software.

The 82575 reads two control bits out of EEPROM. Each bit affects its respective LAN class code value. If the bit is 0b (this is the current value of the unused bits) the LAN class code remains as it is (value = 020000 = LAN). If the bit is set to 1b, the LAN class code becomes a SCSI class code (value = 010000 = SCSI). Having this functionality enables programmers to change one port (or two in specific applications) to a SCSI device type and loads an iSCSI miniport driver for that port. This port also functions as iSCSI HBA. Default values for these fields in the EEPROM for both ports remain as a network class type.

In this case, the MAC address and the IP address of the port are used by the iSCSI function.

§ §



## 3.0 General Initialization and Reset Operation

---

This section lists all necessary initializations and describes the reset commands for the 82575.

### 3.1 Power Up State

When the 82575 powers up, it reads the EEPROM. The EEPROM contains sufficient information to bring the link up and configure the 82575 for manageability and/or APM wakeup. However, software initialization is required for normal operation.

### 3.2 Initialization Sequence

The following sequence of commands is typically issued to the 82575 by the software device driver in order to initialize the 82575 to normal operation. The major initialization steps are:

- Disable Interrupts - see Interrupts during initialization.
- Issue Global Reset and perform General Configuration - see Global Reset and General Configuration.
- Setup the PHY and the link - see Link Setup Mechanisms and Control/Status Bit Summary.
- Initialize all statistical counters - see Initialization of Statistics.
- Initialize Receive - see Receive Initialization.
- Initialize Transmit - see Transmit Initialization.
- Enable Interrupts - see Interrupts During Initialization.

### 3.3 Interrupts During Initialization

Most drivers disable interrupts during initialization to prevent re-entrancy. Interrupts are disabled by writing to the IMC and EIMC registers. Note that the interrupts also need to be disabled after issuing a global reset, so a typical driver initialization flow might be:

- Disable interrupts
- Issue a Global Reset
- Disable interrupts (again)
- ...



After the initialization completes, a typical driver enables the desired interrupts by writing to the IMS and EIMS registers.

## 3.4 Global Reset and General Configuration

The 82575 initialization typically starts with a global reset that puts it into a known state and enables the software device driver to continue the initialization sequence.

Several values in the Device Control Register (CTRL) need to be set upon power up or after an 82575 reset for normal operation.

- FD should be set per interface negotiation (if done in software), or is set by the hardware if the interface is Auto-Negotiating. This is reflected in the Device Status Register in the Auto-Negotiating case.
- Speed is determined via Auto-Negotiation or forced by software if the link is forced. Status information for speed is also readable in STATUS.
- In SerDes mode, CTRL.ILOS should be set to according to the polarity of the Sig\_DET signal.

Set the packet buffer allocation for transmit receive flows in the PBA register. This should be done before RCTL.RXEN & TCTL.TXEN are set. An ordered disabling of all queues and of the Rx and Tx flows is required before any change in the packet buffer allocation is done.

If flow control is enabled, program the FCRTL, FCRTH, FCTTV and FCRTV registers.

## 3.5 Receive Initialization

Program the Receive address register(s) per the station address. This can come from the EEPROM or from any other means (for example, on some systems, this comes from the system PROM not the EEPROM on the adapter card)

Set up the MTA (Multicast Table Array) per software by zeroing all entries initially and adding in entries as requested.

Program RCTL with appropriate values. If initializing it at this stage, it is best to leave the receive logic disabled (EN = 0b) until after the receive descriptor ring has been initialized. If VLANs are not used, software should clear VFE. Then there is no need to initialize the VFTA. Select the receive descriptor type.

The following should be done once per receive queue:

- Allocate a region of memory for the receive descriptor list.
- Receive buffers of appropriate size should be allocated and pointers to these buffers should be stored in the descriptor ring.
- Program the descriptor base address with the address of the region.
- Set the length register to the size of the descriptor ring.
- Program PSRCTL of the queue according to the size of the buffers and the required header handling
- If header split or header replication is required for this queue, program the PSRTYPE register according to the required headers.



- Enable the queue by setting RXDCTL.ENABLE. In the case of queue zero, the enable bit is set by default, as such, the ring parameters should be set before RCTL.RXEN is set.
- Program the direction of packets to this queue according to the mode select in MRQC. Packets directed to a disabled queue are dropped.

### 3.5.1 Initialize the Receive Control Register

To properly receive packets, the receiver should be enabled by setting RCTL.RXEN. This should be done only after all other setup is accomplished. If software uses the Receive Descriptor Minimum Threshold Interrupt, that value should be set.

**Note:** The Receive Descriptor Tail register of the queue (RDT[n]) should not be bumped until the queue is enabled. This register must also be written after the queue is enabled and the receiver is enabled.

### 3.5.2 Dynamic Queue Enabling and Disabling

Receive queues can be dynamically enabled or disabled provided the following procedure is followed:

Enabling:

- Follow the per queue initialization previously described.
- If there are still packets in the packet buffer directed to this queue according to previous settings, they are received after the queue is re-enabled. The software device driver might check if old packets are still in the internal packet buffer by reading the RDFPCQ# register of the queue.

Disabling:

- Disable the direction of packets to this queue.
- Disable the queue by clearing RXDCTL.ENABLE. The 82575 immediately stops to fetch and write back descriptors from this queue. The 82575 eventually completes the storage of one buffer allocated to this queue. Any further packet directed to this queue is dropped. If the currently processed packet is spread over more than one buffer, all subsequent buffers are not written.
- The 82575 clears RXDCTL.ENABLE only after all pending memory accesses to the descriptor ring or to the buffers are done. The software device drive should poll this bit before releasing the memory allocated to this queue.

The Rx path can be disabled only after all Rx queues are disabled.

## 3.6 Transmit Initialization

Program the TCTL register according to the required MAC behavior.

If work in half duplex mode is expected, program the TCTL\_EXT.COLD field. For internal PHY mode, the default value is 41h. For SGMII mode, a value reflecting the 82575 and the PHY SGMII delays should be used. A suggested value for a typical PHY is 46h for 10 Mb/s and 4Ch for 100 Mb/s.

The following should be done once per transmit queue:

- Allocate a region of memory for the transmit descriptor list.
- Program the descriptor base address with the address of the region.



- Set the length register to the size of the descriptor ring.
- Program the TXDCTL register with the desired TX descriptor write back policy. Suggested values are:
  - WTHRESH = 1b
  - All other fields 0b.
- Set the queue priority using TXDCTL.Priority
- Enable the queue using TXDCTL.ENABLE (queue zero is enabled by default).

Enable the transmit path by setting TCTL. This should be done only after all other settings are done.

### 3.6.1 Dynamic Queue Enabling and Disabling

Transmit queues can be dynamically enabled or disabled provided the following procedure is followed:

Enabling: Follow the per queue initialization previously described.

Disabling:

- Stop storing packet for transmission in this queue.
- Wait until the head of the queue (TDH) is equal to the tail (TDT). For example, the queue is empty.
- Disable the queue by clearing TXDCTL.ENABLE.

The Tx path can be disabled only after all Tx queues are disabled.

## 3.7 Link Setup Mechanisms and Control/Status Bit Summary

**Note:** The CTRL\_EXT.LINK\_MODE value should be set to the desired mode prior to the setting of the other fields in the link setup procedures.

### 3.7.1 PHY Initialization

Refer to the PHY documentation for the initialization and link setup steps. The software device driver uses the MDIC register to initialize the PHY and setup the link.

### 3.7.2 MAC/PHY Link Setup (CTRL\_EXT.LINK\_MODE = 00b)

This section summarizes the various means of establishing proper MAC/PHY link setups, differences in MAC CTRL register settings for each mechanism, and the relevant MAC status bits. The methods are ordered in terms of preference (the first mechanism being the most preferred).

- MAC settings automatically based on duplex and speed resolved by PHY (CTRL.FRCDPLX = 0b, CTRL.FRCSPEED = 0b)





CTRL.FD - Don't care; duplex setting is established from PHY's internal indication to the MAC (FDX) after PHY has auto-negotiated a successful link-up

CTRL.SLU - Must be set to 1b by software to enable communications between MAC and PHY

CTRL.RFCE - Must be set by software after reading flow control resolution from PHY registers

CTRL.TFCE - Must be set by software after reading flow control resolution from PHY registers

CTRL.SPEED - Don't care; speed setting is established from PHY's internal indication to the MAC (SPD\_IND) after PHY has auto-negotiated a successful link-up

STATUS.FD - Reflects the actual duplex setting (FDX) negotiated by the PHY and indicated to MAC

STATUS.LU - Reflects link indication (LINK) from PHY qualified with CTRL.SLU (set to 1b)

STATUS.SPEED - Reflects actual speed setting negotiated by the PHY and indicated to the MAC (SPD\_IND)

- MAC duplex and speed settings forced by software based on resolution of PHY (CTRL.FRCDPLX = 1b, CTRL.FRCSPD = 1b)

CTRL.FD - Set by software based on reading PHY status register after PHY has auto-negotiated a successful link-up

CTRL.SLU - Must be set to 1b by software to enable communications between MAC and PHY

CTRL.RFCE - Must be set by software after reading flow control resolution from PHY registers

CTRL.TFCE - Must be set by software after reading flow control resolution from PHY registers

CTRL.SPEED - Set by software based on reading PHY status register after PHY has auto-negotiated a successful link-up.

STATUS.FD - Reflects the MAC forced duplex setting written to CTRL.FD

STATUS.LU - Reflects link indication (LINK) from PHY qualified with CTRL.SLU (set to 1b)

STATUS.SPEED - Reflects MAC forced speed setting written in CTRL.SPEED

- MAC/PHY duplex and speed settings both forced by software (fully-forced link setup) (CTRL.FRCDPLX = 1b, CTRL.FRCSPD = 1b, CTRL.SLU = 1b)

CTRL.FD - Set by software to desired full/half duplex operation (must match duplex setting of PHY)

CTRL.SLU - Must be set to 1b by software to enable communications between MAC and PHY. PHY must also be forced/configured to indicate positive link indication (LINK) to the MAC

CTRL.RFCE - Must be set by software to desired flow-control operation (must match flow-control settings of PHY)

CTRL.TFCE - Must be set by software to desired flow-control operation (must match flow-control settings of PHY)

CTRL.SPEED - Set by software to desired link speed (must match speed setting of PHY)



STATUS.FD - Reflects the MAC duplex setting written by software to CTRL.FD

STATUS.LU - Reflects 1b. (positive link indication LINK from PHY qualified with CTRL.SLU).

**Note:** Since both CTRL.SLU and the PHY link indication LINK are forced, this bit set does not guarantee that operation of the link has been truly established.

STATUS.SPEED - Reflects MAC forced speed setting written in CTRL.SPEED.

### 3.7.3 MAC/SerDes Link Setup (CTRL\_EXT.LINK\_MODE = 11b)

Link setup procedures using an external SerDes interface mode:

- Hardware Auto-Negotiation Enabled (PCS\_LCTL.AN\_ENABLE = 1b)

CTRL.FD - Ignored; duplex is set by priority resolution of PCS\_ANDV and PCS\_LPAB.

CTRL.SLU - Ignored; it is not possible to "force" link configuration (AN\_ENABLE takes precedence)

CTRL.RFCE - Must be set by software after reading flow control resolution from PCS registers

CTRL.TFCE - Must be set by software after reading flow control resolution from PCS registers

CTRL.SPEED - Ignored; speed always 1000 Mb/s when using SGMII mode communications

STATUS.FD - Reflects hardware-negotiated priority resolution

STATUS.LU - Reflects PCS\_LSTS.AN COMPLETE (Auto-Negotiation complete)

STATUS.SPEED - Reflects 1000 Mb/s speed, reporting fixed value of 10b

PCS\_LCTL.FORCE\_LINK - Ignored; it is not possible to "force" link configuration (AN\_ENABLE takes precedence)

PCS\_LCTL.FSD - Ignored; it is not possible to "force" link configuration (AN\_ENABLE takes precedence)

PCS\_LCTL.FSV - Ignored; speed always 1000Mb/s when using SerDes mode communications

PCS\_LCTL.FDV - Ignored; duplex is set by priority resolution of PCS\_ANDV and PCS\_LPAB

PCS\_LCTL.FLV - Ignored; it is not possible to "force" link configuration (AN\_ENABLE takes precedence)

- Software-Executed Auto-Negotiation Enabled (PCS\_LCTL.AN\_ENABLE = 0b)

CTRL.FD - Should be set by software to the duplex value established via software priority resolution

CTRL.SLU - Should be set by software to 1b when software Auto-Negotiation completes

CTRL.RFCE - Set by software as a result of software priority resolution

CTRL.TFCE - Set by software as a result of software priority resolution

CTRL.SPEED - Ignored; speed always 1000 Mb/s when using SerDes mode communications



STATUS.FD - Reflects the value written by software to CTRL.FD

STATUS.LU - Reflects whether loss-of-signal (LOS) from SerDes is indicated, qualified with CTRL.SLU (set to 1b)

STATUS.SPEED - Reflects 1000 Mb/s speed, reporting fixed value of 10b

PCS\_LCTL.FORCE\_LINK - Must be set to 1b by software to enable communications to the SerDes

PCS\_LCTL.FSD - Must be set to 1b by software to enable communications to the SerDes

PCS\_LCTL.FSV - Ignored; speed always 1000 Mb/s when using SerDes mode communications.

PCS\_LCTL.FDV - Should be set by software to the duplex value established via software priority resolution

PCS\_LCTL.FLV - Should be set by software to 1b when software Auto-Negotiation completes

- Forced-Link (Auto-Negotiation Skipped) (PCS\_LCTL. AN ENABLE = 0b, and no software auto-negotiation performed)

CTRL.FD - Duplex is set by software for the desired duplex mode of operation

CTRL.SLU - Must be set to 1b by software to enable communications to the SerDes

CTRL.RFCE - Set by software for the desired mode of operation

CTRL.TFCE - Set by software for the desired mode of operation

CTRL.SPEED - Ignored

STATUS.FD - Reflects the value written by software to CTRL.FD

STATUS.LU - Reflects whether loss-of-signal (LOS) from SerDes is indicated, qualified with CTRL.SLU (set to 1b)

STATUS.SPEED - Reflects 1000 Mb/s speed, reporting fixed value of 10b

PCS\_LCTL.FORCE\_LINK - Must be set to 1b by software to enable communications to the SerDes

PCS\_LCTL.FSD - Must be set to 1b by software to enable communications to the SerDes

PCS\_LCTL.FSV - Ignored; speed always 1000 Mb/s when using SerDes mode communications.

PCS\_LCTL.FDV - Duplex is set by software for the desired duplex mode of operation.

PCS\_LCTL.FLV - Should be set by software to 1b to enable communications to the SerDes

### 3.7.4 MAC/SGMII Link Setup (CTRL\_EXT.LINK\_MODE = 10b)

Link setup procedures using an external SGMII interface mode:



- Hardware Auto-Negotiation Enabled (PCS\_LCTL. AN\_ENABLE = 1b, CTRL.FRCDPLX = 0b, CTRL.FRCSPEED = 0b)

CTRL.FD - Ignored; duplex is set by priority resolution of PCS\_ANDV and PCS\_LPAB.

CTRL.SLU - Ignored; it is not possible to "force" link configuration (AN\_ENABLE takes precedence)

CTRL.RFCE - Must be set by software after reading flow control resolution from PCS registers

CTRL.TFCE - Must be set by software after reading flow control resolution from PCS registers

CTRL.SPEED - Don't care; speed setting is established from SGMII's internal indication to the MAC after SGMII has auto-negotiated a successful link-up

STATUS.FD - Reflects hardware-negotiated priority resolution

STATUS.SPEED - Reflects actual speed setting negotiated by the SGMII and indicated to the MAC

PCS\_LCTL.FORCE\_LINK - Ignored; it is not possible to "force" link configuration (AN\_ENABLE takes precedence)

PCS\_LCTL.FSD - Ignored; it is not possible to "force" link configuration (AN\_ENABLE takes precedence)

PCS\_LCTL.FSV - Ignored; speed is set by priority resolution of PCS\_ANDV and PCS\_LPAB

PCS\_LCTL.FDV - Ignored; duplex is set by priority resolution of PCS\_ANDV and PCS\_LPAB

PCS\_LCTL.FLV - Ignored; it is not possible to "force" link configuration (AN\_ENABLE takes precedence)

- Software-Executed Auto-Negotiation Enabled (PCS\_LCTL. AN\_ENABLE = 0b; CTRL.FRCDPLX = 1b, CTRL.FRCSPEED = 1b)

CTRL.FD - Should be set by software to the duplex value established via software priority resolution

CTRL.SLU - Should be set by software to 1b when software Auto-Negotiation completes

CTRL.RFCE - Set by software as a result of software priority resolution

CTRL.TFCE - Set by software as a result of software priority resolution

CTRL.SPEED - Set by software to desired link speed (must match speed setting of external SGMII PHY)

STATUS.FD - Reflects MAC forced speed setting written in CTRL.SPEED

STATUS.LU - Reflects whether loss-of-signal (LOS) from SerDes is indicated, qualified with CTRL.SLU (set to 1b)

STATUS.SPEED - Reflects MAC forced speed setting written in CTRL.SPEED

PCS\_LCTL.FORCE\_LINK - Must be set to 1b by software to enable communications to the SGMII PHY

PCS\_LCTL.FSD - Must be set to 1b by software to enable communications to the SGMII PHY

PCS\_LCTL.FSV - Set by software to desired link speed (must match speed setting of external SGMII PHY)



PCS\_LCTL.FDV - Should be set by software to the duplex value established via software priority resolution

PCS\_LCTL.FLV - Should be set by software to 1b when software Auto-Negotiation completes

- Forced-Link (Auto-Negotiation Skipped) (PCS\_LCTL. AN\_ENABLE = 0b, and no software auto-negotiation performed)

CTRL.FD - Duplex is set by software for the desired duplex mode of operation

CTRL.SLU - Must be set to 1b by software to enable communications to the SerDes

CTRL.RFCE - Set by software for the desired mode of operation

CTRL.TFCE - Set by software for the desired mode of operation

CTRL.SPEED - Set by software to desired link speed (must match speed setting of external SGMII PHY)

STATUS.FD - Reflects the value written by software to CTRL.FD

STATUS.LU - Reflects whether loss-of-signal (LOS) from SerDes is indicated, qualified with CTRL.SLU (set to 1b)

STATUS.SPEED - Reflects MAC forced speed setting, written in CTRL.SPEED

PCS\_LCTL.FORCE\_LINK - Must be set to 1b by software to enable communications to the SerDes

PCS\_LCTL.FSD - Must be set to 1b by software to enable communications to the SerDes

PCS\_LCTL.FSV - Set by software to desired link speed (must match speed setting of external SGMII PHY and CTRL.SPEED)

PCS\_LCTL.FDV - Duplex is set by software for the desired duplex mode of operation (must match duplex setting of external SGMII PHY and CTRL.FD)

PCS\_LCTL.FLV - Must be set by software to 1b to enable communications to the SerDes

## 3.8 Reset Operation

The 82575's reset sources are as follows:

PE\_RST\_N:

Asserting PE\_RST\_N indicates that both the power and the PCIe\* clock sources are stable. This pin asserts an internal reset also after a D3cold exit. Most units are reset on the rising edge of PE\_RST\_N. The only exception is the GIO unit, which is kept in reset while PE\_RST\_N is deasserted (level).

Inband PCIe\* Reset:

The 82575 generates an internal reset in response to a Physical layer message from the PCIe\* or when the PCIe\* link goes down (entry to Polling or Detect state). This reset is equivalent to PCI reset in previous (PCI) gigabit LAN controllers.



#### D3hot to D0 Transition:

This is also known as ACPI Reset. The 82575 generates an internal reset on the transition from D3hot power state to D0 (caused after configuration writes from D3 to D0 power state). Note that this reset is per function and resets only the function that transitioned from D3hot to D0.

#### Software Reset:

Software can reset the 82575 by writing the Device Reset bit of the Device Control register (CTRL.RST). The 82575 re-reads the per-function EEPROM fields after a software reset. Bits that are normally read from the EEPROM are reset to their default hardware values. Note that this reset is per function and resets only the function that received the software reset. PCI Configuration space (configuration and mapping) of the 82575 is unaffected. Prior to issuing a software reset the software device driver needs to operate the master disable algorithm.

#### Force TCO:

This reset is generated when manageability logic is enabled. It is only generated if the Reset on Force TCO bit of the EEPROM's Management Control word is 1b. In pass through mode it is generated when receiving a ForceTCO SMB command with bit 1 or bit 7 set. EEPROM Reset:

Writing a 1b to the EEPROM Reset bit of the Extended Device Control Register (CTRL\_EXT.EE\_RST) causes the 82575 to re-read the per-function configuration from the EEPROM, setting the appropriate bits in the registers loaded by the EEPROM.

#### PHY Reset:

Software can write a 1b to the PHY Reset bit of the Device Control Register (CTRL.PHY\_RST) to reset the internal PHY. The firmware must configure the PHY following a PHY Reset.

The procedure for resetting the PHY by software is as follows:

1. Take PHY ownership using the software semaphore (SWSM.SWESMBI - 05B50h, bit 1 and SY\_FW\_SYNC.SW\_PHY\_SM0/1 - 05B5Ch, bit 1/2).
2. Drive PHY reset.
3. Wait 10 ms
4. Release PHY reset in the CTRL register.
5. Release PHY and EEPROM ownership using the software semaphore (SWSM.SWESMBI - 05B50h, bit 1 and SY\_FW\_SYNC.SW\_PHY\_SM0/1, SY\_FW\_SYNC.SW\_EEP\_SM - 05B5Ch, bit 1/2/0).
6. Wait for the CFG\_DONE (EEMNGCTL.CFG\_DONE - 1010h, bit 18).
7. Start configuring the PHY.

**Note:** Refer to [Section 14.0](#) for a description of software/firmware semaphore usage.

The resets affect the registers and logic listed in [Table 3](#).

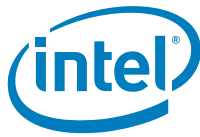

**Table 3. 82575 Reset Effects**

Reset Activation	Internal_Power_On_Reset	PE_RST_N	In-Band PCIe*	D3hot to D0	SW	Force TCO	EE	PHY	Notes
LTSSM (PCIe* back to detect/polling)	X	X	X						
PCIe* Link data path	X	X	X						
Read EEPROM (Per Function)				X	X	X	X		
Read EEPROM (Complete Load)	X	X	X						
PCI Configuration Registers RO	X	X	X						4
PCI Configuration Registers RW	X	X	X	X					
PCIe* local registers	X	X	X						5
Data path	X	X	X	X	X	X			
Wake Up (PM) Context	X	Note 1							5
Wake Up Control Register	X								6
Wake Up Status Registers	X								7
Rule Checker Tables	X								
Manageability Control Registers	X								8
Firmware (MMS Unit)	X								
Wake-Up Management Registers	X	X	X	X	X	X			4, 9
Memory Configuration Registers	÷	÷	÷	÷	÷	÷			4
PHY/SerDes PHY	÷	÷	÷	÷		÷		÷	2
Strapping Pins	÷	÷	÷						

**Notes:**

1. If AUX\_POWER = 0b the Wakeup Context is reset (PME\_Status and PME\_En bits should be 0b at reset if the 82575 does not support PME from D3cold).
2. The firmware must configure the PHY after any PHY reset.
3. Link reset clears the Receive Configuration Word (RXCW).
4. The following register fields do not follow the previously stated general rules:



- a. SDP0\_IODIR, SDP1\_IODIR, SDP2\_IODIR, SDP3\_IODIR - reset on Internal\_Power\_On\_Reset only. Any EEPROM auto-load resets these fields to the values in the EEPROM.
  - b. Packet Buffer Allocation (PBA) - reset on Internal\_Power\_On\_Reset only.
  - c. Packet Buffer Size (PBS) - reset on Internal\_Power\_On\_Reset only.
  - d. LED configuration registers
  - e. The Aux Power Detected bit in the PCIe\* Device Status register is reset on Internal\_Power\_On\_Reset and GIO Power Good only
  - f. FLA - reset on Internal\_Power\_On\_Reset only.
5. The following registers are part of this group:
- a. SWSM
  - b. GCR (only part of the bits; see [Section 14.0](#))
  - c. FUNCTAG
  - d. GSCL\_1/2/3/4
  - e. GSCN\_0/1/2/3
  - f. SW\_FW\_SYNC (only part of the bits; see [Section 14.0](#))
6. The Wake Up Context is defined in the PCI Bus Power Management Interface Specification (Sticky bits). It includes:
- a. PME\_En bit of the Power Management Control/Status Register (PMCSR).
  - b. PME\_Status bit of the Power Management Control/Status Register (PMCSR).
  - c. Aux\_En in the PCIe\* registers
  - d. The device Requester ID (since it is required for the PM\_PME TLP).
  - e. The shadow copies of these bits in the Wakeup Control Register are treated identically.
7. Refers to bits in the Wake Up Control Register that are not part of the Wake-Up Context (the PME\_En and PME\_Status bits).
8. The Wake Up Status Registers include the following:
- a. Wake Up Status Register
  - b. Wake Up Packet Length.
  - c. Wake Up Packet Memory.
9. The manageability control registers refer to the following registers:
- a. MANC - 5820h
  - b. MFUTP01-7 - 05030h - 504Ch
  - c. MFVAL - 05824h
  - d. MANC2H - 5860h
  - e. MAVTV1-7 - 0x5010 - 0x502C
  - f. MDEF0-7 - 890h - 58AC
  - g. MIPAF0-15 - 58B0h - 58ECh
10. MMAH/MMAL0-3 - 5910h - 592Ch
11. FWSM
- Note:** For detailed manageability control register information, refer to the *Intel® 82575 TCO/ System Manageability Interface Application Note*.
12. The Wake-up Management Registers include the following:
- a. Wake Up Filter Control.





- b. IP Address Valid.
- c. IPv4 Address Table
- d. IPv6 Address Table
- e. Flexible Filter Length Table
- f. Flexible Filter Mask Table

13. The Other Configuration Registers includes:

- General Registers
- Interrupt Registers
- Receive Registers
- Transmit Registers
- Statistics Registers
- Diagnostic Registers

Of these registers, MTA[n], VFTA[n], WUPM[n], FFMT[n], FFVT[n], TDBAH/TDBAL, and RDBAH/RDVAL registers have no default value. If the functions associated with the registers are enabled they must be programmed by software. Once programmed, their value is preserved through all resets as long as power is applied to the 82575.

**Note:** In situations where the 82575 is reset using the software reset CTRL.RST, the TX data lines are forced to all zeros. This causes a substantial number of symbol errors to be detected by the link partner.

### 3.8.1 PHY Behavior During a Manageability Session:

During some manageability sessions (for example a IDER or SOL session as initiated by an external BMC), the platform is reset so that it boots from a remote media. This reset must not cause the Ethernet link to drop since the manageability session will be lost. Also, the Ethernet link should be kept on continuously during the session for the same reasons. The 82575 limits the cases in which the internal PHY would restart the link, by masking two types of events from the internal PHY:

- PE\_RST\_N and PCIe\* resets (in-band and link drop) do not reset the PHY during such a manageability session
- The PHY does not change link speed as a result of a change in power management state to avoid link loss. For example, the transition to D3hot state is not propagated to the PHY.
  - Note that if main power is removed, the PHY is allowed to react to the change in power state (the PHY might respond in link speed change). The motivation for this exception is to reduce power when operating on auxiliary power by reducing link speed.

The capability described in this section is disabled by default on Internal\_Power\_On\_Reset. The *Keep\_PHY\_Link\_Up\_En* bit in the EEPROM must be set to 1b to enable it. Once enabled, the feature is enabled until the next Internal\_Power\_On\_Reset (the 82575 does not revert to the hardware default value on PE\_RST\_N, PCIe\* reset, or any other reset but Internal\_Power\_On\_Reset).

When the *Keep\_PHY\_Link\_Up* bit (veto bit) in the MANC register is set, the following behaviors are disabled:

- The PHY is not reset on PE\_RST\_N and PCIe\* resets (in-band and link drop). Other reset events are not affected: Internal\_Power\_On\_Reset, Device Disable, Force TCO, and PHY reset by software.
- The PHY does not change its power state. As a result link speed does not change.
- The 82575 does not initiate configuration of the PHY to avoid losing link.



The *Keep\_PHY\_Link\_Up* bit is set by the BMC through a command on the sideband interface. It is cleared by the external BMC (again, through a command on the sideband interface) when the manageability session ends. Once the *Keep\_PHY\_Link\_Up* bit is cleared, the PHY updates its Dx state and acts accordingly (negotiates its speed).

The *Keep\_PHY\_Link\_Up* bit is also cleared on de-assertion of the MAIN\_PWR\_OK input pin. MAIN\_PWR\_OK must be de-asserted at least 1 ms before power drops below its 90% value. This allows enough time to respond before auxiliary power takes over.

The *Keep\_PHY\_Link\_Up* bit is a R/W bit and can be accessed by host software, but software is not expected to clear the bit. The bit is cleared in the following cases:

- On Internal\_Power\_On\_Reset
- When the BMC resets or initializes it
- On de-assertion of the MAIN\_PWR\_OK input pin. The BMC should set the bit again if it wishes to maintain speed on exit from Dr state.

## 3.9 Initialization of Statistics

Statistics registers are hardware-initialized to values as detailed in each particular register's description. The initialization of these registers begins upon transition to D0active power state (when internal registers become accessible, as enabled by setting the Memory Access Enable of the PCIe\* Command register) and is guaranteed to complete within 1  $\mu$ s of this transition. Access to statistics registers prior to this interval might return indeterminate values.

All of the statistical counters are cleared on read and a typical software device driver reads them (making them zero) as a part of the initialization sequence.

§ §

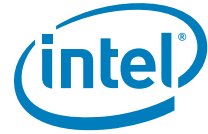

## 4.0 EEPROM and Flash Interface

---

This section describes the EEPROM and Flash interfaces supported by 82575.

### 4.1 EEPROM Device

The 82575 uses an EEPROM device to store product configuration information. The EEPROM is divided into three general regions:

- **Hardware Accessed** — Loaded by the 82575 after power-up, PCI reset de-assertion, a D3 to D0 transition, or a software commanded EEPROM read (CTRL\_EXT.EE\_RST).
- **Manageability Firmware Accessed**
  - In Pass-Through (PT) mode, loaded by the 82575 in PT mode after power up or a firmware reset. Refer to the *Intel® 82575 GbE Controller System Manageability Interface Application Note* for more information.
- **Software Accessed** — Used by software only. These registers are listed in this document for convenience and are only for software and are ignored by the 82575.

The EEPROM interface supports Serial Peripheral Interface (SPI) mode 0 and expects the EEPROM to be capable of 2 MHz operation.

The 82575 is compatible with many sizes of 4-wire serial EEPROM devices. If PT mode functionality (SMBus or NC-SI) is desired, a 32 KB (256 Kb) serial SPI-compatible EEPROM is recommended. If no manageability mode is desired, a 16 KB (128 Kb) serial SPI-compatible EEPROM can be used. All EEPROMs are accessed in 16-bit words although the EEPROM is designed to also accept 8-bit data accesses.

The 82575 automatically determines the address size to be used with the SPI EEPROM it is connected to and sets the *EEPROM Size* field of the EEPROM/Flash Control (EEC) and Data Register (EEC.EE\_ADDR\_SIZE; bit 10). Software uses this size to determine the EEPROM access method. The exact size of the EEPROM is stored within one of the EEPROM words.

**Note:** The different EEPROM sizes have two different numbers of address bits (8 bits or 16 bits). As a result, they must be accessed with a slightly different serial protocol. Software must be aware of this if it accesses the EEPROM using direct access.

#### 4.1.1 Software Accesses

The 82575 provides two different methods for software access to the EEPROM. It can either use the built-in controller to read the EEPROM or access the EEPROM directly using the EEPROM's 4-wire interface.



Software can use the EEPROM Read register (EERD) to cause the 82575 to read a word from the EEPROM that the software can then use. To do this, software writes the address to read into the *Read Address* field (EERD.ADDR; bits 15:2) and simultaneously writes a 1b to the *Start Read* bit (EERD.START; bit 0). The 82575 then reads the word from the EEPROM, sets the *Read Done* bit (EERD.DONE; bit 1), and puts the data in the *Read Data* field (EERD.DATA; bits 31:16). Software can poll the EEPROM Read register until it sees the *Read Done* bit set, then use the data from the *Read Data* field. Any words read this way are not written to the 82575's internal registers.

Software can also directly access the EEPROM's 4-wire interface through the EEPROM/Flash Control register (EEC). It can use this for reads, writes, or other EEPROM operations.

To directly access the EEPROM, software should follow these steps:

1. Write a 1b to the *EEPROM Request* bit (EEC.EE\_REQ; bit 6).
2. Read the *EEPROM Grant* bit (EEC.EE\_GNT; bit 7) until it becomes 1b. It remains 0b as long as the hardware is accessing the EEPROM.
3. Write or read the EEPROM using the direct access to the 4-wire interface as defined in the EEPROM/Flash Control & Data register (EEC). The exact protocol used depends on the EEPROM placed on the board and can be found in the appropriate datasheet.
4. Write a 0b to the *EEPROM Request* bit (EEC.EE\_REQ; bit 6).

Finally, software can cause the 82575 to re-read part of the hardware accessed fields of the EEPROM (setting the 82575's internal registers appropriately) by writing a 1b to the *EEPROM Reset* bit of the *Extended Device Control Register* (CTRL\_EXT.EE\_RST; bit 13).

**Note:** If the EEPROM does not contain a valid signature, the 82575 assumes 16-bit addressing. In order to access an EEPROM requiring 8-bit addressing, software must use the direct access mode.

## 4.1.2 Signature and CRC Fields

The only way the 82575 can discover whether an EEPROM is present is by trying to read the EEPROM. The 82575 first reads the EEPROM *Sizing & Protected* field Word at address 12h. The 82575 checks the signature value for bits 15 and 14. If bit 15 is 0b and bit 14 is 1b, it considers the EEPROM to be present and valid and reads additional EEPROM words and programs its internal registers based on the values read. Otherwise, it ignores the values it read from that location and does not read any other words.

## 4.1.3 EEPROM Recovery

The EEPROM contains fields that if programmed incorrectly might affect the functionality of 82575. The impact can range from incorrectly setting a function like LED programming, disabling an entire feature like no manageability or link disconnection, to the inability to access the 82575 via the regular PCIe\* interface.

The 825785 implements a mechanism that enables a recovery from a faulty EEPROM no matter what the impact is by using an SMBus message that instructs the firmware to invalidate the EEPROM.



This mechanism uses an SMBus message that the firmware is able to receive in all modes, no matter what the content of the EEPROM is (even in diagnostic mode). After receiving this kind of message, the firmware clears the signature of the EEPROM in word 12h bit 15/14 to 00b. Afterwards, the BIOS/operating system initiates a reset to force an EEPROM auto-load process that fails and enables access to the 82575.

Firmware is programmed to receive such a command only from a PCIe\* reset until one of the functions changes its status from D0u to D0a. Once one of the functions switches to D0a, it can be safely assumed that the 82575 is accessible to the host and there is no more need for this function. This reduces the possibility of malicious software to use this command as a back door and limits the time the firmware must be active in non-manageability mode.

If the firmware is programmed not to do any other function apart from answering to this command, it can request clock gating immediately after one of the functions changes its status from D0u to D0a. If the system goes back down to D0u from D0a, it is undefined whether firmware supports the EEPROM recovery command.

The Command is sent on a fixed SMBus address of C8h. The format of the command is SMBus Write Data Byte as follows:

Function	Command	Data Byte
Release EEPROM	C7h	AAh

**Note:** This solution requires a controllable SMBus connection to the 82575.

If more than one 82575 is in a state to accept this solution, then all the 82575s on the board ACKs this command and accepts it. An 82575 supporting this mode should not ACK this command if it is not in D0u state.

The 82575 is guaranteed to accept the command on the SMBus interface and on address C8h; however, it might be accepted on other configured interfaces and addresses as well.

After receiving a release EEPROM command, firmware should keep its current state. It is the responsibility of the programmer updating the EEPROM to send a firmware reset, if required, after the full EEPROM update process completes.

## 4.1.4 Protected EEPROM Space

The 82575 provides to the host a mechanism for a hidden area in the EEPROM. The hidden area cannot be accessed via the EEPROM registers in the CSR space. It can be accessed only by the Manageability (MNG) subsystem. For more information on the MNG subsystem, refer to the *82575 TCO/System Manageability Interface Application Note*.

A mechanism to protect part of the EEPROM from host writes is also provided. This mechanism is controlled by words 2Dh and 2Ch. These words control the start and the end of the read only area.

## 4.1.5 Initial EEPROM Programming

In most applications, initial EEPROM programming is done directly on the EEPROM pins. Nevertheless, it is desirable to enable existing software utilities (accessing the EEPROM via the host interface) to initially program the whole EEPROM without breaking the protection mechanism. Following a power-up



sequence, the 82575 reads the hardware initialization words in the EEPROM. If the signature in word 12h does not equal 01b the EEPROM is assumed as non-programmed. There are two effects for non-valid signature:

- The 82575 stops reading EEPROM data and sets the relevant registers to default values.
- The 82575 enables access to any location in the EEPROM via the EEPROM CSR registers.

## 4.1.6 Activating the Protection Mechanism

Following an 82575 initialization, it reads the EEPROM. It then turns on the protection mechanism if word 12h [15:14] contains a valid signature (equals 01b) and bit 4 in word 12h is set (enable protection). Once the protection mechanism is turned on, words 12h, 2Ch, and 2Dh become write-protected and the area that is defined by word 12h becomes hidden (for example, read/write protected) and the area defined by word 2Ch and 2Dh becomes write protected.

**Note:** No matter what the read only protected area is, words 30h:3Fh (used by the PXE driver) are writeable unless defined as hidden.

## 4.1.7 Non Permitted Accesses to Protected Areas in the EEPROM

This section refers to EEPROM accesses via the EEC (bit banging) or EERD (parallel read access) registers. Following a write access to the write protected areas in the EEPROM, the hardware responds properly on the PCIe\* bus, but does not initiate any access to the EEPROM. Following a read access to the hidden area in the EEPROM (as defined by word 12h), the hardware does not access the EEPROM and returns meaningless data to the host.

**Note:** Using bit banging, the SPI EEPROM can be accessed in a burst mode. For example, providing an opcode address and then reading or writing data for multiple bytes. The hardware inhibits an attempt to access the protected EEPROM locations even in burst accesses.

Software should not access the EEPROM in a Burst Write mode starting in a non protected area and continue to a protected one. In such a case, it is not guaranteed that the write access to any area ever takes place.

## 4.1.8 EEPROM-Less Support

The 82575 loads information from the EEPROM non-volatile memory storage into the device registers during the power-up sequence. If an EEPROM is not present, either by design or by fault, some of the device registers might not be tuned for normal operation. It is required that the following script be run immediately after an 82575 reset and before normal operation if an EEPROM is not detected.

**Note:** These actions are presented without comment because most of the settings involved are not customer tunable. They must be performed in order, and the loader function is included as follows. The example code is designed to be extensible to include other hardware families.

Definitions:

```
u32 is unsigned 32 bit value,
```



s32 is signed 32 bit value,

u8 is unsigned 8 bit value.

```
#define E1000_CCMCTL      0x05B48 /* CCM Control Register */
#define E1000_GIOCTL     0x05B44 /* GIO Analog Control Register */
#define E1000_SCCTL      0x05B4C /* PCIc PLL Cfg Register */
#define E1000_SCTL        0x00024 /* SerDes Control */
#define E1000_EECD        0x00010 /* EEPROM Control */
#define E1000_EECD_PRES   0x00000100 /* NVM Present */
#define E1000_GEN_CTL_READY      0x80000000
#define E1000_GEN_CTL_ADDRESS_SHIFT  8
#define E1000_GEN_POLL_TIMEOUT      640
```

Error codes are not required to be standard; programmers can define them as needed.

```
/* Is the EEPROM present? If not then run the tuning script*/
if ((E1000_READ_REG(hw, E1000_EECD) & E1000_EECD_PRES) == 0)
    if (hw->mac.type == e1000_82575) {
        /* SerDes configuration via SERDESCTRL */
        e1000_write_8bit_ctrl_reg(E1000_SCTL, 0x00, 0x0C);
        e1000_write_8bit_ctrl_reg(E1000_SCTL, 0x01, 0x78);
        e1000_write_8bit_ctrl_reg(E1000_SCTL, 0x1B, 0x23);
        e1000_write_8bit_ctrl_reg(E1000_SCTL, 0x23, 0x15);

        /* CCM configuration via CCMCTL register */
        e1000_write_8bit_ctrl_reg(E1000_CCMCTL, 0x14, 0x00);
        e1000_write_8bit_ctrl_reg(E1000_CCMCTL, 0x10, 0x00);

        /* PCIe lanes configuration */
        e1000_write_8bit_ctrl_reg(E1000_GIOCTL, 0x00, 0xEC);
        e1000_write_8bit_ctrl_reg(E1000_GIOCTL, 0x61, 0xDF);
        e1000_write_8bit_ctrl_reg(E1000_GIOCTL, 0x34, 0x05);
```



```
e1000_write_8bit_ctrl_reg(E1000_GIOCTL, 0x2F, 0x81);

/* PCIe PLL Configuration */
e1000_write_8bit_ctrl_reg(E1000_SCCTL, 0x02, 0x47);
e1000_write_8bit_ctrl_reg(E1000_SCCTL, 0x14, 0x00);
e1000_write_8bit_ctrl_reg(E1000_SCCTL, 0x10, 0x00);
    }
}

/**
 * e1000_write_8bit_ctrl_reg - Write a 8bit CTRL register
 * INPUTS
 *   reg: 32-bit register offset such as E1000_SCTL
 *   offset: register offset to write to
 *   data: data to write at register offset
 *
 * Writes an address/data control type register. There are several of these
 * and they all have the format address << 8 | data and bit 31 is polled for
 * completion.
 */
s32
e1000_write_8bit_ctrl_reg (u32 reg, u32 offset, u8 data)
{
    u32 i, regvalue = 0;
    s32 ret_val = E1000_SUCCESS;

    /* Set up the address and data */
    regvalue = ((u32)data) | (offset << E1000_GEN_CTL_ADDRESS_SHIFT);
    E1000_WRITE_REG(reg, regvalue);
}
```





```

/* Poll the ready bit to see if the MDI read completed */
for (i = 0; i < E1000_GEN_POLL_TIMEOUT; i++) {
    usec_delay(5);
    regvalue = E1000_READ_REG(reg);
    if (regvalue & E1000_GEN_CTL_READY)
        break;
}
if (!(regvalue & E1000_GEN_CTL_READY)) {
    DEBUGOUT1("Reg %08x did not indicate ready\n", reg);
    ret_val = -E1000_ERR_PHY;
}
return ret_val;
}

```

## 4.2 Flash Interface Operation

The 82575 provides two different methods for software access to the Flash.

Using legacy Flash transactions, the Flash is read from, or written to, each time the host processor performs a read or a write operation to a memory location that is within the FLASH address mapping or at boot via accesses in the space indicated by the Expansion ROM Base Address register. All accesses to the Flash require the appropriate command sequence for the 82575 used. Refer to the specific Flash data sheet for more details on reading from or writing to Flash.

Accesses to the Flash are based on a direct decode of processor accesses to a memory window defined in either:

1. The 82575's Flash Base Address register (PCIe\* Control register at offset 14h or 18h).
2. A certain address range of the IOADDR register defined by the IO Base Address register (PCIe\* Control register at offset 18h or 20h).
3. The Expansion ROM Base Address register (PCIe\* Control register at offset 30h).

The 82575 controls accesses to the Flash when it decodes a valid access.

**Note:** Flash read accesses must always be assembled by the 82575 each time the access is greater than a byte-wide access.

The 82575 byte reads or writes to the Flash take on the order of 2  $\mu$ s. The 82575 continues to issue retry accesses during this time.

The 82575 supports only byte writes to the Flash.

Another way for software to access the Flash is directly using the Flash's 4-wire interface through the Flash Access register (FLA). It can use this for reads, writes, or other Flash operations (accessing the Flash status register, erase, etc.).



To directly access the Flash, software needs to:

1. Write a 1b to the Flash Request bit (FLA.FL\_REQ)
2. Read the Flash Grant bit (FLA.FL\_GNT) until it = 1b. It remains 0b as long as there are other accesses to the Flash.
3. Write or read the Flash using the direct access to the 4-wire interface as defined in the Flash Access register (FLA). The exact protocol used depends on the Flash placed on the board and can be found in the appropriate datasheet.
4. Write a 0b to the *Flash Request* bit (FLA.FL\_REQ).

## 4.2.1 Flash Write Control

The Flash is write controlled by the FWE bits in the EEPROM/FLASH Control and Data register (EEC.FWE). Note that attempts to write to the Flash device when writes are disabled (FWE = 10b) should not be attempted. Behavior after such an operation is undefined and can result in component and/or system hangs.

After sending a one byte write to the Flash, software checks if it can send the next byte to write (check if the write process in the Flash had finished) by reading the Flash Access register. If the bit (FLA.FL\_BUSY) in this register is set, the current write did not finish. If bit (FLA.FL\_BUSY) is cleared, then software can continue and write the next byte to the Flash.

## 4.2.2 Flash Erase Control

When software needs to erase the Flash, it sets bit FLA.FL\_ER in the Flash Access register to 1b (Flash Erase) and then set bit EEC.FWE in the EEPROM/Flash Control register to 0b.

Hardware gets this command and sends the erase command to the Flash. Note that the erase process completes automatically. Software should wait for the end of the erase process before any further access to the Flash. This can be checked by using the Flash Write control mechanism.

The op-code used for erase operation is defined in the FLASHOP register.

**Note:** Sector erase by software is not supported. In order to delete a sector, the serial (bit bang) interface should be used.

## 4.3 Shared EEPROM

The 82575 uses a single EEPROM device to configure hardware default parameters for both LAN devices including Ethernet Individual Addresses (IA), LED behaviors, receive packet-filters for manageability, and wakeup capability). Certain EEPROM words are used to specify hardware parameters that are LAN device-independent (such as those which affect circuits behavior). Other EEPROM words are associated with a specific LAN device. Both LAN devices access the EEPROM to obtain their respective configuration settings.

### 4.3.1 EEPROM Deadlock Avoidance

The EEPROM is a shared resource between four clients:



- Hardware auto read.
- Accesses of port 0 LAN driver.
- Accesses of port 1 LAN driver.
- Firmware accesses.

All clients can access the EEPROM using parallel access, where hardware implements the actual access to the EEPROM. Hardware can also schedule these accesses so that all clients get served without starvation.

However, software and firmware clients can access the EEPROM using bit banging. In this case, there is a request/grant mechanism that locks the EEPROM to the exclusive usage of one client. If this client is stuck without releasing the lock, the other clients can no longer access the EEPROM. To avoid this, the 82575 implements a timeout mechanism that releases the grant from a client that did not toggle the EEPROM bit-bang interface for more than two seconds.

Consequently, if an agent that was granted access to the EEPROM for bit-bang access did not toggle, the bit bang interface for 500 ms. The agent should check if it still owns the interface before continuing the bit-banging.

### 4.3.2 EEPROM Map Shared Words

The EEPROM map lists those words configuring either LAN devices or the entire 82575 as LAN 0/LAN 1. Both. Those words configuring a specific LAN's device parameters are identified as either LAN 0 or LAN 1.

The following EEPROM words warrant additional notes specifically related to dual-LAN support:

Ethernet Address (IA) (LAN 0/LAN 1 shared)	The EEPROM specifies the IA associated with the LAN 0 device and used as the hardware default of the Receive Address registers for that device. The hardware-default IA for the LAN 1 device is automatically determined by the same EEPROM word and is set to the value of $\{IA_{LAN\ 0} \text{ XOR } 010000000000h\}$ .
Initialization Control 1, Initialization Control 2 (LAN 0/LAN 1 shared)	These EEPROM words specify hardware-default values for parameters that apply a single value to both LAN devices, such as link configuration parameters required for auto-negotiation, wakeup settings, PCI/PCI-X bus advertised capabilities, etc.
Initialization Control 3 (LAN 0, LAN 1 unique)	This EEPROM word configures default values associated with each LAN device's hardware connections, including which link mode (internal PHY) is used with this LAN device. Because a separate EEPROM word configures the defaults for each LAN, extra care must be taken to ensure that the EEPROM image does not specify a resource conflict.

## 4.4 Shared FLASH

The 82575 provides an interface to an external serial Flash/ROM memory device. This Flash/ROM device can be mapped into memory and/or I/O address space for each LAN device through the use of Base Address Registers (BARs). Bit 13 of the EEPROM Initialization Control Word 3 associated with each LAN device selectively disables/enables whether the Flash can be mapped for each LAN device by controlling the BAR register advertisement and write ability.



### 4.4.1 Flash Access Contention

The 82575 implements internal arbitration between Flash accesses initiated through the LAN 0 device and those initiated through the LAN 1 device. If accesses from both LAN devices are initiated during the same approximate size window, the first one is served first and only then the next one. Note that the 82575 does not synchronize between the two entities accessing the Flash though contentions caused from one entity reading and the other modifying the same locations is possible.

To avoid this contention, accesses from both LAN devices should be synchronized using external software synchronization of the memory or I/O transactions responsible for the access. It might be possible to ensure contention-avoidance simply by nature of software sequence.

### 4.4.2 Flash Deadlock Avoidance

The flash is a shared resource between the following clients:

- Accesses of port 0 LAN driver
- Accesses of port 1 LAN driver
- BIOS Parallel access via expansion ROM mechanism
- Firmware accesses

All clients can access the EEPROM using parallel access, where hardware implements the actual access to the flash. Hardware can schedule these accesses so that all the clients get served without starvation.

However, software and hardware clients can access the serial flash using bit banging. In this case, there is a request/grant mechanism that locks the serial flash to the exclusive usage of one client. If this client is stuck without releasing the lock, the other clients cannot access the flash. In order to avoid this, the 82575 implements a timeout mechanism, which releases the grant from a client that did not toggle the flash bit-bang interface for more than two seconds.

Consequently, if an agent that was granted access to the flash for bit-bang access did not toggle the bit-bang interface for 500 ms, it should check if it still owns the interface before continuing bit banging.

This mode is enabled by bit 5 in word 0Ah of the EEPROM.

## 4.5 EEPROM Map

Table 4 lists the EEPROM map for the 82575.

**Table 4. 82575 EEPROM Map**

Word	Used By <sup>1</sup>	High Byte (15:8)	Low Byte (7:0)	Image Value	LAN 0/1
00h	HW	Ethernet Address Byte 2	Ethernet Address Byte 1	IA(2,1)	Both
01h	HW	Ethernet Address Byte 4	Ethernet Address Byte 3	IA(4,3)	Both
02h	HW	Ethernet Address Byte 6	Ethernet Address Byte 5	IA(6,5)	Both
03h: 07h	SW	Compatibility (High Byte)	Compatibility (Low Byte)	0000h	Both
08h	SW	PBA Byte 1	PBA Byte 2		



**Table 4. 82575 EEPROM Map**

Word	Used By <sup>1</sup>	High Byte (15:8)	Low Byte (7:0)	Image Value	LAN 0/1
09h	SW	PBA Byte 3	PBA Byte 4		
0Ah	HW	Initialization Control 1			All
0Bh	HW	Subsystem ID			Both
0Ch	HW	Subsystem Vendor ID			All
0Dh	HW	Device ID			LAN 0
0Eh	HW	Reserved			All
0Fh	HW	Initialization Control 2			All
10h	HW	Software Defined Pins Control			LAN 1
11h	HW	Device ID			LAN 1
12h	HW	EEPROM Sizing & Protected Fields			Both
13h	HW	Reserved			Both
14h	HW	Initialization Control 3		XXXXh	LAN 1
15h	HW	NC-SI Configuration	PCIe* Completion Timeout Configuration		Both
16h	HW	MSI-X Configuration			Both
17h	FW	Firmware Start Address (Including PHY Initialization Address)			Both
18h	HW	PCIe* Initialization Configuration 1			Both
19h	HW	PCIe* Initialization Configuration 2			Both
1Ah	HW	PCIe* Initialization Configuration 3			Both
1Bh	HW	PCIe* Control			Both
1Ch	HW	LEDCTL 1 3 Default			Both
1Dh	HW	Dummy Function Device ID			Both
1Eh	HW	Device Revision ID			Both
1Fh	FW	LEDCTL 0 2 Default			Both
20h	HW	Software Defined Pins Control			LAN 0
21h	HW	Functions Control			Both
22h	HW	LAN Power Consumption		280Ch	Both
23h	HW	Management Hardware Configuration Control			Both
24h	HW	Initialization Control 3		XXXXh	LAN 0
25h: 2Bh	HW	Reserved			Both
2Ch	HW	End of RO Area			Both
2Dh	HW	Start of RO Area			Both
2Eh	HW	Watchdog Configuration			Both
2Fh	OEM	VPD Pointer			
30h	PXE	Main Setup Options PCI Function 0 (Word 30h)			
31h	PXE	Configuration Customization Options PCI Function 0 (Word 31h)			
32h	PXE	PXE Version (Word 32h)			
33h	PXE	IBA Capabilities (Word 33h)			
34h	PXE	Setup Options PCI Function 1 (Word 34h)			
35h	PXE	Configuration Customization Options PCI Function 1 (Word 35h)			
36h	PXE	iSCSI Option ROM Version (Word 36h)			
37h	PXE	Alternate MAC Address Pointer (Word 37h)			
38h	PXE	Setup Options PCI Function 2 (Word 38h)			



**Table 4. 82575 EEPROM Map**

Word	Used By <sup>1</sup>	High Byte (15:8)	Low Byte (7:0)	Image Value	LAN 0/1
39h	PXE	onfiguration Customization Options PCI Function 2 (Word 39h)			
3Ah	PXE	CSetup Options PCI Function 3 (Word 3Ah)			
3Bh	PXE	Configuration Customization Options PCI Function 3 (Word 3Bh)			
3Dh	iSCSI	SCSI Boot Configuration Offset (Word 3Dh)			
3Fh	PXE	Checksum Word (Word 3Fh)			
40h: 4Fh	HW	Reserved			
50h: 53h	FW	Common Firmware Pointers			MNG
54h	FW	MNG Capabilities			MNG
55h: 5Ah	FW	PT Pointers			MNG
5Bh: ...	FW	Firmware Structure			MNG

1. This column specifies whether this byte is used by hardware (HW), software (SW) or firmware (FW). EEPROM words can also be used by Preboot eXecution Environment (PXE) code.

### 4.5.1 Hardware Accessed Words

This section describes the EEPROM words that are loaded by the 82575 hardware. Most of these bits are located in configuration registers. The words are only read and used if the signature field in the EEPROM Sizing & Protected Fields (word 12h) is valid.

**Note:** When changing the default value of a reserved bit, 82575 behavior is undefined.

The following table lists the auto-load sequence.



**Table 5. EEPROM Auto-Load Sequence**

Full Reset	Reset of LAN0 Only	Reset of LAN1 Only	Comments
012	012	012	
00A	00A	00A	
018			
019			
01A			
01B			
026			
027			
028			
029			
02A			
02B			
025			
021			
01E			
015			
016			
014			
024			
01C			
01F			
02C			
02D			
022			
00B			Loaded only if load subsystem ID bit is set
00C			
00D			Loaded only if load device ID bit is set
01D			
011			
00F	00F	00F	
040			
041			



044			
047			
04E			
04F			
000	000	000	
001	001	001	
002	002	002	
020	020		
010		010	
02E	02E	02E	

### 4.5.1.1 Ethernet Address (Words 00h – 02h)

The Ethernet Individual Address (IA) is a 6-byte field that must be unique for each Ethernet port and each copy of the EEPROM image. The first three bytes are vendor specific. The value from this field is loaded into the Receive Address Register 0 (RAL0/RAH0).

The Ethernet address is loaded for LAN0 and bit 41 (8th MSB) is inverted for LAN1 (bit 0 byte 6 in the EEPROM = bit 8 in EEPROM word 2).

### 4.5.1.2 Initialization Control 1 (Word 0Ah)

This word read by the 82575 contains initialization values that:

- Set defaults for some internal registers.
- Enable or disable specific features.
- Determine which PCI configuration space values are loaded from the EEPROM.

**Table 6. Initialization Control 1 (Word 0Ah)**

Bit(s)	Name	Default	Description
15:12	Reserved	0000b	Reserved
11	FRCSPD	1b	Default setting for the <i>Force Speed</i> bit in the Device Control register (CTRL[11]). The hardware default value is 1b. 0b = Do not force. 1b = Force.
10	FD	1b	Default for duplex setting. Mapped to Device Control register bit 0. The hardware default value is 1b. 0b = Half duplex. 1b = Full duplex.
9	LRST	1b	Default setting for link reset (CTRL[3]). It should set to 0b for hardware to initiate Auto-Negotiation upon power up or assertion of a PCIe* reset without driver intervention. The hardware default value is 1b. 0b = Initiate auto-negotiation. 1b = Do not initiate auto-negotiation.
8:7	Reserved	00b	Reserved.



**Table 6. Initialization Control 1 (Word 0Ah)**

Bit(s)	Name	Default	Description
6	SDP_IDDQ_EN	0b	When set, SDP keeps their value and direction when the 82575 enters dynamic IDDQ mode. Otherwise, SDP moves to HighZ and pull up mode in dynamic IDDQ mode.
5	Deadlock Timeout Enable	1b	If set, a device granted access to the EEPROM that does not toggle the interface for more than 1 second might have the grant revoked. 0b = Disable. 1b - Enable.
4	ILOS	0b	Default setting for the Loss-of-Signal Polarity setting for CTRL[7]. The hardware default value is 0b.
3	Power MNG	1b	This bit defines the 82575 power management support: 0b = The power management registers set is read only. The 82575 does not execute a hardware transition to D3. <b>Note:</b> This setting is for testing purposes only. 1b = Full support for power management. For normal operation, this bit must be set to 1b.
2	Reserved	0b	Reserved.
1	Load Subsystem ID	1b	When this bit equals 1b, the 82575 loads its PCIe* Subsystem ID and Subsystem Vendor ID from the EEPROM words 0Bh and 0Ch. 0b = Do not load. 1b = Load.
0	Load Vendor/Device ID	1b	When this bit is set to 1b, the 82575 loads its PCIe* device ID from EEPROM words 0Dh, 11h, and 1Dh. 0b = Do not load. 1b = Load.

#### 4.5.1.3 Subsystem ID (Word 0Bh)

If the Load Subsystem IDs bit in the Initialization Control Word 1 (0Ah) is set, this word is used to initialize the Subsystem ID. Its default value is 0h.

#### 4.5.1.4 Subsystem Vendor ID (Word 0Ch)

If the Load Subsystem IDs bit in the Initialization Control Word 1 (0Ah) is set, this word is used to initialize the Subsystem Vendor ID. Its default value is 8086h.

#### 4.5.1.5 Device ID (Word 0Dh, 11h)

If the Load Device IDs bit in the Initialization Control Word 1 (0Ah) is set, this word is used to initialize the Device ID of LAN0 and LAN1 functions, respectively. Its default value is 10A7h.

#### 4.5.1.6 Dummy Device ID (Word 1Dh)

If the Load Device IDs in word 0Ah is set, this word is used to initialize the Device ID of dummy devices. Its default value is 10A6h

#### 4.5.1.7 Initialization Control 2 (Word 0Fh)

This is the second word read by the 82575 and contains additional initialization values that:



- Set defaults for some internal registers.
- Enable and disable specific features.

**Table 7. Initialization Control 2 (Word 0Fh)**

Bit(s)	Name	Default	Description
15	APM PME# Enable	0b	The <i>APM PME# Enable</i> bit represents the initial value of the Assert PME On APM Wakeup bit in the Wake Up Control Register (WUC.APMPME). 0b = Disable 1b = Enable
14	Reserved	0b	Reserved. Should be set to 0b.
13:12	Pause Capability	11b	These bits enable the desired PAUSE capability for the advertised configuration base page. Mapped to PCS_ANADV.ASM.
11	ANE	0b	This bit enables Auto-Negotiation and is mapped to PCS_LCTL.AN_ENABLE. 0b = Disable. 1b = Enable.
10:8	Flash Size Indication	000b	Requested flash Memory Space: 000b = 64 KB 001b = 128 KB 010b = 256 KB 011b = 512 KB 100b = 1 MB 101b = 2 MB 110b = 4 MB 111b = 8 MB
7	DMA Clock Gating Enable	1b	Enables automatic reduction of DMA and MAC frequency. Mapped to STATUS[31]. This bit is relevant only if the L1 indication enable is set. 0b = Disable. 1b = Enable.
6	PHY Power Down Enable	1b	This bit enables the PHY to power down. When it is set, the PHY can enter into a low power state. 0b = Disable. 1b = Enable.
5	Reserved	0b	Reserved.
4	CCM PLL Shutdown Enable	0b	When set, the CCM PLL can be shut down in low power states when the PHY is in power-down (link disconnect). When cleared, the CCM PLL is not shut down in a low-power state. 0b = Disable. 1b = Enable.
3	L1 Indication Enable	0b	When set, enables idle indication to the L1 mechanism. 0b = Disable. 1b = Enable.

**Table 7. Initialization Control 2 (Word 0Fh)**

Bit(s)	Name	Default	Description
2	SerDesLow Power Enable	0b	When this bit is set, the SerDes can enter a low power state when the function is in Dr state. This bit is mapped to CTRL_EXT[18].  0b = Disabled. 1b = Enabled.
1	Reserved	1b	Reserved. Should be set to 0b.
0	LPLU	1b	Low Power Link Up  Enables the decrease in link speed in non-D0a states when dictated by power policy and the power management state. This bit is loaded to each of the PHYs only when LAN0/1 OEM bits disable (word 23 bit 7/8) respectively, are cleared.  0b = Disable. 1b = Enable.

#### 4.5.1.8 Software Defined Pins Control (Word 10h)

This word configures initial settings for the Software Definable Pins.

**Note:** Word 10h is for LAN1.

**Table 8. Software Defined Pins Control (Word 10h)**

Bit(s)	Name	Default	Description
15	SDPDIR[3]	0b	SDP3 Pin - Initial Direction. This bit configures the initial hardware value of the <i>SDP3_IODIR</i> bit in the Extended Device Control (CTRL_EXT) register following power up.  0 = Input. 1b = Output. Set to 1b if not using SDP.
14	SDPDIR[2]	0b	SDP2 Pin - Initial Direction. This bit configures the initial hardware value of the <i>SDP2_IODIR</i> bit in the Extended Device Control (CTRL_EXT) register following power up.  0 = Input. 1b = Output. Set to 1b if not using SDP.
13	PHY_in_LAN_disable	0b	Determines the behavior of the MAC and PHY when a LAN port is disabled through an external pin.  0b = MAC and PHY maintain functionality while in LAN Disable (to support manageability). 1b = MAC and PHY are powered down in LAN Disable (manageability cannot access the network through this port).
12	Reserved	0b	Reserved. Should be set to 0b.
11	LAN_DIS	0b	LAN Disable. When this bit is set to 1b, the appropriate LAN is disabled.  0b = Enable. 1b = Disable.
10	LAN_PCI_DIS	0b	LAN PCI Disable. When this bit is set to 1b, the appropriate LAN PCI function is disabled. For example, the LAN is functional for MNG operation but is not connected to the host through PCIe*.  0b = Enable. 1b = Disable.



**Table 8. Software Defined Pins Control (Word 10h)**

Bit(s)	Name	Default	Description
9	SDPDIR[1]	0b	SDP1 Pin - Initial Direction. This bit configures the initial hardware value of the <i>SDP1_IODIR</i> bit in the Device Control (CTRL) register following power up.  0b = Input. 1b = Output. Set to 0b is not using SDP.
8	SDPDIR[0]	0b	SDP0 Pin - Initial Direction. This bit configures the initial hardware value of the <i>SDP00_IODIR</i> bit in the Device Control (CTRL) register following power up.  0b = Input. 1b = Output. Set to 0b is not using SDP.
7	SDPVAL[3]	0b	This bit holds the value of the SDP3 pin (Initial Output Value). It configures the initial power-on value output of SDP3 when it is configured as an output. This is accomplished by configuring the initial hardware value of the <i>SDP3_DATA</i> bit in the Extended Device Control (CTRL_EXT) register after power up.
6	SDPVAL[2]	0b	SDP2 Pin - Initial Output Value. This bit configures the initial power on value output of SDP2 (when it is configured as an output) by configuring the initial hardware value of the <i>SDP2_DATA</i> bit in the Extended Device Control (CTRL_EXT) register after power up.
5	WD_SDP0	0b	When set, SDP[0] is used as watchdog timeout indication. When reset, it is used as a Software Defined Pin (as per bits 8 and 0). This bit is mapped to <i>SDP0_WDE[21]</i> in the CTRL register.  0b = SDP0 is used normally as SDP. 1b = SDP0 is used as a watchdog timeout indication.
4	Gigabit Disable	0b	When this bit is set, the Gigabit Ethernet operation is disabled. An example of when this might be used is if Gigabit Ethernet operation exceeds system power limits. Software configures this bit only if the LAN1/LAN0 OEM Bit configuration disable (word 23h, bits 8:7) are cleared. Hardware does not use this bit.  0b = Enable. 1b = Disable.
3	Disable 1000 in non-D0a	0b	Disables 1000 Mb/s operation in non-D0a states. This bit is for software use. Hardware does not use this bit.  0b = Enable. 1b = Disable
2	D3COLD_WAKEUP_ADVEN	1b	Configures the initial hardware default value of the <i>ADV3WUC</i> bit in the Device Control register (CTRL) after power up.  0b = Advertised. 1b = Not advertised.
1	SDPVAL[1]	0b	SDP1 Pin - Initial Output Value. This bit configures the initial power on value output of SDP2 (when it is configured as an output) by configuring the initial hardware value of the <i>SDP1_DATA</i> bit in the Device Control (CTRL) register after power up.
0	SDPVAL[0]	0b	SDP0 Pin - Initial Output Value. This bit configures the initial power on value output of SDP2 (when it is configured as an output) by configuring the initial hardware value of the <i>SDP0_DATA</i> bit in the Device Control (CTRL) register after power up.

#### 4.5.1.9 EEPROM Sizing & Protected Fields (Word 12h)

Provides common power consumption and other indications about EEPROM size and protection.

**Note:** The software driver can only read this word. It has no write access to this word through the EEC and EERD registers. Write access is possible only through an authenticated firmware interface.

**Table 9. EEPROM Sizing & Protected Fields (Word 12h)**

Bit(s)	Name	Default	Description
15:14	Signature	01b	The Signature field indicates to the device that there is a valid EEPROM present. If the Signature field is not 01b, the other bits in this word are ignored, no further EEPROM read is performed and default values are used for the configuration space IDs.
13:10	EEPROM Size	0010b	These bits indicate the actual EEPROM size and are mapped to EEC[14:11]: 0000b = 128 bytes 0001b = 256 bytes 0010b = 512 bytes 0011b = 1 KB 0100b = 2 KB 0101b = 4 KB 0110b = 8 KB 0111b = 16 KB 1000b = 32 KB 1001b - 1011b = Reserved
9:5	Reserved	00000b	Reserved. Should be set to 00000b.
4	Enable EEPROM Protection	0b	If set, all EEPROM protection schemes are enabled.
3:0	HEPSize	0000b	T0000 = No hidden block 0001b = 2 bytes 0010b = 4 bytes 0011b = 8 bytes 0100b = 16 bytes 0101b = 32 bytes 0110b = 64 bytes 0111b = 128 bytes 1000b = 256 bytes 1001b = 512 bytes 1010b = 1 KB 1011b = 2 KB 1100b = 4 KB 1101b = 8 KB 1110b = 16 KB 1111b = 32 KB

#### 4.5.1.10 Initialization Control 3 (Word 14h, 24h)

This word controls general initialization values. Word 14h is used for LAN1. Word 24 is used for LAN0.



**Table 10. Initialization Control 3 (Word 14h and 24h High Byte)**

Bit(s)	Name	Default	Description
15	SerDes Energy Source	0b	SerDes Energy Source Detection When 0b, internal SerDes Rx electrical Idle indication. When 1b, external LOS signal. This bit also indicates the source of the signal detect while establishing a link in SerDes mode. This bit sets the default value of the CONNSW.ENRGSRC bit.
14	I2C SFP Enable	0b	I2C SFP Enable 0b = Disabled. When disabled, the I2C pads are isolated. 1b = Enabled. Used to set the default value of CTRL_EXT[25].
13	LAN Flash Disable	1b	A bit value of 1b disables the Flash logic. The Flash access BAR in the PCI Configuration space is disabled.
12:11	Interrupt Pin	0b for LAN 0 1b for LAN 1	This bit controls the value advertised in the <i>Interrupt Pin</i> field of the PCI Configuration header for this device and function. A value of 0b reflected in the <i>Interrupt Pin</i> field indicates that this device uses INTA#; a value of 1b indicates that this device uses INTB#. If only a single port of the 82575 is enabled, this value is ignored and the <i>Interrupt Pin</i> field of the enabled port reports INTA# usage. 0 = INT#A 1 = INT#B 2 = INT#C 3 = INT#D
10	APM Enable	1b	This field controls the initial value of Advanced Power Management Wake Up Enable in the Wake Up Control Register (WUC.APME) and is mapped to CTRL[6] and to WUC[0]. 0b = APM wakeup disabled. 1b = APM wakeup enable.
9:8	Link Mode	00b	This field controls the initial value of Link Mode bits of the Extended Device Control Register (CTRL_EXT.LINK_MODE), specifying which link interface and protocol is used by the MAC. 00b = MAC operates in 1000Base-T mode with the internal copper PHY. 01b = MAC operates using internal SerDes module (legacy). 10b = MAC operates in SGMII mode. 11b = MAC operates in internal SerDes mode (recommended).
7	Expansion BAR Enable	0b	Enable/disable Expansion ROM BAR 0b = Enable. 1b = Disable.
6:5	Reserved	-	Reserved.
4:2	Reserved	000b	Reserved.
1	Ext_VLAN	0b	Sets the default for CTRL_EXT[26] bit. Indicates that additional VLAN is expected in the system. 1b = Expect additional VLAN in all packets. 0b = Don't expect additional VLAN.
0	Keep_PHY_Link_Up_En	0b	Enables No PHY Reset when the BMC indicates that the PHY should be kept on. When asserted, this bit prevents the PHY reset signal and the power changes reflected to the PHY according to the MANC.Keep_PHY_Link_Up value. This bit should be set to the same value at both words (14h, 24h) to reflect the same option to both LANs. 1b = Enable. 0b = Disable.



The description of bits 13 and 11 in various combinations are as follows:

Flash Disable (Bit 13)	Boot Disable (Bit 11)	Functionality (Active Windows)
0b	0b	Flash and Expansion ROM Bars are active.
0b	1b	Flash BAR is enabled and Expansion ROM BAR is disabled.
1b	0b	Flash BAR is disabled and Expansion ROM BAR is enabled.
1b	1b	Flash and Expansion ROM BARs are disabled.

#### 4.5.1.11 NC-SI and PCIe\* Completion Timeout Configuration (Word 15h)

Table 11. NC-SI and PCIe\* Completion Timeout Configuration (Word 15h)

Bit(s)	Name	Default	Description
15	NC-SI Clock Pad Drive Strength	0b	Defines the driving strength of the NC-SI_CLK_OUT pad.
14	NC-SI Data Pad Drive Strength	0b	Defines the drive strength of the NC-SI_DV & NC-SI_RXD pads.
13	NC-SI Output Clock Disable	0b	<p>If set, the clock source is external. In this case, the NC-SI_CLK_OUT pad is kept stable at zero and the NC-SI_CLK_IN pad is used as an input source of the clock.</p> <p>If cleared, the 82575 outputs the NC-SI clock through the NC-SI_CLK_OUT pad. The NC-SI_CLK_IN pad is still used as an NC-SI clock input.</p> <p>If NC-SI is not used, then this bit is set.</p> <p>If this bit is cleared, the Device Dr Power Down Enable in word 0Fh should not be set.</p> <p>0b = Output clock enabled. 1b = Output clock enable.</p>
12:8	Reserved	-	Reserved.
7	Completion Timeout Disable	0b	<p>This bit is loaded into the GCR.Completion_Timeout_Disable bit.</p> <p>0b = Completion timeout enabled. 1b = Completion timeout disabled.</p>
6:5	Completion Timeout Value	00b	<p>These bits are loaded into the GCR.Completion_Timeout_Value bit.</p> <p>00b = 50 <math>\mu</math>s - 10 ms. 01b = 10 ms - 200 ms. 10b = 200 ms - 4 s. 11b = 4 s - 64 s.</p>
4	Completion Timeout Resend	1b	<p>This bit is loaded into the GCR.Completion_Timeout_Resend bit.</p> <p>0b = Do not resend request on completion timeout. 1b = Resend request on completion timeout.</p>
3:0	Reserved	0000b	Reserved.



### 4.5.1.12 MSI-X Configuration (Word 16h)

**Table 12. MSI-X Configuration (Word 16h)**

Bit(s)	Name	Default	Description
15:12	MSI-X0_N	9h	This field specifies the number of entries in MSI-X tables of LAN 0. The range is 0-15. MSI_X_N is equal to the number of entries minus one.
11:8	MSI-X1_N	9h	This field specifies the number of entries in MSI-X tables of LAN 0. The range is 0-15. MSI_X_N is equal to the number of entries minus one.
7:5	Reserved	-	Reserved.
4:0	PCIE_EIDLE_DLY	0h	PCIE* Electrical Idle Delay Delay cycles before entering electrical idle to allow a data path flush.

### 4.5.1.13 PLL/Lane/PHY Initialization Pointer (Word 17h)

Bit(s)	Name	Default	Description
15:0			PLL/Lane/PHY Initialization Pointer

### 4.5.1.14 PCIe\* Initialization Configuration 1 (Word 18h)

This field sets default values for some internal registers and enables or disables specific features.

**Table 13. PCIe\* Initialization Configuration 1 (Word 18h)**

Bit(s)	Name	Default	Description
15	Reserved	0b	Reserved. Should be set to 0b.
14:12	L1 Act Exit Latency	110b	This field represents the L1 active exit latency for the configuration space. When it is set to 110b, the latency range is 32 $\mu$ s to 64 $\mu$ s.
11:9	L1 Act Accept Latency	110b	This field represents the L1 active acceptable latency for the configuration space. When it is set to 110b, the acceptable latency range is 32 $\mu$ s to 64 $\mu$ s.
8:6	L0s Accept Latency	011b	This field represents the L0s acceptable latency for the configuration space. When it is set to 011b, the acceptable latency is 512 ns.
5:3	L0s Separated Exit Latency	001b	This field represents the L0s exit latency for active state power management with a separated reference clock. When it is set to 001b, the latency range is between 64 ns and 128 ns.
2:0	L0s Common Exit Latency	001b	This field represents the L0s exit latency for active state power management with a common reference clock. When it is set to 001b, the latency range is between 64 ns and 128 ns.

### 4.5.1.15 PCIe\* Initialization Configuration 2 (Word 19h)

This word sets default values for some internal registers.



**Table 14. PCIe\* Initialization Configuration 2 (Word 19h)**

Bit(s)	Name	Default	Description
15	DLLP Timer Enable	0b	When it is set to 1b, the DLLP timer counter is enabled. 0b = Disable. 1b = Enable.
14	Reserved	0b	Reserved.
13	Reserved	0b	Reserved.
12	Serial Number Capabilit y	1b	Serial Number Capability Enable. Should be set to 1b.
11:8	Extra NFTS	0000b	Extra NFTS (Number of Fast Training Signal) that is added to the original requested number of NFTS (as requested by the upstream component).
7:0	NFTS	50h	This field identifies the number of special sequences for L0s transition to L0.

#### 4.5.1.16 Software Defined Pins Control (Word 20h)

This configures initial settings for the Software Definable Pins.

**Note:** Word 20h is for LAN0.

**Table 15. Software Defined Pins Control (Word 20h)**

Bit(s)	Name	Default	Description
15	SDPDIR[3]	0b	SDP3 Pin - Initial Direction. This bit configures the initial hardware value of the <i>SDP3_IODIR</i> bit in the Extended Device Control (CTRL_EXT) register following power up. 0b = Input. 1b = Output. Set to 1b if not using SDP.
14	SDPDIR[2]	0b	SDP2 Pin - Initial Direction. This bit configures the initial hardware value of the <i>SDP2_IODIR</i> bit in the Extended Device Control (CTRL_EXT) register following power up. 0b = Input. 1b = Output. Set to 1b if not using SDP.
13	PHY_in_ LAN_ disable	0b	Determines the behavior of the MAC and PHY when a LAN port is disabled through an external pin. 0b = MAC and PHY maintain functionality while in LAN Disable (to support manageability). 1b = MAC and PHY are powered down in LAN Disable (manageability cannot access the network through this port).
12:10	Reserved	000b	Reserved. Should be set to 000b.
9	SDPDIR[1]	0b	SDP1 Pin - Initial Direction. This bit configures the initial hardware value of the <i>SDP1_IODIR</i> bit in the Device Control (CTRL) register following power up. 0b = Input. 1b = Output. Set to 0b if not using SDP.

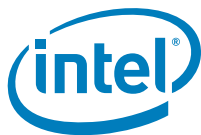

Table 15. Software Defined Pins Control (Word 20h)

Bit(s)	Name	Default	Description
8	SDPDIR[0]	0b	SDP0 Pin - Initial Direction. This bit configures the initial hardware value of the <i>SDP00_IODIR</i> bit in the Device Control (CTRL) register following power up.  0b = Input. 1b = Output.  Set to 1b if not using SDP.
7	SDPVAL[3]	0b	This bit holds the value of the SDP3 pin (Initial Output Value). It configures the initial power-on value output of SDP3 when it is configured as an output. This is accomplished by configuring the initial hardware value of the <i>SDP3_DATA</i> bit in the Extended Device Control (CTRL_EXT) register after power up.
6	SDPVAL[2]	0b	SDP2 Pin - Initial Output Value. This bit configures the initial power on value output of SDP2 (when it is configured as an output) by configuring the initial hardware value of the <i>SDP2_DATA</i> bit in the Extended Device Control (CTRL_EXT) register after power up.
5	WD_SDP0	0b	When set, SDP[0] is used as watchdog timeout indication. When reset, it is used as a Software Defined Pin (as per bits 8 and 0). This bit is mapped to <i>SDP0_WDE[21]</i> in the CTRL register.  0b = SDP0 is used normally as SDP. 1b = SDP0 is used as a watchdog timeout indication.
4	Gigabit Disable	0b	When this bit is set, the Gigabit Ethernet operation is disabled. An example of when this might be used is if Gigabit Ethernet operation exceeds system power limits. Software configures this bit only if the LAN1/LAN0 OEM Bit configuration disable (word 23h, bits 8:7) are cleared. Hardware does not use this bit.  0b = Enable. 1b = Disable.
3	Disable 1000 in non-D0a	0b	Disables 1000 Mb/s operation in non-D0a states. This bit is for software use. Hardware does not use this bit.  0b = Enable. 1b = Disable.
2	D3COLD_WAKEUP_ADVEN	1b	Configures the initial hardware default value of the <i>ADV3WUC</i> bit in the Device Control register (CTRL) after power up.  0b = Advertised. 1b = Not advertised.
1	SDPVAL[1]	0b	SDP1 Pin - Initial Output Value. This bit configures the initial power on value output of SDP2 (when it is configured as an output) by configuring the initial hardware value of the <i>SDP1_DATA</i> bit in the Device Control (CTRL) register after power up.
0	SDPVAL[0]	0b	SDP0 Pin - Initial Output Value. This bit configures the initial power on value output of SDP2 (when it is configured as an output) by configuring the initial hardware value of the <i>SDP0_DATA</i> bit in the Device Control (CTRL) register after power up.

#### 4.5.1.17 PCIe\* Initialization Configuration 3 (Word 1Ah)

This word sets default values for some internal registers.



Table 16. PCIe\* Initialization Configuration 3 (Word 1Ah)

Bit(s)	Name	Default	Description
15	Master Enable	1b	When this bit is set to 1b, the PHY can act as a master (upstream component with cross link functionality). 0b = Disable. 1b = Enable.
14	Scramble Disable	0b	When this bit is set to 1b, the PCIe* LFSR scrambling feature is disabled. 0b = Enable. 1b = Disable.
13	Ack/Nak Scheme	0b	This field identifies the acknowledgement/no acknowledgement scheme for the 82575. 0b = Scheduled for transmission following any TLP. 1b = Scheduled for transmission according to time-outs specified in the PCIe* specification.
12	Cache Line Size	0b	This bit represents the cache line size. 0b = 64 bytes. 1b = 128 bytes. <b>Note:</b> The value loaded must be equal to the actual cache line size used by the platform as configured by system software.
11:10	GIO Capability	01b	PCIe* Capability Version The value of this field is reflected in the two LSBs of the capability version in the PCIe* CAP register (configuration space - A2h). Note that this is not the PCIe* version. It is the PCIe* capability version. This version is a field in the PCIe* capability structure and is not the same as the PCIe* version. It changes only when the content of the capability structure changes. For example, PCIe* 1.0, 1.0a and 1.1 all have a capability version of 1. PCIe* 2.0 has a version 2 because it added registers to the capabilities structures.
9	IO Support	1b	This bit represents the status of I/O support (I/O BAR request). When it is set to 1b, I/O is supported. 0b = Not supported. 1b = Supported.
8	Max Packet Size	1b	This bit identifies the status of the default packet size. 0b = 128 bytes. 1b = 256 bytes.
7:6	Lane Width	10b	This field identifies the maximum link width. 00b = 1 lane. 01b = 2 lanes. 10b = 4 lanes. 11b = Reserved.
5	Elastic Buffer Diff1	0b	When this bit is set to 1b, the elastic buffers are activated in a more limited mode (read and write pointers).
4	Elastic Buffer Control	0b	When this bit equals 1b, the elastic buffers operate under phase-only mode during electrical idle states.



**Table 16. PCIe\* Initialization Configuration 3 (Word 1Ah)**

Bit(s)	Name	Default	Description
3:2	Active State PM Support	11b	This field determines support for Active State Link Power Management. It is loaded into the PCIe* Active State Link PM Support register. 00b = Reserved. 01b = L0s entry supported. 10b = Reserved. 11b = L0s and L1 supported.
1	Slot Clock Cfg	1b	When this bit is set, the 82575 uses the PCIe* reference clock supplied on the connector. This is primarily used for add-in solutions.
0	Loopback Polarity Inversion	0b	This field verifies the polarity inversion in loopback master entry.

#### 4.5.1.18 PCIe\* Control (Word 1Bh)

This word configures initial settings for the PCIe\* default functionality.

**Table 17. PCIe\* Control (Word 1Bh)**

Bit(s)	Name	Default	Description
15	Reserved	0b	Reserved.
14	Dummy Function Enable	0b	Dummy Function Enable 0b = Disabled function 0 is replace with function 1. 1b = Disabled function 0 is replaced with dummy function.
13	GIO Down Reset Disable	0b	This bit disables a core reset when the PCIe* link goes down. 0b = Enable. 1b = Disable.
12	Lane Reversal Disable	0b	This bit disables the ability to negotiate lane reversal. 0b = Enable. 1b = Disable.
11	Good Recovery	0b	When set to 1b, the LTSSM Recovery states always progresses towards LinkUp (force a good recovery, when a recovery occurs). 0b = Normal mode.
10	Reserved	1b	Reserved. Should always be set to 1b. 0b - Enable. 1b = Disable.
9:7	Reserved	000b	Reserved. Always set to 000b.
6	GIO TS Retrain Mode	0b	This bit controls the condition of LTSSM entry to recovery. 0b = Normal mode. 1b = Special mode.
5	L2 Disable	0b	This bit disables the link from entering L2 state. 0b = Enable. 1b = Disable.
4	Skip Disable	0b	This bit disables the SKIP symbol insertion in the elastic buffer. 0b = Enable. 1b = Disable.



Table 17. PCIe\* Control (Word 1Bh)

Bit(s)	Name	Default	Description
3	Reserved	0b	Reserved.
2	Electrical Idle	0b	Electrical Idle Mask. When set to 1b, disables the check for illegal electrical idle sequence (for example, idle ordered set without common mode and vice versa). Also excepts any of them as a correct idle sequence.  0b = Enable. 1b = Disable  <b>Note:</b> Specification can be interpreted so that the idle ordered set is sufficient for transition to power management states. The use of this bit allows an exception for such interpretation and avoids the possibility of correct behavior being understood as illegal sequences.
1:0	Latency to Enter L1	11b	These bits identify the period in L0s state before transitioning into an L1 state.  00b = 64 $\mu$ s 01b = 256 $\mu$ s 10b = 1 ms 11b = 4 ms

#### 4.5.1.19 LED 1, 3 Configuration Defaults (Word 1Ch)

This EEPROM word specifies the hardware defaults for the LEDCTL register fields controlling the LED1 (ACTIVITY indication) and LED3 (LINK\_1000 indication) output behaviors.

Table 18. LED 1-3 Configuration Defaults (Word 1Ch)

Bit(s)	Name	Default	Description
15	LED3 Blink	0b	This bit represents the initial value of the LED3_BLINK field. If it equals 0b, the LED is non-blinking.
14	LED3 Invert	0b	This bit represents the initial value of the LED3_IVRT field. If it equals 0b, it is an active low output.
13	Reserved	0b <sup>1</sup>	Reserved.
12	Reserved	0b	This bit is reserved and should be set to 0b.
11:8	LED3 Mode	0111b	This field represents the initial value of the LED3_MODE specifying the event, state, and pattern displayed on the LED3 (LINK_1000) output. A value of 0111b (or 7h) causes this to indicate 1000 Mb/s operation. See Table 19 for all available LED modes.
7	LED1 Blink	1b	This field holds the initial value of LED1_BLINK field and is equal to 0b for non-blinking.
6	LED1 Invert	0b	This field holds the initial value of LED1_IVRT field and is equal to 0b for an active low output.
5	Reserved	0b <sup>a</sup>	Reserved.
4	Reserved	0b	This bit is reserved and should be set to 0b.
3:0	LED1 Mode	0011b	This field represents the initial value of the LED1_MODE specifying the event, state, and pattern displayed on the LED1 (ACTIVITY) output. A value of 0011b (3h) causes this to indicate ACTIVITY state. See Table 19 for all available LED modes.

1. These bits are read from the EEPROM.

**Note:** A value of 0703h is used to configure default hardware LED behavior equivalent to 82544-based copper Ethernet controllers (LED0=LINK\_UP, LED1=blinking ACTIVITY, LED2=LINK\_100, and LED3=LINK\_1000).



**Table 19. LED Mode**

Mode	Selected Mode	Source Indication
0000b	LINK_10/1000	Asserted when either 10 or 1000 Mb/s link is established and maintained.
0001b	LINK_100/1000	Asserted when either 100 or 1000 Mb/s link is established and maintained.
0010b	LINK_UP	Asserted when any speed link is established and maintained.
0011b	FILTER_ACTIVITY	Asserted when link is established and packets are being transmitted or received that passed MAC filtering.
0100b	LINK/ACTIVITY	Asserted when link is established and when there is no transmit or receive activity.
0101b	LINK_10	Asserted when a 10 Mb/s link is established and maintained.
0110b	LINK_100	Asserted when a 100 Mb/s link is established and maintained.
0111b	LINK_1000	Asserted when a 1000 Mb/s link is established and maintained.
1000b	SDP_MODE	LED activation is a reflection of the SDP signal. SDP0, SDP1, SDP2, SDP3 are reflected to LED0, LED1, LED2, LED3 respectively.
1001b	FULL_DUPLEX	Asserted when the link is configured for full duplex operation (de-asserted in half-duplex).
1010b	COLLISION	Asserted when a collision is observed.
1011b	ACTIVITY	Asserted when link is established and packets are being transmitted or received.
1100b	BUS_SIZE	Asserted when the 82575 detects a 1-lane PCIe* connection.
1101b	PAUSED	Asserted when the 82575's transmitter is flow controlled.
1110b	LED_ON	Always high (Asserted)
1111b	LED_OFF	Always low (De-asserted)

#### 4.5.1.20 Device Revision ID (Word 1Eh)

**Table 20. Device Revision ID (Word 1Eh)**

Bit(s)	Name	Default	Description
15	DEV_OFF_EN	0b	When set, enables the 82575 to enter power down. 0b = Disable. 1b = Enable.
14	Reserved	1b	Reserved.
13	Reserved	0b	Reserved.
12	LAN 1 iSCSI Enable	0b	When set, LAN 1 class code is set to 010000h (SCSI) When reset, LAN 1 class code is set to 020000h (LAN)
11	LAN 0 iSCSI Enable	0b	When set, LAN 0 class code is set to 010000h (SCSI) When reset, LAN 0 class code is set to 020000h (LAN)
10:8	Reserved	0h	Reserved.
7:0	Device Revision ID	00h	Device Revision ID.

#### 4.5.1.21 LED 0, 2 Configuration Defaults (Word 1Fh)

This EEPROM word specifies the hardware defaults for the LEDCTL register fields controlling the LED0



(LINK\_UP) and LED2 (LINK\_100) output behaviors

**Table 21. LED 0-2 Configuration Defaults (Word 1Fh)**

Bit(s)	Name	Default	Description
15	LED2 Blink	0b	This bit represents the initial value of the LED2_BLINK field. If it equals 0b, the LED is non-blinking.
14	LED2 Invert	0b	This bit represents the initial value of the LED2_IVRT field. If it equals 0b, it is an active low output.
13	Reserved	0b <sup>1</sup>	Reserved.
12	Reserved	0b	This bit is reserved and should be set to 0b.
11:8	LED2 Mode	0110b	This field represents the initial value of the LED2_MODE specifying the event, state, and pattern displayed on the LED2 (LINK_1000) output. A value of 0110b (or 6h) causes this to indicate 100 Mb/s operation. See <a href="#">Table 19</a> for all available LED modes.
7	LED0 Blink	0b	This field holds the initial value of LED0_BLINK field and is equal to 0b for non-blinking.
6	LED0 Invert	0b	This field holds the initial value of LED0_IVRT field and is equal to 0b for an active low output.
5	Global Blink Mode	0b <sup>a</sup>	Global Blink Mode 0b = Blink at 200 ms on and 200ms off. 1b = Blink at 83 ms on and 83 ms off.
4	Reserved	0b	This bit is reserved and should be set to 0b.
3:0	LED0 Mode	0010b	This field represents the initial value of the LED0_MODE specifying the event, state, and pattern displayed on the LED0 (ACTIVITY) output. A value of 0010b (2h) causes this to indicate link up state. See <a href="#">Table 19</a> for all available LED modes.

1. These bits are read from the EEPROM.

**Note:** A value of 0602h is used to configure default hardware LED behavior equivalent to 82544-based copper 82575s (LED0=LINK\_UP, LED1=blinking ACTIVITY, LED2=LINK\_100, and LED3=LINK\_1000).



### 4.5.1.22 Functions Control (Word 21h)

Table 22. Functions Control (Word 21h)

Bit(s)	Name	Default	Description
15:13	Reserved	000b	Reserved.
12	LAN Function Select	0b	When both LAN ports are enabled and the LAN function select equals 0b, LAN 0 is routed to PCI function 0 and LAN 1 is routed to PCI function 1. If the LAN function select bit equals 1b, LAN 0 is routed to PCI function 1 and LAN 1 is routed to PCI function 0. This bit is mapped to FACTPS[30].
11:0	Reserved	0h	Reserved.

### 4.5.1.23 LAN Power Consumption (Word 22h)

This word is meaningful only if the EEPROM signature in word 0Ah is valid and Power Management is enabled.

Table 23. LAN Power Consumption (Word 22h)

Bit(s)	Name	Default	Description
15:8	LAN D0 Power	0h	The value in this field is reflected in the PCI Power Management Data Register of the LAN functions for D0 power consumption and dissipation (Data_Select = 0 or 4). Power is defined in 100 mW units and includes the external logic required for the LAN function.
7:5	Function 0 Common Power	0h	The value in this field is reflected in the PCI Power Management Data Register of function 0 when the Data_Select field is set to 8 (common function). The most significant bits in the Data Register that reflect the power values are padded with zeros.
4:0	LAN D3 Power	0h	The value in this field is reflected in the PCI Power Management Data Register of the LAN functions for D3 power consumption and dissipation (Data_Select = 3 or 7). Power is defined in 100 mW units and includes the external logic required for the LAN function. The most significant bits in the Data Register that reflect the power values are padded with zeros.

### 4.5.1.24 Management Hardware Configuration Control (Word 23h)

This word contains bits that direct special firmware behavior when configuring the PHY/PCIe\*/SerDes.

Bit	Name	Description
15	LAN1_FT_CO_DIS	LAN1 force TCO reset disable (1 disable, 0 enable).
14	LAN0_FT_CO_DIS	LAN0 force TCO reset disable (1 disable, 0 enable).
13:1 0	Reserved	Reserved.
9	Firmware Code Exist	If set, indicates to the firmware that there is firmware EEPROM code at address 50h.
8	LAN1_OEM_DIS	LAN1 OEM bits configuration disable. 0b = Enable. 1b = Disable.
7	LAN0_OEM_DIS	LAN0 OEM bits configuration disable. 0b = Enable. 1b = Disable.



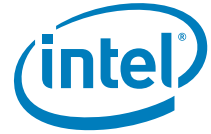

6	CRC_DIS	PHY / SERDES / PCIe* CRC disable. 0b = Enable. 1b = Disable.
5	LAN1_ROM_DIS	LAN1 ROM Disable Disables PHY and SerDes ROM configuration for port 1. 0b = Enable. 1b = Disable.
4	LAN0_ROM_DIS	LAN0 ROM Disable Disables PHY and SerDes ROM configuration for port 0. 0b = Enable. 1b = Disable.
3	MNG_wake_check_dis	When set, indicates that the firmware is always to configure the PHY after power-up without checking that manageability or wake-up are enabled. 0b = Enable. 1b = Disable.
2	PCIe* ROM Disable	When set, indicates that the firmware is not to configure the PCIe* from the ROM tables. 0b = Enable. 1b = Disable.
1	PHY ROM Disable	When set, indicates that the firmware is not to configure the PHY of both ports from the ROM tables. 0b = Enable. 1b = Disable.
0	SERDES ROM Disable	When set, indicates that the firmware is not to configure the SerDes of both ports from the ROM tables. 0b = Enable. 1b = Disable.

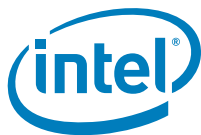

### 4.5.1.25 End of RO Area (Word 2Ch)

Table 24. End of RO Area (Word 2Ch)

Bit(s)	Name	Default	Description
15	Reserved	0b	Reserved.
14:0	EORO_ area	0h	Defines the end of the area in the EEPROM that is RO. The resolution is one word and can be up to byte address FFFFh (7FFFh words). A value of zero indicates no RO area.

### 4.5.1.26 Start of RO Area (Word 2Dh)

Table 25. Start of RO Area (Word 2Dh)

Bit(s)	Name	Default	Description
15	Reserved	0b	Reserved.
14:0	SORO_ area	0h	Defines the start of the area in the EEPROM that is RO. The resolution is one word and can be up to byte address FFFFh (7FFFh words). Should be smaller or equal to Word 2Ch.

### 4.5.1.27 Watchdog Configuration (Word 2Eh)

Table 26. Watchdog Configuration (Word 2Eh)

Bit(s)	Name	Default	Description
15	Watchdog Enable	0b	Enable watchdog interrupt.
14:11	Watchdog Timeout	2h	Watchdog timeout period (in seconds).
10:0	Reserved	-	Reserved.

### 4.5.1.28 VPD Pointer (Word 2Fh)

This word points to the Vital Product Data (VPD) structure. This structure is available for the NIC/LOM vendor to store its own data.

### 4.5.1.29 PXE Words (Words 30h:3Eh)

Words 30h through 3Eh have been reserved for configuration and version values to be used by PXE code. The only exception is word 3Dh. 3Dh is used for iSCSI boot configuration.

#### 4.5.1.29.1 Main Setup Options PCI Function 0 (Word 30h)



The main setup options are stored in word 30h. These options are those that can be changed by the user via the Control-S setup menu. Word 30h has the following format:

Bit(s)	Name	Default	Description
15:13	RFU	0x0	Reserved. Must be 0.
12:10	FSD	0x0	Bits 12-10 control forcing speed and duplex during driver operation. Valid values are: 000b – Auto-negotiate 001b – 10Mbps Half Duplex 010b – 100Mbps Half Duplex 011b – Not valid (treated as 000b) 100b – 10Mbps Full Duplex 101b – 100Mbps Full Duplex 111b – 1000Mbps Full Duplex <b>Only applicable for copper-based adapters. Not applicable to 10GbE.</b> Default value is 000b.
9	RSV	0b	Reserved. Set to 0.
8	DSM	1b	Display Setup Message. If the bit is set to 1, the Press Control-S message is displayed after the title message. Default value is 1.
7:6	PT	0x0	Prompt Time. These bits control how long the CTRL-S setup prompt message is displayed, if enabled by DIM. 00 = 2 seconds (default) 01 = 3 seconds 10 = 5 seconds 11 = 0 seconds Note: CTRL-S message is not displayed if 0 seconds prompt time is selected.
5	IBD	0b	iSCSI Boot Disable.
4:3	DBS	0b	Default Boot Selection. These bits select which device is the default boot device. These bits are only used if the agent detects that the BIOS does not support boot order selection or if the MODE field of word 31h is set to MODE_LEGACY. 00 = Network boot, then local boot (default) 01 = Local boot, then network boot 10 = Network boot only 11 = Local boot only
2	DEP	0b	Deprecated. Must be 0.
1:0	PS	0x0	Protocol Select. These bits select the active boot protocol. 00 = PXE (default value) 01 = RPL (only if RPL is in the flash) 10 = iSCSI Boot primary port (only if iSCSI Boot is using this adapter) 11 = iSCSI Boot secondary port (only if iSCSI Boot is using this adapter) Only the default value of 00b should be initially programmed into the adapter; other values should only be set by configuration utilities.



#### 4.5.1.29.2 Configuration Customization Options PCI Function 0 (Word 31h)

Word 31h of the EEPROM contains settings that can be programmed by an OEM or network administrator to customize the operation of the software. These settings cannot be changed from within the Control-S setup menu. The lower byte contains settings that would typically be configured by a network administrator using an external utility; these settings generally control which setup menu options are changeable. The upper byte is generally settings that would be used by an OEM to control the operation of the agent in a LOM environment, although there is nothing in the agent to prevent their use on a NIC implementation. The default value for this word is 4000h.

Bit(s)	Name	Default	Function
15:14	SIG	0x1	Signature. Must be set to 01 to indicate that this word has been programmed by the agent or other configuration software.
13	RFU	0b	Reserved. Must be 0.
12	RFU	0b	Reserved. Must be 0.
11	RETRY	0b	Selects Continuous Retry operation.  If this bit is set, IBA will NOT transfer control back to the BIOS if it fails to boot due to a network error (such as failure to receive DHCP replies). Instead, it will restart the PXE boot process again. If this bit is set, the only way to cancel PXE boot is for the user to press ESC on the keyboard. Retry will not be attempted due to hardware conditions such as an invalid EEPROM checksum or failing to establish link.  Default value is 0.
10:8	MODE	0b	Selects the agent's boot order setup mode.  This field changes the agent's default behavior in order to make it compatible with systems that do not completely support the BBS and PnP Expansion ROM standards. Valid values and their meanings are:  000b - Normal behavior. The agent will attempt to detect BBS and PnP Expansion ROM support as it normally does.  001b - Force Legacy mode. The agent will not attempt to detect BBS or PnP Expansion ROM supports in the BIOS and will assume the BIOS is not compliant. The user can change the BIOS boot order in the Setup Menu.  010b - Force BBS mode. The agent will assume the BIOS is BBS-compliant, even though it may not be detected as such by the agent's detection code. The user can NOT change the BIOS boot order in the Setup Menu.  011b - Force PnP Int18 mode. The agent will assume the BIOS allows boot order setup for PnP Expansion ROMs and will hook interrupt 18h (to inform the BIOS that the agent is a bootable device) in addition to registering as a BBS IPL device. The user can NOT change the BIOS boot order in the Setup Menu.  100b - Force PnP Int19 mode. The agent will assume the BIOS allows boot order setup for PnP Expansion ROMs and will hook interrupt 19h (to inform the BIOS that the agent is a bootable device) in addition to registering as a BBS IPL device. The user can NOT change the BIOS boot order in the Setup Menu.  101b - Reserved for future use. If specified, is treated as a value of 000b.  110b - Reserved for future use. If specified, is treated as a value of 000b.  111b - Reserved for future use. If specified, is treated as a value of 000b.
7	RFU	0b	Reserved. Must be 0.
6	RFU	0b	Reserved. Must be 0.
5	DFU	0b	Disable Flash Update.  If this bit is set to 1, the user is not allowed to update the flash image using PROSet. Default value is 0.



4	DLWS	0b	Disable Legacy Wakeup Support. If this bit is set to 1, the user is not allowed to change the Legacy OS Wakeup Support menu option. Default value is 0.
3	DBS	0b	Disable Boot Selection. If this bit is set to 1, the user is not allowed to change the boot order menu option. Default value is 0.
2	DPS	0b	Disable Protocol Select. If set to 1, the user is not allowed to change the boot protocol. Default value is 0.
1	DTM	0b	Disable Title Message. If this bit is set to 1, the title message displaying the version of the Boot Agent is suppressed; the Control-S message is also suppressed. This is for OEMs who do not wish the boot agent to display any messages at system boot. Default value is 0.
0	DSM	0b	Disable Setup Menu. If this bit is set to 1, the user is not allowed to invoke the setup menu by pressing Control-S. In this case, the EEPROM may only be changed via an external program. Default value is 0.

#### 4.5.1.29.3 PXE Version (Word 32h)

Word 32h of the EEPROM is used to store the version of the boot agent that is stored in the flash image. When the Boot Agent loads, it can check this value to determine if any first-time configuration needs to be performed. The agent then updates this word with its version. Some diagnostic tools to report the version of the Boot Agent in the flash also read this word. The format of this word is:

Bit(s)	Name	Hardware Default	Function
15 - 12	MAJ	0x0	PXE Boot Agent Major Version. Default value is 0.
11 - 8	MIN	0x0	PXE Boot Agent Minor Version. Default value is 0.
7 - 0	BLD	0x0	PXE Boot Agent Build Number. Default value is 0.

#### 4.5.1.29.4 IBA Capabilities (Word 33h)

Word 33h of the EEPROM is used to enumerate the boot technologies that have been programmed into the flash. This is updated by flash configuration tools and is not updated or read by IBA.

Bit(s)	Name	Default	Function
15 - 14	SIG	0x1	Signature. Must be set to 01 to indicate that this word has been programmed by the agent or other configuration software.
13 - 5	RFU	0b	Reserved. Must be 0.
4	ISCSI	0b	iSCSI Boot is present in flash if set to 1.
3	EFI	0b	EFI UNDI driver is present in flash if set to 1.
2	Reserved	0b	Set to 0.
1	UNDI	0b	PXE UNDI driver is present in flash if set to 1.
0	BC	0b	PXE Base Code is present in flash if set to 1.

#### 4.5.1.29.5 Setup Options PCI Function 1 (Word 34h)

This word is the same as word 30h, but for function 1 of the device.

**4.5.1.29.6 Configuration Customization Options PCI Function 1 (Word 35h)**

This word is the same as word 31h, but for function 1 of the device.

**4.5.1.29.7 iSCSI Option ROM Version (Word 36h)**

Word 0x36 of the NVM is used to store the version of iSCSI Option ROM updated as the same format as PXE Version at Word 0x32. The value must be above 0x2000 and the value below (word 0x1FFF = 16 KB NVM size) is reserved. iSCSIUtil, FLAUtil, DMiX update iSCSI Option ROM version if the value is above 0x2000, 0x0000, or 0xFFFF. The value (0x0040 - 0x1FFF) should be kept and not be overwritten.

**4.5.1.29.8 Alternate MAC Address Pointer (Word 37h)**

This word may point to a location in the EEPROM containing additional MAC addresses used by system management functions. If the additional MAC addresses are not supported, the word shall be set to 0xFFFF

**4.5.1.29.9 Setup Options PCI Function 2 (Word 38h)**

This word is the same as word 30h, but for function 2 of the device.

**4.5.1.29.10 Configuration Customization Options PCI Function 2 (Word 39h)**

This word is the same as word 31h, but for function 2 of the device.

**4.5.1.29.11 Setup Options PCI Function 3 (Word 3Ah)**

This word is the same as word 30h, but for function 3 of the device.

**4.5.1.29.12 Configuration Customization Options PCI Function 3 (Word 3Bh)**

This word is the same as word 31h, but for function 3 of the device.

**4.5.1.29.13 iSCSI Boot Configuration Offset (Word 3Dh)**

Bit	Name	Description
15:0	Offset	Defines the offset in EEPROM where the iSCSI boot configuration structure starts.

**4.5.1.29.13.1 iSCSI Module Structure**

Configuration Item	Size in Bytes	Comments
iSCSI Boot Signature	2	'Y', 'S'
iSCSI Block Size	2	Total byte size of the iSCSI configuration block
Structure Version	1	Version of this structure. Should be set to 1.
Reserved	1	Reserved for future use.
Initiator Name	255 + 1	iSCSI initiator name. This field is optional and built by manual input, DHCP host name, or with MAC address as defined in section 4.4.



Reserved	34	Reserved for future use.
BELOW FIELDS ARE PER PORT.		
Flags	2	<p><b>Bit 00h → Enable DHCP</b>  0 – Use static configurations from this structure  1 – Overrides configurations retrieved from DHCP.</p> <p><b>Bit 01h → Enable DHCP for getting iSCSI target information.</b>  0 – Use static target configuration  1 – Use DHCP to get target information by the Option 17 Root Path.</p>
		<p><b>Bit 02h – 03h → Authentication Type</b>  00 – none  01 – one way chap  02 – mutual chap</p> <p><b>Bit 04h – 05h → Ctrl-D setup menu</b>  00 – enabled  03 – disabled, skip Ctrl-D entry</p>
		<p><b>Bit 06h – 07h → Reserved</b>  <b>Bit 08h – 09h → ARP Retries</b>  Retry value  <b>Bit 0Ah – 0Fh → ARP Timeout</b>  Timeout value for each try</p>
Initiator IP	4	Initiator DHCP flag; not set → This field should contain the initiator IP address. set → this field is ignored.
Subnet Mask	4	Initiator DHCP flag; not set → This field should contain the subnet mask. set → this field is ignored.
Gateway IP	4	Initiator DHCP flag; not set → This field should contain the gateway IP address. set → If DHCP bit is set this field is ignored.
Boot LUN	2	Target DHCP flag; not set → iSCSI target LUN number should be specified. set → this field is ignored.
Target IP	4	Target DHCP flag; not set → IP address of iSCSI target. set → this field is ignored.
Target Port	2	Target DHCP flag; not set → TCP port used by iSCSI target. Default is 3260. set → this field is ignored.
Target Name	255 + 1	Target DHCP flag; not set → iSCSI target name should be specified. set → this field is ignored.
CHAP Password	16 + 2	The minimum CHAP secret must be 12 octets and maximum CHAP secret size is 16. The last 2 bytes are null alignment padding.
CHAP User Name	127 + 1	The user name must be non-null value and maximum size of user name allowed is 127 characters.



Reserved	2	Reserved
Mutual CHAP Password	16 + 2	The minimum mutual CHAP secret must be 12 octets and maximum mutual CHAP secret size is 16. The last 2 bytes are null alignment padding.
Reserved	160	Reserved for future use.

The maximum amount of boot configuration information that is stored is 834 bytes (417 words); however, the iSCSI boot implementation can limit this value in order to work with a smaller EEPROM.

Variable length fields are used to limit the total amount of EEPROM that is used for iSCSI boot information. Each field is preceded by a single byte that indicates how much space is available for that field. For example, if the *Initiator Name* field is being limited to 128 bytes, then it is preceded with a single byte with the value of 128. The following field begins at 128 bytes after the beginning of the *Initiator Name* field regardless of the actual size of the field. The variable length fields must be NULL terminated unless they reach the maximum size specified in the length byte.

#### 4.5.1.29.14 Checksum Word (Word 3Fh)

The checksum word (0x3F) is used to ensure that the base EEPROM image is a valid image. The value of this word should be calculated such that after adding all the words (0x00:0x3F), including the checksum word itself, the sum should be 0xBABA. The initial value in the 16-bit summing register should be 0x0000 and the carry bit should be ignored after each addition.

**Note:** Hardware does not calculate the word 0x3F checksum during EEPROM write; it must be calculated by software independently and included in the EEPROM write data. Hardware does not compute a checksum over words 0x00:0x3F during EEPROM reads in order to determine validity of the EEPROM image; this field is provided strictly for software verification of EEPROM validity. All hardware configurations based on word 0x00:0x3F content is based on the validity of the *Signature* field of EEPROM Initialization Control Word 1 (*Signature* must be 01b).





## 4.6 Manageability Control Sections

### 4.6.1 Sideband Configuration Structure

#### 4.6.1.1 Section Header - (Offset 0h)

Bit	Name	Description
15:8	Block CRC8	
7:0	Block Length	

#### 4.6.1.2 SMBus Max Fragment Size - (Offset 01h)

Bit	Name	Description
15:0	SMBus Max Fragment Size (bytes)	

#### 4.6.1.3 SMBus Notification Timeout and Flags - (Offset 02h)

Bit	Name	Description
15:8	SMBus Notification Timeout (ms)	Timeout until discarding a packet not read by the BMC. 00h = No discard.
7:6	SMBus Connection Speed	00b = Slow SMBus connection. 01b = Fast SMBus connection (1 MHz). 10b = Reserved. 11b = Reserved.
5	SMBus Block Read Command	0b = Block read command is C0h. 1b = Block read command is D0h.
4	SMBus Addressing Mode	0b = Single-address mode. 1b = Dual-address mode.
3	Reserved	
Bit	Name	Description
2	Disable SMBus ARP Functionality	
1	SMBus ARP PEC	
0	Reserved	

#### 4.6.1.4 SMBus Slave Addresses - (Offset 03h)

Bit	Name	Description
-----	------	-------------



15:9	SMBus 1 Slave Address	Dual-address mode only.
8	Reserved	
7:1	SMBus 0 Slave Address	
0	Reserved	



#### 4.6.1.5 SMBus Fail-Over Register (Low Word) - (Offset 04h)

Bit	Name	Description
15:12	Gratuitous ARP Counter	
11:10	Reserved	
9	Enable Teaming Fail-Over on DX	
8	Remove Promiscuous on DX	
7	Enable MAC Filtering	
6	Enable Repeated Gratuitous ARP	
5	Reserved	
4	Enable Preferred Primary	
3	Preferred Primary Port	
2	Transmit Port	
1:0	Reserved	

#### 4.6.1.6 SMBus Fail-Over Register (High Word) - (Offset 05h)

Bit	Name	Description
15:8	Gratuitous ARP Transmission Interval (seconds)	
7:0	Link Down Fail-Over Time	

#### 4.6.1.7 NC-SI Configuration (Offset 06h)

Bit	Name	Description
15:8	Reserved	
7	Send Package Status	
6	Multi-Drop NC-SI	
5	Filter Control Over NC-SI	
4	LAN Packets Over NC-SI	
3:0	Component ID	

### 4.6.2 Flex TCO Filter Configuration Structure

#### 4.6.2.1 Section Header - (Offset 0h)

Bit	Name	Description
-----	------	-------------

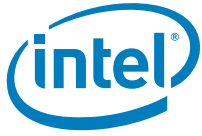

15:8	Block CRC8	
7:0	Block Length	

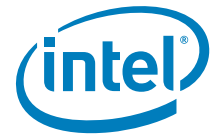

#### 4.6.2.2 Flex Filter Length and Control - (Offset 01h)

Bit	Name	Description
15:8	Flex Filter Length (bytes)	
7:5	Reserved	
4	Last Filter	
3:2	Filter Index (0-3)	
1	Apply Filter to LAN 1	
0	Apply Filter to LAN 0	

#### 4.6.2.3 Flex Filter Enable Mask - (Offset 02 - 09h)

Bit	Name	Description
15:0	Flex Filter Enable Mask	

#### 4.6.2.4 Flex Filter Data - (Offset 0Ah - Block Length)

Bit	Name	Description
15:0	Flex Filter Data	

### 4.6.3 NC-SI Microcode Download Structure

#### 4.6.3.1 Data Patch Size (Offset 0h)

Bit	Name	Description
15:0	Data Size	

#### 4.6.3.2 Rx and Tx Code Size (Offset 1h)

Bit	Name	Description
15:8	Rx Code Length in Dwords	
7:0	Tx Code Length in Dwords	

#### 4.6.3.3 Download Data (Offset 2h - Data Size)

Bit	Name	Description
15:0	Download Data	



## 4.6.4 NC-SI Configuration Structure

### 4.6.4.1 Section Header - (Offset 0h)

Bit	Name	Description
15:8	Block CRC8	
7:0	Block Length	

### 4.6.4.2 Rx Mode Control1 (RR\_CTRL[15:0]) (Offset 01h)

Bit	Name	HDW Default 0ch	Description
15:8	Reserved	0	Should be 0b.
7:5	Reserved	0	Reserved.
4	False Carrier Enable	0b	
3	NC-SI Speed	1b	When set, the NC-SI MAC speed is 100 Mb/s. When reset, NC-SI MAC speed is 10 Mb/s.
2	Receive Without Leading Zeros	0b	If set, packets without leading zeros (such as /J/K/ symbols) between TXEN assertion and TXD first preamble byte can be received.
1	Clear Rx Error	1b	Should be set when the Rx path is stuck because of an overflow condition.
0	NC-SI Loopback Enable	0b	When set, Enables NC-SI Tx to Rx loop. All data that is transmitted from NC-SI is returned to it. No data is actually transmitted from the NC-SI.

### 4.6.4.3 Rx Mode Control2 (RR\_CTRL[31:16]) (Offset 02h)

Bit	Name	HDW Default 00h	Description
15:0	Reserved	00h	Should be 0b.

### 4.6.4.4 Tx Mode Control1 (RT\_CTRL[15:0]) (Offset 03h)

Bit	Name	HDW Default 00h	Description
15:3	Reserved	0	Should be 0b.
2	Transmit With Leading Zeros	0b	When set, send leading zeros (such as /J/K/ symbols) from CRS_DV assertion to start of preamble (PHY Mode). When deasserted, doesn't send leading zeros (MAC mode).



1	Clear Tx Error	0b	Should be set when Tx path is stuck because of an underflow condition Cleared by hardware when release is done.
0	Enable Tx Pads	0b	When set, the NC-SI Tx pads are driving, else they are isolated.

#### 4.6.4.5 Tx Mode Control2 (RT\_CTRL[31:16]) (Offset 04h)

Bit	Name	HDW Default 00h	Description
15:0	Reserved	00h	Should be 0b.

#### 4.6.4.6 MAC Tx Control Reg1 (TxCtrlReg1 (15:0]) (Offset 05h)

Bit	Name	HDW Default 18h	Description
15:7	Reserved	0	Should be 0b.
6	NC-SI_en	0b	Enable the MAC internal NC-SI mode of operation (disables external NC-SI gasket).
5	Two_part_deferral	0b	When set, perform the optional two part deferral.
4	Append_fcs	1b	When set, compute and append FCS on TX frames.
3	Pad_enable	1b	Pad the TX frames, which are less than the minimum frame size.
2	Rtry_col	0b	Retry frames on collision until the max retry limit is reached. Note that this bit has no effect when working in full duplex.
1	Half Duplex	1b	Half-duplex mode of operation, when set. Else Full duplex is assumed.
0	Reserved	0b	Reserved

#### 4.6.4.7 MAC Tx Control Reg2 (TxCtrlReg1 (31:16]) (Offset 06h)

Bit	Name	HDW Default 00h	Description
15:0	Reserved	00h	Should be 0b.

### 4.6.5 Common Firmware Pointer

Word 54h is used to point to firmware structures common to pass through, and non-manageability modes.



### 4.6.5.1 Manageability Capability/Manageability Enable (Word 54h)

Bit	Name	Description
15	Enable Firmware Reset	0b = Firmware reset via HICR is disabled. 1b = Firmware reset via HICR is enabled.
14	Pass Through LAN Interface:	0b = SMBus. 1b = NC-SI.
13:11	Reserved	Reserved.
10:8	Manageability Mode	0h = None. 2h = PT mode. 3h = Reserved. 4h = Host interface enable only. 5h:7h = Reserved.
7	Port1 Manageability Capable	1b = Bits 3:0 are applicable to port 1.
6	Port0 Manageability Capable	1b = Bits 3:0 are applicable to port 0.
5:4	Reserved	Reserved.
3	Pass Through Capable	0b = Disable. 1b = Enable.
2	Reserved	Reserved.
1	Reserved	0b
0	Reserved	0b.

## 4.6.6 Pass Through Pointers

### 4.6.6.1 PT LAN0 Configuration Pointer (Word 56h)

Bit	Name	Description
15:0	Pointer	Pointer to the PT LAN0 configuration pointer structure.

### 4.6.6.2 SMBus Configuration Pointer (Word 57h)

Bit	Name	Description
15:0	Pointer	Pointer to the SMBus configuration pointer structure.

### 4.6.6.3 Flex TCO Filter Configuration Pointer (Word 58h)

Bit	Name	Description
-----	------	-------------



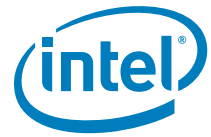

15:0	Pointer	Pointer to the flex TCO configuration pointer structure.
------	---------	--



#### 4.6.6.4 PT LAN1 Configuration Pointer (Word 59h)

Bit	Name	Description
15:0	Pointer	Pointer to the PT LAN1 configuration pointer structure.

#### 4.6.6.5 NC-SI Microcode Download Pointer (Word 5Ah)

Bit	Name	Description
15:0	Pointer	Pointer to the NC-SI microcode download configuration pointer structure.

#### 4.6.6.6 NC-SI Configuration Pointer (Word 5Bh)

Bit	Name	Description
15:0	Pointer	Pointer to the NC-SI configuration pointer structure.

### 4.6.7 PT LAN Configuration Structure

#### 4.6.7.1 Section Header (Offset 0h)

Bit	Name	Description
15:8	Block CRC8	
7:0	Block Length	

#### 4.6.7.2 LAN0 IPv4 Address 0 LSB, MIPAF0 (Offset 01h)

Bit	Name	Description
15:8	LAN0 IPv4 Address 0 (Byte 1)	
7:0	LAN0 IPv4 Address 0 (Byte 0)	

#### 4.6.7.3 LAN0 IPv4 Address 0 LSB, MIPAF0 (Offset 02h)

Bit	Name	Description
15:8	LAN0 IPv4 Address 0 (Byte 3)	
7:0	LAN0 IPv4 Address 0 (Byte 2)	

#### 4.6.7.4 LAN0 IPv4 Address 1; MIPAF1 (Offset 03h:04h)



Same structure as LAN0 IPv4 Address 0.

#### 4.6.7.5 LAN0 IPv4 Address 2; MIPAF2 (Offset 05h:06h)

Same structure as LAN0 IPv4 Address 0.

#### 4.6.7.6 LAN0 IPv4 Address 3; MIPAF3 (Offset 07h:08h)

Same structure as LAN0 IPv4 Address 0.

#### 4.6.7.7 LAN0 MAC Address 0 LSB, MMAL0 (Offset 09h)

Bit	Name	Description
15:8	LAN0 MAC Address 0 (Byte 1)	
7:0	LAN0 MAC Address 0 (Byte 0)	

#### 4.6.7.8 LAN0 MAC Address 0 LSB, MMAL0 (Offset 0Ah)

Bit	Name	Description
15:8	LAN0 MAC Address 0 (Byte 3)	
7:0	LAN0 MAC Address 0 (Byte 2)	

#### 4.6.7.9 LAN0 MAC Address 0 MSB, MMAH0 (Offset 0Bh)

Bit	Name	Description
15:8	LAN0 MAC Address 0 (Byte 5)	
7:0	LAN0 MAC Address 0 (Byte 4)	

#### 4.6.7.10 LAN0 MAC Address 1; MMAL/H1 (Offset 0Ch:0Eh)

Same structure as LAN0 MAC Address 0.

#### 4.6.7.11 LAN0 MAC Address 2; MMAL/H2 (Offset 0Fh:11h)

Same structure as LAN0 MAC Address 0.

#### 4.6.7.12 LAN0 MAC Address 3; MMAL/H3 (Offset 12h:14h)

Same structure as LAN0 MAC Address 0.



#### 4.6.7.13 LAN0 UDP Flex Filter Ports 0:15; MFUTP Registers (Offset 15h:24h)

Bit	Name	Description
15:0	LAN UDP Flex Filter Value	

#### 4.6.7.14 LAN0 VLAN Filter 0:7; MAVTV Registers (Offset 25h:2Ch)

Bit	Name	Description
15:12	Reserved	
11:0	LAN0 VLAN Filter Value	

#### 4.6.7.15 LAN0 Manageability Filters Valid; MFVAL LSB (Offset 2Dh)

Bit	Name	Description
15:8	VLAN	Indicates if the VLAN filter registers (MAVTV) contain valid VLAN tags. Bit 8 corresponds to filter 0, etc.
7:4	Reserved	Reserved.
3:0	MAC	Indicates if the MAC unicast filter registers (MMAH and MMAL) contain valid MAC addresses. Bit 0 corresponds to filter 0, etc.

#### 4.6.7.16 LAN0 Manageability Filters Valid; MFVAL MSB (Offset 2Eh)

Bit	Name	Description
15:12	Reserved	Reserved.
11:8	IPv6	Indicates if the IPv6 address filter registers (MIPAF) contain valid IPv6 addresses. Bit 8 corresponds to address 0, etc. Bit 11 (filter 3) applies only when IPv4 address filters are not enabled (MANC.EN_IPv4_FILTER=0b).
7:4	Reserved	Reserved.
3:0	IPv4	Indicates if the IPv4 address filters (MIPAF) contains a valid IPv4 address. These bits apply only when IPv4 address filters are enabled (MANC.EN_IPv4_FILTER=1b)



#### 4.6.7.17 LANO MAC Value MSB (Offset 2Fh)

Bit	Name	Description
15:0	Reserved	Reserved.

#### 4.6.7.18 LANO MANC Value LSB (Offset 30h)

Bit	Name	Description
15:9	Reserved	Reserved.
8	Enable IPv4 Address Filters	When set, the last 128 bits of the MIPAF register are used to store four IPv4 addresses for IPv4 filtering. When cleared, these bits store a single IPv6 filter.
7	Enable Xsum Filtering to MNG	When this bit is set, only packets that pass the L3 and L4 checksum are send to the MNG block.
6	Reserved	Reserved.
5	Enable MNG Packets to Host Memory	This bit enables the functionality of the MANC2H register. When set, the packets that are specified in the MANC2H registers are also sent to host memory if they pass the manageability filters.
4:0	Reserved	Reserved.

#### 4.6.7.19 LANO Receive Enable 1 (Offset 31h)

Bit	Name	Description
15:8	Receive Enable Byte 12	BMC SMBus slave address.
7	Enable BMC Dedicated MAC	
6	Reserved	Always set to 1b.
5:4	Notification Method	00b = SMBus alert. 01b = Asynchronous notify. 10b = Direct receive. 11b = Reserved.
3	Enable ARP Response	
2	Enable Status Reporting	
1	Enable Receive All	
0	Enable Receive TCO	

#### 4.6.7.20 LANO Receive Enable 2 (Offset 32h)

Bit	Name	Description
15:8	Receive Enable Byte 14	Alert value.

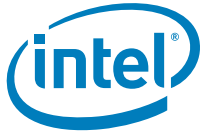

7:0	Receive Enable Byte 13	Interface value.
-----	------------------------	------------------



#### 4.6.7.21 LAN0 MANC2H Value LSB (Offset 33h)

Bit	Name	Description
15:8	Reserved	Reserved.
7:0	Host Enable	When set, indicates that packets routed by the manageability filters to manageability are also sent to the host. Bit 0 corresponds to decision rule 0, etc.

#### 4.6.7.22 LAN0 MANC2H Value MSB (Offset 34h)

Bit	Name	Description
15:0	Reserved	Reserved.

#### 4.6.7.23 Manageability Decision Filters; MDEF0,1 (Offset 35h)

Bit	Name	Description
15:12	Flex Port	Controls the inclusion of flex port filtering in the manageability filter decision (OR section). Bit 12 corresponds to flex port 0, etc. (see also bits 11:0 of the next word).
11	Port 26Fh	Controls the inclusion of port 26Fh filtering in the manageability filter decision (OR section).
10	Port 298h	Controls the inclusion of port 298h filtering in the manageability filter decision (OR section).
9	Neighbor Discovery	Controls the inclusion of neighbor discovery filtering in the manageability filter decision (OR section).
8	ARP Response	Controls the inclusion of ARP response filtering in the manageability filter decision (OR section).
7	ARP Request	Controls the inclusion of ARP request filtering in the manageability filter decision (AND section).
6	Multicast	Controls the inclusion of multicast addresses filtering in the manageability filter decision (OR section).
5	Broadcast	Controls the inclusion of broadcast address filtering in the manageability filter decision (OR section).
4	Unicast	Controls the inclusion of unicast address filtering in the manageability filter decision (OR section).
3	IP Address	Controls the inclusion of IP address filtering in the manageability filter decision (AND section).
2	VLAN	Controls the inclusion of VLAN addresses filtering in the manageability filter decision (AND section).
1	Broadcast	Controls the inclusion of broadcast address filtering in the manageability filter decision (AND section).
0	Unicast	Controls the inclusion of unicast address filtering in the manageability filter decision (AND section).

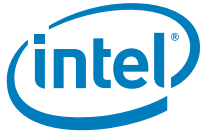

#### 4.6.7.24 Manageability Decision Filters; MDEF0, 2 (Offset 36h)

Bit	Name	Description
15:12	Flex TCO	Controls the inclusion of flex TCO filtering in the manageability filter decision (OR section). Bit 12 corresponds to flex TCO filter 0, etc.
11:0	Flex Port	Controls the inclusion of flex port filtering in the manageability filter decision (OR section). Bit 11 corresponds to flex port 0, etc. (see bits 15:12 of previous word).

#### 4.6.7.25 Manageability Decision Filters; MDEF1:6, 1:2 (Offset 37h:42h)

Same as words 35h and 36h for MDEF1:MDEF6.



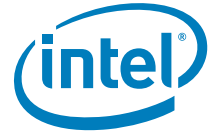

#### 4.6.7.26 ARP Response IPv4 Address 0 LSB (Offset 43h)

Bit	Name	Description
15:8	ARP Response IPv4 Address Byte 1	
7:0	ARP Response IPv4 Address Byte 0	

#### 4.6.7.27 ARP Response IPv4 Address 0 MSB (Offset 44h)

Bit	Name	Description
15:8	ARP Response IPv4 Address Byte 3	
7:0	ARP Response IPv4 Address Byte 2	

#### 4.6.7.28 LAN0 IPv6 Address 0 LSB; MIPAF (Offset 45h)

Bit	Name	Description
15:8	LAN0 IPv6 Address 0 Byte 1	
7:0	LAN0 IPv6 Address 0 Byte 0	

#### 4.6.7.29 LAN0 IPv6 Address 0 MSB; MIPAF (Offset 46h)

Bit	Name	Description
15:8	LAN0 IPv6 Address 0 Byte 3	
7:0	LAN0 IPv6 Address 0 Byte 2	

#### 4.6.7.30 LAN0 IPv6 Address 0 LSB; MIPAF (Offset 47h)

Bit	Name	Description
15:8	LAN0 IPv6 Address 0 Byte 5	
7:0	LAN0 IPv6 Address 0 Byte 4	

#### 4.6.7.31 LAN0 IPv6 Address 0 MSB; MIPAF (Offset 48h)

Bit	Name	Description
15:8	LAN0 IPv6 Address 0 Byte 7	
7:0	LAN0 IPv6 Address 0 Byte 6	



#### 4.6.7.32 LAN0 IPv6 Address 0 LSB; MIPAF (Offset 49h)

Bit	Name	Description
15:8	LAN0 IPv6 Address 0 Byte 9	
7:0	LAN0 IPv6 Address 0 Byte 8	

#### 4.6.7.33 LAN0 IPv6 Address 0 MSB; MIPAF (Offset 4Ah)

Bit	Name	Description
15:8	LAN0 IPv6 Address 0 Byte 11	
7:0	LAN0 IPv6 Address 0 Byte 10	

#### 4.6.7.34 LAN0 IPv6 Address 0 LSB; MIPAF (Offset 4B)

Bit	Name	Description
15:8	LAN0 IPv6 Address 0 Byte 13	
7:0	LAN0 IPv6 Address 0 Byte 12	

#### 4.6.7.35 LAN0 IPv6 Address 0 MSB; MIPAF (Offset 4Ch)

Bit	Name	Description
15:8	LAN0 IPv6 Address 0 Byte 15	
7:0	LAN0 IPv6 Address 0 Byte 14	

#### 4.6.7.36 LAN0 IPv6 Address 1; MIPAF (Offset 4Dh)

Same structure as LAN0 IPv6 Address 0.

#### 4.6.7.37 LAN0 IPv6 Address 2; MIPAF (Offset 55h:5Ch)

Same structure as LAN0 IPv6 Address 0.

## 4.7 Software Owned EEPROM Words

This section describes the software owned EEPROM words (words 03h:09h).



## 4.7.1 Compatibility Fields (Word 03h:07h)

Five words in the EEPROM image are reserved for compatibility information. New bits within these fields will be defined as the need arises for determining software compatibility between various hardware revisions.

## 4.7.2 PBA Number (Words 08h, 09h)

The nine-digit Printed Board Assembly (PBA) number used for Intel manufactured Network Interface Cards (NICs) is stored in EEPROM.

Through the course of hardware ECOs, the suffix field is incremented. The purpose of this information is to enable customer support (or any user) to identify the revision level of a product.

Network driver software should not rely on this field to identify the product or its capabilities.

PBA numbers have exceeded the length that can be stored as HEX values in two words. For newer NICs, the high word in the PBA Number Module is a flag (0xFAFA) indicating that the actual PBA is stored in a separate PBA block. The low word is a pointer to the starting word of the PBA block.

The following shows the format of the PBA Number Module field for new products.

PBA Number	Word 0x8	Word 0x9
G23456-003	FAFA	Pointer to PBA Block

The following provides the format of the PBA block; pointed to by word 0x9 above:

Word Offset	Description
0x0	Length in words of the PBA Block (default is 0x6)
0x1 ... 0x5	PBA Number stored in hexadecimal ASCII values.

The new PBA block contains the complete PBA number and includes the dash and the first digit of the 3-digit suffix which were not included previously. Each digit is represented by its hexadecimal-ASCII values.

The following shows an example PBA number (in the new style):

PBA Number	Word Offset 0	Word Offset 1	Word Offset 2	Word Offset 3	Word Offset 4	Word Offset 5
G23456-003	0006	4732	3334	3536	2D30	3033
	Specifies 6 words	G2	34	56	-0	03

Older NICs have PBA numbers starting with [A,B,C,D,E] and are stored directly in words 0x8-0x9. The dash in the PBA number is not stored; nor is the first digit of the 3-digit suffix (the first digit is always 0b for older products).

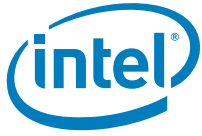

The following example shows a PBA number stored in the PBA Number Module field (in the old style):

PBA Number	Byte 1	Byte 2	Byte 3	Byte 4
E23456-003	E2	34	56	03

§ §



## 5.0 Receive and Transmit Description

This section describes the data flows, packet reception, packet transmission, transmit descriptor ring structure, TCP segmentation, and transmit checksum offloading for the 82575.

### 5.1 82575 Data Flows

#### 5.1.1 Transmit Data Flow

Transmit data flow provides a high level description of all data/control transformations steps needed for transmitting Ethernet packets over the wire.

Step	Description
1	The host creates a descriptor ring and configures one of the 82575's transmit queues with the address location, length, head and tail pointers of the ring (one of four available transmit queues).
2	The host is requested by the TCP/IP stack to transmit a packet; it gets the packet data within one or more data buffers.
3	The host initializes descriptor(s) that point to the data buffer(s) and have additional control parameters that describes the needed hardware functionality. The host places that descriptor in the correct location at the appropriate transmit ring.
4	The host updates the appropriate queue tail pointer (TDT)
5	The 82575's DMA senses a change of a specific TDT and as a result sends a PCIe* request to fetch the descriptor(s) from host memory.
6	The descriptor(s) content is received in a PCIe* read completion and is written to the appropriate location in the descriptor queue internal cache.
7	The DMA fetches the next descriptor and processes its content; as a result the DMA sends PCIe* requests to fetch the packet data from system memory.
8	The packet data is being received from PCIe* completions and passes through the transmit DMA that performs all programmed data manipulations (various CPU offloading tasks as checksum offload TSO offload, etc.) on the packet data on the fly.
9	While the packet is passing through the DMA, it is stored into the transmit FIFO. After the entire packet is stored in the transmit FIFO, it is being forwarded to transmit switch module.
10	The transmit switch arbitrates between host and management packets and eventually forwards the packet to the MAC.
11	The MAC appends the L2 CRC to the packet and sends the packet to the line using a pre-configured interface.
12	When all the PCIe* completions for a given packet are done; the DMA updates the appropriate descriptor(s).



Step	Description
13	After enough descriptors are gathered for write-back or the interrupt moderation timer completes, the descriptors are written back to host memory using PCIe* posted writes. Alternatively, the header pointer might only be written back.
14	After the interrupt moderation timer completes, an interrupt is generated to notify the host driver that the specific packet has been read to the 82575 and the driver can release the buffers.

## 5.2 Receive Data Flow

Receive Data Flow provides a high level description of all data/control transformations steps needed for receiving Ethernet packets over the wire.

Step	Description
1	The host creates a descriptor ring and configures one of the 82575's receive queues with the address location, length, head and tail pointers of the ring (one of four available Rx queues).
2	The host initializes descriptors that point to empty data buffers. The host places these descriptors in the correct location at the appropriate receive ring.
3	The host updates the appropriate queue tail pointer (RDT).
4	the 82575's DMA senses a change of a specific RDT and as a result sends a PCIe* request to fetch the descriptors from host memory.
5	The descriptors content is received in a PCIe* read completion and is written to the appropriate location in the descriptor queue internal cache.
6	A packet enters the receive MAC.
7	The MAC forwards the packet to receive filter(s).
8	If the packet matches the pre-programmed criteria of the receive filtering it is forwarded to receive FIFO.
9	The receive DMA fetches the next descriptor from the appropriate queue to be used for the next received packet.
10	After the entire packet is placed into the receive FIFO, the receive DMA posts the packet data to the location indicated by the descriptor through the PCIe* interface. If the packet size is greater than the buffer size, more descriptors are fetched and their buffers are used for the received packet.
11	When the packet is placed into host memory the receive DMA updates all the descriptor(s) that were used by packet data.
12	After enough descriptors are gathered for write-back, the interrupt moderation timer completes, or the packet requires immediate forwarding, the receive DMA writes back the descriptor content along with status bits that indicate the packet information including what offloads were done on the packet.
13	After the interrupt moderation timer completes or an immediate packet is received, the 82575 initiates an interrupt to the host to indicate that a new received packet is ready in host memory.
14	The host reads packet data and sends it to the TCP/IP stack for further processing. The host releases the associated buffers and descriptors once they are no longer in use.

## 5.3 Receive Functionality

Packet reception consists of recognizing the presence of a packet on the wire, performing address filtering, storing the packet in the receive data FIFO, transferring the data to one of the four receive queues in host memory, and updating the state of a receive descriptor.

**Note:** The maximum supported received packet size is 9018 bytes.



### 5.3.1 Packet Address Filtering

Hardware stores incoming packets in host memory subject to the following filter modes. If there is insufficient space in the receive FIFO, hardware drops them and indicates the missed packet in the appropriate statistics registers.

The following filter modes are supported:

- **Exact Unicast/Multicast** — The destination address must exactly match one of 16 stored addresses. These addresses can be unicast or multicast.

**Note:** The software device driver can use only 15 entries (entries 0-14). Entry 15 should be kept untouched by the software device driver. It can be used only by the manageability's firmware or external TCO controller.

- **Promiscuous Unicast** — Receive all unicasts.
- **Multicast** — The upper bits of the incoming packet's destination address index a bit vector that indicates whether to accept the packet; if the bit in the vector is one, accept the packet, otherwise, reject it. The controller provides a 4096 bit vector. Software provides four choices of which bits are used for indexing. These are [47:36], [46:35], [45:34], or [43:32] of the internally stored representation of the destination address.
- **Promiscuous Multicast** — Receive all multicast packets.

**Note:** When a promiscuous bit is set and a multicast packet is received, the PIF bit of the packet status is not set.

- **VLAN** — Receive all VLAN packets that are for this station and have the appropriate bit set in the VLAN filter table.

Normally, only good packets are received. These are defined as those packets with no CRC error, symbol error, sequence error, length error, alignment error, or where carrier extension or RX\_ERR errors are detected. However, if the *Store Bad Packet* bit is set in the Receive Control register (RCTL.SBP), then bad packets that pass the filter function are stored in host memory. Packet errors are indicated by error bits in the receive descriptor (RDESC.ERRORS). It is possible to receive all packets, regardless of whether they are bad, by setting the promiscuous enables and the *Store Bad Packet* bit.

**Note:** CRC errors before the SFD are ignored. Any packet must have a valid SFD in order to be recognized by the 82575 (even bad packets).

The manageability engine might decide to snoop or redirect part of the received packets according to external BMC instructions and EEPROM settings.

### 5.3.2 Receive Data Storage

The descriptor points to a memory buffer to store packet data. The size of the buffer can be set using either the generic RCTL.BSIZE field, or the per queue SRRCTL[n].BSIZEPACKET field.

Receive buffer size, selected by bit settings in the Receive Control register (RCTL.BSIZE), support the following buffer sizes:

- 256 B
- 512 B
- 1024 B
- 2048 B



If for any queue `SRRCTL[n].BSIZEPACKET` equals 0b, the buffer size defined by `RCTL.BSIZE` is used; otherwise, the buffer size defined by `SRRCTL[n].BSIZEPACKET` is used.

In addition, for advanced descriptor usage the `SRRCTL.BSIZEHEADER` field is used to define the size of the buffers allocated to headers.

The 82575 places no alignment restrictions on receive memory buffer addresses. This is desirable in situations where the receive buffer was allocated by higher layers in the networking software stack, as these higher layers might have no knowledge of a specific device's buffer alignment requirements.

**Note:** When the *No Snoop Enable* bit is used in advanced descriptors, the buffer address must be 16-bit aligned.

### 5.3.3 Legacy Receive Descriptor Format

A receive descriptor is a data structure that contains the receive data buffer address and fields for hardware to store packet information. If `SRRCTL[n].DESCTYPE = 000b`, the 82575 uses the Legacy Rx Descriptor as shown in Table 27. The shaded areas indicate fields that are modified by hardware upon packet reception (descriptor write-back).

**Table 27. Receive Descriptor (RDESC) Layout**

	63	48	47	40	39	32	31	16	15	0
0	Buffer Address [63:0]									
8	VLAN Tag	Errors	Status 0	Packet Checksum (See Note)	Length					

**Note:** The checksum indicated here is the unadjusted "16-bit ones complement" of the packet. A software assist might be required to back out appropriate information prior to sending it to upper software layers. The packet checksum is always reported in the first descriptor (even in the case of multi-descriptor packets).

#### 5.3.3.1 Length Field

Upon receipt of a packet for the 82575, hardware stores the packet data into the indicated buffer and writes the length, Packet Checksum, status, errors, and status fields. Length covers the data written to a receive buffer including CRC bytes (if any). Software must read multiple descriptors to determine the complete length for packets that span multiple receive buffers.

#### 5.3.3.2 Packet Checksum

For standard 802.3 packets (non-VLAN) the Packet Checksum is by default computed over the entire packet from the first byte of the DA through the last byte of the CRC, including the Ethernet and IP headers. Software can modify the starting offset for the packet checksum calculation via the Receive Checksum Control register (`RXCSUM`). To verify the TCP/UDP checksum using the Packet Checksum, software must adjust the Packet Checksum value to back out the bytes that are not part of the true TCP Checksum. When operating with the Legacy Rx Descriptor, the `RXCSUM.IPPCSE` and `RXCSUM.PCSD` fields should be cleared (the default value).





For packets with a VLAN header, the packet checksum includes the header (if VLAN striping is not enabled by the CTRL.VME). If a VLAN header strip is enabled, the packet checksum and the starting offset of the packet checksum exclude the VLAN header.

### 5.3.3.3 Receive Descriptor Status Field

Status information indicates whether the descriptor has been used and whether the referenced buffer is the last one for the packet. Refer to [Table 28](#) for the layout of the status field. Error status information is shown in [Table 29](#).

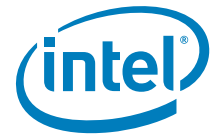

Table 28. Receive Status (RDESC.STATUS) Layout

7	6	5	4	3	2	1	0
PIF	IPCS	TCPCS	UDPCS	VP	IXSM	EOP	DD

Receive Descriptor Status Bits	Bit(s)	Description
PIF	7	<p>Passed In-Exact Filter.</p> <p>Hardware supplies the PIF field to expedite software processing of packets. Software must examine any packet with PIF set to determine whether to accept the packet. If PIF is clear, then the packet is known to be for this station so software need not look at the packet contents. In general, packets passing only the Multicast Vector (MTA) but not any of the MAC address exact filters (RAH, RAL) has PIF set. In addition, the following condition causes PIF to be cleared:</p> <p>The DA of the packet is a multicast address and promiscuous multicast is set (RCTL.MPE = 1b).                      The DA of the packet is a broadcast address and accept broadcast mode is set (RCTL.BAM = 1b).</p> <p>A MAC control frame forwarded to the host (RCTL.PMCF = 0b) that does not match any of the exact filters, has the PIF bit set.</p>
IPCS	6	<p>IPv4 Checksum Calculated on Packet</p> <p>If active, hardware provides IPv4 checksum offload.</p>
TCPCS	5	<p>TCP Checksum Calculated on Packet.</p> <p>Hardware provides an IPv4 checksum offload if IPCS is active and TCP checksum is offload. A pass/fail indication is provided in the Error field - IPE and TCPE. See <a href="#">Table 31</a> for supported packet types.</p>
UDPCS	4	<p>UDP Checksum Calculated on Packet.</p> <p>Hardware provides an IPv4 checksum offload if IPCS is active and UDP checksum is offload. A pass/Fail indication is provided in the Error field - IPE and TCPE. See <a href="#">Table 31</a> for supported packet types.</p>
VP	3	<p>Packet is 802.1q (matched VET).</p> <p>The VP field indicates whether the incoming packet's type matches VET and VLAN field is strip (For example, if the packet is a VLAN (802.1q) type). This bit is set if the packet type matches VET and CTRL.VME is set.</p>
IXSM	2	<p>Ignore Checksum Indication.</p> <p>When set to 1b, hardware does not provide checksum offload. Software device driver should ignore the IPCS, TCPCS, and UDPCS bits.</p>
EOP	1	<p>End of Packet.</p> <p>Packets that exceed the receive buffer size span multiple receive buffers. EOP indicates whether this is the last buffer for an incoming packet.</p>
DD	0	<p>Descriptor Done.</p> <p>indicates whether hardware is done with the descriptor. When set along with EOP, the received packet is complete in main memory. Software can determine buffer usage by setting the status byte to 0b before making the descriptor available to hardware and checking it for non-zero content at a later time. For multi-descriptor packets, packet status is provided in the final descriptor of the packet (EOP set). If EOP is not set for a descriptor, only the <i>Address</i>, <i>Length</i>, and <i>DD</i> bits are valid.</p>

**Note:** See [Table 34](#) for a description of supported packet types for receive checksum offloading. Unsupported packet types either have the IXSM bit set, or they don't have the IPCS or TCPCS bits set. IPv6 packets do not have the IPCS bit set, but might have the TCPCS bit set if the 82575 recognized the TCP or UDP packet.



### 5.3.3.4 Receive Descriptor Errors Field

Most error information appears only when the *Store Bad Packets* bit (RCTL.SBP) is set and a bad packet is received. Refer to [Table 29](#) for a definition of the possible errors and their bit positions.



Table 29. Receive Errors (RDESC.ERRORS) Layout

7	6	5	4	3	2	1	0
RXE	IPE	TCPE	CXE	LE	SEQ	SE	CE

Field	Bit(s)	Description
RXE	7	<p>Rx Data Error.</p> <p>Indicates that a data error occurred during the packet reception. A data error refers to the reception of a /FE/ code from the XGMII interface which eventually causes a CRC error detection (CE bit). This bit is valid only when the EOP and DD bits are set and is not set in descriptors unless RCTL.SBP is set. The RXE bit can also be set if a parity error was discovered in the packet buffer while reading this packet. In this case, RXE might be set even if RCTL.SBP is not set.</p>
IPE	6	<p>IPv4 Checksum Error.</p> <p>Indicates that the IPv4 header checksum is incorrect. If IPv4 checksum offload is disabled by RXCSUM.IPOFL, this bit is 0b.</p>
TCPE	5	<p>TCP/UDP Checksum Error.</p> <p>Indicates that the TCP or UDP checksum is incorrect. If TCP/UDP checksum offload is disabled by RXCSUM.TUOFL, this bit is 0b.</p> <p>The IP and TCP checksum error bits are valid only when the IPv4 or TCP/UDP checksum(s) is performed on the received packet as indicated via IPCS and TCPCS. These, along with the other error bits, are valid only when the EOP and DD bits are set in the descriptor.</p> <p><b>Note:</b> Receive checksum errors have no effect on packet filtering.</p> <p>If receive checksum offloading is disabled (RXCSUM.IPOFL &amp; RXCSUM.TUOFL), then the IPE and TCPE bits are 0b.</p> <p>In 10/100/1000BASE-T mode, the RXE bit indicates that a data error occurred during the packet reception that has been detected by the PHY. This generally corresponds to signal errors occurring during the packet reception. This bit is valid only when the EOP and DD bits are set and is not set in descriptors unless RCTL.SBP is set.</p> <p>CRC errors and alignment errors are both indicated via the CE bit. Software might distinguish between these errors by monitoring the respective statistics registers.</p>
CXE	4	<p>Carrier Extension Error</p> <p>Reads as 0b.</p>
LE	3	<p>Length Error</p> <p>Indicates packets with length error. For example, indicates valid packets (no CRC error) with a type/length field with a value lower or equal 1500 greater than the L2 payload size. Packets with length error are forwarded to the host only if the RFCTL.LEF bit is set or RFCTL.SBP bit is set.</p>
SEQ	2	<p>Sequence Error</p> <p>In 802.3 implementations, this would be classified as a framing error.</p> <p>A valid delimiter sequence consists of:  idle → start-of-frame (SOF) → data, → pad (optional) → end-of-frame (EOF) → fill (optional) → idle.</p>
SE	1	<p>Symbol Error.</p>
CE	0	<p>CRC Error or Alignment Error.</p> <p>Indicates an Ethernet CRC error was detected. This bit is valid only when the EOP and DD bits are set and is not set in descriptors unless RCTL.SBP is set.</p>

The IP and TCP checksum error bits are valid only when the IPv4 or TCP/UDP checksum(s) is performed on the received packet as indicated via IPCS and TCPCS. These, along with the other error bits are valid only when the EOP and DD bits are set in the descriptor.

**Note:** Receive checksum errors have no effect on packet filtering.



If receive checksum offloading is disabled (RXCSUM.IPOFL & RXCSUM.TUOFL), the *IPE* and *TCPE* bits are 0b.

In 1000BASE-T or 10/100BASE-T mode, the *RXE* bit indicates that a data error occurred during the packet reception that has been detected by the PHY. This generally corresponds to signal errors occurring during the packet reception. This bit is valid only when the *EOP* and *DD* bits are set and are not set in descriptors unless *RCTL.SBP* bit is set. The *RXE* bit can also be set if a parity error was discovered in the packet buffer while reading this packet. In this case, *RXE* can be set even if *RCTL.SBP* is not set.

CRC errors and alignment errors are both indicated via the *CE* bit. The software device driver might distinguish between these errors by monitoring the respective statistics registers.

### 5.3.3.5 VLAN Tag Field

Hardware stores additional information in the receive descriptor for 802.1q packets. If the packet type is 802.1q (determined when a packet matches *VET* and *RCTL.VME* = 1b), then the VLAN Tag field records the VLAN information and the four-byte VLAN information is stripped from the packet data storage. Otherwise, the VLAN Tag field contains 0000h.

**Table 30. VLAN Tag Field Layout for 802.1q Packets**

15	13	12	11	0
PRI		CFI	VLAN	

### 5.3.4 Advanced Receive Descriptors

The 82575 uses the following receive descriptor.

Descriptor Read Format:

63		1	0
0	Buffer Address [63:1]	A0/ NSE	
8	Header Buffer Address [63:1]	DD	

#### 5.3.4.1 Packet Buffer Address

This field contains the physical address of the packet buffer. The the lowest bit is either *A0* (LSB of address) or *No Snoop Enable* (NSE), depending on bit *RXCTL.RXdataWriteNSEn* of the relevant queue.

#### 5.3.4.2 Header Buffer Address

This field contains the physical address of the header buffer. The lowest bit is Descriptor Done (DD).

**Note:** The 82575 does not support Null Descriptors in which Packet or Header address is equal to 0b.



When software sets the *NSE* bit, the 82575 places the received packet associated with this descriptor in memory at the Packet Buffer Address with the *NSE* bit set in the PCIe\* attribute fields. *NSE* does not affect the data written to the Header Buffer Address.

When a packet spans more than one descriptor, the header buffer address is not used for the second, third, etc. descriptors; only the Packet Buffer Address is used in this case.

*NSE* is enabled for Packet Buffers that the software device driver knows have not been touched by the processor since the last time they were used, so the data cannot be in the processor cache and snoop is always a miss. Avoiding these snoop misses improves system performance. *NSE* is particularly useful when the data movement engine is moving the data from the Packet Buffer into application buffers and the software device driver is using the information in the Header Buffer when working with the packet.

**Note:** When *NSE* is used, Relaxed Ordering should also be enabled with CTRL\_EXT.RO\_DIS.

Each time the 82575 writes back the descriptors, it uses the following descriptor format. Note that the *SRRCTL[n].DESCTYPE* bit must be set to a value other than 000b so the 82575 can write back the special descriptors

Descriptor Write Format:

	63	48	47	3	31	3	21	20	16	15	4	3:0
0	RSS Hash Value <sup>1</sup>			S P H	Header Buffer Length		Rsv		Packet Type		RSS Type	
	Packet Checksum <sup>a</sup>		IP Identification <sup>a</sup>									
8	VLANTag		Length		Extended Error			Extended Status				

1. Mutually exclusive by RXCSUM.PCSD.



### 5.3.4.3 Packet Type

Field	Description
Reserved (bits 11:8)	Reserved
NFS (bit 7)	NFS header present
SCTP (bit 6)	SCTP header present
UDP (bit 5)	UDP header present
TCP (bit 4)	TCP header present
IPv6E (bit 3)	IPv6 header includes extensions
IPv6 (bit 2)	IPv6 header present
IPv4E (bit 1)	IPv4 header includes extensions
IPv4 (bit 0)	IPv4 header present

### 5.3.4.4 RSS Type

The 82575 must identify the packet type and then choose the appropriate RSS Hash Function to be used on the packet. The RSS Type reports the packet type that was used for the RSS Hash Function.

Packet Type	Description
0h	No hash computation done for this packet.
1h	HASH_TCP_IPV4
2h	HASH_IPV4
3h	HASH_TCP_IPV6
4h	HASH_IPV6_EX
5h	HASH_IPV6
6h	HASH_TCP_IPV6_EX
7h	HASH_UDP_IPV4
8h	HASH_UDP_IPV6
9h	HASH_UDP_IPV6_EX
Ah - Fh	Reserved

### 5.3.4.5 Split Header

- SPH (bit 10) - When set to 1b, indicates that HDR\_BUF\_LEN field reflects the length of the header found by the hardware.
- HDR\_BUF\_LEN (bit 9:0) - The length (Bytes) of the header as parsed by the 82575. In Header Split Always mode (SPH set to 1b), this field also reflects the size of the Header that was actually stored in the buffer. In split mode when HBO is set the HDR\_BUF\_LEN can be greater than 0 though nothing is written to the header buffer. In Header Replication mode (SPH is set in this mode, too) however, this does not reflect the size of the data actually stored in the header buffer, because the 82575 fills the buffer up to the size configured by SRRCTL[n].BSIZEHEADER which might be larger than the header size reported here.

#### Packet Types Supported by Packet Split

The 82575 provides header split for the packet types listed in [Table 31](#). Other packet types are posted sequentially in the host packet buffer. Each line in [Table 31](#) has an enable bit in the PSRTYPE register. When one of the bits is set, the corresponding packet type is split.



Table 31. Supported Packets

Packet Type	Description	Header Split
0h	MAC, (VLAN/SNAP)	No.
1h	MAC, (VLAN/SNAP) IPv4	Split header after L3 if packets are fragmented.
2h	MAC, (VLAN/SNAP) IPv4, TCP	Split header after L4 if packets are not fragmented. Otherwise, treat the packet as packet type 1.
3h	MAC (VLAN/SNAP), IPv4, UDP	Split header after L4 if either IPv4 or IPv6 indicates a fragmented packet.
4h	MAC (VLAN/SNAP), IPv4, IPv6	Split header after L3 if either IPv4 or IPv6 indicates a fragmented packet
5h	MAC (VLAN/SNAP), IPv4, IPv6, TCP	Split header after L4 if IPv4 is not fragmented and if IPv6 does not include a fragment extension header. Otherwise, treat as packet type 4
6h	MAC (VLAN/SNAP), IPv4, IPv6, UDP	Split header after L4 if IPv4 is not fragmented and if IPv6 does not include a fragment extension header. Otherwise, treat as packet type 4.
7h	MAC, (VLAN/SNAP) IPv6	Split header after L3 if fragmented packets.
8h	MAC, (VLAN/SNAP) IPv6, TCP	Split header after L4 if IPv6 does not include a fragment extension header. Otherwise treat as packet type 7.
9h	MAC (VLAN/SNAP), IPv6, UDP	Split header after L4 if IPv6 does not include a fragment extension header. Otherwise treat as packet type 7.
Ah	Reserved	Reserved.
Bh	MAC (VLAN/SNAP), IPv4, TCP, NFS	Split header after L5 if not fragmented. Otherwise, treat as packet type 1. If not enabled, treat as packet type 2h.
Ch	MAC (VLAN/SNAP), IPv4, UDP, NFS	Split header after L5 if not fragmented. Otherwise, treat as packet type 1. If not enabled, treat as packet type 3h.
Dh	Reserved	Reserved.
Eh	MAC (VLAN/SNAP), IPv4, IPv6, TCP, NFS	Split header after L5 if IPv4 is not fragmented and if IPv6 does not include a fragment extension header. Otherwise, treat as packet type 4. If not enabled, treat as packet type 5h.
Fh	MAC (VLAN/SNAP), IPv4, IPv6, UDP, NFS	Split header after L5 if IPv4 is not fragmented and if IPv6 does not include a fragment extension header. Otherwise, treat as packet type 4. If not enabled, treat as packet type 6h.
10h	Reserved	Reserved.
11h	MAC (VLAN/SNAP), IPv6, TCP	Split header after L5 if IPv6 does not include a fragment extension header. Otherwise, treat as packet type 7. If not enabled, treat as packet type 8h.
12h	MAC (VLAN/SNAP), IPv6, UDP, NFS	Split header after L5 if IPv6 does not include a fragment extension header. Otherwise, treat as packet type 7. If not enabled, treat as packet type 9h.

**Note:** The header of the fragmented IPv6 packet is defined until the fragmented extension header.

### 5.3.4.6 Packet Checksum

For standard 802.3 packets (non-VLAN) the Packet Checksum is by default computed over the entire packet from the first byte of the DA through the last byte of the CRC, including the Ethernet and IP headers. Software can modify the starting offset for the packet checksum calculation via the Receive Checksum Control register (RXCSUM). To verify the TCP/UDP checksum using the Packet Checksum, software must adjust the Packet Checksum value to back out the bytes that are not part of the true TCP Checksum. Likewise, for fragmented UDP packets, the Packet Checksum field can be used to accelerate UDP checksum verification by the host processor. This operation is enabled by the RXCSUM.IPPCSE bit.

For packets with VLAN header, the packet checksum includes the header if VLAN striping is not enabled by CTRL.VME. If VLAN header strip is enabled, the packet checksum and the starting offset of the packet checksum exclude the VLAN header.





This field is mutually exclusive with the RSS Hash Value. It is enabled when the RXCSUM.PCSD bit is cleared.

### 5.3.4.7 RSS Hash Value

This field is mutually exclusive with Packet Checksum. It is enabled when the RXCSUM.PCSD bit is set.

### 5.3.4.8 Extended Status

9	8	7	6	5	4	3	2	1	0
VEXT	CRCV	PIF	IPCS	TCPCS	UDPCS	VP	IXSM	EOP	DD
Reserved							DYNINT	UDPV	

Field	Bit(s)	Description
Reserved	19:12	Reserved.
DYNINT	11	Dynamic Interrupt. Indicates that this packet caused an immediate interrupt via Dynamic Interrupt Moderation. This bit is valid only for the last descriptor of the packet.
UDPV	10	Valid UDP XSUM.
VEXT	9	1st VLAN Found. Valid only when CTRL_EXT.EXTENDED_VLAN is set. Otherwise, this bit is set to 0b.
CRCV	8	Speculative CRC Valid. Hardware speculatively found a valid CRC-32. Its up to the software device driver to determine this indication's validity of a correct CRC-32.
PIF	7	Passed In-Exact Filter. Hardware supplies the PIF field to expedite software processing of packets. Software must examine any packet with PIF set to determine whether to accept the packet. If PIF is clear, then the packet is known to be for this station so software need not look at the packet contents. In general, packets passing only the Multicast Vector (MTA) but not any of the MAC address exact filters (RAH, RAL) has PIF set. In addition, the following condition causes PIF to be cleared:  The DA of the packet is a multicast address and promiscuous multicast is set (RCTL.MPE = 1b).  The DA of the packet is a broadcast address and accept broadcast mode is set (RCTL.BAM = 1b).  A MAC control frame forwarded to the host (RCTL.PMCF = 0b) that does not match any of the exact filters, has the PIF bit set.
IPCS	6	IPv4 Checksum Calculated on Packet If active, hardware provides IPv4 checksum offload.
TCPCS	5	TCP Checksum Calculated on Packet. Hardware provides an IPv4 checksum offload if IPCS is active and TCP checksum is offload. A pass/fail indication is provided in the Error field - IPE and TCPE. See <a href="#">Table 31</a> for supported packet types.
UDPCS	4	UDP Checksum Calculated on Packet. Hardware provides an IPv4 checksum offload if IPCS is active and UDP checksum is offload. A pass/Fail indication is provided in the Error field - IPE and TCPE. See <a href="#">Table 31</a> for supported packet types.



VP	3	Packet is 802.1q (matched VET). The VP field indicates whether the incoming packet's type matches VET and VLAN field is strip (For example, if the packet is a VLAN (802.1q) type). This bit is set if the packet type matches VET and CTRL.VME is set.
<b>Field</b>	<b>Bit(s)</b>	<b>Description</b>
IXSM	2	Ignore Checksum Indication. When set to 1b, hardware does not provide checksum offload. Software device driver should ignore the IPCS, TCPCS, and UDPCS bits.
EOP	1	End of Packet. Packets that exceed the receive buffer size span multiple receive buffers. EOP indicates whether this is the last buffer for an incoming packet.
DD	0	Descriptor Done. indicates whether hardware is done with the descriptor. When set along with EOP, the received packet is complete in main memory. Software can determine buffer usage by setting the status byte to 0b before making the descriptor available to hardware and checking it for non-zero content at a later time. For multi-descriptor packets, packet status is provided in the final descriptor of the packet (EOP set). If EOP is not set for a descriptor, only the <i>Address</i> , <i>Length</i> , and <i>DD</i> bits are valid.

**Note:** Unsupported packet types will either have the IXSM bit set, or do not have the IPCS or TCPCS bits set. Ipv6 packets do not have the IPCS bit set, but might have the TCPCS bit set if the 82575 recognized the TCP or UDP packet.

### 5.3.4.9 Extended Errors

11	10	9	8	6	5	4	3	2	0
RXE	IPE	TCPE	Reserved		SE	CE	HBO	Reserved	

Field	Bit(s)	Description
RXE	11	Rx Data Error. Indicates that a data error occurred during the packet reception. A data error refers to the reception of a /FE/ code from the XGMII interface which eventually causes a CRC error detection (CE bit). This bit is valid only when the EOP and DD bits are set and is not set in descriptors unless RCTL.SBP is set. The RXE bit can also be set if a parity error was discovered in the packet buffer while reading this packet. In this case, RXE might be set even if RCTL.SBP is not set.
IPE	10	IPv4 Checksum Error. Indicates that the IPv4 header checksum is incorrect. If IPv4 checksum offload is disabled by RXCSUM.IPOFL, this bit is 0b.



TCPE	9	<p>TCP/UDP Checksum Error.</p> <p>Indicates that the TCP or UDP checksum is incorrect. If TCP/UDP checksum offload is disabled by RXCSUM.TUOFL, this bit is 0b.</p> <p>The IP and TCP checksum error bits are valid only when the IPv4 or TCP/UDP checksum(s) is performed on the received packet as indicated via IPCS and TCPCS. These, along with the other error bits, are valid only when the <i>EOP</i> and <i>DD</i> bits are set in the descriptor.</p> <p><b>Note:</b> Receive checksum errors have no effect on packet filtering.</p> <p>If receive checksum offloading is disabled (RXCSUM.IPOFL &amp; RXCSUM.TUOFL), then the IPE and TCPE bits are 0b.</p> <p>In 10/100/1000BASE-T mode, the RXE bit indicates that a data error occurred during the packet reception that has been detected by the PHY. This generally corresponds to signal errors occurring during the packet reception. This bit is valid only when the <i>EOP</i> and <i>DD</i> bits are set and is not set in descriptors unless RCTL.SBP is set.</p> <p>CRC errors and alignment errors are both indicated via the CE bit. Software might distinguish between these errors by monitoring the respective statistics registers.</p>
<b>Field</b>	<b>Bit(s)</b>	<b>Description</b>
Reserved	8	Reserved.
LE	7	<p>Length Error</p> <p>Indicates packets with length error. For example, indicates valid packets (no CRC error) with a type/length field with a value lower or equal 1500 greater than the L2 payload size. Packets with length error are forwarded to the host only if RFCTL.LEF bit is set or RFCTL.SBP bit is set.</p>
SE	5	Symbol Error.
CE	4	<p>CRC Error or Alignment Error.</p> <p>Indicates an Ethernet CRC error was detected. This bit is valid only when the <i>EOP</i> and <i>DD</i> bits are set and is not set in descriptors unless RCTL.SBP is set.</p>
HBO	3	<p>Header Buffer Overflow (header is bigger than the header buffer).</p> <p><b>Note:</b> This bit is relevant only if the <i>SPH</i> bit is set.</p> <p>In both Header Replication modes, HBO is set if the header size (as calculated by the hardware) is bigger than the allocated buffer size (PSRCTL.BSIZEHEADER) but the replication will still take place up to the header buffer size. HW will set this bit in order to indicate to the SW it needs to allocate bigger buffers for the headers.</p> <p>In Header Split mode, when SRRCTL[n] BSIZEHEADER is smaller than HDR_BUF_LEN, then HBO is set to 1b. In this case, the header is not split. Instead, the header resides within the Host Packet Buffer. The HDR_BUF_LEN field is still valid and equal to the calculated size of the header. However, the header is not copied into the header buffer.</p> <p><b>Note:</b> Most error information appears only when the Store Bad Buffers bit (RCTL.SBP) is set and a bad packet is received.</p>
Reserved	2:0	Reserved.

### 5.3.4.10 Packet Buffer (Number of Bytes Exists in the Host Packet Buffer)

The length covers the data written to a receive buffer including CRC bytes (if any). Software must read multiple descriptors to determine the complete length for packets that span multiple receive buffers. If SRRCTL.DESC\_TYPE = 4 (advanced descriptor header replication large packet only) and the total packet length is smaller than the size of the header buffer (no replication is done), this field will still reflect the size of the packet, although no data is written to the packet buffer. Otherwise, if the buffer is not split because the header is bigger than the allocated header buffer, this field will reflect the size of the data written to the first packet buffer (header + data).



### 5.3.4.11 VLAN Tag Field

Hardware stores additional information in the receive descriptor for 802.1q packets. If the packet type is 802.1q (determined when a packet matches VET and RCTL.VME = 1b), then the VLAN Tag field records the VLAN information and the four-byte VLAN information is stripped from the packet data storage. Otherwise, the VLAN Tag field contains 0000h.

Table 32. VLAN Tag Field Layout for 802.1g Packets

15	13	12	11	0
PRI		CFI		VLAN

### 5.3.5 Receive UDP Fragmentation Checksum

The 82575 provides Receive fragmented UDP checksum offload. The following setup should be made to enable this mode:

1. RXCSUM.PCSD bit should be cleared. The Packet Checksum and IP Identification fields are mutually exclusive with the RSS hash. When the PCSD bit is cleared, the Packet Checksum and IP Identification are active instead of RSS hash.
2. RXCSUM.IPPCSE bit should be set. This field enables the IP payload checksum enable that is designed for the fragmented UDP checksum.
3. RXCSUM.PCSS field must be zero. The packet checksum start should be zero to enable auto start of the checksum calculation. Refer to the table that follows w for exact description of the checksum calculation.

Incoming Packet Type	Packet Checksum	UDPV	UDPCS/TCPCS
Non IPv4 packet.	Unadjusted "16 bit ones complement" checksum of the entire packet (excluding VLAN header).	0b	0b/0b
Non fragmented IPv4 packet.	Same as above.	0b	Depends on the Transport header and TUOFL field.
Fragmented IPv4 without transport header.	The unadjusted 1b's complement checksum of the IP payload.	0b	1b/0b
Fragmented IPv4 with UDP header.	Same as above.	1b if the UDP header checksum is valid (not 0b).	1b/0b

**Note:** When the software device driver computes the "16-bit 1's complement" checksum on the incoming packets of the UDP fragments, it should expect a value of FFFFh.

### 5.3.6 Receive Descriptor Fetching

The fetching algorithm attempts to make the best use of PCIe\* bandwidth by fetching a cache-line (or more) descriptor with each burst. The following paragraphs briefly describe the descriptor fetch algorithm and the software control provided.

When the on-chip buffer is empty, a fetch happens as soon as any descriptors are made available (host writes to the tail pointer). When the on-chip buffer is nearly empty (RXDCTL.PTHRESH), a prefetch is performed each time enough valid descriptors (RXDCTL.HTHRESH) are available in host memory



When the number of descriptors in host memory is greater than the available on-chip descriptor storage, the 82575 might elect to perform a fetch that is not a multiple of cache line size. The hardware performs this non-aligned fetch if doing so results in the next descriptor fetch being aligned on a cache line boundary. This enables the descriptor fetch mechanism to be most efficient in the cases where it has fallen behind software.

All fetch decisions are based on the number of available descriptors and do not take into account any split of the transaction due to bus access limitations.

**Note:** The 82575 **never** fetches descriptors beyond the descriptor TAIL pointer.

## 5.3.7 Receive Descriptor Write-Back

Processors have cache line sizes that are larger than the receive descriptor size (16 bytes). Consequently, writing back descriptor information for each received packet causes expensive partial cache line updates. A Receive descriptor packing mechanism minimizes the occurrence of partial line write backs.

### 5.3.7.1 Receive Descriptor Packing

To maximize memory efficiency, receive descriptors are packed together and written as a cache line whenever possible. Descriptor write backs accumulate and are opportunistically written out in cache line-oriented chunks as follows:

- RXDCTL.WTHRESH descriptors have been used (the specified max threshold of unwritten used descriptors has been reached)
- The receive timer expires (EITR). In this case all descriptors are flushed ignoring any cache line boundaries
- Explicit software flush (RXDCTLn.SWFLS)
- Dynamic packets. If at least one of the descriptors waiting for write-back is classified as a packet requiring immediate notification, the entire queue is flushed.

When the numbers of descriptors specified by RXDCTL.WTHRESH have been used, they are written back, regardless of cache line alignment. It is recommended that WTHRESH be a multiple of cache line size. When the receive timer (EITR) expires, all used descriptors are forced to be written back prior to initiating the interrupt, for consistency. Software can explicitly flush accumulated descriptors by writing the RXDCTLn register with the *SWFLS* bit set.

When the 82575 does a partial cache line write-back, it attempts to recover to cache-line alignment on the next write-back.

All write back decisions are based on the number of descriptors available and do not take into account any split of the transaction due to bus access limitations.

## 5.3.8 Receive Descriptor Ring Structure

Figure 3 shows the structure of each of the four receive descriptor rings. Hardware maintains four circular queues of descriptors and writes back used descriptors just prior to advancing the head pointer(s). Head and tail pointers wrap back to base when size descriptors have been processed.

Software inserts receive descriptors by advancing the tail pointer(s) to refer to the address of the entry just beyond the last valid descriptor. This is accomplished by writing the descriptor tail register(s) with the offset of the entry beyond the last valid descriptor. Hardware adjusts its internal tail pointer(s) accordingly. As packets arrive, they are stored in memory and the head pointer(s) is incremented by hardware. When the head pointer(s) is equal to the tail pointer(s), the queue(s) is empty. Hardware stops storing packets in system memory until software advances the tail pointer(s), making more receive buffers available.

The receive descriptor head and tail pointers reference to 16-byte blocks of memory. Shaded boxes in the figure represent descriptors that have stored incoming packets but have not yet been recognized by software. Software can determine if a receive buffer is valid by reading the descriptors in memory. Any descriptor with a non-zero status byte has been processed by the hardware, and is ready to be handled by the software.

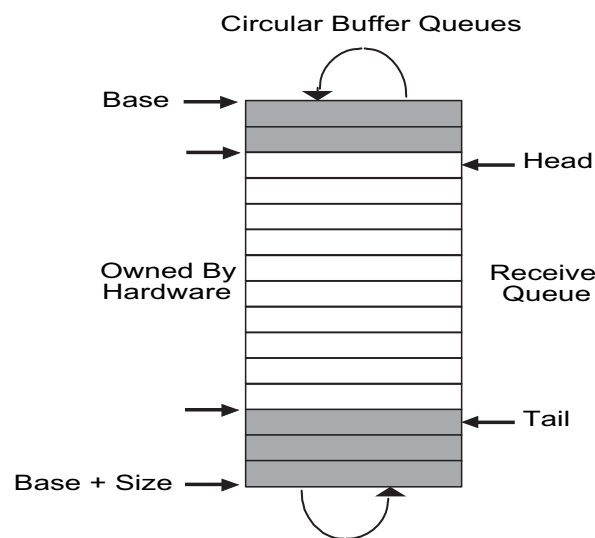

**Figure 3. Receive Descriptor Ring Structure**

**Note:** The head pointer points to the next descriptor that is written back. At the completion of the descriptor write-back operation, this pointer is incremented by the number of descriptors written back. **HARDWARE OWNS ALL DESCRIPTORS BETWEEN [HEAD AND TAIL].** Any descriptor not in this range is owned by software.

The receive descriptor ring is described by the following registers:

- Receive Descriptor Base Address registers (RDBA0, RDBA1, RDBA2, RDBA3)  
These registers indicate the state of the descriptor ring buffer. This 64-bit address is aligned on a 16-byte boundary and is stored in two consecutive 32-bit registers. Hardware ignores the lower 4 bits.
- Receive Descriptor Length registers (RDLEN0, RDLEN1, RDLEN2, RDLEN3)  
These registers determine the number of bytes allocated to the circular buffer. This value must be a multiple of 128 (the maximum cache line size). Since each descriptor is 16 bytes in length, the total number of receive descriptors is always a multiple of 8.
- Receive Descriptor Head registers (RDH0, RDH1, RDH2, RDH3)



These registers hold a value that is an offset from the base and indicates the in-progress descriptor. There can be up to 8 KB descriptors in the circular buffer. Hardware maintains a shadow copy that includes those descriptors completed but not yet stored in memory.

- Receive Descriptor Tail registers (RDT0, RDT1, RDT2, RDT3)

These registers hold a value that is an offset from the base and identifies the location beyond the last descriptor hardware can process. This is the location where software writes the first new descriptor.

If software statically allocates buffers, and uses memory read to check for completed descriptors, it simply has to zero the status byte in the descriptor to make it ready for re-use by hardware. This is not a hardware requirement, but is necessary for performing an in-memory scan.

All the registers controlling the descriptor rings behavior should be set before receive is enabled, apart from the tail registers which are used during the regular flow of data.

## 5.4 Multiple Receive Queues

The 82575 supports four receive descriptor Queues organized in ring structures. The ring functionality is described in [Section 5.3.8](#). The four receive queues are intended for use with the Receive Side Scaling (RSS) algorithm. The following figure shows the implementation of multiple receive queues in connection with RSS.

**Note:** For more information on manageability, refer to the *82575 TCO/System Manageability Interface Application Note (AP-495)*.

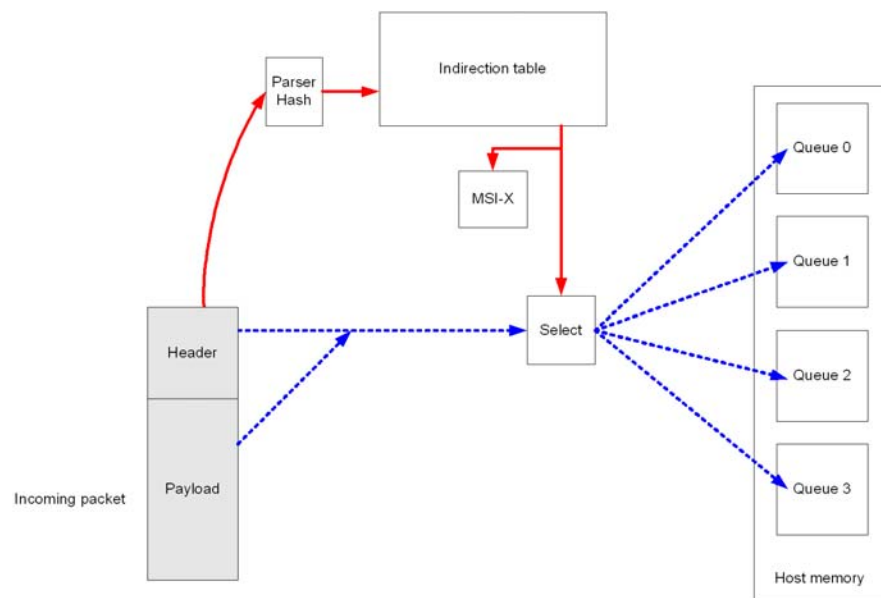

**Figure 4. Multiple Queues in Receive**

First, the software application stores into the indirection table a set of values, enabling pre-determined indirection of incoming packets to specific queues, each queue being dedicated to one processor. This enables load balancing of multiple connections among the processors.



When receiving an incoming packet, its header is analyzed, according to the protocol used (IPv4, IPv6, etc.). The connection-related fields are parsed and then a hash function is performed. The outcome of the hash function is used to index into the indirection table memory; the value stored in this table is used to generate an input to the Select modules that indicates to which queue the incoming packet is going to be directed.

The number of processors in use need to fit the number of queues. As a result, when a platform features more than four processors, only four of them are allocated to the Rx queues.

## 5.4.1 Queuing for Virtual Machine Devices (VMDq)

VMDs are I/O devices specifically targeted for sharing in a virtual system. In a virtual system, multiple operating systems are loaded and each executes as though the entire system's resources are available for each. However, for the limited number of I/O devices, this presents a problem because each operating system might be in a separate memory domain and all the data movement and device management has to be done by a VMM (Virtual Machine Monitor). VMM access adds latency and delay to I/O accesses and degrades I/O performance. VMDs are designed to reduce the burden of VMM by making certain functions of an I/O device shared and thus can be accessed directly from each guest operating system or Virtual Machine (VM). The 82575's four queues can be accessed by four different VMs if configured properly. When the 82575 is enabled for multiple queue direct access for VMs, it becomes a VMDq device.

**Note:** Most configuration and resources are shared across queues. System software must resolve any conflicts in configuration between the VMs.

The 82575 provides several options for sharing the four receive queues among VMs:

- VMs are associated with receive queues based on the packet destination MAC address
- VMs are associated with receive queues based on the packet VLAN tag ID
- VMs are associated with receive queues based on the packet destination MAC address and Receive Side Scaling (RSS)
- VMs are associated with receive queues based on the packet VLAN tag ID and Receive Side Scaling (RSS)

The appropriate mode is defined through the Multiple Receive Queues Enable field in the Multiple Receive Queues Command register (MRQC). If promiscuous mode is enabled, packets that do not match into a specific queue are routed into a default queue defined by the VMDq Control register (VMD\_CTL). Promiscuous mode is used to support more than four VMs so that the busier VMs are assigned specific queues while all other VMs share the default queue. Unless assigned a dedicated MAC address and a specific port, multicast and broadcast packets will be sent to the default queue.

**Note:** Packets must pass the regular receive filtering rules to be posted into any of the receive queues.

### 5.4.1.1 Association Through MAC Address

Each of the 16 MAC address filters can be associated with one of the four receive queues. A packet that matches a certain filter (and is eligible to be passed to the host) is routed to the respective queue. The QSEL field in the Receive Address High register (RAH) determines the target queue. Packets that do not match any of the MAC filters (broadcast, promiscuous, etc.) are forwarded to the default queue.





Software can program different values to the MAC filters (any bits in RAH or RAL) at any time. The 82575 responds to the change on a packet boundary but does not guarantee the change to take place at some precise time.

### 5.4.1.2 Association Through MAC Address + RSS

This mode combines classification through a MAC address and load balancing via RSS. MAC addressing is used to classify packets to two pools (where a pool can be associated with a VM). RSS is then used for each pool to determine the exact queue or processor. A single RSS Redirection Table serves both pools; with the first half of each entry dedicated to pool 0 and the second half to pool 1. Note that the same RSS key is used for both pools.

This scheme is targeted for VMDq use as well as future uses such as classification between a LAN pool and an iSCSI pool.

This two-stage procedure operates as follows:

- The MSB of the QSEL field (QSEL[19]) in the Receive Address High register (RAH) matched by the Destination Address determines the target pool.
- The index into the RSS Redirection Table is computed as in described in [Section 5.4.2](#).

Software might program different values to the MAC filters (any bits in RAH or RAL) at any time. The 82575 responds to the change on a packet boundary but does not guarantee the change to take place at some precise time.

Packets that do not match any of the MAC filters (broadcast, promiscuous, etc.) are forwarded to the default pool and are further classified by the RSS rules for that queue.

A packet forwarded to a queue (either by MAC address matching or by default), that cannot receive an RSS hash value is assigned to the default queue of this pool.

### 5.4.1.3 Association through VLAN tag ID

When MRCQ.MRQE = 100b, packets are forwarded to a queue according to their VLAN tag ID. The VLAN tag of the packet is used as an index to a table that indicates the queue to which the packet should be routed. The table is created by the VFQA1 (msb) and VFQA0 (lsb).

**Note:** Note: The VLAN tags that should be received should also be set in the VFTA table.

### 5.4.1.4 Association through VLAN tag ID +RSS

This mode combines classification through VLAN tag ID and load balancing via RSS. VLAN tag ID filtering is used to classify packets to 2 pools (where a pool may be associated with a VM) using the VFQA1 table. RSS is then used for each pool to determine the exact queue or processor. A single RSS Redirection Table serves both pools; with the first half of each Indirection Table entry dedicated to pool 0 and the second half to pool 1.

The RSS redirection method is similar to the method used when associating queues by MAC address +RSS.

**Note:** Note: The VLAN tags that should be received should also be set in the VFTA table



## 5.4.2 Multiple Receive Queues & Receive-Side Scaling (RSS)

The 82575 provides four hardware receive queues and filters each receive packet into one of the queues based on criteria described in the sections that follow. Classification of packets into receive queues have several uses such as Receive Side Scaling (RSS), generic Multiple receive queues, or Priority receive queues. However, RSS is the only usage that is described specifically. Other uses should make use of the available hardware.

Multiple Receive Queues are enabled when the RXCSUM.PCSD bit is set (Packet Checksum is disabled) and the Multiple Receive Queues Enable bits are not set to 00b. Multiple Receive Queues are therefore mutually exclusive with UDP fragmentation. Also, support for multiple queues is not provided when legacy receive descriptor format is used.

When Multiple Receive Queues are enabled, the 82575 provides software with several types of information. Some are requirements of RSS while other are provided for device driver assistance:

- A Dword result of the RSS hash function. This is used by the stack for flow classification and is written into the receive packet descriptor (required by RSS).
- A 4-bit RSS Type field. This conveys the hash function used for the specific packet (required by RSS).

The following summarizes the process of classifying a packet into a receive queue:

1. The receive packet is parsed into the header fields used by the hash operation (for example, IP addresses, TCP/UDP port, etc.)
2. A hash calculation is performed. The 82575 supports a single hash function as defined by RSS. The 82575 does not indicate to the device driver which hash function is used. The 32-bit result is fed into the receive packet descriptor.
3. The seven LSBs of the hash result are used as an index into a 128-entry Redirection Table. Each entry provides a 2-bit Queue number that indicates the queue into which the packet should be routed.

When multiple receive queues are disabled, packets enter hardware queue 0. System software can enable or disable RSS at any time. While disabled, system software can update the contents of any of the RSS-related registers. While RSS is enabled, software can update the Indirection Table at any time.

When multiple request queues are enabled in RSS mode, un-decodable packets enter hardware queue 0. The 32-bit tag (normally a result of the hash function) equals 0b.

### 5.4.2.1 RSS Hash Function

A single hash function is defined with six variations for the following cases:

- IPv4. The 82575 parses the packet and uses the IPv4 source and destination addresses to generate the hash value.
- TCP/IPv4. The 82575 parses the packet to identify an IPv4 packet containing a TCP segment. The 82575 uses the IPv4 source and destination addresses and the TCP local and remote port values to generate the hash value.
- IPv6. The 82575 parses the packet to identify an IPv6 packet and uses the IPv6 source and destination addresses to generate the hash value.
- TCP/IPv6. The 82575 parses the packet to identify an IPv6 packet containing a TCP segment. The 82575 uses the IPv6 source and destination addresses and the TCP local and remote port values to generate the hash value.



- IPv6Ex. The 82575 parses the packet to identify an IPv6 packet. Extension headers should be parsed for a Home-Address-Option field (for source address) or the Routing-Header-Type-2 field (for destination address). Note that the packet is not required to contain any of these extension headers to be hashed by this function. If the specified extension headers are not present in the packet, the 82575 uses the source/destination from the standard IPv6 header.
- TCPIPv6Ex. The 82575 parses the packet to identify an IPv6 packet containing a TCP segment with extensions. Extension headers should be parsed for a Home-Address-Option field (for source address) or the Routing-Header-Type-2 field (for destination address). Note that the packet is not required to contain any of these extension headers to be hashed by this function. If the specified extension headers are not present in the packet, the 82575 uses the source/destination from the standard IPv6 header.

The following cases are in addition to the RSS standard:

- UDPIIPv4 - The 82575 parses the packet to identify a packet with UDP over IPv4
- UDPIIPv6 - The 82575 parses the packet to identify a packet with UDP over IPv6
- UDPIIPv6Ex - The 82575 parses the packet to identify a packet with UDP over IPv6 with extensions

A packet is identified as containing a TCP segment if all of the following conditions are met:

- The transport layer protocol is TCP (not UDP, ICMP, IGMP, etc.).
- The TCP segment can be parsed (for example, IP options can be parsed or the packet is not encrypted).
- The packet is not IP fragmented (even if the fragment contains a complete TCP header).

**Note:** When RSS is enabled (MRQC.MRQE equals 010b, 101b or 110b), TCP Rx checksum must also be enabled (RXCSUM.TUOFL = 1b).

Bits[31:16] of the Multiple Receive Queues Command (MRQC) register enable each of the above hash function variations (several may be set at a given time). If several functions are enabled at the same time, priority is defined as follows (skip functions that are not enabled):

- IPv4 Packet.
  - a. Try using the TCP/IPv4 function.
  - b. Try using the IPv4\_UDP function.
  - c. Try using the IPv4 function.
- IPv6 Packet.
  - a. If TCPIPv6Ex is enabled, try using the TCP/IPv6Ex function; else, if TCPIPv6 is enabled, try using the TCPIPv6 function.
  - b. If UDPIIPv6Ex is enabled, try using the UDPIIPv6EX function; else, if UDPIIPv6 is enabled, try using the UDPIIPv6 function.
  - c. If IPv6Ex is enabled, try using the IPv6Ex function; else, if IPv6 is enabled, try using the IPv6 function.

The following combinations are currently supported:

- Any combination of IPv4, TCPIPv4, and UDPIIPv4, and or,
- Any combination of either IPv6, TCPIPv6, and UDPIIPv6 or IPv6Ex, TCPIPv6Ex, and UDPIIPv6Ex

When a packet cannot be parsed by the above rules, it enters hardware queue 0. The 32-bit tag (which is a result of the hash function) equals 0. The 5-bit MRQ field also equals zero.

In the case of tunneling (for example, IPv4-IPv6 tunnel), the external IP address (in the base header) is used.



The 32-bit result of the hash computation is written into the packet descriptor and also provides an index into the Indirection Table.

The following notation is used to describe the following hash functions:

- Ordering is little endian in both bytes and bits. For example, the IP address 161.142.100.80 translates into A18E 6450h in the signature.
- A “^” denotes bit-wise eXclusive OR (XOR) operation of same width vectors.
- @x-y denotes bytes x through y (including both of them) of the incoming packet, where byte 0 is the first byte of the IP header. In other words, we consider all byte offsets as offsets into a packet where the framing layer header has been stripped out. Therefore, the source IPv4 address is referred to as @12-15, while the destination v4 address is referred to as @16-19.
- @x-y, @v-w denotes concatenation of bytes x-y followed by bytes v-w, preserving the order in which they occurred in the packet.

All hash function variations (IPv4 and IPv6) follow the same general structure. Specific details for each variation are described in the following section. The hash uses a random secret key of length 320 bits (40 bytes). The key is generated and supplied through the RSS Random Key Register (RSSRK).

The algorithm works by examining each bit of the hash input from left to right. Our nomenclature defines left and right for a byte array as follows:

Given an array K with k bytes, our nomenclature assumes that the array is laid out as:

```
K[0] K[1] K[2] ... K[k-1]
```

K[0] is the left most byte, and the most significant bit of K[0] is the left most bit. K[k-1] is the right most byte, and the least significant bit of K[k-1] is the right most bit.

```
ComputeHash(input[], N)
```

For hash-input input[] of length N bytes (8N bits) and a random secret key K of 320 bits

```
Result = 0;
For each bit b in input[] {
    if (b == 1) then Result ^= (left-most 32 bits of K);
    shift K left 1 bit position;
}
return Result;
```

The following four pseudo-code examples are intended to help clarify exactly how the hash is to be performed in four cases: IPv4 with and without ability to parse the TCP header and IPv6 with and without a TCP header.

#### 5.4.2.1.1 Hash for IPv4 with TCP

Concatenate SourceAddress, DestinationAddress, SourcePort, DestinationPort into one single byte-array, preserving the order in which they occurred in the packet: Input[12] = @12-15, @16-19, @20-21, @22-23.

```
Result = ComputeHash(Input, 12);
```



#### 5.4.2.1.2 Hash for IPv4 with UDP

Concatenate `SourceAddress`, `DestinationAddress`, `SourcePort`, `DestinationPort` into one single byte-array, preserving the order in which they occurred in the packet: `Input[12] = @12-15, @16-19, @20-21, @22-23`.

```
Result = ComputeHash(Input, 12);
```

#### 5.4.2.1.3 Hash for IPv4 without TCP

Concatenate `SourceAddress` and `DestinationAddress` into one single byte-array

```
Input[8] = @12-15, @16-19
```

```
Result = ComputeHash(Input, 8)
```

#### 5.4.2.1.4 Hash for IPv6 with TCP

Similar to above:

```
Input[36] = @8-23, @24-39, @40-41, @42-43
```

```
Result = ComputeHash(Input, 36)
```

#### 5.4.2.1.5 Hash for IPv6 with UDP

Similar to above:

```
Input[36] = @8-23, @24-39, @40-41, @42-43
```

```
Result = ComputeHash(Input, 36)
```

#### 5.4.2.1.6 Hash for IPv6 without TCP

```
Input[32] = @8-23, @24-39
```

```
Result = ComputeHash(Input, 32)
```

### 5.4.2.2 Indirection Table

The indirection table is a 128-entry structure, indexed by the 7 least significant bits of the hash function output. Each entry of the table contains the following:

- Bit [7:6]: Queue index. for pool 1 or regular RSS
- Bits [5:4]: Reserved
- Bits [3:2]: Queue index for pool 0
- Bits [1:0]: Reserved

The Queue Index determines the physical queue for the packet.

System software can update the indirection table during run time. Such updates of the table are not synchronized with the arrival time of received packets. Therefore, it is not guaranteed that a table update takes effect on a specific packet boundary.



### 5.4.2.3 Support for Multiple Processors

It is assumed that each queue is associated with a specific processor, even when there are more processors than queues.

## 5.4.3 RSS Verification Suite

This section contains the values used in the given examples. Assume that the random key byte-stream is:

0x6d, 0x5a, 0x56, 0xda, 0x25, 0x5b, 0x0e, 0xc2,  
0x41, 0x67, 0x25, 0x3d, 0x43, 0xa3, 0x8f, 0xb0,  
0xd0, 0xca, 0x2b, 0xcb, 0xae, 0x7b, 0x30, 0xb4,  
0x77, 0xcb, 0x2d, 0xa3, 0x80, 0x30, 0xf2, 0x0c,  
0x6a, 0x42, 0xb7, 0x3b, 0xbe, 0xac, 0x01, 0xfa

### 5.4.3.1 IPv4

Destination Address/ Port	Source Address/Port	IPv4 only	IPv4 with TCP
161.142.100.80 :1766	66.9.149.187 :2794	323E 8FC2h	51CC C178h
65.69.140.83 :4739	199.92.111.2 :14230	D718 262Ah	C626 B0EAh
12.22.207.184 :38024	24.19.198.95 :12898	D2D0 A5DEh	5C2B 394Ah
209.142.163.6 :2217	38.27.205.30 :48228	8298 9176h	AFC7 327Fh
202.188.127.2 :1303	153.39.163.191 :44251	5D18 09C5h	10E8 28A2h

### 5.4.3.2 IPv6

The IPv6 address tuples are only for verification purposes and may not make sense as a tuple.

Destination Address/Port	Source Address/Port	IPv6 only	IPv6 with TCP
3FFE:2501:200:1FFF::7 (1766)	3FFE:2501:200:3::1 (2794)	2CC1 8CD5	4020 7D3D
FF02::1 (4739)	3FFE:501:8::260:97FF:FE40:EF AB (14230)	0F0C 461C	DDE5 1BBF
FE80::200:F8FF:FE21:67CF (38024)	3FFE:1900:4545:3:200:F8FF:F E21:67CF (44251)	4B61 E985	02D1 FEEF



## 5.5 Header Splitting and Replication

This feature consists of splitting or replicating a packet's header to a different memory space. This helps the host to fetch headers only for processing: headers are replicated through a regular snoop transaction, in order to be processed by the host processor. It is recommended to perform this transaction with the DCA feature enabled.

The packet (header + payload) is stored in memory through an optional non-snoop transaction.

The 82575 supports header splitting in several modes:

- Legacy mode: legacy descriptors are used; headers and payloads are not split.
- Advanced mode, no split: advanced descriptors are in use; header and payload are not split.
- Advanced mode, split: Advanced descriptors are in use; header and payload are split to different buffers.
- Advanced mode, replication: Advanced descriptors are in use; header is replicated in a separate buffer and in a payload buffer.
- Advanced mode, replication, conditioned by packet size: Advanced descriptors are in use; replication is performed only if the packet is larger than the header buffer size.
- Advanced mode, split: always use header buffer: Advanced descriptors are in use; header and payload are split to different buffers. If no split is done, the first part of the packet is stored in the header buffer.

Header splitting and header replication modes are shown in Figure 5.

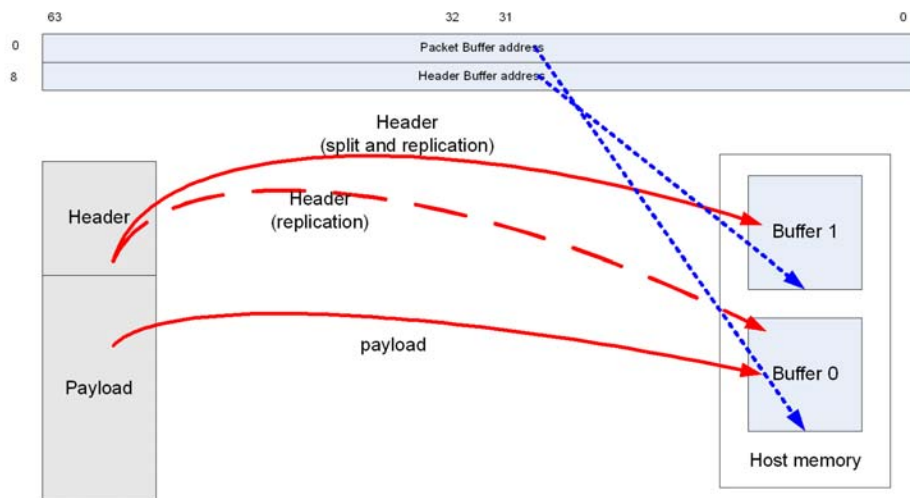

**Figure 5. Header Splitting with Replicated Header**

The physical address of each buffer is written in the Buffer Addresses fields. The sizes of these buffers are statically defined by BSIZEPACKET in the SRRCTL[n] registers.

The Packet Buffer Address includes the address of the buffer assigned to the replicated packet, including header and data payload portions of the received packet. In case of split header, only the payload is included.

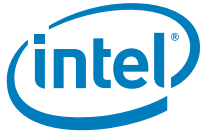

The Header Buffer Address includes the address of the buffer that contains the header information. The Receive DMA module stores the header portion of the received packets into this buffer.

The 82575 uses the Packet Replication or splitting feature when the `SRRCTL[n].DESCTYPE` is greater than one. The software device driver must also program the buffer sizes in the `SRRCTL[n]` registers.

When Header split is selected, the packet is split only on selected types of packets. A bit exists for each option in `PSRTYPE[n]` registers, so several options can be used in conjunction. If one or more bits are set, the splitting is performed for the corresponding packet type.

Table 33 lists the behavior of the 82575 in the different modes.



**Table 33. Header Splitting and Header Replication Mode**

DESCTYPE	Condition	SPH	HBO	PKT LEN	HDR LEN	Copy
Split	Header cannot be decoded	0b	0b	Min(packet length buffer size)	N/A	Header + Payload → Packet Buffer
	Header ≤ BSIZEHEADER	1b	0b	Min(payload length buffer size <sup>1</sup> )	Header size	Header → Packet Buffer Payload → Packet Buffer
	Header > BSIZEHEADER	1b	1b	Min(packet length buffer size)	Header size <sup>2</sup>	Header + Payload → Packet Buffer
Split (always use header buffer)	Packet length ≤ BSIZEHEADER	0b	0b	0b	Packet length	Header + Payload → Header Buffer
	Header cannot be decoded (packet length > BSIZEHEADER)	0b	0b	Min(packet length - BSIZE-HEADER, data buffer size)	BSIZE-HEADER	Header + Payload → Header + Packet Buffer <sup>3</sup>
	Header ≤ BSIZEHEADER	1b	0b	Min(payload length, data buffer size)	Header size	Header → Header Buffer Payload → Packet Buffer
	Header > BSIZEHEADER	1b	1b	Min(packet length - BSIZE-HEADER, data buffer size)	Header size <sup>b</sup>	Header + Payload → Header + Packet Buffer
Replicate	Header + payload ≤ BSIZEHEADER	0b/ 1b	0b	Min(packet length, buffer size)	Header size, N/A <sup>4</sup>	Header + Payload → Header Buffer Header + Payload → Packet Buffer
	Header + Payload > BSIZEHEADER	0b/ 1b	0b/1b <sup>5</sup>	Min(packet length, buffer size)	Header size, N/A <sup>d</sup>	(Header + Payload)(partial <sup>f</sup> ) → Header Buffer Header + Payload → Packet Buffer
Replicate large packet	Header + payload ≤ BSIZEHEADER	0b/ 1b	0b	Packet length	Header size, N/A <sup>d</sup>	Header + Payload → Header Buffer
	Header + Payload > BSIZEHEADER	0b/ 1b	0b/1b <sup>e</sup>	Min(packet length, buffer size)	Header size, N/A <sup>d</sup>	(Header + Payload)(partial <sup>g</sup> ) → Header Buffer Header + Payload → Packet Buffer

1. In a header only packet (for example. TCP ACK packet), PKT\_LEN is 0b.
2. The HDR\_LEN doesn't reflect the actual data size stored in the header buffer. It reflects the header size determined by the parser.
3. If the packet spans more than one descriptor, only the header buffer of the first descriptor is used.
4. If SPH = 0b, then the header size is not relevant. In any case, the HDR\_LEN doesn't reflect the actual data size stored in the Header buffer.
5. HBO is 1b if the header size is bigger than BSIZEHEADER; otherwise, 0b.
6. Partial means up to BSIZEHEADER.

**Note:** If SRRCTL#.NSE is set, all buffers' addresses in a packet descriptor must be word aligned. The packet header cannot span across buffers, therefore, the size of the header buffer must be larger than any expected header size. Otherwise, only the part of the header fitting the header buffer is replicated. In case of header split mode (SRRCTL.DESCTYPE = 010b), a packet with a header larger than the header buffer will not be split.



## 5.5.1 Receive Packet Checksum Offloading

The 82575 supports the offloading of three receive checksum calculations: the Packet Checksum, the IPv4 Header Checksum, and the TCP/UDP Checksum.

The Packet checksum is the one's complement over the receive packet, starting from the byte indicated by RXCSUM.PCSS (0b corresponds to the first byte of the packet), after stripping. For packets with VLAN header, the packet checksum includes the header if VLAN stripping is not enabled by the CTRL.VME. If VLAN header strip is enabled, the packet checksum and the starting offset of the packet checksum exclude the VLAN header due to masking of VLAN header. For example, for an Ethernet II frame encapsulated as an 802.3ac VLAN packet and CTRL.VME is set and with RXCSUM.PCSS set to 14, the Packet Checksum includes the entire encapsulated frame, excluding the 14-byte Ethernet header (DA, SA, Type/Length) and the 4-byte q-tag. The packet checksum does not include the Ethernet CRC if the RCTL.SECRC bit is set.

Software must make the required offsetting computation (to back out the bytes that should not have been included and to include the pseudo-header) prior to comparing the Packet Checksum against the TCP checksum stored in the packet.

For supported packet/frame types, the entire checksum calculation can be off-loaded to the 82575. If RXCSUM.IPOFL is set to 1b, the 82575 calculates the IPv4 checksum and indicates a pass/fail indication to software via the IPv4 Checksum Error bit (RDESC.IPE) in the ERROR field of the receive descriptor. Similarly, if RXCSUM.TUOFL is set to 1b, the 82575 calculates the TCP or UDP checksum and indicates a pass/fail condition to software via the TCP/UDP Checksum Error bit (RDESC.TCPE). These error bits are valid when the respective status bits indicate the checksum was calculated for the packet (RDESC.IPCS and RDESC.TCPCS respectively). Similarly, if RFCTL.IPv6\_DIS and RFCTL.IP6Xsum\_DIS are cleared to 0b and RXCSUM.TUOFL is set to 1b, the 82575 calculates the TCP or UDP checksum for IPv6 packets. It then indicates a pass/fail condition in the TCP/UDP Checksum Error bit (RDESC.TCPE).

If neither RXCSUM.IPOFLD nor RXCSUM.TUOFLD is set, the Checksum Error bits (IPE and TCPE) is 0b for all packets.

Supported Frame Types include:

- Ethernet II
- Ethernet SNAP

**Table 34. Supported Receive Checksum Capabilities**

Packet Type	HW IP Checksum Calculation	HW TCP/UDP Checksum Calculation
IPv4 packets	Yes <sup>1</sup>	Yes
IPv6 packets	No (n/a)	Yes
IPv6 packet with next header options:		
• Hop-by-Hop options	No (n/a)	Yes
• Destinations options	No (n/a)	Yes
• Routing (with LEN 0)	No (n/a)	Yes
• Routing (with LEN > 0)	No (n/a)	No
• Fragment	No (n/a)	No
• Home option	No (n/a)	No
IPv4 tunnels:		
• IPv4 packet in an IPv4 tunnel	Either IP or TCP <sup>a</sup>	Either IP or TCP <sup>a</sup>
• IPv6 packet in an IPv4 tunnel	Either IP or TCP <sup>a</sup>	Either IP or TCP <sup>a</sup>

**Table 34. Supported Receive Checksum Capabilities**

Packet Type	HW IP Checksum Calculation	HW TCP/UDP Checksum Calculation
IPv6 tunnels:		
• IPv4 packet in an IPv6 tunnel	No	No
• IPv6 packet in an IPv6 tunnel	No	No
Packet is an IPv4 fragment	Yes	No
Packet is greater than 1552 bytes; (LPE=1b)	Yes	Yes
Packet has 802.3ac tag	Yes	Yes
IPv4 Packet has IP options (IP header is longer than 20 bytes)	Yes	Yes
Packet has TCP or UDP options	Yes	Yes
IP header's protocol field contains a protocol # other than TCP or UDP.	Yes	No

1. For tunnels, the software device driver might only do the TCP checksum or IPv4 checksum. If the TCP checksum is desired, the software device driver should define the IP header length as the combined length of both IP headers in the packet. If an IPv4 checksum is required, the IP header length should be set to the IPv4 header length.

Table 34 lists the general details about what packets are processed. In more detail, the packets are passed through a series of filters to determine if a receive checksum is calculated.

### 5.5.1.1 MAC Address Filter

This filter checks the MAC destination address to be sure it is valid (IA match, broadcast, multicast, etc.). The receive configuration settings determine which MAC addresses are accepted. See the various receive control configuration registers such as RCTL (RTCL.UPE, RCTL.MPE, RCTL.BAM), MTA, RAL, and RAH.

### 5.5.1.2 SNAP/VLAN Filter

This filter checks the next headers looking for an IP header. It is capable of decoding Ethernet II, Ethernet SNAP, and IEEE 802.3ac headers. It skips past any of these intermediate headers and looks for the IP header. The receive configuration settings determine which next headers are accepted. See the various receive control configuration registers such as RCTL (RCTL.VFE), VET, and VFTA.

### 5.5.1.3 IPv4 Filter

This filter checks for valid IPv4 headers. The version field is checked for a correct value (4). IPv4 headers are accepted if they are any size greater than or equal to 5 (Dwords). If the IPv4 header is properly decoded, the IP checksum is checked for validity. The RXCSUM.IPOFL bit must be set for this filter to pass.

### 5.5.1.4 IPv6 Filter

This filter checks for valid IPv6 headers, which are a fixed size and have no checksum. The IPv6 extension headers accepted are: Hop-by-Hop, Destination Options, and Routing. The maximum size next header accepted is 16 Dwords (64 bytes).



### 5.5.1.5 IPv6 Extension Headers

IPv4 and TCP provide header lengths that allow hardware to easily navigate through these headers on packet reception for calculating checksums and CRCs, etc. For receiving IPv6 packets, however, there is no IP header length to help hardware find the packet's ULP (such as TCP or UDP) header. One or more IPv6 extension headers might exist in a packet between the basic IPv6 header and the ULP header. Hardware must skip over these extension headers to calculate the TCP or UDP checksum for received packets.

The IPv6 header length without extensions is 40 bytes. The IPv6 field *Next Header Type* indicates what type of header follows the IPv6 header at offset 40. It might be an upper layer protocol header such as TCP or UDP (Next Header Type of 6 or 17, respectively), or it might indicate that an extension header follows. The final extension header indicates with its *Next Header Type* field the type of ULP header for the packet.

IPv6 extension headers have a specified order. However, destinations must be able to process these headers in any order. Also, IPv6 (or IPv4) can be tunneled using IPv6, and thus another IPv6 (or IPv4) header and potentially its extension headers can be found after the extension headers.

The IPv4 Next Header Type is at byte offset 9. In IPv6, the first Next Header Type is at byte offset 6.

All IPv6 extension headers have the Next Header Type in their first 8 bits. Most have the length in the second 8 bits (Offset Byte[1]) as shown:

	1	2	3
0 1 2 3 4 5 6 7	8 9 0 1 2 3 4 5	6 7 8 9 0 1 2 3	4 5 6 7 8 9 0 1
Next Header Type	Length		

Table 35 lists the encodings of the *Next Header Type* field and information on determining each header type's length. The IPv6 extension headers are not otherwise processed by the 82575 so details are not covered.



**Table 35. Next Header Type Encodings**

Header	Next Header Type	Header Length (units are in bytes unless otherwise specified)
IPv6	6	Always 40 bytes
IPv4	4	Offset bits [7:4] Unit = 4 bytes
TCP	6	Offset byte [12, bits [7:4]] Unit = 4 bytes
UDP	17	Always 8 bytes
Hop by Hop Options	0 <sup>1</sup>	8 + offset byte [1]
Destination Options	60	8 + offset byte [1]
Routing	43	8 + offset byte [1]
Fragment	44	Always 8 bytes
Authentication	51	8 + 4* (offset byte [1])
Encapsulating Security Payload	50	2
No Next Header	59	3

1. Hop by Hop Options Header is only found in the first Next Header Type of an IPv6 Header.
2. Encapsulated Security Payload.
3. When a No Next Header type is encountered, the rest of the packet should not be processed.

**Note:** The 82575 hardware acceleration does not support all IPv6 Extension header types. Also, the RFACTL.Ipv6\_DIS bit must be cleared for this filter to pass.

### 5.5.1.6 UDP/TCP Filter

This filter checks for a valid UDP or TCP header. The prototype next header values are 11h and 06h, respectively. The RXCSUM.TUOFL bit must be set for this filter to pass.

## 5.6 Packet Transmission

The transmission process for regular (non-TCP Segmentation packets) involves:

- The protocol stack receives from an application a block of data that is to be transmitted.
- The protocol stack calculates the number of packets required to transmit this block based on the MTU size of the media and required packet headers.
- For each packet of the data block:
  - Ethernet, IP and TCP/UDP headers are prepared by the stack.
  - The stack interfaces with the software device driver and commands the driver to send the individual packet.
  - The software device driver gets the frame and interfaces with the hardware.
  - The hardware reads the packet from host memory (via DMA transfers).
  - The driver returns ownership of the packet to the Network Operating System (NOS) when the hardware has completed the DMA transfer of the frame (indicated by an interrupt).



Output packets are made up of pointer-length pairs constituting a descriptor chain (so called descriptor based transmission). Software forms transmit packets by assembling the list of pointer-length pairs, storing this information in the transmit descriptor, and then updating the on-chip transmit tail pointer to the descriptor. The transmit descriptor and buffers are stored in host memory. Hardware typically transmits the packet only after it has completely fetched all packet data from host memory and deposited it into the on-chip transmit FIFO. This permits TCP or UDP checksum computation, and avoids problems with PCIe\* underruns.

Another transmit feature is TCP Segmentation. The hardware has the capability to perform packet segmentation on large data buffers off-loaded from the Network Operating System (NOS). This feature is described in detail in [Section 5.8](#).

## 5.6.1 Transmit Data Storage

Data are stored in buffers pointed to by the descriptors. Alignment of data is on an arbitrary byte boundary with the maximum size per descriptor limited only to the maximum allowed packet size (9018 bytes). A packet typically consists of two (or more) descriptors, one (or more) for the header and one for the actual data. Some software implementations copy the header(s) and packet data into one buffer and use only one descriptor per transmitted packet.

## 5.6.2 Transmit Contexts

The 82575 provides hardware checksum offload and TCP Segmentation facilities. These features enable TCP and UDP packet types to be handled more efficiently by performing additional work in hardware, thus reducing the software overhead associated with preparing these packets for transmission. Part of the parameters used by these features are handled through contexts.

A context refers to a set of device registers loaded or accessed as a group to provide a particular function. The 82575 supports 16 context register sets on-chip. The transmit queues can contain Transmit Data Descriptors, much like the receive queue, and also Transmit Context Descriptors.

A transmit context descriptor differs from a data descriptor as it does not point to packet data. Instead, this descriptor provides the ability to write to the on-chip contexts that support the transmit checksum offloading and the segmentation features of the 82575.

The 82575 supports one type of transmit context: the extended context is written with a Transmit Context Descriptor DTYP = 2 and this context is always used for Transmit Data Descriptor DTYP = 3.

The IDX field contains an index to one of 16 on-chip contexts. Software must track what context is stored in each IDX location. Also, each advanced descriptor must refer to a context unless no offload is needed.

Contexts can be initialized with a Transmit Context Descriptor and then used for a series of related Transmit Data Descriptors. The context, for example, defines the checksum and offload capabilities for a given type of TCP/IP flows. All packets of this type can be sent using this context.

Contexts should only be over written by a Transmit Context Descriptor when there are no Transmit Data Descriptors in any queue that point to it. This is the only way for software to ensure that the correct context is used for the data. If context are statically allocated to queues and there are no cross referencing between data descriptor from one queue and context descriptor of another queue, then there are no limitation on the context descriptor setting.



Each context defines information about the packet sent including the total size of the MAC header (TDESC.MACHDR), the amount of payload data that should be included in each packet (TDESC.MSS), TCP Header length (TDESC.TCPHDR), IP Header length (TDESC.IPHDR) and information about what type of protocol (TCP, IP, etc.) is used. Other than TCP, IP (TDESC.TUCMD), most information is specific to the segmentation capability and is therefore ignored for context descriptors that do not have the *TSE* bit set.

Because there are dedicated resources on-chip for contexts, they remain constant until they are modified by another context descriptor. This means that a context can (and will) be used for multiple packets (or multiple segmentation blocks) unless a new context is loaded prior to each new packet. Depending on the environment, it might be completely unnecessary to load a new context for each packet. For example, if most traffic generated from a given node is standard TCP frames, this context could be setup once and used for many frames. Only when some other frame type is required would a new context need to be loaded by software using a different index.

This same logic can also be applied to the segmentation context, though the environment is a more restrictive one. In this scenario, the host is commonly asked to send messages of the same type, TCP/IP for instance, and these messages also have the same Maximum Segment Size (MSS). In this instance, the same segmentation context could be used for multiple TCP messages that require hardware segmentation.

### 5.6.3 Transmit Descriptors

The 82575 supports legacy and advanced descriptors.

Legacy descriptors are intended to support legacy drivers, in order to allow fast power up of platform, and to facilitate debug. The legacy descriptors are recognized as such based on the *DEXT* bit.

In addition, the 82575 supports two types of advanced transmit descriptors:

1. Advanced Transmit Context descriptor, DTYP = 0010b.
2. Advanced Transmit Data descriptor, DTYP = 0011b.

**Note:** DTYP = 0000b and 0001b are reserved values.

The Transmit Data Descriptor points to a block of packet data to be transmitted. The TCP/IP Context Transmit Descriptor does not point to packet data. It contains control/context information that is loaded into on-chip registers that affect the processing of packets for transmission. The following sections describe the descriptor formats.

### 5.6.4 Legacy Transmit Descriptor Format

To select legacy mode operation, bit 29 of the second line of the descriptor (TDSEC.DEXT) should be set to 0b. In this case, the descriptor format is defined as shown in [Table 36](#). The address and length must be supplied by software. Bits in the command byte are optional, as are the Checksum Offset (CSO), and Checksum Start (CSS) fields.



Table 36. Transmit Descriptor (TDESC) Layout – Legacy Mode

	63	48	47	40	39	36	35	32	31	24	23	16	15	0
0	Buffer Address [63:0]													
8	Special	CSS	ExtCMD	STA	CMD	CSO	Length							

## 5.6.5 Transmit Descriptor Write Back Format

	63	48	47	40	39	36	35	32	31	24	23	16	15	0
0	Buffer Address [63:0]													
8	Special	CSS	Reserved	STA	CMD	CSO	Length							

### 5.6.5.1 Length

Length (TDESC.LENGTH) specifies the length in bytes to be fetched from the buffer address provided. The maximum length associated with any single legacy descriptor is 9018 bytes.

**Note:** The maximum allowable packet size for transmits changes based on the value written to the Packet Buffer Allocation register.

Descriptor length(s) can be limited by the size of the transmit FIFO. All buffers comprising a single packet must be able to be stored simultaneously in the transmit FIFO. For any individual packet, the sum of the individual descriptors' lengths must be below 9018 bytes.

**Note:** Descriptors with zero length (null descriptors) transfer no data. Null descriptors might appear only between packets and must have their *EOP* bits set.

### 5.6.5.2 Checksum Offset and Start (CSO and CSS)

A checksum offset (TDESC.CSO) field indicates where, relative to the start of the packet, to insert a TCP checksum if this mode is enabled. A checksum start (TDESC.CSS) field indicates where to begin computing the checksum. Both CSO and CSS are in units of bytes. These must both be in the range of data provided to the device in the descriptor. This means for short packets that are padded by software, CSS and CSO must be in the range of the unpadded data length, not the eventual padded length (64 bytes).

With an 802.1Q header, the offset values depend on the VLAN insertion enable bit - CTRL.VME and the VLE bit. If they are not set (VLAN tagging included in the packet buffers), the offset values should include the VLAN tagging. If these bits are set (VLAN tagging is taken from the packet descriptor), the offset values should exclude the VLAN tagging.

Hardware does not add the 802.1Q Ether Type or the VLAN field following the 802.1Q Ether Type to the checksum. So for VLAN packets, software can compute the values to back out only on the encapsulated packet rather than on the added fields.

**Note:** UDP checksum calculation is not supported by the legacy descriptor because the legacy descriptor does not support the translation of a checksum result of 0000h to FFFFh needed to differentiate between an UDP packet with a checksum of zero and an UDP packet without checksum.





Because the CSO field is eight bits wide, it puts a limit the location of the checksum to 255 bytes from the beginning of the packet.

EOP, when set, indicates the last descriptor making up the packet. One or many descriptors can be used to form a packet. Hardware inserts a checksum at the offset indicated by the CSO field if the Insert Checksum bit (IC) is set. Checksum calculations are for the entire packet starting at the byte indicated by the CSS field. A value of 0 corresponds to the first byte in the packet. CSS must be set in the first descriptor for a packet. In addition, IC is ignored if CSO or CSS are out of range. This occurs if  $(CSS \geq \text{length})$  or  $(CSO \geq \text{length} - 1)$ .

**Note:** CSO must be larger than CSS and CSS must be equal or bigger than 14 bytes, and CSO must be smaller than the packet length minus 4 bytes.

### 5.6.5.3 Command Byte (CMD)

The CMD byte stores the applicable command and has fields shown in [Table 37](#).

Software must compute an offsetting entry to back out the bytes of the header that are not part of the IP pseudo header and should not be included in the TCP checksum and store it in the position where the hardware computed checksum is inserted.

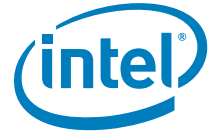

**Table 37. Transmit Command (TDESC.CMD) Layout**

7	6	5	4	3	2	1	0
RSV	VLE	DEXT	RSV	RS	IC	IFCS	EOP

TDESC.CMD	Description
Reserved (bit 7)	Reserved.
VLE (bit 6)	<p>VLAN Packet Enable</p> <p>Indicates that the packet is a VLAN packet (for example, hardware should add the VLAN Ether type and an 802.1q VLAN tag to the packet).</p> <p>When set to 0b, sends generic Ethernet packet.</p> <p>When set to 1b, sends 802.1Q packet; the Ethernet Type field comes from the VET register and the VLAN data comes from the special field of the TX descriptor.</p> <p><b>Note:</b> If the <i>VLE</i> bit is set, the CTRL.VME bit should also be set to enable VLAN tag insertion. If the CTRL.VME bit is not set, the 82575 does not insert VLAN tags on outgoing packets.</p>
DEXT (bit 5)	<p>Extension (0b for legacy mode).</p> <p>Should be written with 0b for future compatibility.</p>
RSV (bit 4)	<p>Reserved</p> <p>Should be programmed to 0b.</p>
RS (bit 3)	<p>Report Status</p> <p>Signals hardware to report the status information. This is used by software that does in-memory checks of the transmit descriptors to determine which ones are done. For example, if software queues up 10 packets to transmit, it can set the RS bit in the last descriptor of the last packet. If software maintains a list of descriptors with the RS bit set, it can look at them to determine if all packets up to (and including) the one with the RS bit set have been buffered in the output FIFO. Looking at the status byte and checking the Descriptor Done (DD) bit do this. If DD is set, the descriptor has been processed.</p>
IC (bit 2)	<p>Insert Checksum</p> <p>When set, the 82575 needs to insert a checksum at the offset indicated by the CSO field. The checksum calculations are performed for the entire packet starting at the byte indicated by the CCS field. IC is ignored if CSO and CCS are out of the packet range. This occurs when <math>(CSS \geq \text{length})</math> or <math>(CSO \geq \text{length} - 1)</math>. IC is valid only when EOP is set.</p>
IFCS (bit 1)	<p>Insert FCS</p> <p>When set, hardware appends the MAC FCS at the end of the packet. When cleared, software should calculate the FCS for proper CRC check. There are several cases in which software must set IFCS:</p> <ul style="list-style-type: none"> <li>Transmission of short packet while padding is enabled by the <i>TCTL.PSP</i> bit</li> <li>Checksum offload is enabled by the <i>IC</i> bit in the TDESC.CMD</li> <li>VLAN header insertion enabled by the <i>VLE</i> bit in the TDESC.CMD</li> </ul>
EOP (bit 0)	<p>End Of Packet</p> <p>When set, indicates the last descriptor making up the packet. One or many descriptors can be used to form a packet.</p>

**Note:** When tail write-back is enabled, the descriptor write-back is not executed.



### 5.6.5.4 Transmit Descriptor Status Field Format

Table 38. Transmit Status Layout

3	2	1	0
Reserved			DD

TDESC.STATUS	Description
RSV (bits 3:1)	Reserved. Should be programmed to 000b.
DD (bit 0)	Descriptor Done Indicates that the descriptor is finished and is written back either after the descriptor has been processed (with RS set).

### 5.6.6 Transmit Descriptor Special Field Format

The *Special* field is used to provide the 802.1q/802.1ac tagging information and is qualified only on the first descriptor of each packet when the VLE bit is set.



**Table 39. Special Field (TDESC.SPECIAL) Layout**

15	13	12	11	0
PRI		CFI		VLAN

TDESC.SPECIAL	Description
PRI	User Priority 3 bits that provide the VLAN user priority field to be inserted in the 802.1Q tag.
CFI	Canonical Form Indicator.
VLAN	VLAN Identifier 12 bits that provide the VLAN identifier field to be inserted in the 802.1Q tag.

### 5.6.7 Advanced Transmit Context Descriptor

**Table 40. Transmit Context Descriptor (TDESC) Layout – (Type = 0010b)**

	63	48	47	40	39	32	31	1	15	9	8	0					
0	SN					VLAN			MACLEN	IPLen							
8	MSS			L4LEN	IDX	RSV	ADV	DTYP	TCMD		MKRLOC						
	63	48	47	40	39	36	35	32	31	24	23	2	1	0	9	8	0

**Table 41. Transmit Context Descriptor (TDESC) Layout**

Field	Description
IPLen	IP Header Length If an offload is requested, IPLen must be greater than or equal to 6 and less than or equal to 511.
MACLEN	MAC Header Length When an offload is requested (one of TSE or IXSM or TXSM is set), MACHDR must be larger than or equal to 14 and less than or equal to 127.
VLAN	Insert 802.1Q VLAN tag in Packet During Transmission This VLAN tag is inserted and needed only when a packet using this context has its DCMD.VLE bit set.
Reserved	Reserved
MKRLOC	IP Checksum Offset For MPA streams, the location of markers in the TCP stream is at (SeqNum mod 512) = MKRLOC. Markers are inserted when DCMD.
TUCMD	TCP/UDP command field The command field provides options that control the checksum offloading, along with some of the generic descriptor processing functions. Bits 10:5 - Reserved Bit 4 - MKRREQ, when set to 1b, indicates that markers are required for this request. Bit 3:2 - L4T Packet Type (L4T), 00b = UDP; 01 = TCP; 10b, 11b = Reserved. Bit 1 - IP Packet Type (IPv4), when set to 1b = IPv4; when set to 0b = IPv6. Bit 0 - SNAP indication.

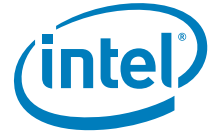

Field	Description
DTYP	Descriptor Type Always set to 0010b for this type of descriptor.
ADV	Bits 7:6 - Reserved. Bit 5 - DEXT, description extension (1b for advanced mode). Bits 4:0 - Reserved.
IDX	Index into the hardware table where CD is placed.
L4LEN	Layer 4 Header Length If TSE is set, this field is greater than or equal to 12 and less than or equal to 255. Otherwise, this field is ignored
MSS	Maximum Segment Size Control See <a href="#">Section 5.6.7.1</a> .

### 5.6.7.1 Maximum Segment Size (MSS) Control

This field specifies the maximum TCP payload segment sent per frame, less any header. The total length of each frame (or section) sent by the TCP Segmentation mechanism (excluding Ethernet CRC) is as follows:

The one exception is the last packet of a TCP segmentation which is (typically) shorter.

Software calculates the MSS which is the amount of TCP data which should be used before markers and CRC are added. As a result, software reduces the MSS sent down to hardware by the maximum amount of bytes that can be added for markers/CRC. The actual number of bytes of TCP data sent out on the wire is greater than this MSS value each time markers and CRC are added by hardware.

**Note:** L5LEN is computed internally. L5LEN = 16 for tagged buffers and 20 for untagged buffers according to TUCMD. DDPTYP.

The total length is smaller or equal to 9014 bytes.

MSS is ignored when DCMD.TSE is not set.

**Note:** The header lengths must meet the following:

$MACLEN + IPLEN + L4LEN \leq 512$

**Note:** MACLEN is augmented by 4 bytes if VLAN is active.

The context descriptor requires valid data only in the fields used by the specific offload options. [Table 42](#) lists the required valid fields according to the different offload options.



**Table 42. Advanced Transmit Context Descriptor Required Valid Fields**

Required Offload			Valid Fields in Context							
TSE	TXSM	IXSM	VLAN	L4LEN	IPLN	MACLEN	MSS	MKRLOC SN MKRREQ	L4T	IPV4
N/A	1b	1b	VLE	yes	yes	yes	yes	yes	yes	yes
1b	1b	1b	VLE	yes	yes	yes	yes	no	yes	yes
0b	1b	X	VLE	no	yes	yes	no	no	yes	yes
0b	0b	1b	VLE	no	yes	yes	no	no	no	yes
0b	0b	0b	VLE	no	no	no	no	no	no	no

### 5.6.8 Advanced Transmit Data Descriptor

Table 43 and Table 44 list the advanced transmit data descriptor read and write-back formats.

**Table 43. Advanced Transmit Data Descriptor Read Format**

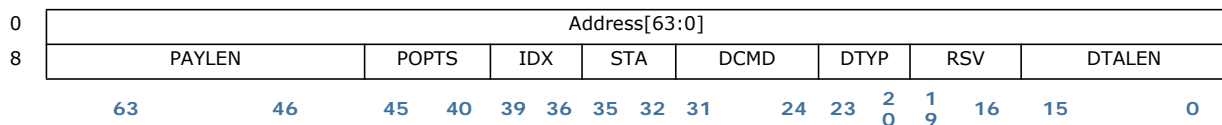

**Table 44. Advanced Transmit Data Descriptor Write-Back Format**

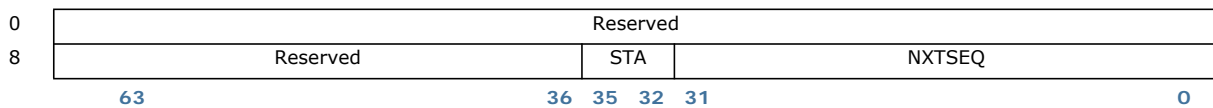

#### 5.6.8.1 Address

The physical address of a data buffer in host memory that contains a portion of a transmit packet.

#### 5.6.8.2 DTALEN

The length (in bytes) of data buffer at the address pointed to by this specific descriptor.

#### 5.6.8.3 DTYP

Always set to 0011b for this descriptor type.



## 5.6.8.4 DCMD

### DCMD Layout

Field	Description
TSE	<p>TCP Segmentation Enable</p> <p>Indicates a TCP segmentation request. When <i>TSE</i> is set in the first descriptor of a TCP packet, hardware uses the corresponding context descriptor in order to perform TCP segmentation.</p> <p><b>Note:</b> TCTL.PSP must be enabled when <i>TSE</i> is true since the last frame can be shorter than 60 bytes, resulting in a bad frame if TCTL.PSP is disabled.</p> <p><b>Note:</b> If a TSO frame spans multiple descriptors, the <i>TSE</i> bit must be set only in the first data descriptor.</p>
VLE	<p>VLAN Packet Enable</p> <p>Indicates that the packet is a VLAN packet (for example, hardware adds the VLAN Ether type and an 802.1q VLAN tag to the packet).</p>
DEXT	<p>Descriptor Extension (1b for Advanced Mode)</p> <p>Must be set to 1b to indicate advanced descriptor format (not legacy).</p>
Reserved	Reserved
RS	<p>Report Status</p> <p>Signals hardware to report the status information. This is used by software that does in-memory checks of the transmit descriptors to determine which ones are done. For example, if software queues up to 10 packets to transmit, it can set the RS bit in the last descriptor of the last packet. If software maintains a list of descriptors with the RS bit set, it can look at them to determine if all packets up to (and including) the one with the RS bit set have been buffered in the output FIFO. Looking at the status byte and checking the <i>Descriptor Done</i> (DD) bit do this. If DD is set, the descriptor has been processed.</p> <p><b>Note:</b> Descriptors with a zero length transfer no data.</p>
Reserved	Reserved
DTYP	<p>Descriptor Type</p> <p>Always set to 0010b for this type of descriptor.</p>
IFCS	<p>Insert FCS</p> <p>When set, hardware appends the MAC FCS at the end of the packet. When cleared, software should calculate the FCS for proper CRC check. There are several cases in which software must set IFCS:</p> <ul style="list-style-type: none"> <li>Transmission of short packet while padding is enabled by the TCTL.PSP bit.</li> <li>Checksum offload is enabled by the either TXSM or IXSM bits in the TDESC.DCMD.</li> <li>VLAN header insertion enabled by the VLE bit in the TDESC.DCMD.</li> <li>TCP segmentation offload enabled by the TSE bit in the TDESC.DCMD.</li> </ul>
EOP	<p>End of Packet</p> <p>EOP indicates whether this is the last buffer of the packet.</p>



### 5.6.8.5 STA

Table 45. STA Layout

Field	Description
Reserved (bits 3:1)	Reserved.
DD (bit 0)	Descriptor Done.

### 5.6.8.6 IDX

Index into the hardware context table to indicate which context should be used for this request. If no offload is required, this field is not relevant and no context needs to be initiated before the packet is sent.

### 5.6.8.7 POPTS

Table 46. POPTS Layout

Field	Description
Reserved (bits 5:2)	Reserved.
TXSM (bit 1)	Insert TCP/UDP Checksum When set to 1b, TCP / UDP checksum is inserted. In this case, TUCMD.L4T indicates whether the checksum is TCP or UDP. When TUCMD.TSE is set, TXSM must be set to 1b. If this bit is set, the packet should at least contain a TCP header.
IXSM (bit 1)	Insert IP Checksum When set to 1b, indicates that IP Checksum is inserted. In IPv6 mode, it must be reset to 0b. If the TUCMD.TSE bit is set and TUCMD.IPV4 is set, IXSM must be set to 1b as well. If this bit is set, the packet should at least contain an IP header.

### 5.6.8.8 PAYLEN

The length (in bytes) of the large send payload or single send full Ethernet packet. PAYLEN indicates the size of the data to be read from the host, which means the raw data length without markers, CRC, and padding. In the case of a single send packet, PAYLEN should not include the parts of the packet added by hardware such as CRC, VLAN tag, or padding.

**Note:** PAYLEN is ignored if TSE is not set.

When a packet spreads over multiple descriptors, all the descriptor fields are only valid in the 1st descriptor of the packet, except for RS, which is always checked, and EOP, which is always set at last descriptor of the series.

## 5.7 Transmit Descriptor Ring Structure

The transmit descriptor ring structure is shown in [Figure 6](#). A pair of hardware registers maintains the transmit queue. New descriptors are added to the ring by writing descriptors into the circular buffer memory region and moving the ring's tail pointer. The tail pointer points one entry beyond the last hardware owned descriptor (but at a point still within the descriptor ring). Transmission continues up to the descriptor where head equals tail at which point the queue is empty.





Descriptors passed to hardware should not be manipulated by software until the head pointer has advanced past them.

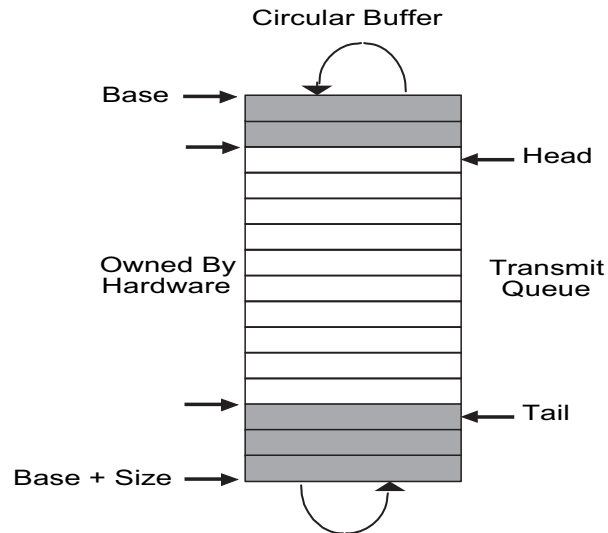

**Figure 6. Transmit Descriptor Ring Structure**

Shaded boxes in Figure 6 represent descriptors that have been transmitted but not yet reclaimed by software. Reclaiming involves freeing up buffers associated with the descriptors.

The transmit descriptor ring is described by the following registers:

- **Transmit Descriptor Base Address registers (TDBA0-3)**  
These registers indicate the start address of the descriptor ring buffer in the host memory. This 64-bit address is aligned on a 16-byte boundary and is stored in two consecutive 32-bit registers. Hardware ignores the lower 4 bits.
- **Transmit Descriptor Length register (TDLEN0-3)**  
These registers determine the number of bytes allocated to the circular buffer. This value must be 128 byte aligned.
- **Transmit Descriptor Head register (TDH0-3)**  
These registers hold a value which is an offset from the base and indicates the in-progress descriptor. There can be up to 8 KB descriptors in the circular buffer. Reading these registers return the value of the head that corresponding to descriptors already loaded in the output FIFO. This register reflects the internal head of the hardware write-back process including descriptor in the posted write pipe and might point further ahead than the last descriptor actually written back to memory.
- **Transmit Descriptor Tail register (TDT0-3)**  
These registers hold a value, which is an offset from the base, and indicates the location beyond the last descriptor hardware can process. This is the location where software writes the first new descriptor.

The base register indicates the start of the circular descriptor queue and the length register indicates the maximum size of the descriptor ring. The lower seven bits of length are hard-wired to 0b. Byte addresses within the descriptor buffer are computed as follows:



$address = base + (ptr * 16)$ , where  $ptr$  is the value in the hardware head or tail register.

The size chosen for the head and tail registers permit a maximum of 64 K descriptors, or approximately 16 K packets for the transmit queue given an average of four descriptors per packet.

Once activated, hardware fetches the descriptor indicated by the hardware head register. The hardware tail register points one beyond the last valid descriptor. Software reads the head register to determine which packets—those logically before the head—have been transferred to the on-chip FIFO or transmitted.

All the registers controlling the descriptor rings behavior should be set before transmit is enabled, apart from the tail registers which are used during the regular flow of data.

**Note:** Software determines if a packet has been sent by either of three methods:

- Setting the RS bit in the transmit descriptor command field or by performing a PIO read of the transmit head register or by reading the head value written by the 82575 to the address pointed by the TDWBAL and TDWBAH register.
- Checking the transmit descriptor DD bit or head value in memory eliminates a potential race condition. All descriptor data is written to the IO bus prior to incrementing the head register, but a read of the head register could pass the data write in systems performing IO write buffering.
- Updates to transmit descriptors use the same IO write path and follow all data writes. Consequently, they are not subject to the race.

In general, hardware prefetches packet data prior to transmission. Hardware typically updates the value of the head pointer after storing data in the transmit FIFO.

## 5.7.1 Transmit Descriptor Fetching

The descriptor processing strategy for transmit descriptors is essentially the same as for receive descriptors except that a different set of thresholds are used. As for receives, the number of on-chip transmit descriptors has been increased (from 8 to 64), and the fetch and write-back algorithms modified.

When the on-chip buffer is empty, a fetch happens as soon as any descriptors are made available (host writes to the tail pointer). When the on-chip buffer is nearly empty ( $TXDCTL[n].PTHRESH$ ), a prefetch is performed each time enough valid descriptors ( $TXDCTL[n].HTHRESH$ ) are available in host memory and no other DMA activity of greater priority is pending (descriptor fetches and write-backs or packet data transfers).

When the number of descriptors in host memory is greater than the available on-chip descriptor storage, the chip may elect to perform a fetch which is not a multiple of cache line size. The hardware performs this non-aligned fetch if doing so results in the next descriptor fetch being aligned on a cache line boundary. This allows the descriptor fetch mechanism to be most efficient in the cases where it has fallen behind software.

**Note:** The 82575 **NEVER** fetches descriptors beyond the descriptor tail pointer.

## 5.7.2 Transmit Descriptor Write-Back

The descriptor write-back policy for transmit descriptors is similar to that for receive descriptors with a few additional factors. First, since transmit descriptor write-backs are optional (controlled by RS in the transmit descriptor), only descriptors that have one (or both) of these bits set start the accumulation of



write-back descriptors. Secondly, to preserve backward compatibility, if the TXDCTL[n].WTHRESH value is 0b, the 82575 writes back a single byte of the descriptor (TDESCR.STA) and all other bytes of the descriptor are left unchanged.

Since the benefit of delaying and then bursting transmit descriptor write-backs is small at best, it is likely that the threshold are left at the default value (0b) to force immediate write-back of transmit descriptors and to preserve backward compatibility.

Descriptors are written back in one of three conditions:

- TXDCTL[n].WTHRESH = 0b and a descriptor which has RS set is ready to be written back
- The corresponding EITR counter has reached zero
- TXDCTL[n].WTHRESH > 0b and TXDCTL[n].WTHRESH descriptors have accumulated

For the first condition, write-backs are immediate. This is the default operation and is backward compatible.

The other two conditions are only valid if descriptor bursting is enabled. In the second condition, the EITR counter is used to force timely write-back of descriptors. The first packet after timer initialization starts the timer. Timer expiration flushes any accumulated descriptors and sets an interrupt event (TXDW).

For the final condition, if TXDCTL[n].WTHRESH descriptors are ready for write-back, the write-back is performed.

## 5.8 TCP Segmentation

Hardware TCP Segmentation is one of the off-loading options of most modern TCP/IP stacks. This is often referred to as Transmit Segmentation Offloading (TSO). This feature enables the TCP/IP stack to pass to the 82575's software device driver a message to be transmitted that is bigger than the Maximum Transmission Unit (MTU) of medium. It is then the responsibility of the software device driver and hardware to carve the TCP message into MTU size frames that have appropriate layer 2 (Ethernet), 3 (IP), and 4 (TCP) headers. These headers must include sequence number, checksum fields, options and flag values as required. Note that some of these values (such as the checksum values) are unique for each packet of the TCP message, and other fields such as the source IP address are constant for all packets associated with the TCP message.

Padding (TCTL.PSP) must be enabled in TCP segmentation mode, since the last frame might be shorter than 60 bytes - resulting in a bad frame if PSP is disabled.

The offloading of these mechanisms to the software device driver and the 82575 saves significant CPU cycles. The software device driver shares the additional tasks to support these options with the 82575.

**Note:** Although the 82575's TCP segmentation offload implementation was specifically designed to take advantage of new "TCP Segmentation offload" features, the hardware implementation was made generic enough so that it could also be used to "segment" traffic from other protocols. For instance, this feature could be used any time it is desirable for hardware to segment a large block of data for transmission into multiple packets that contain the same generic header.



## 5.8.1 Assumptions

The following assumption applies to the TCP Segmentation implementation in the 82575: The RS bit operation is not changed. Interrupts are set after data in buffers pointed to by individual descriptors is transferred to hardware.

## 5.8.2 Transmission Process

The transmission process for regular (non-TCP Segmentation packets) involves:

- The protocol stack receives from an application a block of data that is to be transmitted.
- The protocol stack calculates the number of packets required to transmit this block based on the MTU size of the media and required packet headers.
- For each packet of the data block:
  - Ethernet, IP and TCP/UDP headers are prepared by the stack.
  - The stack interfaces with the software device driver and commands the driver to send the individual packet.
  - The software device driver gets the frame and interfaces with the hardware.
  - The hardware reads the packet from host memory (via DMA transfers).
- The software device driver returns ownership of the packet to the operating system when the hardware has completed the DMA transfer of the frame (indicated by an interrupt).

The transmission process for the 82575 TCP segmentation offload implementation involves:

- The protocol stack receives from an application a block of data that is to be transmitted.
- The stack interfaces to the software device driver and passes the block down with the appropriate header information.
- The software device driver sets up the interface to the hardware (via descriptors) for the TCP Segmentation context.
- The hardware transfers the packet data and performs the Ethernet packet segmentation and transmission based on offset and payload length parameters in the TCP/IP context descriptor including:
  - Packet encapsulation
  - Header generation and field updates including IPv4, IPv6 and TCP/UDP checksum generation
- The software device driver returns ownership of the block of data to the operating system when the hardware has completed the DMA transfer of the entire data block (indicated by an interrupt).

### 5.8.2.1 TCP Segmentation Data Fetch Control

To perform TCP Segmentation in the 82575, DMA must be able to fit at least one packet of the segmented payload into available space in the on-chip packet buffer. DMA does various comparisons between the remaining payload and the packet buffer available space, fetching additional payload and sending additional packets as space permits.

## 5.8.3 TCP Segmentation Performance

Performance improvements for a hardware implementation of TCP Segmentation offload mean:



- The stack does not need to partition the block to fit the MTU size (saves CPU cycles).
- The stack only computes one Ethernet, IP, and TCP header per segment (saves CPU cycles).
- The stack interfaces with the software device driver only once per block transfer, instead of once per frame.
- Larger PCI bursts are used which improves bus efficiency (for example, lowering transaction overhead).
- Interrupts are easily reduced to one per TCP message instead of one per packet.
- Fewer I/O accesses are required to command the hardware.

### 5.8.4 Packet Format

Typical TCP/IP transmit window size is 8760 bytes (about 6 full size frames). A TCP message can be as large as 256 KB and is generally fragmented across multiple pages in host memory. The 82575 partitions the data packet into standard Ethernet frames prior to transmission. The 82575 supports calculating the Ethernet, IP, TCP, and even UDP headers, including checksum, on a frame by frame basis.

Ethernet	IPv4/IPv6	TCP/UDP	DATA	FCS
----------	-----------	---------	------	-----

Figure 7. TCP/IP Packet Format

Frame formats supported by the 82575 include:

- Ethernet 802.3
- IEEE 802.1q VLAN (Ethernet 802.3ac)
- Ethernet Type 2
- Ethernet SNAP
- IPv4 headers with options
- IPv6 headers with extensions
- TCP with options
- UDP with options

VLAN tag insertion is handled by hardware.

UDP (unlike TCP) is not a reliable protocol and fragmentation is not supported at the UDP level. UDP messages that are larger than the MTU size of the given network medium are normally fragmented at the IP layer. This is different from TCP, where large TCP messages can be fragmented at either the IP or TCP layers depending on the software implementation. The 82575 has the ability to segment UDP traffic (in addition to TCP traffic), however, because UDP packets are generally fragmented at the IP layer, the 82575's TCP Segmentation feature is normally not conducive to handling UDP traffic.

### 5.8.5 TCP Segmentation Indication

Software indicates a TCP Segmentation transmission context to the hardware by setting up a TCP/ IP Context Transmit Descriptor. The purpose of this descriptor is to provide information to the hardware to be used during the TCP segmentation offload process.



Setting the TSE bit in the TUCMD field to 1b indicates that this descriptor refers to the TCP Segmentation context (as opposed to the normal checksum offloading context). This causes the checksum offloading, packet length, header length, and maximum segment size parameters to be loaded from the descriptor into the 82575.

The TCP Segmentation prototype header is taken from the packet data itself. Software must identify the type of packet that is being sent (IPv4/IPv6, TCP/UDP, other), calculate appropriate checksum offloading values for the desired checksums, and calculate the length of the header which is prepended. The header can be up to 240 bytes in length.

Once the TCP Segmentation context has been set, the next descriptor provides the initial data to transfer. This first descriptor(s) must point to a packet of the type indicated. Furthermore, the data it points to might need to be modified by software as it serves as the prototype header for all packets within the TCP Segmentation context. The following sections describe the supported packet types and the various updates that are performed by hardware. This should be used as a guide to determine what must be modified in the original packet header to make it a suitable prototype header.

The following summarizes the fields considered by the software device driver for modification in constructing the prototype header:

- IP Header:
  - Length should be set to zero
- For IPv4 Headers:
  - Identification field should be set as appropriate for first packet of send (if not already)
  - Header checksum should be zeroed out unless some adjustment is needed by the software device driver
- TCP Header:
  - Sequence number should be set as appropriate for first packet of send (if not already)
  - PSH and FIN flags should be set as appropriate for last packet of send
  - TCP checksum should be set to the partial pseudo-header checksum as follows:

IP Source Address		
IP Destination Address		
Zero	Layer 4 Protocol ID	Zero

Figure 8. TCP Partial Pseudo-Header Checksum for IPv6

IPv6 Source Address	
IPv6 Final Destination Address	
Zero	
Zero	Next Header

Figure 9. TCP Partial Pseudo-Header Checksum for IPv4



- UDP Header:
  - The 82575's DMA function fetches the Ethernet, IP, and TCP/UDP prototype header information from the initial descriptor(s) and save them on-chip for individual packet header generation. The following sections describe the updating process performed by the hardware for each frame sent using the TCP Segmentation capability.

### 5.8.6 IP and TCP/UDP Headers

This section outlines the format and content for the IP, TCP and UDP headers. The 82575 requires baseline information from the software device driver in order to construct the appropriate header information during the segmentation process.

Header fields that are modified by the 82575 are highlighted in the figures that follow.

**Note:** IPv4 requires the use of a checksum for the header. IPv6 does not use a header Checksum. IPv4 length includes the TCP and IP headers as well as data. IPv6 length does not include the IPv6 header.

The IPv4 header is first shown in the traditional (RFC 791) representation, and because byte and bit ordering is confusing in that representation, the IP header is also shown in little-endian format. The actual data is fetched from memory in little-endian format.

0 1 2 3 4 5 6 7								1 8 9 0 1 2 3 4 5								2 6 7 8 9 0 1 2 3								3 4 5 6 7 8 9 0 1							
Version				IP Hdr Length				TYPE of service								Total length															
Identification								Flags				Fragment Offset																			
Time to Live				Layer 4 Protocol ID								Header Checksum																			
Source Address																															
Destination Address																															
Options																															

Figure 10. IPv4 Header (Traditional Representation)

Byte3				Byte2				Byte1				Byte0														
7 6 5 4 3 2 1 0				7 6 5 4 3 2 1 0				7 6 5 4 3 2 1 0				7 6 5 4 3 2 1 0														
LSB				Total length				MSB				TYPE of Service				Version		IP Hdr Length								
Fragment Offset Low				R	E	S	N	F	M	F	Fragment Offset High				LSB				Identification				MSB			
Header Checksum								Layer 4 Protocol ID				Time to Live														
Source Address																										
Destination Address																										
Options																										



Figure 11. IPv4 Header (Little-Endian Order)

**Note:** Identification is incremented on each packet.

Flags Field Definition:

The Flags field is defined below. Note that hardware does not evaluate or change these bits.

- MF - More Fragments
- NF - No Fragments
- Reserved

The 82575 does TCP segmentation not IP fragmentation. IP fragmentation might occur in transit through a network's infrastructure.

0 1 2 3 4 5 6 7								8 9 0 1 2 3 4 5								6 7 8 9 0 1 2 3								4 5 6 7 8 9 0 1							
Version				Priority				Flow Label																							
Payload Length												Next Header Type								Hop Limit											
Source Address																															
Destination Address																															
Extensions (if any)																															

Figure 12. IPv6 TCP Header (Traditional Representation)

Byte3								Byte2								Byte1								Byte0							
7 6 5 4 3 2 1 0								7 6 5 4 3 2 1 0								7 6 5 4 3 2 1 0								7 6 5 4 3 2 1 0							
Flow Label																Version				Priority											
Hop Limit				Next Header Type								LSB				Payload Length								MSB							
Source Address																															
Destination Address																															
Extensions																															

Figure 13. IPv6 Header (Little Endian Order)

A TCP or UDP frame uses a 16 bit wide one's complement checksum. The checksum word is computed on the outgoing TCP or UDP header and payload, and on the Pseudo Header. Details on checksum computations are provided in Section 3.8.

**Note:** TCP and UDP over IPv6 requires the use of checksum, where it is optional for UDP over IPv4.





The TCP header is first shown in the traditional (RFC 793) representation. Because byte and bit ordering is confusing in that representation, the TCP header is also shown in little-endian format. The actual data is fetched from memory in little-endian format.

0 1 2 3 4 5 6 7								8 9 0 1 2 3 4 5								6 7 8 9 0 1 2 3								4 5 6 7 8 9 0 1															
Source Port																Destination Port																							
Sequence Number																																							
Acknowledgement Number																																							
TCP Header Length				Reserved								U R G		A C K		P S H		R S T		S Y N		F I N		Window															
Checksum																Urgent Pointer																							
Options																																							

Figure 14. TCP Header (Traditional Representation)

Byte3								Byte2								Byte1								Byte0																							
7 6 5 4 3 2 1 0								7 6 5 4 3 2 1 0								7 6 5 4 3 2 1 0								7 6 5 4 3 2 1 0																							
Destination Port																Source Port																															
LSB																Sequence Number																MSB															
Acknowledgement Number																																															
Window																R E S		U R G		A C K		P S H		R S T		S Y N		F I N		TCP Header Length				Reserved													
Urgent Pointer																Checksum																															
Options																																															

Figure 15. TCP Header (Little Endian)

The TCP header is always a multiple of 32 bit words. TCP options may occupy space at the end of the TCP header and are a multiple of 8 bits in length. All options are included in the checksum.

The checksum also covers a 96-bit pseudo header conceptually prefixed to the TCP Header. The IPv4 pseudo header contains the IPv4 Source Address, the IPv4 Destination Address, the IPv4 Protocol field, and TCP Length. The IPv6 pseudo header contains the IPv6 Source Address, the IPv6 Destination Address, the IPv6 Payload Length, and the IPv6 Next Header field. Software pre-calculates the PARTIAL pseudo header sum, which includes IPv4 SA, DA and protocol types, but NOT the TCP length, and stores this value into the TCP checksum field of the packet. For both IPv4 and IPv6, hardware needs to factor in the TCP length to the software supplied pseudo header partial checksum.

**Note:** The Protocol ID field should always be added the least significant byte (LSB) of the 16 bit pseudo header sum, where the most significant byte (MSB) of the 16 bit sum is the byte that corresponds to the first checksum byte out on the wire.

The TCP Length field is the TCP Header Length including option fields plus the data length in bytes, which is calculated by hardware on a frame by frame basis. The TCP Length does not count the 12 bytes of the pseudo header. The TCP length of the packet is determined by hardware as:



TCP Length = min(PAYLOADLEN) + L5\_LEN

The two flags that might be modified are defined as:

- PSH: Receiver should pass this data to the application without delay
- FIN: Sender is finished sending data

The handling of these flags is described in [Section 5.8.7](#).

Payload is normally MSS except for the last packet where it represents the remainder of the payload.

IPv4 Source Address		
IPv4 Destination Address		
Zero	Layer 4 Protocol ID	TCP Length

**Figure 16. TCP Pseudo Header Content (Traditional Representation)**

The Layer 4 Protocol ID value in the pseudo-header identifies the upper-layer protocol (6 for TCP or 17 for UDP).

IPv6 Source Address	
IPv6 Final Destination Address	
TCP Packet Length	
Zero	Next Header

**Figure 17. TCP/UDP Pseudo Header Content for IPv6 (Traditional Representation)**

**Note:** If the IPv6 packet contains a routing header, the destination address used in the pseudo-header is that of the final destination. At the originating node, that address is in the last element of the routing header; at the recipient(s), that address is in the *Destination Address* field of the IPv6 header.

The next header value in the pseudo-header identifies the upper-layer protocol (6 for TCP or 17 for UDP). It differs from the next header value in the IPv6 header if there are extension headers between the IPv6 header and the upper-layer header.

The upper-layer packet length in the pseudo-header is the length of the upper-layer header and data (TCP header plus TCP data). Some upper-layer protocols carry their own length information (for example, the *Length* field in the UDP header); for such protocols, that is the length used in the pseudo-header. Other protocols (such as TCP) do not carry their own length information, in which case the length used in the pseudo-header is the payload length from the IPv6 header minus the length of any extension headers present between the IPv6 header and the upper-layer header.

Unlike IPv4, when UDP packets are originated by an IPv6 node, the UDP checksum is not optional. Whenever originating a UDP packet, an IPv6 node must compute a UDP checksum over the packet and the pseudo-header and if that computation yields a result of zero, it must be changed to FFFFh for placement in the UDP header. IPv6 receivers must discard UDP packets containing a zero checksum and should log the error.



A type 0 routing header contains the following format:

Next Header	Hdr Ext Len	Routing Type 0	Segments Left n
Reserved			
Address[1]			
Address[2]			
...			
Final Destination Address[n]			

**Figure 18. IPv6 Routing Header (Traditional Representation)**

- Next Header - 8-bit selector. Identifies the type of header immediately following the routing header. Uses the same values as the *IPv4 Protocol* field [RFC-1700 et seq.].
- Header Extension Length - 8-bit unsigned integer. Length of the routing header in 8-octet units, not including the first 8 octets. For the Type 0 Routing header, Header Extension Length is equal to two times the number of addresses in the header.
- Routing Type - 0
- Segments Left - 8-bit unsigned integer. Number of route segments remaining. For example, the number of explicitly listed intermediate nodes still to be visited before reaching the final destination. Equal to "n" at the source node.
- Reserved - 32-bit reserved field. Initialized to zero for transmission; ignored on reception.
- Address[1...n] - Vector of 128-bit addresses, numbered 1 to n.

The 82575 supports checksum off-loading as a component of the TCP Segmentation offload feature and as a standalone capability. Section 3.8.7 describes the interface for controlling the checksum off-loading feature. This section describes the feature as it relates to TCP Segmentation.

The 82575 supports IP and TCP/UDP header options in the checksum computation for packets that are derived from the TCP Segmentation feature.

**Note:** The 82575 is capable of computing one level of IP header checksum and one TCP/UDP header and payload checksum. In case of multiple IP headers, the driver has to compute all but one IP header checksum. The 82575 calculates checksums on the fly on a frame by frame basis and inserts the result in the IP/TCP/UDP headers of each frame. TCP and UDP checksum are a result of performing the checksum on all bytes of the payload and the pseudo header.

Three specific types of checksum are supported by the hardware in the context of the TCP Segmentation offload feature:

- IPv4 checksum
- TCP checksum
- UDP checksum

Each packet that is sent via the TCP segmentation offload feature optionally includes the IPv4 checksum and either the TCP or UDP checksum.



All checksum calculations use a 16-bit wide one's complement checksum. The checksum word is calculated on the outgoing data. The checksum field is written with the 16 bit one's complement of the one's complement sum of all 16-bit words in the range of CSS to CSE, including the checksum field itself.

**Table 47. Supported Transmit Checksum Capabilities**

Packet Type	HW IP Checksum Calculation	HW TCP/UDP Checksum Calculation
IPv4 packets	Yes	Yes
IPv6 packets (no ip checksum in Ipv6)	NA	Yes
Packet is greater than 1552 bytes; (LPE = 1b)	Yes	Yes
Packet has 802.3ac tag	Yes	Yes
Packet has IP options (IP header is longer than 20 bytes)	Yes	Yes
Packet has TCP or UDP options	Yes	Yes
IP header's protocol field contains a protocol # other than TCP or UDP	Yes	No

Table 48 lists the conditions of when checksum offloading can/should be calculated.

**Table 48. Calculating Checksum Offloading**

Packet Type	IPv4	TCP/UDP	Reason
Non TSO	Yes	No	IP raw packet (non TCP/UDP protocol)
	Yes	Yes	TCP segment or UDP datagram with checksum offload
	No	No	Non-IP packet or checksum not offloaded
TSO	Yes	Yes	For TSO, checksum offload must be done

## 5.8.7 IP/TCP/UDP Header Updating

IP/TCP/UDP header is updated for each outgoing frame based on the IP/TCP header prototype which hardware transfers from the first descriptor(s) and stores on chip. The IP/TCP/UDP headers are fetched from host memory into an on-chip 512 byte header buffer once for each TCP segmentation context (for performance reasons, this header is not fetched again for each additional packet that is derived from the TCP segmentation process). The checksum fields and other header information are later updated on a frame by frame basis. The updating process is performed concurrently with the packet data fetch.

The following sections define which fields are modified by hardware during the TCP Segmentation process by the 82575.

**Note:** Software must make the PAYLEN and HDRLEN values of context descriptors correct. Otherwise, the failure of large send due to either under-run or over-run might cause hardware to send bad packets or even cause transmit hardware to hang. The indication of large send failure can be checked in the TSCTFC statistic register.



### 5.8.7.1 TCP/IP/UDP Header for the First Frame

The hardware makes the following changes to the headers of the first packet that is derived from each TCP segmentation context.

- MAC Header (for SNAP)
  - Type/Len field =  $MSS + MACLEN + IPLEN + L4LEN - 14$
- IPv4 Header
  - IP Total Length =  $MSS + L4LEN - IPLEN$
  - IP Checksum
- IPv6 Header
  - Payload Length =  $MSS + L4LEN + IPV6\_HDR\_extension$
- TCP Header
  - Sequence Number: The value is the sequence number of the first TCP byte in this frame.
  - If FIN flag = 1b, it is cleared in the first frame.
  - If PSH flag = 1b, it is cleared in the first frame.
  - TCP Checksum
- UDP Header
  - UDP length:  $MSS + L4LEN$
  - UDP Checksum

### 5.8.7.2 TCP/IP/UDP Header for the Subsequent Frames

The hardware makes the following changes to the headers for subsequent packets that are derived as part of a TCP segmentation context:

**Note:** Number of bytes left for transmission =  $PAYLEN - (N * MSS)$ . Where N is the number of frames that have been transmitted.

- MAC Header (for SNAP packets)
  - Type/LEN field =  $MSS + MACLEN + IPLEN + L4LEN - 14$
- IPv4 Header
  - IP Identification: incremented from last value (wrap around)
  - IP Total Length =  $MSS + L4LEN + IPLEN$
  - IP Checksum
- IPv6 Header
  - Payload Length =  $MSS + L4LEN + IPV6\_HDR\_extension$
- TCP Header
  - Sequence Number update: Add previous TCP payload size to the previous sequence number value. This is equivalent to adding the MSS to the previous sequence number.
  - If FIN flag = 1b, it is cleared in these frames.
  - If PSH flag = 1b, it is cleared in these frames.
  - TCP Checksum
- UDP Header
  - UDP Length:  $MSS + L4LEN$



- UDP Checksum

### 5.8.7.3 TCP/IP/UDP Header for the Last Frame

Hardware makes the following changes to the headers for the last frame of a TCP segmentation context:

**Note:** Last frame payload bytes =  $PAYLEN - (N * MSS)$

- MAC Header (for SNAP packets)
  - Type/LEN field = last frame payload bytes + MACLEN + ILEN + L4LEN - 14
- IPv4 Header
  - IP Total Length = last frame payload bytes + L4LEN + ILEN
  - IP Identification: incremented from last value (wrap around configurable based on a 15 bit width or 16-bit width)
  - IP Checksum
- IPv6 Header
  - Payload Length = last frame payload bytes + L4LEN + IPV6\_HDR\_extension
- TCP Header
  - Sequence Number update: Add previous TCP payload size to the previous sequence number value. This is equivalent to adding the MSS to the previous sequence number.
  - If FIN flag = 1b, set it in this last frame
  - If PSH flag = 1b, set it in this last frame
  - TCP Checksum
- UDP Header
  - UDP length: last frame payload bytes + L4LEN
  - UDP Checksum

## 5.9 IP/TCP/UDP Transmit Checksum Offloading

The 82575 performs checksum offloading as an optional part of the TCP/UDP segmentation offload feature. These specific checksums are supported under TCP segmentation:

- IPv4 checksum
- TCP checksum
- UDP checksum

Checksum offloading can also be performed in a single-send packet.

**Note:** For tunneled packets, hardware can perform either an IPv4 checksum or TCP checksum but not both.



## 5.10 IP/TCP/UDP Transmit Checksum Offloading in Non-Segmentation Mode

The previous section on TCP Segmentation offload describes the IP/TCP/UDP checksum offloading mechanism used in conjunction with TCP Segmentation. The same underlying mechanism can also be applied as a standalone feature. The main difference in normal packet mode (non-TCP Segmentation) is that only the checksum fields in the IP/TCP/UDP headers need to be updated.

Before taking advantage of the 82575's enhanced checksum offload capability, a checksum context must be initialized. For the normal transmit checksum offload feature this is performed by providing the 82575 with a TCP/IP Context Descriptor with TUCMD.TSE = 0b. Setting TSE = 0b indicates that the normal checksum context is being set, as opposed to the segmentation context.

**Note:** Enabling the checksum offloading capability without first initializing the appropriate checksum context leads to unpredictable results. CRC appending (DCMD.IFCS) must be enabled in TCP/IP checksum mode, since CRC must be inserted by hardware after the checksums have been calculated.

As mentioned in [Section 5.7](#), it is not necessary to set a new context for each new packet. In many cases, the same checksum context can be used for a majority of the packet stream. In this case, some performance can be gained by only changing the context on an as needed basis or electing to use the offload feature only for a particular traffic type, thereby avoiding all context descriptors except for the initial one.

Each checksum operates independently. Inserting IP and TCP checksums for each packet are enabled through the Transmit Data Descriptor POPTS.TSXM and POPTS.IXSM fields, respectively.

### 5.10.1 IP Checksum

Three fields in the Transmit Context Descriptor set the context of the IP checksum offloading feature:

- TUCMD.IPv4
- IPLEN
- MACLEN

TUCMD.IPv4 = 1b specifies that the packet type for this context is IPv4 and that the IP header checksum should be inserted. TUCMD.IPv4 = 0b indicates that the packet type is IPv6 (or some other protocol) and that the IP header checksum should not be inserted.

MACLEN specifies the byte offset from the start of the transferred data to the first byte to be included in the checksum, the start of the IP header. The minimal allowed value for this field is 12. Note that the maximum value for this field is 255 which is adequate for typical applications.

**Note:** The MACLEN+IPLLEN value needs to be less than the total DMA length for a packet. If this is not the case, the results will be unpredictable.

IPLLEN specifies where the IP checksum should stop. Again, this is limited to the first 256 bytes of the packet and must be less than or equal to the total length of a given packet. If this is not the case, the checksum is not inserted.

The 16-bit IPv4 header checksum is placed at the two bytes starting at MACLEN+10.



As mentioned in [Section 5.6.2](#), it is not necessary to set a new context for each new packet. In many cases, the same checksum context can be used for a majority of the packet stream. In this case, some performance can be gained by only changing the context on an as needed basis or electing to use the offload feature only for a particular traffic type, thereby avoiding all context descriptors except for the initial one.

## 5.10.2 TCP Checksum

Three fields in the Transmit Context Descriptor set the context of the TCP checksum offloading feature:

- MACLEN
- IPLEN
- TUCMD.L4T

TUCMD.TCPL4T = 1b specifies that the packet type is TCP, and that the 16-bit TCP header checksum should be inserted at byte offset MACLEN + IPLEN + 16. TUCMD.L4T = 0b indicates that the packet is UDP and that the 16-bit checksum should be inserted starting at byte offset MACLEN + IPLEN + 6.

IPLEN+MACLEN specifies the byte offset from the start of the transferred data to the first byte to be included in the checksum, the start of the TCP header. The minimal allowed value for this sum is 18/28 for UDP or TCP, respectively. Note that the maximum value for this field is 255 and is adequate for typical applications.

**Note:** The IPLEN + MACLEN + L4LEN value needs to be less than the total transfer length for a packet. If not, results are unpredictable.

The TCP/UDP checksum always continues to the last byte of the transferred data.

**Note:** For non-TSO, software still needs to calculate a full checksum for the TCP/UDP pseudo-header. This checksum of the pseudo-header should be placed in the packet data buffer at the appropriate offset for the checksum calculation.

## 5.11 Multiple Transmit Queues

The number of transmit queues for the 82575 has increased to four, to match the expected number of processors on most server platforms. If there are more processors than queues, then one queue can be used to service more than one processor.

In transmission, each processor sets a queue in the host memory (this memory is likely to be the one that is closely connected to the processor).

Transmission priority among the queues is under software configuration and meets the following rules:

- Arbitration between queues is done at the segment boundary. That is, once a segment (including a TSO segment) is selected for transmission, it would complete transmitting before another packet is selected.
- Each queue can be assigned as High Priority (HP) or Low Priority (LP). Software can change priority any time during operation.
- HP queues are always selected before LP queues. Note that this might cause starvation of the LP queues.
- Round robin arbitration is performed among the HP queues.





- Round robin arbitration is performed among the LP queues.

**Note:** In order to prevent starvation, HP queues should not be used for TSO requests. Software must enforce this; it is not enforced by the 82575.

Software should also change the priority bit only when a queue is empty and it is guaranteed that the 82575 is not engaged in fetching Tx packets for the given queue.

The following scheme avoids excessive latency of transmit packets queued simultaneously with TSO packets. TSO packets take tens of  $\mu\text{s}$  (or more) to transmit. A packet queued behind several TSO packets would suffer from an additional latency of tens to hundreds of  $\mu\text{s}$ . This is unacceptable in some applications where low latency is a requirement.

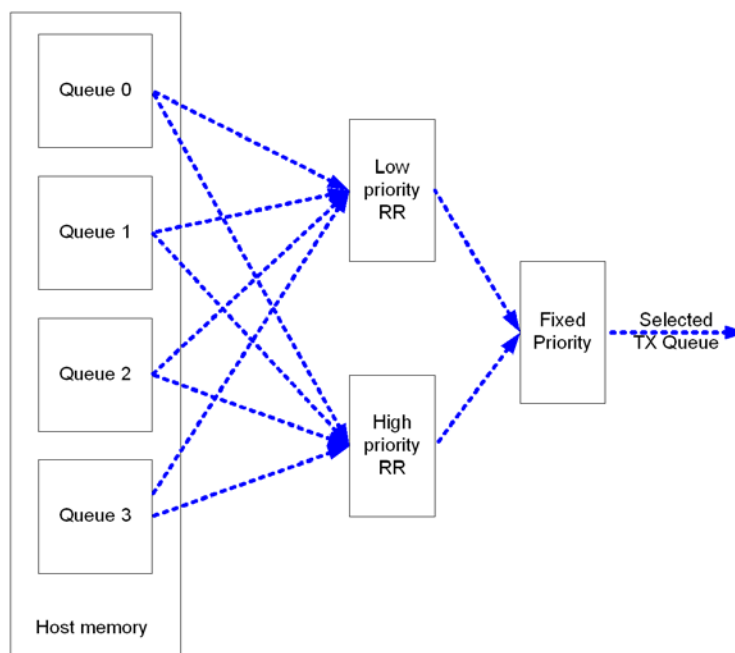

Figure 19. Multiple Queues in Transmit

## 5.12 Tx Completions Head Write-Back

In legacy hardware, transmit requests are completed by writing the DD bit to the transmit descriptor ring. This causes cache thrash since both the software device driver and hardware are writing to the descriptor ring in host memory. Instead of writing the DD bits to signal that a transmit request is complete, hardware writes the contents of the descriptor queue head to host memory. The software device driver reads that memory location to determine which transmit requests are complete. In order to improve the performance of this feature, the software device driver needs to program DCA registers to configure which CPU will process each TX queue.

The head counter is reflected in a memory location that is allocated by software for each queue.



Head write-back occurs if TDWBAL#.Head\_WB\_En is set for this queue and the RS bit is set in the Tx descriptor, following corresponding data upload into packet buffer.

The software device driver has control on this feature through Tx Queue 0-3 head write-back address, low and high (enabling a 64-bit address).

The low register's LSB hold the control bits.

- The Head\_WB\_En bit enables activation of tail write-back. In this case, no descriptor write-back is executed.
- The SN\_WB\_en bit enables both the DD and the sequence number bit write-back into the descriptor address.
- The 30 upper bits of this register hold the lowest 32 bits of the head write-back address, assuming that the two last bits are set to 0b.

The high register holds the high part of the 64-bit address. The 82575 only writes the 16 bits that are pointed by TDWBAH/TDWBAL address.

## 5.13 Interrupts

The interrupt logic consists of the 10 registers listed in Table 49 plus the registers associated with MSI/MSI-X signaling.

**Table 49. Interrupt Registers**

Register	Acronym	Function
Interrupt Cause	ICR	Records interrupt conditions.
Interrupt Cause Set	ICS	Allows software to set bits in the ICR.
Interrupt Mask Set/Read	IMS	Sets or reads bits in the other interrupt mask.
Interrupt Mask Clear	IMC	Clears bits in the other interrupt mask.
Interrupt Acknowledge auto-mask	IAM	Under some conditions, the content of this register is copied to the mask register following read or write of ICR.
Extended Interrupt Cause	EICR	ICR. Records interrupt causes from receive and transmit queues. An interrupt is signaled when unmasked bits in this register are set.
Extended Interrupt Cause Set	EICS	Enables software to set bits in the ICR.
Extended Interrupt Mask Set/Read	EIMS	Sets or read bits in the interrupt mask.
Extended Interrupt Mask Clear	EIMC	Clears bits in the interrupt mask.
Extended Interrupt Auto Clear	EIAC	Enables bits in the EICR to be cleared automatically following an MSI-X interrupt without a read or write of the EICR.
Extended Interrupt Acknowledge Auto-Mask	EIAM	This register is used to decide which masks are cleared in the extended mask register following read or write of EICR or which masks are set following a write to EICS. In MSI-X mode, this register also controls which bits in EIMC are cleared automatically following an MSI-X interrupt.

### 5.13.1 Interrupt Cause Register (ICR)

This register captures the interrupt causes not directly captured by the EICR. These are infrequent management interrupts and error conditions.



**Note:** When EICR is used in MSI-X mode, the Rx / Tx related bits in ICR should be masked.

## 5.13.2 Interrupt Cause Set Register (ICS)

This registers enables setting the bits of ICR by software, by writing a 1b in the corresponding bits in ICS. Used to rearm interrupts software did not have time to handle in the current interrupt routine.

## 5.13.3 Interrupt Mask Set/Read Register (IMS)

An interrupt is enabled if its corresponding mask bit in this register is set to 1b and disabled if its corresponding mask bit is set to 0b. A PCIe\* interrupt is generated each time one of the bits in this register is set and the corresponding interrupt condition occurs. The occurrence of an interrupt condition is reflected by having a bit set in the ICR.

Reading this register returns which bits have an interrupt mask set.

A particular interrupt can be enabled by writing a 1b to the corresponding mask bit in this register. Any bits written with a 0b are unchanged. Therefore, if software desires to disable a particular interrupt condition that had been previously enabled, it must write to the IMC instead of writing a 0b to a bit in this register.

## 5.13.4 Interrupt Mask Clear Register (IMC)

Software blocks interrupts by clearing the corresponding mask bit. This is accomplished by writing a 1b to the corresponding bit in this register. Bits written with 0b are unchanged (their mask status does not change).

## 5.13.5 Interrupt Acknowledge Auto-mask register (IAM)

An ICR read or write has the side effect of writing the contents of this register to the IMC register. If CTRL\_EXT.NSICR = 0b, then the copy of this register to IMS only occurs after at least one bit is set in the IMS and there is a true interrupt as reflected in ICR.INTA.

## 5.13.6 Extended Interrupt Cause Registers (EICR)

This register records the non-error interrupts from the receive and transmit queues in a unique bit per queue plus one bit to indicate when any interrupt in the ICR is active. Bits in this register can be configured to auto-clear when the MSI-X interrupt message is sent in order to minimize software device driver overhead when using MSI-X interrupt signaling.

In systems that do not support MSI-X, writing 1b's clears the corresponding bits in this register. Most systems have write- buffering that minimizes overhead, but this might require a read operation to guarantee that the write has been flushed from posted buffers. Reading this register auto-clears all bits.



### 5.13.7 Extended Interrupt Cause Set Register (EICS)

This registers enables the setting of bits in EICR, by software, by writing a 1b in the corresponding bits in EICS. Used to rearm interrupts software did not have time to handle in the current interrupt routine.

### 5.13.8 Extended Interrupt Mask Set and Read Register (EIMS)/Extended Interrupt Mask Clear Register (EIMC)

Interrupts appear on PCIe\* only if the interrupt cause bit is set to 1b and the corresponding interrupt mask bit is set to 1b. Software blocks asserting an interrupt by clearing the corresponding bit in the mask register. The cause bit stores the interrupt event regardless of the state of the mask bit. Clear and set make this register more thread safe by avoiding a read-modify-write operation on the mask register. The mask bit is set for each bit written to a one in the set register and cleared for each bit written in the clear register. Reading the set register (EIMS) returns the current mask register value.

### 5.13.9 Extended Interrupt Auto Clear Enable Register (EIAC)

Each bit in this register enables clearing of the corresponding bit in EICR following interrupt generation. When a bit is set, the corresponding bit in EICR is automatically cleared following an interrupt. This feature should only be used in MSI-X mode.

When used in conjunction with MSI-X interrupt vector, this feature enables interrupt cause recognition and selective interrupt cause without requiring software to read or write the EICR register; therefore, the penalty related to a PCIe\* read or write transaction is avoided ([Section 5.15](#)).

### 5.13.10 Extended Interrupt Auto Mask Enable Register (EIAM)

Each bit set in this register enables clearing of the corresponding bit in EIMS following read or write-to-clear to EICR. It also enables setting of the corresponding bit in EIMS following a write-to-set to EICS.

This mode is provided in case MSI-X is not used. As a result, auto-clear through EIAC register is not available.

In MSI-X mode, the software device driver might set the bits of this register to select mask bits that are reset during interrupt processing. In this mode, each bit in this register enables clearing of the corresponding bit in EIMC following interrupt generation.



### 5.13.11 Interrupt Modes Setting Bits

There are bits in the CTRL\_EXT register that define the behavior of the interrupt mechanism. Setting these bits is different in each mode of operation. The following table describes the recommended setting of these bits in the different modes:

Field	Bit(s)	Initial Value	Description	INT-x/ MSI + Legacy	INT-x/ MSI + Extend	MSI-X
NSICR	0	0b	Non Selective Interrupt Clear on Read  When set, every read of ICR clears it. When this bit is cleared, an ICR read causes it to be cleared only if an actual interrupt was asserted or IMS = 0b. This bit should be cleared by drivers not using the extended interrupts capabilities and set otherwise.	0b <sup>1</sup>	1b	1b
EIAME	24	0b	Extended Interrupt Auto Mask Enable  When set (usually in MSI-X mode), upon firing of an MSI-X message, bits set in EIAM associated with this message are cleared. Otherwise, EIAM is used only upon read or write of EICR/EICS registers.	0b	0b	1b
PBA_ support	31	0b	PBA Support  When set, setting one of the extended interrupts masks via EIMS causes the PBA bit of the associated MSI-X vector to be cleared. Otherwise, the 82575 behaves in a way supporting legacy INT-x interrupts.  Should be cleared when working in INT-x or MSI mode and set in MSI-X mode.	0b	0b	1b

1. In systems where interrupt sharing is not expected, the NSICR bit can also be set by legacy drivers.

## 5.14 Interrupt Moderation

An interrupt is generated upon receiving of incoming packets, as throttled by the EITR registers. There are 10 EITR registers; each one is allocated to a vector of MSI-X.

When the MSI-X interrupt is activated, each active bit in EICR can trigger an interrupt vector. The allocation of MSI-X vectors to each bit of EICR is set by the setting the MSI\_X\_ALLOC[09:0] registers. Following the allocation, the EITR corresponding to the MSI-X vector is tied to one or more bits in EICR.

When MSI-X is not activated, the interrupt moderation is controlled by EITR[0].

Software can use EITR to limit the rate of delivery of interrupts to the host processor. This register provides a guaranteed inter-interrupt delay between interrupts asserted by the 82575, regardless of network traffic conditions.

The following algorithm can be used to convert the inter-interrupt interval value to the common interrupts/sec performance metric:

$$\text{interrupts/sec} = (256 \cdot 10^{-9} \text{sec} \cdot \text{interval})^{-1}$$

For example, if the interval is programmed to 500d, the 82575 guarantees the CPU is not interrupted by the 82575 for at least 128 microseconds from the last interrupt. The maximum observable interrupt rate from the 82575 should not exceed 7813 interrupts/sec.



Inversely, inter-interrupt interval value can be calculated as:

$$\text{inter-interrupt interval} = (256 \cdot 10^{-9} \text{sec} \cdot \text{interrupts/sec})^{-1}$$

The optimal performance setting for this register is very system and configuration specific. An initial suggested value is 4000 (one interrupt every 250  $\mu$ s).

The EITR should default to 0b upon initialization and reset. It loads in the value programmed by the software after software initializes the 82575.

When software wants to force an immediate interrupt, for example, after setting a bit in the EICR with the EICS register, the value of the counter can be written to 0b to generate an immediate interrupt. This write should include re-writing the *Interval* field with the desired constant, as it will be used to reload the counter immediately for the next throttling interval.

The 82575 implements interrupt moderation to reduce the number of interrupts software processes. The moderation scheme is based on EITR. Each time an interrupt event happens, the corresponding bit in the EICR is activated. However, an interrupt message is not sent out on the PCIe\* interface until the EITR counter assigned to that EICR bit has counted down to zero. As soon as the interrupt is issued, the EITR counter is reloaded with its initial value and the process repeats again. The interrupt flow should follow as shown in [Figure 20](#).

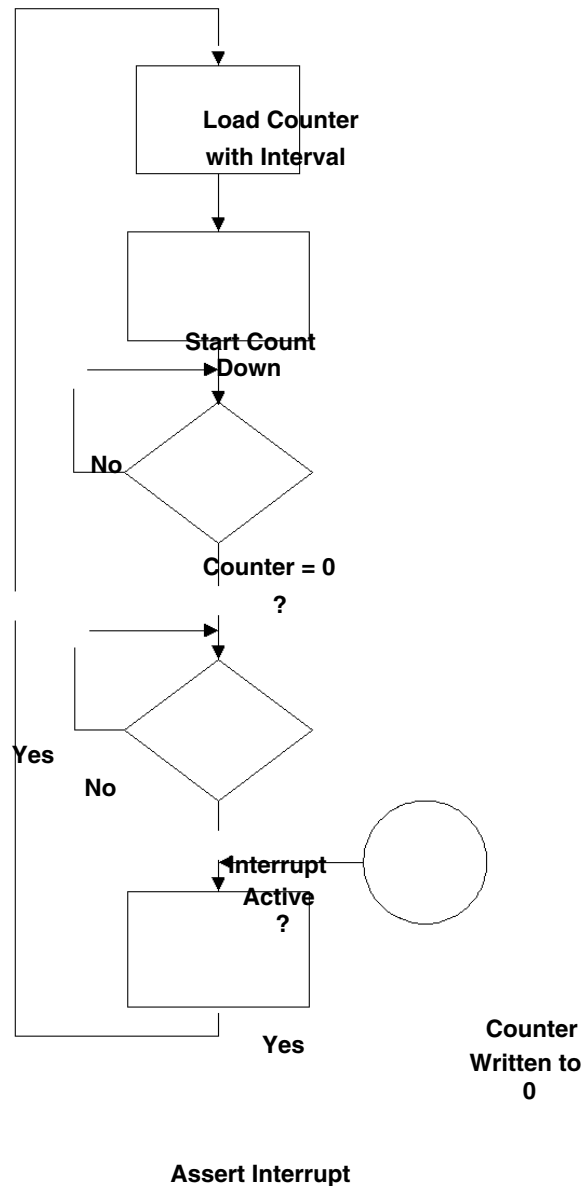
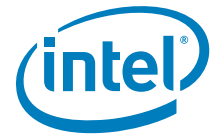

**Figure 20. Interrupt Throttle Flow Diagram**

For cases where the 82575 is connected to a small number of clients, it is desirable to initiate the interrupt as soon as possible with minimum latency. For these cases, when the EITR counter counts down to zero and no interrupt event has happened, then the EITR counter is not reset but stays at zero. Therefore, the next interrupt event triggers an immediate interrupt (see [Figure 21](#) and [Figure 22](#)).

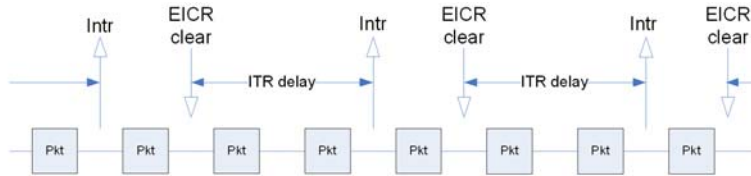

Figure 21. Case A: Heavy Load, Interrupts Moderated

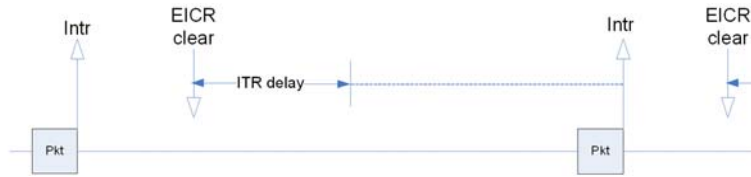

Figure 22. Case B: Light Load, Interrupts Immediately on Packet Receive

## 5.15 Clearing Interrupt Causes

The 82575 has three available methods for clearing the EICR bits: auto-clear, clear-on-write, and clear-on-read. Note that ICR bits can only be cleared with clear-on-write or clear-on-read.

### 5.15.1 Auto-Clear

In systems that support MSI-X, the interrupt vector enables the interrupt service routine to know the interrupt cause without reading EICR. With interrupt moderation active, software loads from spurious interrupts is minimized. In this case, the software overhead of a I/O read or write can be avoided by setting appropriate EICR bits to auto-clear mode by setting the corresponding bits in the EIAC.

When auto-clear is enabled for a interrupt cause, the EICR bit is set when a cause event occurs. When the EITR counter reaches zero, the MSI-X message is sent on to the PCIe\* interface. Afterwards, the EICR bit is cleared and enabled to be set by a new cause event. The vector in the MSI-X message signals software the cause of the interrupt to be serviced.

It is possible that in the time after the EICR bit is cleared and the interrupt service routine services the cause, for example checking the transmit and receive queues, that another cause event occurs that is then serviced by this ISR call, yet the EICR bit remains set. This results in a spurious interrupt. Software can detect this case, for example if there are no entries that require service in the transmit and receive queues, and exit knowing that the interrupt has been automatically cleared. The use of interrupt moderations through the EITR register limits the extra software overhead that can be caused by these spurious interrupts.





## 5.15.2 Write to Clear

In the case where the software device driver wants to configure itself in MSI-X mode to not use the auto-clear feature, it might clear the EICR bits by writing to the EICR register. Any bits written with a 1b is cleared. Any bits written with a 0b remain unchanged.

## 5.15.3 Read to Clear

The EICR and ICR registers are cleared on a read.

**Note:** The software device driver should never do a read-to-clear of the EICR when in MSI-X mode, since this can clear interrupt cause events which are processed by a different interrupt handler (assuming multiple vectors).

## 5.16 Dynamic Interrupt Moderation

There are some types of network traffic for which latency is a critical issue. For these types of traffic, interrupt moderation hurts performance by increasing latency between when a packet is received by hardware and when it is indicated to the host operating system. This traffic can be identified by the TCP port value in conjunction with control bits, size and VLAN priority.

The 82575 implements an eight-entry, software programmable, table of TCP ports and eight registers with control bits filter and size threshold. In addition, a dedicated register enables setting of a VLAN priority threshold. If a packet is received on one of these TCP ports, and the conditions set by the register fit to the packet, hardware should interrupt immediately, overriding the interrupt moderation by the EITR counter.

A *Port Enabling* bit allows enabling or disabling of a specific port for this purpose; VLAN priority filtering allows issuing of immediate interrupt.

The logic of the dynamic interrupt moderation is as follows:

- There are eight port filters. Each filter checks the value of incoming packets TCP port, size, and control bits against values stored in the filter's register. Each parameter can be bypassed (or via a wildcard). Each filter can be enabled or disabled. If one of the filters detects an adequate packet, an immediate interrupt is issued.
- When VLAN priority filtering is enabled, VLAN packets trigger an immediate interrupt when the VLAN priority is equal to or above the VLAN priority threshold. This is regardless of the status of the port filters.

**Note:** EITR is reset to 0b following a dynamic interrupt.

Immediate interrupts are available only when using advanced receive descriptors as opposed to legacy descriptors.



## 5.16.1 TCP Timer Interrupt

In order to implement TCP timers for I/OAT 2, software needs to take action periodically (every 10 milliseconds). The software device driver must rely on software-based timers, whose granularity can change from platform to platform. This software timer generates a software Network Interface Card (NIC) interrupt, which then enables the software device driver to perform timer functions as part of its usual DPC. Note that the timer interval is system-specific.

It would be more accurate and more efficient for this periodic timer to be implemented in hardware. The software device driver could program a timeout value (usual value of 10 ms), and each time the timer expires, hardware sets a specific bit in the EICR. When an interrupt occurs (due to normal interrupt moderation schemes), software reads the EICR and discovers that it needs to process timer events during that DPC.

The timeout should be programmable by the software device driver, and it should be able to disable the timer interrupt if it is not needed.

A stand-alone down-counter is implemented. with an interrupt issued each time the value of the counter is zero.

Software is responsible for setting the initial value for the timer in the *Duration* field. Kick-starting is done by writing a 1b to the *Kick Start* bit.

Following kick-starting, an internal counter is set to the value defined by the *Duration* field. Afterwards, the counter is decreased by one each millisecond. When the counter reaches zero, an interrupt is issued. The counter re-starts counting from its initial value if the *Loop* field is set.

## 5.17 Memory Error Correction and Detection

The 82575 internal memories are protected by error correcting code that might correct memory errors and detect uncorrectable error. Correctable errors are silently corrected and are counted in the PBECCSTS.Corr\_err\_cnt, RDHESTS.Corr\_err\_cnt or TDHESTS.Corr\_err\_cnt fields according to the memory in which the error was found.

Uncorrectable errors are counted in the PBECCSTS.Uncorr\_err\_cnt, RDHESTS.Uncorr\_err\_cnt or TDHESTS.Uncorr\_err\_cnt fields according to the memory in which the error was found. The 82575 reacts to uncorrectable error detection according to the location in which the error was found:

- If the error was detected in a receive packet data, the packet is sent to the host with the *RXE* bit set in the receive descriptor. This packet should be discarded by the host.
- If the error was detected in a transmit packet data, the packet is sent to the network with a wrong FCS so that the link partner can discard it.
- If the error was detected in the descriptors attached to receive or transmit packets or in the descriptor handler cache memory, the consistency of the receive/transmit flow cannot be guaranteed. In this case, the flow in which the error was detected is stopped and an interrupt is generated indicating the location of the detected error. The flow stop can be released only by a software reset (CTRL.RST). The interrupt causes used to indicate an unrecoverable error are ICR[25:22] according to the location of the error.

Enabling the reaction mechanism of the 82575 to uncorrectable errors is done using the CTRL\_EXT.MEHE bit.



## 6.0 PCIe\* Local Bus Interface

This section describes the software interface and some related hardware aspects of PCIe\* in regard to the 82575.

### 6.1 General Functionality

- **Native/Legacy Functionality.** All 82575 PCI functions are native PCIe\* functions.
- **Locked Transactions.** The 82575 does not support locked requests as a target or master.
- **End to End CRC.** This is not supported by the 82575.

#### 6.1.1 Message Handling (Receive Side)

Message packets are special packets that carry message code. The upstream device transmits special messages to the 82575 by using this mechanism. The transaction layer decodes the message code and responds accordingly.

Table 50. Supported Messages on the Receive Side

Message Code [7:0]	Routing r2r1r0	Name	Device Response
14h	100	PM_Active_State_NAK	Stop ASPM L1 negotiation and go back to L0
19h	011	PME_Turn_Off	Send PME_to_Ack and start L2 negotiation
50h	100	Slot power limited support (one Dword)	Silently drop
7Eh	010,011,100	Vendor_Defined Type 0 (no data)	Unsupported request
7Eh	010,011,100	Vendor_Defined Type 0 (data)	Unsupported request
7Fh	010,011,100	Vendor_Defined Type 1 (no data)	Silently drop
7Fh	010,011,100	Vendor_Defined Type 1 (data)	Silently drop
00h	011	Unlock	Silently drop

#### 6.1.2 Message Handling (Transmit Side)

The transaction layer is also responsible for transmitting specific messages to report internal and external events such as interrupts and power management events.



Table 51. Supported Messages on the Transmit Side

Message Code [7:0]	Routing r2r1r0	Description
20h	100	Assert INT A
21h	100	Assert INT B
22h	100	Assert INT C
23h	100	Assert INT D
24h	100	De-assert INT A
25h	100	De-assert INT B
26h	100	De-assert INT C
27h	100	De-assert INT D
30h	000	ERR_COR
31h	000	ERR_NONFATAL
33h	000	ERR_FATAL
18h	000	PM_PME
1Bh	101	PME_to_Ack

## 6.1.3 Data Alignment

### 6.1.3.1 4 KB Boundary

Requests must not specify an address/length combination causing memory space access to cross a 4 KB boundary. It is the hardware responsibility to break requests into 4 KB aligned requests if required. This does not create any software requirement. However, if software allocates a buffer across the 4 KB boundary, hardware issues multiple requests for the buffer. Software should align buffers to the 4 KB boundary in cases where it improves performance.

The general rules for packet alignment are as follows. Note that these apply to all 82575 requests (read/write, snoop and no snoop):

- The length of a single request does not exceed the PCIe\* limit of MAX\_PAYLOAD\_SIZE for write and MAX\_READ\_REQ for read
- The length of a single request does not exceed 82575's internal limitations of 256 bytes for write and 512 bytes for read.
- A single request does not span across different memory pages as noted by the 4 KB boundary.

If a request can be sent as a single PCIe\* packet and still meet the general rules for packet alignment, then it is not broken at the cacheline boundary but rather sent as a single packet. However, if the general rules require that the request is broken into two or more packets, then the request is broken at cacheline boundary.

## 6.1.4 Transaction Attributes

### 6.1.4.1 Traffic Class and Virtual Channels

The 82575 only supports Traffic Class 0 (default) and Virtual Channel 0 (default).



### 6.1.4.2 Relaxed Ordering

The 82575 takes advantage of the relaxed ordering rules of the PCIe\* Specification.

Relaxed ordering can be used in conjunction with the no snoop attribute to allow the memory controller to advance non-snoop writes ahead of earlier snooped writes.

Relaxed ordering is enabled in the 82575 by clearing the *RO\_DIS* bit in the CTRL\_EXT register. The actual setting of relaxed ordering is done for LAN traffic by the host through the DCA registers.

**Note:** The 82575 cannot perform relax ordering for descriptor writes or an MSI write.

### 6.1.4.3 Snoop Not Required

The 82575 can be configured to set the *Snoop Not Required* attribute bit for master data writes. System logic can provide a separate path into system memory for non-coherent traffic. The non-coherent path to system memory provides a higher, more uniform bandwidth for write requests.

**Note:** The *Snoop Not Required* attribute does not alter transaction ordering. Therefore, to achieve maximum benefit from snoop not required transactions, it is advisable to also set the relaxed ordering attribute. This assumes that system logic supports both the snoop not required and relaxed ordering attributes.

No snoop is enabled in the 82575 by clearing the *NS\_DIS* bit in the CTRL\_EXT register. The actual setting of no snoop is done for LAN traffic by the host through the DCA registers.

#### 6.1.4.3.1 No Snoop and Relaxed Ordering for LAN Traffic

Software configures non-snoop and relax order attributes for each queue and each type of transaction by setting the respective bits in the DCA\_RXCTRL and TCA\_TXCTRL registers.

Table 52 lists the default behavior for the *No Snoop* and *Relaxed Ordering* bits for LAN traffic when I/OAT 2 is enabled.

**Table 52. LAN Traffic Attributes**

Transaction	No Snoop Default	Relaxed Ordering Default	Comments
Rx Descriptor Read	N	Y	
Rx Descriptor Write Back	N	N	RO must never be used for this traffic
Rx Data Write	Y	Y	See note and section below
Rx Replicated Header	N	Y	
Tx Descriptor Read	N	Y	
Tx Descriptor Write Back	N	Y	
Tx Data Write	N	Y	

**Note:** Rx payload no snoop is also conditioned by the *MSE* bit in the Receive descriptor.

#### 6.1.4.3.2 No Snoop Option for Payload



Under certain conditions that occur when I/OAT is enabled, software knows that it is safe to transfer a new packet into a certain buffer without snooping on the front-side bus. This scenario occurs when software is posting a receive buffer to hardware that the CPU has not accessed since the last time it was owned by hardware. This might happen if the data was transferred to an application buffer by the data movement engine. As such, software should be able to set a bit in the receive descriptor indicating that the 82575 should perform a no snoop transfer when it eventually writes a packet to this buffer.

When a non-snoop transaction is activated, the TLP header has a non-snoop attribute in the Transaction Descriptor field. This is triggered by the *NSE* bit in the Receive descriptor.

## 6.2 Flow Control

### 6.2.1 Flow Control Rules

The 82575 implements only the Default Virtual Channel (VC0). A single set of credits is maintained for VC0.

**Table 53. Flow Control Credit Allocation**

Credit Type	Operations	Number of Credits
Posted Request Header (PH)	Target Write (1 unit) Message (1 unit)	2 units (allowing concurrent accesses to both LAN ports)
Posted Request Data (PD)	Target Write (length per 16 bytes = 1) Message (1 unit)	MAX_PAYLOAD_SIZE/16
Non-Posted Request Header (NPH)	Target Read (1 unit) Configuration Read (1 unit) Configuration Write (1 unit)	2 units (allowing concurrent target accesses to both LAN ports)
Non-Posted Request Data (NPD)	Configuration Write (1 unit)	2 units
Completion Header (CPLH)	Read Completion (not applicable)	Infinite (accepted immediately)
Completion Data (CPLD)	Read Completion (not applicable)	Infinite (accepted immediately)

The flow control update rules are as follows:

- The 82575 maintains two credits for Non-Posted Request Data at any given time. The controller increments the credit by one after the credit is consumed and sends an UpdateFC packet as soon as possible. UpdateFC packets are scheduled immediately after a resource is available.
- The 82575 provides two credits for Posted Request Header. For example, two credits are given for two concurrent target writes and two credits for Non-Posted Request Header (two concurrent target reads). UpdateFC packets are scheduled immediately after a resource is available.
- The 82575 follows the PCIe\* recommendations for frequency of UpdateFC FCPs.

### 6.2.2 Upstream Flow Control Tracking

The 82575 issues a master transaction only when the required flow control credits are available. Credits are tracked for posted, non-posted and completions. The later operates against a switch.



### 6.2.3 Flow Control Update Frequency

In any case, UpdateFC packets are scheduled immediately after a resource is available. When the Link is in the L0 or L0s link state, Update FCs for each enabled type of non-infinite flow control credit must be scheduled for transmission at least once every 30  $\mu$ s (-0% or +50%), except when the extended synchronize bit of the control link register is set. In this case, the limit is 120  $\mu$ s (-0% or +50%).

### 6.2.4 Flow Control Timeout Mechanism

The 82575 implements the optional flow control update timeout mechanism. This mechanism is activated when the link is in L0 or L0s link state. It uses a timer with a limit of 200  $\mu$ s (0% or +50%), where the timer is reset by the receipt of any DLLP.

When the timer expires, the mechanism instructs the PHY to retrain the link through the LTSSM recovery state.

### 6.2.5 Error Forwarding

If a TLP is received with an error forwarding trailer, the packet is dropped and is not delivered to its destination.

System logic is expected to trigger a system level interrupt to inform the operating system of the problem. The operating system has the ability to stop the process associated with the transaction, re-allocate memory instead of the faulty area, etc.

## 6.3 Host Interface

### 6.3.1 Tag IDs

PCIe\* device numbers identify logical devices within the physical device. The 82575 implements a single logical device with up to two separate PCI functions: LAN 0 and LAN 1. The device number is captured from each type 0 configuration write transaction.

Each of the PCIe\* functions interfaces with the PCIe\* unit through one or more clients. A client ID identifies the client and is included in the tag field of the PCIe\* packet header. Completions always carry the tag value included in the request to allow routing of the completion to the appropriate client.

Tag IDs are allocated differently for read and write.

- For reads, [Table 54](#) lists the Tag ID allocation. The Tag ID is interpreted by hardware in order to forward the read data to the required device.
- For writes, [Table 55](#) and [Table 56](#) list the Tag ID allocation when DCA mode is not active. Unlike reads, the values are for debug only enabling tracing of requests through the system. When in DCA mode, the Tag IDs are replaced by the adequate DCA bits.

**Note:** Only five low bits of tags are usable because the configuration of the *Extended Tag Field Enable* bit in the configuration space Device Control register (8h) depends on the operating system and is not predictable.



Table 54 lists the tag IDs in read transactions.

Table 54. Assignment of Tag IDs

Tag ID	Description
00h	Reserved
01h	Descriptor Rx
03h:02h	Reserved
04h	Descriptor Tx
07h:05h	Reserved
08h	Data Request 0
09h	Data Request 1
0Ah	Data Request 2
0Bh	Data Request 3
10h	Management
11h	Message Unit
12h:1Fh	Reserved

Since DCA is implemented differently in data movement engine 1 and in data movement engine 2 platforms, the tag IDs are different as well.

DCA mode (data movement engine 1 and 2) is done by setting the *DCA\_Mode* bit in the DCA Mode register.

DCA itself is enabled or disabled by setting the *DCA\_Dis* bit in the GCR register.

Table 55. Tag IDs in Write Transactions (Data Movement Engine 1)

Tag ID	Description	DCA
00h	Management	Disabled
01h	Descriptors, data, WB tail for CPU ID 0	Enabled
02h	WB descriptor Tx / WB tail	Disabled
03h	Descriptors, data, WB tail for CPU ID 1	Enabled
04h	WB descriptor Rx	Disabled
05h	Descriptors, data, WB tail for CPU ID 2	Enabled
06h	Write data	Disabled
07h	Descriptors, data, WB tail for CPU ID 3	Enabled
08h	Reserved	-
09h	Descriptors, data, WB tail for CPU ID 4	Enabled
0Ah	Reserved	Disabled
0Bh	Descriptors, data, WB tail for CPU ID 5	Enabled
0Ch	Reserved	Disabled
0Dh	Descriptors, data, WB tail for CPU ID 6	Enabled



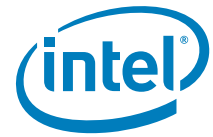

Tag ID	Description	DCA
0Eh	Reserved	Disabled
0Fh	Descriptors, data, WB tail for CPU ID 7	Enabled
1Bh:10h	Reserved	-
1Ch	Reserved	Disabled
1Dh	Reserved	Enabled
1Eh	MSI, MSI-X	Disabled
1Fh	Messages	Enabled

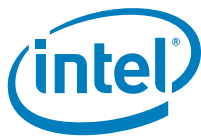

Table 56. Tag IDs in Write Transactions (Data Movement Engine 2)

Tag ID	Description	DCA
00h	All (no hint)	Enabled
01h	Descriptors, data, WB tail for CPU ID 1	Enabled
02h	Descriptors, data, WB tail for CPU ID 2	Enabled
03h	Descriptors, data, WB tail for CPU ID 3	Enabled
04h	Descriptors, data, WB tail for CPU ID 4	Enabled
05h	Descriptors, data, WB tail for CPU ID 5	Enabled
06h	Descriptors, data, WB tail for CPU ID 6	Enabled
07h	Descriptors, data, WB tail for CPU ID 7	Enabled
08h	Descriptors, data, WB tail for CPU ID 8	Enabled
09h	Descriptors, data, WB tail for CPU ID 9	Enabled
0Ah	Descriptors, data, WB tail for CPU ID 0A	Enabled
0Bh	Descriptors, data, WB tail for CPU ID 0B	Enabled
0Ch	Descriptors, data, WB tail for CPU ID 0C	Enabled
0Dh	Descriptors, data, WB tail for CPU ID 0D	Enabled
0Eh	Descriptors, data, WB tail for CPU ID 0E	Enabled
0Fh	Descriptors, data, WB tail for CPU ID 0F	Enabled
10h	Descriptors, data, WB tail for CPU ID 10	Enabled
11h	Descriptors, data, WB tail for CPU ID 11	Enabled
12h	Descriptors, data, WB tail for CPU ID 12	Enabled
13h	Descriptors, data, WB tail for CPU ID 13	Enabled
14h	Descriptors, data, WB tail for CPU ID 14	Enabled
15h	Descriptors, data, WB tail for CPU ID 15	Enabled
16h	Descriptors, data, WB tail for CPU ID 16	Enabled
17h	Descriptors, data, WB tail for CPU ID 17	Enabled
18h	Descriptors, data, WB tail for CPU ID 18	Enabled
19h	Descriptors, data, WB tail for CPU ID 19	Enabled
1Ah	Descriptors, data, WB tail for CPU ID 1A	Enabled
1Bh	Descriptors, data, WB tail for CPU ID 1B	Enabled
1Ch	Descriptors, data, WB tail for CPU ID 1C	Enabled
1Dh	Descriptors, data, WB tail for CPU ID 1D	Enabled
1Eh	Descriptors, data, WB tail for CPU ID 1E	Enabled
1Fh	Descriptors, data, WB tail for CPU ID 1F	Disabled

**Note:** While in data movement engine 2 mode, if DCA is not enabled in the platform then the Tag



IDs are as in data movement engine 1 mode. When in data movement engine 2 mode, messages and MSI/MSI-X write requests are sent with a hint tag of 1Fh.

### 6.3.2 Completion Timeout Mechanism

The completion timeout mechanism is activated for each request that requires one or more completions when the request is transmitted. Revision 1.1 of the PCI specification requires:

- Completion Timeout timer should not expire in less than 10 ms.
- Completion Timeout timer must expire if a request is not completed in 50 ms.

However, some platforms experience completion latencies that are longer than 50 ms, in some cases up to seconds. The 82575 provides a programmable range for the completion timeout as well as the ability to disable the completion timeout altogether. The new capability structure is assigned a PCIe\* capability structure version of 2h.

The 82575 controls the following aspects of completion timeout:

- Disabling or enabling completion timeout
- Disabling or enabling resending a request on completion timeout
- A programmable range of timeout values

Programming the behavior of completion timeout is done differently whether capability structure version 1h is enabled or capability structure version 2h. Table 57 lists the behavior for both cases.

**Table 57. Completion Timeout Programming**

Capability	Capability Structure Version = 1h	Capability Structure Version = 2h
Completion timeout enabling	Loaded from EEPROM into CSR bit	Controlled through PCI configuration. Visible through read-only CSR bit
Resend request enable	Loaded from EEPROM into CSR bit	Loaded from EEPROM into read-only CSR bit
Completion Timeout period	Loaded from EEPROM into CSR bit	Controlled through PCI configuration. Visible through read-only CSR bit

Completion Timeout Enable:

- Version = 1h- Loaded from the *Completion Timeout Disable* bit in the EEPROM into the *Completion\_Timeout\_Disable* bit in the PCIe\* Control register (GCR). The default is completion timeout enabled.
- Version = 2h - Programmed through PCI configuration. Visible through the *Completion\_Timeout\_Disable* bit in the PCIe\* Control register (GCR). The default is completion timeout enabled.

Resend Request Enable:

- The *Completion Timeout Resend* EEPROM bit, loaded in the *Completion\_Timeout\_Resend* bit in the PCIe\* Control register (GCR), enables resending the request (applies only when completion timeout is enabled). The default is to resend a request that timed out.

Completion Timeout Period:

- Version = 1h.- Loaded from the *Completion Timeout Value* field in the EEPROM to the *Completion\_Timeout\_Value* bits in the PCIe\* Control register (GCR).



- Version = 2h - Programmed through PCI configuration. Visible through the *Completion\_Timeout\_Value* bits in the PCIe\* Control register (GCR).

System software programs a range (one of 9 possible ranges that sub-divide the four ranges) into the PCI configuration register. The supported sub-ranges are:

- 50 μs to 50 ms (default).
- 50 μs to 100 μs
- 1 ms to 10 ms
- 16 ms to 55 ms
- 65 ms to 210 ms
- 260 ms to 900 ms
- 1 s to 3.5 s
- 4 s to 13 s
- 17 s to 64 s

A memory read request for which there are multiple completions are considered completed only when all completions have been received by the requester. If some, but not all, requested data is returned before the completion timeout timer expires, the requestor is permitted to keep or to discard the data that was returned prior to timer expiration.

## 6.4 Error Events and Error Reporting

The PCIe\* Specification defines two error reporting paradigms:

- Baseline error reporting capability.
- Advanced error reporting capability.

The baseline error reporting capabilities are required of all PCIe\* devices and define the minimum error reporting requirements. The advanced error reporting capability is defined for more robust error reporting and is implemented with a specific PCIe\* capability structure. Both mechanisms are supported by the 82575.

Also, the SERR# enable and the parity error bits from the legacy command register take part in the error reporting and logging mechanism.

### 6.4.1 Error Events

Table 58 lists the error events identified by the 82575 and its response. The PCIe\* Specification can be consulted for the effect on the PCI Status register.

Table 58. Response and Reporting of Error Events

Error Types	Error Events	Default Severity	Action
Physical Layer Errors			
Receiver Error	<ul style="list-style-type: none"> <li>• 8b/10b decode errors.</li> <li>• Packet framing error.</li> </ul>	Correctable. Send ERR_CORR.	TLP → Initiate Nak; drop data. DLLP → Drop.
Data Link Errors			



Table 58. Response and Reporting of Error Events

Error Types	Error Events	Default Severity	Action
Bad TLP	<ul style="list-style-type: none"> <li>Bad CRC.</li> <li>Illegal EDB.</li> <li>Wrong sequence number.</li> </ul>	Correctable. Send ERR_CORR.	TLP → Initiate Nak; drop data.
Bad DLLP	Bad CRC.	Correctable. Send ERR_CORR.	DLLP → Drop.
Replay Timer Timeout	Replay timer expiration.	Correctable. Send ERR_CORR.	Follow LL rules.
Replay Number Rollover	Replay number rollover.	Correctable. Send ERR_CORR.	Follow LL rules.
Data Link Layer Protocol Error	Received ACK/NACK not corresponding to any TLP.	Uncorrectable. Send ERR_FATAL.	Follow LL rules.
TLP Errors			
Poisoned TLP Received	TLP with error forwarding.	Uncorrectable. ERR_NONFATAL. Log header.	A poisoned completion is ignored and the request can be retried after timeout. If enabled, the error is reported.
Unsupported Request (UR)	<ul style="list-style-type: none"> <li>Wrong configuration access.</li> <li>MRdLk.</li> <li>Configuration request type1.</li> <li>Unsupported vendor. Defined type 0 message:</li> <li>Invalid MSG code.</li> <li>Unsupported TLP type.</li> <li>Wrong function number.</li> <li>Wrong traffic class or virtual channel.</li> <li>Received target access with data size larger than 64 bits.</li> <li>Received TLP outside address range.</li> </ul>	Uncorrectable. ERR_NONFATAL. Log header.	Send completion with UR.
Completion Timeout	Completion Timeout timer expired.	Uncorrectable. ERR_NONFATAL.	Send the read request again
Completer Abort (CA)	Attempts to write to the FLASH device when writes are disabled (FWE = 10b).	Uncorrectable. ERR_NONFATAL. Log header.	Send completion with CA.
Unexpected Completion	Received completion without a request for it (tag, ID, etc.).	Uncorrectable. ERR_NONFATAL. Log header.	Discard TLP.
Receiver Overflow	Received TLP beyond allocated credits.	Uncorrectable. ERR_FATAL.	Receiver behavior is undefined.
Flow Control Protocol Error	<ul style="list-style-type: none"> <li>Minimum initial flow control advertisements.</li> <li>Flow control update for infinite credit advertisement.</li> </ul>	Uncorrectable. ERR_FATAL.	Receiver behavior is undefined.



Table 58. Response and Reporting of Error Events

Error Types	Error Events	Default Severity	Action
Malformed TLP (MP)	<ul style="list-style-type: none"><li>Data payload exceeds maximum payload size.</li><li>Received TLP data size does not match length field.</li><li>TD field value does not correspond with the observed size.</li><li>Byte enables violations.</li><li>PM messages that do not use TC0.</li><li>Usage of unsupported VC.</li></ul>	Uncorrectable. ERR_FATAL. Log header.	Packet dropped. Free flow control credits.
Completion with Unsuccessful Completion Status		No action (already done by originator of completion).	Free FC credits.
Byte count integrity	When byte count isn't compatible with the length field and the actual expected completion length. For example, length field is 10 (in Dword), actual length is 40, but the byte count field that indicates how many bytes are still expected is smaller than 40, which is not reasonable.	Uncorrectable. ERR_FATAL	The 82575 doesn't check for this error and accepts these packets. This might cause a completion timeout condition.

## 6.4.2 Error Pollution

Error pollution can occur if error conditions for a given transaction are not isolated to the error's first occurrence. If the Physical Layer detects and reports a Receiver Error, to avoid having this error propagate and cause subsequent errors at upper layers, the same packet is not signaled at the Data Link or Transaction layers.

Similarly, when the Data Link Layer detects an error, subsequent errors, which occur for the same packet, are not signaled at the Transaction Layer.

## 6.4.3 Unsuccessful Completion Status

A completion with an unsuccessful completion status is dropped and not delivered to its destination. The request that corresponds to the unsuccessful completion is retried by sending a new request for the undeliverable data.

## 6.4.4 Error Reporting Changes

The Revision 1.1 PCI specification defines two changes to advanced error reporting. A (new) *Role-Based Error Reporting* bit in the Device Capabilities register is set to 1b to indicate that these changes are supported by the 82575.

- Setting the *SERR# Enable* bit in the PCI Command register also enables UR reporting (in the same manner that the *SERR# Enable* bit enables reporting of correctable and uncorrectable errors). The *SSERR# Enable* bit overrides the *UR Error Reporting Enable* bit in the PCI Express Device Control register.



2. Changes in the response to some Uncorrectable Non-Fatal errors detected in non-posted requests to the 82575 called Advisory Non-fatal Error cases. For each of the errors listed, the following behavior is defined:
  - a. The Advisory Non-Fatal Error Status bit is set in the Correctable Error Status register to indicate the occurrence of the advisory error, and the Advisory Non-Fatal Error Mask corresponding bit in the Correctable Error Mask register is checked to determine whether to proceed further with logging and signaling.
  - b. If the Advisory Non-Fatal Error Mask bit is clear, logging proceeds by setting the corresponding bit in the Uncorrectable Error Status register, based upon the specific uncorrectable error that is being reported as an advisory error. If the corresponding uncorrectable error bit in the Uncorrectable Error Mask register is clear, the First Error Pointer and Header Log registers are updated to log the error, assuming they are not still occupied by a previously unserviceable error.
  - c. An ERR\_COR Message is sent if the *Correctable Error Reporting Enable* bit is set in the Device Control register. An ERROR\_NONFATAL message is not sent for this error.

The following Uncorrectable Non-Fatal errors are considered as Advisory Non-fatal Errors:

- A Completion with an Unsupported Request or Completer Abort (UR/CA) Status that signals an uncorrectable error for a Non-Posted Request. If the severity of the UR/CA error is non-fatal, the Completer must handle this case as an Advisory Non-Fatal Error.
- When the Requester of a Non-Posted Request times out while waiting for the associated Completion, the Requester is permitted to attempt to recover from the error by issuing a separate subsequent Request or to signal the error without attempting recovery. The Requester is permitted to attempt recovery zero, one, or multiple (finite) times, but must signal the error (if enabled) with an uncorrectable error Message if no further recovery attempt is made. If the severity of the Completion Timeout is non-fatal, and the Requester elects to attempt recovery by issuing a new request, the Requester must first handle the current error case as an Advisory Non-Fatal Error.
- When a Receiver receives an unexpected Completion and the severity of the Unexpected Completion error is non-fatal, the Receiver must handle this case as an Advisory Non-Fatal Error.

## 6.5 Link Layer

### 6.5.1 ACK/NAK Scheme

The 82575 supports two alternative schemes for ACK/NAK rate:

1. ACK/NAK is scheduled for transmission according to timeouts specified in the LTIV register.
2. ACK/NAK is scheduled for transmission according to time-outs specified in the PCIe\* Specification.

The ACK/NAK scheme bit loaded from the EEPROM determines which of the two schemes is used.

### 6.5.2 Supported DLLPs

The following DLLPs are supported by the 82575 as a receiver.

**Table 59.** DLLPs Received

Ack	
Nak	
PM_Request_Ack	



Table 59. DLLPs Received

InitFC1-P	v2v1v0 = 000
InitFC1-NP	v2v1v0 = 000
InitFC1-Cpl	v2v1v0 = 000
InitFC2-P	v2v1v0 = 000
InitFC2-NP	v2v1v0 = 000
InitFC2-Cpl	v2v1v0 = 000
UpdateFC-P	v2v1v0 = 000
UpdateFC-NP	v2v1v0 = 000
UpdateFC-Cpl	v2v1v0 = 000

The following DLLPs are supported by the 82575 as a transmitter.

Table 60. DLLPs Initiated

Ack	
Nak	
PM_Enter_L1	
PM_Enter_L23	
PM_Active_State_Request_L1	
InitFC1-P	v2v1v0 = 000
InitFC1-NP	v2v1v0 = 000
InitFC1-Cpl	v2v1v0 = 000
InitFC2-P	v2v1v0 = 000
InitFC2-NP	v2v1v0 = 000
InitFC2-Cpl <sup>1</sup>	v2v1v0 = 000
UpdateFC-P	v2v1v0 = 000
UpdateFC-NP	v2v1v0 = 000

1. UpdateFC-Cpl is not transmitted due to the infinite FC-CPL allocation.

### 6.5.3 Transmit EDB Nullifying

In case of a retrain, there is a need to guarantee that no abrupt termination of the transmit packet occurs. For this reason, early termination of the transmitted packet is possible. This is accomplished by appending EDB to the packet.

## 6.6 Physical Layer

### 6.6.1 Link Width

The 82575 supports a maximum link width of x4, x2, or x1 as determined by the minimum of:

- The PCIEPert SKU fuse
- The EEPROM *Lane\_Width* field in PCIe\* Initialization Configuration 3 word





The max link width is loaded into the *Maximum Link Width* field of the PCIe\* Capability register (LCAP[11:6]). The hardware default is the x4 link.

During link configuration, the platform and the 82575 negotiate on a common link width. The link width must be one of the supported PCIe\* link widths (1x, 2x, 4x), such that:

- If Maximum Link Width = x4, then the 82575 negotiates to either x4, x2 or x1
- If Maximum Link Width = x2, then the 82575 negotiates to either x2 or x1
- If Maximum Link Width = x1, then the 82575 only negotiates to x1

### 6.6.1.1 Polarity Inversion

If polarity inversion is detected, the Receiver must invert the received data.

During the training sequence, the Receiver looks at Symbols 6-15 of TS1 and TS2 as the indicator of Lane polarity inversion (D+ and D- are swapped). If Lane polarity inversion occurs, the TS1 Symbols 6-15 received are D21.5 as opposed to the expected D10.2. Similarly, if Lane polarity inversion occurs, Symbols 6-15 of the TS2 ordered set are D26.5 as opposed to the expected D5.2. This provides the clear indication of Lane polarity inversion.

### 6.6.1.2 L0s Exit latency

The number of FTS sequences (N\_FTS) sent during L0s exit, is loaded from the EEPROM.

### 6.6.1.3 Lane-to-Lane De-Skew

A multi-lane link can have many sources of lane to lane skew. Although symbols are transmitted simultaneously on all lanes, they cannot be expected to arrive at the receiver without lane-to-lane skew. The lane-to-lane skew may include components, which are less than a bit time, bit time units (400 ps for 2.5 Gb), or full symbol time units (4 ns) of skew caused by the retiming repeaters' insert/delete operations. Receivers use TS1 or TS2 or Skip ordered sets (SOS) to perform link de-skew functions.

The 82575 supports de-skew of up to 6 symbols time (24 ns).

### 6.6.1.4 Lane Reversal

The following lane reversal modes are supported:

- Lane configuration of x4, x2, and x1
- Lane reversal in x4 and in x2
- Degraded mode (downshift) from x4 to x2 to x1 and from x2 to x1, with one restriction: if lane reversal is executed in x4, then downshift is only to x1 and not to x2.

**Note:** The above restriction requires that a x2 interface to the 82575 must connect to lanes 0 and 1 on the 82575. The PCIe\* Card Electromechanical specification does not allow to route a x2 link to a wider connector. Therefore, a system designer is not allowed to connect a x2 link to lanes 2 and 3 of a PCI e\* connector. It is also recommended that when using x2 mode on a NIC, the 82575 is connected to lanes 0 and 1.



### 6.6.1.5 Reset

The PCIe\* Physical layer can supply a core reset to the 82575. The reset can be caused by the following:

1. Upstream move to Hot reset - Inband Mechanism (LTSSM).
2. Recovery failure (LTSSM returns to detect)
3. Upstream component move to disable.

### 6.6.1.6 Scrambler Disable

The Scrambler/de-scrambler functionality in the 82575 can be eliminated by these mechanisms:

1. Upstream according to the PCIe\* specification.
2. EEPROM bit.

## 6.6.2 Performance Monitoring

The 82575 incorporates PCIe\* performance monitoring counters to provide common capabilities for evaluate performance. It implements four 32-bit counters to correlate between concurrent measurements of events as well as the sample delay and interval timers. The four 32-bit counters can also operate in a two 64-bit mode to count long intervals or payloads.

The list of events supported by the 82575 and the counters control bits are described in the memory register map.

## 6.6.3 Configuration Registers

### 6.6.3.1 PCI Compatibility

PCIe\* is completely compatible with existing deployed PCI software. To achieve this, PCIe\* hardware implementations conform to the following requirements:

- All devices must be supported by deployed PCI software and must be enumerable as part of a tree through PCI device enumeration mechanisms.
- Devices must not require any resources such as address decode ranges and interrupts beyond those claimed by PCI resources for operation of software compatible and software transparent features with respect to existing deployed PCI software.
- Devices in their default operating state must confirm to PCI ordering and cache coherency rules from a software viewpoint.
- PCIe\* devices must conform to PCI power management specifications and must not require any register programming for PCI compatible power management beyond those available through PCI power management capability registers. Power management is expected to conform to a standard PCI power management by existing PCI bus drivers.

PCIe\* devices implement all registers required by the PCI Specification as well as the power management registers and capability pointers specified by the PCI power management specification. In addition, PCIe\* defines a PCIe\* capability pointer to indicate support for PCIe\* extensions and associated capabilities.



The LAN0 and LAN1 are shown in PCI functions 0 and PCI functions 1, respectively. The LAN Function Select field in EEPROM word 21h is reflected in the FACTPS (05B30h) register and determines if LAN0 appears in PCI function 0 or PCI function 1. LAN1 appears in the complementary PCI function.

All functions contain the following regions of the PCI configuration space:

- Mandatory PCI configuration registers
- Power management capabilities
- MSI capabilities
- PCIe\* extended capabilities

## 6.6.4 Mandatory PCI Configuration Registers

The PCI configuration registers map follows. Registers of the LAN functions that have changed relative to earlier Gigabit Ethernet controllers are marked in ***bold italics***. Initial values of the configuration registers are marked in parenthesis.

Configuration registers are assigned one of the attributes listed in the following table.

RD/WR	Description
RO	Read only register. Register bits are read only and cannot be altered by software.
RW	Read/Write register. Register bits are read or write and may be either set or reset.
R/W1C	Read only status / Write 1b to Clear register. Writing a 0b to R/W1C bits has no effect.
ROS	Read only register with Sticky Bits. Register bits are read only and cannot be altered by software. Bits are not cleared by reset and can only be reset with the PWRGOOD signal. Devices that consume AUX power are not allowed to reset sticky bits when AUX power consumption (either through AUX power or PME enable) is enabled.
RWS	Read/Write with Sticky Bits: Register bits are read or write and might be either set or reset by software to the desired state. Bits are not cleared by a reset and can only be reset with the PWRGOOD signal. Devices that consume AUX power are not allowed to reset sticky bits when AUX power consumption (either through AUX power or PME enable) is enabled.
R/W1CS	Read only status / Write 1b to Clear with Sticky Bits. Register bits indicate status when read. A set bit indicates a status event may be cleared by writing a 1b. Writing a 0b to R/W1C bits has no effect. Bits are not cleared by reset and can only be reset with the PWRGOOD signal. Devices that consume AUX power are not allowed to reset sticky bits when AUX power consumption (either through via AUX power or PME enable) is enabled.
HwInit	Hardware Initialized. Register bits are initialized by firmware or hardware mechanisms such as pin strapping or serial EEPROM. Bits are read only after initialization and can only be reset (for write once by firmware) with the PWRGOOD signal.
RsvdP	Reserved and Preserved: This is reserved for future implementations. Software must preserve the value read for writes to bits.
RsvdZ	Reserved and 0b. This is reserved for future R/W1C implementations. Software must use 0b for writes to bits.

The functions have a separate enabling mechanism. A function that is not enabled does not function and does not expose its PCI configuration registers.

Function	Default	Initial EEPROM Address
LAN 0	1b	Strapping Option.
LAN 1	1b	Strapping Option / EEPROM word 10h, bit 11



**Table 61. PCI Compatible Configuration Registers**

Byte Offset	Byte 3	Byte 2	Byte 1	Byte 0
0h	Device ID		Vendor ID (8086h)	
4h	Status Register (0010h)		Command Register (0000h)	
8h	Class Code (020000h, 010185h, 070002h, 0C0701h)			Revision ID (02h)
Ch	(00h)	Header Type (00h, 80h)	Latency Timer (00h)	Cache Line Size (10h)
10h	Base Address 0			
14h	Base Address 1			
18h	Base Address 2			
1Ch	Base Address 3			
20h	Base Address 4			
24h	Base Address 5			
28h	CardBus CIS Pointer (00000000h)			
2Ch	Subsystem ID (0000h)		Subsystem Vendor ID (8086h)	
30h	Expansion ROM Base Address			
34h	Reserved (000000h)			Cap_Ptr (C8h)
38h	Reserved (00000000h)			
3Ch	Max_Latency (00h)	Min_Grant (00h)	Interrupt Pin (01h)	Interrupt Line (00h)

**Note:** The following color notation is used for reference:

	Fields identical to all functions.
	Read only fields.
	Hard coded fields.

Interpretation of the various 82575 registers is provided as follows.

### Vendor ID

This is a read only register that has the same value for all PCI functions. It identifies uniquely Intel products. The field can be automatically loaded from the EEPROM at address 0Eh during initialization with a default value of 8086h.

### Device IDs

This is a read-only register. This field identifies individual 82575 functions. It has the same default value for the two LAN functions but can be auto-loaded from the EEPROM during initialization with a different value for each port. The following table lists the possible values according to the SKU and functionality of each function.

**Note:** Refer to the 82575 Specification Update for supported device IDs.

### Command

This is a read/write register. Its layout follows. Shaded bits are not used by this implementation and are hard wired to 0b. Each function has its own Command register. Unless explicitly specified, functionality is the same in all functions.



Bit(s)	Initial Value	Description
15:11	0b	Reserved.
10	0b	Interrupt Disable. <sup>1</sup>
9	0b	Fast Back-to-Back Enable. Hardwired to 0b.
8	0b	SERR# Enable.
7	0b	Wait Cycle Enable. Hardwired to 0b.
6	0b	Parity Error Response.
5	0b	Palette Snoop Enable. Hardwired to 0b.
4	0b	MWI Enable. Hardwired to 0b.
3	0b	Special Cycle Monitoring. Hardwired to 0b.
2	0b	Enable Mastering: LAN functions - R/W field. Dummy function - RO as zero field.
1	0b	Memory Access Enable: LAN functions - R/W field. Dummy function - RO as zero field.
0	0b	I/O Access Enable: LAN functions - R/W field. Dummy function - RO as zero field.

1. The Interrupt Disable register bit is a read-write bit that controls the ability of a PCIe\* device to generate a legacy interrupt message. When set, devices are prevented from generating legacy interrupt messages.

### Status Register

Shaded bits are not used by this implementation and are hardwired to 0b. Each function has its own status register. Unless explicitly specified, functionality is the same in all functions.

Bit(s)	Initial Value	RD/WR	Description
15	0b	R/W1C	Detected Parity Error.
14	0b	R/W1C	Signaled System Error.
13	0b	R/W1C	Received Master Abort.
12	0b	R/W1C	Received Target Abort.
11	0b	R/W1C	Signaled Target Abort.
10:9	00b		DEVSEL Timing. Hardwired to 0b.
8	0b	R/W1C	Data parity reported.
7	0b		Fast Back-to-Back Capable. Hardwired to 0b.
6	0b		Reserved.
5	0b		66 MHz Capable. Hardwired to 0b.
4	1b	RO	New Capabilities. This indicates that a device implements Extended Capabilities. The 82575 sets this bit and implements a capabilities list indicating its support for PCI Power Management, message signaled interrupts, and the PCIe* extensions.
3	0b	RO	Interrupt Status. <sup>1</sup>
2:0	0b		Reserved.



1. The Interrupt Status field is a RO field that indicates that an interrupt message is pending internally to the device.

### Revision

The default revision ID of this device is 02h.

**Note:** LAN 0 and LAN 1 functions have the same revision ID.

### Class Code

The class code is a read only. Hard coded values that identify the device functionality:

LAN 0 or LAN 1	020000h/01000h	Ethernet/SCSI Adapter Selected according to bit 11 or 12 in word 1Eh in the EEPROM for LAN0 and LAN1, respectively.
----------------	----------------	--

### Cache Line Size

This field is implemented by PCIe\* devices as a read/write field for legacy compatibility purposes but has no impact on any PCIe\* device functionality. It is loaded from EEPROM words 1Ah. All functions are initialized to the same value.

### Latency Timer

The 82575 does not use this and this bit is hardwired to 0b.

### Header Type

This indicates if an 82575 is single function or multifunction. If a single function is the only active one then this field has a value of 00h to indicate a single function 82575. If other functions are enabled then this field has a value of 80h to indicate a multi-function 82575.

### Base Address Registers

The Base Address Registers (BARs) are used to map the 82575 register space of the various functions. 32-bit addresses are used in one register for each memory mapping window.

**Table 62. LAN 0 and LAN 1 Functions**

BAR	Address	Bits 31:4	Bit 3	Bit 2	Bit 1	Bit 0
0	10h	Memory BAR (R/W - 31:17; 0 - 16:4)	0b	0b	0b	0b
1	14h	Flash BAR (R/W - 31:23/16; 0 - 22/15:4) <sup>1</sup>	0b	0b	0b	0b
2	18h	IO BAR (R/W - 31:5; 0 - 4:1)			0b	1b
3	1Ch	MSI-X BAR (R/W - 31:14; '0' - 13:4)	0b	0b	0b	0b
4	20h	Reserved (read as 0b)				
5	24h	Reserved (read as 0b)				

1. LAN Flash sizes can be in the range of 64 KB to 8 MB, depending on the Flash size field in EEPROM word 0Fh.



All base registers have the following fields:

Field	Bit(s)	RD/WR	Initial Value	Description
I/O Address Space	31:5	R/W	0b	These are read/write bits that indicate I/O Bar locations.
Memory Address Space	31:4	R/W	0b	These are read/write bits hardwired to 0b depending on the memory mapping window sizes. <ul style="list-style-type: none"> <li>LAN memory spaces are 128K bytes.</li> <li>LAN Flash spaces can be 64 KB and up to 8 MB in powers of 2. Mapping window size is set by the EEPROM word 0Fh.</li> <li>MSI-X memory space is 16 KB.</li> </ul>
I/O Address Space	4:3	RO	0b	Hardwired to 0b to indicate an I/O space of 32 bytes.
Prefetch Memory	3	R	0b	The 82575 implements non-prefetchable space due to side effects of read transactions. 0b = Non-prefetchable space 1b = Prefetchable space
Memory Type	2:1	R	32-bit = 00b	This field indicates the address space size. 00b = 32-bit
Memory	0	R	Memory = 0b I/O = 1b	If this bit equals 0b, it indicates memory space. If it equals 1b, it indicates input/output.

**Table 63. Memory & I/O Mapping**

Mapping Window	Mapping Description
Memory BAR 0	The internal registers and memories are accessed as direct memory mapped offsets from the base address register. Software accesses can be Dword or 64 bytes.
Flash BAR 1	The external Flash can be accessed using direct memory mapped offsets from the Flash BAR. Software accesses can be byte, word, Dword or 64 bytes.
I/O BAR 2	All internal registers, memories, and Flash can be accessed using I/O operations. There are two 4-byte registers in the I/O mapping window: Address Register and Data Register. Software accesses can be byte, word or Dword.
MSI-X Bar 3	The internal registers and memories are accessed as direct memory mapped offsets from the Base Address register. Software accesses can be Dword or 64 bytes.

### Expansion ROM Base Address

This register is used to define the address and size information for boot-time access to the optional Flash memory. Only the LAN 0/LAN 1 functions can use this window. It is enabled by EEPROM words 24h and 14h for LAN 0 and LAN 1, respectively. This register returns a zero value for functions without expansion ROM window.

Bits 31:11	Bits 10:1	Bit 0
Expansion ROM BAR (R/W - 31:12316; '0' - 22/15:1)		En



Field	Bit(s)	RD/WR	Initial Value	Description
Address	31:11	R/W	0b	This field contains address bits, which are read/write and hardwired to 0b, depending on the memory mapping window size. The LAN Expansion ROM space can be 64 KB to 8 MB in powers of 2. The mapping window size is set by EEPROM word 0Fh.
Reserved	10:1	R	0b	This field is reserved and should be set to 0b. (Writes are ignored.)
Enable Expansion	0	R/W	0b	1b = Enables expansion ROM access. 0b = Disables expansion ROM access.

### Subsystem ID

This value can be loaded automatically from the EEPROM at power up with a default value of 0000h.

PCI Function	Default Value	EEPROM Address
LAN Functions	0000h	0Bh

### Subsystem Vendor ID

This value can be loaded automatically from the EEPROM address 0Ch at power up or reset. A value of 8086h is the default for this field at power up if the EEPROM does not respond or is not programmed. All functions are initialized to the same value.

### Cap\_Ptr

The Capabilities Pointer field (Cap\_Ptr) is an 8-bit field that provides an offset in the device PCI Configuration Space for the location of the first item in the Capabilities Linked List. The 82575 sets this bit and implements a capabilities list to indicate that it supports PCI Power Management, Message Signaled Interrupts, and PCIe\* Extended capabilities. Its value is 40h, which is the address of the first entry, PCI Power Management.

Address	Item	Next Pointer
40h : 47h	PCI Power Management	50h
50h : 5Fh	Message Signaled Interrupt	60h
60h : 6Fh	Extended Message Signaled Interrupt	A0h
A0h : DBh	PCIe* Capabilities	00h

### Interrupt Pin

This is a read only register.

LAN 0 / LAN 1.<sup>1</sup> A value of 01h or 02h indicates that this function implements legacy interrupt on INTA or INTB, respectively. This value is loaded from EEPROM word 24h and 14h for LAN 0 and LAN 1, respectively.

### Interrupt Line

1. If only a single device or function of the 82575 is enabled, this value is ignored, and the Interrupt Pin field of the enabled device reports INTA# usage.





Read and write registers programmed by software indicate the type of system interrupt request lines the device interrupt pin is bound to. (Each PCIe\* function has its own register.)

Max\_Lat/Min\_Gnt

This field is not used and is hardwired to 0b.

### 6.6.5 PCI Power Management Registers

All fields are reset on full power up. All of the fields except PME\_En and PME\_Status are reset on exit from the D3cold state. If auxiliary power is not supplied, the PME\_En and PME\_Status fields are also reset on exit from the D3cold state.

The tables that follow list the organization of the PCI Power Management Register block. Initial values are marked in parenthesis and the following color notation is used.

Some fields in this section depend on the power management enable bits in EEPROM word 0Ah.

**Table 64. Power Management Register Block**

Byte Offset	Byte 3	Byte 2	Byte 1	Byte 0
40h	Power Management Capabilities (PMC)		Next Pointer (50h)	Capability ID
44h	Data	PMCSR_BSE Bridge Support Extensions	Power Management Control / Status Register (PMCSR)	

**Note:** The following color notation is used for reference:

	Fields identical to all functions.
	Read only fields.
	Hard coded fields and strapping options.

The following section describes the register definitions, whether they are required or optional for compliance, and how they are implemented in 82575.

#### Capability ID

The Capability ID is 1 byte at offset 40h and is read only. This field equals 01h, indicating the linked list item as the PCI Power Management Registers.

#### Next Pointer

The Next Pointer is 1 byte at offset 41h and is read only. This field provides an offset to the next capability item in the capability list. It has a value of 50h, which points to the MSI capability.

#### Power Management Capabilities (PMC)

The PMC is 2 bytes at offset 42h and is read only. This field describes the device functionality at the power management states as described in the table that follows. Each device function has its own register.



Table 65. Power Management Capabilities (PMC)

Bit(s)	Default	RD/WR	Description
15:11		RO	PME_Support. This 5-bit field indicates the power states in which the function may assert PME#. The IDE function field is hardwired to 0b while the other functions depend on EEPROM word 0Ah: Condition ⇒ Functionality ⇒ Value PM Disable in EEPROM ⇒ No PME at all states ⇒ 00000b PM Enable & No Aux Pwr ⇒ PME at D0 and D3hot ⇒ 01001b PM Enable with Aux Pwr ⇒ PME at D0, D3hot and D3cold ⇒ 11001b
10	0b	RO	D2_Support. The 82575 does not support the D2 state.
9	0b	RO	D1_Support. The 82575 does not support D1 state.
8:6	000b	RO	Auxiliary Current. This is the required current defined in the data register.
5	1b	RO	DSI. The 82575 requires its device driver to be executed following transition to the D0 uninitialized state.
4	0b	RO	Reserved. This bit is reserved and should be set to 0b.
3	0b	RO	PME_Clock. The PME clock is disabled and is hardwired to 0b.
2:0	010b	RO	Version. The 82575 complies with PCI Power Management Specification, Revision 1.2.

Power Management Control/Status Register (PMCSR)

The PMCSR is 2 bytes at offset 44h and is read/write. This register is used to control and monitor power management events in the device. Each device function has its own PMCSR.

Table 66. Power Management Control/Status Register

Bit(s)	Default	RD/WR	Description
15	0b (at power up)	R/W1C	PME_Status. This bit is set to 1b when the function detects a wake-up event independent of the state of the PME enable bit. Writing a 1b clears this bit.
14:13	Reflects value in Data Register	RO	Data_Scale. This field indicates the scaling factor that is used to interpret the value of the Data Register. For the LAN and Common functions this field equals 01b (indicating 0.1 watt units) if power management is enabled in the EEPROM and the Data_Select field is set to 0, 3, 4, or 7 (or 8 for Function 0). Otherwise, it equals 00b. For the manageability functions this field equals 10b (indicating 0.01 watt units) if power management is enabled in the EEPROM and the Data_Select field is set to 0, 3, 4, or 7. Otherwise, it equals 00b.
12:9	0000b	R/W	Data_Select. This four-bit field is used to select which data is to be reported through the Data Register and Data_Scale field. These bits are writable only when power management is enabled through EEPROM.
8	0b (at power up)	R/W	PME_En. If Power Management is enabled in the EEPROM, writing a 1b to this register enables wakeup. If power management is disabled in the EEPROM, writing a 1b to this bit has no affect and will not set the bit to 1b.
7:4	0000b	RO	Reserved. This bit is reserved and should return a value of 0000b for this field.



**Table 66. Power Management Control/Status Register**

Bit(s)	Default	RD/WR	Description
3	0b	RO	No_Soft_Reset. This bit is always set to 0b to indicate that the 82575 performs an internal reset while transitioning from D3hot to D0 via software control of the PowerState bits. Configuration context is lost when performing the soft reset. Upon transition from the D3hot to the D0 state, full reinitialization sequence is needed to return the 82575 to D0 Initialized.
2	0b	RO	Reserved for PCIe*.
1:0	00b	R/W	Power State. This field is used to set and report the power state of a function as defined: 00b – D0 01b – D1 (cycle ignored if written with this value) 10b – D2 (cycle ignored if written with this value) 11b – D3 (cycle ignored if power management is disabled in the EEPROM)

**PMCSR\_BSE Bridge Support Extensions: 1 Byte, Offset 46h, (RO)**

This field is 1 byte at offset 46h and is read only. This register is not implemented in the 82575 and its value should be set to 00h.

**Data Register: 1 Byte, Offset CFh, (RO)**

The Data Register is 1 byte at offset CFh and is read only. This optional register is used to report power consumption and heat dissipation. The reported register is controlled by the Data\_Select field in the PMCSR, and the power scale is reported in the Data\_Scale field of the PMCSR. Data from this field is loaded from the EEPROM if power management is enabled in the EEPROM or with a default value of 00h otherwise. The values for the 82575 functions are as follows:

Function	D0 (Consume/Dissipate)	D3 (Consume/Dissipate)	Common	Data Scale
Data Select	0h / 4h	3h / 7h	8h	
Function 0	EEPROM Word 22h	EEPROM Word 22h	EEPROM Word 22h	01b
Function 1	EEPROM Word 22h	EEPROM Word 22h	00h	01b

**Note:** For other Data\_Select values, the Data Register output is reserved (0b).

### 6.6.5.1 Message Signaled Interrupt (MSI) Configuration Registers

This structure is required for PCIe\* devices. There are no changes to this structure from the PCI Specification, Revision 2.2. Initial values of the configuration registers are marked in parenthesis and the following color notation is used.

**Table 67. Message Signaled Interrupt Configuration Registers**

Byte Offset	Byte 3	Byte 2	Byte 1	Byte 0
50h	Message Control (0080h)		Next Pointer (60h)	Capability ID (05h)
54h	Message Address			
58h	Message Upper Address			
5Ch	Reserved		Message Data	

**Note:** The following color notation is used for reference:



	Fields identical to all functions.
	Read only fields.
	Hard coded fields and strapping options.

**Capability ID: 1 Byte, Offset 50h, (RO)**

This field equals 05h indicating the linked list item as being the Message Signaled Interrupt registers.

**Next Pointer: 1 Byte, Offset 51h, (RO)**

This field provides an offset to the next capability item in the capability list. Its value of 60h points to the MSI-X capability structure.

**Message Control: 2 Byte, Offset 52h, (R/W)**

The register fields are described in the table that follows. There is a dedicated register per PCI function to enable separately their MSI.

Bits	Default	RD/WR	Description
15:8	0b	RO	Reserved. Reads as 0b.
7	1b	RO	64-bit Capable. A value of 1b indicates that the 82575 is capable of generating 64-bit message addresses.
6:4	000b	RO	Multiple Message Enable. The 82575 returns 000b to indicate that it supports a single message per function.
3:1	000b	RO	Multiple Message Capable. The 82575 indicates a single requested message per each function.
0	0b	R/W	MSI Enable. If 1b, Message Signaled Interrupts. In this case, the 82575 generates MSI for interrupt assertion instead of INTx signaling.

**Message Address Low 4 Byte, Offset 54h, (R/W)**

Written by the system to indicate the lower 32 bits of the address to use for the MSI memory write transaction. The lower two bits always return 0b regardless of the write operation.

**Message Address High 4 Byte, Offset 58h, (R/W)**

Written by the system to indicate the upper 32-bits of the address to use for the MSI memory write transaction.

**Message Data 2 Byte, Offset 5C, (R/W)**

Written by the system to indicate the lower 16 bits of the data written in the MSI memory write DWORD transaction. The upper 16 bits of the transaction are written as 0b.

## 6.6.5.2 MSI-X Configuration

The MSI-X capability structure is required for PCIe\* devices. More than one MSI-X capability structure per function is prohibited, but a function is permitted to have both an MSI and an MSI-X capability structure.



In contrast to the MSI capability structure, which directly contains all of the control/status information for the function's vectors, the MSI-X capability structure instead points to an MSI-X Table structure and a MSI-X Pending Bit Array (PBA) structure, each residing in Memory Space.

Each structure is mapped by a Base Address register (BAR) belonging to the function, located beginning at 10h in Configuration Space. A BAR Indicator register (BIR) indicates which BAR, and a QWORD-aligned Offset indicates where the structure begins relative to the base address associated with the BAR. The BAR is permitted to be either 32-bit or 64-bit, but must map Memory Space. A function is permitted to map both structures with the same BAR, or to map each structure with a different BAR.

The MSI-X Table structure typically contains multiple entries, each consisting of several fields: Message Address, Message Upper Address, Message Data, and Vector Control. Each entry is capable of specifying a unique vector.

The Pending Bit Array (PBA) structure contains the function's Pending Bits, one per Table entry, organized as a packed array of bits within QWORDS.

The last QWORD is not necessarily be fully populated.

**Table 68. MSI-X Capability Structure**

Byte Offset	Byte 3	Byte 2	Byte 1	Byte 0
60h	Message Control (0009h)		Next Pointer (0Ah)	Capability ID (11h)
64h <sup>1</sup>	Table Offset			Table BIR
68h <sup>2</sup>	PBA Offset			PBA BIR

1. Hardwired to 3h.
2. Hardwired to 2003h.

**Note:** The following color notation is used for reference:

	Fields identical to all functions.
	Read only fields.
	Hard coded fields and strapping options.

#### Capability ID: 1 Byte, Offset 60h, (RO)

This field equals 11h indicating the linked list item as being the MSI-X registers.

#### Next Pointer: 1 Byte, Offset 61h, (RO)

This field provides an offset to the next capability item in the capability list. Its value of A0h points to the PCIe\* capability structure.

#### Message Control: 2 Byte, Offset 62h, (R/W)

The register fields are described in the table that follows. There is a dedicated register per PCI function to enable separately their MSI.



Table 69. MSI-X Message Control Field

Bits	Default	RD/WR	Description
10:0	009h <sup>1</sup>	RO	Table Size. System software reads this field to determine the MSI-X Table Size N, which is encoded as N-1. For example, a returned value of 00000001111b indicates a table size of 16.
13:11	000b	RO	Always return 0b on reads. Write operation has no effect.
14	0b	R/W	Function Mask. If set to 1b, all of the vectors associated with the function are masked, regardless of their per-vector <i>Mask</i> bit states.  If set to 0b, each vector's <i>Mask</i> bit determines whether the vector is masked or not.  Setting or clearing the MSI-X <i>Function Mask</i> bit has no effect on the state of the per-vector <i>Mask</i> bits.
15	0b	R/W	MSI-X Enable. If set to 1b and the MSI Enable bit in the MSI Message Control register is 0b, the function is permitted to use MSI-X to request service and is prohibited from using its INTx# pin.  System configuration software sets this bit to enable MSI-X. A software device driver is prohibited from writing this bit to mask a function's service request.  If set to 0b, the function is prohibited from using MSI-X to request service.

1. Default is read from the EEPROM.

Table 70. MSI-X Table Offset

Bits	Default	RD/WR	Description
31:3	000h	RO	Table Offset  Used as an offset from the address contained by one of the function's Base Address registers to point to the base of the MSI-X Table. The lower 3 Table BIR bits are masked off (set to 0b) by software to form a 32-bit QWORD-aligned offset.  This field is read only.
2:0	3h	RO	Table BIR  Indicates which one of a function's Base Address registers, located beginning at 10h in Configuration Space, is used to map the function's MSI-X Table into Memory Space.  BIR Value Base Address register 0 = 10h 1 = 14h 2 = 18h 3 = 1Ch 4 = 20h 5 = 24h 6 = Reserved 7 = Reserved  For a 64-bit Base Address register, the Table BIR indicates the lower DWORD.

**Table 71. MSI-X PBA Table Offset**

Bits	Default	RD/WR	Description
31:3	400h	RO	<p>PBA Offset</p> <p>Used as an offset from the address contained by one of the function's Base Address registers to point to the base of the MSI-X PBA. The lower 3 PBA BIR bits are masked off (set to 0b) by software to form a 32-bit QWORD-aligned offset.</p> <p>This field is read only.</p>
2:0	3h	RO	<p>PBA BIR</p> <p>Indicates which one of a function's Base Address registers, located beginning at 10h in Configuration Space, is used to map the function's MSI-X PBA into Memory Space.</p> <p>The PBA BIR value definitions are identical to those for the MSI-X Table BIR.</p> <p>This field is read only.</p>

To request service using a given MSI-X Table entry, a function performs a DWORD memory write transaction using the contents of the Message Data field entry for data, the contents of the Message Upper Address field for the upper 32 bits of address, and the contents of the Message Address field entry for the lower 32 bits of address. A memory read transaction from the address targeted by the MSI-X message produces undefined results.

MSI-X Table entries and *Pending* bits are each numbered 0 through N-1, where N-1 is indicated by the Table Size field in the MSI-X Message Control register. For a given arbitrary MSI-X Table entry K, its starting address can be calculated with the formula:

- Entry starting address = Table base + K\*16

For the associated *Pending* bit K, its address for QWORD access and bit number within that QWORD can be calculated with the formulas:

- QWORD address = PBA base + (K div 64)\*8
- QWORD bit# = K mod 64

Software that chooses to read *Pending* bit K with DWORD accesses can use these formulas:

- DWORD address = PBA base + (K div 32)\*4
- DWORD bit# = K mod 32

### 6.6.5.3 PCIe\* Configuration Registers

PCIe\* provides two mechanisms to support native features:

- PCIe\* defines a PCI capability pointer indicating support for PCIe\*
- PCIe\* extends the configuration space beyond the 256 bytes available for PCI to 4096 bytes.

The 82575 implements the PCIe\* Capability Structure for Endpoint Devices as follows:

**Table 72. PCIe\* Configuration Registers**

Byte Offset	Byte 3	Byte 2	Byte 1	Byte 0
A0h	PCIe* Capability Register		Next Pointer	Capability ID
A4h	Device Capability			
A8h	Device Status		Device Control	



Table 72. PCIe\* Configuration Registers

Byte Offset	Byte 3	Byte 2	Byte 1	Byte 0
ACh	Link Capability			
B0h	Link Status		Link Control	
B4h	Reserved			
B8h	Reserved		Reserved	
BCh	Reserved			
C0h	Reserved		Reserved	
C4h	Device Capability 2			
C8h	Reserved		Device Control	
CCh	Reserved			
D0h	Reserved		Reserved	
D4h	Reserved			
D8h	Reserved		Reserved	

**Note:** The following color notation is used for reference:

	Fields identical to all functions.
	Read only fields.
	Hard coded fields and strapping options.

### Capability ID

The Capability ID is 1 byte at offset A0h and is read only. This field equals 10h, indicating the linked list item is a PCIe\* Capabilities Register.

### Next Pointer

The Next Pointer is 1 byte at offset A1h and is read only. It points to the offset of the next capability item in the capability list. A 00h value indicates that it is the last item in the capability linked list.

### PCIe\* CAP

The PCIe\* CAP field is 2 bytes at offset A2h. The PCIe\* capabilities register identifies the PCIe\* device type and associated capabilities. This is a read only register identical to all functions.

Bit(s)	Default	RD/WR	Description
15:14	00b	RO	Reserved
13:9	00000b	RO	Interrupt Message Number The 82575 does not implement multiple MSI per function. This field is hardwired to 0b.
8	0b	RO	Slot Implemented The 82575 does not implement slot options. This field is hardwired to 0b.
7:4	0000b	RO	Device/Port Type This field indicates the type of PCIe* functions. All functions are Native PCI functions with a value of 0000b.
3:0	0001b <sup>1</sup>	RO	Capability Version This indicates the PCIe* capability structure version number. The 82575 supports both version 1 and version 2.





1. Default loaded from the EEPROM.

## Device CAP

This field is 4 bytes at offset A4h and is read only. It identifies the PCIe\* device specific capabilities. It is a read only register with the same value for LAN function 0 and LAN function 1.

Bit(s)	Default	RD/WR	Description
31:28	RO	0000b	Reserved
27:26	RO	00b	Slot Power Limit Scale This field is used in upstream ports only. It is hardwired in the 82575 to 0b for all functions.
25:18	RO	00h	Slot Power Limit Value This field is used in upstream ports only. It is hardwired in the 82575 to 0b for all functions.
17:16	RO	00b	Reserved
15	RO	1b	Role-Based Error Reporting This bit, when set, indicates that the 82575 implements the functionality originally defined in the Error Reporting ECN for PCIe Base Specification 1.0a and later incorporated into PCIe Base Specification 1.1.
14	RO	0b	Power Indicator Present In the 82575, this bit is hardwired 0b for all functions.
13	RO	0b	Attention Indicator Present In the 82575, this bit is hardwired 0b for all functions.
12	RO	0b	Attention Button Present In the 82575, this bit is hardwired 0b for all functions.
11:9	RO	110b <sup>1</sup>	Endpoint L1 Acceptable Latency This field indicates the acceptable latency that the 82575 can withstand due to the transition from the L1 state to the L0 state. All functions share the same value loaded from the EEPROM PCIe* Initialization Configuration 1, word 18h.
8:6	RO	011b <sup>1</sup>	Endpoint L0s Acceptable Latency This field indicates the acceptable latency that the 82575 can withstand due to the transition from the L0s state to the L0 state. All functions share the same value loaded from the EEPROM PCIe* Initialization Configuration 1, word 18h.
5	RO	0b	Extended Tag Field Supported This field identifies the maximum Tag field size supported. The 82575 supports a 5-bit Tag field for all functions.
4:3	RO	00b	Phantom Function Supported This is not supported by the 82575.
2:0	RO	001b <sup>1</sup>	Max Payload Size Supported This field indicates the maximum payload that the 82575 can support for TLPs. It is loaded from the EEPROM PCIe* Initialization Configuration 3, word 1Ah bit 8, with a default value of 256Bh.

1. Value loaded from the EEPROM

## Device Control

The Device Control field is 2 bytes at offset A8h and is read/write. This register controls the PCIe\* specific parameters. There is a dedicated register for each function.



Bit(s)	RD/WR	Default	Description
15	RO	0b	Reserved
14:12	RW	010b / 000b	<p>Max Read Request Size</p> <p>This field sets maximum read request size for the 82575 as a requester.</p> <p>000b = 128 bytes. This is the default value for non-LAN functions.</p> <p>001b = 256 bytes.</p> <p>010b = 512 bytes. This is the default value for the LAN devices.</p> <p>011b = 1 KB.</p> <p>100b = 2 KB.</p> <p>101b = Reserved.</p> <p>110b = Reserved.</p> <p>111b = Reserved.</p>
11	RW	1b	<p>Enable No Snoop</p> <p>Snoop is gated by <i>Non Snoop</i> bits in the GCR register in the CSR space.</p>
10	RW	0b	<p>Auxiliary Power PM Enable</p> <p>When set, the 82575 can draw auxiliary power independent of the PME AUX power signal. The 82575 is a multi-function device and is allowed to draw auxiliary power if at least one of the functions has this bit set.</p>
9	RW	0b	<p>Phantom Functions Enable</p> <p>This field is not implemented in the 82575.</p>
8	RW	0b	<p>Extended Tag Field Enable</p> <p>This field is not implemented in the 82575.</p>
7:5	RW	000b (128 Bytes)	<p>Max Payload Size</p> <p>This field sets maximum TLP payload size for the 82575 functions. As a receiver, the 82575 must handle TLPs as large as the set value. As transmitter, the 82575 must not generate TLPs exceeding the set value. The Max Payload Size supported in the 82575 capabilities register indicates permissible values that can be programmed.</p>
4	RW	1b	<p>Enable Relaxed Ordering</p> <p>If this bit is set, the device is permitted to set the Relaxed Ordering bit in the attribute field of write transactions that do not need strong ordering. (Documentation in the RO_DIS bit of the CTRL_EXT register also provides more details.)</p>
3	RW	0b	<p>Unsupported Request Reporting Enable</p> <p>This bit enables error report.</p>
2	RW	0b	<p>Fatal Error Reporting Enable</p> <p>This bit enables error report.</p>
1	RW	0b	<p>Non-Fatal Error Reporting Enable</p> <p>This bit enables error report.</p>
0	RW	0b	<p>Correctable Error Reporting Enable</p> <p>This bit enables error report.</p>

### Device Status

The Device Status field is 2 bytes at offset AAh and is read only. This register provides information about PCIe\* device specific parameters. There is a dedicated register per each function.



Bit(s)	RD/WR	Default	Description
15:6	RO	00h	Reserved
5	RO	0b	Transaction Pending This indicates whether or not the 82575 has any pending transactions. Transactions include completions for any outstanding non-posted request for all used traffic classes.
4	RO	0b	Aux Power Detected If auxiliary power is detected this field is set to 1b. It is a strapping signal from the periphery identical for all functions. This is reset on Internal_Power_On_Reset and GIO Power Good only.
3	RW1C	0b	Unsupported Request Detected This indicates that the 82575 received an unsupported request. This field is identical in all functions. The 82575 cannot distinguish which function caused the error.
2	RW1C	0b	Fatal Error Detected This indicates status of fatal error detection.
1	RW1C	0b	Non-Fatal Error Detected This indicates status of non-fatal error detection.
0	RW1C	0b	Correctable Detected This indicates status of correctable error detection.

### Link CAP

The Link CAP is 4 bytes at offset ACh and is read only. This register identifies the PCIe\* Link specific capabilities. This is a read only register identical to all functions.

Bit(s)	RD/WR	Default	Description
31:24	HwInit	0b	Port Number This represents the PCIe* port number for the given PCIe* Link. The field is set in the link training phase.
23:18	RO	0h	Reserved
17:15	RO	110b (32 – 64 $\mu$ s)	L1 Exit Latency This indicates the exit latency from L1 to L0 state. This field is loaded from the EEPROM PCIe* Initialization Configuration 1, word 18h. Defined encoding: 000b = Less than 1 $\mu$ s 001b = 1 $\mu$ s - 2 $\mu$ s 010b = 2 $\mu$ s - 4 $\mu$ s 011b = 4 $\mu$ s - 8 $\mu$ s 100b = 8 $\mu$ s - 16 $\mu$ s 101b = 16 $\mu$ s - 32 $\mu$ s 110b = 32 $\mu$ s - 64 $\mu$ s 111b = L1 transition not supported



Bit(s)	RD/WR	Default	Description
14:12	RO	001b (64 – 128 ns)	<p>L0s Exit Latency</p> <p>This indicates the exit latency from L0s to L0 state. This field is loaded from the EEPROM PCIe* Initialization Configuration 1, word 18h. There are two values for Common PCIe* clock or Separate PCIe* clock.</p> <p>Defined encoding:</p> <p>000b = Less than 64 ns            001b = 64 ns – 128 ns            010b = 128 ns – 256 ns            011b = 256 ns – 512 ns            100b = 512 ns – 1 µs            101b = 1 µs – 2 µs            110b = 2 µs – 4 µs            111b = Reserved</p> <p>If the 82575 uses common clock, PCIe* Initialization Configuration 1, equals 1B0h/70h, bits [2:0]; and if the 82575 uses separate clock, 1B0h/70h, bits [5:3].</p>
11:10	RO	11b	<p>Active State Link PM Support</p> <p>This indicates the level of active state power management supported in the 82575.</p> <p>Defined encoding:</p> <p>00b = Reserved            01b = L0s Entry Supported            10b = Reserved            11b = L0s and L1 Supported</p> <p>This field is loaded from the EEPROM PCIe* Initialization Configuration 3, word 1Ah.</p>
9:4	RO	4h	<p>Max Link Width</p> <p>This indicates the maximum link width. The 82575 supports by 1-, by 2- and by 4-link width. The field is loaded from the EEPROM PCIe* Initialization Configuration 3, word 1Ah, with a default value of 4 lanes for the 82575.</p> <p>Defined encoding:</p> <p>000000b = Reserved            000001b = x1            000010b = x2            000100b = x4</p>
3:0	RO	0001b	<p>Max Link Speed</p> <p>The 82575 indicates a maximum link speed of 2.5 Gb/s.</p>

### Link Control

The Link Control field is 2 bytes at offset B0h and is read only. This register controls PCIe\* link specific parameters. There is a dedicated register for each function.



Bit(s)	RD/WR	Default	Description
15:8	RO	0h	Reserved
7	RW	0b	Extended Synchronization This bit forces extended transmit of the FTS ordered set in FTS and extra TS1 at exit from L0s prior to entering L0.
6	RW	0b	Common Clock Configuration When this is set, it indicates that the 82575 and the component at the other end of the link are operating with a common reference clock. A value of 0b indicates that they are operating with an asynchronous clock. This parameter affects the L0s exit latencies.
5	RO	0b	Retrain Clock This is not applicable for endpoint devices and is hardwired to 0b.
4	RO	0b	Link Disable This field is not applicable for endpoint devices and is hardwired to 0b.
3	RW	0b	Read Completion Boundary.
2	RO	0b	Reserved
1:0	RW	00b	Active State Link PM Control This field controls the active state power management supported on the link. Link PM functionality is determined by the lowest common denominator of all functions.  Defined encoding: 00b = PM disabled 01b = L0s entry supported 10b = Reserved 11b = L0s and L1 supported

### Link Status

The Link Status field is 2 bytes at offset B2h and is read only. This register provides information about PCIe\* link specific parameters. This is a read only register identical to all functions.

Bit(s)	RD/WR	Default	Description
15:13	RO	0000b	Reserved
12	HwInit	1b	Slot Clock Configuration When this is set, it indicates that the 82575 uses the physical reference clock that the platform provides on the connector. This bit must be cleared if the 82575 uses an independent clock. The Slot Clock Configuration bit is loaded from the Slot_Clock_Cfg EEPROM bit.
11	RO	0b	Link Training This indicates that link training is in progress.



Bit(s)	RD/WR	Default	Description
10	RO	0b	Link Training Error This indicates that a link training error has occurred.
9:4	RO	000001b	Negotiated Link Width This field indicates the negotiated width of the link. Relevant encoding: 000001b = x1 000010b = x2 000100b = x4
3:0	RO	0001b	Link Speed This field indicates the negotiated link speed. A value of 0001b is the only defined speed, which is 2.5 Gb/s.

### Reserved

Reserved. 2 bytes at offset B4h and is read only. Un-implemented reserved registers not relevant to PCIe\* endpoint.

The following two registers are implemented only if the capability version is 2.

### Device CAP 2

Device Capability 2 is 4 bytes at offset C4h. This register identifies PCIe\* device specific capabilities. It is a read only register with the same value for the two LAN functions.



Bit(s)	RD/WR	Default	Description
15:5	RO	0h	Reserved
4	RO	1b	Completion Timeout Disable Supported A value of 1b indicates support for the Completion Timeout Disable mechanism.
3:0	RO	1111b	Completion Timeout Ranges Supported This field indicates 82575 support for the optional Completion Timeout programmability mechanism. This mechanism enables system software to modify the Completion Timeout value. Four time value ranges are defined: Range A: 50 $\mu$ s to 10 ms Range B: 10 ms to 250 ms Range C: 250 ms to 4 s Range D: 4 s to 64 s Bits are set as follows to show the timeout value ranges supported. 0000b = Completion Timeout programming not supported - the 82575 must implement a timeout value in the range 50 $\mu$ s to 50 ms. 0001b = Range A 0010b = Range B 0011b = Ranges A & B 0110b = Ranges B & C 0111b = Ranges A, B & C 1110b = Ranges B, C & D 1111b = Ranges A, B, C & D All other values are reserved. It is strongly recommended that the Completion Timeout mechanism not expire in less than 10 ms.

## Device Control 2

Device Control 2 is 2 bytes at offset C8h. This register controls PCIe\* specific parameters. It has the same value for the two LAN functions.



Bit(s)	RD/WR	Default	Description
15:5	RO	0h	Reserved
4	RW	0b	<p>Completion Timeout Disable</p> <p>When set to 1b, this bit disables the Completion Timeout mechanism.</p> <p>Software is permitted to set or clear this bit at any time. When set, the Completion Timeout detection mechanism is disabled. If there are outstanding requests when the bit is cleared, it is permitted but not required for hardware to apply the completion timeout mechanism to the outstanding requests. If this is done, it is permitted to base the start time for each request on either the time this bit was cleared or the time each request was issued.</p> <p>The default value for this bit is 0b.</p>
3:0	RO	0000b	<p>Completion Timeout Value</p> <p>In 82575s that support Completion Timeout programmability, this field enables system software to modify the Completion Timeout value.</p> <p>Defined encodings:</p> <p>0000b = Default range: 50 <math>\mu</math>s to 50 ms</p> <p>It is strongly recommended that the Completion Timeout mechanism not expire in less than 10 ms.</p> <p>Values available if Range A (50 <math>\mu</math>s to 10 ms) programmability range is supported:</p> <p>0001b = 50 <math>\mu</math>s to 100 <math>\mu</math>s            0010b = 1 ms to 10 ms</p> <p>Values available if Range B (10 ms to 250 ms) programmability range is supported:</p> <p>0101b = 16 ms to 55 ms            0110b = 65 ms to 210 ms</p> <p>Values available if Range C (250 ms to 4 s) programmability range is supported:</p> <p>1001b = 260 ms to 900 ms            1010b = 1 s to 3.5 s</p> <p>Values available if the Range D (4 s to 64 s) programmability range is supported:</p> <p>1101b = 4 s to 13 s            1110b = 17 s to 64 s</p> <p>Values not defined above are reserved.</p> <p>Software is permitted to change the value in this field at any time. For requests already pending when the Completion Timeout Value is changed, hardware is permitted to use either the new or the old value for the outstanding requests and is permitted to base the start time for each request either on when this value was changed or on when each request was issued.</p> <p>The default value for this field is 0000b.</p>

### 6.6.5.3.1 PCIe\* Extended Configuration Space

PCIe\* Configuration Space is located in a flat memory mapped address space. PCIe\* extends the configuration space beyond the 256 bytes available for PCI to 4096 bytes. The 82575 decodes additional 4-bits (bits 27:24) to provide the additional configuration (see the figure that follows). PCIe\* reserves the remaining 4 bits (bits 31:28) for future expansion of the configuration space beyond 4096 bytes.

The configuration address for a PCIe\* device is computed using PCI-compatible bus, device and function numbers as follows:

Bits 31:28	Bits 27:20	Bits 19:15	Bits 14:12	Bits 11:2	Bits 1:0
0000b	Bus #	Device #	Func #	Register Address (offset)	00b





PCIe\* Extended Configuration Space is allocated using a linked list of optional or required PCIe\* extended capabilities following a format resembling PCI capability structures. The first PCIe\* extended capability is located at offset 100h in the device configuration space. The first Dword of the capability structure identifies the capability and version and points to the next capability.

The 82575 supports Advanced Error Reporting Capability at offset 100h and Serial Number at offset 140h of the PCIe\* extended capabilities.

### 6.6.5.3.2 Advanced Error Reporting Capability

The PCIe\* advanced error reporting capability is an optional extended capability to support advanced error reporting. This is supported by the 82575. Details and definitions of the extended capabilities structures and advanced error reporting capabilities are documented in the PCIe\* Specification.

### 6.6.5.3.3 Device Serial Number

The 82575 implements the PCIe\* Device Serial Number optional capability. The Device Serial Number is a read only 64-bit value that is unique for a given PCIe\* device.

Both functions return the same Device Serial Number value.

**Table 73. PCIe\* Device Serial Number Capability Structure**

Offset 140h	PCIe* Enhanced Capability Header
Offset 144h	Serial Number Register (Lower Dword)
Offset 148h	Serial Number Register (Upper Dword)

#### Device Serial Number Enhanced Capability Header (Offset 140h)

The following tables detail allocation of register fields as well as their respective bit definitions in the Device Serial Number enhanced capability header. The Extended Capability ID for the Device Serial Number capability is 0003h.

**Table 74. Device Serial Number Enhanced Capability Header**

Bits 31:20	Next Capability Offset
Bits 19:16	Capability Version
Bits 15:0	PCIe* Extended Capability ID

**Table 75. Device Serial Number Enhanced Capability Header**

Bit(s)	Attributes	Description
31:20	RO	Next Capability Offset This field contains the offset to the next PCIe* capability structure or 000h if no other items exist in the linked list of capabilities. For extended capabilities implemented in device configuration space, this offset is relative to the beginning of the PCI compatible configuration space and must always equal either 000h (to terminate the list of capabilities) or be greater than 0FFh.
19:16	RO	Capability Version This field is a PCI SIG defined version number that indicates the version of the capability structure present. It must equal 1h for this version of the specification.
15:0	RO	PCIe* Extended Capability ID This field is a PCI SIG defined identification number indicating indicates the nature and format of the extended capability. The Extended Capability ID for the Device Serial Number Capability is 0003h.



Serial Number Register (Offset 148h:144h)

The Serial Number register is a 64-bit field that contains the IEEE defined 64-bit extended unique identifier (EUI-64\*). The following tables detail the allocation of register fields as well as their respective bit definitions in the Serial Number register.

**Table 76. Device Serial Number Enhanced Capability Header**

Bits 63:32	Serial Number Register (Upper Dword)
Bits 31:0	Serial Number Register (Lower Dword)

**Table 77. Serial Number Register**

Bit(s)	Attributes	Description
63:0	RO	PCIe* Device Serial Number This field contains the IEEE defined 64-bit extended unique identifier (EUI-64*). This identifier includes a 24-bit company identification value assigned by IEEE registration authority and a 40-bit extension identifier assigned by the manufacturer.

Serial Number Definition in the 82575

In the 82575, the serial number uses the MAC address according to the following definition.

Field	Company ID			Extension identifier				
Order	Addr+0	Addr+1	Addr+2	Addr+3	Addr+4	Addr+5	Addr+6	Addr+7
	Most Significant Byte						Least Significant Byte	
	Most Significant Bit						Least Significant Bit	

The serial number can be constructed from the 48-bit MAC address in the following form:

Field	Company ID			MAC Label		Extension identifier		
Order	Addr+0	Addr+1	Addr+2	Addr+3	Addr+4	Addr+5	Addr+6	Addr+7
	Most Significant Bytes					Least Significant Byte		
	Most Significant Bit					Least Significant Bit		

The MAC label in this case is FFFFh. For example, the vendor is Intel and the vendor ID is 00-A0-C9, and the extension identifier, 23-45-67. In this case, the 64-bit serial number is:

Field	Company ID			MAC Label		Extension identifier		
Order	Addr+0	Addr+1	Addr+2	Addr+3	Addr+4	Addr+5	Addr+6	Addr+7
	00	A0	C9	FF	FF	23	45	67
	Most Significant Byte					Least Significant Byte		
	Most Significant Bit					Least Significant Bit		

The MAC address is the function 0 MAC address as loaded from EEPROM into the RAL and RAH registers.

The translation from EEPROM words 0h to 2h to the serial number is as follows:

- Serial number ADDR + 0, 1 = EEPROM word 0

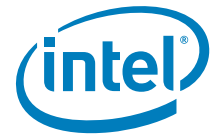

- Serial number ADDR + 2, 5 = EEPROM word 1
- Serial number ADDR + 3, 4 = FF FF
- Serial number ADDR + 6, 7 = EEPROM word 2

The official document defining EUI-64 can be located at: <http://standards.ieee.org/regauth/oui/tutorials/EUI64.html>.

§ §

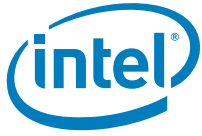

**NOTE:**      *This page intentionally left blank.*



## 7.0 Power Management

---

The 82575 supports the Advanced Configuration and Power Interface (ACPI) Specification as well as Advanced Power Management (APM). This section describes how power management is implemented in 82575.

Implementation requirements were obtained from the following documents:

- PCI Bus Power Management Interface Specification - Revision 1.1
- PCI Express\* Base Specification - Revision 1.0a
- ACPI Specification - Revision 2.0
- PCI Express\* Card Electromechanical Specification - Revision 1.0
- Mobile PCIe\* Communications Specification - Revision 0.80KD

**Note:** Power management can be disabled through bits in the Initialization Control Word, which is loaded from the EEPROM during power-up reset. Even when disabled, the power management register set is still present. Power management support is required by the PCIe\* Specification.

The following assumptions apply to the implementation of power management for the 82575:

- The driver sets the filters up prior to the system transitioning the 82575 to the D3 state.
- Before a transition from D0 to the D3 state, the operating system ensures the device driver has been disabled.
- No wake-up capability, except APM wakeup if it is enabled in the EEPROM, is required after the system puts the 82575 into the D3 state and then returns it to D0.
- If the APMPME bit in the Wake Up Control Register (WUC.APMPME) is 1b, it is permissible to assert GIO\_WAKE\_N even when PME\_En is 0b.

The 82575 power is delivered through external voltage regulators. Refer to the *82575 Design Guide* for external power delivery system requirements.

### 7.1 Power States

The 82575 supports D0 and D3 power states defined in the PCI Power Management and PCIe\* Specifications. D0 is divided into two sub-states: D0u and D0a. In addition, it supports a Dr state that is entered when the power good signal is de-asserted (including the D3cold state).

Figure 23 shows the power states and transitions between them.

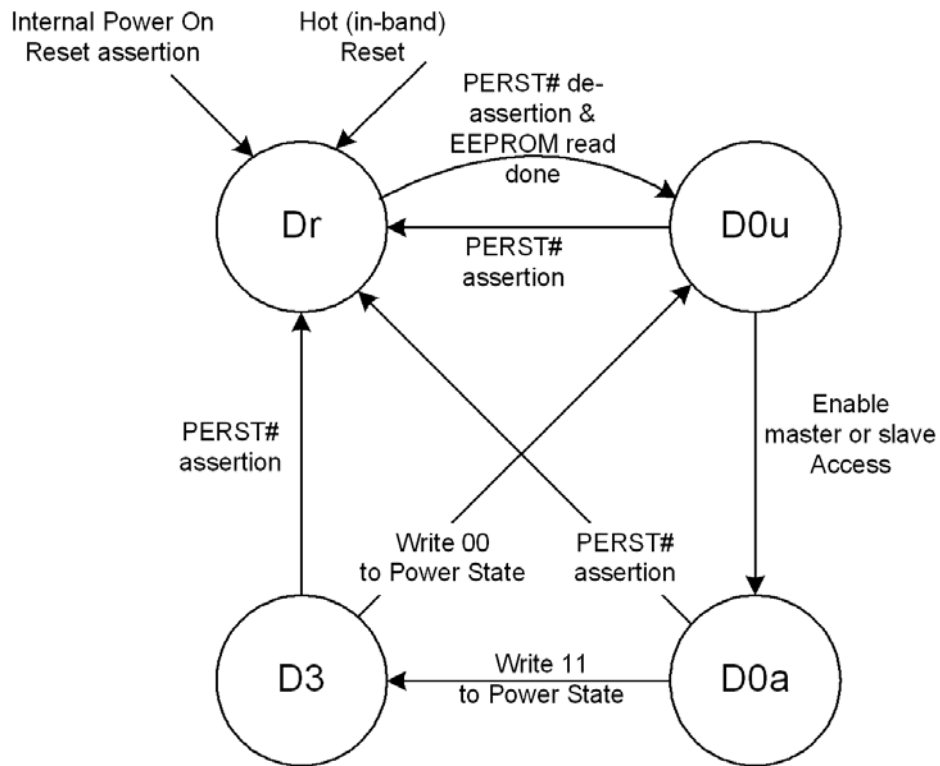

Figure 23. Power States and Transitions

## 7.2 Auxiliary Power

If DisabledD3Cold equals 0b, the 82575 uses the AUX\_PWR indication that auxiliary power is available. As a result, the 82575 advertises D3<sub>cold</sub> wakeup support. The amount of power required for the function (this includes the entire NIC or LOM) is advertised in the Power Management Data Register, which is loaded from the EEPROM.

If D3cold is supported, the PME\_En and PME\_Status bits of the Power Management Control/Status Register (PMCSR) and their shadow bits in the Wake Up Control Register (WUC) are reset only by the power up reset (detection of power rising).

The only effect of setting AUX\_PWR to 1b is advertising D3<sub>cold</sub> wakeup support and changing the reset function of PME\_En and PME\_Status. AUX\_PWR is a strapping option in the 82575.

## 7.3 Form Factor Power Limits

The following table summarizes power limitations introduced by some of the different form factors.



	Form Factor	
	LOM	PCIe* NIC
Main	N/A	3A @ 3.3v
Auxiliary (aux enabled)	375 mA @ 3.3V	375 mA @ 3.3v
Auxiliary (aux disabled)	20 mA @ 3.3V	20 mA @ 3.3v

**Note:** This auxiliary current limit only applies when the primary 3.3V voltage source is not available. For example, the NIC is in a low power D3 state.

The 82575 exceeds allocated auxiliary power in some configurations (for example, both ports running at gigabit speed). as a result, the 82575 must be configured such that it meets the previously stated requirements. To do so, the 82575 implements two EEPROM bits to disable operation in certain cases:

1. The *Disable 1000* PHY CSR bit disables 1000 Mb/s operation under all conditions.
2. The *Disable 1000 in non-D0a* PHY CSR bit disables 1000 Mb/s operation in non-D0a states. If *Disable 1000 in non-D0a* is set, and the 82575 is at gigabit speed on entry to a non-D0a state, then it removes advertisement for 1000 and auto-negotiates.

The 82575 restarts link Auto-Negotiation each time it transitions from a state where gigabit speed is enabled to a state where gigabit speed is disabled or vice versa. For example, if *Disable 1000 Mb/s in non-D0a* is set but *Disable 1000 Mb/s* is clear, the 82575 restarts link Auto-Negotiation on transition from the D0 state to D3 or Dr states.

## 7.4 Power Management Interconnects

This section describes the power reduction techniques employed by 82575 main interconnects.

### 7.4.0.1 PCIe\* Link Power Management

The PCIe\* link state follows the power management state of the 82575. Since the 82575 incorporates multiple PCI functions, the device power management state is defined as the power management state of the most awake function:

- If any function is in D0 state (either D0a or D0u), the PCIe\* link assumes the 82575 is in D0 state. Else,
- If the functions are in D3 state, the PCIe\* link assumes the 82575 is in D3 state. Else,
- The 82575 is in Dr state (PE\_RST\_N is asserted to all functions).

The 82575 supports all PCIe\* power management link states:

- L0 state is used in D0u and D0a states.
- The L0s state is used in D0a and D0u states each time link conditions apply.
- The L1 state is also used in D0a and D0u states when idle conditions apply for a longer period of time. The L1 state is also used in the D3 state.
- The L2 state is used in the Dr state following a transition from a D3 state if PCI-PM PME is enabled.
- The L3 state is used in the Dr state when no auxiliary power is provided to the 82575.



82575 support for Active State Link Power Management is reported via the PCIe\* Active State Link PM Support register loaded from the EEPROM.

While in L0 state, the 82575 transitions the transmit lane(s) into L0s state once the idle conditions are met for a period of time as shown in [Figure 24](#).

L0s configuration fields are:

- L0s enable - The default value of the Active State Link PM Control field in the PCIe\* Link Control register is set to 00b (both L0s and L1 disabled). System software can later write a different value into the Link Control register. The default value is loaded on any reset of the PCI configuration registers.
- The L0S\_ENTRY\_LAT bit in the PCIe\* Control register (GCR), determines L0s entry latency. When set to 0b, L0s entry latency is the same as L0s Exit latency of the 82575 at the other end of the link. When set to 1b, L0s entry latency is (L0s Exit Latency of the 82575 at the other end of the link /4). Default value is 0b (entry latency is the same as L0s Exit latency of the 82575 at the other end of the link).
- L0s exit latency (as published in the *L0s Exit Latency* field of the Link Capabilities register) is loaded from EEPROM. Separate values are loaded when the 82575 shares the same reference PCIe\* clock with its partner across the link and when the 82575 uses a different reference clock than its partner across the link. The 82575 reports whether it uses the slot clock configuration through the PCIe\* *Slot Clock Configuration* bit loaded from the Slot\_Clock\_Cfg EEPROM bit.
- L0s Acceptable Latency (as published in the *Endpoint L0s Acceptable Latency* field of the Device Capabilities register) is loaded from EEPROM.

L1 configuration fields are:

- L1 entry latency - the 82575 enters the L1 state after it has been in the L0s state (in both directions) for a period of time determined by the Latency\_To\_Enter\_L1 CSR register. Initial value is loaded from the Latency\_To\_Enter\_L1 EEPROM field.
- L1 exit latency (as published in the *L1 Exit Latency* field of the Link Capabilities register) is loaded from the L1\_Act\_Ext\_Latency Latency\_To\_Enter\_L1 field in the EEPROM.
- L1 Acceptable Latency (as published in the *Endpoint L1 Acceptable Latency* field of the Device Capabilities register) is loaded from EEPROM.



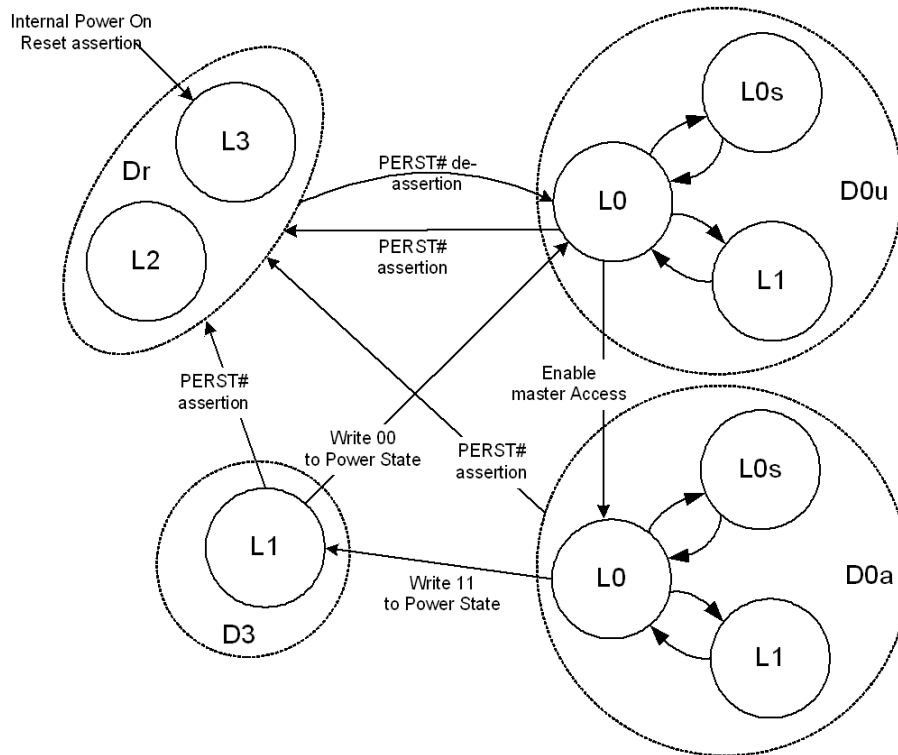

Figure 24. Link Power Management

### 7.4.0.2 NC-SI Clock Control

The 82575 can be configured to provide a 50 MHz output clock to its NC-SI interface and other platform devices. When enabled (through the *NC-SI Output Clock* EEPROM bit), the NC-SI clock is provided in all power states without exception.

### 7.4.0.3 PHY Power Management

#### 7.4.0.3.1 Link Speed Control

Normal PHY speed negotiation drives to establish a link at the highest possible speed. The 82575 supports an additional mode of operation where the PHY drives to establish a link at a low speed. The link-up process allows a link to come up at the lowest possible speed in cases where power is more important than performance. Different behavior is defined for the D0 state and the other non-D0 states.

**Note:** The Low Power Link Up (LPLU) feature just described should be disabled (in both D0a and non-D0a states) when the user advertisement is anything other than 10/100/1000 Mb/s.



This avoids negotiating through the LPLU procedure a link speed that is not advertised by the user.

The following table lists the link speed as a function of a power management state, link speed control, and gigabit speed enabling:

Power Management State	Low Power Link Up	1000 Mb/s Disable Bits		PHY Speed Negotiation
		Disable 1000	Disable 1000 in Non-D0a	
D0a	0	0	X	The PHY negotiates to the highest speed advertised (normal operation).
		1		The PHY negotiates to highest speed advertised except 1000 Mb/s.
	1	0	X	The PHY goes through the LPLU procedure, starting with the advertised values.
		1		The PHY goes through the LPLU procedure, starting with advertised values but does not advertise 1000 Mb/s.
Non-D0a	0	0	0	The PHY negotiates to highest speed advertised.
		0	1	The PHY negotiates to highest speed advertised except 1000 Mb/s.
		1	X	
	1	0	0	The PHY goes through the LPLU procedure, starting at 10 Mb/s.
		0	1	The PHY goes through LPLU procedure, starting at 10 Mb/s but does not advertise 1000 Mb/s.

The 82575 initiates auto-negotiation without a direct driver command in the following cases:

- When the state of 1000 Mb/s disable changes. For example, if 1000 Mb/s is disabled on D3 or Dr entry (but not in D0a), the PHY auto negotiates on entry.
- When LPLU changes state with a change in PM state. For example, on transition from D0a without LPLU to D3 with LPLU. Or, on transition from D3 w LPLU to D0 without LPLU.
- On a transition from D0a state to a non-D0a state, or from a non-D0a state to D0a state, and LPLU is set.

#### 7.4.0.3.2 D0a State

A power managed link speed control lowers link speed (and power) when the highest link performance is not required. When it is enabled to this D0 Low Power Link Up mode, any link negotiation tries to establish a low link speed, starting with an initial advertisement defined by software.

The D0 LPLU configuration bit enables D0 Low Power Link Up. Before enabling the feature, software must advertise one of the following speed combinations: 10 Mb/s only, 10/100 Mb/s, or 10/100/1000 Mb/s.

When speed negotiation starts, the PHY tries to negotiate a speed based on the currently advertised values. If link establishment fails, the PHY tries to negotiate with different speeds; it enables all speeds up to the lowest speed supported by the partner. For example, the 82575 advertises 10 Mb only and the partner supports 1000 Mb only. After the first try fails, the 82575 enables 10/100/1000 Mb/s and try again. The PHY continues to try and establish a link until it succeeds or until it is instructed otherwise. In the second step (adjusting to partner speed), the PHY also enables parallel detect, if needed. Automatic MDI/MDI-X resolution is done during the first auto-negotiation stage.



#### 7.4.0.3.3 Non-D0a State

The PHY can negotiate to a low speed while in a non-D0a states (Dr, D0u, or D3). This applies only when the link is required by SMB manageability, APM wake up, or a power management event. Otherwise, the PHY is disabled during the non-D0 state.

The EEPROM *LPLU* bit enables reduction in link speed:

- On power-up entry to Dr state, the PHY advertises support for 10 Mb/s only and goes through the link up process.
- On any entry to a non-D0a state (Dr, D0u, or D3), the PHY advertises support for 10 Mb/s only and goes through the link up process described as follows.
- While in a non-D0 state, if auto-negotiation is required, the PHY advertises support for 10 Mb/s only and goes through the link up process.

The EEPROM *LPLU* bit is loaded into the *LPLU* configuration bit. Software can set or clear this bit at any time. From that point on, the 82575 acts according to the latest value of the *LPLU* bit.

Link negotiation begins with the PHY trying to negotiate at 10 Mb/s speed only regardless of user AN advertisement. If link establishment fails, the PHY tries to negotiate at additional speeds; it enables all speeds up to the lowest speed supported by the partner. For example, the 82575 advertises 10 Mb only and the partner supports 1000 Mb only. After the first try fails, the 82575 enables 10/100/1000 Mb/s and try again. The PHY continues to try and establish a link until it succeeds or until it is instructed otherwise. In the second step (adjusting to partner speed), the PHY also enables parallel detect, if needed. Automatic MDI/MDI-X resolution is done during the first auto-negotiation stage.

#### 7.4.0.3.4 Link Energy Detect

The Link Energy Detect MDIO bit is set each time energy is detected on the link. This includes the period of time during link negotiation and when link is established. This bit should be valid immediately after a reset of the device or the PHY.

#### 7.4.0.3.5 PHY Power-Down State

Each of the 82575 PHYs enter a power-down state when none of its clients is enabled and therefore, no need to maintain a link. This can happen in one of several cases as follows:

- PHY power down is enabled through the EEPROM *PHY Power Down Enable* bit.
- D3/Dr state - each PHY enters a low-power state if the following conditions are met:
  - The LAN function associated with this PHY is in a non-D0 state.
  - APM Wake on LAN\* (WOL) is inactive.
  - Manageability does not use this port.
  - ACPI PME is disabled for this port.
- SerDes mode - each PHY is disabled when its LAN function is configured in SerDes mode.
- LAN Disable - Each PHY can be disabled if its LAN function's LAN Disable input indicates that the relevant function should be disabled. Since the PHY is shared between the LAN function and manageability, it might not be desired to power down the PHY in LAN Disable. The *PHY\_in\_LAN\_Disable* EEPROM bit determines whether the PHY (and MAC) are powered down when the LAN Disable pin is asserted. The default is not to power down.

A LAN port can also be disabled through EEPROM settings. If the *LAN\_DIS* EEPROM bit is set, the PHY enters power down. Note, however, that setting the EEPROM *LAN\_PCI\_DIS* bit does not bring the PHY into power down.



#### 7.4.0.3.6 SerDes/SGMII Power-Down State

Each of the 82575's SerDes enters a power-down state when none of its clients are enabled. This case does not require a link to be maintained. The following conditions must be met for the SerDes to enter this power-down state:

- SerDes power down must be enabled through the EEPROM *SerDes Low Power Enable* bit
- D3/Dr state - each SerDes enters a low-power state if the following conditions are met:
  - The LAN function associated with this SerDes is in a non-D0 state.
  - APM Wake on LAN\* (WOL) is inactive.
  - Pass through manageability is disabled.
  - ACPI PME is disabled.
- PHY mode - each SerDes is disabled when its LAN function is configured in PHY mode.
- LAN Disable - Each SerDes can be disabled if its LAN function's LAN Disable input indicates that the relevant function should be disabled. Since the SerDes is shared between the LAN function and manageability, it might not be desired to power down the SerDes in LAN Disable. The *PHY\_in\_LAN\_Disable* EEPROM bit determines whether the SerDes are powered down when the LAN Disable pin is asserted. The default is not to power down.

### 7.4.1 Power States

#### 7.4.1.1 Dr State

Transition to Dr state is initiated as follows:

- On system power up. The Dr state starts with the assertion of the internal power detection circuit (Internal\_Power\_On\_Reset) and ends with de-asserting PE\_RST\_N.
- On transition from a D0a state. During operation, the system might assert PE\_RST\_N at any time. In an ACPI system, a system transition to the G2/S5 state causes a transition from D0a to Dr.
- On transition from a D3 state. The system transitions the 82575 into the Dr state by asserting PE\_RST\_N.

Any wake-up filter settings that were enabled before entering this reset state are maintained.

The system might maintain PE\_RST\_N assertion for an arbitrary time. The de-assertion (rising edge) PE\_RST\_N causes a transition to the D0u state.

While in Dr state, the 82575 might enter one of several modes with different levels of functionality and power consumption. The lower-power modes are achieved when the 82575 is not required to maintain any functionality. The Dr Disable mode is described in "Entry to Dr State".

**Note:** If the 82575 is configured to provide a 50 MHz NC-SI clock (via the *NC-SI Output Clock* EEPROM bit), then the NC-SI clock must be provided in Dr state as well.

##### 7.4.1.1.1 Dr Disable Mode

The 82575 enters a Dr Disable mode on transition to D3cold state when it does not need to maintain any functionality. The conditions to enter either state are:

- The 82575 (all PCI functions) is in Dr state
- APM WOL is inactive for both LAN functions



- Pass through manageability is disabled
- ACPI PME is disabled for all PCI functions
- The 82575 *Disable Power Down En* EEPROM bit is set (default hardware value is disabled).

Entry into Dr Disable is usually done after asserting PE\_RST\_N. It can also be possible to enter Dr Disable mode by reading the EEPROM while already in Dr state. The usage model for this later case is at system power up, assuming that manageability and wake up are not required. Once the 82575 enters Dr state on power-up, the EEPROM is read. If the EEPROM contents determines that the conditions to enter Dr Disable are met, the 82575 then enters this mode (assuming that PE\_RST\_N is still asserted).

Exiting from Dr Disable is by de-asserting PE\_RST\_N.

#### 7.4.1.1.2 Entry to Dr State

Dr entry on platform power up starts with the assertion of the internal power detection circuit (Internal\_Power\_On\_Reset). The EEPROM is read and determines the 82575 configuration. If the *APM Enable bit* in the EEPROM Initialization Control Word 2 is set, then APM wake up is enabled. The MAC and PHY state is determined by the manageability state and APM wake. To reduce power consumption, if APM Wake is enabled, the PHY auto-negotiates to a lower link speed on Dr entry. The PCIe\* link is not enabled in Dr state following system power up (since PE\_RST\_N is asserted).

Entry to Dr state from D0a state is by asserting PE\_RST\_N. An ACPI transition to the G2/S5 state is reflected in an 82575 transition from D0a to Dr state. The transition can be orderly (programmer selects the shut down option), in which case the software device driver can have a chance to intervene. Or, it might be an emergency transition (power button override), in which case, the software device driver is not notified.

To reduce power consumption if any manageability, APM wake or PCI PM PME is enabled, the PHY auto-negotiates to a lower link speed on D0a to Dr transition.

Transition from D3 state to Dr state is done by asserting PE\_RST\_N. Prior to that, the system initiates a transition of the PCIe\* link from L1 state to either the L2 or L3 state (assuming all functions were already in D3 state). The link enters L2 state if PCI-PM PME is enabled.

#### 7.4.1.2 D0 Uninitialized State

The D0u state is a low-power state used after PE\_RST\_N is de-asserted following power-up (cold or warm), on hot reset (in-band reset through PCIe\* physical layer message) or on D3 exit.

When entering D0u, the 82575 disables wake ups and asserts a reset to the PHY while the EEPROM is being read. If the APM mode bit in the EEPROM Initialization Control Word 2 is set, then APM wake up is enabled.

##### 7.4.1.2.1 Entry to D0u State

D0u is reached from either the Dr state (de-asserting PE\_RST\_N) or the D3hot state (by configuration software writing a value of 00b to the *Power State* field of the PCI PM registers).

De-asserting PE\_RST\_N means that the entire state of the 82575 is cleared except for the sticky bits. The state is loaded from the EEPROM. Afterwards, the PCIe\* link is established. When this completes, the configuration software can access the 82575.



On a transition from D3 to D0u, the 82575 PCI Configuration space is not reset. However, the 82575 requires that software perform a full re-initialization of the function including its PCI Configuration Space.

### 7.4.1.3 D0 Active State

Once memory space is enabled, the 82575 enters an active state. It can transmit and receive packets if properly configured by the driver. The PHY is enabled or re-enabled by the 82575 driver to operate/auto-negotiate to full line speed/power if not already operating at full capability. Any APM Wakeup previously active remains active. The driver can deactivate APM Wakeup by writing to the Wake Up Control Register (WUC) or activate other Wake Up Filters by writing to the Wake Up Filter Control Register (WUFC).

#### 7.4.1.3.1 Entry to D0a State

D0a is entered from the D0u state by writing a 1b to the *Memory Access Enable* or the *I/O Access Enable* bit of the PCI Command Register. The DMA, MAC, and PHY of the appropriate LAN function are enabled.

### 7.4.1.4 D3 State

The D3 state referred to in this section is PCI PM D3hot.

The 82575 transitions to D3 when the system writes a 11b to the *PowerState* field of the Power Management Control/Status register (PMCSR). Any WakeUp filter settings that were enabled before entering this reset state are maintained. Upon transitioning to D3 state, the 82575 clears the *Memory Access Enable* and *I/O Access Enable* bits of the PCI Command Register, which disables memory access decode. In D3, the 82575 only responds to PCI configuration accesses and does not generate master cycles.

Configuration and Message requests are the only TLPs accepted by a function in the D3hot state. All other received Requests must be handled as Unsupported Requests and all received Completions can optionally be handled as Unexpected Completions. If an error caused by a received TLP (for example, an Unsupported Request) is detected while in D3hot, and reporting is enabled, the link must be returned to L0 if it is not already in L0 and an error message must be sent.

A D3 state is followed by either a D0u state (in preparation for a D0a state) or by a transition to Dr state (PCI PM D3cold state). To transition back to D0u, the system writes 00b to the Power State field of the PMCSR. Transition to the Dr state is by asserting PE\_RST\_N.

#### 7.4.1.4.1 Entry to D3 State

Transition to D3 state is through a configuration write to the Power State field of the PCI PM registers.

Prior to transition from D0 to the D3 state, the software device driver disables scheduling of further tasks to the 82575. It masks all interrupts and does not write to the transmit descriptor tail register or to the receive descriptor tail register and operates the master disable algorithm. If wake up capability is needed, the software device driver should set up the appropriate wake up registers and the system should write a 1b to the PME\_En bit of the PMCSR or to the Auxiliary Power PM Enable bit of the PCIe\* Device Control Register before the transition to D3.



As a response to being programmed into the D3 state, the 82575 brings its PCIe\* link into the L1 link state. As part of the transition into the L1 state, the 82575 suspends scheduling of new TLPs and waits for the completion of all previous TLPs it has sent. The 82575 clears the Memory Access Enable and I/O Access Enable bits of the PCI Command Register, which disables memory access decode. Any receive packets that have not been transferred into system memory is kept in the 82575 and discarded later on D3 exit. Any transmit packets that have not been sent can still be transmitted, assuming the Ethernet link is valid.

To reduce power consumption, if APM wake or PCI PM PME is enabled, the PHY auto-negotiates to a lower link speed on D3 entry.

#### 7.4.1.4.2 Master Disable

System software can disable master accesses on the PCIe\* link by either clearing the PCI Bus Master bit or by bringing the function into a D3 state. From this point on, the 82575 must not issue master accesses for this function. Due to the full duplex nature of PCIe\* and the pipelined design in the 82575, multiple requests from several functions might be pending when the master disable request arrives. The protocol described in this section ensures that a function does not issue master requests to the PCIe\* link after its master enable bit is cleared or after entry to D3 state.

Two configuration bits are provided for the handshake between the 82575 function and its driver:

- *GIO Master Disable* bit in the Device Control Register (CTRL). When the *GIO Master Disable* bit is set, the 82575 blocks new master requests, including manageability requests, by this function. The 82575 then proceeds to issue any pending requests by this function. This bit is cleared on master reset (Internal\_Power\_On\_Reset all the way to Software Reset) to allow master accesses.
- *GIO Master Enable Status* bits in the Device Status Register. These bits are cleared by the 82575 when the *GIO Master Disable* bit is set and no master requests are pending by the relevant function. Otherwise, these bits are set. This indicates that no master requests is issued by this function as long as the *GIO Master Disable* bit is set. The following activities must end before the 82575 clears the *GIO Master Enable Status* bit.
  - Master requests by the transmit and receive engines
  - Master requests by the manageability agents
  - Reception of firmware indication that the interface to this function is Idle
  - All pending completions to the 82575 are received

**Note:** The software device driver sets the *GIO Master Disable* bit when notified of a pending master disable (or D3 entry). The 82575 then blocks new requests and proceeds to issue any pending requests by this function. The driver then polls the *GIO Master Enable Status* bit. Once the bit is cleared, it is guaranteed that no requests are pending from this function. The driver might time-out if the *GIO Master Enable Status* bit is not cleared within a given time.

The *GIO Master Disable* bit must be cleared to enable a master request to the PCIe\* link. This can be done either through reset or by the software device driver.

#### 7.4.1.5 Link-Disconnect

In any of D0u, D0a, D3, or Dr, the 82575 enters a link-disconnect state if it detects a link-disconnect condition on the Ethernet Link. Note that the link-disconnect state is invisible to software (other than the *Link Energy Detect* bit state). In particular, while in D0 state, software might be able to access any of the device registers as in a link-connect state.





## 7.4.2 Power-State Transitions Timing

The following sections give detailed timing for the state transitions. The timing diagrams are not to scale, and the dotted connecting lines represent the 82575 requirements, and the solid connecting lines, 82575 guarantees. The clocks edges are shown to indicate running clocks only. They are not used to indicate the actual number of cycles for any operation.

### 7.4.2.1 Power Up (Off to Dup to D0u to D0a)

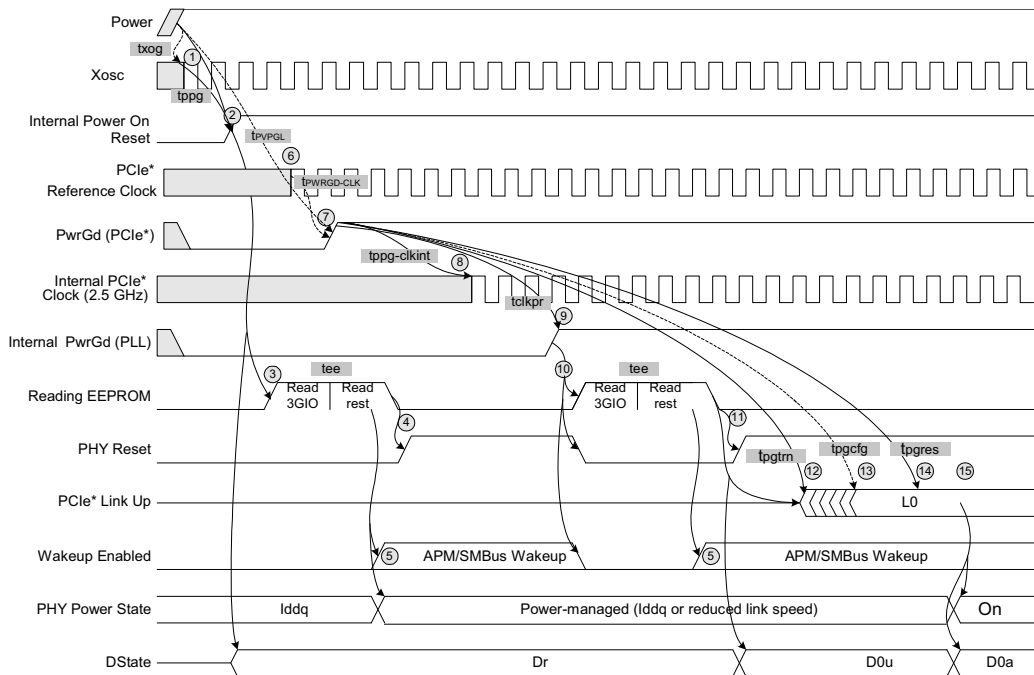

Notes	
1	Xosc is stable $t_{xog}$ after the power is stable.
2	Internal_Power_On_Reset is asserted after all power supplies are good and $t_{ppg}$ , after Xosc, is stable.
3	An EEPROM read starts on the rising edge of Internal_Power_On_Reset.
4	After reading the EEPROM, the PHY reset is de-asserted.
5	APM wake-up mode may be enabled based on what is read from the EEPROM.
6	The PCIe* reference clock is valid $t_{PWRGDPE\_RST-CLK}$ before the assertion of PE_RST_N. Per the PCIe* Specification.
7	PE_RST_N is asserted $t_{PVPGCL}$ after power is stable.
8	The Internal PCIe* clock is valid and stable $t_{ppg-clkint}$ from PE_RST_N de-assertion.
9	The PCIe* internal PE_RST_N signal is asserted $t_{clkpr}$ after the external PE_RST_N signal.
10	Assertion of the internal PCIe* PE_RST_N causes the EEPROM to be re-read, asserts PHY reset, and disables wake up.
11	After reading the EEPROM, PHY reset is de-asserted.
12	Link training starts after $t_{pgtrn}$ from PE_RST_N de-assertion.



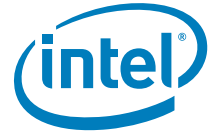

Notes	
13	A first PCIe* configuration access might arrive after $t_{pgcfg}$ from PE_RST_N de-assertion.
14	A first PCIe* configuration response can be sent after $t_{pgres}$ from PE_RST_N de-assertion.
15	Writing a 1b to the <i>Memory Access Enable</i> bit in the PCI Command Register transitions the 82575 from D0u to D0 state.

### 7.4.2.2 Transition from D0a to D3 and Back without PE\_RST\_N

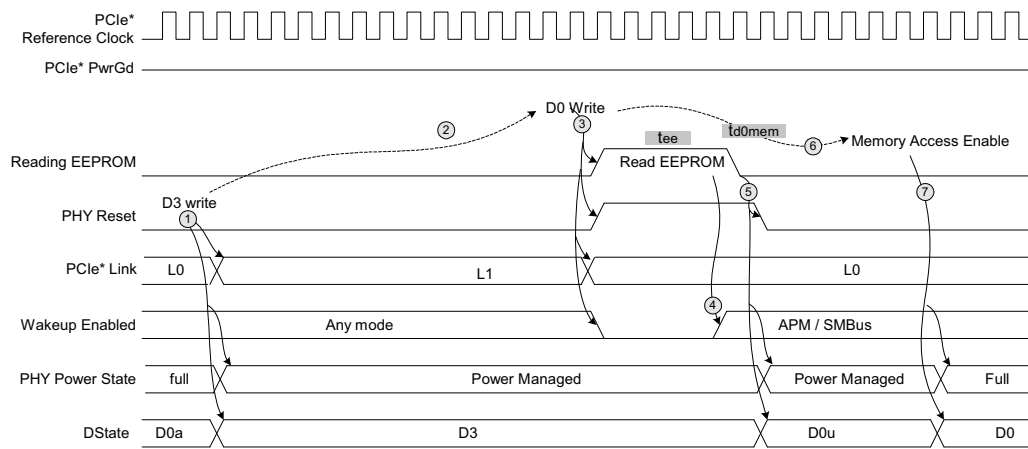

Notes	
1	Writing 11b to the Power State field of the Power Management Control/Status Register (PMCSR) transitions the 82575 to D3.
2	The system keeps the 82575 in D3 for an arbitrary amount of time.
3	To exit D3, the system writes 00b to the Power State field of the Power Management Control/Status Register (PMCSR).
4	APM wake up or SMB mode can be enabled based on the EEPROM contents.
5	After reading the EEPROM, the reset to the PHY is de-asserted. The PHY operates at a reduced speed if APM wake up or SMB is enabled. Otherwise, it is powered down.
6	The system can delay an arbitrary time before enabling memory access.
7	Writing a 1b to the <i>Memory Access Enable</i> bit or to the I/O Access Enable bit in the PCI Command Register transitions the 82575 from D0u to D0 and returns the PHY to full power and full speed operation.



### 7.4.2.3 Transition from D0a to D3 and Back with PE\_RST\_N

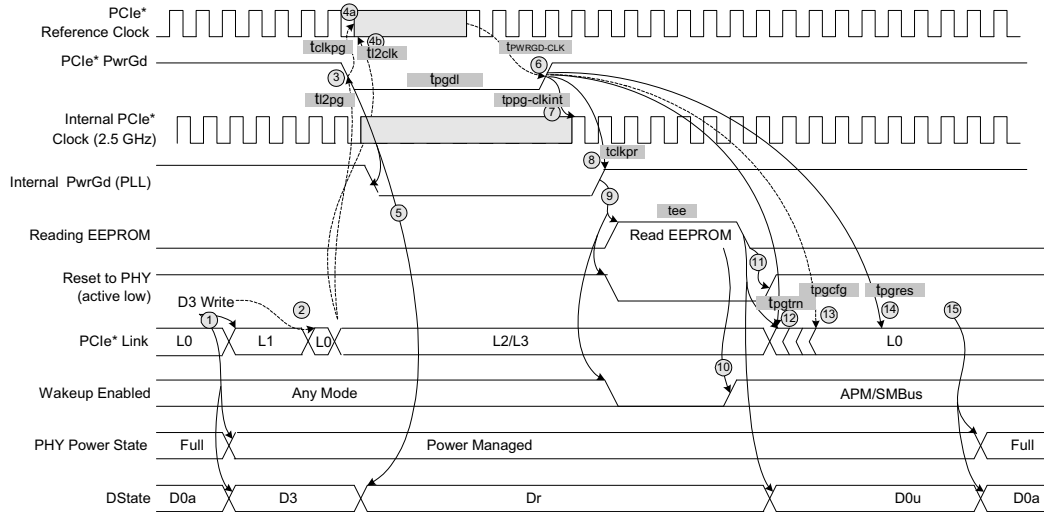

Notes	
1	Writing 11b to the Power State field of the Power Management Control/Status Register (PMCSR) transitions the 82575 to D3. The PCIe* link transitions to L1 state.
2	The system can delay an arbitrary amount of time between setting the D3 mode and transitioning the link to an L2 or L3 state.
3	After a link transition, PE_RST_N is asserted.
4	The system must assert PE_RST_N before stopping the PCIe* reference clock. It must also wait $t_{2clk}$ after link transition to L2 or L3 before stopping the reference clock.
5	When PE_RST_N is asserted, the 82575 transitions to Dr state.
6	The system starts the PCIe* reference clock $t_{PWRGDPE\_RST\_CLK}$ before de-asserting PE_RST_N.
7	The internal PCIe* clock is valid and stable $t_{ppg-clkint}$ from PE_RST_N de-assertion.
8	The PCIe* internal PE_RST_N signal is asserted $t_{clkpr}$ after the external PE_RST_N signal.
9	Assertion of the internal PCIe* PE_RST_N causes the EEPROM to be re-read, asserts a PHY reset, and disables wake up.
10	APM wake-up mode might be enabled based on the EEPROM contents.
11	After reading the EEPROM, the PHY reset is de-asserted.
12	Link training starts after $t_{pgtrn}$ from PE_RST_N de-assertion.
13	A first PCIe* configuration access might arrive after $t_{pgcfg}$ from PE_RST_N de-assertion.
14	A first PCIe* configuration response can be sent after $t_{pgres}$ from PE_RST_N de-assertion.
15	Writing a 1b to the <i>Memory Access Enable</i> bit in the PCI Command Register transitions the 82575 from D0u to D0 state.



### 7.4.2.4 D0a to Dr and Back without Transition to D3

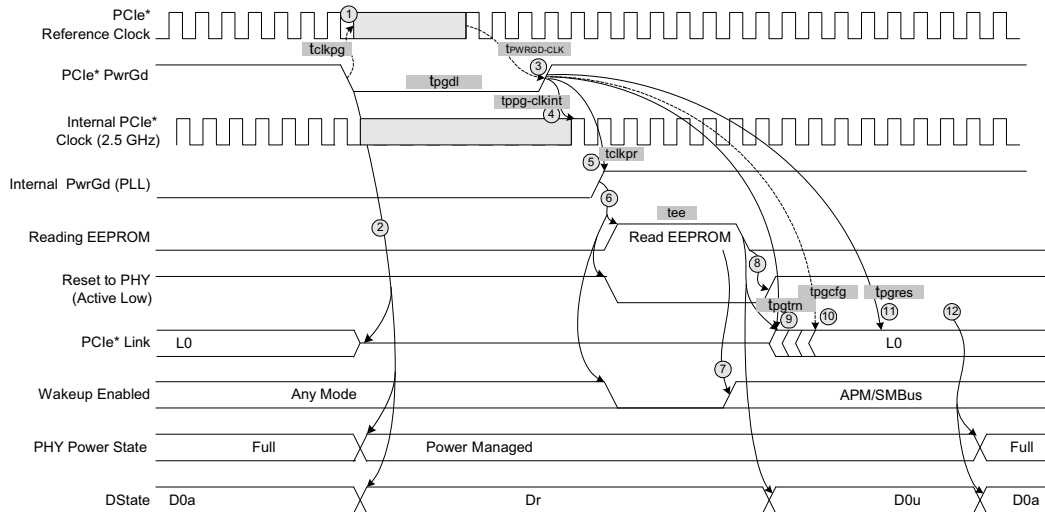

Notes	
1	The system must assert PE_RST_N before stopping the PCIe* reference clock. It must also wait $t_{2clk}$ after link transition to L2 or L3 before stopping the reference clock.
2	When PE_RST_N is asserted, the 82575 transitions to Dr state and the PCIe* link transitions to an electrical idle.
3	The system starts the PCIe* reference clock $t_{PWRGDPE\_RST-CLK}$ before de-asserting PE_RST_N.
4	The internal PCIe* clock is valid and stable $t_{ppg-clkint}$ from PE_RST_N de-assertion.
5	The PCIe* internal PE_RST_N signal is asserted $t_{clkpr}$ after the external PE_RST_N signal.
6	Assertion of the internal PCIe* PE_RST_N causes the EEPROM to be re-read, asserts a PHY reset, and disables wake up.
7	APM wake-up mode can be enabled based on the EEPROM contents.
8	After reading the EEPROM, PHY reset is de-asserted.
9	Link training starts after $t_{pgtrn}$ from PE_RST_N de-assertion.
10	A first PCIe* configuration access might arrive after $t_{pgcfg}$ from PE_RST_N de-assertion.
11	A first PCIe* configuration response can be sent after $t_{ppres}$ from PE_RST_N de-assertion.
12	Writing a 1b to the <i>Memory Access Enable</i> bit in the PCI Command Register transitions the 82575 from D0u to D0a state.

### 7.4.2.5 Timing Requirements

The 82575 requires the following start up and power state transitions.



Parameter	Description	Min	Max	Notes
$t_{xog}$	Xosc stable from power stable.		10 ms	
$t_{PWRGDPE\_RST\_CLK}$	PCIe* clock valid to PCIe* power good.	100 $\mu$ s	-	As per PCIe* Specification.
$t_{PVPGL}$	Power rails stable to PCIe* PE_RST_N in active	100 ms	-	As per PCIe* Specification.
$T_{pgcfg}$	External PE_RST_N signal to first configuration cycle.	100 ms		As per PCIe* Specification.
$t_{d0mem}$	82575 programmed from D3hot to D0 state to next 82575 access.	10 ms		As per PCIe* Management Specification.
$t_{l2pg}$	L2 link transition to PE_RST_N de-assertion.	0 ns		As per PCIe* Specification.
$t_{l2clk}$	L2 link transition to removal of PCIe* reference clock.	100 ns		As per PCIe* Specification.
$T_{clkpg}$	PE_RST_N de-assertion to removal of PCIe* reference clock.	0 ns		As per PCIe* Specification.
$T_{pgdl}$	PE_RST_N assertion time.	100 $\mu$ s		As per PCIe* Specification.

### 7.4.2.6 Timing Guarantees

The 82575 guarantees the following start up and power state transition related timing parameters.

Parameter	Description	Min	Max	Notes
$t_{xog}$	Xosc stable from power stable.		10 ms	
$t_{ppg}$	Internal power good delay from valid power rail.	35 ms	35ms	
$t_{ee}$	EEPROM read duration.	-	20 ms	
$t_{ppg-clkint}$	PCIe* PE_RST_N to internal PLL lock.		50 $\mu$ s	
$t_{clkpr}$	Internal PCIe* PE_RST_N from external PCIe* PE_RST_N.		50 $\mu$ s	
$t_{pgtrn}$	PCIe* PE_RST_N to start of link training.		20 ms	As per PCIe* Specification.
$T_{pgres}$	External PE_RST_N response to first configuration cycle.		1 s	As per PCIe* Specification.

## 7.4.3 82575 and SerDes Power-Down State

### 7.4.3.1 SerDes Power-Down State

The SerDes enters a power-down state when none of its clients is enabled and therefore, no need to maintain a link. The following conditions must be met for the SerDes to enter a power-down mode:

- SerDes power-down is enabled through either the EEPROM *SerDes Low Power Enable* bit or the same bit in CTRL\_EXT.
- The LAN function associated with this SerDes is in a non-D0 state.
- APM WOL is inactive.
- ACPI PME is disabled for both LAN functions (in some Dr cases, ACPI power management is irrelevant).



The SerDes also enters a power-down state in the following cases:

- When the 82575 is configured for PHY operation only.
- When the LAN0\_DIS\_N (or LAN1\_DIS\_N) signal for this LAN function indicates that the relevant function should be disabled and the EEPROM *SerDes Low-Power Enable* bit is set.

### 7.4.3.2 82575 Power-Down State

The 82575 enters a global power-down state if all of the following conditions are met:

- The 82575 *Power-Down Enable* EEPROM bit was set (default hardware value is disabled).
- The 82575 is in Dr state.
- The link connections of both ports (PHY or SerDes) are in power down mode.

The 82575 also enters a power-down state when the DEV\_OFF\_N pin is active and the relevant EEPROM bits were configured as previously stated. In addition, the manageability firmware can decide to power down the 82575.

## 7.5 Wake Up

The 82575 supports two modes of wakeup management:

1. Advanced Power Management wakeup (APM).
2. ACPI/PCIe\* defined wakeup.

The usual model is to activate only one of the two modes at a time but not both. If both modes are activated at the same time, the 82575 might wakeup the system in unexpected events. For example, if APM is enabled together with PCIe\* PME, a magic packet might wakeup the system even if APMPME is disabled, alternatively, if APM is enabled together with some PCIe\* filters, packets matching these filters might wakeup the system even if PCIe\* PME is disabled.

### 7.5.1 Advanced Power Management Wakeup

Advanced Power Management Wake Up, or APM Wake Up, was previously known as Wake on LAN (WOL). It is a feature that has been present in the 10/100 Mb/s NICs for several generations. Its basic function is to receive a broadcast or unicast packet with an explicit data pattern and respond by asserting a wake-up signal to notify the system about a wake-up event. In the earlier generations, this was accomplished by using a special signal that ran across a cable to a defined connector on the motherboard. The adapter asserted the signal for approximately 50 ms to signal a wake up. If the 82575 is configured appropriately, it uses an in-band PM\_PME message to achieve this.

At power up, the 82575 reads the *APM Enable* bits from the EEPROM Initialization Control Word 2 into the *APM Enable* (APME) bits of the Wakeup Control Register (WUC). These bits enable APM Wake Up.

When APM Wake Up is enabled, the 82575 checks all incoming packets for Magic Packets\*. When the 82575 receives a matching Magic Packet, it acts accordingly. If the Assert PME on *APM Wake Up* (APMPME) bit is set in the WUC register, the 82575:

- Sets the *PME\_Status* bit in the PMCSR and issues a PM\_PME message. In some cases, this might first require assertion of the WAKE# signal to resume power and clock to the PCIe\* interface.
- Stores the first 128 bytes of the packet in the Wake Up Packet Memory (WUPM).



- Sets the Magic Packet Received bit in the Wake Up Status Register (WUS).
- Sets the packet length in the Wake Up Packet Length Register (WUPL).

The 82575 maintains the first magic packet received in the Wake Up Packet Memory (WUPM) until the software device driver writes a 1b to the *Magic Packet Received MAG* bit in the Wake Up Status Register (WUS).

APM Wake Up is supported in all power states and only disabled if a subsequent EEPROM read results in a cleared APM Wake Up bit or software explicitly writes a 0b to the APM Wake Up (APM) bit of the WUC register.

## 7.5.2 PCIe Power Management Wakeup

- The 82575 supports PCIe\* Power Management based wake ups. It can generate system wake-up events from three sources:
- Reception of a Magic Packet.
- Reception of a network wake-up packet.
- Detection of a link change of state.

Activating PCIe\* Power Management Wake Up requires the following steps:

- The driver programs the WUFC register indicating the wake-up packets. It also supplies the necessary data to the IPv4 and IPv6 Address Table (IP4AT and IP6AT) and the Flexible Filter Mask Table (FFMT), and the Flexible Filter Value Table (FFVT). It can also set the Link Status Change (LNKC) bit in the Wake Up Filter Control Register (WUFC) to cause wake up when the link changes state.
- At configuration time, the operating system writes a 1b to the PME\_EN bit of the PMCSR.

After enabling wake up, the operating system typically writes 11b to the lower two bits of the PMCSR placing the 82575 into low-power mode.

After wake up is enabled, the 82575 monitors the incoming packets. First, it filters the packets according to its standard address filtering method and then filtering them with all of the enabled wake-up filters. If a packet passes both the standard address filtering and at least one of the enabled wake-up filters, the 82575:

- Sets the *PME\_Status* bit in the PMCSR.
- If the PME\_EN bit in the PMCSR is set, assert PE\_WAKE\_N or send a PM-PME message as defined in the PCIe\* specification.
- Stores the first 128 bytes of the packet in the Wake Up Packet Memory.
- Sets one or more of the received bits in the Wake Up Status Register (WUS). (The 82575 sets more than one bit if a packet matches more than one filter.)
- Sets the packet length in the Wake Up Packet Length Register (WUPL).

If enabled, a link state change wake up causes similar results, setting PME\_Status, asserting PE\_WAKE\_N and setting the Link Status Changed (LNKC) bit in the Wake Up Status Register (WUS) when the link goes up or down.

The 82575 supports the following change described in the PCIe\* Base Specification, Rev. 1.1RD (section 5.3.3.4): On receiving a PME\_Turn\_Off Message, the 82575 must block the transmission of PM\_PME Messages and transmit a PME\_TO\_Ack Message upstream. The 82575 is permitted to send a PM\_PME Message after the Link is returned to an L0 state through LDn.



PE\_WAKE\_N remains asserted until the operating system either writes a 1b to the PME\_Status bit of the PMCSR or writes a 0b to the PME\_EN bit.

After receiving a wake-up packet, the 82575 ignores any subsequent wake-up packets until the software device driver clears all of the received bits in the Wake Up Status Register (WUS). It also ignores link change events until the software device driver clears the Link Status Change (LNKC) bit in the WUS.

**Note:** Wake on link change is not supported when in SerDes mode.

## 7.5.3 Wake-Up Packets

The 82575 supports various wakeup packets using two types of filters:

- Pre-defined filters
- Flexible filters

Each of these filters are enabled if the corresponding bit in the Wake Up Filter Control register (WUFC) is set to 1b.

### 7.5.3.1 Pre-Defined Filters

The following packets are supported by the 82575 pre-defined filters:

- Directed Packet (including exact, multicast, and broadcast).
- Magic Packet.
- ARP/IPv4 Request Packet.
- Directed IPv4 Packet.
- Directed IPv6 Packet.

Each of these filters are enabled if the corresponding bit in the Wake Up Filter Control Register (WUFC) is set to 1b.

The explanation of each filter includes a table detailing which bytes at which offsets are compared to determine if the packet passes the filter. Both VLAN frames and LLC/Snap frames can increase the given offsets if they are present.

#### 7.5.3.1.1 Directed Exact Packet

The 82575 generates a wake-up event upon reception of any packet whose destination address matches one of the 16 valid programmed Receive Addresses if the Directed Exact Wake Up Enable bit is set in the Wake Up Filter Control Register (WUFC.EX).

Offset	Number of Bytes	Field	Value	Action	Comment
0	6	Destination Address		Compare	Match any pre-programmed address.

#### 7.5.3.1.2 Directed Multicast Packet



For multicast packets, the upper bits of the destination address in the incoming packet index a bit vector. This is the Multicast Table Array that indicates whether to accept the packet. If the Directed Multicast Wake Up Enable bit is set in the Wake Up Filter Control Register (WUFC.MC) and the indexed bit in the vector is 1b, then the 82575 generates a wake-up event. The exact bits used in the comparison are programmed by software in the Multicast Offset field of the Receive Control Register (RCTL.MO).

Offset	Number of Bytes	Field	Value	Action	Comment
0	6	Destination Address		Compare	See above paragraph.

### 7.5.3.1.3 Broadcast

If the *Broadcast Wake Up Enable* bit in the Wake Up Filter Control Register (WUFC.BC) is set, the 82575 generates a wake-up event when it receives a broadcast packet.

Offset	Number of Bytes	Field	Value	Action	Comment
0	6	Destination Address	ff*6	Compare	

### 7.5.3.1.4 Magic Packet\*

The definition for a Magic Packet\* can be located at:

[http://www.amd.com/us-en/assets/content\\_type/white\\_papers\\_and\\_tech\\_docs/20213.pdf](http://www.amd.com/us-en/assets/content_type/white_papers_and_tech_docs/20213.pdf).

The 82575 expects the destination address to either:

- Be the broadcast address (FF.FF.FF.FF.FF.FF).
- Match the value in the Receive Address Register 0 (RAH0, RAL0). This is initially loaded from the EEPROM but might be changed by the software device driver.
- Match any other address filtering enabled by the software device driver.

The 82575 looks for the contents of Receive Address Register 0 (RAH0, RAL0) as the embedded IEEE address. It will consider any non-FFh byte after a series of at least 6 FFs to be the start of the IEEE address for comparison purposes. For example, it catches the case of 7 FFs followed by the IEEE address. As soon as one of the first 96 bytes after a string of FFs does not match, it continues to search for another set of at least 6 FFs followed by the 16 copies of the IEEE address later in the packet. It should be noted that this definition precludes the first byte of the destination address from equaling FF.

A Magic Packet destination address must match the address filtering enabled in the configuration registers with the exception that broadcast packets will be considered to match even if the Broadcast Accept bit of the Receive Control Register (RCTL.BAM) is 0b. If APM Wake Up is enabled in the EEPROM, the 82575 starts with the Receive Address Register 0 (RAH0, RAL0) loaded from the EEPROM. This allows the 82575 to accept packets with the matching IEEE address before the driver comes up.

Offset	Number of Bytes	Field	Value	Action	Comment
--------	-----------------	-------	-------	--------	---------





0	6	Destination Address		Compare	MAC header processed by main address filter.
6	6	Source Address		Skip	
12	8	Possible LLC/SNAP Header		Skip	
12	4	Possible VLAN Tag		Skip	
12	4	Type		Skip	
any	6	Synchronizing Stream	FF*6+	Compare	
any+6	96	16 copies of Node Address	A*16	Compare	Compared to Receive Address Register 0 (RAH0, RAL0).

**Note:** Accepting broadcast magic packets for wake up purposes when Broadcast Accept bit of the Receive Control Register (RCTL.BAM) is 0b differs from older generation Intel Gigabit Ethernet components. Previously, these devices initialized RCTL.BAM to 1b if APM was enabled in the EEPROM but then required that bit to equal 1b to accept broadcast Magic Packets, unless broadcast packets passed another perfect or multicast filter.

### 7.5.3.1.5 ARP/IPv4 Request Packet

The 82575 supports the reception of ARP request packets for wake up if the ARP bit is set in the Wake Up Filter Control Register (WUFC). Four IPv4 addresses are supported and are programmed in the IPv4 Address Table (IP4AT). A successfully matched packet must contain a broadcast MAC address, a Protocol Type of 0806h, an ARP OPCODE of 01h, and one of the four programmed IPv4 addresses. The 82575 also handles ARP request packets with VLAN tagging on both Ethernet II and Ethernet SNAP types.

Offset	Number of Bytes	Field	Value	Action	Comment
0	6	Destination Address		Compare	MAC header processed by main address filter.
6	6	Source Address		Skip	
12	8	Possible LLC/SNAP Header		Skip	
12	4	Possible VLAN Tag		Skip	
12	2	Type	0806h	Compare	ARP
14	2	Hardware Type	0001h	Compare	
16	2	Protocol Type	0800h	Compare	
18	1	Hardware Size	06h	Compare	
19	1	Protocol Address Length	04h	Compare	
20	2	Operation	0001h	Compare	
22	6	Sender Hardware Address	-	Ignore	
28	4	Sender IP Address	-	Ignore	
32	6	Target Hardware Address	-	Ignore	
38	4	Target IP Address	IP4AT	Compare	May match any of 4 values in IP4AT.

### 7.5.3.1.6 Directed IPv4 Packet

The 82575 supports the reception of Directed IPv4 packets for wake up if the IPv4 bit is set in the Wake Up Filter Control Register (WUFC). Four IPv4 addresses are supported and are programmed in the IPv4 Address Table (IP4AT). A successfully matched packet must contain the station MAC address, a Protocol Type of 0800h, and one of the four programmed IPv4 addresses. The 82575 also handles Directed IPv4 packets with VLAN tagging on both Ethernet II and Ethernet SNAP types.



Offset	Number of Bytes	Field	Value	Action	Comment
0	6	Destination Address		Compare	MAC Header processed by main address filter.
6	6	Source Address		Skip	
12	8	Possible LLC/SNAP Header		Skip	
12	4	Possible VLAN Tag		Skip	
12	2	Type	0800h	Compare	IP
14	1	Version/ HDR length	4Xh	Compare	Check IPv4.
15	1	Type of Service	-	Ignore	
16	2	Packet Length	-	Ignore	
18	2	Identification	-	Ignore	
20	2	Fragment Information	-	Ignore	
22	1	Time to Live	-	Ignore	
23	1	Protocol	-	Ignore	
24	2	Header Checksum	-	Ignore	
26	4	Source IP Address	-	Ignore	
30	4	Destination IP Address	IP4AT	Compare	May match any of 4 values in IP4AT.

### 7.5.3.1.7 Directed IPv6 Packet

The 82575 supports reception of Directed IPv6 packets for wake up if the IPv6 bit is set in the Wake Up Filter Control Register (WUFC). One IPv6 address is supported and it is programmed in the IPv6 Address Table (IP6AT). A successfully matched packet must contain the station MAC address, a Protocol Type of 86DDh, and the programmed IPv6 address. In addition, the IPAV.V60 bit should be set. The 82575 also handles Directed IPv6 packets with VLAN tagging on both Ethernet II and Ethernet SNAP types.

Offset	Number of Bytes	Field	Value	Action	Comment
0	6	Destination Address		Compare	MAC Header processed by main address filter.
6	6	Source Address		Skip	
12	8	Possible LLC/SNAP Header		Skip	
12	4	Possible VLAN Tag		Skip	
12	2	Type	0800h	Compare	IP
14	1	Version / Priority	6Xh	Compare	Check IPv6.
15	3	Flow Label	-	Ignore	
18	2	Payload Length	-	Ignore	
20	1	Next Header	-	Ignore	
21	1	Hop Limit	-	Ignore	
22	16	Source IP Address	-	Ignore	
38	16	Destination IP Address	IP6AT	Compare	Match value in IP6AT.

### 7.5.3.2 Flexible Filter

The 82575 supports a total of four flexible filters. Each filter can be configured to recognize any arbitrary pattern within the first 128 bytes of the packet. The flexible filter is configured by software programming mask values into the Flexible Filter Mask Table (FFMT), required values into the Flexible



Filter Value Table (FFVT). These contain separate values for each filter. The software must also enable the filter in the Wake Up Filter Control Register (WUFC) and enable the overall wake up functionality must be enabled by setting PME\_EN in the PMCSR or the WUC register.

When flexible filtering is enabled, the flexible filters scan incoming packets for a match. If the filter encounters any byte in the packet where the mask bit is one and the byte does not match the byte programmed in the Flexible Filter Value Table (FFVT), then the filter will fail that packet. If the filter reaches the required length without failing the packet, it passes the packet and generates a wake-up event. It will ignore any mask bits set to one beyond the required length.

**Note:** The minimum length of a flex filter is two bytes.

The following packets listed in subsequent sections are for reference purposes only. The flexible filter can be used to filter these packets.

### 7.5.3.2.1 IPX Diagnostic Responder Request Packet

An IPX Diagnostic Responder Request Packet must contain a valid MAC address, a Protocol Type of 8137h, and an IPX Diagnostic Socket of 0456h. It might include LLC/SNAP headers and VLAN tags. Since filtering this packet relies on the flexible filters, which use offsets directly specified by the operating system, the operating system must account for the extra offset due to the LLC/SNAP headers and VLAN tags.

Offset	Number of Bytes	Field	Value	Action	Comment
0	6	Destination Address		Compare	
6	6	Source Address		Skip	
12	8	Possible LLC/SNAP Header		Skip	
12	4	Possible VLAN Tag		Skip	
12	2	Type	8137h	Compare	IPX
14	16	Some IPX Data	-	Ignore	
30	2	IPX Diagnostic Socket	0456h	Compare	

### 7.5.3.2.2 Directed IPX Packet

A valid Directed IPX Packet contains the station MAC address, a Protocol Type of 8137h, and an IPX Node Address equal to the station MAC address. It may include LLC/SNAP headers and VLAN tags. Since filtering this packet relies on the flexible filters, which use offsets directly specified by the operating system, the operating system must account for the extra offset due to the LLC/SNAP headers and VLAN tags.

Offset	Number of Bytes	Field	Value	Action	Comment
0	6	Destination Address		Compare	MAC Header processed by main address filter.
6	6	Source Address		Skip	
12	8	Possible LLC/SNAP Header		Skip	
12	4	Possible VLAN Tag		Skip	
12	2	Type	8137h	Compare	IPX.
14	10	Some IPX Data	-	Ignore	
24	6	IPX Node Address	Receive Address 0	Compare	Must match Receive Address 0.

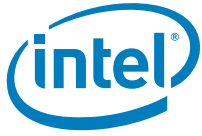

### 7.5.3.2.3 IPv6 Neighbor Discovery Filter

In IPv6, a Neighbor Discovery packet is used for address resolution. A flexible filter can be used to check for a Neighborhood Discovery Packet.

### 7.5.3.3 Wake Up Packet Storage

The 82575 saves the first 128 bytes of the wake-up packet in its internal buffer, which can be read through the Wake Up Packet Memory (WUPM) after the system has been woken up.

§ §



## 8.0 DCA

---

This section describes the Direct Cache Access (DCA) functionality for the 82575.

Direct Cache Access (DCA) is a method to improve network I/O performance by placing some posted inbound writes directly within processor cache. DCA can significantly reduce processor cache miss rates.

DCA provides a mechanism where the posted write data from an I/O device, such as an Ethernet NIC, can be placed into the processor cache with a hardware pre-fetch. This mechanism is initialized upon a power good reset. A software device driver for the I/O device configures it for DCA and sets up the appropriate processor ID and bus ID for the device to send data. The device then encapsulates that information in PCIe\* TLP headers (in the TAG field) to trigger a hardware pre-fetch by the MCH to the processor cache.

DCA implementation is controlled by separate registers (RXCTL and TXCTL) for each receive and transmit queues. In addition, a DCA-enable bit can be found in the GCR register and a DCA\_ID register can be found for each port in order to make visible the function, device, and bus numbers to the software device driver.

The RXCTL and TXCTL registers can be written by software and can be changed at any time. When software changes the register contents, hardware applies changes only after all the previous packets in progress for DCA has completed.

In order to implement DCA, the 82575 has to be aware of the data movement engine version being used. The software device driver initializes the 82575 to make it aware of the data movement engine version. DCA\_BUS\_SELECT CTRL is used in order to properly define the system configuration.

There are two modes for DCA implementation:

1. Data Movement Engine 1: The DCA target ID is derived from processor ID
2. Data Movement Engine 2: The DCA target ID is derived from APIC ID.

The software device driver selects one of these modes through the DCA Mode register.

## 8.1 Implementation Details

### 8.1.1 PCIe\* Message Format for DCA (MWr Mode)

Figure 25 shows the format of the PCIe\* message for DCA.

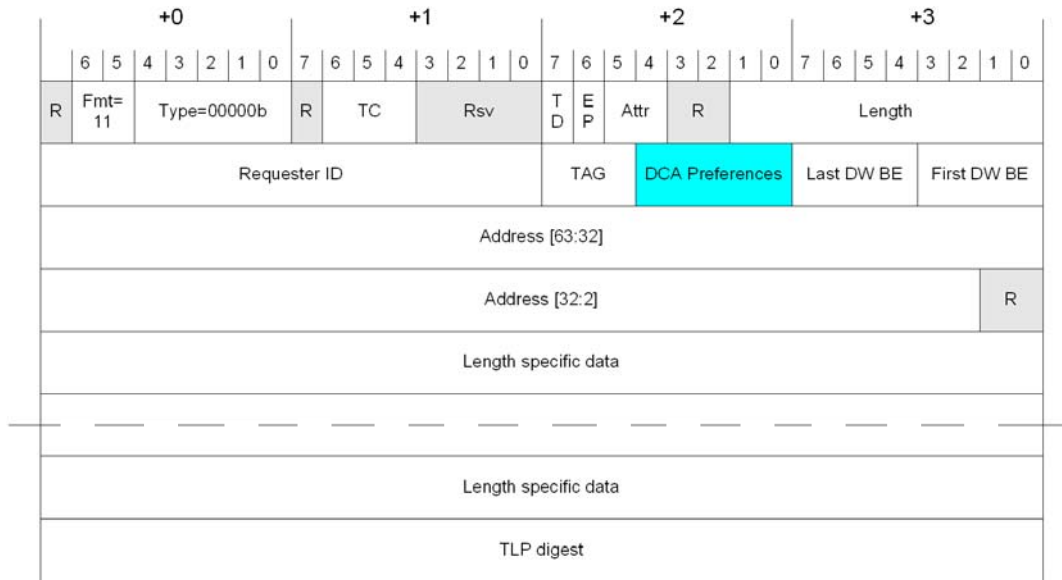

Figure 25. PCIe\* Message Format for DCA

The DCA preferences field has the following formats data movement engine 1 systems:

Bits	Name	Description
0	DCA Indication	0b = DCA disabled. 1b = DCA enabled.
1	DCA Target ID	The DCA Target ID specifies the target cache for the data.

For data movement engine 2 systems:

Bits	Name	Description
7:0	DCA Target ID	0000,0000b: DCA is disabled Other: Target Core Id derived from APIC ID <b>Note:</b> The 82575 supports programming of only five bits of the eight possible. In the 82575 A0, the disable tag is 11111b.

**Note:** All functions within the 82575 have to adhere to the tag encoding rules for DCA writes. Even if a given function is not capable of DCA, but other functions are capable of DCA, memory writes from the non-DCA function must set the tag field to 00000b.

§ §



## 9.0 Ethernet Interface

The 82575 provides a complete CSMA/CD function supporting IEEE 802.3 (10 Mb/s), 802.3u (100 Mb/s), 802.3z and 802.3ab (1000 Mb/s) implementations. It performs all of the functions required for transmission, reception and collision handling called out in the standards.

- Each 82575 MAC can be configured to be used a different media interface. While the most likely application is expected to be based on use of the internal copper PHY, the 82575 supports the following configurations:
- Internal Copper PHY.
- External SerDes device such as an optical SerDes (SFP or onboard) or backplane connections.
- External SGMII device. This mode is used for SFP connections or external SGMII PHYs.

Selection between the various configurations is programmable via each MAC's Extended Device Control Register (CTRL\_EXT.LINK\_MODE bits) and defaulted via EEPROM settings. lists the encoding on the LINK\_MODE field for each of the modes.

**Table 78. Link Mode Encoding**

Link Mode	82575 Mode
00b	Internal PHY
01b	Reserved
10b	SGMII
11b	New SerDes

The GMII/MII mode used to communicate between the MAC and the internal PHY and SGMII mode supports 10/100/1000 Mb/s operation, with both half- and full-duplex operation at 10/100 Mb/s, and full-duplex operation at 1000 Mb/s.

The SerDes function can be used to implement a Fiber/optics-based solution or backplane connection without requiring an external transceiver/SerDes.

**Note:** There are two SerDes modes supported by the 82575, a legacy mode (EXT\_CTRL.LINK\_MODE = 01b) and a recommended one (EXT\_CTRL.LINK\_MODE = 11b). The following description refers to both modes. Both modes implement the same protocol. However the control and status registers used in the two modes are different.

The SGMII interface can be used to connect to SFP modules; however, the following limitations apply:

- No Tx clock
- AC coupling only



The internal copper PHY features 10/100/1000BASE-T signaling and is capable of performing intelligent power-management based on both the system power-state and LAN energy-detection (detection of unplugged cables). Power management includes ability to shut-down to extremely low (powered-down) state when not needed as well as ability to auto-negotiate to lower-speed 10/100 Mb/s operation when the system is in low power-states.

## 9.1 Internal MAC/PHY 10/100/1000Base-T Interface

The 82575 MAC and PHY communicate through an internal 10/100/1000Base-T interface that can be configured for either 1000 Mb/s operation (GMII) or 10/100 Mb/s (MII) mode of operation. For proper network operation, both MAC and PHY must be properly configured (either explicitly via software or via hardware auto-negotiation) to identical speed and duplex settings. All MAC configuration is performed using device control registers mapped into system memory or I/O space; an internal MDIO/MDC interface accessible via software is used to configure the PHY operation.

The internal 1000Base-T mode of operation is similar to 10/100Base-T mode of operation. 1000Base-T mode uses the same MDIO/MDC management interface and registers for PHY configuration as 10/100Base-T mode. These common elements of operation enable the MAC and PHY to cooperatively determine link partner's operational capability and configure the hardware based on those capabilities.

- **RX\_DATA** (receive data): Data received by the PHY is transferred to the MAC in 8-bit quantities at 125 MHz in GMII mode.
- **RX\_ER** (receive error): Receive errors are detected by the PHY and signaled to the MAC. Receive errors may include link coding errors, or any other error detected by the PHY. If receive errors signaled during packet reception, the MAC can be configured to either receive or drop these packets.
- **RX\_DV** (receive data valid): This signal is asserted from the PHY to the MAC to transfer valid frame data to the MAC. It is asserted from the first through the final bytes of a frame, de-asserted after the final byte. The PHY asserts carriers sense with this data-valid signal de-asserted to indicate to the MAC reception of broken packet headers (fragments).

### 9.1.1 MDIO/MDC

The 82575 implements an internal IEEE 802.3 MII Management Interface (also known as the Management Data Input/Output or MDIO Interface) between the MAC and PHY. This interface provides the MAC and software the ability to monitor and control the state of the PHY. The internal MDIO interface defines a physical connection, a special protocol that runs across the connection, and an internal set of addressable registers. The internal interface consists of a data line (MDIO) and clock line (MDC), which are accessible by software via the MAC register space.

- **MDC** (management data clock) — This signal is used by the PHY as a clock timing reference for information transfer on the MDIO signal. The MDC is not required to be a continuous signal and can be frozen when no management data is transferred. The MDC signal has a maximum operating frequency of 2.5 MHz.
- **MDIO** (management data I/O) — This internal signaling between the MAC and PHY logically represents a bi-directional data signal used to transfer control information and status to and from the PHY (to read and write the PHY management registers). Asserting and interpreting value(s) on this interface requires knowledge of the special MDIO protocol to avoid possible internal signal contention or miscommunication to/from the PHY.





Software can use MDIO accesses to read or write registers in either 1000Base-T or 10/100Base-T mode by accessing the 82575's MDIC register.

When working in SGMII/SerDes mode, the external PHY (if applicable) can be accessed either through MDC/MDIO as previously described or via an I<sup>2</sup>C bus using the I2CCMD register. The I<sup>2</sup>C bus or the MDC/MDIO bus are connected via the same pins, and are mutually exclusive. In order to be able to control an external device, either by SFP or MDC/MDIO, the I<sup>2</sup>C *SFP Enable* bit in Initialization Control 3 EEPROM word should be set.

As the MDC/MDIO command can be targeted either to the internal PHY or to an external bus, the *MDIC.Destination* bit is used to define the target of the transaction.

**Note:** Each port has its own MDC/MDIO or I<sup>2</sup>C bus and there is no sharing between the ports of the control port. In order to control both port PHYs via the same control bus, accesses to both PHYs should be done via the same port with different device addresses.

## 9.2 Duplex Operation for Copper PHY Operation

The 82575 supports half-duplex and full-duplex 10/100 Mb/s MII mode either through internal copper PHY or SGMII interface. However, only full-duplex mode is supported when SerDes mode is used or in any 1000 Mb/s connection.

Configuration of the duplex operation of the 82575 can be forced or determined via the Auto-Negotiation process. See [Section 9.3](#) for details on link configuration setup and resolution.

### 9.2.1 Full Duplex

All aspects of the IEEE 802.3, 802.3u, 802.3z, and 802.3ab specifications are supported in full duplex operation. Full duplex operation is enabled by several mechanisms depending on the speed configuration of the 82575 and the specific capabilities of the PHY used in the application. During full duplex operation, the 82575 can transmit and receive packets simultaneously across the link interface.

In full-duplex 10/100/1000Base-T mode, transmission and reception are delineated independently by the 10/100/1000Base-T control signals. Transmission starts upon the assertion of TX\_EN, which indicates there is valid data on the TX\_DATA bus driven from the MAC to the PHY. Reception is signaled by the PHY by the assertion of the RX\_DV signal which indicates valid receive data on the RX\_DATA lines to the MAC.

In SerDes mode, the transmission and reception of packets is indicated by symbols imbedded in the data stream. These symbols delineate the packet encapsulation and the protocol does not rely on other control signals.



## 9.2.2 Half Duplex

In half duplex mode, the 82575 attempts to avoid contention with other traffic on the wire, by monitoring the carrier sense signal provided by the PHY, and deferring to passing traffic. When the Internal Carrier Sense signal is deasserted or after sufficient InterPacket Gap (IPG) has elapsed after a transmission, frame transmission can begin. The MAC signals the PHY with TX\_EN at the start of transmission.

In the case of a collision, the PHY/SGMII detects the collision and asserts the COL signal to the MAC. Transmission of the frame stops within four link clock times, and the 82575 sends a JAM sequence onto the link. After the end of a collided transmission, the 82575 backs off and attempt to retransmit per the standard CSMA/CD method. Note that the re-transmissions are done from the data stored internally in the 82575 MAC transmit packet buffer (no re-access to the data in host memory is performed).

The MAC behavior is different if a regular collision or a late collision is detected. If a regular collision is detected, the MAC always tries to retransmit until the number of excessive collision is reached. In case of late collision, the MAC retransmission is configurable. In addition, statistics are gathered on late collisions.

In the case of a successful transmission, the 82575 is ready to transmit any other frame(s) queued in the MAC's transmit FIFO after the minimum Inter Frame Spacing (IFS) of the link has elapsed.

During transmit, the PHY is expected to signal a carrier-sense (assert the CRS signal) back to the MAC before one slot time has elapsed. The transmission completes successfully even if the PHY fails to indicate CRS within the slot time window; if this situation occurs, the PHY can either be configured incorrectly or be in a link down situation. Such an event is counted in the Transmit without CRS statistic register (see [Section 14.8.12](#)).

## 9.2.3 Gigabit Physical Coding Sub-Layer (PCS) for SerDes

The 82575 integrates the 802.3z PCS function on-chip. The on-chip PCS circuitry is used when the link interface is configured for Serdes or SGMII operation and is bypassed for internal PHY mode.

The packet encapsulation is based on the Fibre Channel physical layer (FC0/FC1) and uses the same coding scheme to maintain transition density and DC balance. The physical layer device is the SerDes and is used for 1000BASE-SX, -LX, or -CX configurations.

### 9.2.3.1 8B10B Encoding/Decoding

The Gigabit PCS circuitry uses the same transmission coding scheme used in the Fibre Channel physical layer specification. The 8B10B coding scheme was chosen by the IEEE standards committee in order to provide a balanced, continuous stream with sufficient transition density to allow for clock recovery at the receiving station. There is a 25 percent overhead for this transmission code which accounts for the data signaling rate of 1250 Mb/s with 1000 Mb/s of actual data.



### 9.2.3.2 Code Groups and Ordered Sets

Code group and ordered set definitions are defined in clause 36 of the IEEE 802.3z standard. These represent special symbols used in the encapsulation of Gigabit Ethernet packets. Table 79 lists a brief description of defined ordered sets for informational purposes only.

**Table 79. Code Group and Ordered Set Usage**

Code	Ordered_Set	# of Code Groups	Usage
/C/	Configuration	4	General reference to configuration ordered sets, either /C1/ or /C2/, which is used during Auto Negotiation to advertise & negotiate link operation information between link partners. Last two code groups contain config base and next page registers.
/C1/	Configuration 1	4	See /C/. Differs from /C2/ in second code group for maintaining proper signaling disparity.
/C2/	Configuration 2	4	See /C/. Differs from /C1/ in second code group for maintaining proper signaling disparity.
/I/	IDLE	2	General reference to IDLE ordered sets. IDLE characters are continually transmitted by the end stations and are replaced by encapsulated packet data. The transitions in the IDLE stream allow the SerDes to maintain clock and symbol synchronization between to link partners.
/I1/	IDLE 1	2	See /I/. Differs from /I2/ in second code group for maintaining proper signaling disparity. <sup>1</sup>
/I2/	IDLE 2	2	See /I/. Differs from /I1/ in second code group for maintaining proper signaling disparity <sup>2</sup> .
/S/	Start_of_Packet	1	The SPD (start_of_packet delimiter) ordered set is used to indicate the starting boundary of a packet transmission. This symbol replaces the first byte of the preamble received from the MAC layer.
/T/	End_of_Packet	1	The EPD (end_of_packet delimiter) is comprised of three ordered sets. The /T/ symbol is always the first of these and indicates the ending boundary of a packet.
/V/	Error_Propagation	1	The /V/ ordered set is used by the PCS to indicate error propagation between stations. This is normally intended to be used by repeaters to indicate collisions.

1. The concept of running disparity is defined in the standard. In summary, this refers to the 1-0 and 0-1 transitions within 8B10B code groups

### 9.2.4 SGMII Encoding in 10/100 Mb/s

When working in SGMII mode at 10 or 100 Mb/s, the code group of each byte is duplicated 100 or 10 times respectively, in order to match the link rate and the SerDes interface rate. The 82575 samples one copy from each received set before sending it to the MAC.

**Note:** If an RXERR is asserted (1b), one of the replications might be ignored by the 82575. In this case the packet might be accepted or dropped due to subsequent CRC errors. This behavior might be observed depending on the placement of the external PHY.



## 9.3 Auto-Negotiation and Link Setup

The method for configuring the link between two link partners is highly dependent on the mode of operation as well as the functionality provided by the specific physical layer device (PHY or SerDes). For SerDes mode, the 82575 provides the complete 802.3z PCS function. For internal PHY mode, the PCS and Auto-Negotiation functions are maintained within the PHY. For SGMII mode, the 82575 supports the SGMII link Auto-Negotiation process, whereas the link Auto-Negotiation is done by the external SGMII PHY.

Configuration of the link can be accomplished by several methods ranging from software's forcing link settings, software-controlled negotiation, MAC-controlled auto-negotiation, to Auto-Negotiation initiated by a PHY. The following sections describe processes of bringing the link up including configuration of the 82575 and the transceiver as well as the various methods of determining duplex and speed configuration.

The process of determining link configuration differs slightly based on the specific link mode (internal PHY, external SerDes, SGMII) being used.

When operating in internal PHY mode, the PHY performs Auto-Negotiation per 802.3ab clause 40 and extensions to clause 28. Link resolution is obtained by the MAC from the PHY after the link has been established. The MAC accomplishes this via the MDIO interface, via specific signals from the internal PHY to the MAC or by MAC auto detection functions.

When operating in SGMII mode, the PCS layer performs SGMII Auto-Negotiation per the SGMII specification. The external PHY is responsible for the Ethernet auto-negotiation process.

### 9.3.1 SerDes Link Configuration

When using SerDes link mode, link mode configuration can be performed using the PCS function in the 82575. The hardware supports both hardware and software Auto-Negotiation methods for determining the link configuration as well as allowing for manually configuration to force the link. Hardware Auto-Negotiation is the preferred method.

#### 9.3.1.1 SerDes Mode Auto-Negotiation

In SerDes mode and at power up or reset via `GIO_PWR_GOOD`, the 82575 initiates Auto-Negotiation based on the default settings in the Device Control and Transmit Configuration or PCS Link Control Word registers as well as settings read from the EEPROM. If enabled in the EEPROM, the 82575 immediately performs Auto-Negotiation.

The 82575 fully supports the IEEE 802.3z Auto-Negotiation function when using the on-chip PCS and internal SerDes.

**Note:** Since speed for SerDes modes is fixed at 1000 Mb/s, speed settings in the Device Control register are unaffected by the Auto-Negotiation process.

There are two implementations accessible in the design:

1. A full hardware Auto-Negotiation implementation that does not require software intervention in order to successfully reach a negotiated link configuration.
2. Software driven negotiation.



A set of registers is provided to facilitate hardware Auto-Negotiation.

**Note:** Hardware Auto-Negotiation can be initiated at power up or assertion of GIO\_PWR\_GOOD by enabling specific bits in the EEPROM.

### 9.3.1.2 PCS Hardware Auto-Negotiation

Hardware supports negotiation of the link configuration per clause 37 of the 802.3z standard. This is accomplished by the exchange of /C/ ordered sets that contain the capabilities defined in the PCS\_ANADV register in the 3rd and 4th symbols of the ordered sets. Next page are supported using the PCS\_NPTX\_AN register.

Bits FD and LU of the Device Status register (STATUS), and bits in the PCS\_LSTS register provide status information regarding the negotiated link.

Auto-Negotiation can be initiated by the following:

- LRST transition from 1b to 0b
- PCS\_LCMD.AN\_ENABLE transition from 0b to 1b
- Receipt of /C/ ordered set during normal operation
- Receipt of different value of the /C/ ordered set during the negotiation process
- Transition from loss of synchronization to synchronized state (if AN\_ENABLE is set).
- PCS\_LCMD.AN\_RESTART transition from 0b to 1b

Resolution of the negotiated link determines 82575 operation with respect to flow control capability and duplex settings. These negotiated capabilities override advertised and software controlled 82575 configuration.

Software must configure the PCS\_ANADV fields to the desired advertised base page. The bits in the Device Control register are not mapped to the *txConfigWord* field in hardware until after Auto-Negotiation completes. The figures that follow show the mapping of the PCS\_ANADV fields to the Config\_reg Base Page encoding per clause 37 of the standard.

15	14	13:12	11:9	8:7	6	5	4:0
Nextp	ACK	RFLT	Rsv	ASM	HD	FD	Rsv
15	14	13:12	11:9	8:7	6	5	4:0
Nextp	ACK	RFLT	Rsv	ASM	HD	FD	Rsv

**Figure 26.** 802.3z Advertised Base Page Mapping

The partner advertisement can be seen in the PCS\_LPAB and PCS\_LPABNP registers.

### 9.3.1.3 Forcing Link

Forcing link can be accomplished by software writing a 1b to CTRL.SLU which forces the MAC PCS logic into a link up state (enables listening to incoming characters when LOS is de-asserted by the internal or external SerDes).

**Note:** The PCS\_LCMD.AN\_ENABLE bit must be set to logic 0b to enable for forcing link.

When link is forced via the CTRL.SLU bit, the link does not come up unless the LOS signal is de-asserted or an energy indication is received from the SerDes receiver, implying that



there is a valid signal being received by the optics or the SerDes. The source of the signal detect is a fixed bit (ENRGSRC) in register CONNSW.

An interrupt bit (RXCFG) has been added to the interrupt registers to flag software that the hardware is receiving configuration symbols (/C/ codes). Software should unmask (enable) this interrupt when forcing link. When the link is forced, the link partner can begin to Auto-Negotiate based due to a reset or enabling of Auto-Negotiation. The reception of /C/ codes causes an interrupt to software and the proper hardware configuration might be set.

### 9.3.1.4 Hardware Detection of Non-Auto-Negotiation Partner

Hardware can detect a SerDes partner that sends idle code groups continuously but do not initiate or answer to an auto-negotiation process. In this case, hardware initiates an auto-negotiation process, and if it fails after some timeout, a link up is assumed. To enable this functionality the PCS\_LCTL.AN\_TIMEOUT\_EN bit should be set.

### 9.3.1.5 SGMII Auto-Negotiation

SGMII protocol includes an auto-negotiation process in order to establish the MAC to PHY connection. This auto-negotiation process is not dependent on the SRDS0/1\_SIG\_DET signal, as this signal indicates the status of the PHY signal detection (usually used in Optical PHY).

The outcome of this auto-negotiation information process is as follows:

- Link status
- Speed
- Duplex

This information is used by hardware to configure the MAC when operating in SGMII mode.

Bits FD and LU of the Device Status register (STATUS) and bits in the PCS\_LSTS register provide status information regarding the negotiated link.

Auto-Negotiation may be initiated by the following:

- LRST transition from 1b to 0b
- PCS\_LCMD.AN\_ENABLE transition from 0b to 1b
- Receipt of /C/ ordered set during normal operation
- Receipt of different value of the /C/ ordered set during the negotiation process
- Transition from loss of synchronization to synchronized state (if AN\_ENABLE is set).
- PCS\_LCMD.AN\_RESTART transition from 0b to 1b

Resolution of the negotiated link determines 82575 operation with respect to speed and duplex settings. These negotiated capabilities override advertised and software controlled 82575 configuration.

When operating in SGMII mode, there is no need to set the PCAS\_ANADV register, as the MAC advertisement word is fixed. The result of the SGMII level auto-negotiation can be read from the PCS\_LPAB register.



## 9.3.2 Copper PHY Link Configuration

When operating with the internal PHY, link configuration is generally determined by PHY Auto-Negotiation. The software device driver must intervene in cases where a successful link is not negotiated or the programmer desires to manually configure the link. The following sections discuss the methods of link configuration for copper PHY operation.

### 9.3.2.1 PHY Auto-Negotiation (Speed, Duplex, and Flow Control)

When using a copper PHY, the PHY performs the Auto-Negotiation function. The actual operational details of this operation are described in the IEEE P802.3ab draft standard and are not included here.

Auto-Negotiation provides a method for two link partners to exchange information in a systematic manner in order to establish a link configuration providing the highest common level of functionality supported by both partners. Once configured, the link partners exchange configuration information to resolve link settings such as:

- Speed: 10/100/1000 Mb/s
- Duplex: Full- or Half-
- Flow Control Operation

PHY specific information required for establishing the link is also exchanged.

**Note:** If flow control is enabled in the 82575, the settings for the desired flow control behavior must be set by software in the PHY registers and Auto-Negotiation restarted. After Auto-Negotiation completes, the software device driver must read the PHY registers to determine the resolved flow control behavior of the link and reflect these in the MAC register settings (CTRL.TFCE and CTRL.RFCE).

Once PHY Auto-negotiation completes, the PHY asserts a link indication (LINK) to the MAC. Software must have set the *Set Link Up* bit in the Device Control Register (CTRL.SLU) before the MAC recognizes the LINK indication from the PHY and can consider the link to be up.

### 9.3.2.2 MAC Speed Resolution

For proper link operation, both the MAC and PHY must be configured for the same speed of link operation. The speed of the link can be determined and set by several methods with the 82575. These include:

- Software-forced configuration of the MAC speed setting based on PHY indications and can be determined as follows:
  - Software reads of PHY registers directly to determine the PHY's auto-negotiated speed
  - Software reads the PHY's internal PHY-to-MAC speed indication (SPD\_IND) using the MAC STATUS.SPEED register
  - Software signals the MAC to attempt to auto-detect the PHY speed from the PHY-to-MAC RX\_CLK, then programs the MAC speed accordingly
- MAC automatically detects and sets the link speed of the MAC based on PHY indications by using the PHY's internal PHY-to-MAC speed indication (SPD\_IND) and automatically setting the MAC speed.

#### 9.3.2.2.1 Forcing MAC Speed





There might be circumstances when the software device driver must forcibly set the link speed of the MAC. This occurs when the link is manually configured. To force the MAC speed, the software device driver must set the CTRL.FRCSPD (force-speed) bit to 1b and then write the speed bits in the Device Control register (CTRL.SPEED) to the desired speed setting. See [Section 14.3.1](#) for details.

**Note:** Forcing the MAC speed using CTRL.FRCSPD overrides all other mechanisms for configuring the MAC speed and can yield non-functional links if the MAC and PHY are not operating at the same speed/configuration.

When forcing the 82575 to a specific speed configuration, the software device driver must also ensure the PHY is configured to a speed setting consistent with MAC speed settings. This implies that software must access the PHY registers to either force the PHY speed or to read the PHY status register bits that indicate link speed of the PHY.

**Note:** The forcing of the speed settings by CTRL.SPEED can also be accomplished by setting the CTRL\_EXT.SPD\_BYSPS bit. This bit bypasses the MAC's internal clock switching logic and gives the software device driver complete control over when the speed setting takes place. The CTRL.FRCSPD bit uses the MAC's internal clock switching logic which does delay the affect of the speed change.

#### 9.3.2.2 Using Internal PHY Direct Link-Speed Indication

The 82575's internal PHY provides a direct internal indication of its speed to the MAC (SPD\_IND). When using the internal PHY, the most direct method for determining the PHY link speed and either manually or automatically configuring the MAC speed is based on these direct speed indications.

For MAC speed to be set/determined from these direct internal indications from the PHY, the MAC must be configured such that CTRL.ASDE and CTRL.FRCSPD are both 0b (both auto-speed detection and forced-speed override disabled). With the CTRL register configured, the MAC speed is reconfigured automatically each time the PHY indicates a new link-up event to the MAC.

When MAC speed is neither forced nor auto-sensed by the MAC, the current MAC speed setting and the speed indicated by the PHY is reflected in the Device Status register bits STATUS.SPEED.

#### 9.3.2.3 MAC Full/Half Duplex Resolution

The duplex configuration of the link is also resolved by the PHY during the Auto-Negotiation process. The 82575's internal PHY provides an internal indication to the MAC of the resolved duplex configuration using an internal full-duplex indication (FDX).

When using the internal PHY, this internal duplex indication is normally sampled by the MAC each time the PHY indicates the establishment of a good link (LINK indication). The PHY's indicated duplex configuration is applied in the MAC and reflected in the MAC Device Status register (STATUS.FD).

Software can override the duplex setting of the MAC via the CTRL.FD bit when the CTRL.FRCDPLX (force duplex) bit is set. If CTRL.FRCDPLX is 0b, the CTRL.FD bit is ignored and the PHY's internal duplex indication applied.

#### 9.3.2.4 Using PHY Registers

The software device driver might be required under some circumstances to read from, or write to, the MII management registers in the PHY. These accesses are performed via the MDIC registers. The MII registers enable the software device driver to have direct control over the PHY's operation which might include:





- Resetting the PHY
- Setting preferred link configuration for advertisement during the Auto-Negotiation process
- Restarting the Auto-Negotiation process
- Reading Auto-Negotiation status from the PHY
- Forcing the PHY to a specific link configuration

### 9.3.2.5 Comments Regarding Forcing Link

Forcing link in internal PHY mode requires the software driver to configure both the MAC and the PHY in a consistent manner with respect to each other as well as the link partner. After initialization, the software driver configures the desired modes in the MAC, then accesses the PHY MII registers to set the PHY to the same configuration.

Before enabling the link, the speed and duplex settings of the MAC can be forced by software using the CTRL.FRCDSPD, CTRL.FRCDPX, CTRL.SPEED, and CTRL.FD bits. After the PHY and MAC have both been configured, the software device driver should write a 1b to the CTRL.SLU bit.

## 9.3.3 Loss of Signal/Link Status Indication

For either internal PHY, SerDes or SGMII modes of operation, an LOS/LINK signal provides an indication of physical link status to the MAC. When the MAC is configured for Optical SerDes mode, the input reflects loss-of-signal connection from the optics. In backplane mode, where there is no LOS external indication, an internal indication from the SerDes receiver can be used. In SFP systems the LOS indication from the SFP can be used. In internal PHY mode, this signal from the PHY indicates whether the link is up or down; typically indicated after successful Auto-Negotiation. Assuming that the MAC has been configured with CTRL.SLU = 1b, the MAC status bit STATUS.LU, when read generally reflects whether the PHY or SerDes has link (except under forced-link setup where even the PHY link indication may have been forced).

When the link indication from the PHY is de-asserted (or the loss-of-signal asserted from the SerDes), the MAC considers this to be a transition to a link-down situation (for example, cable unplugged, loss of link partner, etc.). If the Link Status Change (LSC) interrupt is enabled, the MAC generates an interrupt to be serviced by the software device driver.

## 9.3.4 Flow Control

Flow control as defined in IEEE specification 802.3x, as well as the specific operation of asymmetrical flow control defined by 802.3z, are supported. The following registers are defined for the implementation of flow control:

**Table 80. Flow Control Registers**

Register Name	Description
CTRL.RFCE	Enables the reception of legacy flow control packets
CTRL.TFCE	Enables the transmission of legacy flow control packets
Flow Control Address Low, High (FCAL/H)	6-byte flow control multicast address
Flow Control Type (FCT)	16-bit field to indicate flow control type
Flow Control Receive Thresh Hi (FCRTH)	13-bit high water mark indicating receive buffer fullness

**Table 80. Flow Control Registers**

Flow Control Receive Thresh Lo (FCRTL)	13-bit low water mark indicating receive buffer emptiness
Flow Control Transmit Timer Value (FCTTV)	16 bit timer value to include in transmitted PAUSE frame
Flow Control Refresh Threshold Value (FCRTV)	16-bit PAUSE refresh threshold value

Flow control is implemented as a means of reducing the possibility of receive buffer overflows which result in the dropping of received packets, and allows for local control of network congestion levels. This can be accomplished by sending an indication to a transmitting station of a nearly-full receive buffer condition at a receiving station.

The implementation of asymmetric flow control allows for one link partner to send flow control packets while being allowed to ignore their reception. For example, not required to respond to PAUSE frames.

### 9.3.4.1 MAC Control Frames and Reception of Flow Control Packets

Three comparisons are used to determine the validity of a flow control frame:

1. A match on the 6-byte multicast address for MAC Control Frames or to the station address of the device (Receive Address Register 0).
2. A match on the type field.
3. A comparison of the MAC Control Opcode field.

Standard 802.3x defines the MAC Control Frame multicast address as 01\_80\_C2\_00\_00\_01h. This address must be loaded into the Flow Control Address Low/High registers (FCAL/H).

The Flow Control Type register (FCT) contains a 16-bit field that is compared against the flow control packet's type field to determine if it is a valid flow control packet: XON or XOFF. 802.3x reserves this value as 8808h. This number must be loaded into the Flow Control Type (FCT) register.

The final check for a valid PAUSE frame is the MAC Control Opcode. At this time only the PAUSE control frame opcode is defined. It has a value of 0001h.

Frame based flow control differentiates XOFF from XON based on the value of the PAUSE timer field. Non-zero values constitute XOFF frames while a value of zero constitutes an XON frame. Values in the timer field are in units of slot time. A "slot time" is hard wired to a 64-byte time or 512-bit time.

**Note:** An XON frame signals a pause cancellation from being initiated by an XOFF frame (Pause for zero slot times).

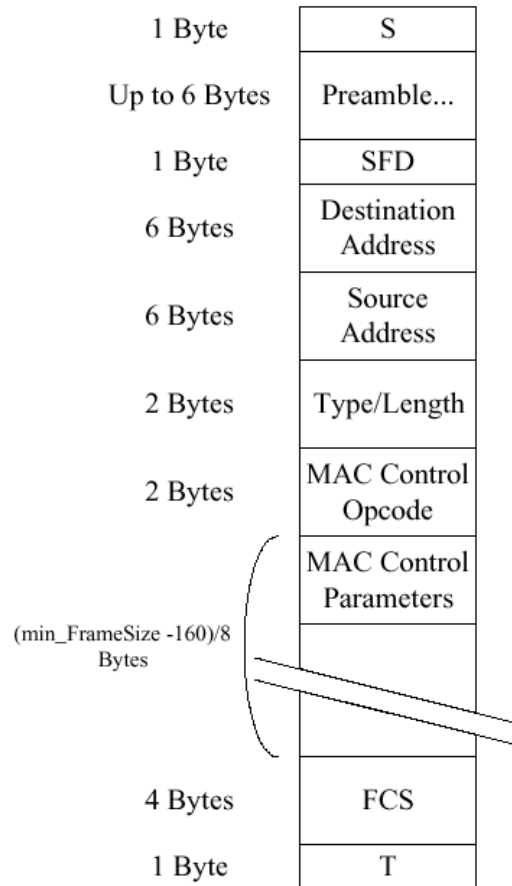

**Note:** "S" is the Start-of-Packet delimiter and "T" is the first part of the End-of-Packet delimiters for 802.3z encapsulation.

**Figure 27. 802.3x MAC Control Frame Format**

The receiver is enabled to receive flow control frames if flow control is enabled through the RFCE bit in the Device Control register (CTRL).

**Note:** Flow control capability must be negotiated between link partners via the Auto-Negotiation process. The Auto-Negotiation process can modify the value of these bits based on the resolved capability between the local device and the link partner.

Once the receiver has validated the reception of an XOFF, or PAUSE frame, the 82575 performs the following:

- Increment the appropriate statistics register(s)
- Set the TXOFF bit in the Device Status Register (STATUS)
- Initialize the pause timer based on the packet's PAUSE timer field
- Disable packet transmission or schedule the disabling of transmission after the current packet completes.



Resumption of transmission can occur under the following conditions:

- Expiration of the PAUSE timer
- Reception of on XON frame (a frame with its PAUSE timer set to 0b)

Either condition clears the TXOFF status bit in the Device Status Register and transmission might resume. Hardware records the number of received XON frames.

**Note:** When flow control reception is disabled (CTRL.RFCE = 0b), flow control packets are not recognized and are parsed as regular packets.

### 9.3.5 Discard PAUSE Frames and Pass MAC Control Frames

Two bits in the Receive Control register (RCTL) are implemented specifically for control over receipt of PAUSE and MAC control frames. These bits are Discard PAUSE Frames (DPF) and Pass MAC Control Frames (PMCF). See [Section 14.3.47](#) for DPF and PMCF bit definitions.

The DPF bit forces the discarding of any valid PAUSE frame addressed to the 82575's station address. If the packet is a valid PAUSE frame and is addressed to the station address (receive address [0]), the 82575 does not pass the packet to host memory if the DPF bit is set to logic high. When DPF is cleared to 0b, a valid flow control packet is transferred via DMA. This bit has no affect on PAUSE operation, only the DMA function.

The PMCF bit allows for the passing of any valid MAC control frames to the system which do not have a valid PAUSE opcode. In other words, the frame can have the correct MAC control frame multicast address (or the MAC station address) as well as the correct type field match with the FCT register, but does not have the defined PAUSE opcode of 0001h. Frames of this type are transferred to host memory when PMCF is logic high.

### 9.3.6 Transmission of PAUSE Frames

Transmitting PAUSE frames is enabled by software writing a 1b to the CTRL.TFCE bit.

Similar to the reception flow control packets described earlier, XOFF packets can be transmitted only if this configuration has been negotiated between the link partners via the Auto-Negotiation process. In other words, the setting of this bit indicates the desired configuration.

The content of the Flow Control Receive Threshold High register determines at what point hardware first transmits a PAUSE frame. Hardware monitors the fullness of the receive FIFO and compares it with the contents of FCRTN. When the threshold is reached, hardware sends a PAUSE frame with its pause time field equal to FCTTV.

At this time, hardware starts counting an internal shadow counter (reflecting the pause timeout counter at the partner end) from zero. When the counter reaches the value indicated in FCRTV register, then, if the PAUSE condition is still valid (meaning that the buffer fullness is still above the low watermark), an XOFF message is sent again.

Once the receive buffer fullness reaches the low water mark, hardware sends an XON message (a PAUSE frame with a timer value of 0). Software enables this capability with the XONE field of the FCRTL.



Hardware sends a PAUSE frame if it has previously sent one and the FIFO overflows even if the refresh timer did not expire. This minimizes the amount of packets dropped if the first PAUSE frame did not reach its target. Since the manageability receive packets use the same data path, the behavior is identical when manageability packets are received.

**Note:** Transmitting Flow Control frames should only be enabled in full duplex mode per the IEEE 802.3 standard. Software should ensure that the transmission of flow control packets is disabled when the 82575 is operating in half-duplex mode.

### 9.3.7 Software Initiated PAUSE Frame Transmission

The 82575 has the added capability to transmit an XOFF frame through software. This function is accomplished by software writing a 1b to the SWXOFF bit of the Transmit Control register (TCTL). Once this bit is set, hardware initiates the transmission of a PAUSE frame in a manner similar to that automatically generated by hardware.

The SWXOFF bit is self clearing after the PAUSE frame has been transmitted. Note that the Flow Control Refresh Threshold mechanism does not work in case of software-initiated flow control. As a result, it is software's responsibility to re-generate PAUSE frames before expiration of the pause counter at the other partner's end.

The state of the CTRL.TFCE bit or the negotiated flow control configuration does not affect software generated PAUSE frame transmission.

**Note:** Software sends an XON frame by programming a 0b in the PAUSE timer field of the FCTTV register. The software emission of XON packet is not allowed while the hardware flow control mechanism is active, as both use the FCTIV registers for different purposes.

- XOFF transmission is not supported in 802.3x for half duplex links. Software should not initiate an XOFF or XON transmission if the 82575 is configured for half duplex operation.
- When flow control is disabled, pause packets (XON/XOFF/other FC) are not detected as Flow Control packets and can be counted in all kinds of counters (for example, multicast).

## 9.4 Loopback Support

The 82575 supports four types of loopback in the LAN interfaces:

- MAC Loopback (Point 1)
- Internal PHY Loopback (Point 2)
- Internal SerDes Loopback (Point 3)
- External PHY Loopback (Point 4)

By setting the 82575 to loopback mode, packets that are transmitted towards the line are looped back to the host. The 82575 is fully functional in these modes, just not transmitting data over the lines.

Figure 28 shows the points of loopback.

**Note:** For more details about loopback usage and test setup, refer to the *Intel® Ethernet Controllers Loopback Modes* application note.

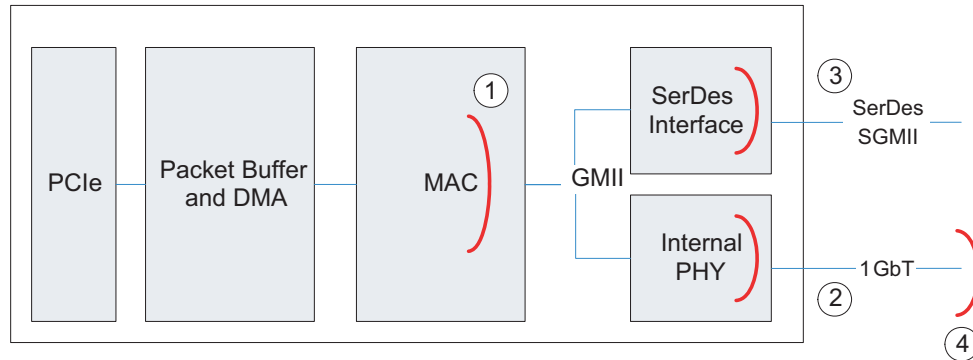

Figure 28. 82575 Loopback Modes

## 9.4.1 MAC Loopback

In MAC loopback, the PHY and SerDes blocks are not functional and data is looped back before these blocks. MAC loopback is operational only when operating in PHY mode (`CTRL_EXT.LINK_MODE = 00b`).

### 9.4.1.1 Setting the 82575 to MAC Loopback Mode

The following procedure should be used to place the 82575 in MAC loopback mode:

- Set `RCTL.LBM` to 01b (bits 7:6)
- Set `CTRL.SLU` (bit 6; should be set by default)
- Set `CTRL.FRCDPLX` and `FRCDPLX` (bits 11 and 12)
- Set `CTRL.SPEED` to 10b (1 Gb/s) and `CTRL.FD`
- Set `CTRL.ILOS`.

Filter configuration and other TX/RX processes are as the same as in normal mode.

**Note:** This configuration can be used when there is no link in the PHY. If there is a link then the `ILOS` bit should be cleared.

## 9.4.2 Internal PHY Loopback

In internal PHY loopback, the SerDes block is not functional and data is looped back at the end of the PHY functionality. This means that the only design that is functional in copper mode is involved in the loopback.

### 9.4.2.1 Setting the 82575 to Internal PHY Loopback Mode

The following procedure should be used to put the 82575 in internal PHY loopback mode:

- Set Link mode to PHY: `CTRL_EXT.LINK_MODE` (`CSR 18h`, bits 23:22) = 00b
- In the PHY control register (address 0 in the PHY):
  - Set duplex mode (bit 8)



- Clear the *Loopback* bit (bit 14)
- Set the *Auto Neg Enable* bit (bit 12)
- Register values should be:
  - a. For 10 Mb/s 4100h.
  - b. For 100 Mb/s 6100h.
  - c. For 1000 Mb/s 4140h.
  - d. In the Port Control register, address 16 (10h) in the PHY, set bit 14 (*Link Disable*). This is not required for 1 Gb/s but required for 10/100 Mb/s.

### 9.4.3 Internal SerDes Loopback

In internal SerDes loopback, the PHY block is not functional and data is looped back at the end of the SerDes functionality. This means that the only design that is functional in SerDes/SGMII mode is involved in the loopback.

#### 9.4.3.1 Setting Internal SerDes Loopback Mode

The following procedure should be used to put the 82575 in SerDes loopback mode:

- Set link mode to SerDes: CTRL\_EXT.LINK\_MODE (CSR 18h, bits 23:22) = 11b
- Configure the SerDes (register 4, bit 1) to loopback: write to SERDESCTL (CSR 00024h) the value 410h
- Move to force mode by setting the following bits:
  - CTRL.FD (CSR 0h, bit 0) = 1b
  - CTRL.SLU (CSR 0h, bit 6) = 1b
  - CTRL.RFCE (CSR 0h, bit 27) = 0b
  - CTRL.TFCE (CSR 0h, bit 28) = 0b
  - CTRL.LRST (CSR 0h, bit 3) = 0b
  - PCS\_LCTL.FORCE\_LINK (CSR 04208h, bit 5) = 1b
  - PCS\_LCTL.FSD (CSR 04208h, bit 4) = 1b
  - PCS\_LCTL.FDV (CSR 04208h, bit 3) = 1b
  - PCS\_LCTL.FLV (CSR 04208h, bit 0) = 1b
  - PCS\_LCTL.AN\_ENABLE (CSR 04208h, bit 16) = 0b
  - CONNSW.ENRGSRC (CSR 00034h, bit 2) = 0b

### 9.4.4 External PHY Loopback

In external PHY loopback, the SerDes block is not functional and data is sent through the MDI interface and looped back using an external loopback plug. This means that the only design that is functional in copper mode is involved in the loopback. If connected at 10/100 Mb/s, the loopback operates without any special setup.



#### 9.4.4.1 Setting External PHY Loopback Mode

The following procedure should be used to put the 82575 in external PHY loopback mode:

- Set Link mode to PHY: CTRL\_EXT.LINK\_MODE (CSR 18h, bits 23:22) = 00b
- In the PHY control register (address 0 in the PHY):
  - Set duplex mode (bit 8)
  - Clear the *Loopback* bit (bit 14)
  - Set the *Auto Neg Enable* bit (bit 12)
- Restart auto-negotiation (set bit 19)
- Reset the PHY (set bit 15)
- Wait for auto-negotiation to complete and then transmit and receive normally.

§ §





## 10.0 802.1q VLAN Support

The 82575 provides several specific mechanisms to support 802.1q VLANs:

- Optional adding (for transmits) and stripping (for receives) of IEEE 802.1q VLAN tags
- Optional ability to filter packets belonging to certain 802.1q VLANs

### 10.1 802.1q VLAN Packet Format

Table 81 compares an untagged 802.3 Ethernet packet with an 802.1q VLAN tagged packet.

**Table 81. VLAN Packet Format Comparison**

802.3 Packet	#Octets	802.1q VLAN Packet	#Octets
DA	6	DA	6
SA	6	SA	6
Type/Length	2	802.1q Tag	4
Data	46-1500	Type/Length	2
CRC	4	Data	46-1500
		CRC*	4

**Note:** The CRC for the 802.1q tagged frame is re-computed so that it covers the entire tagged frame including the 802.1q tag header. Also, max frame size for an 802.1q VLAN packet is 1522 octets as opposed to 1518 octets for a normal 802.3z Ethernet packet.

#### 10.1.1 802.1q Tagged Frames

For 802.1q, the Tag Header field consists of four octets comprised of the Tag Protocol Identifier (TPID) and Tag Control Information (TCI), each taking 2 octets. The first 16 bits of the tag header make up the TPID. It contains the “protocol type” which identifies the packet as a valid 802.1q tagged packet.

The two octets making up the TCI contain three fields (see Table 82 for details):

- User Priority (UP)
- Canonical Form Indicator (CFI). The CFI should be 0b for transmits. For receives, the 82575 has the capability to filter out packets that have this bit set. See the CFIEN and CFI bits in the RCTL as described in Section 14.3.47.
- VLAN Identifier (VID)



**Table 82. 802.1q Tagged Frames**

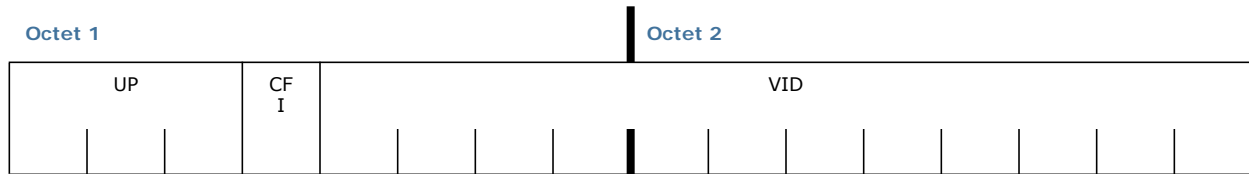

## 10.2 Transmitting and Receiving 802.1q Packets

Since the 802.1q tag is only four bytes, adding and stripping of tags can be done completely in software. (For transmits, software inserts the tag into packet data before it builds the transmit descriptor list, and for receives, software strips the four byte tag from the packet data before delivering the packet to upper layer software.)

However, because adding and stripping of tags in software results in more overhead for the host, the 82575 has additional capabilities to add and strip tags in hardware, as discussed in the following two sections.

### 10.2.1 Adding 802.1q Tags on Transmits

Software might command the 82575 to insert an 802.1q VLAN tag on a per packet or per flow basis. If CTRL.VME is set to 1b, and the VLE bit in the transmit descriptor is set to 1b, then the 82575 inserts a VLAN tag into the packet that it transmits over the wire. The *Tag Protocol Identifier (TPID)* field of the 802.1q tag comes from the VET register. 802.1q tag insertion is done in different ways for legacy and advanced Tx descriptors:

- Legacy Transmit Descriptors: The Tag Control Information (TCI) of the 802.1q tag comes from the VLAN field (Section 5.3.3.5) of the descriptor. Refer to Table 83 for more on hardware insertion of tags for transmits.

**Table 83. VLAN Tag Insertion Decision Table**

VLE	Action
0b	Send generic Ethernet packet.
1b	Send 802.1Q packet; the Ethernet <i>Type</i> field comes from the VET register and the VLAN data comes from the VLAN field of the TX descriptor;

**Note:** This table is relevant only if VMVIR.VLANA = 00b (use descriptor command) for the queue.

- Advanced Transmit Descriptor: The Tag Control Information (TCI) of the 802.1q tag comes from the VLAN *Tag* field (Section 5.3.3.5) of the advanced context descriptor. The *IDX* field of the advanced Tx descriptor should be set to the adequate context can result in unexpected behavior.



## 10.2.2 Stripping 802.1q Tags on Receives

Software can instruct the 82575 to strip 802.1q VLAN tags from received packets. If the CTRL.VME bit is set to 1b, and the incoming packet is an 802.1q VLAN packet (its Ethernet Type field matched the VET register), then the 82575 strips the 4-byte VLAN tag from the packet, and stores the TCI in the Special field of the receive descriptor.

The 82575 also sets the VP bit in the receive descriptor to indicate that the packet had a VLAN tag that was stripped. If the CTRL.VME bit is not set, the 802.1Q packets can still be received if they pass the receive filter. In this case, the VLAN tag is not stripped and the VP bit is not set. Refer to [Table 84](#) for more information regarding receive packet filtering.

## 10.3 802.1q VLAN Packet Filtering

VLAN filtering is enabled by setting the RCTL.VFE bit to 1b. If enabled, hardware compares the type field of the incoming packet to a 16-bit field in the VLAN EtherType (VET) register. If the VLAN type field in the incoming packet matches the VET register, the 802.1q VLAN packet is then compared against the VLAN Filter Table Array for acceptance.

The Virtual LAN ID field indexes a 4096 bit vector. If the indexed bit in the vector is 1b, there is a Virtual LAN match. Software can set the entire bit vector to 1b's if the node does not implement 802.1q filtering.

In summary, the 4096 bit vector is comprised of 128 32-bit registers. The VLAN Identifier (VID) field consists of 12 bits. The upper 7 bits of this field are decoded to determine the 32-bit register in the VLAN Filter Table Array to address and the lower 5 bits determine which of the 32 bits in the register to evaluate for matching.

Two other bits in the Receive Control register (see [Section 14.3.47](#)), CFIEN and CFI, are also used in conjunction with 802.1q VLAN filtering operations. CFIEN enables the comparison of the value of the CFI bit in the 802.1q packet to the Receive Control register CFI bit as an acceptance criteria for the packet.

[Table 84](#) lists reception actions according to control bit settings.

**Note:** The VFE bit does not affect whether the VLAN tag is stripped. It only affects whether the VLAN packet passes the receive filter.

A packet is defined as a VLAN/802.1q packet if its type field matches the VET.



Table 84. Packet Reception Decision Table

Is packet 802.1q?	CTRL. VME	RCTL. VFE	Action
No	X	X	Normal packet reception.
Yes	0	0	Receive a VLAN packet if it passes the standard filters (only). Leave the packet as received in the data buffer. Clear the VP bit in the receive descriptor.
Yes	0	1	Receive a VLAN packet if it passes the standard filters and the VLAN filter table. Leave the packet as received in the data buffer (the VLAN tag is not stripped). Clear the VP bit in the receive descriptor.
Yes	1	0	Receive a VLAN packet if it passes the standard filters (only). Strip off the VLAN information (four bytes) from the incoming packet and store in the descriptor. Set the VP bit in the receive descriptor.
Yes	1	1	Receive a VLAN packet if it passes the standard filters and the VLAN filter table. Strip off the VLAN information (four bytes) from the incoming packet and store in the descriptor. Set the VP bit in the receive descriptor.

## 10.4 Double VLAN Support

The 82575 supports a mode where all received and sent packet have at least one VLAN tag in addition to the regular tagging which may optionally be added. This mode is used for systems where the switches add an additional tag containing switching information.

When a port of the 82575 is working in this mode, the 82575 assumes that all packets received or sent to this port have at least one VLAN, including packet received or sent on the NC-SI interface.

One exception to this rule are flow control PAUSE packets which are not expected to have any VLAN.

Insertion or stripping of VLAN is done on the second VLAN if it exists. All the filtering functions of the 82575 (Rx filtering) ignores the first VLAN in this mode.

This mode is activated by setting CTRL\_EXT.EXTENDED\_VLAN bit. The default of this bit is set according to bit 1 in word 24h/14h of the EEPROM for ports 0 and 1, respectively.

The type of the VLAN tag used for the additional VLAN is defined in the VET.VET\_EXT field.

The Rx filter detects the presence of this VLAN and indicates it in the RDESC.STATUS.VEXT bit.

§ §

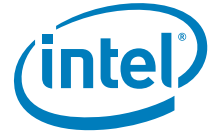

## 11.0 PHY Functionality and Features

---

The PHY default configuration is determined by data from the EEPROM, read right after power-on reset.

### 11.1 Auto MDIO Register Initialization

The 82575 PHYs support an option for automatically initializing MDIO registers with values from EEPROM/ROM, in case defaults in hardware are not adequate. In the 82575, this is performed by firmware.

There are two types of register initialization:

1. General register initialization - any register in a PHY can be initialized.
2. Customer visible mirror bit initialization - there are some bits in PHY that are a mirror of a customer visible EEPROM bits (PHY register 25 bits 3:0 and 6 and PHY register 26 bit 0).

After any PHY reset (power down included), a PHY needs to be initialized.

The register initialization is done by the firmware through the MAC/PHY MDIO interface (MDIC).

#### 11.1.1 General Register Initialization

A block of data is allocated in EEPROM/ROM. This block holds register addresses and data in MDIC format.

Each time a PHY reset ends, this block is read from EEPROM /ROM (first from ROM then from EEPROM) by firmware and is written to the PHY registers through the MDIC register and MDIO interface.

#### 11.1.2 Visible Mirror Bit Initialization

There are a number of visible bits that reside in the EEPROM/MAC control registers that have a mirror bit in the PHY registers. These bits are also updated by firmware after every PHY reset.

These bits are updated after the General Register initialization and through a read modify write sequence.

The current visible mirror bits are in PHY register 25 (bits 3:0 and bit 6) and PHY register 26 (bit 0).

The PHY might perform some low level initialization such as DSP configuration based on EEPROM settings. The details of those initialization are beyond the scope of this Software Developers Manual.

## 11.2 Determining Link State

The PHY and its link partner determine the type of link established through one of three methods:

- Auto-Negotiation
- Parallel Detection
- Forced Operation

Auto-Negotiation is the only method allowed by the 802.3ab standard for establishing a 1000BASE-T link, although forced operation method could be used for test purposes. For 10/100 links, any of the three methods can be used. The sections that follow discuss each in greater detail.

Figure 29 provides an overview of link establishment. First the PHY checks if Auto-Negotiation is enabled. By default, the PHY supports Auto-Negotiation (PHY register 0, bit 12). If not, the PHY forces operation as directed. If Auto-Negotiation is enabled, the PHY begins transmitting Fast Link Pulses (FLPs) and receiving FLPs from its link partner. If FLPs are received by the PHY, Auto-Negotiation proceeds. It also can receive 100BASE-TX MLT3 and 10BASE-T Normal Link Pulses (NLPs). If either MLT3 or NLPs are received, it aborts FLP transmission and immediately brings up the corresponding half-duplex link.

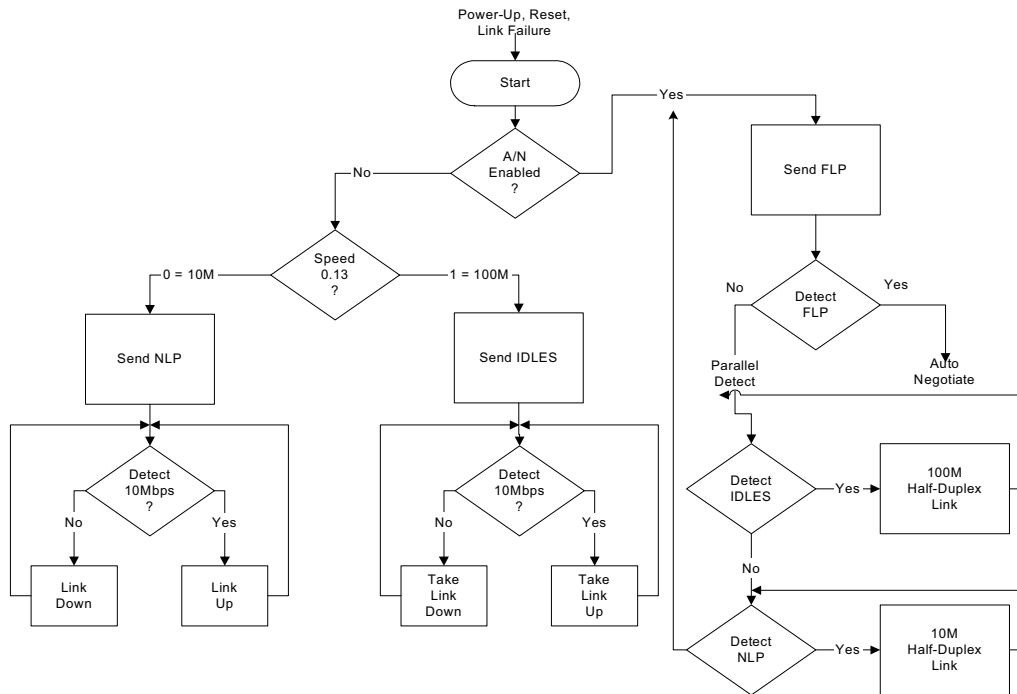

Figure 29. Overview of Link Establishment

### 11.2.1 False Link

The PHY does not falsely establish link with a partner operating at a different speed. For example, the PHY does not establish a 1000 Mb/s or 10 Mb/s link with a 100 Mb/s link partner.



When the PHY is first powered on, reset, or encounters a link down state, it must determine the line speed and operating conditions to use for the network link.

The PHY first checks the MDIO registers (initialized via the Hardware Control Interface or written by software) for operating instructions. Using these mechanisms, programmers can command the PHY to do one of the following:

- Force twisted-pair link operation to:
  - 1000-T Full Duplex
  - 1000-T Half Duplex
  - 100-TX, Full Duplex
  - 100-TX, Half Duplex
  - 10BASE-T, Full Duplex
  - 10BASE-T, Half Duplex
- Allow Auto-Negotiation/parallel-detection.

In the first six cases (forced operation), the PHY immediately begins operating the network interface as commanded. In the last case, the PHY begins the Auto-Negotiation/parallel-detection process.

## 11.2.2 Forced Operation

Forced operation can be used to establish 10 and 100 links, and 1000 links for test purposes. In this method, Auto-Negotiation is disabled completely and the link state of the PHY is determined by PHY register 0d.

**Note:** When speed is forced, the MDI/MDI-X crossover feature is not functional.

In forced operation, the programmer sets the link speed (10, 100, or 1000) and duplex state (full or half). For Gigabit (1000) links, the programmer must explicitly designate one side as the Master and the other as the Slave. [Table 85](#) summarizes link establishment procedures.

**Table 85. Determining Duplex State Via Parallel Detection**

Configuration	Result
Both sides set for Auto-Negotiate.	Link is established via Auto-Negotiation.
Both sides set for forced operation.	No problem as long as duplex settings match.
One side set for Auto-Negotiation and the other for forced, half-duplex.	Link is established via parallel detect.
One side set for Auto-Negotiation and the other for forced full-duplex.	Link is established; however, sides disagree, resulting in transmission problems. Forced side is full-duplex, Auto-Negotiation side is half-duplex.

## 11.2.3 Auto Negotiation

The PHY supports the IEEE 802.3u Auto-Negotiation scheme with next page capability. Next Page exchange uses PHY register 7d to send information and PHY register 8d to receive them. Next Page exchange can only occur if both ends of the link advertise their ability to exchange Next Pages.



## 11.2.4 Parallel Detection

Parallel detection can only be used to establish 10 and 100 links. It occurs when the PHY tries to negotiate (transmit FLPs to its link partner), but instead of sensing FLPs from the link partner, it senses 100BASE-TX MLT3 code or 10BASE-T Normal Link Pulses (NLPs) instead. In this case, the PHY immediately stops Auto-Negotiation (terminates transmission of FLPs) and immediately brings up whatever link corresponds to what it has sensed (MLT3 or NLPs). If the PHY senses both of the technologies together, a parallel detection fault is detected and the PHY continues sending FLPs

With parallel detection, it is impossible to determine the true duplex state of the link partner, and the IEEE standard requires the PHY to assume a half-duplex link. Parallel detection also does not allow exchange of flow-control ability (PAUSE and ASM\_DIR) or Master/Slave relationship required by 1000BASE-T. For this reason, parallel detection cannot be used to establish Gigabit Ethernet links.

## 11.2.5 Auto Cross-Over

Twisted pair Ethernet PHY's must be correctly configured for MDI or MDI-X operation to interoperate. The PHY supports the automatic MDI/MDI-X configuration originally developed for 1000Base-T and standardized in IEEE 802.3u section 40. Manual (non-automatic) configuration is still possible.

For 1000BASE-T links, pair identification is determined automatically in accordance with the standard.

For 10/100 links and during auto-negotiation, pair usage is determined by bits 12 and 13 in the PHY Port Control Register (18d).

In addition, the PHY has an Automatic Crossover Detection function. If bit 12 in PHY register 18d = 1b, the PHY automatically detects which application is being used and configures itself accordingly.

### 11.2.5.1 Support for Different Board Layouts

In order to support different board layouts, the 82575 supports an internal flip of the lanes.

The following table lists the logical assignment of the physical lanes in each mode:

	Flip Chip	Non-Flip Chip
MDI Mode	A → d B → c C → b D → a	A → a B → b C → c D → d
MDI-X Mode	A → c B → d C → a D → b	A → b B → a C → d D → c

The default mode is non-flip chip and auto-MDI-X. For example, MDI or MDI-X mode is set during the auto-negotiation process (as described in IEEE 802.3, section 40.4.4 Automatic MDI/MDI-X Configuration).





## 11.3 Link Criteria

Once the link state is determined—via Auto-Negotiation, parallel detection or forced operation— the PHY and its link partner bring up the link.

### 11.3.1 1000BASE-T

For 1000BASE-T links, the PHY and its link partner enter a training phase. They exchange idle symbols and use the information gained to set their adaptive filter coefficients.

Either side indicates completion of the training phase to its link partner by changing the encoding of the idle symbols it transmits. When both sides so indicate, the link is up. Each side continues sending idle symbols whenever it has no data to transmit. The link is maintained as long as valid idle or data symbols are received.

### 11.3.2 100BASE-TX

For 100BASE-TX links, the PHY and its link partner immediately begin transmitting idle symbols. Each side continues sending idle symbols whenever it has no data to transmit. The link is maintained as long as valid idle symbols or data is received.

In 100 Mb/s mode, the PHY establishes a link whenever the scrambler becomes locked and remains locked. Link will remain up unless the descrambler receives idles at less than a specified rate.

### 11.3.3 10BASE-T

For 10BASE-T links, the PHY and its link partner begin exchanging Normal Link Pulses (NLPs). The PHY transmits an NLP every 16 ms, and expects to receive one every 10 to 20 ms. The link is maintained as long as normal link pulses are received.

## 11.4 Link Enhancements

The PHY offers two enhanced link functions, each of which are discussed in the sections that follow:

- SmartSpeed
- Flow Control

### 11.4.1 SmartSpeed

SmartSpeed is an enhancement to auto-negotiation that enables the PHY to react intelligently to network conditions that prohibit establishment of a 1000BASE-T link, such as cable problems. Such problems might allow auto-negotiation to complete, but then inhibit completion of the training phase. Normally, if a 1000BASE-T link fails, the PHY returns to the auto-negotiation state with the same speed settings indefinitely. With SmartSpeed enabled, after a configurable number (1-5, PHY Register 27d bits 8:6) of failed attempts, the PHY automatically downgrades the highest ability it advertises to the next



lower speed: from 1000 to 100 to 10. Once a link is established, and if it is later broken, the PHY automatically upgrades the capabilities advertised to the original setting. This allows the PHY to automatically recover once the cable plant is repaired.

### 11.4.1.1 Using SmartSpeed

SmartSpeed is enabled by setting PHY register 16d, bit 7 to 1b. When SmartSpeed downgrades the PHY advertised capabilities, it sets bit 5 of PHY register 19. When link is established, its speed is indicated in PHY register 17, bits 15:14. SmartSpeed automatically resets the highest-level Auto-Negotiation abilities advertised, if link is established and then lost for more than two seconds.

### 11.4.2 Flow Control

Flow control enables congested nodes to pause traffic. MACs indicate their ability to implement flow control during Auto-Negotiation.

The PHY transparently supports MAC-to-MAC advertisement of flow control through its Auto-Negotiation process. Prior to Auto-Negotiation, the MAC indicates its flow control capabilities via PHY register 4d, bit 10 (Pause) and PHY register 4d, bit 11 (ASM\_DIR). After Auto-Negotiation, the link partner’s flow control capabilities are indicated in PHY register 5d, bits 11:10.

Table 86 lists the intended operation for the various settings of ASM\_DIR and Pause. This information is provided for reference only; it is the responsibility of the MAC to implement the correct function. The PHY merely enables the two MACs to communicate their abilities to each other.

**Table 86. Pause And Asymmetric Pause Settings**

ASM_DIR Settings Local (PHY Register 4d, Bit 10) and Remote (PHY Register 5d, Bit 10)	Pause Setting - Local (PHY Register 4d, Bit 9)	Pause Setting - Remote (PHY Register 5d, Bit 9)	Result
Both ASM_DIR = 1b	1b	1b	Symmetric - Either side can flow control the other
	1b	0b	Asymmetric - Remote can flow control local only
	0b	1b	Asymmetric - Local can flow control remote
	0b	0b	No flow control
Either or both ASM_DIR = 0b	1b	1b	Symmetric - Either side can flow control the other
	Either or both = 0b		No flow control



## 11.5 Management Data Interface

The PHY supports the IEEE 802.3 MII Management Interface also known as the Management Data Input/Output (MDIO) Interface. The MDIO interface consists of a physical connection to the MAC, a specific protocol which runs across the connection, and a 16-bit MDIO register set.

PHY Registers 0d through 10d and 15d are required and their functions are specified by the IEEE 802.3 specification. Additional registers are included for expanded functionality.

## 11.6 Low Power Operation

The 82575 can be get into a low-power state according to MAC control (Power Management controls) or via PHY register 0d. In either power down mode, the 82575 is not capable of receiving or transmitting packets.

## 11.7 Power Down via the PHY Register

The PHY can be powered down using the control bit found in PHY register 0d, bit 11. This bit powers down a significant portion of the port but clocks to the register section remain active. This enables the PHY management interface to remain active during power-down. The power-down bit is active high. When the PHY exits software power-down (PHY register 0d, bit 11 = 0b), it re-initializes all analog functions, but retains its previous configuration settings.

## 11.8 1000 Mb/s Operation

This section provides an overview of 1000BASE-T functions, followed by discussion and review of the internal functional blocks shown in [Figure 30](#).

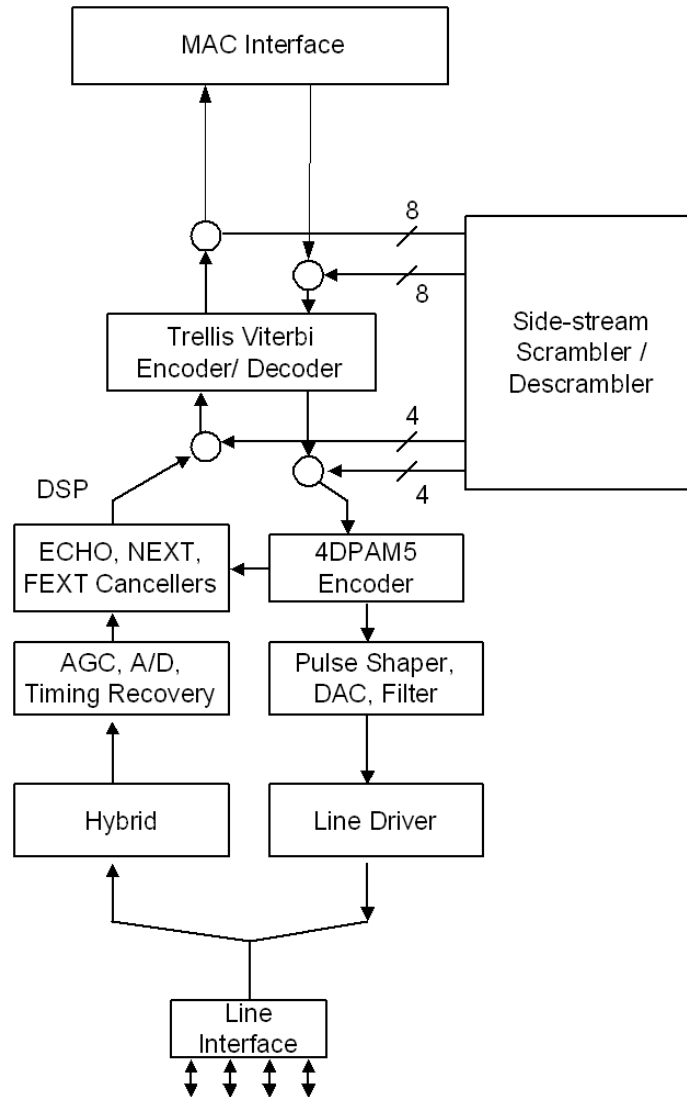

Figure 30. 1000 Base-T PHY Functions Overview

## 11.8.1 Transmit Functions

This section describes functions used when the Media Access Controller (MAC) transmits data through the PHY and out onto the twisted-pair connection.

### 11.8.1.1 Scrambler

The scrambler randomizes the transmitted data. The purpose of scrambling is two fold:

1. Scrambling eliminates repeating data patterns from the 4DPAM5 waveform to reduce EMI.



2. Each channel (A, B, C, D) gets a unique signature that the receiver uses for identification.

The scrambler is driven by a Linear Feedback Shift Register (LFSR), which is randomly loaded at power-up. The LFSR function used by the Master differs from that used by the Slave, giving each direction its own unique signature. The LFSR, in turn, generates uncorrelated outputs. These outputs randomize the inputs to the 4DPAM5 and Trellis encoders and randomize the sign of the 4DPAM5 outputs.

## 11.8.2 Transmit FIFO

The transmit FIFO re-synchronizes data transmitted by the MAC to the transmit reference used by the PHY.

### 11.8.2.1 Transmit Phase-Locked Loop PLL

This function generates the 125 MHz timing reference used by the PHY to transmit 4DPAM5 symbols. When the PHY is the Master side of the link, the crystal input is the reference for the transmit PLL. When the PHY is the Slave side of the link, the recovered receive clock is the reference for the transmit PLL.

### 11.8.2.2 Trellis Encoder

The Trellis Encoder uses the two high-order bits of data and its previous output to generate a ninth bit, which determines if the next 4DPAM5 pattern should be even or odd. This function provides forward error correction and enhances the signal-to-noise (SNR) ratio by a factor of 6 dB.

### 11.8.2.3 4DPAM5 Encoder

The 4DPAM5 encoder translates 8B codes transmitted by the MAC into 4DPAM5 symbols. The encoder operates at 125 Mhz, which is both the frequency of the MAC interface and the baud rate used by 1000BASE-T.

Each 8B code represents one of 256 data patterns. Each 4DPAM5 symbol consists of one of five signal levels (-2,-1,0,1,2) on each of the four twisted pair (A,B,C,D) representing  $5^4$  or 625 possible patterns per baud period. Of these, 113 patterns are reserved for control codes, leaving 512 patterns for data. These data patterns are divided into two groups of 256 even and 256 odd data patterns. As a result, each 8B octet has two possible 4DPAM5 representations—one even and one odd pattern.

### 11.8.2.4 Spectral Shaper

This function causes the 4DPAM5 waveform to have a spectral signature that is very close to that of the MLT3 waveform used by 100BASE-TX. This enables 1000BASE-T to take advantage of infrastructure (cables, magnetics) designed for 100BASE-TX.

The shaper works by transmitting 75% of a 4DPAM5 code in the current baud period, and adding the remaining 25% into the next baud period.

### 11.8.2.5 Low-Pass Filter

To aid with EMI, this filter attenuates signal components more than 180 Mhz. In 1000BASE-T, the fundamental symbol rate is 125 Mhz.

### 11.8.2.6 Line Driver

The line driver drives the 4DPAM5 waveforms onto the four twisted-pair channels (A, B, C, D), adding them onto the waveforms that are simultaneously being received from the link partner.

### 11.8.2.7 Transmit/Receive Flow

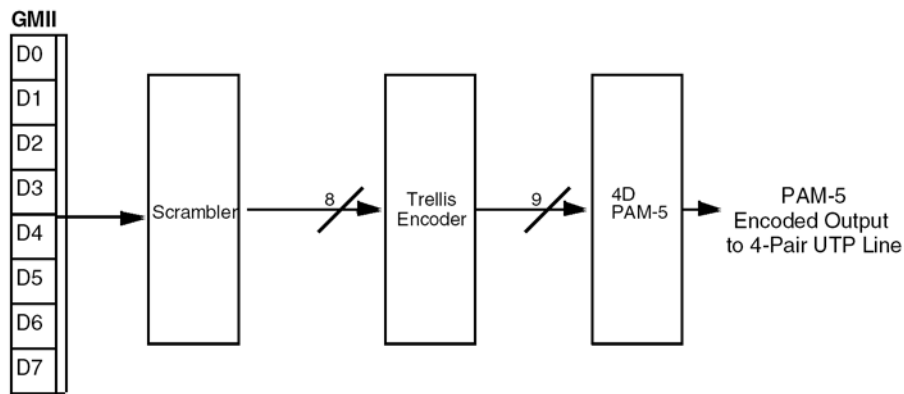

Scrambler Polynomials:

$1 + x^{13} + x^{33}$  (Master PHY Mode)

$1 + x^{20} + x^{33}$  (Slave PHY Mode)

Figure 31. 1000BASE-T Transmit Flow And Line Coding Scheme

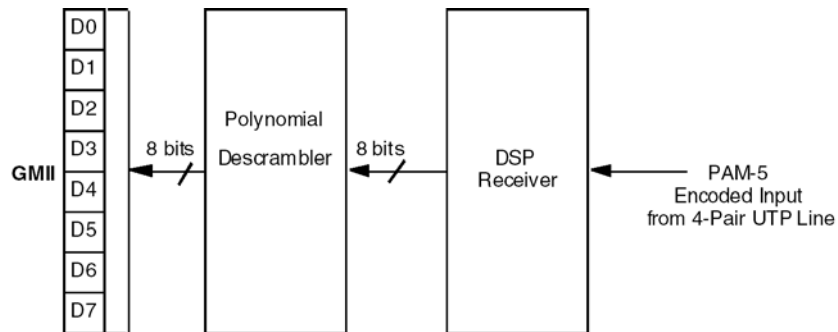

Figure 32. 1000BASE-T Receive Flow



## 11.8.3 Receive Functions

This section describes function blocks that are used when the PHY receives data from the twisted pair interface and passes it back to the MAC.

### 11.8.3.1 Hybrid

The hybrid subtracts the transmitted signal from the input signal, allowing the use of simple 100BASE-TX compatible magnetics.

### 11.8.3.2 Automatic Gain Control

The Automatic Gain Control (AGC) normalizes the amplitude of the received signal, adjusting for the attenuation produced by the cable.

### 11.8.3.3 Timing Recovery

This function re-generates a receive clock from the incoming data stream which is used to sample the data. On the Slave side of the link, this clock is also used to drive the transmitter.

### 11.8.3.4 Analog-to-Digital Converter

The Analog-to-Digital (ADC) function converts the incoming data stream from an analog waveform to digitized samples for processing by the DSP core.

### 11.8.3.5 Digital Signal Processor

The Digital Signal Processor (DSP) provides per-channel adaptive filtering, which eliminates various signal impairments including:

- Inter-symbol interference (equalization).
- Echo caused by impedance mismatch of the cable.
- Near-end crosstalk (NEXT) between adjacent channels (A, B, C, D).
- Far-end crosstalk (FEXT)
- Propagation delay variations between channels of up to 120 ns.
- Extraneous tones that have been coupled into the receive path.

The adaptive filter coefficients are initially set during the training phase. They are continuously adjusted (adaptive equalization) during operation through the decision-feedback loop.

### 11.8.3.6 Descrambler

The descrambler identifies each channel by its characteristic signature, removing the signature and re-routing the channel internally. In this way, the receiver can correct for channel swaps and polarity reversals. The descrambler uses the same base LFSR used by the transmitter on the other side of the link.

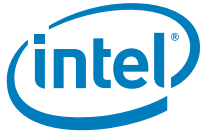

The descrambler requires approximately 15  $\mu$ s. to lock, normally accomplished during the training phase.

### 11.8.3.7 Viterbi Decoder/Decision Feedback Equalizer (DFE)

The Viterbi decoder generates clean 4DPAM5 symbols from the output of the DSP. The decoder includes a Trellis encoder identical to the one used by the transmitter. The Viterbi decoder simultaneously looks at the received data over several baud periods. For each baud period, it predicts whether the symbol received should be even or odd, and compares that to the actual symbol received. The 4DPAM5 code is organized in such a way that a single level error on any channel changes an even code to an odd one and vice versa. In this way, the Viterbi decoder can detect single-level coding errors, effectively improving the Signal-To-Noise (SNR). When an error occurs, this information is quickly fed back into the equalizer to prevent future errors.

### 11.8.3.8 4DPAM5 Decoder

The 4DPAM5 decoder generates 8B data from the output of the Viterbi decoder.

## 11.9 100 Mb/s Operation

The MAC passes data to the PHY over the MII. The PHY encodes and scrambles the data, then transmits it using MLT-3 for 100TX over copper. The PHY descrambles and decodes MLT-3 data received from the network. When the MAC is not actively transmitting data, the PHY sends out idle symbols on the line.

## 11.10 10 Mb/s Operation

The PHY operates as a standard 10 Mb/s transceiver. Data transmitted by the MAC as 4-bit nibbles is serialized, Manchester-encoded, and transmitted on the MDI[0]+/- outputs. Received data is decoded, de-serialized into 4-bit nibbles and passed to the MAC across the internal MII. The PHY supports all the standard 10 Mb/s functions.

### 11.10.1 Link Test

In 10 Mb/s mode, the PHY always transmits link pulses. If the Link Test Function is enabled, it monitors the connection for link pulses. Once it detects 2 to 7 link pulses, data transmission is enabled and remains enabled as long as the link pulses or data reception continues. If the link pulses stop, the data transmission is disabled.

If the Link Test function is disabled, the PHY might transmit packets regardless of detected link pulses. Setting PHY register 16d, bit 14 can disable the Link Test function.





## 11.10.2 10Base-T Link Failure Criteria and Override

Link failure occurs if Link Test is enabled and link pulses stop being received. If this condition occurs, the PHY returns to the Auto-Negotiation phase if Auto-Negotiation is enabled. Setting PHY register 16d, bit 14 disables the Link Integrity Test function, then the PHY transmits packets, regardless of link status.

## 11.10.3 Jabber

If the MAC begins a transmission that exceeds the jabber timer, the PHY disables the transmit and loopback functions and asserts collision indication to the MAC. The PHY automatically exits jabber mode after 250-750 ms. This function can be disabled by setting PHY register 16d, bit 10 to 1b.

## 11.10.4 Polarity Correction

The PHY automatically detects and corrects for the condition where the receive signal (MDI\_PLUS[0]/MDI\_MINUS[0]) is inverted. Reversed polarity is detected if eight inverted link pulses, or four inverted end-of-frame markers, are received consecutively. If link pulses or data are not received for 96-130 ms, the polarity state is reset to a non-inverted state.

## 11.10.5 Dribble Bits

The PHY device handles dribble bits for all of its modes. If between one to four dribble bits are received, the nibble is passed across the interface. The data passed across is padded with 1b's if necessary. If between five to seven dribble bits are received, the second nibble is not sent onto the internal MII bus to the MAC. This ensures that dribble bits between 1-7 do not cause the MAC to discard the frame due to a CRC error.

§ §



**NOTE:**      *This page intentionally left blank.*



## 12.0 Configurable LED Outputs

---

The 82575 implements four output drivers intended for driving external LED circuits per port. Each LAN device provides an independent set of LED outputs (these pins and their function are bound to a specific LAN device). Each of the four LED outputs can be individually configured to select the particular event, state, or activity that is indicated on that output. In addition, each LED can be individually configured for output polarity as well as for blinking versus non-blinking (steady-state) indication.

The configuration for LED outputs is specified via the LEDCTL register. In addition, the hardware-default configuration for all the LED outputs can be specified via EEPROM fields, thereby supporting LED displays configurable to a particular OEM preference.

Each of the four LED's can be configured to use one of a variety of sources for output indication. The MODE bits control the LED source:

- LINK\_100/1000 is asserted when link is established at either 100 or 1000 Mb/s.
- LINK\_10/1000 is asserted when link is established at either 10 or 1000 Mb/s.
- LINK\_UP is asserted when any speed link is established and maintained.
- ACTIVITY is asserted when link is established and packets are being transmitted or received.
- LINK/ACTIVITY is asserted when link is established AND there is NO transmit or receive activity
- LINK\_10 is asserted when a 10 Mb/s link is established and maintained.
- LINK\_100 is asserted when a 100 Mb/s link is established and maintained.
- LINK\_1000 is asserted when a 1000 Mb/s link is established and maintained.
- FULL\_DUPLEX is asserted when the link is configured for full duplex operation.
- COLLISION is asserted when a collision is observed.
- PAUSED is asserted when the 82575's transmitter is flow controlled.
- LED\_ON is always asserted; LED\_OFF is always de-asserted.

The IVRT bits enable the LED source to be inverted before being output or observed by the blink-control logic. LED outputs are assumed to normally be connected to the negative side (cathode) of an external LED.

The BLINK bits control whether the LED should be blinked (either 200 ms on and 200 ms off or 83 ms on and 83 ms off) while the LED source is asserted. The blink control might be especially useful for ensuring that certain events, such as ACTIVITY indication, cause LED transitions, which are sufficiently visible to a human eye.

**Note:** The LINK/ACTIVITY source functions slightly different from the others when BLINK is enabled. The LED is off if there is no LINK, on if there is LINK and no ACTIVITY, and blinking if there is LINK and ACTIVITY.



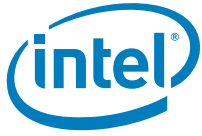

**NOTE:**      *This page intentionally left blank.*



## 13.0 Dual Port Characteristics

The 82575 architecture includes two instances both the MAC and PHY. With both MAC/PHY pairs operating, the 82575 appears as a multi-function PCIe\* device containing two identically-functioning devices. To avoid confusion, each MAC (when combined with either an internal/external PHY or SerDes) is referred to as “LANx”, where x = “A” or x = “B” to refer to each logical LAN device (LAN 0 or LAN 1).

This section details specific features common to each MAC or PHY, resources/interfaces for which dedicated independent hardware/software interfaces exists for each LAN, as well as resources which are shared by both LAN devices.

The 82575 normally appears to the system as a single, multi-function PCIe\* device. It provides the ability to selectively disable one of the internal LAN functions, thereby allowing it to appear to the system as a single-function, single-LAN device. The mechanisms for controlling this behavior and the resulting appearance to the system are described in [Section 13.5](#) entitled, “LAN Disable”.

### 13.1 Features of Each MAC

The 82575 is designed to have the capability to appear as two independent instances of a gigabit controller. The following section details major features that can be considered to be distinct features available to each 82575 MAC independently.

#### 13.1.1 PCIe\* Interface

The 82575 contains a single physical PCIe\* core interface. The 82575 is designed so that each of the logical LAN devices (LAN 0, LAN 1) appears as a distinct function implementing, amongst other registers, the following PCIe\* device header space:

Byte Offset	Byte 0	Byte 1	Byte 2	Byte 3
0h	Device ID		Vendor ID	
4h	Status Register		Command Register	
8h	Class Code 020000h			Revision ID (02h)
Ch	00h	Header Type 00h	Latency Timer	Cache Line Size
10h	Base Address 0			
14h	Base Address 1			
18h	Base Address 2			
1Ch	Base Address 3			
20h	Base Address 4			
24h	Base Address 5			



Byte Offset	Byte 0	Byte 1	Byte 2	Byte 3
28h	Cardbus CIS Pointer (not used)			
2Ch	Subsystem ID		Subsystem Vendor ID	
30h	Expansion ROM Base Address			
34h	Reserved			Cap_Ptr
38h	Reserved			
3Ch	Max_Latency 00h	Min_Grant Fh	Interrupt Pin 01h or 02h)	Interrupt Line 00h

Many of the fields of the PCIe\* header space contain hardware default values that are either fixed or can be overridden using EEPROM, but cannot be independently specified for each logical LAN device. The following fields are considered to be common to both LAN devices:

Vendor ID	Vendor ID is fixed to 8086 and is not readable from EEPROM.
Revision	The revision number of the 82575 is reflected identically for both LAN devices.
Header Type	This field indicates if a device is single function or multifunction. The value reflected in this field is reflected identically for both LAN devices, but the actual value reflected depends on LAN Disable configuration.  When both 82575 LAN ports are enabled, both PCI headers return 80h in this field, acknowledging being part of a multi-function device. LAN A exists as device "function 0", while LAN B exists as device "function 1".  If one of the LAN ports is disabled, then only a single-function device is indicated (this field returns a value of 00h), and the LAN exists as device "function 0".
Subsystem ID	The Subsystem ID of the 82575 can be specified via EEPROM, but only a single value can be specified. The value is reflected identically for both LAN devices.
Subsystem Vendor ID	The Subsystem Vendor ID of the 82575 can be specified via EEPROM, but only a single value can be specified. The value is reflected identically for both LAN devices.
Class Code, Cap_Ptr, Max Latency, Min Grant	These fields reflect fixed values that are constant values reflected for both LAN devices.

The following fields are implemented unique to each LAN device:

Device ID	The Device ID reflected for each LAN device can be independently specified via EEPROM.
Command, Status	Each LAN device implements its own command/status registers.
Latency Timer, Cache Line Size	Each LAN device implements these registers uniquely. The system should program these fields identically for each LAN to ensure consistent behavior and performance of each device.
Memory BAR, Flash BAR, IO BAR, Expansion ROM BAR	Each LAN device implements its own Base Address registers, allowing each device to claim its own address region(s).
Interrupt Pin	Each LAN device independently indicates which interrupt pin (INTA# or INTB#) is used by that 82575's MAC to signal system interrupts. The value for each LAN device can be independently specified via EEPROM, but only if both LAN devices are enabled.



## 13.1.2 MAC Configuration Register Space

All device control/status registers detailed in [Section 14.3](#), Main Register Descriptions, are implemented per-LAN device. Each LAN device can be accessed using memory or I/O cycles, depending on the specific BAR setting(s) established for that LAN device.

Register accesses to each MAC instance are independent. An outstanding read for one LAN device does not impact the 82575's ability to accept a register access to the other LAN. PCIe\* bus operation, where each register access results in a completion by one LAN device, in no way prevents the other LAN device from accepting and servicing its register space as the 82575's PCIe\* core supports two credits for memory accesses.

## 13.1.3 SDP, LED, INT# Output

Each LAN device provides an independent set of LED outputs and software-programmable I/O pins (SDP). Four LED outputs and four SDP pins are provided per LAN device. These pins and their function are bound to a specific LAN device (eight SDP pins cannot be associated with a single LAN device, for example).

## 13.2 Shared EEPROM

The 82575 uses a single EEPROM device to configure hardware default parameters for both LAN devices, including Ethernet Individual Addresses (IA), LED behaviors, receive packet-filters for manageability and wakeup capability, etc. Certain EEPROM words are used to specify hardware parameters which are LAN device-independent (such as those that affect circuits behavior). Other EEPROM words are associated with a specific LAN device. LAN 0 and LAN 1 accesses the EEPROM to obtain their respective configuration settings.

## 13.3 Shared FLASH

The 82575 provides an interface to an external FLASH/ROM memory device, as described in [Section 4.0](#). This FLASH/ROM device can be mapped into memory and/or I/O address space for each LAN device through the use of PCI Base Address Registers (BARs). Bit 3 of the EEPROM Initialization Control Word 3 associated with each LAN device selectively disables/enables whether the FLASH can be mapped for each LAN device by controlling the BAR register advertisement and writeability.

### 13.3.1 FLASH Access Contention

The 82575 implements internal arbitration between Flash accesses initiated through the LAN "A" device and those initiated through the LAN "B" device. If accesses from both LAN devices are initiated during the same approximate size window, The first one is served first and only then the next one, Note that the 82575 does not synchronize between the two entities accessing the Flash though contentions caused from one entity reading and the other modifying the same locations is possible.



To avoid this contention, accesses from both LAN devices MUST be synchronized using external software synchronization of the memory or I/O transactions responsible for the access. It might be possible to ensure contention-avoidance simply by nature of software sequentially.

## 13.4 Link Mode/Configuration

The 82575 provides significant amount of flexibility in pairing a LAN device with a particular type of media (copper or fiber-optic) as well as the specific transceiver/interface used to communicate with the media. Each MAC, representing a distinct LAN device, can be coupled with an internal copper PHY (the default) or SerDes interface independently. The link configuration specified for each LAN device can be specified in the LINK\_MODE field of the Extended Device Control Register (CTRL\_EXT) and initialized from the EEPROM Initialization Control Word 3 associated with each LAN device

## 13.5 LAN Disable

For a LOM design, it might be desirable for the system to provide BIOS-setup capability for selectively enabling or disabling LOM devices. This might allow an end-user more control over system resource-management, avoid conflicts with add-in NIC solutions, etc. The 82575 provides support for selectively enabling or disabling one or both LAN device(s) in the system.

### 13.5.1 Overview

Device presence (or non-presence) must be established early during BIOS execution in order to ensure that BIOS resource-allocation (of interrupts, of memory or IO regions) is done according to devices that are present only. This is frequently accomplished using a BIOS CVDR (Configuration Values Driven on Reset) mechanism. The 82575 LAN-disable mechanism is implemented in order to be compatible with such a solution. The 82575 samples two pins (strapping) on PCIe\* reset to determine the LAN-enable configuration. The 82575 also enables the same through EEPROM presetting.

The LAN disabling can be done at two different levels. Either the LAN is disabled completely, or the function is not apparent on the PCIe\* configuration space. In this case, the LAN function is still available for the manageability accesses. The selection between the two modes is done using the PHY\_in\_LAN\_disable EEPROM bit.

When a particular LAN is fully disabled, all internal clocks to that LAN are disabled, the 82575 is held in reset, and the internal PHY for that LAN is powered-down. In both modes, The 82575 does not respond to PCI configuration cycles, unless it is function #0, in which case, the function presents itself as a dummy device. Effectively, the LAN device becomes invisible to the system from both a configuration and power-consumption standpoint.

As mentioned all PCI functions can be enabled or disabled and an additional EEPROM bit (LAN Function Sel) enables to swap between the two LAN functions.

It is desired to keep all the functions at their respective location, even when other functions are disabled. If function #0 (either LAN0 or LAN1) is disabled, then it does not disappear from the PCIe\* configuration space. Rather, the function presents itself as a dummy function. The device ID and class





code of this function changes to other values 10A6h and FF00h, respectively. In addition the function does not require any memory or I/O space and does not require an interrupt line. Also MSI and MSI-X capability structure does not appear in this mode. Memory, I/O and master enable bits are read only.

## 13.5.2 Multi-Function Advertisement

If the LAN 1 port is disabled, the 82575 no longer is a multi-function device. It normally reports a 80h in the PCI Configuration Header field *Header Type*, indicating multi-function capability. However, if a LAN ID is disabled, it reports a 0h in this field to signify single-function capability.

## 13.5.3 Legacy Interrupt Use

When both LAN devices are enabled, the 82575 can use interrupt pins INTA# to INTC# for interrupt reporting. The EEPROM Initialization Control Word 3 (bits 12:11) associated with each LAN device controls which of these interrupts are used for each LAN device. The specific interrupt pin used is reported in the PCI Configuration Header *Interrupt Pin* field associated with each LAN device.

However, if either LAN device is disabled, then INTA# must be used for the remaining LAN device, regardless of the EEPROM configuration. Under these circumstances, the *Interrupt Pin* field of the PCI Header always reports a value of 1h, indicating INTA# usage.

## 13.5.4 Power Reporting

When both LAN devices are enabled, the PCI Power Management Register Block has the capability of reporting a Common Power value. The Common Power value is reflected in the data field of the PCI Power Management registers. The value reported as Common Power is specified via EEPROM, and is reflected in the data field each time the *Data\_Select* field has a value of 8h (8h = Common Power Value Select).

When only one LAN is enabled and the 82575 appears as a single-function device, the Common Power value, if selected, reports 0h (undefined value), as Common Power is undefined for a single-function device.

## 13.6 Device Disable

For a LOM design, it might be desirable for the system to provide BIOS-setup capability for selectively enabling or disabling LOM devices. This allows an end-user more control over system resource-management; avoid conflicts with add-in NIC solutions, etc. The 82575 provides support for selectively enabling or disabling it.

**Note:** If the 82575 is configured to provide a 50 MHz NC-SI clock (via the NC-SI Output Clock EEPROM bit), then the \Device should not be disabled.

Device Disable is initiated by asserting the asynchronous DEV\_OFF\_N pin. The DEV\_OFF\_N pin should always be connected to enable correct device operation.

The EEPROM Device *Disable Power Down En* bit enables device disable mode (hardware default is that the mode is disabled).



While in device disable mode, the PCIe\* link is in L3 state. The PHY is in power down mode. Output buffers are tri-stated.

Asserting or deasserting the PCIe\* PE\_RST\_N does not have any effect while the 82575 is in device disable mode (for example, the 82575 stays in the respective mode as long as DEV\_OFF\_N is asserted). However, the 82575 might momentarily exit the device disable mode from the time PCIe\* PE\_RST\_N is de-asserted again and until the EEPROM is read.

During power-up, the DEV\_OFF\_N pin is ignored until the EEPROM is read. From that point, the 82575 might enter Device Disable if DEV\_OFF\_N is asserted.

Deasserting the DEV\_OFF\_N pin causes a fundamental reset to the 82575.

**Note:** The DEV\_OFF\_N pin should maintain its state during system reset and system sleep states. It should also insure the proper default value on system power-up. For example, a designer could use a GPIO pin that defaults to 1b (enable) and is on system suspend power (it maintains state in S0-S5 ACPI states).

## 13.6.1 BIOS Handling of Device Disable

1. Assume that following a power up sequence, the DEV\_OFF\_N signals is driven high (else it is already disabled).
2. The PCIe\* is established following the GIO\_PWR\_GOOD
3. BIOS recognizes that the entire 82575 should be disabled.
4. The BIOS drives the DEV\_OFF\_N signal to the low level.
5. As a result, the 82575 samples the DEV\_OFF\_N signals and enters device disable mode.
6. The BIOS could put the Link in the Electrical IDLE state (at the other end of the PCIe\* link) by clearing the *LINK Disable* bit in the Link Control Register.
7. Proceed with normal operation
8. Re-enable could be done by driving the DEV\_OFF\_N signal high, followed later by bus enumeration.

## 13.7 Copper/Fiber Switch

The 82575 component provides significant amount of flexibility in pairing a LAN device with a particular type of media (for example, copper or fiber-optic) as well as the specific transceiver/interface used to communicate with the media. Each MAC, representing a distinct LAN device, can be coupled with an internal copper PHY (the default) or SerDes interface independently. The link configuration specified for each LAN device can be specified in the LINK\_MODE field of the Extended Device Control Register (CTRL\_EXT) and initialized from the EEPROM Initialization Control Word 3 associated with each LAN device.

In some applications, software might need to be aware of the presence of a link on the connection not currently active. In order to supply such an indication, any of the 82575 ports can set the AUTOSENSE\_EN bit in the CONNSW register (address 00034h) in order to enable sensing of the non active connection activity. When in SerDes detect mode, software should define which indication is used to detect the energy change in SerDes/SGMII mode. It can be either the external signal detect pin or the internal signal detect. This is done using the CONNSW.ENRGSRC bit.



Software can then enable the OMED interrupt in ICR in order to get an indication on any detection of energy in the non active connection.

The following procedure should be followed in order to enable the auto-sense mode:

- SerDes Detect Mode (PHY is active):
  1. Set CONNSW.ENRGSRC to determine the sources for the signal detect indication (1b = external SIG\_DET, 0b = internal SerDes electrical idle). The default of this bit is set by the EEPROM.
  2. Set CONNSW.AUTOSENSE\_EN.
  3. When signal is detected on the SerDes link, the 82575 sets the interrupt bit OMED in ICR and if enabled, issue an interrupt. The CONNSW.AUTOSENSE\_EN is cleared unless CONNSW.ASCLR\_DIS is set. In such a case the host driver is responsible for the clearing of the AUTOSENSE\_EN bit.
- PHY Detect Mode:
  1. Set CONNSW.AUTOSENSE\_CONF = 1b.
  2. Reset the PHY by assertion and de-assertion of CTRL.PHY\_RST.
  3. Wait until EEMNGCTL.CFG\_DONE is set.
  4. Enter the PHY to Link-Disconnect mode by setting PHY register 25 (bit 5) via MDIC register.
  5. Set CONNSW.AUTOSENSE\_EN = 1b and clear CONNSW.AUTOSENSE\_CONF.
  6. When signal is detected on the PHY link, the 82575 sets the interrupt bit OMED in ICR and if enabled, issue an interrupt.
  7. The 82575 puts the PHY in power down unless CONNSW.ASCLR\_DIS is set. In such a case the host driver is responsible for the clearing of the AUTOSENSE\_EN bit.

According to the result of the interrupt, software can then decide to switch to the other core.

The following procedures needs to be followed to actually switch between the two modes:

- Internal PHY to SerDes Transition:
  1. Disable Receiver by clearing RCTL.RXEN.
  2. Disable Transmitter by clearing TCTL.EN.
  3. Verify that the 82575 has stopped processing outstanding cycles and is idle.
  4. Modify LINK mode to SerDes or SGMII by setting CTRL\_EXT.LINK\_MODE to 10b or 11b, respectively.
  5. Enable/Disable flow control values within the MAC.
  6. Set up Tx and Rx queues and enable Tx and Rx processes.
- SerDes to Internal PHY Transition:
  1. Disable Receiver by clearing RCTL.RXEN.
  2. Disable Transmitter by clearing TCTL.EN.
  3. Verify that the 82575 has stopped processing outstanding cycles and is idle.
  4. Modify LINK mode to PHY mode by setting CTRL\_EXT.LINK\_MODE to 00b.
  5. Set Link Up indication by setting CTRL.SLU.
  6. Reset the PHY by setting CTRL.PHY\_RST, waiting 10 ms and clearing CTRL.PHY\_RST.
  7. Set up PHY with desired auto-negotiation parameters.
  8. Set up Tx and Rx queues and enable Tx and Rx processes.

The 82575's link mode is controlled by the Extended Device Control register:



CTRL\_EXT (00018h) bits 23:22. The default value for the LINK\_MODE setting is directly mapped from the EEPROM's initialization Control Word 3 (bits 1:0). Software can modify the LINK\_MODE indication by writing the corresponding value into this register.

**Note:**

- Before dynamically cycling a mode, ensure via the software device driver that the current mode of operation is not in the process of transmitting or receiving data. This is achieved by disabling the transmitter and receiver, waiting until the 82575 is in an idle state and then beginning the process for changing the link mode.
- The mode switch in this method, is only valid until the next hardware reset of the 82575. After a hardware reset, the link mode is restored to the default set by the EEPROM. To get a permanent change of the link mode, the default in the EEPROM should be changed.
- The auto switch capability can be used in either port independent of the usage of the other port.

§ §

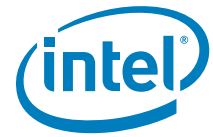

**NOTE:**        *This page intentionally left blank.*

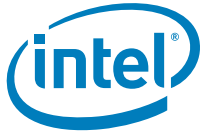



## 14.0 Register Descriptions

---

This section details the state inside the 82575 that are visible to the programmer. In some cases, it describes hardware structures invisible to software in order to clarify a concept.

The internal register/memory space is described in the following sections and divided up into the following categories:

- General
- Interrupt
- MAC Receive
- MAC Transmit
- Statistics
- Wake Up
- PCIe\*
- Diagnostics (including packet buffer memory access)
- Packet Generator
- PHY Receive, Transmit and Special Function

**Note:** The PHY registers are accessed through the MDI/O interface (see [Section 14.3.8](#) for PHY register descriptions).

The 82575's address space is mapped into five regions with PCI Base Address Registers described in the table below. These regions are shown as follows.

Internal registers and memories (including PHY)	Memory	128 KB
Flash (optional)	Memory	64 - 512 KB
Expansion ROM (optional)	Memory	64 - 512 KB
Internal registers and memories, Flash (optional)	I/O Windows Mapped	32 Bytes
MSI-X (optional)	Memory	16 KB

Both the Flash and Expansion ROM Base Address Registers map the same Flash memory. The internal registers and memories and Flash can be access through I/O space by doing a level of indirection, as explained later.

### 14.1 Register Conventions

All registers in the 82575 are defined to be 32 bits and should be accessed as 32-bit double words. There are some exceptions to this rule:



- Register pairs where two 32-bit registers make up a larger logical size.
- Accesses to Flash memory (through the Expansion ROM space, secondary BAR space, or the I/O space) can be byte, word, or double word accesses.

**Reserved bit positions.** Some registers contain certain bits that are marked as “reserved.” These bits should never be set to a value of 1b by software. Reads from registers containing reserved bits can return indeterminate values in the reserved bit positions unless read values are explicitly stated. When read, these reserved bits should be ignored by software.

**Reserved and/or undefined addresses.** Any register address not explicitly declared in this specification should be considered to be reserved and should not be written. Writing to reserved or undefined register addresses can cause indeterminate behavior. Reads from reserved or undefined configuration register addresses can return indeterminate values unless read values are explicitly stated for specific addresses.

**Initial values.** Most registers define the initial hardware values prior to being programmed. In some cases, hardware initial values are undefined and are listed as such via the text “undefined,” “unknown,” or “X.” Some such values might need setting through EEPROM configuration or software in order for proper operation to occur; this need is dependent on the function of the bit. Other registers might cite a hardware default that is overridden by a higher precedence operation. Operations that might supersede hardware defaults can include a valid EEPROM load, completion of a hardware operation (such as hardware Auto-Negotiation), or writing of a different register whose value is then reflected in another bit.

For registers that should be accessed as 32-bit double words, partial writes (less than a 32-bit double word) is ignored. Partial reads return all 32 bits of data regardless of the byte enables.

**Note:** Partial reads to read-on-clear registers (like ICR) can have unexpected results since all 32 bits are actually read regardless of the byte enables. Partial reads should not be done.

All statistics registers are implemented as 32-bit registers. Though some logical statistics registers represent counters in excess of 32-bits in width, registers must be accessed using 32-bit operations. For example, independent access to each 32-bit field.

Refer to the special notes for VLAN Filter Table, Multicast Table Arrays and Packet Buffer Memory appears in the specific register definitions.

The 82575 register fields are assigned one of the attributes listed in [Table 87](#).



**Table 87. Field Attributes**

Attribute	Description
RW	Read-Write field: Register bits are read-write and can be either set or cleared by software to the desired state.
RWS	Read-Write Status field: Register bits are read-write and can be either set or cleared by software to the desired state. However, the value of this field might be changed by hardware to reflect a status change.
RO	Read-only register: Register bits are read-only and cannot be altered by software. Register bits can be initialized by hardware mechanisms such as pin strapping or serial EEPROM or reflect status of the hardware state.
R/W1C	Read-only status, Write-1b-to-clear status register: Register bits indicate status when read, a set bit indicating a status event can be cleared by writing a 1b. Writing a 0b to R/W1C bits has no effect. These bits are considered as status bits.
RSV	Reserved. These fields should not be written.
RC	Read-only status, Read-to-clear status register: Register bits indicate status when read, a set bit indicating a status event is cleared by reading it.
SC	Self Clear field: a command field that is self clearing. These fields are always read as 0b.
WO	Write only field: a command field that can not be read, These fields read value is undefined.
RC/W1C	Read-only status, Write-1b-to-clear status register: Read-to-clear status register Register bits indicate status when read, a set bit indicating a status event can be cleared by writing a 1b or by reading the register. Writing a 0b to RC/W1C bits has no effect.
RS	Read Set – this is the attribute used for Semaphore bits. These bits are set by read in case the previous value was 0b. In this case the read value is 0b; otherwise the read value is 1b. Cleared by writing 0b.

## 14.1.1 Memory and I/O Address Decoding

### 14.1.1.1 Memory-Mapped Access to Internal Registers and Memories

The internal registers and memories can be accessed as direct memory-mapped offsets from the base address register (BAR0 see [Section 6.6.4](#)).

### 14.1.1.2 Memory-Mapped Access to FLASH

The external Flash can be accessed using direct memory-mapped offsets from the Flash Base Address register (BAR1 see [Section 6.6.4](#)). The Flash is only accessible if enabled through the EEPROM Initialization Control Word, and if the Flash Base Address register contains a valid (non-zero) base memory address. For accesses, the offset from the Flash BAR corresponds to the offset into the flash actual physical memory space.

### 14.1.1.3 Memory-Mapped Access to MSI-X Tables

The MSI-X tables can be accessed as direct memory-mapped offsets from the Base Address register (BAR3 see [Section 6.6.4](#)). See [Section 14.1.1.4](#) for the appropriate offset for each specific internal register.



### 14.1.1.4 Memory-Mapped Access to Expansion ROM

The external Flash can also be accessed as a memory-mapped expansion ROM. Accesses to offsets starting from the Expansion ROM Base Address (see [Section 6.6.4](#)) reference the Flash provided that access is enabled through the EEPROM Initialization Control Word, and if the Expansion ROM Base Address register contains a valid (non-zero) base memory address.

## 14.1.2 I/O-Mapped Internal Register, Internal Memory, and Flash

To support pre-boot operation (prior to the allocation of physical memory base addresses), all internal registers, memories, and Flash can be accessed using I/O operations. I/O accesses are supported only if an I/O Base Address is allocated and mapped (BAR2 [Section 6.6.4](#)), the BAR contains a valid (non-zero value), and I/O address decoding is enabled in the PCIe\* configuration.

When an I/O BAR is mapped, the I/O address range allocated opens a 32-byte window in the system I/O address map. Within this window, two I/O addressable registers are implemented: IOADDR and IODATA. The IOADDR register is used to specify a reference to an internal register, memory, or Flash, and then the IODATA register is used as a window to the register, memory or Flash address specified by IOADDR:

Offset	Abbreviation	Name	RW	Size
00h	IOADDR	Internal Register, Internal Memory, or Flash Location Address 00000h - 1FFFFh — Internal Registers and Memories 20000h - 7FFFFh — Undefined 80000h - 87FFFFh — Flash	RW	4 bytes
04h	IODATA	Data field for reads or writes to the Internal Register Internal Memory, or Flash location as identified by the current value in IOADDR. All 32 bits of this register are read/write-able.	RW	4 bytes
08h - 1Fh	Reserved	Reserved.	RO	4 bytes

### 14.1.2.1 IOADDR

The IOADDR register must always be written as a DWORD access. Writes that are less than 32 bits are ignored. Reads of any size return a DWORD of data. However, the chipset or processor can only return a subset of that DWORD.

For software programmers, the IN and OUT instructions must be used to cause I/O cycles to be used on the PCIe\* bus. Since writes must be to a 32-bit quantity, the source register of the OUT instruction must be EAX (the only 32-bit register supported by the OUT command). For reads, the IN instruction can have any size target register, but it is recommended that the 32-bit EAX register be used.

Since only a particular range is addressable, the upper bits of this register are hard coded to 0b. Bits 31 through 20 are not write-able and always read back as 0b.

At hardware reset (Internal\_Power\_On\_Reset) or PCI Reset, this register value resets to 00h. Once written, the value is retained until the next write or reset.



### 14.1.2.2 IODATA

The IODATA register must always be written as a DWORD access when the IOADDR register contains a value for the Internal Register and Memories (00000h - 1FFFCh). In this case, writes less than 32 bits are ignored.

The IODATA register can be written as a byte, word, or Dword access when the IOADDR register contains a value for the Flash (80000h - FFFFh). In this case, the value in IOADDR must be properly aligned to the data value. The table below lists the supported configurations:

Access Type	IOADDR Register Bits [1:0]	Target IODATA Access BE[3:0]# Bits in Data Phase
BYTE (8 bits)	00b	1110b
	01b	1101b
	10b	1011b
	11b	0111b
WORD (16 bits)	00b	1100b
	10b	0011b
DWORD (32 bits)	00b	0000b

**Note:** Software might need to implement special code to access the Flash memory at a byte or word at a time. Example code that reads a Flash byte is shown here:

```
char *IOADDR;

char *IODATA;

IOADDR = IOBASE + 0;

IODATA = IOBASE + 4;

*(IOADDR) = Flash_Byte_Address;

Read_Data = *(IODATA + (Flash_Byte_Address % 4));
```

Reads to IODATA of any size returns a Dword of data. However, the chipset or processor can only return a subset of that Dword.

For software programmers, the IN and OUT instructions must be used to cause I/O cycles to be used on the PCIe\* bus. Where 32-bit quantities are required on writes, the source register of the OUT instruction must be EAX (the only 32-bit register supported by the OUT command).

Writes and reads to IODATA when the IOADDR register value is in an undefined range (20000h - 7FFFCh) should not be performed. Results can be indeterminate.

**Note:** There are no special software timing requirements on accesses to IOADDR or IODATA. All accesses are immediate except when data is not readily available or acceptable. In this



case, the 82575 delays the results through normal bus methods. For example, a split transaction or transaction retry.

Because a register/memory/flash read or write takes two IO cycles to complete, software must provide a guarantee that the two IO cycles occur as an atomic operation. Otherwise, results can be indeterminate.

### 14.1.2.3 Undefined I/O Offsets

I/O offsets 08h through 1Fh are considered to be reserved offsets with the I/O window. Dword reads from these addresses will return FFFFh; writes to these addresses are discarded.

## 14.2 Register Summary

All 82575's non-PCIe\* configuration registers, except from the MSI-X register, are listed in the table. These registers are ordered by grouping and are not necessarily listed in order that they appear in the address space.

Category	Offset	Abbreviation	Name	R/W	Page
General	00000h 00004h	CTRL	Device Control	R/W	299
General	00008h	STATUS	Device Status	RO	302
General	00010h	EEC	EEPROM/Flash Control	R/W	303
General	00014h	EERD	EEPROM Read	R/W	305
General	00018h	CTRL_EXT	Extended Device Control	R/W	306
General	0001Ch	FLA	Flash Access	R/W	309
General	00020h	MDIC	MDI Control	R/W	310
General	00024h	SERDESCTL	Serdes_ana	R/W	326
General	00028h	FCAL	Flow Control Address Low	R/W	328
General	0002Ch	FCAH	Flow Control Address High	R/W	328
General	00030h	FCT	Flow Control Type	R/W	329
General	00034h	CONNSW	Copper/Fiber Switch Control	R/W	326
General	00038h	VET	VLAN EtherType	R/W	327
General	05B78h	UFUSE	Fuse Register	RO	327
General	00028h	FCAL	Flow Control Address Low	R/W	328
General	0002Ch	FCAH	Flow Control Address High	R/W	328
General	00030h	FCT	Flow Control Type	R/W	329
General	00170h	FCTTV	Flow Control Transmit Timer Value	R/W	329
General	00E00h	LEDCTL	LED Control	R/W	329
General	01000h	PBA	Packet Buffer Allocation	R/W	331
General	01008h	PBS	Packet Buffer Size	R/W	332
General	01028h	I2CCMD	SFP I2C Command	R/W	332
General	0102Ch	I2CPARAMs	SFP I2C Parameter	R/W	333
General	0103C	FLASHOP	FLASH Opcode	R/W	334
General	01038h	EEDIAG	EEPROM Diagnostic	R/W	334
General	01010h	EEMNGCTL	Manageability EEPROM Control Register	RO	335



Category	Offset	Abbreviation	Name	R/W	Page
General	01014h	EEMNGDATA	Manageability EEPROM Read/Write Data	RO	336
General	01018h	FLMNGCTL	Manageability Flash Control Register	R/W	336
General	0101Ch	FLMNGDATA	Manageability Flash Read Data	R/W	336
General	01020h	FLMNGCNT	Manageability Flash Read Counter	R/W	337
General	01204h	EEARBC	EEPROM Auto Read Bus control	R/W	337
General	01040h	WDSTP	Watchdog Setup	R/W	338
General	01044h	WDSWSTS	Watchdog SW	R/W	338
General	01048h	FRTIMER	Free Running Timer	R/WS	339
General	0104Ch	TCPTIMER	TCP Timer	R/W	339
Interrupt	000C0h	ICR	Interrupt Cause Read	RC/ W1C	340
Interrupt	000C8h	ICS	Interrupt Cause Set	WO	341
Interrupt	000D0h	IMS	Interrupt Mask Set/Read	R/W	342
Interrupt	000D8h	IMC	Interrupt Mask Clear	WO	343
Interrupt	000E0h	IAM	Interrupt Acknowledge Auto Mask	R/W	344
Interrupt	01520h	EICS	Extended Interrupt Cause Set	WO	345
Interrupt	01524h	EIMS	Extended Interrupt Mask Set/Read	R/WS	346
Interrupt	01528h	EIMC	Extended Interrupt Mask Clear	WO	346
Interrupt	0152Ch	EIAC	Extended Interrupt Auto Clear	R/W	347
Interrupt	01530h	EIAM	Extended Interrupt Auto Mask	R/W	347
Interrupt	01580h	EICR	Extended Interrupt Cause Read	RC/ W1C	347
Interrupt	05A80h: 05A9Ch	IMIR	Immediate Interrupt Rx[7:0]	R/W	349
Interrupt	05AA0h: 05ABCh	IMIREX	Immediate Interrupt Rx Extended[7:0]	R/W	350
Interrupt	05AC0h	IMIRVP	Immediate Interrupt Rx VLAN Priority	R/W	350
Interrupt	01600h: 01624h	MSIXBM	MSI-X Cause Allocation Bit Map Table	R/W	351
Interrupt	01680h: 016A4h	EITR	Extended Interrupt Throttling Rate 9 - 0	R/W	348
Receive	00100h	RCTL	Receive Control	R/W	351
Receive	0280Ch: 02B0Ch	SRRCTL[3:0]	Split and Replication Receive Control Register Queue 3:0	R/W	354
Receive	05480h: 0548Ch	PSRTYPE[3:0]	Packet Split Receive Type (n)	R/W	355
Receive	02160h	FCRTL	Flow Control Receive Threshold Low	R/W	356
Receive	02168h	FCRTH	Flow Control Receive Threshold High	R/W	357
Receive	02460h	FCRTV	Flow Control Refresh Timer Value	R/W	357
Receive	02800h: 02B00h	RDBAL	Receive Descriptor Base Low Queue 3:0	R/W	358
Receive	02804h: 02B04h	RDBAH	Receive Descriptor Base High Queue 3:0	R/W	358
Receive	02808h: 02B08h	RDLEN	Receive Descriptor Length Queue 3:0	R/W	358
Receive	02810h: 02B10h	RDH	Receive Descriptor Head Queue 3:0	R/W	359
Receive	02818h: 02B18h	RDT	Receive Descriptor Tail Queue 3:0	R/W	359



Category	Offset	Abbreviation	Name	R/W	Page
Receive	02814h: 02B28h	RXDCTL	Receive Descriptor Control Queue 3:0	R/W	360
Receive	02814h: 02B14h	RXCTL	Rx DCA Control Queue 3:0	R/W	376
Receive	05000h	RXCSUM	Receive Checksum Control	R/W	361
Receive	05004h	RLPML	Receive Long Packet Maximum Length	R/W	362
Receive	05008h	RFCTL	Receive Filter Control	R/W	362
Receive	05200h- 053FCh	MTA[127:0]	Multicast Table Array (n)	R/W	379
Receive	05400h: 05428h	RAL	Receive Address Low (15:0)	R/W	380
Receive	05404h: 0547C	RAH	Receive Address High (15:0)	R/W	380
Receive	0581Ch	VMD_CTL	VMDq Control Register	R/W	384
Receive	05600h- 057FCh	VFTA[127:0]	VLAN Filter Table Array (n)	R/W	385
Receive	0B100h: 0B1FCh	VFQA0	VLAN Filter Queue Array 0	R/W	385
Receive	0B200h: 0B3FCh	VFQA1	VLAN Filter Queue Array 1	R/W	385
Receive	05818h	MRQC	Multiple Receive Queues Command	R/W	382
Receive	05C00- 05C7Ch	RETA	Redirection Table	R/W	383
Receive	05C80- 05CAFh	RSSRK	RSS Random Key	R/W	384
Transmit	00400h	TCTL	Transmit Control	R/W	363
Transmit	00404h	TCTL_EXT	Transmit Control Extended	R/W	364
Transmit	00410h	TIPG	Transmit IPG	R/W	365
Transmit	03590h	DTXCTL	DMA Tx Control	R/W	365
Transmit	03800h: 03B00	TDBAL	Transmit Descriptor Base Low Queue 3:0	R/W	366
Transmit	03804h: 03B04h	TDBAH	Transmit Descriptor Base High Queue 3:0	R/W	366
Transmit	03808h: 03B08h	TDLEN	Transmit Descriptor Length Queue 3:0	R/W	367
Transmit	03810h: 03B10h	TDH	Transmit Descriptor Head Queue 3:0	R/W	367
Transmit	03814h: 03B14	TXCTL	Transmit DCA CTRL Queue 3:0	R/W	378
Transmit	03818h: 03B18h	TDT	Transmit Descriptor Tail Queue 3:0	R/W	367
Transmit	03828h: 03B28h	TXDCTL	Transmit Descriptor Control Queue 3:0	R/W	367
Transmit	03838h: 03B38h	TDWBAL	Transmit Descriptor WB Address Low Queue 3:0	R/W	369
Transmit	0383Ch: 03B3C	TDWBAH	Transmit Descriptor WB Address High Queue 3:0	R/W	370
Statistics	04000h	CRCERRS	CRC Error Count	RC	416
Statistics	04004h	ALGNERRC	Alignment Error Count	RC	417
Statistics	04008h	SYMERRS	Symbol Error Count	RC	417
Statistics	0400Ch	RXERRC	RX Error Count	RC	417
Statistics	04010h	MPC	Missed Packets Count	RC	417



Category	Offset	Abbreviation	Name	R/W	Page
Statistics	04014h	SCC	Single Collision Count	RC	418
Statistics	04018h	ECOL	Excessive Collisions Count	RC	418
Statistics	0401Ch	MCC	Multiple Collision Count	RC	418
Statistics	04020h	LATECOL	Late Collisions Count	RC	418
Statistics	04028h	COLC	Collision Count	RC	418
Statistics	04030h	DC	Defer Count	RC	419
Statistics	04034h	TNCRS	Transmit - No CRS	RC	419
Statistics	04040h	RLEC	Receive Length Error Count	RC	419
Statistics	04048h	XONRXC	XON Received Count	RC	419
Statistics	0404Ch	XONTXC	XON Transmitted Count	RC	420
Statistics	04050h	XOFFRXC	XOFF Received Count	RC	420
Statistics	04054h	XOFFTXC	XOFF Transmitted Count	RC	420
Statistics	04058h	FCRUC	FC Received Unsupported Count	RC	420
Statistics	0405Ch	PRC64	Packets Received (64 Bytes) Count	RC	421
Statistics	04060h	PRC127	Packets Received (65-127 Bytes) Count	RC	421
Statistics	04064h	PRC255	Packets Received (128-255 Bytes) Count	RC	421
Statistics	04068h	PRC511	Packets Received (256-511 Bytes) Count	RC	421
Statistics	0406Ch	PRC1023	Packets Received (512-1023 Bytes) Count	RC	422
Statistics	04070h	PRC1522	Packets Received (1024-Max Bytes)	RC	422
Statistics	04074h	GPRC	Good Packets Received Count	RC	422
Statistics	04078h	BPRC	Broadcast Packets Received Count	RC	423
Statistics	0407Ch	MPRC	Multicast Packets Received Count	RC	423
Statistics	04080h	GPTC	Good Packets Transmitted Count	RC	423
Statistics	04088h	GORCL	Good Octets Received Count (Low)	RC	424
Statistics	0408Ch	GORCH	Good Octets Received Count (Hi)	RC	424
Statistics	04090h	GOTCL	Good Octets Transmitted Count (Low)	RC	424
Statistics	04094h	GOTCH	Good Octets Transmitted Count (Hi)	RC	424
Statistics	040A0h	RNBC	Receive No Buffers Count	RC	424
Statistics	040A4h	RUC	Receive Undersize Count	RC	425
Statistics	040A8h	RFC	Receive Fragment Count	RC	425
Statistics	040ACh	ROC	Receive Oversize Count	RC	425
Statistics	040B0h	RJC	Receive Jabber Count	RC	425
Statistics	040B4h	MNGPRC	Management Packets Received Count	RC	426
Statistics	040B8h	MPDC	Management Packets Dropped Count	RC	426
Statistics	040BCh	MNGPTC	Management Pkts Transmitted Count	RC	426
Statistics	040C0h	TORL	Total Octets Received (Lo)	RC	427
Statistics	040C4h	TORH	Total Octets Received (Hi)	RC	427
Statistics	040C8h	TOTL	Total Octets Transmitted (Low)	RC	427
Statistics	040CCh	TOTH	Total Octets Transmitted (Hi)	RC	427
Statistics	040D0h	TPR	Total Packets Received	RC	427
Statistics	040D4h	TPT	Total Packets Transmitted	RC	428
Statistics	040D8h	PTC64	Packets Transmitted (64 Bytes) Count	RC	428
Statistics	040DCh	PTC127	Packets Transmitted (65-127 Bytes) Count	RC	428
Statistics	040E0h	PTC255	Packets Transmitted (128-255 Bytes) Count	RC	429
Statistics	040E4h	PTC511	Packets Transmitted (256-511 Bytes) Count	RC	429



Category	Offset	Abbreviation	Name	R/W	Page
Statistics	040E8h	PTC1023	Packets Transmitted (512-1023 Bytes) Count	RC	429
Statistics	040ECh	PTC1522	Packets Transmitted (1024-1522) Count	RC	429
Statistics	040F0h	MPTC	Multicast Packets Transmitted Count	RC	430
Statistics	040F4h	BPTC	Broadcast Packets Transmitted Count	RC	430
Statistics	040F8h	TSCTC	TCP Segmentation Context Transmitted Count	RC	430
Statistics	04100h	IAC	Interrupt Assertion Count	RC	431
Statistics	04104h	RPTHC	Rx Packets to Host Count	RC	431
Statistics	04118h	TXQEC	Tx Queue Empty Count	RC	431
Statistics	04120h	RXDMTC	Rx Descriptor Minimum Threshold Count	RC	431
Statistics	04124h	ICRXOC	Interrupt Cause Rx Overrun Count	RC	431
Statistics	04228h	SCVPC	SerDes/SGMII Code Violation Packet Count	R/WS	432
Wakeup	05800h	WUC	Wake Up Control	R/W	385
Wakeup	05808h	WUFC	Wakeup Filter Control	R/W	386
Wakeup	05810h	WUS	Wakeup Status	R/W1C	387
Wakeup	05838h	IPAV	IP Address Valid	R/W	387
Wakeup	05840h-05858h	IP4AT	IPv4 Address Table	R/W	388
Wakeup	05880h-0588Fh	IP6AT	IPv6 Address Table	R/W	388
Wakeup	05900h	WUPL	Wakeup Packet Length	RC	389
Wakeup	05A00h-05A7Ch	WUPM	Wakeup Packet Memory	RC	389
Wakeup	09000h-093F8h	FFMT	Flexible Filter Mask Table	R/W	389
Wakeup	09800h-09BF8h	FFVT	Flexible Filter Value Table	R/W	390
Wakeup	05F00h-05F18h	FFLT	Flexible Filter Length Table	R/W	390
MNG	05010h-0502Ch	MAVTV	VLAN TAG Value 0:7	R/W	391
MNG	05030h-0504Ch	MFUTP[7:0]	Management Flex UDP/TCP Ports	R/W	392
MNG	05820h	MANC	Management Control	R/W	392
MNG	05824h	MFVAL	Manageability Filters Valid	R/W	393
MNG	05860h	MANC2H	Management Control to Host	R/W	394
MNG	05890h-058ACh	MDEF[7:0]	Manageability Decision Filters	R/W	394
MNG	058B0h-058ECh	MIPAF	Manageability IP Address Filter	R/W	395
MNG	05910h:05928h	MMAL[3:0]	Manageability MAC Address Low 3:0	R/W	398
MNG	05914h:0592Ch	MMAH[3:0]	Manageability MAC Address High 3:0	R/W	398
MNG	09400h-097F8h	FTFT	Flexible TCO Filter Table	R/W	398
PCIe*	05B00h	GCR	PCIe* Control	R/W	400
PCIe*	05B08h	FUNCTAG	Function Tag	R/W	403
PCIe*	05B10h	GSCL_1	PCIe* statistics Control #1	R/W	403
PCIe*	05B14h	GSCL_2	PCIe* statistics Control #2	R/W	403





Category	Offset	Abbreviation	Name	R/W	Page
PCIe*	05B18h	GSCL_3	PCIe* statistics Control #3	R/W	407
PCIe*	05B1Ch	GSCL_4	PCIe* statistics Control #4	R/W	407
PCIe*	05B20h	GSCN_0	PCIe* Counter #0	R/W	407
PCIe*	05B24h	GSCN_1	PCIe* Counter #1	R/W	407
PCIe*	05B28h	GSCN_2	PCIe* Counter #2	R/W	408
PCIe*	05B2Ch	GSCN_3	PCIe* Counter #3	R/W	408
PCIe*	05B30h	FACTPS	Function Active and Power State to MNG	R/W	408
PCIe*	05B34h	GIOANACTL0	SerDes/CCM/PCIe* CSR	R/W	409
PCIe*	05B38h	GIOANACTL1	SerDes/CCM/PCIe* CSR	R/W	409
PCIe*	05B3Ch	GIOANACTL2	SerDes/CCM/PCIe* CSR	R/W	409
PCIe*	05B40h	GIOANACTL3	SerDes/CCM/PCIe* CSR	R/W	410
PCIe*	05B44h	GIOANACTLALL	SerDes/CCM/PCIe* CSR	R/W	410
PCIe*	05B48h	CCMCTL	SerDes/CCM/PCIe* CSR	R/W	410
PCIe*	05B4Ch	SCCTL	SerDes/CCM/PCIe* CSR	R/W	410
PCIe*	05B50h	SWSM	Software Semaphore	R/W	411
PCIe*	05B54h	FWSM	Firmware Semaphore	R/WS	411
PCIe*	05B5Ch	SW_FW_SYNC	Software-Firmware Synchronization	R/WS	413
PCIe*	05B64h	MREVID	Mirrored Revision ID	RO	415
PCIe*	05B68h	PBACL	MSI-X PBA Clear	R/W1C	415
PCIe*	05B70h	DCA_ID	DCA Requester ID Information	RO	415
PCIe*	05B74h	DCA_CTRL	DCA Control	R/W	416
Diagnostic	02410h	RDFH	Receive Data FIFO Head	R/W	432
Diagnostic	02418h	RDFT	Receive Data FIFO Tail	R/W	432
Diagnostic	02420h	RDFHS	Receive Data FIFO Head Saved	R/W	433
Diagnostic	02428h	RDFTS	Receive Data FIFO Tail Saved	R/W	433
Diagnostic	02430h: 0243Ch	RDFPCQ	Receive Data FIFO Packet Count Queue 3:0	R/W	433
Diagnostic	02458h	PBDIAG	PB Diagnostic	R/W	434
Diagnostic	02454h	PBDESCRP	Rx and PB Descriptor Read Pointer	RO	434
Diagnostic	0245Ch	PBECCSTS	Packet Buffer ECC Control	RC	436
Diagnostic	02468h	RDHESTS	Rx Descriptor Handler ECC Status	RO	437
Diagnostic	0246Ch	TDHESTS	Tx Descriptor Handler ECC Status	RO	437
Diagnostic	03438h	PBEEI	Packet Buffer ECC Error Inject	R/W	436
Diagnostic	025F8h	RDHEEI	Rx Descriptor Handler ECC Error Injection	R/W	440
Diagnostic	035F8h	TDHEEI	Tx Descriptor Handler ECC Error Injection	R/W	441
Diagnostic	025FCh	RDHMP	Rx Descriptor Handler Memory Page Number	R	439
Diagnostic	03400h	PBMPN	Packet Buffer memory Page Number	R/W	438
Diagnostic	03410h	TDFH	Transmit Data FIFO Head	R/W	434
Diagnostic	03418h	TDFT	Transmit Data FIFO Tail	R/W	435
Diagnostic	03420h	TDFHS	Transmit Data FIFO Head Saved	R/W	435
Diagnostic	03428h	TDFTS	Transmit Data FIFO Tail Saved	R/W	435
Diagnostic	03430h	TDFPC	Transmit Data FIFO Packet Count	R/W	436
Diagnostic	035FCh	TDHMP	Tx Descriptor Handler Memory Page Number	R/W	439
Diagnostic	10000h- 10FFCh	PBM	Packet Buffer Memory (n)	R/W	438

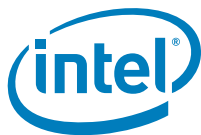

Category	Offset	Abbreviation	Name	R/W	Page
Packet Generator	04280h	PGDAL	PG Destination Address Low	R/W	441
Packet Generator	04284h	PGDAH	PG Destination Address High	R/W	441
Packet Generator	04288h	PGSAL	PG Source Address Low	R/W	442
Packet Generator	0428Ch	PGSAH	PG Source Address High	R/W	442
Packet Generator	04290h	PGIPG	PG Inter Packet Gap	R/W	442
Packet Generator	04294h	PGPL	PG Packet Length	R/W	443
Packet Generator	04298h	PGNP	PG Number Of Packets	R/W	443
Packet Generator	0429Ch	PGSTS	PG Status	RO	444
Packet Generator	042A4h	PGCTL	PG Control	R/W	444
PCS	04200h	PCS_CFG	PCS Configuration 0	R/W	370
PCS	04208h	PCS_LCTL	PCS Link Control	R/W	371
PCS	0420Ch	PCS_LSTS	PCS Link Status	RO	372
PCS	04218h	PCS_ANADV	AN Advertisement	R/W	373
PCS	0421Ch	PCS_LPAB	Link Partner Ability	RO	374
PCS	04220h	PCS_NPTX	AN Next Page Transmit	R/W	375
PCS	04224h	PCS_LPABNP	Link Partner Ability Next Page	RO	376
MSI-X	00000h: 00090h	MSIXTADD	MSI-X Table Entry Lower Address	R/W	446
MSI-X	00004h: 00094h	MSIXTUADD	MSI-X Table Entry Upper Address	R/W	446
MSI-X	00008h: 00098h	MSIXTMSG	MSI-X Table Entry Message	R/W	446
MSI-X	0000Ch: 0009Ch	MSIXTVCTRL	MSI-X Table Vector Control	R/W	446
MSI-X	02000h: 02004h	MSIXPBA	MSI-X Pending Bit Array	RO	447

**Note:** The PHY registers are accessed through the MDI/O interface.

## 14.3 Main Register Descriptions

This section contains detailed register descriptions for general purpose, DMA, interrupt, receive, and transmit registers. These registers correspond to the main functions of the 82575.



### 14.3.1 Device Control Register - CTRL (00000h; R/W)

This register, as well as the Extended Device Control register (CTRL\_EXT), controls the major operational modes for the 82575. While software writes to this register to control the 82575 settings, several bits (such as *FD* and *SPEED*) can be overridden depending on other bit settings and the resultant link configuration determined by the PHY's Auto-Negotiation resolution.

**Note:** In half-duplex mode, the 82575 transmits carrier extended packets and can receive both carrier extended packets and packets transmitted with bursting.

When using an internal PHY or SGMII, the *FD* (duplex) and *SPEED* configuration of the 82575 is normally determined from the link configuration process. Software can specifically override/set these 82575 MAC settings via these bits in a forced-link scenario; if so, the values used to configure the 82575 MAC must be consistent with the PHY settings.

When operating in SerDes mode, the *SPEED* field value is ignored. In SerDes mode with Auto-Negotiation enabled, the *FD* bit is set to the negotiated duplex value.

If hardware AN is enabled, the transmitter sends configuration words until AN completes.

When the 82575 MAC is operating in a 10/100/1000BASE-T (internal PHY) mode, manual link configuration is controlled through the PHY's 10/100BASE-T management interface.

A signal called LOS (loss-of-signal) indicates when no laser light is being received when the 82575 is used in a 1000BASE-SX or -LX implementation. This prevents false carrier cases occurring when transmission out a non-existent fiber couples into the input. Note that there is no standard polarity for this signal coming from different manufacturers. The *ILOS* bit provides for inversion of the signal from different external SerDes vendors and should be set when external SerDes provides a negative-true loss-of-signal. This bit also inverts the LINK input that provides link status indication from the PHY (in 10/100/1000BASE-T mode) and therefore should be set to 0b for proper internal PHY operation.

The *ADVD3WUC* bit (Advertise D3Cold Wakeup Capability Enable control) enables the AUX\_PWR pin to determine whether D3Cold support is advertised. If full 1Gb/s operation in D3 state is desired but the system's power requirements in this mode would exceed the D3Cold Wakeup-Enabled specification limit (375 mA at 3.3V), this bit can be used to prevent the capability from being advertised to the system.

When using the internal PHY, by default the PHY re-negotiates the lowest functional link speed in D3 and D0u states. The *LPLU* bit enables this capability to be disabled, if full 1Gb/s speed is desired in these states.

**Note:** The 82575's internal PHY automatically detects an unplugged LAN cable and reduces operational power to the minimal amount required to maintain system operation. 82575 operations is not affected except for the inability to transmit/receive due to the lost link.

Device Reset (RST) can be used to globally reset the entire 82575. This register is provided as a software mechanism to recover from an indeterminate or suspected hung hardware state. Most registers (receive, transmit, interrupt, statistics, etc.), and state machines are set to their power-on reset values, approximating the state following a power-on or PCI reset. However, PCIe\* configuration registers are not reset, thereby leaving the 82575 mapped into system memory space and accessible by a software device driver. One internal configuration register, Packet Buffer Allocation (PBA), also retains its value through a global reset.

**Note:** To ensure that global device reset has fully completed and that the 82575 responds to subsequent accesses, an approximate one microsecond wait is required, after setting, before attempting to check to see if the bit has cleared or to access (read or write) any other 82575 register.



Field	Bit(s)	Initial Value	Description
FD	0	1b	Full-Duplex Controls the MAC duplex setting when explicitly set by software. 0b = half duplex. 1b = full duplex.
Reserved	1	0b	This bit is reserved and should be set to 0b for future compatibility.
GIO Master Disable	2	0b	When set to 1b, the function of this bit blocks new master requests including manageability requests. If no master requests are pending by this function, the <i>GIO Master Enable Status</i> bit is set.
Reserved	3	1b <sup>1</sup>	Reserved
Reserved	4	0b <sup>1</sup>	Reserved Factory use only. Should be written with 0b.
Reserved	5	0b <sup>1</sup>	Reserved Must be set to 0b.
SLU	6	0b <sup>1</sup>	Set Link Up When the MAC link mode is set for 10/100/1000Base-T mode (internal PHY), Set Link Up must be set to 1b to permit the MAC to recognize the LINK signal from the PHY, which indicates the PHY has gotten the link up, and to receive and transmit data. The Set Link Up is normally initialized to 0b. However, if the <i>APM Enable</i> bit (bit 10) of Word 14/24 is set in the EEPROM then it is initialized to 1b.
ILOS	7	0b <sup>1</sup>	Invert Loss-of-Signal (LOS/LINK) Signal 0b = Do not invert (active high input signal). 1b = Invert signal (active low input signal).
SPEED	9:8	10b	Speed selection. These bits determine the speed configuration and are written by software after reading the PHY configuration through the MDIO interface. These signals are ignored when Auto-Speed Detection is enabled. 00b = 10 Mb/s. 01b = 100 Mb/s. 10b = 1000 Mb/s. 11b = not used.
Reserved	10	0b	Reserved Write as 0b to ensure future compatibility.
FRCSPEED	11	0b <sup>1</sup>	Force Speed This bit is set when software needs to manually configure the MAC speed settings according to the SPEED bits. When using a PHY device, note that the PHY device must resolve to the same speed configuration or software must manually set it to the same speed as the MAC. The default is asserted. Software must clear this bit to enable the PHY or ASD function to control the MAC speed setting. Note that this bit is superseded by the CTRL_EXT.SPD_BYSPS bit which has a similar function.
FRCDPLX	12	0b	Force Duplex When set to 1b, software can override the duplex indication from the PHY that is indicated in the FDX to the MAC. Otherwise, in 10/100/1000Base-T link mode, the duplex setting is sampled from the PHY FDX indication into the MAC on the asserting edge of the PHY LINK signal. When asserted, the <i>CTRL.FD</i> bit sets duplex.
Reserved	15:13	000b	Reserved Reads as 000b.



Field	Bit(s)	Initial Value	Description
SDP0_GPIEN	16	0b	General Purpose Interrupt Detection Enable for SDP0 If software-controlled IO pin SDP0 is configured as an input, this bit (when 1b) enables the use for GPI interrupt detection.
SDP1_GPIEN	17	0b	General Purpose Interrupt Detection Enable for SDP1 If software-controlled IO pin SDP1 is configured as an input, this bit (when 1b) enables the use for GPI interrupt detection.
SDP0 DATA (RWS)	18	0b <sup>1</sup>	SDP0 Data Value Used to read or write the value of software-controlled IO pin SDP0. If SDP0 is configured as an output (SDP0_IODIR = 1b), this bit controls the value driven on the pin (initial value EEPROM-configurable). If SDP0 is configured as an input, reads return the current value of the pin. When the SDP0_WDE bit is set, this field indicates the polarity of the watchdog indication.
SDP1 DATA (RWS)	19	0b <sup>1</sup>	SDP1 Data Value Used to read or write the value of software-controlled IO pin SDP1. If SDP1 is configured as an output (SDP1_IODIR = 1b), this bit controls the value driven on the pin (initial value EEPROM-configurable). If SDP0 is configured as an input, reads return the current value of the pin.
ADV3WUC	20	1b <sup>1</sup>	D3Cold Wakeup Capability Advertisement Enable When set, D3Cold wakeup capability is advertised based on whether AUX_PWR advertises presence of auxiliary power (yes if AUX_PWR is indicated, no otherwise). When 0b, however, D3Cold wakeup capability is not advertised even if AUX_PWR presence is indicated. Note that the initial value is EEPROM configurable.
SDP0_WDE	21	0b <sup>1</sup>	SDP0 used for Watchdog indication When set, SDP0 is used as a watchdog indication. When set, the SDP0_DATA bit indicates the polarity of the watchdog indication. In this mode, SDP0_IODIR must be set to an output.
SDP0_IODIR	22	0b <sup>1</sup>	SDP0 Pin Directionality Controls whether software-controllable pin SDP0 is configured as an input or output (0b = input, 1b = output). Initial value is EEPROM-configurable. This bit is not affected by software or system reset, only by initial power-on or direct software writes.
SDP1_IODIR	23	0b <sup>1</sup>	SDP1 Pin Directionality Controls whether software-controllable pin SDP1 is configured as an input or output (0b = input, 1b = output). Initial value is EEPROM-configurable. This bit is not affected by software or system reset, only by initial power-on or direct software writes.
Reserved	25:24	0b <sup>1</sup>	Reserved. Formerly used as SDP3 and SDP2 pin input/output direction control, respectively.
RST	26	0b	Device Reset This bit performs a reset of the entire 82575, resulting in a state nearly approximating the state following a power-up reset or internal PCIe* reset, except for system PCI configuration. 0b = Normal. 1b = Reset. This bit is self clearing and is referred to as software reset or global reset.
RFCE	27	0b	Receive Flow Control Enable When set, indicates that the 82575 responds to the reception of flow control packets. Reception of flow control packets requires the correct loading of the FCAL/H and FCT registers. If Auto-Negotiation is enabled, this bit is set to the negotiated duplex value.
TFCE	28	0b	Transmit Flow Control Enable When set, indicates that the 82575 transmits flow control packets (XON and XOFF frames) based on the receiver fullness. If Auto-Negotiation is enabled, this bit is set to the negotiated duplex value.



Field	Bit(s)	Initial Value	Description
Reserved	29	0b	Reserved Should be written with 0b to ensure future compatibility. Read as 0b.
VME	30	0b	VLAN Mode Enable When set to 1b, all packets transmitted from the 82575 that have <i>VLE</i> bit set in their descriptor is sent with an 802.1Q header added to the packet. The contents of the header come from the transmit descriptor and from the VLAN type register. On receive, VLAN information is stripped from 802.1Q packets.
PHY_RST	31	0b	PHY Reset Controls a hardware-level reset to the internal PHY. 0b = Normal operation. 1b = PHY reset asserted.

1. If the signature bits of the EEPROM's Initialization Control Word 1 match (01b), these bits are read from the EEPROM.

### 14.3.2 Device Status Register - STATUS (00008h; R)

This register provides software status for the 82575's settings and modes of operation.

Field	Bit(s)	Initial Value	Description
FD	0	X	Full-Duplex FD reflects the actual MAC duplex configuration. This normally reflects the duplex setting for the entire link, as it normally reflects the duplex configuration negotiated between the PHY and link partner (copper link) or MAC and link partner (fiber link). 0b = half duplex. 1b = full duplex.
LU	1	X	Link Up For this bit to be valid, the <i>Set Link Up</i> bit in the Device Control Register (CTRL.SU) must be set. Link up provides a useful indication of whether something is attached to the port. Successful negotiation of features/link parameters results in link activity. The link startup process (and consequently the duration for this activity after reset) can be several 100's of ms. When the MAC is operating in 10/100/1000BASE-T mode (internal PHY), this reflects whether the PHY's LINK indication is present. If Auto-Negotiation is enabled, this can also indicate successful auto-negotiation. 0b = No link established. 1b = Link established.
LAN ID	3:2	0b	LAN ID Provides software a mechanism to determine the LAN identifier for the MAC. 00b = LAN 0. 01b = LAN 1.
TXOFF	4	X	Transmission Paused This bit indicates the state of the transmit function when symmetrical flow control has been enabled and negotiated with the link partner. This bit is set to 1b when transmission is paused due to the reception of an XOFF frame. It is cleared (0b) upon expiration of the pause timer or the receipt of an XON frame.
Reserved	5	X	Reserved



Field	Bit(s)	Initial Value	Description
SPEED	7:6	X	<p>Link Speed Setting</p> <p>Reflects the speed setting of the MAC and/or link when it is operating in 10/100/1000BASE-T mode (internal PHY).</p> <p>When the MAC is operating in 10/100/1000BASE-T mode with the internal PHY, these bits normally reflect the speed of the actual link, negotiated by the PHY and link partner and reflected internally from the PHY to the MAC (SPD_IND). These bits also might represent the speed configuration of the MAC only, if the MAC speed setting has been forced via software (CTRL.SPEED) or if MAC auto-speed detection is used.</p> <p>If Auto-Speed Detection is enabled, the 82575's speed is configured only once after the LINK signal is asserted by the PHY.</p> <p>00b = 10 Mb/s. 01b = 100 Mb/s. 10b = 1000 Mb/s. 11b = 1000 Mb/s.</p>
ASDV	9:8	X	<p>Auto-Speed Detection Value</p> <p>Speed result sensed by the 82575's MAC auto-detection function.</p> <p>These bits are provided for diagnostics purposes only. The ASD calculation can be initiated by software writing a logic 1b to the CTRL_EXT.ASDCHK bit. The resultant speed detection is reflected in these bits.</p>
PHYRA	10	1b	<p>PHY Reset Asserted</p> <p>This read/write bit is set by hardware following the assertion of a PHY reset; it is cleared by writing a 0b to it. This bit is also used by firmware indicating a required initialization of the 82575's PHY.</p>
Reserved	18:11	0h	Reserved
GIO Master Enable Status	19	1b	This bit is cleared by the 82575 when the <i>GIO Master Disable</i> bit is set and no master requests are pending by this function. Indicates that no master requests are issued by this function as long as the <i>GIO Master Disable</i> bit is set.
Reserved	30:20	0h	Reserved
DMA Clock Gating Enable	31	0b <sup>1</sup>	<p>DMA clock gating <i>Enable</i> bit loaded from the EEPROM.</p> <p>Indicates that the 82575 supports DMA clock gating.</p>

1. If the signature bits of the EEPROM's Initialization Control Word 1 match (01b), this bit is read from the EEPROM.

### 14.3.3 EEPROM/Flash Control Register - EEC (00010h; R/W)

This register provides software direct access to the EEPROM. Software can control the EEPROM by successive writes to this register. Data and address information is clocked into the EEPROM by software toggling the EE\_SK and EE\_DI bits (0 and 2) of this register with EE\_CS set to 0b. Data output from the EEPROM is latched into the EE\_DO bit (bit 3) via the internal 62.5 MHz clock and can be accessed by software via reads of this register.

**Note:** Attempts to write to the FLASH device when writes are disabled (FWE is not equal to 10b) should not be attempted. Behavior after such an operation is undefined and can result in component and/or system hangs.



Field	Bit	Initial Value	Description
EE_SK	0	0b	Clock input to the EEPROM When EE_GNT = 1b, the EE_SK output signal is mapped to this bit and provides the serial clock input to the EEPROM. Software clocks the EEPROM via toggling this bit with successive writes.
EE_CS	1	0b	Chip select input to the EEPROM When EE_GNT = 1b, the EE_CS output signal is mapped to the chip select of the EEPROM device. Software enables the EEPROM by writing a 1b to this bit.
EE_DI	2	0b	Data input to the EEPROM When EE_GNT = 1b, the EE_DI output signal is mapped directly to this bit. Software provides data input to the EEPROM via writes to this bit.
EE_DO (RO)	3	X	Data output bit from the EEPROM The EE_DO input signal is mapped directly to this bit in the register and contains the EEPROM data output. This bit is RO from a software perspective; writes to this bit have no effect.
FWE	5:4	01b	Flash Write Enable Control These two bits, control whether writes to Flash memory are allowed. 00b = Flash erase (along with bit 31 in the FLA register). 01b = Flash writes disabled. 10b = Flash writes enabled. 11b = Not allowed.
EE_REQ	6	0b	Request EEPROM Access The software must write a 1b to this bit to get direct EEPROM access. It has access when EE_GNT is 1b. When the software completes the access it must write a 0b.
EE_GNT	7	0b	Grant EEPROM Access When this bit is 1b the software can access the EEPROM using the SK, CS, DI, and DO bits.
EE_PRES (RO)	8	1b	EEPROM Present This bit indicates that an EEPROM is present by monitoring the EE_DO input for an active-low acknowledge by the serial EEPROM during initial EEPROM scan. 1b = EEPROM present.
Auto_RD (RO)	9	0b	EEPROM Auto Read Done When set to 1b, this bit indicates that the auto read by hardware from the EEPROM is done. This bit is also set when the EEPROM is not present or when its signature is not valid.





Field	Bit	Initial Value	Description																																	
EE_ADDR_SIZE	10	0b	<p>EEPROM Address Size</p> <p>This field defines the address size of the EEPROM.</p> <p>This bit is set by the EEPROM size auto-detect mechanism. If no EEPROM is present or the signature is not valid, a 16-bit address is assumed.</p> <p>0b = 8- and 9-bit. 1b = 16-bit.</p>																																	
EE_SIZE (RO)	14:11 <sup>1</sup>	0010b	<p>EEPROM Size</p> <p>This field defines the size of the EEPROM:</p> <table border="1"> <thead> <tr> <th>Field Value</th> <th>EEPROM Size</th> <th>EEPROM Address Size</th> </tr> </thead> <tbody> <tr> <td>0000b</td> <td>128 bytes</td> <td>1 byte</td> </tr> <tr> <td>0001b</td> <td>256 bytes</td> <td>1 byte</td> </tr> <tr> <td>0010b</td> <td>512 bytes</td> <td>1 byte</td> </tr> <tr> <td>0011b</td> <td>1 KB</td> <td>2 bytes</td> </tr> <tr> <td>0100b</td> <td>2 KB</td> <td>2 bytes</td> </tr> <tr> <td>0101b</td> <td>4 KB</td> <td>2 bytes</td> </tr> <tr> <td>0110b</td> <td>8 KB</td> <td>2 bytes</td> </tr> <tr> <td>0111b</td> <td>16 KB</td> <td>2 bytes</td> </tr> <tr> <td>1000b</td> <td>32 KB</td> <td>2 bytes</td> </tr> <tr> <td>1001b:1111b</td> <td>Reserved</td> <td>Reserved</td> </tr> </tbody> </table>	Field Value	EEPROM Size	EEPROM Address Size	0000b	128 bytes	1 byte	0001b	256 bytes	1 byte	0010b	512 bytes	1 byte	0011b	1 KB	2 bytes	0100b	2 KB	2 bytes	0101b	4 KB	2 bytes	0110b	8 KB	2 bytes	0111b	16 KB	2 bytes	1000b	32 KB	2 bytes	1001b:1111b	Reserved	Reserved
Field Value	EEPROM Size	EEPROM Address Size																																		
0000b	128 bytes	1 byte																																		
0001b	256 bytes	1 byte																																		
0010b	512 bytes	1 byte																																		
0011b	1 KB	2 bytes																																		
0100b	2 KB	2 bytes																																		
0101b	4 KB	2 bytes																																		
0110b	8 KB	2 bytes																																		
0111b	16 KB	2 bytes																																		
1000b	32 KB	2 bytes																																		
1001b:1111b	Reserved	Reserved																																		
Reserved	31:15	0b	<p>Reserved</p> <p>Reads as 0b.</p>																																	

1. These bits are read from the EEPROM.

### 14.3.4 EEPROM Read Register - EERD (00014h; RW)

This register is used by software to cause the 82575 to read individual words in the EEPROM. To read a word, software writes the address to the *Read Address* field and simultaneously writes a 1b to the *Start Read* field. The 82575 reads the word from the EEPROM and places it in the *Read Data* field, setting the *Read Done* field to 1b. Software can poll this register, looking for a 1b in the *Read Done* field, and then using the value in the *Read Data* field.

When this register is used to read a word from the EEPROM, that word does not influence any of the 82575's internal registers even if it is normally part of the auto-read sequence.

Field	Bit(s)	Initial Value	Description
START	0	0b	<p>Start Read</p> <p>Writing a 1b to this bit causes the EEPROM to read a (16-bit) word at the address stored in the EE_ADDR field and then storing the result in the EE_DATA field. This bit is self-clearing.</p>



DONE	1	0b	Read Done Set to 1b when the EEPROM read completes. Set to 0b when the EEPROM read is in progress. Writes by software are ignored.
ADDR	15:2	0h	Read Address This field is written by software along with <i>Start Read</i> to indicate the word to read.
DATA (RO)	31:16	X	Read Data. Data returned from the EEPROM read.

### 14.3.5 Extended Device Control Register - CTRL\_EXT (00018h, R/W)

This register provides extended control of the 82575's functionality beyond that provided by the Device Control register (CTRL).

The 82575 allows up to four externally controlled interrupts. All software-definable pins, can be mapped for use as GPI interrupt bits. These mappings are enabled by the SDPx\_GPIEN bits only when these signals are also configured as inputs via SDPx\_IODIR. When configured to function as external interrupt pins, a GPI interrupt is generated when the corresponding pin is sampled in an active-high state.

The bit mappings are shown in [Table 88](#) for clarity.

**Table 88. Bit Mappings**

SDP Pin Used as GPI	CTRL_EXT Field Settings		Resulting ICR Bit (GPI)
	Directionality	Enable as GPI interrupt	
3	SDP3_IODIR	SDP3_GPIEN	14
2	SDP2_IODIR	SDP2_GPIEN	13
1	SDP1_IODIR	SDP1_GPIEN	12
0	SDP0_IODIR	SDP0_GPIEN	11

**Note:**

1. If software uses the EE\_RST function and desires to retain current configuration information, the contents of the control registers should be read and stored by software. Control register values are changed by a read of the EEPROM which occurs upon assertion of the EE\_RST bit.
2. The EEPROM reset function can read configuration information out of the EEPROM which affects the configuration of PCIe\* space BAR settings. The changes to the BARs are not visible unless the system reboots and the BIOS is allowed to re-map them.
3. The SPD\_BYPS bit performs a similar function to the CTRL.FRCSPD bit in that the 82575's speed settings are determined by the value software writes to the CTRL.SPEED bits. However, with the SPD\_BYPS bit asserted, the settings in CTRL.SPEED take effect rather than waiting until after the 82575's clock switching circuitry performs the change.

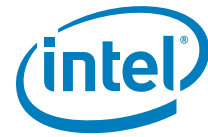

Field	Bit(s)	Initial Value	Description
NSICR	0	0b	Non Selective Interrupt clear on read When set, every read of ICR clears it. When this bit is cleared, an ICR read causes it to be cleared only if an actual interrupt was asserted or IMS = 0b. This bit should be cleared by software device drivers not using the extended interrupts capabilities and set otherwise.
Reserved	1	0b	Reserved. Should be written as 0b to ensure future compatibility.
SDP2_GPIEN	2	0b	General Purpose Interrupt Detection Enable for SDP2 If software-controllable IO pin SDP2 is configured as an input, this bit (when set to 1b) enables use for GPI interrupt detection.
SDP3_GPIEN	3	0b	General Purpose Interrupt Detection Enable for SDP3 If software-controllable IO pin SDP3 is configured as an input, this bit (when set to 1b) enables use for GPI interrupt detection.
Reserved	5:4	00b	Reserved. Reads as 00b.
SDP2_DATA	6	0b <sup>1</sup>	SDP2 Data Value. Used to read (write) the value of software-controllable IO pin SDP2. If SDP2 is configured as an output (SDP2_IODIR = 1b), this bit controls the value driven on the pin (initial value EEPROM-configurable). If SDP2 is configured as an input, reads return the current value of the pin.
SDP3_DATA	7	0b <sup>1</sup>	SDP3 Data Value. Used to read (write) the value of software-controllable IO pin SDP3. If SDP3 is configured as an output (SDP3_IODIR = 1b), this bit controls the value driven on the pin (initial value EEPROM-configurable). If SDP3 is configured as an input, reads return the current value of the pin.
Reserved	9:8	0b <sup>1</sup>	Reserved Formally used as SDP5 and SDP4 pin input/output direction control, respectively.
SDP2_IODIR	10	0b <sup>1</sup>	SDP2 Pin Directionality. Controls whether software-controllable pin SDP2 is configured as an input or output (0b = input, 1b = output). Initial value is EEPROM-configurable. This bit is not affected by software or system reset, only by initial power-on or direct software writes.
SDP3_IODIR	11	0b <sup>1</sup>	SDP3 Pin Directionality. Controls whether software-controllable pin SDP3 is configured as an input or output (0b = input, 1b = output). Initial value is EEPROM-configurable. This bit is not affected by software or system reset, only by initial power-on or direct software writes.
ASDCHK	12	0b	ASD Check Initiates an Auto-Speed-Detection (ASD) sequence to sense the frequency of the PHY receive clock (RX_CLK). The results are reflected in STATUS.ASDV. This bit is self-clearing.
EE_RST	13	0b	EEPROM Reset When set, initiates a reset-like event to the EEPROM function. This causes the EEPROM to be read as if a RST# assertion had occurred. All 82575 functions should be disabled prior to setting this bit. This bit is self-clearing.
RESERVED	14	0b	Reserved. Should be set to 0b.
SPD_BYP	15	0b	Speed Select Bypass When set to 1b, all speed detection mechanisms are bypassed, and the 82575 is immediately set to the speed indicated by CTRL.SPEED. This provides a method for software to have full control of the speed settings of the 82575 and when the change takes place by overriding the hardware clock switching circuitry.
NS_DIS	16	0	No Snoop Disable When set to 1b, the 82575 does not set the no snoop attribute in any PCIe* packet, independent of PCIe* configuration and the setting of individual no snoop enable bits. When set to 0b, behavior of no snoop is determined by PCIe* configuration and the setting of individual no snoop enable bits.



Field	Bit(s)	Initial Value	Description
RO-DIS	17	0b	Relaxed Ordering Disabled When set to 1b, the 82575 does not request any relaxed ordering transactions in PCIe* mode regardless of the state of bit 1 in the PCIe* command register. When this bit is cleared and bit 1 of the PCIe* command register is set, the 82575 requests relaxed ordering transactions as provided by registers RXCTL and TXCTL (per queue and per flow).
SerDes Low Power Enable	18	0b <sup>1</sup>	When set, allows the SerDes to enter a low power state when the function is in Dr state as described in <a href="#">Section 7.4.1.1</a> .
DMA Dynamic Gating Enable	19	0b <sup>1</sup>	When set, enables dynamic clock gating of the DMA and MAC units.
PHY Power Down Enable	20	1b <sup>1</sup>	When set, enables the PHY to enter a low-power state as described in <a href="#">Section 7.4.0.3</a> .
Reserved	21	0b	Reserved. Should be set to 0b.
LINK_MODE	23:22	0b <sup>1</sup>	Link Mode This controls which interface is used to talk to the link. 00b = Direct copper (1000Base-T) interface (10/100/1000Base-T internal PHY mode). 01b = Internal SerDes (legacy) interface. 10b = SGMII. 11b = Internal SerDes (new) interface.
EIAME	24	0b	Extended Interrupt Auto Mask Enable When set (usually in MSI-X mode), after sending an MSI-X message, bits set in EIAM associated with this message are cleared. Otherwise, EIAM is used only after a read or write of the EICR/EICS registers.
I2C Enabled	25	0b <sup>1</sup>	Enable I2C This bit enables the I <sup>2</sup> C bus that can be used to access SFP modules in the EEPROM. If cleared, the I <sup>2</sup> C pads are isolated and accesses through I2CCMD are ignored.
Extended VLAN	26	0b	Extended VLAN When set, all incoming Rx packets are expected to have at least one VLAN with the Ether type as defined in VET.EXT_VET that should be ignored. The packets can have a second VLAN that should be used for all filtering purposes. All Tx packets are expected to have at least one VLAN added to them by the host. In the case of an additional VLAN request (VLE) the second VLAN is added after the VLAN is added by the host. This bit should only be reset only by a PCIe* reset and should only be changed while Tx & Rx processes are stopped.
Reserved	27	0b	Reserved Was IAME.
DRV_LOAD	28	0b	Driver Loaded This bit should be set by the driver after it loaded. This bit should be cleared when the driver unloads or after a PCIe* soft reset. The MNG controller loads this bit to indicate to the manageability controller that the driver has loaded.
Reserved	29	0b	Reserved Reads as 0b.
MEHE	30	0b	Memory Error Handling Enable When set, the 82575 reactions to uncorrectable memory error detection is activated.
PBA_support	31	1b	PBA Support When set, setting one of the extended interrupts masks via EIMS causes the PBA bit of the associated MSI-X vector to be cleared. Otherwise, the 82575 behaves in a way supporting legacy INT-x interrupts. Should be cleared when working in INT-x or MSI mode and set in MSI-X mode.



1. These bits are read from the EEPROM.

### 14.3.6 Flash Access - FLA (0001Ch; R/W)

This register provides software direct access to the Flash. Software can control the Flash by successive writes to this register. Data and address information is clocked into the Flash by software toggling the FL\_SCK bit (bit 0) of this register with FL\_CE set to 1b. Data output from the Flash is latched into the FL\_SO bit (bit 3) of this register via the internal 125 MHz clock and can be accessed by software via reads of this register.

**Note:** In the 82575, the Flash Access register is only reset at Internal\_Power\_On\_Reset and not as legacy devices at a software reset.

Field	Bit(s)	Initial Value	Description
FL_SCK	0	0b	Clock Input to the FLASH When FL_GNT is 1b, the FL_SCK out signal is mapped to this bit and provides the serial clock input to the FLASH device. Software clocks the FLASH memory via toggling this bit with successive writes.
FL_CE	1	0b	Chip Select Input to the FLASH When FL_GNT is 1b, the FL_CE output signal is mapped to the chip select of the FLASH device. Software enables the FLASH by writing a 0b to this bit.
FL_SI	2	0b	Data Input to the FLASH When FL_GNT is 1b, the FL_SI output signal is mapped directly to this bit. Software provides data input to the FLASH via writes to this bit.
FL_SO	3	X	Data Output Bit from the FLASH The FL_SO input signal is mapped directly to this bit in the register and contains the FLASH memory serial data output. This bit is read only from the software perspective — writes to this bit have no effect.
FL_REQ	4	0b	Request FLASH Access The software must write a 1b to this bit to get direct FLASH memory access. It has access when FL_GNT is 1b. When the software completes the access it must write a 0b.
FL_GNT	5	0b	Grant FLASH Access When this bit is 1b, the software can access the FLASH memory using the FL_SCK, FL_CE, FL_SI, and FL_DO bits.
FLA_add_size	6	0b	FLASH Address Size When Flash_add_size is set, all flashes (including 64 KB) are accessed using 3 bytes of the address. If this bit is set by one of the functions, it is also reflected in the other one.
Reserved	29:7	0b	Reserved Reads as 0b.
FL_BUSY	30	0b	FLASH Busy This bit is set to 1b while a write or an erase to the FLASH memory is in progress. While this bit is clear (read as 0b) software can access to write a new byte to the FLASH device.
FL_ER	31	0b	FLASH Erase Command This command is sent to the FLASH component only if the EEC.FWE field is cleared. This bit is automatically cleared and read as 0b.



### 14.3.7 MDI Control Register - MDIC (00020h; R/W)

Software uses this register to read or write Management Data Interface (MDI) registers in the internal PHY or an external SGMII PHY.

For an MDI read cycle, the sequence of events is as follows:

- The processor performs a PCIe\* write cycle to the MII register with:
  - Ready = 0b
  - Interrupt Enable set to 1b or 0b
  - Opcode = 10b (read)
  - PHYADD = PHY address from the MDI register
  - REGADD = Register address of the specific register to be accessed (0 through 31)
- The MAC applies the following sequence on the MDIO signal to the PHY:  
<PREAMBLE><01><10><PHYADD><REGADD><Z> where Z stands for the MAC tri-stating the MDIO signal
- The PHY returns the following sequence on the MDIO signal:  
<0><DATA><IDLE>
- The MAC discards the leading bit and places the following 16 data bits in the MII register
- The 82575 asserts an interrupt indicating MDI "Done" if the *Interrupt Enable* bit was set
- The 82575 sets the *Ready* bit in the MII register indicating the Read is complete.
- The processor might read the data from the MII register and issue a new MDI command

For a MDI write cycle, the sequence of events is as follows:

- Ready = 0b
- Interrupt Enable set to 1b or 0b
- Opcode = 01b (write)
- PHYADD = PHY address from the MDI register
- REGADD = Register address of the specific register to be accessed (0 through 31)
- Data = Specific data for desired control of the PHY
- The MAC applies the following sequence on the MDIO signal to the PHY:  
<PREAMBLE><01><01><PHYADD><REGADD><10><DATA><IDLE>
- The 82575 asserts an interrupt indicating MDI "Done" if the *Interrupt Enable* bit was set
- The 82575 sets the *Ready* bit in the MII register to indicate that the write operation completed
- The CPU might issue a new MDI command

**Note:** An MDI read or write might take as long as 64  $\mu$ s from the processor write to the *Ready* bit assertion.

If an invalid opcode is written by software, the MAC does not execute any accesses to the PHY registers.

If the PHY does not generate a 0b as the second bit of the turn-around cycle for reads, the MAC aborts the access, sets the *E* (error) bit, writes FFFFh to the data field to indicate an error condition, and sets the *Ready* bit.

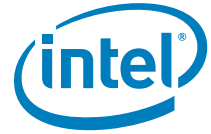

**Note:** After a PHY reset, access through the MDIC register should not be attempted for 300  $\mu$ s.

Field	Bit(s)	Initial Value	Description
DATA	15:0	X	Data In a Write command, software places the data bits and the MAC shifts them out to the PHY. In a Read command, the MAC reads these bits serially from the PHY and software can read them from this location.
REGADD	20:16	0b	PHY Register Address: Reg. 0, 1, 2, ...31
PHYADD	25:21	0b	PHY Address
OP	27:26	0b	Opcode 01b = MDI Write 10b = MDI Read All other values are reserved.
R (RWS)	28	0b	Ready Bit Set to 1b by the 82575 at the end of the MDI transaction (for example, indication of a Read or Write completion). It should be reset to 0b by software at the same time the command is written.
I	29	0b	Interrupt Enable When set to 1b by software, it causes an Interrupt to be asserted to indicate the end of an MDI cycle.
E (RWS)	30	0b	Error This bit is set to 1b by hardware when it fails to complete an MDI read. Software should make sure this bit is clear (0b) before issuing an MDI read or write command.
Destination	31	0b	Destination 0b = The transaction is to the internal PHY. 1b = The transaction is directed to the I <sup>2</sup> C Interface.

### 14.3.8 PHY Registers

This document uses a special nomenclature to define the read/write mode of individual bits in each register. See [Table 89](#).

For all binary equations appearing in the register map, the symbol “|” is equivalent to a binary OR operation.



**Table 89. PHY Register Bit Mode Definitions**

Register Mode	Description
LH	Latched High. Event is latched and erased when read.
LL	Latched Low. Event is latched and erased when read. For example, Link Loss is latched when the PHY Control Register bit 2 = 0b. After read, if the link is good, the PHY Control Register bit 2 is set to 1b.
RO	Read Only.
R/W	Read and Write.
SC	Self-Clear. The bit is set, automatically executed, and then reset to normal operation.
CR	Clear after Read. For example, 1000BASE-T Status Register bits 7:0 (Idle Error Counter).
Update	Value written to the register bit does not take effect until software PHY reset is executed.

### 14.3.8.1 PHY Control Register - PCTRL (00d; R/W)

Field	Bit(s)	Description	Mode	Default
Reserved	5:0	Reserved Always read as 0b. Write to 0b for normal operation	RW	Always 000000b
Speed Selection 1000 Mb/s (MSB)	6	Speed Selection is determined by bits 6 (MSB) and 13 (LSB) as follows. 11b = Reserved 10b = 1000 Mb/s 01b = 100 Mb/s 00b = 10 Mb/s  A write to these bits do not take effect until a software reset is asserted, Restart Auto-Negotiation is asserted, or Power Down transitions from power down to normal operation. <b>Note:</b> If auto-negotiation is enabled, this bit is ignored.	R/W	00b
Collision Test	7	1b = Enable COL signal test. 0b = Disable COL signal test. <b>Note:</b> This bit is ignored unless loopback is enabled (bit 14 = 1b).	R/W	0b
Duplex Mode	8	1b = Full Duplex. 0b = Half Duplex. <b>Note:</b> If auto-negotiation is enabled, this bit is ignored.	R/W	1b
Restart Auto-Negotiation	9	1b = Restart Auto-Negotiation Process. 0b = Normal operation.  Auto-Negotiation automatically restarts after hardware or software reset regardless of whether or not the restart bit is set.	WO, SC	0b
Isolate	10	This bit has no effect on PHY functionality. Program to 0b for future compatibility.	R/W	0b
Power Down	11	1b = Power down. 0b = Normal operation.  When using this bit, PHY default configuration is lost and is not loaded from the EEPROM after de-asserting the <i>Power Down</i> bit.	R/W	0b
Auto-Negotiation Enable	12	1b = Enable Auto-Negotiation Process. 0b = Disable Auto-Negotiation Process.  This bit must be enabled for 1000BASE-T operation.	R/W	1b





Field	Bit(s)	Description	Mode	Default
Speed Selection (LSB)	13	See Speed Selection (MSB), bit 6. <b>Note:</b> If auto-negotiation is enabled, this bit is ignored.	R/W	1b
Loopback	14	1b = Enable loopback. 0b = Disable loopback.	R/W	0b
Reset	15	1b = PHY reset. 0b = Normal operation. <b>Note:</b> When using PHY Reset, the PHY default configuration is not loaded from the EEPROM.	WO, SC	0b

### 14.3.8.2 PHY Status Register - PSTATUS (01d; R)

Field	Bit(s)	Description	Mode	Default
Extended Capability	0	1b = Extended register capabilities.	RO	1b
Jabber Detect	1	1b = Jabber condition detected. 0b = Jabber condition not detected.	RO LH	0b
Link Status	2	1b = Link is up. 0b = Link is down.	RO, LL	0b
Auto-Negotiation Ability	3	1b = PHY able to perform Auto-Negotiation. 0b = PHY is not able to perform Auto-Negotiation.	RO	1b
Remote Fault	4	1b = Remote fault condition detected. 0b = Remote fault condition not detected.	RO LH	0b
Auto-Negotiation Complete	5	1b = Auto-Negotiation process complete. 0b = Auto-Negotiation process not complete.	RO	0b
MF Preamble Suppression	6	0b = PHY does not accept management frames with preamble suppressed. 1b = PHY accepts management frames with preamble suppressed.	RO	0b
Reserved	7	Reserved. Ignore on reads.	RO	0b
Extended Status	8	1b = Extended status information in the Extended PHY Status Register (15d). 0b = No extended status information in the Extended PHY Status Register (15d).	RO	1b
100BASE-T2 Half Duplex	9	0b = PHY not able to perform half duplex 100BASE-T2. 1b = PHY able to perform half duplex 100BASE-T2 (not supported).	RO	0b
100BASE-T2 Full Duplex	10	0b = PHY not able to perform full duplex 100BASE-T2. 1b = PHY able to perform full duplex 100BASE-T2 (not supported).	RO	0b
10 Mb/s Half Duplex	11	1b = PHY able to perform half duplex 10BASE-T. 0b = PHY not able to perform half duplex 10BASE-T.	RO	1b
10 Mb/s Full Duplex	12	1b = PHY able to perform full duplex 10BASE-T. 0b = PHY not able to perform full duplex 10BASE-T.	RO	1b



Field	Bit(s)	Description	Mode	Default
100BASE-X Half Duplex	13	1b = PHY able to perform half duplex 100BASE-X. 0b = PHY able to perform half duplex 100BASE-X.	RO	1b
100BASE-X Full Duplex	14	1b = PHY able to perform full duplex 100BASE-X. 0b = PHY not able to perform full duplex 100BASE-X.	RO	1b
100BASE-T4	15	0b = PHY not able to perform 100BASE-T4. 1b = PHY able to perform 100BASE-T4.	RO	0b

### 14.3.8.3 PHY Identifier Register 1 (LSB) - PHY ID 1 (02d; R)

Field	Bit(s)	Description	Mode	Default
PHY ID Number	15:0	The PHY identifier composed of bits 3 through 18 of the Organizationally Unique Identifier (OUI)	RO	02A8h

### 14.3.8.4 PHY Identifier Register 2 (MSB) - PHY ID 2 (03d; R)

Field	Bit(s)	Description	Mode	Default
Manufacturer's Revision Number	3:0	4 bits containing the manufacturer's revision number.	RO	0h
Manufacturer's Model Number	9:4	6 bits containing the manufacturer's part number.	RO	38h
PHY ID Number	15:10	The PHY identifier composed of bits 19 through 24 of the OUI	RO	00h

### 14.3.8.5 Auto-Negotiation Advertisement Register - ANA (04d; R/W)

Field	Bit(s)	Description	Mode	Default
Selector Field	4:0	00001b = 802.3 Other combinations are reserved. Unspecified or reserved combinations should not be transmitted. <b>Note:</b> Setting this field to a value other than 00001b can cause auto negotiation to fail.	R/W	00001b
10Base-T	5	1b = DTE is 10BASE-T capable. 0b = DTE is not 10BASE-T capable.	R/W	1b
10Base-T Full Duplex	6	1b = DTE is 10BASE-T full duplex capable. 0b = DTE is not 10BASE-T full duplex capable.	R/W	1b
100Base-TX	7	1b = DTE is 100BASE-TX capable. 0b = DTE is not 100BASE-TX capable.	R/W	1b <sup>1</sup>
100BASE-TX Full Duplex	8	1b = DTE is 100BASE-TX full duplex capable. 0b = DTE is not 100BASE-TX full duplex capable.	R/W	1b <sup>1</sup>
100BASE-T4	9	0b = Not capable of 100BASE-T4. 1b = Capable of 100BASE-T4 (not supported).	R/W	0b



Field	Bit(s)	Description	Mode	Default
PAUSE	10	Advertise to Partner that Pause operation (as defined in 802.3x) is desired.	R/W	1b
ASM_DIR	11	Advertise Asymmetric Pause direction bit. This bit is used in conjunction with PAUSE.	R/W	1b
Reserved	12	Always read as 0b. Write to 0b for normal operation.	R/W	0b
Remote Fault	13	1b = Set Remote Fault bit. 0b = Do not set Remote Fault bit.	R/W	0b
Reserved	14	Always read as 0b. Write to 0b for normal operation.	R/W	0b
Next Page	15	1b = Manual control of Next Page (Software). 0b = 82575 control of Next Page (Auto).	R/W	0b

1. If EEPROM ADV10LU (word 21h, bit 3) is asserted, then the default is set to 0b; otherwise, the default is 1b.

### 14.3.8.6 Auto-Negotiation Base Page Ability Register - (05d; R)

Field	Bit(s)	Description	Mode	Default
Selector Fields[4:0]	4:0	<00001> = IEEE 802.3 Other combinations are reserved. Unspecified or reserved combinations shall not be transmitted. If field does not match PHY Register 04d, bits 4:0, the AN process does not complete and no HCD is selected.	RO	N/A
10BASE-T	5	1b = Link Partner is 10BASE-T capable. 0b = Link Partner is not 10BASE-T capable.	RO	N/A
10BASE-T Full Duplex	6	1b = Link Partner is 10BASE-T full duplex capable. 0b = Link Partner is not 10BASE-T full duplex capable.	RO	N/A
100BASE-TX	7	1b = Link Partner is 100BASE-TX capable. 0b = Link Partner is not 100BASE-TX capable.	RO	N/A
100BASE-TX Full Duplex	8	1b = Link Partner is 100BASE-TX full duplex capable. 0b = Link Partner is not 100BASE-TX full duplex capable.	RO	N/A
100BASE-T4	9	1b = Link Partner is 100BASE-T4 capable. 0b = Link Partner is not 100BASE-T4 capable.	RO	N/A
LP Pause	10	Link Partner uses Pause Operation as defined in 802.3x.	RO	N/A
LP ASM_DIR	11	Asymmetric Pause Direction Bit 1b = Link Partner is capable of asymmetric pause. 0b = Link Partner is not capable of asymmetric pause.	RO	N/A
Reserved	12	Always read as 0b. Write as 0b.	RO	0b
Remote Fault	13	1b = Remote fault. 0b = No remote fault.	RO	N/A
Acknowledge	14	1b = Link Partner has received Link Code Word from the PHY. 0b = Link Partner has not received Link Code Word from the PHY.	RO	N/A
Next Page	15	1b = Link Partner has ability to send multiple pages. 0b = Link Partner has no ability to send multiple pages.	RO	N/A



### 14.3.8.7 Auto-Negotiation Expansion Register - ANE (06d; R)

Field	Bit(s)	Description	Mode	Default
Link Partner Auto-Negotiation Able	0	1b = Link Partner is Auto-Negotiation able. 0b = Link Partner is not Auto-Negotiation able.	RO	0b
Page Received	1	Indicates that a new page has been received and the received code word has been loaded into PHY register 05d (base pages) or PHY register 08d (next pages) as specified in clause 28 of 802.3. This bit clears on read. If PHY register 16d bit 1 (Alternate NP Feature) is set, the <i>Page Received</i> bit also clears when <i>mr_page_rx</i> = false or <i>transmit_disable</i> = true.	RO/LH	0b
Next Page Able	2	1b = Local device is next page able. 0b = Local device is not next page able.	RO	1b
Link Partner Next Page Able	3	1b = Link Partner is next page able. 0b = Link Partner is not next page able.	RO	0b
Parallel Detection Fault	4	1b = Parallel detection fault has occurred. 0b = Parallel detection fault has not occurred.	RO/LH	0b
Base Page	5	This bit indicates the status of the auto-negotiation variable, base page. If flags synchronization with the auto-negotiation state diagram enabling detection of interrupted links. This bit is only used if PHY register 16d, bit 1 (Alternate NP Feature) is set.  1b = <i>base_page</i> = true. 0b = <i>base_page</i> = false.	RO/LH	0b
Reserved	15:6	Always read as 0b.	RO	0b

### 14.3.8.8 Auto-Negotiation Next Page Transmit Register - NPT (07d; R/W)

Field	Bit(s)	Description	Mode	Default
Message/Unformatted Field	10:0	11-bit message code field.	R/W	1b
Toggle	11	1b = Previous value of the transmitted Link Code Word = 0b. 0b = Previous value of the transmitted Link Code Word = 1b.	RO	0b
Acknowledge 2	12	1b = Complies with message. 0b = Cannot comply with message.	R/W	0b
Message Page	13	1b = Message page. 0b = Unformatted page.	R/W	1b
Reserved	14	Always read as 0b. Write to 0b for normal operation.	RO	0b
Next Page	15	1b = Additional next pages follow. 0b = Last page.	R/W	0b



### 14.3.8.9 Auto-Negotiation Next Page Ability Register - LPN (08d; R)

Bit(s)	Field	Description	Mode	Default
10:0	Message/Unformatted Field	11-bit message code field.	RO	0b
11	Toggle	1b = Previous value of the transmitted Link Code Word = 0b. 0b = Previous value of the transmitted Link Code Word = 1b.	RO	0b
12	Acknowledge 2	1b = Link Partner complies with the message. 0b = Link Partner cannot comply with the message.	RO	0b
13	Message Page	1b = Page sent by the Link Partner is a Message Page. 0b = Page sent by the Link Partner is an Unformatted Page.	RO	0b
14	Acknowledge	1b = Link Partner has received Link Code Word from the PHY. 0b = Link Partner has not received Link Code Word from the PHY.	RO	0b
15	Next Page	1b = Link Partner has additional next pages to send. 0b = Link Partner has no additional next pages to send.	RO	0b

### 14.3.8.10 1000BASE-T/100BASE-T2 Control Register - GCON (09d; R/W)

Bit(s)	Field	Description	Mode	Default
7:0	Reserved	Always read as 0b. Write to 0b for normal operation.	R/W	0b
8	1000BASE-T Half Duplex	1b = DTE is 1000BASE-T capable. 0b = DTE is not 1000BASE-T capable. This bit is used by Smart Negotiation.	R/W	0b
9 <sup>1</sup>	1000BASE-T Full Duplex	1b = DTE is 1000BASE-T full duplex capable. 0b = DTE is not 1000BASE-T full duplex capable. This bit is used by Smart Negotiation.	R/W	1b
10	Port Type	1b = Prefer multi-port device (Master). 0b = Prefer single port device (Slave). This bit is only used when PHY register 9, bit 12 is set to 0b.	R/W	0b
11	Master/Slave Config Value	1b = Configure PHY as MASTER during MASTER-SLAVE negotiation (only when PHY register 9, bit 12 is set to 1b). 0b = Configure PHY as SLAVE during MASTER-SLAVE negotiation (only when PHY register 9, bit 12 is set to 1b).	R/W	0b
12	Master/Slave Config Enable	1b = Manual Master/Slave configuration. 0b = Automatic Master/Slave configuration.	R/W	0b
15:13	Test mode	000b = Normal Mode. 001b = Pulse and Droop Template. 010b = Jitter Template. 011b = Jitter Template. 100b = Distortion Packet. 101b, 110b, 111b = Reserved.	R/W	000b



1. The default of this bit is affected by the EEPROM bit configuration of the 82575.  
If EEPROM bit AN-1000DIS is asserted, then the default is set to 0b.  
If EEPROM bit ADV10LU (word 21h, bit 3) is asserted, then the default is set to 0b.

### 14.3.8.11 1000BASE-T/100BASE-T2 Status Register - GSTATUS (10d; R)

Field	Bit(s)	Description	Mode
Idle Error Count	7:0	Idle Error counter Value.  This register counts the number of invalid idle codes when link is high and the PHY is in either 1000BASE-T or 100BASE-T modes. If an overflow, these bits are held at all 1b. They are cleared on read or a hard or soft reset.	RO, LH
Reserved	9:8	Reserved. Always set to 00b.	RO
LP 1000T HD	10	1b = Link Partner is capable of 1000BASE-T half duplex. 0b = Link Partner is not capable of 1000BASE-T half duplex.  Values in bits 11:10 are not valid until the ANE Register Page Received bit equals 1b.	RO
LP 1000T FD	11	1b = Link Partner is capable of 1000BASE-T full duplex. 0b = Link Partner is not capable of 1000BASE-T full duplex.  Values in bits 11:10 are not valid until the ANE Register Page Received bit equals 1b.	RO
Remote Receiver Status	12	1b = Remote Receiver OK. 0 b = Remote Receiver Not OK.	RO
Local Receiver Status	13	1b = Local Receiver OK. 0b = Local Receiver Not OK.	RO
Master/Slave Resolution	14	1b = Local PHY configuration resolved to Master. 0b = Local PHY configuration resolved to Slave.  Values in bits 11:10 are not valid until the ANE Register Page Received bit equals 1b.	RO
Master/Slave Config Fault	15	1b = Master/Slave configuration fault detected. 0b = No Master/Slave configuration fault detected.	RO, LH



### 14.3.8.12 Extended Status Register - ESTATUS (15d; R)

Field	Bit(s)	Description	Mode	Default
Reserved	11:0	Reserved. Always read as 0b.	RO	0b
1000BASE-T Half Duplex	12	1b = 1000BASE-T half duplex capable. 0b = not 1000BASE-T half duplex capable.	RO	1b
1000BASE-T Full Duplex	13	1b = 1000BASE-T full duplex capable. 0b = Not 1000BASE-T full duplex capable.	RO	1b
1000BASE-X Half Duplex	14	1b = 1000BASE-X half duplex capable. 0b = Not 1000BASE-X half duplex capable.	RO	0b
1000BASE-X Full Duplex	15	1b = 1000BASE-X full duplex capable. 0b = Not 1000BASE-X full duplex capable.	RO	0b

### 14.3.8.13 Port Configuration Register - PCONF (16d; R/W)

Field	Bit(s)	Description	Mode	Default
Reserved	0	Always read as 0b. Write to 0b for normal operation.	R/W	0b
Alternate NP Feature	1	1b = Enable alternate Auto-Negotiate next page feature. 0b = Disable alternate Auto-Negotiate next page feature.	R/W	0b
Reserved	3:2	Always read as 0b. Write to 0b for normal operation.	R/W	0b
Auto MDIX Parallel Detect Bypass	4	Auto_MDIX Parallel Detect Bypass. Bypasses the fix to IEEE auto-MDIX algorithm for the case where the PHY is in forced-speed mode and the link partner is auto-negotiating. 1b = Strict 802.3 Auto-MDIX algorithm. 0b = Auto-MDIX algorithm handles Auto-Negotiation disabled modes. This is accomplished by lengthening the auto-MDIX switch timer before attempting to swap pairs on the first time out.	R/W	0b
PRE_EN	5	Preamble Enable 0b = Set RX_DV high coincident with SFD. 1b = Set RX_DV high and RXD = preamble (after CRS is asserted).	R/W	1b
Reserved	6	Always read as 0b. Write to 0b for normal operation.	R/W	0b
Smart Speed	7	1b = Smart Speed selection enabled. 0b = Smart Speed selection disabled. <b>Note:</b> The default of this bit is determined by the EEPROM speed bit (word 21h, bit 5).	R/W	0b
TP Loopback (10BASE-T)	8	1b = Disable TP loopback during half-duplex operation. 0b = Normal operation.	R/W	1b
Reserved	9	Always read as 0b. Write to 0b for normal operation.	R/W	0b
Jabber (10BASE-T)	10	1b = Disable jabber. 0b = Enable jabber.	R/W	0b
Bypass 4B5B (100BASE-TX)	11	1b = Bypass4B5B encoder and decoder. 0b = Normal operation.	R/W	0b
Bypass Scramble (100BASE-TX)	12	1b = Bypass scrambler and descrambler. 0b = Normal operation.	R/W	0b



Field	Bit(s)	Description	Mode	Default
Transmit Disable	13	1b = Disable twisted-pair transmitter. 0b = Normal operation.	R/W	0b
Link Disable	14	1b = Force link pass 0b = Normal operation  For 10BASE-T, this bit forces the link signals to be active. In 100BASE-T mode, setting this bit should force the Link Monitor into it's LINKGOOD state. For Gigabit operation, this merely bypasses Auto-Negotiation—the link signals still correctly indicate the appropriate status.	R/W	0b
Reserved	15	Always read as 0b. Write 0b for normal operation.	R/W	0b

### 14.3.8.14 Port Status 1 Register - PSTAT (17d; RO)

Field	Bit(s)	Description	Mode	Default
LFIT Indicator	0	Status bit indicating the Auto-Negotiation Link Fail Inhibit Timer has expired. This indicates that the Auto-Negotiation process completed page exchanges but was unable to bring up the selected MAU's link.  1b = Auto-Negotiation has aborted Link establishment following normal page exchange. 0b = Auto-Negotiation has either completed normally, or is still in progress.  This bit is cleared when read or when one of the following occurs: Link comes up (PHY register 17d, bit 10 = 1b). Auto-Negotiation is disabled (PHY register 00d, bit 12 = 0b). Auto-Negotiation is restarted (PHY register 00d, bit 9 = 1b).	RO/ LH/SC	0b
Polarity Status	1	1b = 10BASE-T polarity is reversed. 0b = 10BASE-T polarity is normal.	RO	0b
Reserved	8:2	Ignore these bits.	RO	0b
Duplex Mode	9	1b = Full duplex. 0b = Half duplex.	RO	0b
Link	10	Indicates the current status of the link. Differs from PHY register 01, bit 2 in that this bit changes anytime the link status changes. PHY register 01, bit 2 latches low and stays low until read regardless of link status.  1b = Link is currently up. 0b = Link is currently down.	RO	0b
MDI-X Status	11	Status indicator of the current MDI/MDI-X state of the twisted pair interface. This status bit is valid regardless of the MAU selected.  1b = PHY has selected MDI-X (crossed over). 0b = PHY has selected MDI (NOT crossed over).	RO	0b





Field	Bit(s)	Description	Mode	Default
Receive Status	12	1b = PHY currently receiving a packet. 0b = PHY receiver is IDLE. When in internal loopback, this bit reads as 0b.	RO	0b
Transmit Status	13	1b = PHY currently transmitting a packet. 0b = PHY transmitter is IDLE. When in internal loopback, this bit reads as 0b.	RO	00b
Data Rate	15:14	00b = Reserved. 01b = PHY operating in 10BASE-T mode. 10b = PHY operating in 100BASE-TX mode. 11b = PHY operating in 1000BASE-T mode.	RO	0b

### 14.3.8.15 Port Control Register - PCONT (18d; R/W)

Field	Bit(s)	Description	Mode	Default
Reserved	3:0	Always read as 0b. Write to 0b for normal operation.	R/W	0b
TP Loopback	4	Allow gigabit loopback on twisted pairs.	R/W	0b
Reserved	8:5	Always read as 0000b. Write to 0000b for normal operation.	R/W	0000b
Non-Compliant Scrambler Compensation	9	1b = Detect and correct for non-compliant scrambler. 0b = Detect and report non-compliant scrambler. <b>Note:</b> The default of this bit is affected by the EEPROM bit configurations of the 82575. If EEPROM word 21h, bit 2 is asserted, then the default is set to 1b.	R/W	0b
TEN_CRS_Select	10	1b = Extend CRS to cover 1000Base-T latency and RX_DV. 0b = Do not extend CRS (RX_DV can continue past CRS).	R/W	1b
Flip_Chip	11	Used for applications where the core or application is mirror-imaged. Channel D acts like channel A with t10pol_inv set and vice-versa. Channel C acts like channel B with t10pol_inv set and vice-versa. This forces the correctness of all MDI/MDIX and polarity issues.	R/W	0b
Auto-MDI-X	12	Auto-MDI-X algorithm enable. 1b = Enable Auto-MDI-X mode. 0b = Disable Auto-MDI-X mode (manual mode). <b>Note:</b> When forcing speed to 10Base-T or 100Base-T, use manual mode. Clear the bit and set PHY register 18d, bit 13 according to the required MDI-X mode.	R/W	1b



Field	Bit(s)	Description	Mode	Default
MDI-X Mode	13	Force MDI-X mode. Valid only when operating in manual mode. (PHY register 18d, bit 12 = 0b.  1b = MDI-X (cross over). 0b = MDI (no cross over).	R/W	0b
Reserved	14	Always read as 0b. Write to 0b for normal operation.	R/W	0b
Jitter Test Clock	15	This configuration bit is used to enable the 82575 to drive its differential transmit clock out through the appropriate Analog Test (ATEST+/-) output pads. This feature is required in order to demonstrate conformance to the IEEE Clause 40 jitter specification.  When high, it sends Jitter Test Clock out.  This bit works in conjunction with internal PHY register 4011h, bit 15. In order to have the clock probed out, it is required to perform the following write sequence:  PHY register 18d, bit 15 = 1b PHY register 31d = 4010h (page select) PHY register 17d = 0080h PHY register 31d = 0000h (page select)	R/W	0b

### 14.3.8.16 Link Health Register - LINK (19d; RO)

Field	Bit(s)	Description	Mode	HW Rst
Valid Channel A	0	The channel A DSP had converged to incoming data.	RO	0b
Valid Channel B	1	The channel B DSP had converged to incoming data.	RO	0b
Valid Channel C	2	The channel C DSP had converged to incoming data.	RO	0b
Valid Channel D	3	The channel D DSP had converged to incoming data.  If An_Enable is true, valid_chan_A = dsplockA latched on the rising edge of link_fail_inhibit_timer_done and link = 0b. If An_enable is false, valid_chan_A = dsplockA.	RO	0b
Auto-Negotiation Active	4	Auto-Negotiate is actively deciding HCD.	RO	0b
Reserved	5	Always read as 0b.	RO	0b
Auto-Negotiation Fault	6	Auto-Negotiate Fault: This is the logical OR of PHY register 01d, bit 4, PHY register 06d, bit 4, and PHY register 10d, bit 15.	RO	0b
Reserved	7	Always read as 0b.	RO	0b
Data Err[0]	8	Mode: 10: 10 Mbps polarity error. 100: Symbol error. 1000: Gig idle error.	LH	0b
Data Err[1]	9	Mode: 10: N/A. 100: Scrambler unlocked. 1000: Local receiver not OK.	RO/LH	0b
Count Overflow	10	32 idle error events were counted in less than 1 ms.	RO/LH	0b
Gigabit Rem Rcvr NOK	11	Gig has detected a remote receiver status error. This is a latched high version of PHY register 10d, bit 12.	RO/LH	0b



Field	Bit(s)	Description	Mode	HW Rst
Gigabit Master Resolution	12	Gig has resolved to master. This is a duplicate of PHY register 10d, bit 14.  Programmers must read PHY register 10d, bit 14 to clear this bit.	RO	0b
Gigabit Master Fault	13	A fault has occurred with the gig master/slave resolution process. This is a copy of PHY register 10, bit 15.  Programmers must read PHY register 10, bit 15 to clear this bit.	RO	0b
Gigabit Scrambler Error	14	1b indicates that the PHY has detected gigabit connection errors that are most likely due to a non-IEEE compliant scrambler in the link partner.  0b = Normal scrambled data.  Definition is: If an_enable is true and in Gigabit mode, on the rising edge of internal signal link_fail_inhibit timer_done, the dsp_lock is true but loc_rcvr_OK is false.	RO	0b
SS Downgrade	15	Smart Speed has downgraded the link speed from the maximum advertised.	RO/LH	0b

### 14.3.8.17 1000Base-T FIFO Register - PFIFO (20d; R/W)

Field	Bit(s)	Description	Mode	Default
Buffer Size	3:0	An unsigned integer that stipulates the number of write clocks to delay the read controller after internal 1000Base-T's tx_en is first asserted. This buffer protects from underflow at the expense of latency. The maximum value that can be set is 13d or Dh.	R/W	0101b
Reserved	7:4	Always read as 0b. Write to 0b for normal operation.	R/W	0000b
FIFO Out Steering	9:8	00b, 01b: Enable the output data bus from 1000Base-T FIFO to transmitters, drives zeros on the output loop-back bus from 1000Base-T FIFO to external application and to DSP RX-FIFOs in test mode.  10b: Drive zeros on output bus from 1000Base-T FIFO to transmitters, enable data on the output loop-back bus from 1000Base-T FIFO to external application and to DSP RX-FIFOs in test mode.  11b: Enable the output data bus from 1000Base-T FIFO to both transmitters and loop-back bus.	R/W	00b
Disable Error Out	10	When set, disables the addition of under/overflow errors to the output data stream on internal 1000Base-T's tx_error.	R/W	0b
Reserved	13:11	Always read as 0b. Write to 0b for normal operation.	R/W	0b
FIFO Overflow	14	Status bit set when read clock that is slower than internal 1000Base-T's gtx_clk has allowed the FIFO to fill to capacity mid packet. Decrease buffer size.	RO/LH	0b
FIFO Underflow	15	Status bit set when read clock that is faster than internal 1000Base-T's gtx_clk empties the FIFO mid packet. Increase the buffer size.	RO/LH	0b



### 14.3.8.18 Channel Quality Register - CHAN (21d; RO)

Field	Bit(s)	Description	Mode	Default
MSE_A	3:0	The converged mean square error for Channel A.	RO	0b
MSE_B	7:4	The converged mean square error for Channel B.	RO	0b
MSE_C	11:8	The converged mean square error for Channel C.	RO	0b
MSE_D	15:12	The converged mean square error for Channel D. This field is only meaningful in gigabit, or in 100BASE-TX if this is the receive pair.  Use of this field is complex and needs interpretation based on the chosen threshold value.	RO	0b

### 14.3.8.19 PHY Power Management - (25d; R/W)

Field	Bit(s)	Description	Mode	Default
Reserved	15:9	Always read as 0b. Write to 0b for normal operation.	R/W	0b
rst_compl	8	Indicates PHY internal reset cleared.	LH	0b
Reserved	7	Reserved.	R/W	0b
Disable 1000	6	When set, disables 1000 Mb/s in all power modes. Note that this bit can be loaded from EEPROM.	R/W	0b
Reserved	5	Always read as 0b. Write to 0b for normal operation.	R/W	0b
Link Energy Detect	4	This bit is set when the PHY detects energy on the link. Note that this bit is valid only if AN enabled (PHY register 00b, bit 12) and SPD_EN is enabled (PHY register 25d, bit 0).	R/W	0b
Disable 1000 nD0a	3	Disables 1000 Mb/s operation in non-D0a states. Note that this bit can be loaded from EEPROM.	R/W	0b
LPLU	2	Low Power on Link Up  When set, enables the decrease in link speed while in non-D0a states when the power policy and power management state specify it. Note that bit can be loaded from EEPROM.	R/W	1b
D0LPLU	1	D0 Low Power Link Up  When set, configures the PHY to negotiate for a low speed link while in D0a state.	R/W	0b
Reserved	0	Reserved	R/W	0b

### 14.3.8.20 Special Gigabit Disable Register - (26d; R/W)

Field	Bit(s)	Description	Mode	Default
Reserved	15:0	Always read as 0b. Write to 0b for normal operation.	R/W	0h



### 14.3.8.21 Misc Cntrl Register 1 - (27d; R/W)

Field	Bit(s)	Description	Mode	Default
Reserved	15	Ignore this bit.	R/W	0b
Reserved	14:9	Always read as 0b. Write to 0b for normal operation.	R/W	0b
ss_cfg_cntr	8:6	Smart speed counter configuration: 1-5 (001b:101b).	R/W	010b
T10_auto_pol_dis	5	When set, disables the auto-polarity mechanism in the 10 block.	R/W	0b
Reserved	4:0	Always read as 0b. Write to 0b for normal operation.	R/W	0b

### 14.3.8.22 Misc Cntrl Register 2 - (28d; RO)

Field	Bit(s)	Description	Mode	Default
Reserved	15:14	Always read as 0b. Write to 0b for normal operation.	R/W	0b
Act_an_adv_gigfdx	13	Indicates the actual AN advertisement of the PHY for 1000 Full-Duplex Capability. 0b = Not 1000 Full Duplex Capable. 1b = 1000 Full Duplex Capable.	RO	0b
Act_an_adv_gighdx	12	Indicates the actual AN advertisement of the PHY for 1000 Half-Duplex Capability. 0b = Not 1000 Half Duplex Capable. 1b = 1000 Half Duplex Capable.	RO	0b
Act_an_adv_100fd	11	Indicates the actual AN advertisement of the PHY for 100 Full-Duplex Capability. 0b = Not 100 Full Duplex Capable. 1b = 100 Full Duplex Capable.	RO	0b
Act_an_adv_100hd	10	Indicates the actual AN advertisement of the PHY for 100 half-Duplex Capability. 0b = Not 100 Half Duplex Capable. 1b = 100 Half Duplex Capable.	RO	0b
Act_an_adv_10fdx	9	Indicates the actual AN advertisement of the PHY for 10 Full-Duplex Capability. 0b = Not 10 Full Duplex Capable. 1b = 10 Full Duplex Capable.	RO	0b
Act_an_adv_10hdx	8	Indicates the actual AN advertisement of the PHY for 10 Half-Duplex Capability. 0b = Not 10 Half Duplex Capable. 1b = 10 Half Duplex Capable.	RO	0b
Reserved	7:0	Reserved.	R/W	0b

**Note:** Bits 13:8 might differ from the corresponding bits in PHY register 04d and 09d due to non-IEEE PHY features (lplu, an1000\_dis, and smart-speed).



### 14.3.8.23 Page Select Core Register - (31d; WO)

Field	Bit(s)	Description	Mode	Default
PAGE_SEL	15:0	This register is used to swap out the Base Page containing the IEEE registers for Intel reserved test and debug pages residing within the Extended Address space.	WO	0b

### 14.3.9 SERDES ANA - SERDESCTL (00024h; R/W)

Field	Bit(s)	Initial Value	Description
Done Indication	31	1b	When a write operation completes, this bit is set to 1b indicating that new data can be written. This bit is over written to 0b by new data.
Reserved	30:16	0b	Reserved.
Address	15:8	0b	Address to SerDes.
Data	7:0	0b	Data to SerDes.

### 14.3.10 Copper/Fiber Switch Control - CONNSW (00034h; R/W)

Field	Bit(s)	Initial Value	Description
AUTOSENSE_EN	0	0b	Auto Sense Enable When set, the auto sense mode is active. In this mode the non-active link is sensed by hardware as follows  PHY Sensing: The electrical idle detector of the receiver of the PHY is activated while in SerDes or SGMII mode.  SerDes sensing: The electrical idle detector of the receiver of the SerDes is activated while in internal PHY mode, assuming the ENRGSRRC bit is cleared  If energy is detected in the non active media, the OMED bit in the ICR register is set and this bit is cleared. This includes the case where energy was present at the non-active media when this bit is being set.
AUTOSENSE_CONF	1	0b	Auto Sense Config Mode This bit should be set during the configuration of the PHY/SerDes towards the activation of the auto-sense mode. While this bit is set, the PHY/SerDes is active even though the active link is set to SerDes or SGMII/PHY. Energy detection while this bit is set will not be reflected to the OMED interrupt.
ENRGSRRC	2	0b <sup>1</sup>	SerDes Energy Detect Source If set, the OMED interrupt cause is set after asserting the external signal detect pin. If cleared, the OMED interrupt cause is set after exiting from electrical idle of the SerDes receiver.  This bit also defines the source of the signal detect indication used to set link up while is SerDes mode.
Reserved	3	0b	Reserved Must be set to 0b.
Reserved	8:4	0h	Reserved



SerDesD (RO)	9	X	SerDes Signal Detect Indication Indicates the SerDes signal detect value according to the selected source (either external or internal). Valid only if LINK_MODE is SerDes or SGMII.
PHYSD (RO)	10	X	PHY Signal Detect Indication Valid only if LINK_MODE is the PHY and the receiver is not in electrical idle.
Reserved	31:11	0h	Reserved

1. Words 24h and 14h (bit 15) in the EEPROM defines the default of the ENRGSRC bit in this register for LAN0 and LAN1 respectively.

### 14.3.11 VLAN Ether Type - VET (00038h; R/W)

This register contains the type field hardware matches against to recognize an 802.1Q (VLAN) Ethernet packet and uses when add and transmit VLAN Ethernet packets. To be compliant with the 802.3ac standard, this register should be programmed with the value 8100h. For VLAN transmission the upper byte is first on the wire (VET[15:8]).

Field	Bit(s)	Initial Value	Description
VET	15:0	8100h	VLAN EtherType Should be programmed with 8100h.
VET EXT	31:16	8100h	External VLAN Ether Type.

### 14.3.12 Fuse Register - UFUSE (5B78h; RO)

Field	Bit(s)	Initial Value	Description
Number of LANs	0	Fuse dependent	If disabled, LAN1 is disabled, otherwise both ports are enabled <b>Note:</b> Fuse is always enabled.
PCIePerf	1	Fuse dependent	PCIe* performance (high or low PCIe* lane count). See Table 90. <b>Note:</b> This fuse use is always enabled.
Manageability	2	Fuse dependent	0b - Reserved. 1b = Enable manageability.
I/OAT	3	Fuse dependent	Enables DMA engine unlocking and header replication.
Copper-SerDes	4	Fuse dependent	When enabled, both SerDes and 1000BASE-T PHY are enabled, including SFP. When blown, 1000BASE-T is disabled (consider de-powering).
IDV Enable	5	Fuse dependent	When enabled, IDV DFT feature is enabled.
VT/iSCSI Enable	6	Fuse dependent	When enabled, VT and iSCSI support is enabled.
Spare fuses	9:7	Fuse dependent	Two spare fuses.
LNO NIC	10	Fuse dependent	Anti-counterfeit measures to identify returned NICs. Software readable fuse; no action required.



ULT Lockout	11	Fuse dependent	Indicates if the ULT information is valid.
CLS Lockout	12	Fuse dependent	Indicates the class programming was done.
Reserved	31:13	00h	Reserved.

**Table 90. PCIe\* Performance**

Port	Enabled	Disabled
Single port	x2	x1
Dual port	x4	x2

### 14.3.13 Flow Control Address Low - FCAL (00028h; R/W)

Flow control packets are defined by 802.3X to be either a unique multicast address or the station address with the Ether Type field indicating PAUSE. The FCA registers provide the value hardware compares incoming packets against to determine that it should PAUSE its output.

The FCAL register contains the lower bits of the internal 48-bit Flow Control Ethernet address. All 32 bits are valid. Software can access the High and Low registers as a register pair if it can perform a 64-bit access to the PCIe\* bus. This register should be programmed with 00\_C2\_80\_01h. The complete flow control multicast address is: 01\_80\_C2\_00\_00\_01h; where 01h is the first byte on the wire, 80h is the second, etc.

**Note:** Any packet matching the contents of {FCAH, FCAL, FCT} when CTRL.RFCE is set is acted on by the 82575. Whether flow control packets are passed to the host (software) depends on the state of the RCTL.DPF bit and whether the packet matches any of the normal filters

Field	Bit(s)	Initial Value	Description
FCAL	31:0	X	Flow Control Address Low Should be programmed with 00_C2_80_01h

### 14.3.14 Flow Control Address High - FCAH (0002Ch; R/W)

This register contains the upper bits of the 48-bit Flow Control Ethernet address. Only the lower 16 bits of this register have meaning. The complete Flow Control address is {FCAH, FCAL}. This register should be programmed with 01\_00h. The complete flow control multicast address is: 01\_80\_C2\_00\_00\_01h; where 01h is the first byte on the wire, 80h is the second, etc.

Field	Bit(s)	Initial Value	Description
FCAH	15:0	X	Flow Control Address High Should be programmed with 01_00h.
Reserved	31:16	0b	Reserved Reads as 0b.





### 14.3.15 Flow Control Type - FCT (00030h; R/W)

This register contains the type field that hardware matches to recognize a flow control packet. Only the lower 16 bits of this register have meaning. This register should be programmed with 88\_08h. The upper byte is first on the wire FCT[15:8].

Field	Bit(s)	Initial Value	Description
FCT	15:0	X	Flow Control Type Should be programmed with 88_08h.
Reserved	31:16	0b	Reserved Reads as 0b.

### 14.3.16 Flow Control Transmit Timer Value - FCTTV (00170h; R/W)

The 16-bit value in the TTV field is inserted into a transmitted frame (either XOFF frames or any PAUSE frame value in any software transmitted packets). It counts in units of slot time, usually 4 bytes. If software needs to send an XON frame, it must set TTV to 0b prior to initiating the PAUSE frame.

**Note:** The 82575 uses a fixed slot time of 64 byte times.

Field	Bit(s)	Initial Value	Description
TTV	15:0	X	Transmit Timer Value These bits are included in the XOFF frame.
Reserved	31:16	0b	Reserved Reads as 0b. Should be written to 0b for future compatibility.

### 14.3.17 LED Control - LEDCTL (00E00h; RW)

Field	Bit	Initial Value	Description
LED0_MODE	3:0	0010b <sup>1</sup>	LED0/LINK# Mode This field specifies the control source for the LED0 output. An initial value of 0010b selects LINK_UP# indication.
Reserved	4	0b	Reserved
GLOBAL_BLINK_MODE	5	0b <sup>1</sup>	Global Blink Mode This field specifies the blink mode of all the LEDs. 0b = Blink at 200 ms on and 200 ms off. 1b = Blink at 83 ms on and 83 ms off.
LED0_IVRT	6	0b <sup>1</sup>	LED0/LINK# Invert This field specifies the polarity/ inversion of the LED source prior to output or blink control. 0b = Do not invert LED source. 1b = Invert LED source.



Field	Bit	Initial Value	Description
LED0_BLINK	7	0b <sup>1</sup>	LED0/LINK# Blink This field specifies whether to apply blink logic to the (possibly inverted) LED control source prior to the LED output. 0b = Do not blink asserted LED output. 1b = Blink asserted LED output.
LED1_MODE	11:8	0011b <sup>1</sup>	LED1/ACTIVITY# Mode This field specifies the control source for the LED1 output. An initial value of 0011b selects FILTER ACTIVITY# indication.
Reserved	12	0b	Reserved Read-only as 0b. Write as 0b for future compatibility.
Reserved	13	0b	Reserved
LED1_IVRT	14	0b <sup>1</sup>	LED1/ACTIVITY# Invert
LED1_BLINK	15	1b <sup>1</sup>	LED1/ACTIVITY# Blink
LED2_MODE	19:16	0110b <sup>1</sup>	LED2/LINK100# Mode This field specifies the control source for the LED2 output. An initial value of 0011b selects LINK100# indication.
Reserved	20	0b	Reserved Read-only as 0b. Write as 0b for future compatibility.
Reserved	21	0b	Reserved
LED2_IVRT	22	0b <sup>1</sup>	LED2/LINK100# Invert
LED2_BLINK	23	0b <sup>1</sup>	LED2/LINK100# Blink
LED3_MODE	27:24	0111b <sup>1</sup>	LED3/LINK1000# Mode This field specifies the control source for the LED3 output. An initial value of 0111b selects LINK1000# indication.
Reserved	28	0b	Reserved Read-only as 0b. Write as 0b for future compatibility.
Reserved	29	0b	Reserved
LED3_IVRT	30	0b <sup>1</sup>	LED3/LINK1000# Invert
LED3_BLINK	31	0b <sup>1</sup>	LED3/LINK1000# Blink

1. These bits are read from the EEPROM.

### 14.3.17.1 MODE Encodings for LED Outputs

Table 91 lists the MODE encodings used to select the desired LED signal source for each LED output.

**Note:** When LED Blink mode is enabled the appropriate LED Invert bit should be set to 0b.

The dynamic LED modes (FILTER\_ACTIVITY, LINK/ACTIVITY, COLLISION, ACTIVITY, PAUSED) should be used with LED Blink mode enabled.

When LED blink mode is enabled, the blinking frequencies are 1/5 of the rates listed in the Table 91.



**Table 91. Mode Encodings**

Mode	Selected Mode	Source Indication
0000b	LINK_10/1000	Asserted when either 10 or 1000 Mb/s link is established and maintained.
0001b	LINK_100/1000	Asserted when either 100 or 1000 Mb/s link is established and maintained.
0010b	LINK_UP	Asserted when any speed link is established and maintained.
0011b	FILTER_ACTIVITY	Asserted when link is established and packets are being transmitted or received that passed MAC filtering.
0100b	LINK/ACTIVITY	Asserted when link is established and when there is no transmit or receive activity.
0101b	LINK_10	Asserted when a 10 Mb/s link is established and maintained.
0110b	LINK_100	Asserted when a 100 Mb/s link is established and maintained.
0111b	LINK_1000	Asserted when a 1000 Mb/s link is established and maintained.
1000b	SDP_MODE	LED activation is a reflection of the SDP signal. SDP0, SDP1, SDP2, SDP3 are reflected to LED0, LED1, LED2, LED3 respectively.
1001b	FULL_DUPLEX	Asserted when the link is configured for full duplex operation (de-asserted in half-duplex).
1010b	COLLISION	Asserted when a collision is observed.
1011b	ACTIVITY	Asserted when either 10 or 1000 Mb/s link is established and maintained.
1100b	BUS_SIZE	Asserted when either 100 or 1000 Mb/s link is established and maintained.
1101b	PAUSED	Asserted when any speed link is established and maintained.
1110b	LED_ON	Asserted when link is established and packets are being transmitted or received that passed MAC filtering.
1111b	LED_OFF	Asserted when link is established and when there is no transmit or receive activity.

### 14.3.18 Packet Buffer Allocation - PBA (01000h; R/W)

This register sets the on-chip receive and transmit storage allocation ratio. The receive allocation value is read/write for the lower six bits. The transmit allocation is read-only and is calculated based on RXA and CBA. The partitioning size is 1 KB.

**Note:** Programming this register does not automatically re-load or initialize internal packet-buffer RAM pointers. Software must reset both transmit and receive operation (using the global device reset CTRL.RST bit) after changing this register in order for it to take effect. The PBA register itself is not reset by assertion of the global reset, but is only reset upon initial hardware power-on.

For best performance, the transmit buffer allocation should be set to accept two full-sized packets (For good 9 KB jumbo frame performance, the transmit allocation should be a minimum of 18 KB).

Transmit packet buffer size should be configured to be more than 8 KB.

Field	Bit(s)	Initial Value	Description
RXA	9:0	0022h	Receive Packet Buffer Allocation in KB The upper four bits are read only as 0b. Default is 34 KB.
Reserved	15:10	00h	Reserved.
TXA (RO)	31:16	000Eh	Transmit Packet Buffer Allocation in KB These bits read only. Default is 14 KB.



### 14.3.19 Packet Buffer Size - PBS (01008h; R/W)

This register sets the on-chip receive and transmit storage allocation size, The allocation value is read/write for the lower 6 bits. These legal values must be 8 KB aligned (the least 3 bits are 0b). The division between transmit and receive is done according to the PBA register.

**Note:** Programming this register does not automatically re-load or initialize internal packet-buffer RAM pointers. Software must reset both the transmit and receive operation (using the global device reset *CTRL.RST* bit) after changing this register in order for it to take effect. The PBS register itself is not reset by asserting global reset, but is only reset upon initial hardware power-on.

Programming this register should be aligned with programming the PBA register hardware operation (if PBA and PBS are not coordinated and not determined).

Field	Bit(s)	Initial Value	Description
PBS	15:0	0030h	Packet Buffer Size in KB This value must be a multiple of 8 KB. The upper 10 bytes are always 0b. The default value is 48. The PBA register defines how the packet buffer is allocated between transmit and receive.
Reserved	30:16	0000h	Reserved Reads as 0b.
PB_MNG	31	0b	Packet Buffer for Manageability When set to 1b, all Rx/Tx traffic is not written to the packet buffer so that the packet buffer could be used as memory for manageability controller code.

### 14.3.20 SFP 12C Command - I2CCMD (01028h; R/W)

This register is used by software to read or write to the EEPROM's SFP modules.

**Note:** According to the SFP specification, only reads are allowed from this interface; however, SFP vendors also provide a writable register through this interface (for example, PHY registers). As a result, write capability is also supported.

Field	Bit(s)	Initial Value	Description
DATA	15:0	X	Data In a write command, software places the data bits and then the MAC shifts them out to the I <sup>2</sup> C bus. In a read command, the MAC reads these bits serially from the I <sup>2</sup> C bus and then software reads them from this location. <b>Note:</b> This field is read in byte order not in word order.
REGADD	23:16	0h	I <sup>2</sup> C Register Address For example, register 0, 1, 2, . . . 255.
PHYADD	26:24	0h	Device Address Bits 1-3 The actual address used is b{1010, PHYADD[2:0], 0}.
OP	27	0b	Op Code 0b = I <sup>2</sup> C write. 1b = I <sup>2</sup> C read.



Reset	28	0b	Reset Sequence If set, sends a reset sequence before the actual read or write. This bit is self clearing. A reset sequence is defined as nine consecutive stop conditions.
R	29	0b	Ready Bit Set to 1b by the 82575 at the end of the I <sup>2</sup> C transaction. For example, indicates a read or write has completed. Reset by a software write of a command.
I	30	0b	Interrupt Enable When set to 1b by software, it causes an Interrupt to be asserted to indicate the end of an I <sup>2</sup> C cycle (ICR.MDAC).
E	31	0b	Error This bit set is to 1b by hardware when it fails to complete an I <sup>2</sup> C read. Reset by a software write of a command.

### 14.3.21 SFP 12C Parameters - I2CPARAMS (0102Ch; R/W)

This register is used to set the parameters for the I<sup>2</sup>C access to the SFP module and to allow bit bang access to the I<sup>2</sup>C interface

Field	Bit(s)	Initial Value	Description
Write Time	4:0	110b	Write Time Defines the delay between a write access and the next access. The value is in microseconds. A value of zero is not valid.
Reserved	7:5	000b	Reserved
I2CBB_EN	8	0b	I <sup>2</sup> C Bit Bang Enable If set, the I <sup>2</sup> C_CLK and I <sup>2</sup> C_DATA lines are controlled via the CLK, DATA and DATA_OE_N fields of this register. Otherwise, they are controlled by the hardware machine activated via the I2CCMD or MDIC registers.
CLK	9	0b	I <sup>2</sup> C Clock While in bit bang mode, controls the value driven on the I2C_CLK pad of this port.
DATA_OUT	10	0b	I <sup>2</sup> C_DATA While in bit bang mode and when the DATA_OE_N field is zero, controls the value driven on the I2C_DATA pad of this port.



DATA_OE_N	11	0b	I <sup>2</sup> C_DATA_OE_N While in bit bang mode, controls the direction of the I2C_DATA pad of this port. 0b = Pad is output. 1b = Pad is input.
DATA_IN (RO)	12	X	I <sup>2</sup> C_DATA_IN Reflects the value of the I2C_DATA pad. While in bit bang mode and when the DATA_OE_N field is zero, this field reflects the value set in the DATA_OUT field.
Reserved	31:13	0h	Reserved

### 14.3.22 Flash Opcode - FLASHOP (0103Ch; R/W)

This register enables the host or the firmware to define the op-code used in order to erase a sector of the flash or the complete flash. This register is reset only at Internal\_Power\_On\_Reset assertion.

**Note:** The default values fit to Atmel\* Serial Flash Memory devices.

Field	Bit(s)	Initial Value	Description
DERASE	7:0	0062h	Flash Device Erase Instruction The op-code for the Flash erase instruction.
SERASE	15:8	0052h	Flash Block Erase Instruction The op-code for the Flash block erase instruction. Relevant only to Flash access by manageability.
Reserved	31:16	0h	Reserved

### 14.3.23 EEPROM Diagnostic - EEDIAG (01038h; RO)

This register reflects the values of EEPROM bits influencing the hardware that are not reflected otherwise.

Field	Bit(s)	Initial Value	Description
LAN0 Disable Strap Behavior	0	0b	Reflects the inverse of bit 13 in EEPROM word 20h controlling behavior of disabling strap for LAN0.
LAN1 Disable Strap Behavior	1	0b	Reflects the inverse of bit 13 in EEPROM word 10h controlling behavior of disabling strap for LAN1.
LAN1 Disable	2	0b	Reflects bit 11 in EEPROM word 10h controlling the disabling of LAN1 as PCIe*.
LAN1 PCI Disable	3	0b	Reflects bit 10 in EEPROM word 10h controlling the disabling of LAN1 as PCIe*.
EEPROM Deadlock Release Enable	4	0b	Reflects bit 5 in EEPROM word 0Ah controlling the EEPROM deadlock release enable.
Dynamic IDDQ Enable	5	0b	Reflects bit 15 in EEPROM work 1Eh controlling the dynamic IDDQ enable.
PLL Shutdown Enable	6	0b	Reflects bit 4 in EEPROM 0Fh controlling the PLL shutdown enable control.
PLL Switch	7	0b	Reflects bit 5 in EEPROM word 21h controlling the timing of the switch to PLL clock.
NC-SI Clock Out	8	0b	Reflects the NC-SI clock out setting in bit 13 of EEPROM word 15h.



NC-SI Clock and I/O Pads Strength	10:9	00b	Reflects the NC-SI clock and I/O pad drive strength settings in bits 15:14 of EEPROM word 15h.
SDP_IDDQ_EN	11	0b	Reflects SDP behavior in the dynamic IDDQ setting in bit 6 of EEPROM word Ah.
EEPROM Parallel State	13:12	X	State of the EEPROM parallel access arbitration state machine.
EEPROM Serial State	15:14	X	State of the EEPROM serial access arbitration state machine.
Flash Serial State	17:16	X	State of the Flash serial access arbitration state machine.
Flash Read Data State	19:18	X	State of the Flash read data bus arbitration state machine.
Flash Parallel State	22:20	X	State of the Flash parallel access arbitration state machine.
Reserved	30:23	0h	Reserved
Deadlock Release	31	X	Indicates a deadlock condition was detected in the EEPROM and the current grant was released.

### 14.3.24 Manageability EEPROM Control Register - EEMNGCTL (01010h; RO)

This register is reserved for firmware access to the EEPROM and is read-only by the host.

Field	Bit(s)	Initial Value	Description
Reserved	17:0	00h	Reserved
CFG_DONE 0	18	0b	MNG Configuration Cycle is Done for Port 0 This bit indicates that the MNG configuration cycle (SerDes, PHY, GIO and PLLs) is done for port 0. This bit is set to 1b by MNG firmware to indicate that the configuration is done and cleared by hardware on any of the reset sources that cause the firmware to init the PHY. Writing a 0b by firmware does not affect the state of this bit. <b>Note:</b> The Port 0 software device driver should not try to access the PHY for configuration before this bit is set (see <a href="#">Section 3.0</a> ).
CFG_DONE 1	19	0b	MNG Configuration Cycle is Done for Port 1 This bit indicates that the MNG configuration cycle (SerDes, PHY, GIO and PLLs) is done for port 1. This bit is set to 1b by MNG firmware to indicate that the configuration is done and cleared by hardware on any of the reset sources that cause the firmware to init the PHY. Writing a 0b by firmware does not affect the state of this bit. <b>Note:</b> The Port 1 software device driver should not try to access the PHY for configuration before this bit is set (see <a href="#">Section 3.0</a> ).
Reserved	31:20	00h	Reserved



### 14.3.25 Manageability EEPROM Read/Write Data - EEMNGDATA (1014h; RO)

Field	Bit(s)	Initial Value	Description
WRDATA	15:0	00h	Write Data Data written to the EEPROM.
RDDATA	31:16	X	Read Data Data returned from the EEPROM read.

### 14.3.26 Manageability Flash Control Register - FLMNGCTL (1018h; R/W)

Field	Bit(s)	Initial Value	Description
ADDR	23:0	00h	Address This field is written by manageability along with <i>Start Read</i> or <i>Start Write</i> to indicate the Flash address to read or write.
CMD	24:25	00h	Command Indicates which command should be executed. Valid only when the <i>CMDV</i> bit is set. 00b - Read command. 01b - Write command. 10b - Sector erase. 11b - Erase. The op-codes used for Erase and Sector Erase commands are fixed according to the values set in the FLASHOP register.
CMDV	26	0b	Command Valid When set, indicates that the manageability firmware issues a new command. Cleared by hardware at the end of the command.
FLBUSY	27	0b	Flash Busy This bit indicates that the Flash is busy processing a Flash transaction and shouldn't be accessed.
Reserved	29:28	00h	Reserved
DONE	30	1b	Read Done This bit clears after the <i>CMDV</i> bit is set by manageability and is set back again when the Flash single read transaction completes. When reading a burst transaction, the bit is cleared every time manageability reads the FLMNGRDDATA register.
WRDONE	31	1b	Global Done This bit clears after the <i>CMDV</i> bit is set by manageability and is set back again when the all Flash transactions complete. For example, the Flash unit finished to read all the requested read or other single access (write and erase).

### 14.3.27 Manageability Flash Read Data - FLMNGDATA





## (101Ch; R/W)

Field	Bit(s)	Initial Value	Description
DATA	31:0	00h	Read/write Data On read transactions, this register contains the data returned from the Flash read. On write transactions, bits 7:0 are written to the Flash.

### 14.3.28 Manageability Flash Read Counter - FLMNGCNT (1020h; R/W)

Field	Bit(s)	Initial Value	Description
Abort	31	0b	Abort Writing a 1b to this bit aborts the current burst read operation. It is self-cleared by the Flash interface block when the Abort command is executed.
Reserved	30:25	00h	Reserved
RDCNT	24:0	00h	Read Counter This counter holds the size of the Flash burst read in Dwords.

### 14.3.29 EEPROM Auto Read Bus Control - EEARBC (01024h; R/W)

In EEPROM-less implementations, this register is used to program the 82575 the same way it should be programmed if an EEPROM was present.

**Note:** A separate Application Note is required to enable implementing the software device driver.

Field	Bit(s)	Initial Value	Description
VALID_CORE	0	0b	Valid Write Active to Core 0 Write strobe to Core 0. Firmware/software sets this bit for write access. Software should clear this bit to terminate the write transaction.
VALID_CORE1	1	0b	Valid Write Active to Core 1 Write strobe to Core 1. Firmware/software sets this bit for write access. Software should clear this bit to terminate the write transaction.
VALID_COMMON	2	0b	Valid Write Active to Common Write strobe to Common. Firmware/software sets this bit for write access. Software should clear this bit to terminate the write transaction.
Reserved	3	0b	Reserved Reads as 0b.
ADDR	12:4	0h	Write Address This field specifies the 16-bit word address of the EEPROM data.
Reserved 15:13	0h	0b	Reserved Reads as 0b.
DATA	31:16	0h	Data written into the EEPROM auto read bus.

**Note:**

- More than one valid bit can be set for write accesses. This results in writing the specific address to more than one destination.
- Not all EEPROM addresses are part of the auto read. By using this register software can write to the hardware registers that are configured during auto read only.
- Write access to address 12h in the EEPROM is protected if a valid EEPROM exist. This limitation protects the secured EEPROM mechanism.

### 14.3.30 Watchdog Setup - WDSTP (01040h; R/W)

Field	Bit(s)	Initial Value	Description
WD_Enable	0	0b <sup>1</sup>	Enable Watchdog Timer
WD_Timer_Load_enable (SC)	1	0b	Enables the load of the watchdog timer by writing to WD_Timer field. If this bit is not set, the WD_Timer field is loaded by the value of WD_Timeout. <b>Note:</b> Writing to this field is only for DFX purposes.
Reserved	15:2	0h	Reserved
WD_Timer (RWS)	23:16	WD_Timeout	Indicates the current value of the timer. Resets to the timeout value each time the 82575 functional bit in Software Device Status register is set. If this timer expires, the WD interrupt to the firmware and the WD SDP is asserted. As a result, this timer is stuck at zero until it is re-armed. <b>Note:</b> Writing to this field is only for DFX purposes.
WD_Timeout	31:24	0h <sup>1</sup>	Defines the number of seconds until the watchdog expires. The granularity of this timer is 1 sec. The minimal value allowed for this register when the watchdog mechanism is enabled is two. Setting this field to 1b might cause the watchdog to expire immediately.

1. Value read from the EEPROM.

### 14.3.31 Watchdog SW Device Status - WDSWSTS (01044h; R/W)

Field	Bit(s)	Initial Value	Description
Dev_Functional (SC)	0	0b	Each time this bit is set, the watchdog timer is re-armed. This bit is self clearing
Force_WD (SC)	1	0b	Setting this bit causes the WD timer to expire immediately. The WD_timer field is set to 0b. It can be used by software in order to indicate some fatal error detected in the software or in the hardware. This bit is self clearing.
Reserved	23:2	0h	Reserved
Stuck Reason	31:24	0h	This field can be used by software to indicate to the firmware the reason the 82575 is malfunctioning. The encoding of this field is software/firmware dependent. A value of 0b indicates a functional 82575.



### 14.3.32 Free Running Timer - FRTIMER (01048h; RWS)

This register reflects the value of a free running timer that can be used for various timeout indications. The register is reset by a PCI reset and/or software reset.

**Note:** Writing to this register is for DFX purposes only.

Field	Bit(s)	Initial Value	Description
Microsecond	19:0	0h	Number of microseconds in the current second.
Seconds	31:20	0h	Number of seconds from the timer start (up to 4095 seconds).
Reserved	23:2	0h	Reserved
Stuck Reason	31:24	0h	This field can be used by software to indicate to the firmware the reason the 82575 is malfunctioning. The encoding of this field is software/firmware dependent. A value of 0b indicates a functional 82575.

### 14.3.33 TCP Timer - TCPTIMER (0104Ch; R/W)

Field	Bit(s)	Initial Value	Description
Duration	7:0	0h	Duration Duration of the TCP interrupt interval in $\mu$ s.
KickStart (WS)	8	0b	Counter Kick-Start Writing a 1b to this bit kick-starts the counter down-count from the initial value defined in the <i>Duration</i> field. Writing a 0b has no effect.
TCPCountEn	9	0b	TCP Count Enable 1b = TCP timer counting enabled. 0b = TCP timer counting disabled.  Once enabled, the TCP counter counts from its internal state. If the internal state is equal to 0b, the down-count does not restart until KickStart is activated. If the internal state is not 0b, the down-count continues from internal state.  This enables a pause in the counting for debug purpose.
TCPCountFinish (WS)	10	0b	TCP Count Finish This bit enables software to trigger a TCP timer interrupt, regardless of the internal state.  Writing a 1b to this bit triggers an interrupt and resets the internal counter to its initial value. Down-count does not restart until either KickStart is activated or Loop is set.  Writing a 0b has no effect.
Loop	11	0b	TCP Loop  When set to 1b, the TCP counter reloads duration each time it reaches zero, and continues down-counting from this point without kick-starting.  When set to 0b, the TCP counter stops at a zero value and does not restart until KickStart is activated.  <b>Note:</b> Setting this bit alone is not enough to start the timer activity. The KickStart bit should also be set.
Reserved	31:12	-	Reserved



### 14.3.34 Interrupt Cause Read Register - ICR (000C0H; R)

This register contains the interrupt conditions for the 82575 that are not present directly in the EICR. Each time an ICR interrupt causing event occurs, the corresponding interrupt bit is set in this register. The *EICR.Other* bit reflects the setting of interrupt causes from ICR as masked by the Interrupt Mask Set/Read register. Each time all un-masked causes in ICR are cleared, the *EICR.Other* bit is also cleared.

ICR bits are cleared on register read. Clear-on-read may be enabled/disabled through a general configuration register bit.

Auto clear is not available for the bits in this register.

In order to prevent unwanted LSC interrupts during initialization, software should disable this interrupt until the end of initialization.

Field	Bit(s)	Initial Value	Description
TXDW	0	0b	Transmit Descriptor Written Back Set when the 82575 writes back a Tx descriptor to memory.
Reserved	1	0b	Reserved Should be set to 0b for compatibility.
LSC	2	0b	Link Status Change This bit is set each time the link status changes (either from up to down, or from down to up). This bit is affected by the LINK indication from the PHY (internal PHY mode).
RXSEQ	3	0b	Receive Sequence Error Incoming packets with a bad delimiter sequence set this bit. In other 802.3 implementations, this would be classified as a framing error. A valid sequence consists of: idle → SOF → data → pad (opt) EOF → fill (opt) → idle.
RXDMT0	4	0b	Receive Descriptor Minimum Threshold Reached Indicates that the minimum number of receive descriptors are available and software should load more receive descriptors.
Reserved	5	0b	Reserved
RXO	6	0b	Receiver Overrun Set on receive data FIFO overrun. Could be a result caused by no available receive buffers or because PCIe* receive bandwidth is inadequate.
RXDW	7	0b	Receiver Descriptor Write Back Set when the 82575 writes back an Rx descriptor to memory.
Reserved	8	0b	Reserved Reads as 0b.
MDAC	9	0b	MDIO Access Complete Set when an MDIO access or an SFP I <sup>2</sup> C transaction completes.
Reserved	10	0b	Reserved
GPI_SDP0	11	0b	General Purpose Interrupt on SDP0 If GPI interrupt detection is enabled on this pin (via CTRL_EXT), this interrupt cause is set when the SDP0 is sampled high.
GPI_SDP1	12	0b	General Purpose Interrupt on SDP1 If GPI interrupt detection is enabled on this pin (via CTRL_EXT), this interrupt cause is set when the SDP1 is sampled high.



Field	Bit(s)	Initial Value	Description
GPI_SDP2	13	0b	General Purpose Interrupt on SDP2 If GPI interrupt detection is enabled on this pin (via CTRL_EXT), this interrupt cause is set when the SDP2 is sampled high.
GPI_SDP3	14	0b	General Purpose Interrupt on SDP3 If GPI interrupt detection is enabled on this pin (via CTRL_EXT), this interrupt cause is set when the SDP3 is sampled high.
Reserved	17:15	000b	Reserved
MNG	18	0b	Manageability Event Detected Indicates that a manageability event happened. When the 82575 is at power down mode, the IPMI can generate a PME for the same events that would cause an interrupt when the 82575 is at the D0 state.
Reserved	19	0b	Reserved
OMED	20	0b	Other Media Energy Detect When in SerDes/SGMII mode, indicates that link status has changed on the 1000BASE-T PHY or when in 1000BASE-T PHY mode, there is a change in SerDes/SGMII link status.
Reserved	21	0b	Reserved
RX_PBUR	22	0b	Rx Packet Buffer Unrecoverable Error This bit is set when an unrecoverable error is detected in the packet buffer memory for a Rx packet.
TX_PBUR	23	0b	Tx Packet Buffer Unrecoverable Error This bit is set when an unrecoverable error is detected in the packet buffer memory for a Tx packet.
RX_DHER	24	0b	Rx Descriptor Handler Error This bit is set when an unrecoverable error is detected in the descriptor handler memory for Rx descriptors.
TX_DHER	25	0b	Tx Descriptor Handler Error This bit is set when an unrecoverable error is detected in the descriptor handler memory for Tx descriptors.
SW_WD	26	0b	SW Watchdog This bit is set after a software watchdog timer times out.
Reserved	27	0b	Reserved
OUTSYNC	28	0b	DMA Tx Detected out of Sync Situation Occurs when the amount of data in DMA is not equal to the amount of data pointed to by the descriptor. <b>Note:</b> This bit should never get set during normal operation.
Reserved	31:29	0000b	Reserved

### 14.3.35 Interrupt Cause Set Register - ICS (000C8h; WO)

Software uses this register to set an interrupt condition. Any bit written with a 1b sets the corresponding interrupt. This results in the corresponding bit being set in the Interrupt Cause Read Register (see [Section 14.3.34](#)). A PCIe\* interrupt is generated if one of the bits in this register is set and the corresponding interrupt is enabled through the Interrupt Mask Set/Read Register (see [Section 14.3.36](#)).

Bits written with 0 are unchanged.



Field	Bit(s)	Initial Value	Description
TXDW	0	0b	Sets the Transmit Descriptor Written Back Interrupt.
Reserved	1	-	Reserved
LSC	2	0b	Sets the Link Status Change Interrupt.
RXSEQ	3	0b	Sets the Receive Sequence Error Interrupt.
RXDMT0	4	0b	Sets the Receive Descriptor Minimum Threshold Hit Interrupt.
Reserved	5	0b	Reserved.
RXO	6	0b	Sets the Receiver Overrun Interrupt. Sets on Receive Data FIFO Overrun.
RXDW	7	0b	Receiver Descriptor Write Back Set when the 82575 writes back an Rx descriptor to memory.
Reserved	8	0b	Reserved Reads as 0b.
MDAC	9	0b	Sets the MDI/O Access Complete Interrupt.
RXCFG	10	0b	Sets the Receiving /C/ Ordered Sets Interrupt.
GPI_SDP0	11	0b	Sets the General Purpose Interrupt, related to SDP0 pin.
GPI_SDP1	12	0b	Sets the General Purpose Interrupt, related to SDP1 pin.
GPI_SDP2	13	0b	Sets the General Purpose Interrupt, related to SDP2 pin.
GPI_SDP3	14	0b	Sets the General Purpose Interrupt, related to SDP3 pin.
Reserved	17:15	0b	Reserved.
MNG	18	0b	Sets the Management Event Interrupt.
Reserved	19	0b	Reserved.
OMED	20	0b	Sets the Other Media Energy Detected Interrupt.
Reserved	21	0b	Reserved.
RX PBUR	22	0b	Sets the Receive Packet Buffer Unrecoverable Error Interrupt.
TX PBUR	23	0b	Sets the Transmit Packet Buffer Unrecoverable Error Interrupt.
RX DHER	24	0b	Sets the Rx Descriptor Handler Error Interrupt.
TX DHER	25	0b	Sets the Tx Descriptor Handler Error Interrupt.
SW WD	26	0b	Sets the Software Watchdog Interrupt.
Reserved	27	0b	Reserved.
OUTSYNC	28	0b	Sets the DMA Tx Out of Sync Interrupt.
Reserved	31:29	0000b	Reserved.

### 14.3.36 Interrupt Mask Set/Read Register - IMS (000D0h; R/W)

Reading this register returns bits have an interrupt mask set. An interrupt is enabled if its corresponding mask bit is set to 1b and disabled if its corresponding mask bit is set to 0b. A PCIe\* interrupt is generated each time one of the bits in this register is set and the corresponding interrupt condition occurs. The occurrence of an interrupt condition is reflected by having a bit set in the Interrupt Cause Read Register (see [Section 14.3.34](#)).

A particular interrupt can be enabled by writing a 1b to the corresponding mask bit in this register. Any bits written with a 0b are unchanged. As a result, if software desires to disable a particular interrupt condition that had been previously enabled, it must write to the Interrupt Mask Clear Register (see [Section 14.3.37](#)) rather than writing a 0b to a bit in this register.



Field	Bit(s)	Initial Value	Description
TXDW	0	0b	Sets/Reads the Transmit Descriptor Written Back Interrupt.
Reserved	1	-	Reserved
LSC	2	0b	Sets/Reads the Link Status Change Interrupt.
RXSEQ	3	0b	Sets/Reads the Receive Sequence Error Interrupt.
RXDMT0	4	0b	Sets/Reads the Receive Descriptor Minimum Threshold Hit Interrupt.
Reserved	5	0b	Reserved.
RXO	6	0b	Sets/Reads the Receiver Overrun Interrupt. Sets on Receive Data FIFO Overrun.
RXDW	7	0b	Receiver Descriptor Write Back Set when the 82575 writes back an Rx descriptor to memory.
Reserved	8	0b	Reserved Reads as 0b.
MDAC	9	0b	Sets/Reads the MDIO/SFP Access Complete Interrupt.
RXCFG	10	0b	Sets/Reads the Receiving /C/ Ordered Sets Interrupt.
GPI_SDP0	11	0b	Sets/Reads the General Purpose Interrupt, related to SDP0 pin.
GPI_SDP1	12	0b	Sets/Reads the General Purpose Interrupt, related to SDP1 pin.
GPI_SDP2	13	0b	Sets/Reads the General Purpose Interrupt, related to SDP2 pin.
GPI_SDP3	14	0b	Sets/Reads the General Purpose Interrupt, related to SDP3 pin.
Reserved	17:15	0b	Reserved.
MNG	18	0b	Sets/Reads the Management Event Interrupt.
Reserved	19	0b	Reserved.
OMED	20	0b	Sets/Reads the Other Media Energy Detected Interrupt.
Reserved	21	0b	Reserved.
RX PBUR	22	0b	Sets/Reads the Receive Packet Buffer Unrecoverable Error Interrupt.
TX PBUR	23	0b	Sets/Reads the Transmit Packet Buffer Unrecoverable Error Interrupt.
RX DHER	24	0b	Sets the Rx Descriptor Handler Error Interrupt.
TX DHER	25	0b	Sets the Tx Descriptor Handler Error Interrupt.
SW WD	26	0b	Sets the Software Watchdog Interrupt.
Reserved	27	0b	Reserved.
OUTSYNC	28	0b	Sets/Reads the DMA Tx Out of Sync Interrupt.
Reserved	31:29	0000b	Reserved.

### 14.3.37 Interrupt Mask Clear Register - IMC (000D8h; W)

Software uses this register to disable an interrupt. Interrupts are presented to the bus interface only when the mask bit is set to 1b and the cause bit set to 1b. The status of the mask bit is reflected in the Interrupt Mask Set/Read Register (see [Section 14.3.36](#)), and the status of the cause bit is reflected in the Interrupt Cause Read Register (see [Section 14.3.34](#)). Reading this register returns the value of the IMS register.

Software blocks interrupts by clearing the corresponding mask bit. This is accomplished by writing a 1b to the corresponding bit in this register. Bits written with 0b are unchanged (their mask status does not change).



On interrupt handling, the software device driver should set all the bits in this register related to the current interrupt request even though the interrupt was triggered by part of the causes that were allocated to this vector.

Field	Bit(s)	Initial Value	Description
TXDW	0	0b	Clears the Transmit Descriptor Written Back Interrupt.
Reserved	1	-	Reserved
LSC	2	0b	Clears the Link Status Change Interrupt.
RXSEQ	3	0b	Clears the Receive Sequence Error Interrupt.
RXDMT0	4	0b	Clears the Receive Descriptor Minimum Threshold Hit Interrupt.
Reserved	5	0b	Reserved.
RXO	6	0b	Clears the Receiver Overrun Interrupt. Sets on Receive Data FIFO Overrun.
RXDW	7	0b	Receiver Descriptor Write Back Set when the 82575 writes back an Rx descriptor to memory.
Reserved	8	0b	Reserved Reads as 0b.
MDAC	9	0b	Clears the MDIO/SFP Access Complete Interrupt.
RXCFG	10	0b	Clears the Receiving /C/ Ordered Sets Interrupt.
GPI_SDP0	11	0b	Clears the General Purpose Interrupt, related to SDP0 pin.
GPI_SDP1	12	0b	Clears the General Purpose Interrupt, related to SDP1 pin.
GPI_SDP2	13	0b	Clears the General Purpose Interrupt, related to SDP2 pin.
GPI_SDP3	14	0b	Clears the General Purpose Interrupt, related to SDP3 pin.
Reserved	17:15	0b	Reserved.
MNG	18	0b	Clears the Management Event Interrupt.
Reserved	19	0b	Reserved.
OMED	20	0b	Clears the Other Media Energy Detected Interrupt.
Reserved	21	0b	Reserved.
RX PBUR	22	0b	Clears the Receive Packet Buffer Unrecoverable Error Interrupt.
TX PBUR	23	0b	Clears the Transmit Packet Buffer Unrecoverable Error Interrupt.
RX DHER	24	0b	Clears the Rx Descriptor Handler Error Interrupt.
TX DHER	25	0b	Clears the Tx Descriptor Handler Error Interrupt.
SW WD	26	0b	Clears the Software Watchdog Interrupt.
Reserved	27	0b	Reserved.
OUTSYNC	28	0b	Clears the DMA Tx Out of Sync Interrupt.
Reserved	31:29	0000b	Reserved.

### 14.3.38 Interrupt Acknowledge Auto Mask Register - IAM (000E0h; R/W)

Field	Bit(s)	Initial Value	Description
IAM_VALUE	31:0	0b	Each time the <i>CTRL_EXT.IAME</i> bit is set, an ICR read or write has the side effect of writing the contents of this register to the IMC register.





### 14.3.39 Extended Interrupt Cause - EICR (01580h; RC/W1C)

This register contains the frequent interrupt conditions for the 82575. Each time an interrupt causing event occurs, the corresponding interrupt bit is set in this register. An interrupt is generated each time one of the bits in this register is set and the corresponding interrupt is enabled via the Interrupt Mask Set/Read register. The interrupt might be delayed by the selected Interrupt Throttling register.

Note that the software device driver cannot determine RxQ and TxQ bits as to what was the cause of the interrupt:

- Receive Descriptor Write Back, Receive Queue Full, Receive Descriptor Minimum Threshold hit, Dynamic Interrupt Moderation for Rx.
- Transmit Descriptor Write Back, Transmit Queue Empty, Transmit Descriptor Low Threshold hit for Tx.

Writing a 1b to any bit in the register clears that bit. Writing a 0b to any bit has no effect on that bit.

Register bits are cleared on register read.

Auto clear can be enabled for any or all of the bits in this register.

Field	Bit(s)	Initial Value	Description
RxQ	3:0	0000b	Receive Queue Interrupts One bit per receive queue, activated on receive queue events for the corresponding bit, such as: Receive Descriptor Write Back. Receive Descriptor Minimum Threshold hit.
Reserved	7:4	0000b	Reserved
TxQ	11:8	0000b	Transmit Queue Interrupts One bit per transmit queue, activated on transmit queue events for the corresponding bit such as Transmit Descriptor Write Back.
Reserved	29:12	0h	Reserved
TCP Timer	30	0b	TCP Timer Expired Activated when the TCP timer reaches its terminal count.
Other Cause	31	0b	Interrupt Cause Active Activated when any bit in the ICR register is set.

### 14.3.40 Extended Interrupt Cause Set - EICS (01520h; WO)

Software uses this register to set an interrupt condition. Any bit written with a 1b sets the corresponding bit in the Extended Interrupt Cause Read register. An interrupt is then generated if one of the bits in this register is set and the corresponding interrupt is enabled via the Extended Interrupt Mask Set/Read register. Bits written with 0b are unchanged.

**Note:** In order to set bit 31 of the EICR (Other Causes), the ICS and IMS registers should be used in order to enable one of the legacy causes.



Field	Bit(s)	Initial Value	Description
RxQ	3:0	0000b	Sets the corresponding EICR RxQ interrupt condition.
Reserved	7:4	0000b	Reserved
TxQ	11:8	0000b	Sets the corresponding EICR TxQ interrupt condition.
Reserved	29:12	0h	Reserved
TCP Timer	30	0b	Sets the corresponding EICR TCP interrupt condition.
Reserved	31	0b	Reserved

### 14.3.41 Extended Interrupt Mask Set/Read - EIMS (01524h; RWS)

Reading of this register returns which bits have an interrupt mask set. An interrupt in EICR is enabled if its corresponding mask bit is set to 1b and disabled if its corresponding mask bit is set to 0b. A PCI interrupt is generated each time one of the bits in this register is set and the corresponding interrupt condition occurs (subject to throttling). The occurrence of an interrupt condition is reflected by having a bit set in the Extended Interrupt Cause Read register.

An interrupt might be enabled by writing a 1b to the corresponding mask bit location (as defined in the ICR register) in this register. Any bits written with a 0b are unchanged. As a result, if software needs to disable an interrupt condition that had been previously enabled, it must write to the Extended Interrupt Mask Clear register rather than writing a 0b to a bit in this register.

Field	Bit(s)	Initial Value	Description
RxQ	3:0	0000b	Mask bit for the corresponding EICR RxQ interrupt condition.
Reserved	7:4	0000b	Reserved
TxQ	11:8	0000b	Mask bit for the corresponding EICR TxQ interrupt condition.
Reserved	29:12	0h	Reserved
TCP Timer	30	0b	Mask bit for the corresponding EICR TCP timer interrupt condition.
Other Cause	31	1b	Mask bit for the corresponding EICR other cause interrupt condition.

### 14.3.42 Extended Interrupt Mask Clear - EIMC (01528h; WO)

This register provides software a way to disable certain or all interrupts. Software disables a given interrupt by writing a 1b to the corresponding bit in this register.

On interrupt handling, the software device driver should set all the bits in this register related to the current interrupt request even though the interrupt was triggered by part of the causes that were allocated to this vector.

Interrupts are presented to the bus interface only when the mask bit is set to 1b and the cause bit is set to 1b. The status of the mask bit is reflected in the Extended Interrupt Mask Set/Read register and the status of the cause bit is reflected in the Interrupt Cause Read register.



Software blocks interrupts by clearing the corresponding mask bit. This is accomplished by writing a 1b to the corresponding bit location (as defined in the ICR register) of that interrupt in this register. Bits written with 0b are unchanged (for example, their mask status does not change).

Field	Bit(s)	Initial Value	Description
RxQ	3:0	0000b	Mask bit for the corresponding EICR RxQ interrupt condition.
Reserved	7:4	0000b	Reserved
TxQ	11:8	0000b	Mask bit for the corresponding EICR TxQ interrupt condition.
Reserved	29:12	0h	Reserved
TCP Timer	30	0b	Mask bit for the corresponding EICR TCP timer interrupt condition.
Other Cause	31	1b	Mask bit for the corresponding EICR other cause interrupt condition.

### 14.3.43 Extended Interrupt Auto Clear - EIAC (0152Ch; R/W)

This register is mapped like the EICS, EIMS, and EIMC registers, with each bit mapped to the corresponding bit in the EICR. EICR bits that have auto clear set are cleared when internally sent even if the MSI-X message that they trigger is sent on the PCIe\* bus is not set (masked). Note that the MSI-X message can be delayed by EITR moderation from the time the EICR bit is activated. Bits without auto clear set also need to be cleared with write-to-clear.

**Note:** Read-to-clear is not compatible with auto clear, so if any bits are set to auto clear, the EICR register should not be read.

Field	Bit(s)	Initial Value	Description
RxQ	3:0	0000b	Auto clear bit for the corresponding EICR RxQ interrupt condition.
Reserved	7:4	0000b	Reserved
TxQ	11:8	0000b	Auto clear bit for the corresponding EICR TxQ interrupt condition.
Reserved	29:12	0h	Reserved
TCP Timer	30	0b	Auto clear bit for the corresponding EICR TCP timer interrupt condition.
Other Cause	31	1b	Auto clear bit for the corresponding EICR other cause interrupt condition.

### 14.3.44 Extended Interrupt Auto Mask Enable - EIAM (01530h; R/W)

Each bit in this register enables clearing of the corresponding bit in EIMS following read- or write-to-clear to EICR or setting of the corresponding bit in EIMS following a write-to-set to EICS.

In MSI-X mode, this register controls which of the bits in EIMC to clear upon interrupt generation.

Field	Bit(s)	Initial Value	Description
RxQ	3:0	0000b	Auto mask bit for the corresponding EICR RxQ interrupt condition.
Reserved	7:4	0000b	Reserved
TxQ	11:8	0000b	Auto mask bit for the corresponding EICR TxQ interrupt condition.



Field	Bit(s)	Initial Value	Description
Reserved	29:12	0h	Reserved
TCP Timer	30	0b	Auto mask bit for the corresponding EICR TCP timer interrupt condition.
Other Cause	31	1b	Auto mask bit for the corresponding EICR other cause interrupt condition.

### 14.3.45 Interrupt Throttle - EITR (01680h + 4\*n [n = 0..9]; R/W)

- Interrupt Throttle Register Queue 0 EITR0 (0x01680)
- Interrupt Throttle Register Queue 1 EITR1 (0x01684)
- Interrupt Throttle Register Queue 2 EITR2 (0x01688)
- Interrupt Throttle Register Queue 3 EITR3 (0x0168C)
- Interrupt Throttle Register Queue 4 EITR4 (0x01690)
- Interrupt Throttle Register Queue 5 EITR5 (0x01694)
- Interrupt Throttle Register Queue 6 EITR6 (0x01698)
- Interrupt Throttle Register Queue 7 EITR7 (0x0169C)
- Interrupt Throttle Register Queue 8 EITR8 (0x016A0)
- Interrupt Throttle Register Queue 9 EITR9 (0x016A4)

Each EITR is responsible for an interrupt cause. The allocation of EITR-to-interrupt cause is through MSI-X allocation registers.

Software uses this register to pace (or even out) the delivery of interrupts to the host processor. This register provides a guaranteed inter-interrupt delay between interrupts asserted by the 82575, regardless of network traffic conditions. To independently validate configuration settings, software can use the following algorithm to convert the inter-interrupt interval value to the common interrupts/sec performance metric:

$$\text{interrupts/sec} = (256 \cdot 10^{-9} \text{sec} \cdot \text{interval})^{-1}$$

For example, if the interval is programmed to 500d, the 82575 guarantees the processor will not be interrupted by it for 128  $\mu$ s from the last interrupt. The maximum observable interrupt rate from the 82575 should never exceed 7813 interrupts/sec.

Inversely, inter-interrupt interval value can be calculated as:

$$\text{inter-interrupt interval} = (256 \cdot 10^{-9} \text{sec} \cdot \text{interval})^{-1}$$

The optimal performance setting for this register is very system and configuration specific. An initial suggested range is 65 to -5580 (28B - 15CC).

**Note:** When working at 10/100 Mb/s and running at ¼ clock, the interval time is doubled by four.

Setting EITR to a non zero value can cause an interrupt cause Rx/Tx statistics miscount.

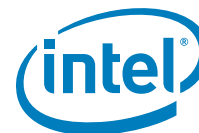

Field	Bit(s)	Initial Value	Description
Reserved	1:0	00b	Reserved
Interval	14:2	0h	Minimum inter-interrupt interval. The interval is specified in 256 ns increments. A zero disables interrupt throttling logic.
Reserved	15	0b	Reserved
Counter (RWS)	31:16	0h	Down Counter Loaded with the interval value each time the associated interrupt is signaled. Counts down to 0 and stops. The associated interrupt is signaled each time this counter is zero and an associated (via the Interrupt Select register) EICR bit is set. This counter can be directly written by software at any time to alter the throttle's performance.

### 14.3.46 Immediate Interrupt Rx - IMIR (05A80h + 4\*n [n = 0..7]; R/W)

This register defines the filtering that corrects which packet triggers dynamic interrupt moderation. Another register includes a size threshold and a control bits bitmap to trigger an immediate interrupt.

**Note:** The *Port* field should be written in network order.

**Note:** If PORT\_IM\_EN is set for a given filter, then at least one of the PORT\_BP, Size\_BP, and CtrlBit\_BP bits should be cleared.

Field	Bit(s)	Initial Value	Description
PORT	15:0	X	Destination TCP Port This field is compared with the destination TCP port in incoming packets.
PORT_IM_EN	16	0b	Destination TCP Port Enable Allows issuing an immediate interrupt if the following three conditions are met: Packet TCP destination port is equal to Port field. Packet length of incoming packet is smaller than Size_Thresh in the IMIREX register. At least one of the TCP control bits of incoming packets is set and the corresponding bit in CtrlBit field in the Im_Int_Rx_Ext register is set.
PORT_BP	17	X	Port Bypass When set to 1b, the TCP port check is bypassed and only other conditions are checked. When set to 0b, the TCP port is checked to fit the port field.
Reserved	31:18	0h	Reserved



### 14.3.47 Immediate Interrupt Rx Extended - IMIREXT (05AA0h + 4\*n [n = 0..7]; R/W)

Field	Bit(s)	Initial Value	Description
Size_Thresh	11:0	X	Size Threshold These 12 bits define a size threshold; a packet with a length below this threshold triggers an interrupt. Enabled by Size_Thresh_en.
CtrlBit	18:13	X	Control Bit When a bit in this field equals 1b, an interrupt is immediately issued after receiving a packet with the corresponding TCP control bits turned on. Bit 13 (URG): Urgent pointer field significant Bit 14 (ACK): Acknowledgment field Bit 15 (PSH): Push function Bit 16 (RST): Reset the connection Bit 17 (SYN): Synchronize sequence numbers Bit 18 (FIN): No more data from sender
CtrlBit_BP	19	X	Control Bits Bypass When set to 1b, the control bits check is bypassed. When set to 0b, the control bits check is performed.
Reserved	31:20	0h	Reserved

**Note:** The size used for this comparison is the size of the packet as forwarded to the host and does not include any of the fields stripped by the MAC (VLAN or CRC). As a result, setting the RCTL.SECRC & CTRL.VME bits should be taken into account while calculating the size threshold.

**Note:** The value of the IMIR and IMIREXT registers after reset is unknown (apart from the IMIR.PORT\_IM\_EN bit which is guaranteed to be cleared). Therefore, both registers should be programmed before IMIR.PORT\_IM\_EN is set for a given flow.

### 14.3.48 Immediate Interrupt Rx VLAN Priority - IMIRVP (05AC0h; R/W)

Field	Bit(s)	Initial Value	Description
Vlan_Pri	2:0	000b	VLAN Priority This field includes the VLAN priority threshold. When Vlan_pri_en is set to 1b, then an incoming packet with a VLAN tag with a priority equal or higher to VlanPri triggers an immediate interrupt, regardless of the EITR moderation.
Vlan_pri_en	3	0b	VLAN Priority Enable When set to 1b, an incoming packet with VLAN tag with a priority equal or higher to Vlan_Pri triggers an immediate interrupt, regardless of the EITR moderation. When set to 0b, the interrupt is moderated by EITR.
Reserved	31:4	0h	Reserved



### 14.3.49 MSI-X Allocation - MSIXBM (01600h + 4\*n [n = 0..9]; R/W)

- MSI-X Allocation Register - MSIXBM0 (01600h)
- MSI-X Allocation Register - MSIXBM1 (01604h)
- MSI-X Allocation Register - MSIXBM2 (0160Ch)
- MSI-X Allocation Register - MSIXBM3 (01610h)
- MSI-X Allocation Register - MSIXBM4 (01614h)
- MSI-X Allocation Register - MSIXBM5 (01618h)
- MSI-X Allocation Register - MSIXBM6 (0161Ch)
- MSI-X Allocation Register - MSIXBM7 (0161Ch)
- MSI-X Allocation Register - MSIXBM8 (01620h)
- MSI-X Allocation Register - MSIXBM9 (01624h)

Each of these registers allocates interrupt causes to one of the 16 possible MSI-X vectors. MSIXBM[0] allocates interrupts to vector 0, MSIXBM[1] allocates interrupts to vector 1, etc.

It is responsibility of software to prevent allocation of an event to multiple vectors; otherwise platform behavior is un-defined.

Field	Bit(s)	Initial Value	Description
RxQ	3:0	0/1b	Receive Queues When a bit in this field is set to 1b, an interrupt occurring in the corresponding RX queue triggers the allocated MSI-X vector. The default for MSIXBM0 is 1h. For all other vectors the default is 0h.
Reserved	7:4	0/1b	Reserved
TxQ	11:8	0/1b	Transmit Queues When a bit in this field is set to 1b, an interrupt occurring in the corresponding RX queue triggers the allocated MSI-X vector. The default for MSIXBM0 is 1b. For all other vectors the default is 0b.
Reserved	29:12	0/1h	Reserved
TCP Timer	30	0/1b	TCP Timer When set to 1b, an interrupt issued by the TCP timer triggers the allocated MSI-X vector. The default for MSIXBM0 is 1b. For all other vectors the default is 0b.
Other Causes	31	0/1b	Other Causes When set to 1b, an interrupt issued by other causes triggers the allocated MSI-X vector. The default for MSIXBM0 is 1b. For all other vectors the default is 0b.

### 14.3.50 Receive Control Register - RCTL (00100h; R/W)

This register controls all 82575 receiver functions.



Field	Bit(s)	Initial Value	Description
Reserved	0	0b	Reserved Write to 0b for future compatibility.
RXEN	1	0b	Receiver Enable The receiver is enabled when this bit is set to 1b. Writing this bit to 0b stops reception after receipt of any in progress packet. All subsequent packets are then immediately dropped until this bit is set to 1b.
SBP	2	0b	Store Bad Packets 0b = do not store. 1b = store bad packets.  This bit controls the MAC receive behavior. A packet is required to pass the address (or normal) filtering before the SBP bit becomes effective. If SBP = 0b, then all packets with layer 1 or 2 errors are rejected. The appropriate statistic would be incremented. If SBP = 1b, then these packets are received (and transferred to host memory). The receive descriptor error field (RDESC.ERRORS) should have the corresponding bit(s) set to signal the software device driver that the packet is erred. In some operating systems the software device driver passes this information to the protocol stack. In either case, if a packet only has layer 3+ errors, such as IP or TCP checksum errors, and passes other filters, the packet is always received (layer 3+ errors are not used as a packet filter).  <b>Note:</b> Symbol errors before the SFD are ignored. Any packet must have a valid SFD (RX_DV with no RX_ER in 10/100/1000BASE-T mode) in order to be recognized by the 82575 (even bad packets). Also, erred packets are not routed to the MNG even if this bit is set.
UPE	3	0b	Unicast Promiscuous Enabled 0b = Disabled. 1b = Enabled.
MPE	4	0b	Multicast Promiscuous Enabled 0b = Disabled. 1b = Enabled.
LPE	5	0b	Long Packet Reception Enable 0b = Disabled. 1b = Enabled.  LPE controls whether long packet reception is permitted. Hardware discards long packets if LPE is 0b. A long packet is one longer than 1522 bytes. If LPE is 1b, the maximum packet size that the 82575 can receive is 16383 bytes.
LBM	7:6	00b	Loopback mode. Controls the loopback mode of the 82575. 00b = Normal operation (or PHY loopback in 10/100/1000BASE-T mode). 01b = MAC loopback (test mode). 10b = Undefined. 11b = Loopback via internal SerDes (SerDes/SGMII mode only). When using the internal PHY, LBM should remain set to 00b and the PHY instead configured for loopback through the MDIO interface.  <b>Note:</b> PHY devices require programming for loopback operation using MDIO accesses.





Field	Bit(s)	Initial Value	Description
RDMTS	9:8	00b	<p>Receive Descriptor Minimum Threshold Size</p> <p>The corresponding interrupt is set each time the fractional number of free descriptors becomes equal to RDMTS.</p> <p>RDMTS[1:0] determines the threshold value for free receive descriptors. See <a href="#">Section 14.3.41</a> for details regarding RDLEN.</p> <p>00b = Free buffer threshold is set to 1/2 of RDLEN.                      01b = Free buffer threshold is set to 1/4 of RDLEN.                      10b = Free buffer threshold is set to 1/8 of RDLEN.                      11b = Reserved.</p>
Reserved	11:10	00b	<p>Reserved</p> <p>Set to 0b for compatibility.</p>
MO	13:12	00b	<p>Multicast Offset</p> <p>Determines which bits of the incoming multicast address are used in looking up the bit vector.</p> <p>00b = bits [47:36] of received destination multicast address.                      01b = bits [46:35] of received destination multicast address.                      10b = bits [45:34] of received destination multicast address.                      11b = bits [43:32] of received destination multicast address.</p>
Reserved	14	0b	Reserved
BAM	15	0b	<p>Broadcast Accept Mode.</p> <p>0b = Ignore broadcast (unless it matches through exact or imperfect filters).                      1b = Accept broadcast packets.</p>
BSIZE	17:16	00b	<p>Receive Buffer Size</p> <p>BSIZE controls the size of the receive buffers and permits software to trade-off descriptor performance versus required storage space. Buffers that are 2048 bytes require only one descriptor per receive packet maximizing descriptor efficiency.</p> <p>00b = 2048 Bytes.                      01b = 1024 Bytes.                      10b = 512 Bytes.                      11b = 256 Bytes.</p> <p><b>Note:</b> BSIZE is not modified when RXEN is set to 1b.</p>
VFE	18	0b	<p>VLAN Filter Enable</p> <p>0b = Disabled (filter table does not decide packet acceptance).                      1b = Enabled (filter table decides packet acceptance for 802.1Q packets).</p> <p>Three bits control the VLAN filter table. The first determines whether the table participates in the packet acceptance criteria. The next two are used to decide whether the CFI bit found in the 802.1Q packet should be used as part of the acceptance criteria.</p>
CFIEN	19	0b	<p>Canonical Form Indicator Enable</p> <p>0b = Disabled (CFI bit found in received 802.1Q packet's tag is not compared to decide packet acceptance).                      1b = Enabled (CFI bit found in received 802.1Q packet's tag must match RCTL.CFI to accept 802.1Q type packet).</p>
CFI	20	0b	<p>Canonical Form Indicator bit value</p> <p>If CFI is set, then 802.1Q packets with CFI equal to this field is accepted; otherwise, the 802.1Q packet is discarded.</p>
Reserved	21	0b	<p>Reserved</p> <p>Should be written with 0b to ensure future compatibility.</p>



Field	Bit(s)	Initial Value	Description
DPF	22	0b	Discard Pause Frames with Station MAC Address Controls whether pause frames directly addressed to this station are forwarded to the host. 0b = incoming pause frames with station MAC address are forwarded to the host. 1b = incoming pause frames with station MAC address are discarded. <b>Note:</b> Pause frames with other MAC addresses (for example, multicast address) are always discarded unless the specific address is added to the accepted MAC addresses (either multicast or unicast).
PMCF	23	0b	Pass MAC Control Frames Filters out unrecognized pause and other control frames. 0b = Pass/forward pause frames. 1b = Filter pause frames (default). PMCF controls the DMA function of MAC control frames (other than flow control). A MAC control frame in this context must be addressed to either the MAC control frame multicast address or the station address, match the type field, and NOT match the PAUSE opcode of 0001h. If PMCF = 1b then frames meeting this criteria are transferred to host memory.
Reserved	25:24	0b0	Reserved Should be written with 0b to ensure future compatibility.
SECRC	26	0b	Strip Ethernet CRC from incoming packet Causes the CRC to be stripped from all packets. 0b = No CRC strip. 1b = Strip CRC. This bit controls whether the hardware strips the Ethernet CRC from the received packet. This stripping occurs prior to any checksum calculations. The stripped CRC is not transferred to host memory and is not included in the length reported in the descriptor.
Reserved	31:27	0h	Reserved Should be written with 0b to ensure future compatibility.

### 14.3.51 Split and Replication Receive Control - SRRCTL (0280Ch + 100\*n [n=0..3]; R/W)

- Split and Replication Receive Control Register (queue 0) - SRRCTL0 (0280Ch)
- Split and Replication Receive Control Register (queue 1) - SRRCTL1 (0290Ch)
- Split and Replication Receive Control Register (queue 2) - SRRCTL2 (02A0Ch)
- Split and Replication Receive Control Register (queue 3) - SRRCTL3 (02B0Ch)



Field	Bit(s)	Initial Value	Description
BSIZEPACKET	6:0	0h	Receive Buffer Size for Packet Buffer The value is in 1 KB resolution. Value can be from 1 KB to 127 KB. Default buffer size is 0 KB. If this field is equal 0b, then RCTL.BSIZE determines the packet buffer size.
Reserved	7	0b	Reserved Should be written with 0b to ensure future compatibility.
BSIZEHEADER	11:8	4h	Receive Buffer Size for Header Buffer The value is in 64 bytes resolution. Value can be from 64 bytes to 1024 bytes. Default buffer size is 256 bytes. This field must be greater than 0 if the value of DESCSTYPE is greater or equal to 2.
Reserved	13:12	00b	Reserved Must be set to 00b.
Reserved	24:14	0h	Reserved.
DESCSTYPE	27:25	000b	Defines the descriptor in Rx 000b = Legacy. 001b = Advanced descriptor one buffer. 010b = Advanced descriptor header splitting. 011b = Always advanced descriptor header replication. 100b = Advanced descriptor header replication large packet only (larger than header buffer size). 101b = Advanced descriptor header splitting (always use header buffer). 111b = Reserved. In non I/OAT, only values 0, 1, 2 and 5 are enabled, writing a value of 3 or 4 is considered as if a value of 1 was written.
Reserved	30:28	0h	Reserved Should be written with 0b to ensure future compatibility.
Drop_En	31	0/1b	Drop Enabled If set, packets received to the queue when no descriptors are available to store them are dropped. The packet is dropped only if there are not enough free descriptors in the host descriptor ring to store the packet. If there are enough descriptors in the host, but they are not yet fetched by the 82575, then the packet is not dropped and there are no release of packets until the descriptors are fetched. Default is 0b for queue 0 and 1b for the other queues.

### 14.3.52 Packet Split Receive Type - PSRTYPE (05480h + 4\*n [n=0..3]; R/W)

This register enables or disables each type of header that needs split.

- Packet Split Receive Type Register (queue 0) - PSRTYPE0 (05480h)
- Packet Split Receive Type Register (queue 1) - PSRTYPE1 (05484h)
- Packet Split Receive Type Register (queue 2) - PSRTYPE2 (05488h)
- Packet Split Receive Type Register (queue 3) - PSRTYPE3 (0548Ch)



Field	Bit(s)	Initial Value	Description
Reserved	0	0b	Reserved
PSR_type1	1	1b	Header includes MAC, (VLAN/SNAP) IPv4 only
PSR_type2	2	1b	Header includes MAC, (VLAN/SNAP) IPv4, TCP only
PSR_type3	3	1b	Header includes MAC, (VLAN/SNAP) IPv4, UDP only
PSR_type4	4	1b	Header includes MAC, (VLAN/SNAP) IPv4, IPv6 only
PSR_type5	5	1b	Header includes MAC, (VLAN/SNAP) IPv4, IPv6, TCP only
PSR_type6	6	1b	Header includes MAC, (VLAN/SNAP) IPv4, IPv6, UDP only
PSR_type7	7	1b	Header includes MAC, (VLAN/SNAP) IPv6 only
PSR_type8	8	1b	Header includes MAC, (VLAN/SNAP) IPv6, TCP only
PSR_type9	9	1b	Header includes MAC, (VLAN/SNAP) IPv6, UDP only
Reserved	10	1b	Reserved
PSR_type11	11	1b	Header includes MAC, (VLAN/SNAP) IPv4, TCP, NFS only
PSR_type12	12	1b	Header includes MAC, (VLAN/SNAP) IPv4, UDP, NFS only
Reserved	13	1b	Reserved
PSR_type14	14	1b	Header includes MAC, (VLAN/SNAP) IPv4, IPv6, TCP, NFS only
PSR_type15	15	1b	Header includes MAC, (VLAN/SNAP) IPv4, IPv6, UDP, NFS only
Reserved	16	1b	Reserved
PSR_type17	17	1b	Header includes MAC, (VLAN/SNAP) IPv6, TCP, NFS only
PSR_type18	18	1b	Header includes MAC, (VLAN/SNAP) IPv6, UDP, NFS only
Reserved	31:19	0h	Reserved

### 14.3.53 Flow Control Receive Threshold Low - FCRTL (02160h; R/W)

This register contains the receive threshold used to determine when to send an XON packet. The complete register reflects the threshold in units of bytes. The lower 4 bits must be programmed to 0b (16 byte granularity). Software must set XONE to enable the transmission of XON frames. Each time hardware crosses the receive-high threshold (becoming more full), and then crosses the receive-low threshold and XONE is enabled (1b), hardware transmits an XON frame. When XONE is set, the *RTL* field should be programmed to at least 1b (at least 16 bytes).

Flow control reception/transmission are negotiated capabilities by the Auto-Negotiation process. When the 82575 is manually configured, flow control operation is determined by the *CTRL.RFCE* and *CTRL.TFCE* bits.

Field	Bit(s)	Initial Value	Description
Reserved	3:0	0000b	Reserved Must be written with 0b.



RTL	15:4	0h	Receive Threshold Low. FIFO low water mark for flow control transmission. This field is in 16 bytes granularity.
Reserved	30:16	0h	Reserved Should be written with 0b for future compatibility. Reads as 0b.
XONE	31	0b	XON Enable 0b = Disabled. 1b = Enabled.

### 14.3.54 Flow Control Receive Threshold High - FCRTH (02168h; R/W)

This register contains the receive threshold used to determine when to send an XOFF packet. The complete register reflects the threshold in units of bytes. This value must be at maximum 48 bytes less than the maximum number of bytes allocated to the Receive Packet Buffer (PBA, RXA), and the lower 4 bits must be programmed to 0b (16 byte granularity). The value of RTH should also be bigger than FCRTL.RTL. Each time the receive FIFO reaches the fullness indicated by RTH, hardware transmits a PAUSE frame if the transmission of flow control frames is enabled.

Flow control reception/transmission are negotiated capabilities by the Auto-Negotiation process. When the 82575 is manually configured, flow control operation is determined by the *CTRL.RFCE* and *CTRL.TFCE* bits.

Field	Bit(s)	Initial Value	Description
Reserved	3:0	0000b	Reserved Must be written with 0b.
RTH	15:4	0h	Receive Threshold High FIFO high water mark for flow control transmission. This field is in 16 bytes granularity.
Reserved	19:16	0h	Reserved Must be set to 0b.
Reserved	31:20	0h	Reserved Should be written to 0b for future compatibility. Reads as 0b.

### 14.3.55 Flow Control Refresh Threshold Value - FCRTV (02460h; R/W)

Field	Bit(s)	Initial Value	Description
FC_refresh_th	15:0	0h	Flow Control Refresh Threshold This value indicates the threshold value of the flow control shadow counter; when the counter reaches this value, and the conditions for PAUSE state are still valid (buffer fullness above low threshold value), a PAUSE (XOFF) frame is sent to link partner. If this field contains zero value, the Flow Control Refresh is disabled.
Reserved	31:16	-	Reserved



### 14.3.55.1 Receive Descriptor Base Address Low - RDBAL (02800h + 100\*n [n=0..3]; R/W)

This register contains the lower bits of the 64-bit descriptor base address. The lower four bits are always ignored. The Receive Descriptor Base Address must point to a 128 byte-aligned block of data.

- Queue0 - RDBAL0 (02800h)
- Queue1 - RDBAL1 (02900h)
- Queue2 - RDBAL2 (02A00h)
- Queue3 - RDBAL3 (02B00h)

Field	Bit(s)	Initial Value	Description
Reserved	6:0	00h	Ignored on writes. Returns 00h on reads.
RDBAL	31:7	X	Receive Descriptor Base Address Low

### 14.3.56 Receive Descriptor Base Address High - RDBAH (02804h + 100\*n [n=0..3]; R/W)

This register contains the upper 32 bits of the 64-bit descriptor base address

- Queue0 - RDBAH0 (02804h)
- Queue1 - RDBAH1 (02904h)
- Queue2 - RDBAH2 (02A04h)
- Queue3 - RDBAH3 (02B04h)

Field	Bit(s)	Initial Value	Description
RDBAH	31:0	X	Receive Descriptor Base Address [63:32]

### 14.3.57 Receive Descriptor Length - RDLEN (02808h + 100\*n [n=0..3]; R/W)

This register sets the number of bytes allocated for descriptors in the circular descriptor buffer. It must be 128-byte aligned.

- Queue0 - RDLEN0 (02808h)
- Queue1 - RDLEN1 (02908h)
- Queue2 - RDLEN2 (02A08h)
- Queue3 - RDLEN3 (02B08h)



Field	Bit(s)	Initial Value	Description
Reserved	6:0	00h	Ignored on writes. Reads back as 00h.
LEN	19:7	00h	Descriptor Length
Reserved	31:20	00h	Reserved Reads as 0b. Should be written to 0b for future compatibility.

### 14.3.58 Receive Descriptor Head - RDH (02810h + 100\*n [n=0..3]; R/W)

The value in this register might point to descriptors that are still not in host memory. As a result, the host cannot rely on this value in order to determine which descriptor to process.

- Queue0 - RDH0 (02810h)
- Queue1 - RDH1 (02910h)
- Queue2 - RDH2 (02A10h)
- Queue3 - RDH3 (02B10h)

Field	Bit(s)	Initial Value	Description
RDH	15:0	0h	Receive Descriptor Head
Reserved	31:16	0h	Reserved Should be written to 0b.

### 14.3.59 Receive Descriptor Tail - RDT (02818h + 100\*n [n=0..3]; R/W)

This register contains the tail pointers for the receive descriptor buffer. The register points to a 16-byte datum. Software writes the tail register to add receive descriptors to the hardware free list for the ring.

- Queue0 - RDT0 (02818h)
- Queue1 - RDT1 (02918h)
- Queue2 - RDT2 (02A18h)
- Queue3 - RDT3 (02B18h)

**Note:** Writing the RDT register while the corresponding queue is disabled is ignored by the 82575.

Field	Bit(s)	Initial Value	Description
RDT	15:0	0h	Receive Descriptor Tail
Reserved	31:16	0h	Reserved Reads as 0b. Should be written to 0b for future compatibility.



### 14.3.60 Receive Descriptor Control - RXDCTL (02828h + 100\*n [n=0..3]; R/W)

This register controls the fetching and write-back of receive descriptors. The three threshold values are used to determine when descriptors are read from and written to host memory. The values are in units of descriptors (each descriptor is 16 bytes).

- Queue0 - RXDCTL0 (02828h)
- Queue1 - RXDCTL1 (02928h)
- Queue2 - RXDCTL2 (02A28h)
- Queue3 - RXDCTL3 (02B28h)

Field	Bit(s)	Initial Value	Description
PTHRESH	5:0	00h	<p>Prefetch Threshold</p> <p>PTHRESH is used to control when a prefetch of descriptors is considered. This threshold refers to the number of valid, unprocessed receive descriptors the 82575 has in its on-chip buffer. If this number drops below PTHRESH, the algorithm considers pre-fetching descriptors from host memory. This fetch does not happen unless there are at least HTHRESH valid descriptors in host memory to fetch.</p> <p><b>Note:</b> HTHRESH should be given a non zero value each time PTHRESH is used.</p>
Reserved	7:6	00h	Reserved
HTHRESH	13:8	00h	Host Threshold
Reserved	15:14	00h	Reserved
WTHRESH	21:16	01h	<p>Write-Back Threshold</p> <p>WTHRESH controls the write-back of processed receive descriptors. This threshold refers to the number of receive descriptors in the on-chip buffer that are ready to be written back to host memory. In the absence of external events (explicit flushes), the write-back occurs only after at least WTHRESH descriptors are available for write-back.</p> <p>Possible values:</p> <p>PTHRESH = 0, 47</p> <p>WTHRESH = 0, 63</p> <p>HTHRESH = 0, 63</p> <p><b>Note:</b> Since the default value for write-back threshold is 1b, the descriptors are normally written back as soon as one cache line is available. WTHRESH must contain a non-zero value to take advantage of the write-back bursting capabilities of the 82575.</p>
Reserved	24:22	00h	Reserved
ENABLE	25	1/0b	<p>Receive Queue Enable</p> <p>When set, the <i>Enable</i> bit enables the operation of the specific receive queue.</p> <p>1b = Default value for queue 1.</p> <p>0b = Default value for queue 3:0.</p> <p>Setting this bit initializes all internal registers of the specific queue. Until then, the state of the queue is kept and can be used for debug purposes.</p> <p>When disabling a queue, this bit is cleared only after all activity in the queue has stopped.</p>
SWFLUSH (WC)	26	0b	<p>Receive Software Flush</p> <p>Enables software to trigger receive descriptor write-back flushing, independently of other conditions.</p> <p>This bit is cleared by hardware.</p>
Reserved	31:27	00h	Reserved





## 14.3.61 Receive Checksum Control - RXCSUM (05000h; R/W)

The Receive Checksum Control register controls the receive checksum offloading features of the 82575. The 82575 supports the offloading of three receive checksum calculations: the Packet Checksum, the IP Header Checksum, and the TCP/UDP Checksum.

**Note:** This register should only be initialized (written) when the receiver is not enabled (for example, only write this register when RCTL.EN = 0b)

Field	Bit(s)	Initial Value	Description
PCSS	7:0	0h	<p>Packet Checksum Start</p> <p>Controls the packet checksum calculation. The packet checksum shares the same location as the RSS field and is reported in the receive descriptor when the RXCSUM.PCSD bit is cleared.</p> <p>If RXCSUM.IPPCSE cleared (the default value), the checksum calculation that is reported in the Rx Packet checksum field is the unadjusted 16-bit ones complement of the packet. The packet checksum starts from the byte indicated by RXCSUM.PCSS (0b corresponds to the first byte of the packet), after VLAN stripping if enabled by the CTRL.VME. For example, for an Ethernet II frame encapsulated as an 802.3ac VLAN packet and with RXCSUM.PCSS set to 14, the packet checksum would include the entire encapsulated frame, excluding the 14-byte Ethernet header (DA, SA, Type/Length) and the 4-byte VLAN tag. The packet checksum does not include the Ethernet CRC if the RCTL.SECRC bit is set. Software must make the required offsetting computation (to back out the bytes that should not have been included and to include the pseudo-header) prior to comparing the packet checksum against the TCP checksum stored in the packet checksum is aimed to accelerate checksum calculation of fragmented UDP packets.</p> <p><b>Note:</b> The PCSS value should not exceed a pointer to the IP header start. If exceeded, the IP header checksum or TCP/UDP checksum will not be calculated correctly.</p>
IPOFLD	8	1b	<p>IP Checksum Off-load Enable</p> <p>RXCSUM.IPOFLD is used to enable the IP Checksum off-loading feature. If RXCSUM.IPOFLD is set to 1b, the 82575 calculates the IP checksum and indicates a pass/fail indication to software via the IP Checksum Error bit (IPE) in the <i>Error</i> field of the receive descriptor. Similarly, if RXCSUM.TUOFLD is set to 1b, the 82575 calculates the TCP or UDP checksum and indicates a pass/fail indication to software via the TCP/UDP Checksum Error bit (TCPE). Similarly, if RFCTL.IPv6_DIS and RFCTL.IP6Xsum_DIS are cleared to 0b and RXCSUM.TUOFLD is set to 1b, the 82575 calculates the TCP or UDP checksum for IPv6 packets. It then indicates a pass/fail condition in the TCP/UDP <i>Checksum Error</i> bit (RDESC.TCPE).</p> <p>This applies to checksum offloading only. Supported frame types:</p> <ul style="list-style-type: none"> <li>Ethernet II</li> <li>Ethernet SNAP</li> </ul>
TUOFLD	9	1b	TCP/UDP Checksum Off-load Enable
Reserved	10	0b	Reserved
CRCOFL	11	0b	<p>CRC32 Offload Enable</p> <p>Enables the CRC32 checksum off-loading feature. If RXCSUM.CRCOFL is set to 1b, the 82575 calculates the CRC32 checksum and indicates a pass/fail indication to software via the CRC32 <i>Checksum Valid</i> bit (CRCV) in the <i>Extended Status</i> field of the receive descriptor.</p> <p>In non I/OAT, this bit is read only as 0b.</p>



IPPCSE	12	0b	IP Payload Checksum Enable See PCSS description.
PCSD	13	0b	Packet Checksum Disable The packet checksum and IP identification fields are mutually exclusive with the RSS hash. Only one of the two options is reported in the Rx descriptor. RXCSUM.PCSD Legacy Rx Descriptor (SRRCTL.DESCTYPE = 000b): 0b (checksum enable) - Packet checksum is reported in the Rx descriptor. 1b (checksum disable) - Not supported. RXCSUM.PCSD Extended or Header Split Rx Descriptor (SRRCTL.DESCTYPE = 000b): 0b (checksum enable) - checksum and IP identification are reported in the Rx descriptor. 1b (checksum disable) - RSS Hash value is reported in the Rx descriptor.
Reserved	31:14	0h	Reserved

### 14.3.62 Receive Long Packet Maximum Length - RLPML (05004; R/W)

Field	Bit(s)	Initial Value	Description
RLPML	13:0	2400h	Maximum allowed long packet length.
Reserved	31:14	0h	Reserved

### 14.3.63 Receive Filter Control Register - RFCTL (05008h; R/W)

Field	Bit(s)	Initial Value	Description
Reserved	0	1b	Must be set to 1b.
Reserved	4:0	0b	Reserved
NFSW_DIS	6	0b	NFS Write Disable Disables filtering of NFS write request headers.
NFSR_DIS	7	0b	NFS Read Disable Disables filtering of NFS read reply headers.
NFS_VER	9:8	00b	NFS Version 00b = NFS version 2. 01b = NFS version 3. 10b = NFS version 4. 11b = Reserved for future use.
IPv6_DIS	10	0b	IPv6 Disable Disables IPv6 packet filtering. Any received IPv6 packet is parsed only as an L2 packet.
IPv6XSUM_DIS	11	0b	IPv6 XSUM Disable Disables XSUM on IPv6 packets.
Reserved	13:12	00b	Reserved



IPFRSP_DIS	14	0b	IP Fragment Split Disable When this bit is set the header of IP fragmented packets are not set.
Reserved	15	0b	Reserved
Reserved	17:16	00b	Reserved Must be set to 00b.
LEF	18	0b	Forward Length Error Packets If set, packets with length error are forwarded to the host. Otherwise, are dropped.
Reserved	31:19	00h	Reserved Should be written with 0b to ensure future capability.

### 14.3.64 Transmit Control Register - TCTL (00400h; R/W)

This register controls all transmit functions for the 82575.

Software can choose to abort packet transmission in less than the Ethernet mandated 16 collisions. For this reason, hardware provides CT.

**Note:** While 802.3x flow control is only defined during full duplex operation, the sending of PAUSE frames via the SWXOFF bit is not gated by the duplex settings within the 82575. Software should not write a 1b to this bit while the 82575 is configured for half-duplex operation.

RTLC configures the 82575 to perform retransmission of packets when a late collision is detected. Note that the collision window is speed dependent: 64 bytes for 10/100 Mb/s and 512 bytes for 1000 Mb/s operation. If a late collision is detected when this bit is disabled, the transmit function assumes the packet has successfully transmitted. This bit is ignored in full-duplex mode.

Field	Bit(s)	Initial Value	Description
Reserved	0	0b	Reserved Write as 0b for future compatibility.
EN	1	0b	Transmit Enable The transmitter is enabled when this bit is set to 1b. Writing 0b to this bit stops transmission after any in progress packets are sent. Data remains in the transmit FIFO until the device is re-enabled. Software should combine this operation with reset if the packets in the TX FIFO should be flushed.
Reserved	2	0b	Reserved Reads as 0b. Should be written to 0b for future compatibility.
PSP	3	0b	Pad Short Packets 0b = Do not pad. 1b = Pad. Padding makes the packet 64 bytes long. This is not the same as the minimum collision distance. If padding of short packets is allowed, the value in the Tx descriptor length field should be not less than 17 bytes.



Field	Bit(s)	Initial Value	Description
CT	11:4	0Fh	Collision Threshold This determines the number of attempts at retransmission prior to giving up on the packet (not including the first transmission attempt). While this can be varied, it should be set to a value of 15 in order to comply with the IEEE specification requiring a total of 16 attempts. The Ethernet back-off algorithm <sup>1</sup> is implemented and clamps to the maximum number of slot-times after 10 retries. This field only has meaning when in half-duplex operation.
BST	21:12	3Fh	Back-Off Slot Time This value determines the back-off slot time value in byte time.
SWXOFF	22	0b	Software XOFF Transmission When set to 1b, the 82575 schedules the transmission of an XOFF (PAUSE) frame using the current value of the PAUSE timer (FCTTV.TTV). This bit self-clears upon transmission of the XOFF frame.
PBE	23	0b	Packet Burst Enable The 82575 does not support packet bursting for 1Gb/s half-duplex transmit operation. This bit must be set to 0b.
RTLCL	24	0b	Re-transmit on Late Collision When set, enables the 82575 to re-transmit on a late collision event.
Reserved	25	0b	Reserved
Reserved	27:26	01h	Reserved
Reserved	31:28	0Ah	Reserved

1. The 82575's Back-off Algorithm is not fully compliant with the 802.3 specification.

### 14.3.65 Transmit Control Extended - TCTL\_EXT (00404;R/W)

This register controls late collision detection.

COLD is used to determine the latest time in which a collision indication is considered as a valid collision and not a late collision. When using the internal PHY, the default value of 41h provides a behavior consistent with the 802.3 spec requested behavior. However, when using an SGMII connected PHY, the SGMII adds some delay on top of the time budget allowed by the specification (collisions in valid network topographies even after 512 bit time can be expected). In order to accommodate this condition, COLD should be updated to take the SGMII inbound and outbound delays. The delay induced by the 82575 is 16 bit time in 10 Mb/s (add two to the COLD field value) and 40 bit time in 100 Mb/s (add five to the COLD field value). A delay induced by the specific PHY used should also be added.

Field	Bit(s)	Initial Value	Description
Reserved	9:0	40h	Reserved
COLD	19:10	42h	Collision Distance Used to determine the latest time in which a collision indication is considered as a valid collision and not a late collision.
Reserved	31:20	0h	Reserved.



### 14.3.66 Transmit IPG Register - TIPG (00410;R/W)

This register controls the Inter Packet Gap (IPG) timer. The recommended TIPG value to achieve 802.3 compliant minimum transmit IPG values in full and half duplex is 00702008h.

Field	Bit(s)	Initial Value	Description
IPGT	9:0	08h	<p>IPG Back to Back</p> <p>Specifies the IPG length for back to back transmissions in both full and half duplex.</p> <p>Measured in increments of the MAC clock:</p> <p>8 ns MAC clock when operating @ 1 Gb/s.</p> <p>80 ns MAC clock when operating @ 100 Mb/s.</p> <p>800 ns MAC clock when operating @ 10 Mb/s.</p> <p>IPGT specifies the IPG length for back-to-back transmissions in both full duplex and half duplex. Note that an offset of 4 byte times is added to the programmed value to determine the total IPG. As a result, a value of 8 is recommended to achieve a 12 byte time IPG.</p>
IPGR1	19:10	08h	<p>IPG Part 1</p> <p>Specifies the portion of the IPG in which the transmitter defers to receive events. IPGR1 should be set to 2/3 of the total effective IPG (8).</p> <p>Measured in increments of the MAC clock:</p> <p>8 ns MAC clock when operating @ 1 Gb/s.</p> <p>80 ns MAC clock when operating @ 100 Mb/s</p> <p>800 ns MAC clock when operating @ 10 Mb/s.</p>
IPGR	29:20	06h	<p>IPG After Deferral</p> <p>Specifies the total IPG time for non back-to-back transmissions (transmission following deferral) in half duplex.</p> <p>Measured in increments of the MAC clock:</p> <p>8 ns MAC clock when operating @ 1 Gb/s.</p> <p>80 ns MAC clock when operating @ 100 Mb/s</p> <p>800 ns MAC clock when operating @ 10 Mb/s.</p> <p>An offset of 5-byte times must be added to the programmed value to determine the total IPG after a defer event. A value of 7 is recommended to achieve a 12-byte effective IPG. Note that the IPGR must never be set to a value greater than IPGT. If IPGR is set to a value equal to or larger than IPGT, it overrides the IPGT IPG setting in half duplex resulting in inter-packet gaps that are larger than intended by IPGT. In this case, full duplex is unaffected and always relies on IPGT.</p> <p>The recommended TIPG value to achieve 802.3 compliant minimum transmit IPG values in full and half duplex is 00601008h.</p>
Reserved	31:30	00b	<p>Reserved</p> <p>Read as 0b.</p> <p>Should be written with 0b for future compatibility.</p>

### 14.3.67 DMA Tx Control - DTXCTL (03590h; R/W)

This register controls whether an IP identification field scrolls on 15-bit or 16-bit boundaries in TSO packets.



Field	Bit(s)	Initial Value	Description
IPID_15'	0	0b	<p>IP Identification 15-Bit</p> <p>When set to 1b, the IP identification field increments and wraps around on 15-bit base. For example, if IP ID is equal to 7FFFh then the next value is 0000h; if IP ID is equal to FFFFh then the next value is 8000h.</p> <p>When set to 0b, the IP Identification field increments and wraps around on 16-bit base. In this case, the value following 7FFFh is 8000h and the value following FFFFh is 0000h.</p> <p>This feature enables software to manage two subgroups of connections.</p>
Reserved	31:1	0h	Reserved

### 14.3.68 Transmit Descriptor Base Address Low - TDBAL (03800h + 100\*n [n=0..3]; R/W)

These registers contain the lower bits of the 64-bit descriptor base address. The lower 4 bits are ignored. The Transmit Descriptor Base Address must point to a 128-byte aligned block of data.

- Queue0 - TDBAL0 (03800h)
- Queue1 - TDBAL1 (03900h)
- Queue2 - TDBAL2 (03A00h)
- Queue3 - TDBAL3 (03B00h)

Field	Bit(s)	Initial Value	Description
Reserved	6:0	00h	Ignored on writes. Returns 00h on reads.
TDBAL	31:7	X	Transmit Descriptor Base Address Low

### 14.3.69 Transmit Descriptor Base Address High - TDBAH (03804h + 100\*n [n=0..3]; R/W)

These registers contain the upper 32 bits of the 64-bit descriptor base address.

- Queue0 - TDBAH0 (03804h)
- Queue1 - TDBAH1 (03904h)
- Queue2 - TDBAH2 (03A04h)
- Queue3 - TDBAH3 (03B04h)

Field	Bit(s)	Initial Value	Description
TDBAH	31:0	X	Transmit Descriptor Base Address [63:32]



### 14.3.70 Transmit Descriptor Length - TDLEN (03808h + 100\*n [n=0..3]; R/W)

These registers contain the descriptor length and must be 128-byte aligned.

- Queue0 - TDLEN0 (03808h)
- Queue1 - TDLEN1 (03908h)
- Queue2 - TDLEN2 (03A08h)
- Queue3 - TDLEN3 (03B08h)

Field	Bit(s)	Initial Value	Description
reserved	6:0	00h	Ignore on writes. Reads back as 00h.
LEN	19:7	0h	Descriptor Length
Reserved	31:20	0h	Reserved Reads as 0b. Should be written to 0b.

### 14.3.71 Transmit Descriptor Head - TDH (03810h + 100\*n [n=0..3]; R/W)

These registers contain the head pointer for the transmit descriptor ring. It points to a 16-byte datum. Hardware controls this pointer.

**Note:** The values in these registers might point to descriptors that are still not in host memory. As a result, the host cannot rely on these values in order to determine which descriptor to release.

- Queue0 - TDH0 (03810h)
- Queue1 - TDH1 (03910h)
- Queue2 - TDH2 (03A10h)
- Queue3 - TDH3 (03B10h)

Field	Bit(s)	Initial Value	Description
TDH	15:0	0h	Transmit Descriptor Head
Reserved	31:16	0h	Reserved Should be written to 0b.

### 14.3.72 Transmit Descriptor Tail - TDT (03818h + 100\*n [n=0..3]; R/W)

These registers contain the tail pointer for the transmit descriptor ring and points to a 16-byte datum. Software writes the tail pointer to add more descriptors to the transmit ready queue. Hardware attempts to transmit all packets referenced by descriptors between head and tail.

- Queue0 - TDT0 (03818h)



- Queue1 - TDT1 (03918h)
- Queue2 - TDT2 (03A18h)
- Queue3 - TDT3 (03B18h)

Field	Bit(s)	Initial Value	Description
TDT	15:0	00h	Transmit Descriptor Tail
Reserved	31:16	00h	Reserved Reads as 0b. Should be written to 00h for future compatibility.

### 14.3.73 Transmit Descriptor Control - TXDCTL (03828h + 100\*n [n=0..3]; R/W)

These registers control the fetching and write-back of transmit descriptors. The three threshold values are used to determine when descriptors are read from and written to host memory. The values are in units of descriptors (each descriptor is 16 bytes).

Since write-back of transmit descriptors is optional (under the control of *RS* bit in the descriptor), not all processed descriptors are counted with respect to *WTHRESH*. Descriptors start accumulating after a descriptor when *RS* is set. In addition, with transmit descriptor bursting enabled, some descriptors are written back that did not have *RS* set in their respective descriptors.

**Note:** When *WTHRESH* = 0b, only descriptors with the *RS* bit set are written back

- Queue0 - TXDCTL0 (03828h)
- Queue1 - TXDCTL1 (03928h)
- Queue2 - TXDCTL2 (03A28h)
- Queue3 - TXDCTL3 (03B28h)

Field	Bit(s)	Initial Value	Description
PTHRESH	5:0	00h	Prefetch Threshold Controls when a prefetch of descriptors is considered. This threshold refers to the number of valid, unprocessed transmit descriptors the 82575 has in its on-chip buffer. If this number drops below <i>PTHRESH</i> , the algorithm considers pre-fetching descriptors from host memory. However, this fetch does not happen unless there are at least <i>HTHRESH</i> valid descriptors in host memory to fetch. <b>Note:</b> <i>HTHRESH</i> should be given a non zero value each time <i>PTHRESH</i> is used.
Reserved	7:6	00h	Reserved
HTHRESH	13:8	00h	Host Threshold
Reserved	15:14	00h	Reserved Reads as 0b. Should be written as 0b for future compatibility.
WTHRESH	21:16	00h	Write-Back Threshold Controls the write-back of processed transmit descriptors. This threshold refers to the number of transmit descriptors in the on-chip buffer that are ready to be written back to host memory. In the absence of external events (explicit flushes), the write-back occurs only after at least <i>WTHRESH</i> descriptors are available for write-back. <b>Note:</b> Since the default value for write-back threshold is 0b, descriptors are normally written back as soon as they are processed. <i>WTHRESH</i> must be written to a non-zero value to take advantage of the write-back bursting capabilities of the 82575.



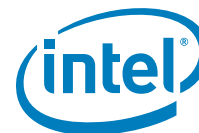

Field	Bit(s)	Initial Value	Description
Reserved	24:22	00h	Reserved
ENABLE	25	1/0b	<p>Transmit Queue Enable</p> <p>When set, this bit enables the operation of a specific transmit queue:                      Default value for Q0 = 1b.                      Default value for Q3:1 = 0b.</p> <p>Setting this bit initializes all the internal registers of a specific queue. Until then, the state of the queue is kept and can be used for debug purposes.</p> <p>When disabling a queue, this bit is cleared only after all activity at the queue stopped.</p> <p><b>Note:</b> This bit is valid only if the queue is actually enabled, thus if RCTL.RXEN is cleared, this bit remain 0b.</p>
SWFLSH	26	0b	<p>Transmit Software Flush</p> <p>This bit enables software to trigger descriptor write-back flushing, independently of other conditions.</p> <p>This bit is self cleared by hardware.</p>
Priority	27	0b	<p>Priority</p> <p>Sets the arbitration priority for this queue.</p> <p>0b = Low priority.                      1b = High priority.</p>
Reserved	31:28	0h	Reserved

### 14.3.74 Tx Descriptor Completion Write-Back Address Low - TDWBAL (03838h + 100\*n [n=0..3]; R/W)

- Queue0 - TDWBAL0 (03838h)
- Queue1 - TDWBAL1 (03938h)
- Queue2 - TDWBAL2 (03A38h)
- Queue3 - TDWBAL3 (03B38h)

Field	Bit(s)	Initial Value	Description
Head_WB_En	0	0b	<p>Head Write-Back Enable</p> <p>1b = Head write-back enabled.                      0b = Head write-back is disabled.</p> <p>When head_WB_en is set, SN_WB_en is ignored and no descriptor write-back is executed.</p>
Reserved	1	0b	Reserved
HeadWB_Low	31:2	0h	Lowest 32 bits of the head write-back memory location (DWORD aligned). Note that the last two bits are always 00b.



### 14.3.75 Tx Descriptor Completion Write-Back Address High - TDWBAH (0383Ch + 100\*n [n=0..3]; R/W)

- Queue0 - TDWBAH0 (0383Ch)
- Queue1 - TDWBAH1 (0393Ch)
- Queue2 - TDWBAH2 (03A3Ch)
- Queue3 - TDWBAH3 (03B3Ch)

Field	Bit(s)	Initial Value	Description
HeadWB_High	31:0	0h	Highest 32 bits of the head write-back memory location (for 64-bit addressing).

### 14.3.76 PCS Configuration 0 - PCS\_CFG (04200h; R/W)

Field	Bit(s)	Initial Value	Description
Reserved	2:0	000b	Reserved
PCS Enable	3	1b	PCS Enable Enables the PCS logic of the MAC. Should be set in both SGMII and SerDes mode for normal operation. Clearing this bit disables RX/TX of both data and control codes. Use this to force link down at the far end.
Reserved	29:4	0h	Reserved
PCS Isolate	30	0b	PCS Isolate Setting this bit isolates the PCS logic from the MAC's data path. PCS control codes are still sent and received.
SRESET	31	0b	Soft Reset Setting this bit puts all modules within the MAC in reset except the Host Interface. The Host Interface is reset via HRST. This bit is NOT self clearing; GMAC is in a reset state until this bit is set.



### 14.3.77 PCS Link Control - PCS\_LCTL (04208h; R/W)

Field	Bit(s)	Initial Value	Description
FLV	0	0b	Forced Link Value This bit denotes the link condition when force link is set. 0b = Forced link down. 1b = Forced link up.
FSV	2:1	10b	Forced Speed Value These bits denote the speed when force speed and duplex is set. This value is also used when AN is disabled or when in SerDes mode. 00b = 10 Mb/s (SGMII). 01b = 100 Mb/s (SGMII). 10b = 1000 Mb/s (SerDes/SGMII). 11b = Reserved.
FDV	3	1b	Forced Duplex Value This bit denotes the duplex mode when force speed and duplex is set. This value is also used when AN is disabled or when in SerDes mode. 1b = Full duplex (SerDes/SGMII). 0b = Half duplex (SGMII).
FSD	4	0b	Force Speed and Duplex If this bit is set, then speed and duplex mode is forced to forced speed value and forced duplex value, respectively. Otherwise, speed and duplex mode are decided by internal AN/SYNC state machines.
FORCE LINK	5	0b	Force Link If this bit is set, then the internal LINK_OK variable is forced to forced link value (bit 0 of this register). Otherwise, LINK_OK is decided by internal AN/SYNC state machines.
LINK LATCH LOW	6	0b	Link Latch Low Enable If this bit is set, then link OK going LOW (negative edge) is latched until a processor read. Afterwards, link OK is continuously updated until link OK again goes LOW (negative edge is seen).
Reserved	15:7	-	Reserved
AN_ENABLE	16	0b <sup>1</sup>	AN Enable Setting this bit enables the AN process.
AN RESTART	17	0b	AN Restart Setting this bit restarts the AN process. This bit is self clearing.
AN TIMEOUT EN	18	1b	AN Timeout Enable This bit enables the AN Timeout feature. During AN, if the link partner does not respond with AN pages, but continues to send good IDLE symbols, then LINK UP is assumed. (This enables LINK UP condition when link partner is not AN-capable and does not affect otherwise). This bit should not be set in SGMII mode.
AN SGMII BYPASS	19	0b	AN SGMII Bypass If this bit is set, then IDLE detect state is bypassed during AN in SGMII mode. This reduces the acknowledge time in SGMII mode.
AN SGMII TRIGGER	20	0b	AN SGMII Trigger If this bit is cleared, then AN is not automatically triggered in SGMII mode even if SYNC fails. AN is triggered only in response to PHY messages or by a manual setting like changing the AN Enable/Restart bits.



Field	Bit(s)	Initial Value	Description
Reserved	23:21	000b	Reserved
FAST LINK TIMER	24	0b	Fast Link Timer AN timer is reduced if this bit is set.
LINK OK FIX EN	25	1b	Link OK Fix Enable Control for enabling/disabling LinkOK/SyncOK fix. Should be set for normal operation.
Reserved	31:26	0h	Reserved

1. Read from EEPROM word 0Fh, bit 11.

### 14.3.78 PCS Link Status - PCS\_LSTS (0420Ch; R/W)

Field	Bit(s)	Initial Value	Description
LINK OK	0	0b	Link OK This bit denotes the current link ok status. 0b = Link down. 1b = Link up/OK.
SPEED	2:1	10b	Speed This bit denotes the current operating Speed. 00b = 10 Mb/s. 01b = 100 Mb/s. 10b = 1000 Mb/s. 11b = Reserved.
DUPLEX	3	1b	Duplex This bit denotes the current duplex mode. 1b = Full duplex. 0b = Half duplex.
SYNC OK	4	0b	Sync OK This bit indicates the current value of Sync OK from the PCS Sync state machine.
Reserved	15:5	-	Reserved
AN COMPLETE	16	0b	AN Complete This bit indicates that the AN process has completed.
Reserved	15:7	-	Reserved
AN_ENABLE	16	0b	AN Enable Setting this bit enables the AN process.
Reserved	17	0b	Reserved
AN TIMEDOUT	18	0b	AN Timed Out This bit indicates an AN process was timed out. Valid after the <i>AN Complete</i> bit is set.



Field	Bit(s)	Initial Value	Description
AN REMOTE FAULT	19	0b	AN Remote Fault This bit indicates that an AN page was received with a remote fault indication during an AN process. This bit cleared on reads.
AN ERROR (RWS)	20	0B	AN Error This bit indicates that a AN error condition was detected in SerDes/SGMII mode. Valid after the <i>AN Complete</i> bit is set. AN error conditions: SerDes mode: Both node not Full Duplex or Remote Fault indicated or received. SGMII mode: PHY is set to 1000 Mb/s Half Duplex mode. Software can also force a AN error condition by writing to this bit (or can clear a existing AN error condition). This bit is cleared at the start of AN.
Reserved	31:21	0h	Reserved

### 14.3.79 AN Advertisement - PCS\_ANADV (04218h; R/W)

Field	Bit(s)	Initial Value	Description
Reserved	4:0	-	Reserved
FDCAP	5	1b	Full Duplex Setting this bit indicates that the 82575 is capable of full duplex operation. This bit should be set to 1b for normal operation.
HDCAP (RO)	6	0b	Half Duplex This bit indicates that the 82575 is capable of half duplex operation. This bit is tied to 0b because the 82575 does not support half duplex in SerDes mode.
ASM	8:7	0b <sup>1</sup>	Local PAUSE Capabilities The 82575's PAUSE capability is encoded in this field. 00b = No PAUSE. 01b = Symmetric PAUSE. 10b = Asymmetric PAUSE to link partner. 11b = Both symmetric an- asymmetric PAUSE to the 82575.
Reserved	11:9	-	Reserved
RFLT	13:12	00b	Remote Fault The 82575's remote fault condition is encoded in this field. The 82575 might indicate a fault by setting a non-zero remote fault encoding and re-negotiating. 00b = No error, link OK. 01b = Link failure. 10b = Offline. 11b = Auto-negotiation error.



Field	Bit(s)	Initial Value	Description
Reserved	14	-	Reserved
NEXTP	15	0b	Next Page Capable The 82575 asserts this bit to request a next page transmission. The 82575 clears this bit when no subsequent next pages are requested.
Reserved	31:16	0h	Reserved

1. Loaded from EEPROM word 0Fh, bits 13:12.

### 14.3.80 Link Partner Ability - PCS\_LPAB (0421Ch; RO)

Field	Bit(s)	Initial Value	Description
Reserved	4:0	-	Reserved
LFPD	5	0b	LP Full Duplex (SerDes) When set to 1b, the link partner is capable of full duplex operation. When set to 0b, the link partner is not capable of full duplex mode. This bit is reserved while in SGMII mode.
LPHD	6	0b	LP Half Duplex (SerDes) When set to 1b, the link partner is capable of half duplex operation. When set to 0b, the link partner is not capable of half duplex mode. This bit is reserved while in SGMII mode.
LPASM	8:7	00b	LP ASMDR/LP PAUSE (SerDes) The link partner's PAUSE capability is encoded in this field. 00b = No PAUSE. 01b = Symmetric PAUSE. 10b = Asymmetric PAUSE to link partner. 11b = Both symmetric and asymmetric PAUSE to the 82575. These bits are reserved while in SGMII mode.
Reserved	9	-	Reserved
SGMII SPEED	11:10	00b	SerDes: reserved. Speed (SGMII): Speed indication from the PHY.
PRF	13:12	00b	LP Remote Fault (SerDes) The link partner's remote fault condition is encoded in this field. 00b = No error, link ok. 10b = Link failure. 01b = Offline. 11b = Auto-negotiation error. SGMII[13]: Reserved SGMII[12]: Duplex mode indication from the PHY.



Field	Bit(s)	Initial Value	Description
ACK	14	0b	Acknowledge (SerDes) The link partner has acknowledge page reception. SGMII: Reserved.
LPNEXTP	15	0b	LP Next Page Capable (SerDes) The link partner asserts this bit to indicate its ability to accept next pages. SGMII: Link-OK indication from the PHY.
Reserved	31:16	-	Reserved

### 14.3.81 Next Page Transmit - PCS\_NPTX (04220h; RO)

Field	Bit(s)	Initial Value	Description
CODE	10:0	0h	Message/Unformatted Code Field The Message Field is a 11-bit wide field that encodes 2048 possible messages. Unformatted Code Field is a 11-bit wide field that might contain an arbitrary value.
TOGGLE	11	0b	Toggle This bit is used to ensure synchronization with the Link Partner during Next Page exchange. This bit always takes the opposite value of the <i>Toggle</i> bit in the previously exchanged Link Code Word. The initial value of the <i>Toggle</i> bit in the first Next Page transmitted is the inverse of bit 11 in the base Link Code Word and, therefore, can assume a value of 0b or 1b. The <i>Toggle</i> bit is set as follows: 0b = Previous value of the transmitted Link Code Word when 1b 1b = Previous value of the transmitted Link Code Word when 0b.
ACK2	12	0b	Acknowledge 2 Used to indicate that a device has successfully received its Link Partners' Link Code Word.
PGTYPE	13	0b	Message/Unformatted Page This bit is used to differentiate a Message Page from an Unformatted Page. The encodings are: 0b = Unformatted page. 1b = Message page.
Reserved	14	-	Reserved
NXTPG	15	0b	Next Page Used to indicate whether or not this is the last Next Page to be transmitted. The encodings are: 0b = Last page. 1b = Additional Next Pages follow.
Reserved	31:16	-	Reserved



## 14.3.82 Link Partner Ability Next Page - PCS\_LPABNP (04224h; RO)

Field	Bit(s)	Initial Value	Description
CODE	10:0	-	Message/Unformatted Code Field The Message Field is a 11-bit wide field that encodes 2048 possible messages. Unformatted Code Field is a 11-bit wide field that might contain an arbitrary value.
TOGGLE	11	-	Toggle This bit is used to ensure synchronization with the Link Partner during Next Page exchange. This bit always takes the opposite value of the <i>Toggle</i> bit in the previously exchanged Link Code Word. The initial value of the <i>Toggle</i> bit in the first Next Page transmitted is the inverse of bit 11 in the base Link Code Word and, therefore, can assume a value of 0b or 1b. The <i>Toggle</i> bit is set as follows: 0b = Previous value of the transmitted Link Code Word when 1b 1b = Previous value of the transmitted Link Code Word when 0b.
ACK2	12	-	Acknowledge 2 Used to indicate that a device has successfully received its Link Partners' Link Code Word.
MSGPG	13	-	Message Page This bit is used to differentiate a Message Page from an Unformatted Page. The encodings are: 0b = Unformatted page. 1b = Message page.
ACK	14	-	Acknowledge The Link Partner has acknowledged Next Page reception.
NXTPG	15	-	Next Page Used to indicate whether or not this is the last Next Page to be transmitted. The encodings are: 0b = Last page. 1b = Additional Next Pages follow.
Reserved	31:16	-	Reserved

## 14.4 DCA Registers

This section contains detailed descriptions for those registers associated with the 82575's DCA capabilities.

### 14.4.1 Rx DCA Control Registers - RXCTL (02814h 100h \*n [n=0..3]; R/W)

**Note:** RX data write no-snoop is activated when the NSE bit is set in the receive descriptor.

- Queue0 - RXCTL0 (02814h)
- Queue1 - RXCTL1 (02914h)
- Queue2 - RXCTL2 (02A14h)





- Queue3 - RXCTL3 (02B14h)

Field	Bit(s)	Initial Value	Description
CPUID	4:0	0h	Physical ID  In a data movement engine 1 platform, the software device driver, upon discovery of the physical CPU ID and CPU Bus ID, programs it into these bits for hardware to associate Physical CPU and Bus ID with the adequate RSS Queue. Bits 2:1 are Target Agent IDs, bit 3 is the Bus ID. Bits 2:0 are copied into bits 3:1 in the TAG field of the TLP headers of PCIe* messages.  In data movement engine 2 platforms, the software device driver programs a value, based on the relevant APIC ID, corresponding to the adequate RSS queue. This value is copied in the 4:0 bits of the <i>DCA Preferences</i> field in the TLP headers of PCIe* messages.
RX Descriptor DCA EN	5	0b	Descriptor DCA Enable  When set, hardware enables DCA for all Rx descriptors written back into memory. When cleared, hardware does not enable DCA for descriptor write-backs. This bit is cleared as a default.
Rx Header DCA EN	6	0b	Rx Header DCA Enable  When set, hardware enables DCA for all received header buffers. When cleared, hardware does not enable DCA for Rx headers. This bit is cleared as a default.
Rx Payload DCA EN	7	0b	Payload DCA Enable  When set, hardware enables DCA for all Ethernet payloads written into memory. When cleared, hardware does not enable DCA for Ethernet payloads. This bit is cleared as a default.
RXdescRead NSEn	8	0b	Rx Descriptor Read No Snoop Enable  This bit must be reset to 0b to ensure correct functionality (unless the software device driver can guarantee the data is present in the main memory before the DMA process occurs).
RXdescRead ROEn	9	0b	Rx Descriptor Read Relax Order Enable
RXdescWBNSen	10	0b	Rx Descriptor Write-Back No Snoop Enable  This bit must be reset to 0b to ensure correct functionality of descriptor write-back.
RXdescWBROen (RO)	11	0b	Rx Descriptor Write-Back Relax Order Enable  This bit must be reset to 0b to ensure correct functionality of descriptor write-back.
RXdataWrite NSEn	12	0b	Rx Data Write No Snoop Enable (header replication: header and data)  When set to 0b, the last bit of the <i>Packet Buffer Address</i> field in the advanced receive descriptor is used as the LSB of the packet buffer address (A0), thus enabling 8-bit alignment of the buffer.  When set to 1b, the last bit of the <i>Packet Buffer Address</i> field in advanced receive descriptor is used as the No-Snoop Enabling (NSE) bit (buffer is 16-bit aligned). If also set to 1b, the NSE bit determines whether the data buffer is snooped or not.
RXdataWrite ROEn	13	1b	Rx Data Write Relax Order Enable (header replication: header and data)
RxRepHeader NSEn	14	0b	Rx Replicated/Split Header No Snoop Enable  This bit must be reset to 0b to ensure correct functionality of header write to host memory.
RxRepHeader ROEn	15	1b	Rx Replicated/Split Header Relax Order Enable
Reserved	31:16	0b	Reserved



## 14.4.2 Tx DCA Control Registers - TXCTL (03814h + 100h \*n [n=0..3]; R/W)

- Queue0 - TXCTL0 (03814h)
- Queue1 - TXCTL1 (03914h)
- Queue2 - TXCTL2 (03A14h)
- Queue3 - TXCTL3 (03B14h)

Field	Bit(s)	Initial Value	Description
CPUID	4:0	0h	Physical ID  In a data movement engine 1 platform, the software device driver, upon discovery of the physical CPU ID and CPU Bus ID, programs it into these bits for hardware to associate Physical CPU and Bus ID with the adequate Tx queue. Bits 2:1 are Target Agent IDs, bit 3 is the Bus ID. Bits 2:0 are copied into bits 3:1 in the TAG field of the TLP headers of PCIe* messages.  In data movement engine 2 platforms, the software device driver programs a value, based on the relevant APIC ID, corresponding to the adequate Tx queue. This value is copied in the 4:0 bits of the <i>DCA Preferences</i> field in the TLP headers of PCIe* messages.
TX Descriptor DCA EN	5	0b	Descriptor DCA Enable  When set, hardware enables DCA for all Tx descriptors written back into memory. When cleared, hardware does not enable DCA for descriptor write-backs. This bit is cleared as a default and also applies to head write-back when enabled.
Reserved	7:6	00b	Reserved
TXdescRDNSen	8	0b	Tx Descriptor Read No Snoop Enable  This bit must be reset to 0b to ensure correct functionality (unless the software device driver has written this bit with a write-through instruction).
TXdescRDROEn	9	1b	Tx Descriptor Read Relax Order Enable
TXdescWBNSen	10	0b	Tx Descriptor Write-Back No Snoop Enable  This bit must be reset to 0b to ensure correct functionality of descriptor write-back. Also applies to head write-back, when enabled.
RXdescWBROEn	11	0b	Tx Descriptor Write-Back Relax Order Enable  Applies to head write-back, when enabled.
TXDataRead NSEn	12	0b	Tx Data Read No Snoop Enable
TXDataRead ROEn	13	1b	Tx Data Read Relax Order Enable
Reserved	31:14	-	Reserved

## 14.5 Filter Registers

This section contains detailed descriptions for those registers associated with the 82575's address filter capabilities.



## 14.5.1 Multicast Table Array - MTA (05200h + 4\*n [n..127]; R/W)

There is one register per 32 bits of the Multicast Address Table for a total of 128 registers (the MTA[127:0] designation). Software must mask to the desired bit on reads and supply a 32-bit word on writes. The first bit of the address used to access the table is set according to the RX\_CTRL.MO field.

**Note:** All accesses to this table must be 32 bit.

Field	Bit(s)	Initial Value	Description
Bit Vector	31:0	X	Word wide bit vector specifying 32 bits in the multicast address filter table.

Figure 33 shows the multicast lookup algorithm. The destination address shown represents the internally stored ordering of the received DA. Note that bit 0 indicated in this diagram is the first on the wire.

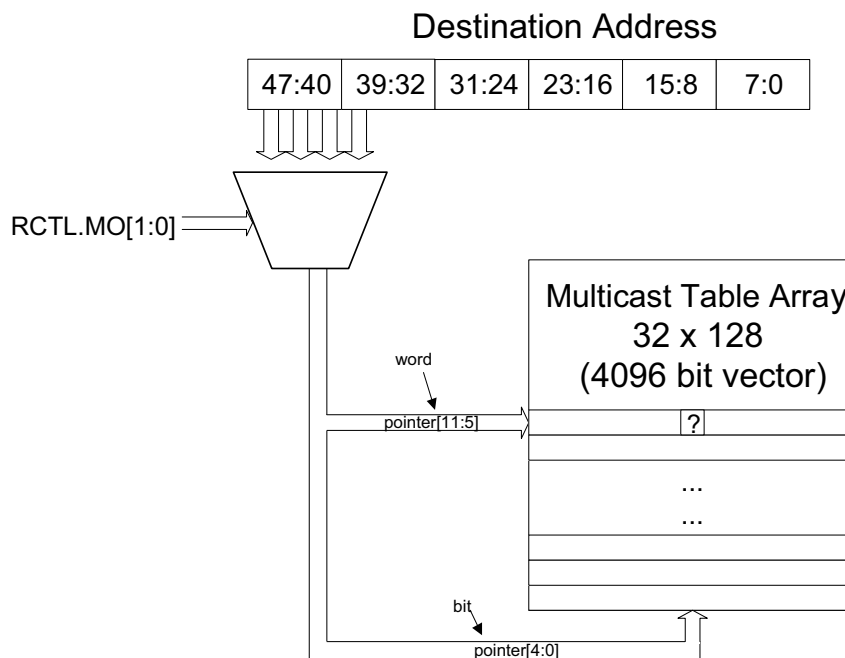

Figure 33. Multicast Table Array



## 14.5.2 Receive Address Low - RAL (05400h + 8\*n [n=0..15]; R/W)

**Note:** "n" is the exact unicast/multicast address entry and it is equals to 0,1,...15.

These registers contain the lower bits of the 48 bit Ethernet address. All 32 bits are valid.

These registers are reset by a software reset or platform reset. If an EEPROM is present, the first register (RAL0) is loaded from the EEPROM after a software or platform reset.

**Note:** The *RAL* field should be written in network order.

Field	Bit(s)	Initial Value	Description
RAL	31:0	X	Receive address low Contains the lower 32-bit of the 48-bit Ethernet address.

## 14.5.3 Receive Address High - RAH (05404h + 8\*n [n=0..15]; R/W)

"n" is the exact unicast/multicast address entry and it is equals to 0,1,...15.

These registers contain the upper bits of the 48 bit Ethernet address. The complete address is [RAH, RAL]. AV determines whether this address is compared against the incoming packet and is cleared by a master reset.

ASEL enables the 82575 to perform special filtering on receive packets.

After reset, if an EEPROM is present, the first register (Receive Address Register 0) is loaded from the *IA* field in the EEPROM with its *Address Select* field set to 00b and its *Address Valid* field set to 1b. If no EEPROM is present, the *Address Valid* field is set to 0b and the *Address Valid* field for all of the other registers is set to 0b.

**Note:** The *RAH* field should be written in network order.

The first receive address register (RAH0) is also used for exact match pause frame checking (DA matches the first register). As a result, RAH0 should always be used to store the individual Ethernet MAC address of the 82575.



Field	Bit(s)	Initial Value	Description
RAH	15:0	X	Receive address High Contains the upper 16 bits of the 48-bit Ethernet address.
ASEL	17:16	X	Address Select Selects how the address is to be used in the address filtering. 00b = Destination address (required for normal mode) 01b = Source address 10b = Reserved 11b = Reserved
QSEL	19:18	00b	Queue Select Association through MAC address - selects one of the four receive queues for packets matching this destination address. 00b = Queue 0 01b = Queue 1 10b = Queue 2 11b = Queue 3 Association through MAC address + RSS - serves as a pool bit, identifying the target pool: QSEL[19] = 0b - pool 0 QSEL[19] = 1b - pool 1
Reserved	30:20	0b	Reserved Reads as 0b. Ignored on writes.
AV	31		Address Valid Cleared after master reset. If an EEPROM is present, the <i>Address Valid</i> field of the Receive Address Register 0 is set to 1b after a software or PCI reset or EEPROM read. In entries 0-15 this bit is cleared by master reset.

## 14.5.4 VLAN Filter Table Array - VFTA (05600h + 4\*n [n=0..127]; R/W)

There is one register per 32 bits of the VLAN Filter Table. The size of the word array depends on the number of bits implemented in the VLAN Filter Table. Software must mask to the desired bit on reads and supply a 32-bit word on writes.

**Note:** All accesses to this table must be 32 bit.

The algorithm for VLAN filtering using the VFTA is identical to that used for the Multicast Table Array. Refer to [Section 14.5.1](#) for a block diagram of the algorithm. If VLANs are not used, there is no need to initialize the VFTA.

Field	Bit(s)	Initial Value	Description
Bit Vector	31:0	X	Double-word wide bit vector specifying 32 bits in the VLAN Filter table.



## 14.5.5 Multiple Receive Queues Command Register - MRQC (05818h; R/W)

Field	Bit(s)	Initial Value	Description
MRQE	2:0	00h	<p>Multiple Receive Queues Enable</p> <p>Enables support for Multiple Receive Queues and defines the mechanism that controls queue allocation. Note that the <i>RXCSUM.PCSD</i> bit must also be set to enable Multiple Receive Queues.</p> <p>000b = Multiple Receive Queues are disabled.</p> <p>001b = Reserved.</p> <p>010b = Multiple receive queues as defined by RSS for four queues.</p> <p>011b = Multiple receive queues as defined by VMDq based on packet destination MAC address.</p> <p>100b = Multiple receive queues as defined by VMDq based on packet VLAN tag ID.</p> <p>101b = Multiple receive queues as defined by VMDq based on packet destination MAC address and RSS.</p> <p>110b = Multiple receive queues as defined by VMDq based on packet VLAN tag ID and RSS.</p> <p>111b = Reserved.</p> <p>In SKUs not supporting VT, The only functional values for this field are 000b and 010b. Writing any other value is treated as if a value of zero was written. A value other than zero might cause unexpected results.</p> <p><b>Note:</b> When RSS is enabled (MRQC.MRQE equals 010b, 101b or 110b), TCP Rx checksum must also be enabled (RXCSUM.TUOFL = 1b).</p>
RSS Interrupt Enable	2	0h	<p>RSS Interrupt Enable</p> <p>When set, this bit enables interrupt control by the RSS Interrupt Mask register. When cleared, a receive packet generates an interrupt indication independent of the RSS Interrupt registers.</p>
Reserved	15:3	0h	Reserved.
RSS Field Enable	31:16	0h	<p>Each bit, when set, enables a specific field selection to be used by the hash function. Several bits can be set at the same time.</p> <p>Bit[16] = Enable TcpIPv4 hash function</p> <p>Bit[17] = Enable IPv4 hash function</p> <p>Bit[18] = Enable TcpIPv6Ex hash function</p> <p>Bit[19] = Enable IPv6Ex hash function</p> <p>Bit[20] = Enable IPv6 hash function</p> <p>Bit[21] = Enable TCPIPv6 has function</p> <p>Bit[22] = Enable UDPIPV4</p> <p>Bit[23] = Enable UDPIPV6</p> <p>Bit[24] = Enable UDPIPV6Ext</p> <p>Bits[31:25] = Reserved; set to 0b.</p>

**Notes:**

1. MRQC\_EN is used for enable/disable RSS hashing and also for enabling multiple receive queues. Disabling this feature is not recommended. Model usage is to reset the 82575 after disabling the RSS.
2. Packet would be tagged as IPv6 if it is without any of the Home-Address-Option field and Routing-Header-Type-2 field. As a result, if a packet is tagged with IPv6 (type 5) in this case, the device driver would have to convert it to IPv6Ex (type 4).



## 14.5.6 Redirection Table - RETA (05C00h + 4\*n [n=0..31]; R/W)

The redirection table is a 128-entry table with each entry being eight bits wide. Only seven bits of each entry are used to store the tag value (five bits for the CPU index and two bits for queue index). The table is configured through the following R/W registers.

DW	31	24	23	16	15	8	7	0
0	Tag 3		Tag 2		Tag 1		Tag 0	
1					...		...	
...								
DW	31	24	23	16	15	8	7	0
30								
31	Tag 127		...		...		...	

Field	Bit(s)	Initial Value	Description
Entry 0	7:0	X	Determines the tag value and physical queue for index 4*n + 0 (n=0..31).
Entry 1	15:8	X	Determines the tag value and physical queue for index 4*n + 1 (n=0..31).
Entry 2	23:16	X	Determines the tag value and physical queue for index 4*n + 2 (n=0..31).
Entry 3	31:24	X	Determines the tag value and physical queue for index 4*n + 3 (n=0..31).

Each entry (byte) of the indirection table contains the following information.

7:6	5:4	3:2	1:0
Queue index pool 1 (default)	Reserved	Queue index pool 0	Reserved

- Bits 7:6 - Queue index pool 1 or regular RSS.
- Bits 5:4 - Reserved
- Bits 3:2 - Queue index pool 0 (relevant only if MRQC.MRQE = 101b or 110b)
- Bits 1:0 - Reserved

The contents of the indirection table are not defined following reset of the Memory Configuration registers. System software must initialize the table prior to enabling multiple receive queues. It might also update the indirection table during run time. Such updates of the table are not synchronized with the arrival time of received packets. Therefore, it is not guaranteed that a table update takes effect on a specific packet boundary.

**Note:** If the operating system provides an indirection table whose size is smaller than 128 bytes, software usually replicates the operating system-provided indirection table to span the whole 128 bytes of the hardware's indirection table



## 14.5.7 RSS Random Key Register - RSSRK (05C80h + 4\*n [n=0..9]; R/W)

The RSS Random Key register stores a 40 byte key used by the RSS hash function.

DW	31	24	23	16	15	8	7	0
0	K[3]			K[2]		K[1]		K[0]
1								...

...

DW	31	24	23	16	15	8	7	0
6								
7	K[39}			...		...		K[36]

Field	Bit(s)	Initial Value	Description
K0	7:0	00h	Byte n*4 of the RSS random key (n=0,1,...9).
K1	15:8	00h	Byte n*4+1 of the RSS random key (n=0,1,...9).
K2	23:16	00h	Byte n*4+2 of the RSS random key (n=0,1,...9).
K3	31:24	00h	Byte n*4+3 of the RSS random key (n=0,1,...9).

## 14.5.8 VMDq Control - VMD\_CTRL (0581Ch; R/W)

Field	Bit(s)	Initial Value	Description
Default VMDq Queue #0	1:0	00b	Determines the target queue for received packets that cannot be classified by the VMDq procedures (for example, broadcast packets) or packets allocated to pool 0 that cannot be decoded by RSS. Operates differently in each mode: Association through MAC address - defines default queue number. Association through MAC address + RSS - Defines the default queue for packets allocated to pool 0.
Reserved	6:2	0h	Reserved
Default VMDq Queue #1	8:7	00b	Determines the target queue for received packets that cannot be classified by the VMDq procedures (for example, broadcast packets) or packets allocated to pool 1 that cannot be decoded by RSS. Operates differently in each mode: Association through MAC address - reserved. Association through MAC address + RSS - defines the default queue for packets allocated to pool 1.
Reserved	30:9	0h	Reserved
Default Pool	31	0b	Determines the target pool for received packets that cannot be classified by the VMDq procedures (for example, broadcast packets). Operates differently in each mode: Association through MAC address - reserved Association through MAC address + RSS - defines the default pool for packets that cannot be allocated to any pool.





## 14.5.9 VLAN Filter Queue Array 0 - VFQA0 (0B100h + 4\*n [n=0...127]; R/W)

This register set classifies receive packets into Rx queues in some schemes for multiple queues. There is one register per 32 bits of the VLAN Filter Queue Array 0. The VLAN Filter Queue Array 0, together with the VLAN Filter Queue Array 1, determines the receive queue for received VLAN packets.

- All accesses to this table must be 32 bit.

Field	Bit(s)	Initial Value	Description
Bit Vector	31:0	0h	Double word wide bit vector specifying 32 bits in the VLAN filter queue array 0.

## 14.5.10 VLAN Filter Queue Array 1 - VFQA1 (0B200h + 4\*n [n=0...127]; R/W)

This register set classifies receive packets into Rx queues in some schemes for multiple queues. There is one register per 32 bits of the VLAN Filter Queue Array 1. The VLAN Filter Queue Array 1, together with the VLAN Filter Queue Array 0, determines the receive queue for received VLAN packets. VLAN Filter Queue Array 1 can alternatively serve as a pool bit in some of the classification schemes.

**Note:** All accesses to this table must be 32 bit.

Field	Bit(s)	Initial Value	Description
Bit Vector	31:0	0h	Double word wide bit vector specifying 32 bits in the VLAN filter queue array 1.

## 14.6 Wakeup Registers

This section contains detailed descriptions for those registers associated with the 82575's wakeup capabilities.

### 14.6.1 Wakeup Control Register - WUC (05800h; R/W)

The PME\_En and PME\_Status bits of this register are reset when Internal\_Power\_On\_Reset is 0b. When AUX\_PWR = 0b, this register is also reset by de-asserting PE\_RST\_N and when transitioning from D3 to D0. The other bits are reset using the standard internal resets.



Field	Bit(s)	Initial Value	Description
APME	0	0b <sup>1</sup>	Advance Power Management Enable If set to 1b, APM Wakeup is enabled.  If this bit is set and the <i>APMPME</i> bit is cleared, reception of a magic packet asserts the <i>WUS.MAG</i> bit but does not assert a PME.
PME_En	1	0b	PME_En  This read/write bit is used by the software device driver to access the PME_En bit of the Power Management Control / Status Register (PMCSR) without writing to the PCIe* configuration space.
PME_Status	2	0b	PME_Status  This bit is set when the 82575 receives a wakeup event. It is the same as the PME_Status bit in the Power Management Control / Status Register (PMCSR). Writing a 1b to this bit clears the PME_Status bit in the PMCSR.
APMPME	3	0b <sup>1</sup>	Assert PME On APM Wakeup  If set to 1b, the 82575 sets the PME_Status bit in the Power Management Control / Status Register (PMCSR) and asserts PME# when APM Wakeup is enabled and the 82575 receives a matching Magic Packet.
Reserved	31:4	0h	Reserved

1. Loaded from the EEPROM.

## 14.6.2 Wakeup Filter Control Register - WUFC (05808h; R/W)

This register is used to enable each of the pre-defined and flexible filters for wakeup support. A value of 1b means the filter is turned on.; A value of 0b means the filter is turned off.

If the NoTCO bit is set, then any packet that passes the manageability packet filtering described in the Total Cost of Ownership (TCO) System Management Bus Interface Application Note does not cause a Wake Up event even if it passes one of the Wake Up Filters. This bit is set at initialization and during any EEPROM read if the SMBus Enable bit of the EEPROM's Management Control word is 1b. Otherwise its initial value is 0b.

Field	Bit(s)	Initial Value	Description
LNKC	0	0b	Link Status Change Wakeup Enable.
MAG	1	0b	Magic Packet Wakeup Enable.
EX	2	0b	Directed Exact Wakeup Enable.
MC	3	0b	Directed Multicast Wakeup Enable.
BC	4	0b	Broadcast Wakeup Enable.
ARP	5	0b	ARP Request Packet Wakeup Enable.
IPv4	6	0b	Directed IPv4 Packet Wakeup Enable.
IPv6	7	0b	Directed IPv6 Packet Wakeup Enable.
Reserved	14:8	0b	Reserved. Set these bits to 0b.
NoTCO	15	0	Ignore TCO/management packets for wakeup.
FLX0	16	0b	Flexible Filter 0 Enable.
FLX1	17	0b	Flexible Filter 1 Enable.



Field	Bit(s)	Initial Value	Description
FLX2	18	0b	Flexible Filter 2 Enable.
FLX3	19	0b	Flexible Filter 3 Enable.
Reserved	31:20	0h	Reserved.

### 14.6.3 Wakeup Status Register - WUS (05810h; R/W1C)

This register is used to record statistics about all wakeup packets received. If a packet matches multiple criteria then multiple bits could be set. Writing a 1b to any bit clears that bit.

This register is not cleared when RST# is asserted. It is only cleared when Internal\_Power\_On\_Reset is de-asserted or when cleared by the software device driver.

**Note:** If additional packets are received that matches one of the wakeup filters, after the original wakeup packet is received, the WUS register is updated with the matching filters accordingly.

Field	Bit(s)	Initial Value	Description
LNKC	0	0b	Link Status Change.
MAG	1	0b	Magic Packet Received.
EX	2	0b	Directed Exact Packet Received The packet's address matched one of the 16 pre-programmed exact values in the Receive Address registers.
MC	3	0b	Directed Multicast Packet Received The packet was a multicast packet hashed to a value that corresponded to a 1 bit in the Multicast Table Array.
BC	4	0b	Broadcast Packet Received.
ARP	5	0b	ARP Request Packet Received.
IPv4	6	0b	Directed IPv4 Packet Received.
IPv6	7	0b	Directed IPv6 Packet Received.
MNG	8	0b	Indicates that a manageability event that should cause a PME happened.
Reserved	15:9	0b	Reserved.
FLX0	16	0b	Flexible Filter 0 Match.
FLX1	17	0b	Flexible Filter 1 Match.
FLX2	18	0b	Flexible Filter 2 Match.
FLX3	19	0b	Flexible Filter 3 Match.
Reserved	31:20	0b	Reserved.

### 14.6.4 IP Address Valid - IPAV (5838h; R/W)

The IP Address Valid indicates whether the IP addresses in the IP Address Table are valid.

Field	Bit(s)	Initial Value	Description
V40	0	0b	IPv4 Address 0 Valid.
V41	1	0b	IPv4 Address 1 Valid.



V42	2	0b	IPv4 Address 2 Valid.
V43	3	0b	IPv4 Address 3 Valid.
Reserved	15:4	0h	Reserved.
V60	16	0b	IPv6 Address 0 Valid.
Reserved	31:17	0b	Reserved.

### 14.6.5 IPv4 Address Table - IP4AT (05840h + 8\*n [n=0..3]; R/W)

The IPv4 Address Table is used to store the four IPv4 addresses for the ARP/IPv4 Request packet and Directed IP packet wakeup.

**Note:** This table is not cleared by any reset.

DWORD#	Address	31 0
0	5840h	IPV4ADDR0
2	5848h	IPV4ADDR1
3	5850h	IPV4ADDR2
4	5858h	IPV4ADDR3

Field	Dword #	Address	Bit(s)	Initial Value	Description
IPV4ADDR0	0	5840h	31:0	X	IPv4 Address 0
IPV4ADDR1	2	5848h	31:0	X	IPv4 Address 1
IPV4ADDR2	4	5850h	31:0	X	IPv4 Address 2
IPV4ADDR3	6	5858h	31:0	X	IPv4 Address 3

### 14.6.6 IPv6 Address Table - IP6AT (05880h + 4\*n[n=0..3]; R/W)

The IPv6 Address Table is used to store the IPv6 addresses for Neighbor Discovery packet filtering and Directed IP packet wakeup.

**Note:** This table is not cleared by any reset.

DWORD#	Address	31 0
0	5880h	IPV6ADDR0
1	5884h	
2	5888h	
3	588Ch	



Field	Dword #	Address	Bit(s)	Initial Value	Description
IPV6ADDR0	0	5880h	31:0	X	IPv6 Address 0, bytes 1-4
	1	5884h	31:0	X	IPv6 Address 0, bytes 5-8
	2	5888h	31:0	X	IPv6 Address 0, bytes 9-12
	3	588Ch	31:0	X	IPv6 Address 0, bytes 16-13

### 14.6.7 Wakeup Packet Length - WUPL (05900h; RC)

This register indicates the length of the first wakeup packet received. It is valid if one of the bits in the Wakeup Status register (WUS) is set. It is not cleared by any reset.

Field	Bit(s)	Initial Value	Description
LEN	11:0	X	Length of wakeup packet. (If jumbo frames is enabled and the packet is longer than 2047 bytes then this field is 2047.)
Reserved	31:12	0h	Reserved

### 14.6.8 Wakeup Packet Memory (128 Bytes) - WUPM (05A00h + 4\*n [n=0..31]; RC)

This register is read-only and it is used to store the first 128 bytes of the wakeup packet for software retrieval after system wakeup. It is not cleared by any reset.

Field	Bit(s)	Initial Value	Description
WUPD	31:0	X	Wakeup Packet Data

### 14.6.9 Flexible Filter Mask Table - FFMT (09000h + 8\*n [n=0..127]; R/W)

The Flexible Filter Mask and Table is used to store the four 1-bit masks for each of the first 128 data bytes in a packet, one for each Flexible Filter. If the mask bit is set to 1b, the corresponding Flexible Filter compares the incoming data byte at the index of the mask bit to the data byte stored in the Flexible Filter Value Table.

Before writing to the Flexible Filter Mask Table the driver must first disable the flexible filters by writing 0b's to the Flexible Filter Enable bits of the Wakeup Filter Control Register (WUFC.FLXn).

**31 0**

Reserved
Reserved
Reserved
Reserved
Reserved

<b>31 4</b>	<b>3 0</b>
Reserved	Byte 0 Mask
Reserved	Byte 1 Mask
Reserved	Byte 2 Mask
Reserved	Byte 126 Mask
Reserved	Byte 127 Mask



Field	Dword #	Address	Bit(s)	Initial Value	Description
MASK0	0	9000h	7:0	X	Mask for Filter [3:0] for Byte 0
MASK1	2	9008h	7:0	X	Mask for Filter [3:0] for Byte 2
MASK2	4	9010h	7:0	X	Mask for Filter [3:0] for Byte 3
...					
MASK127	254	93F8h	7:0	X	Mask for Filter [3:0] for Byte 127

### 14.6.10 Flexible Filter Value Table - FFVT (09800h + 8\*n [n=0..127]; R/W)

The Flexible Filter Value and Table is used to store the one value for each byte location in a packet for each flexible filter. If the corresponding mask bit is set to 1b, the Flexible Filter compares the incoming data byte to the values stored in this table.

Before writing to the Flexible Filter Value Table the driver must first disable the flexible filters by writing 0b's to the Flexible Filter Enable bits of the Wakeup Filter Control Register (WUFC.FLXn).

31 0	31 24	23 16	15 8	7 0
Reserved	Byte0: Value3	Value2	Value1	Value0
Reserved	Byte1: Value3	Value2	Value1	Value0
Reserved	Byte2: Value3	Value2	Value1	Value0
Reserved	Byte127: Value3	Value2	Value1	Value0

Field	Dword #	Address	Bit(s)	Initial Value	Description
MASK0	0	9800h	15:0	X	Mask for Filter [3:0] for Byte 0
MASK1	2	9808h	15:0	X	Mask for Filter [3:0] for Byte 2
MASK2	4	9810h	15:0	X	Mask for Filter [3:0] for Byte 3
...					
MASK127	254	9BF8h	15:0	X	Mask for Filter [3:0] for Byte 127

### 14.6.11 Flexible Filter Length Table - FFLT (05F00h + 8\*n [n=0..3]; R/W)

The flexible filter length table stores the minimum packet lengths required to pass each of the flexible filters. Any packets that are shorter than the programmed length do not pass that filter. Each flexible filter considers a packet that doesn't have any mismatches up to that point to have passed the flexible filter when it reaches the required length. It does not check any bytes past that point.



31	0	31	11	10	0
Reserved		Reserved		Reserved	
Reserved		Reserved		Length 0	
Reserved		Reserved		Length 1	
Reserved		Reserved		Length 2	
Reserved		Reserved		Length 3	

Field	Bits	Initial Value	Description
LEN	10:0	0b	Minimum length for flexible filter i (i=0..3)
Reserved	11:31	0b	Reserved

All reserved fields read as 0's and ignore writes.

**Note:** Before writing to the flexible filter length table the software device driver must first disable the flexible filters by writing 0's to the *Flexible Filter Enable* bits of the Wake Up Filter Control (WUFC.FLXn) register.

Flexible filter cannot operate with a 1-byte pattern. Filters operate properly with all other allowed pattern length (2-7FFh).

## 14.7 Manageability Registers

All management registers are controlled by the BMC for both read and write. Host accesses to the management registers are blocked (read and write) unless debug write is enabled. The attributes for the fields in this section refer to the BMC access rights.

### 14.7.1 Management VLAN TAG Value - MAVTV (5010h + 4\*n [n=0..7]; R/W)

Where "n" is the VLAN filter serial number, equal to 0,1,...7.

Field	Bits	Initial Value	Description
VID	11:0	00h	Contains the VLAN ID that should be compared with the incoming packet if the corresponding bit in MFVAL.VLAN is set.
Rsv	31:12	00h	Reserved.

The MAVTV registers are written by the BMC and are not accessible to the host for writing. The registers are used to filter manageability packets as described in the *Intel® 82575 GbE Controller System Manageability Interface Application Note*.



## 14.7.2 Management Flex UDP/TCP Ports - MFUTP (5030h + 4\*n [n=0..7]; R/W)

Where each 32-bit register (n=0,...,7) refers to two port filters (register 0 refers to ports 0 and 1, register 2 refers to ports 2 and 3, etc.).

Field	Bits	Initial Value	Description
MFUTP_even	15:0	0b	i Management flex UDP/TCP port.
MFUTP_odd	31:16	0b	i + 1 Management flex UDP/TCP port.

The MFUTP registers are written by the BMC and not accessible to the host for writing. The registers are used to filter manageability packets as described the *Intel® 82575 GbE Controller System Manageability Interface Application Note*.

Reset - The MFUTP registers are cleared on Internal\_Power\_On\_Reset only. The initial values for this register can be loaded from the EEPROM after a power-on reset.

**Note:** The MFUTP\_even and MFUTP\_odd fields should be written in network order.

## 14.7.3 Management Control Register - MANC (05820h; R/W)

The MANC register is written by the BMC and is not accessible to the host for writing.

Field	Bits	Initial Value	Description
Reserved	15:0	0b	Reserved.
TCO_RESET	16	0b	TCO Reset Occurred Set to 1b on a TCO reset. This bit is only reset by an Internal_Power_On_Reset.
RCV_TCO_EN	17	0b	Receive TCO Packets Enabled When this bit is set, it enables the receive flow from the wire to the manageability block.
KEEP_PHY_LINK_UP	18	0b	Block PHY Reset and Power State Changes When this bit is set, the PHY reset and power state changes do not get to the PHY. This bit cannot be written unless the <i>Keep_PHY_Link_Up_En</i> EEPROM bit is set. This bit is reset after an Internal_Power_On_Reset.
RCV_ALL	19	0b	Receive All Enable When set, all received packets that passed L2 filtering are directed to the manageability block.
MCST_PASS_L2	20	0b	Receive All Multicast When set, all received multicast packets pass L2 filtering and can be directed to the manageability block by one of the decision filters. Broadcast packets are not forwarded by this bit.
EN_MNG2HOST	21	0b	Enable MNG Packets to Host Memory This bit enables the functionality of the MANC2H register. When set, the packets that are specified in the MANC2H register are also sent to host memory as long as they pass the manageability filters.





Reserved	22	0b	Reserved.
EN_XSUM_FILTER	23	0b	Enable Xsum Filtering to Manageability When set, only packets that pass L3 and L4 checksums are sent to the manageability block. Hardware does not calculate the checksum of packets whose L2 + L3 header is bigger than 256 bytes. The BMC should take care of the checksum check of such packets.
EN_IPv4_FILTER	24	0b	Enable IPv4 address Filters When set, the last 128 bits of the MIPAF register are used to store four IPv4 addresses for IPv4 filtering. When cleared, these bits store a single IPv6 filter.
FIXED_NET_TYPE	25	0b	Fixed Next Type If set, only packets matching the net type defined by the NET_TYPE field pass to manageability. Otherwise, both tagged and un-tagged packet can be forwarded to manageability engine.
NET_TYPE	26	0b	Net Type 0b = Pass only un-tagged packets. 1b = Pass only VLAN tagged packets. Valid only if FIXED_NET_TYPE is set.
Reserved	31:27	00h	Reserved.

## 14.7.4 Manageability Filters Valid - MFVAL (5824h; R/W)

The manageability filters valid registers indicate which filter registers contain a valid entry.

Field	Bits	Initial Value	Description
MAC	3:0	00h <sup>1</sup>	MAC Indicates that if the MAC unicast filter registers (MMAH, MMAL) contain valid MAC addresses. Bit 0 corresponds to filter 0, etc.
Reserved	7:4	00h <sup>1</sup>	Reserved.
VLAN	15:8	00h <sup>1</sup>	VLAN Indicates that if the VLAN filter registers (MAVTV) contain valid VLAN tags. Bit 8 corresponds to filter 0, etc.
IPv4	19:16	00h <sup>1</sup>	IPv4 Indicates that if the IPv4 address filters (MIPAF) contain valid IPv4 addresses. Bit 16 corresponds to IPv4 address 0. These bits apply only when IPv4 address filters are enabled (MANC.EN_IPv4_FILTER=1b)
Reserved	23:20	00h <sup>1</sup>	Reserved.
IPv6	27:24	00h <sup>1</sup>	IPv6 Indicates that if the IPv6 address filter registers (MIPAF) contain valid IPv6 addresses. Bit 24 corresponds to address 0, etc. Bit 27 (filter 3) applies only when the IPv4 address filters are not enabled (MANC.EN_IPv4_FILTER=0b).
Reserved	31:28	00h <sup>1</sup>	Reserved.

1. Loaded from the EEPROM.

Reset - The MFVAL register is cleared on an Internal\_Power\_On\_Reset and firmware reset.

The initial values for this register can be loaded from the EEPROM after an Internal\_Power\_On\_Reset or firmware reset. The MFVAL register is written by the BMC and is not accessible to the host for writing.



## 14.7.5 Management Control to Host Register - MANC2H (5860h; R/W)

The MANC2H register enables the routing of manageability packets to the host based on the decision filter that routed it to the manageability micro-controller. Each manageability decision filter (MDEF) has a corresponding bit in the MANC2H register. When a manageability decision filter (MDEF) routes a packet to manageability, it also routes the packet to the host if the corresponding MANC2HOST bit is set and if the *EN\_MNG2HOST* bit is set. The *EN\_MNG2HOST* bit serves as a global enable for the MANC2H bits.

Field	Bits	Initial Value	Description
Host Enable	7:0	00h <sup>1</sup>	Host Enable When set, indicates that packets routed by the manageability filters to the manageability system are also sent to the host. Bit 0 corresponds to decision rule 0, etc.
Reserved	31:8	00h <sup>1</sup>	Reserved

1. Loaded from the EEPROM.

**Reset** - The MANC2H register is cleared on an *Internal\_Power\_On\_Reset* and a firmware reset. The initial values for this register can be loaded from the EEPROM after an *Internal Power On Rest* or firmware reset.

## 14.7.6 Manageability Decision Filters- MDEF (5890h + 4\*n [n=0..7]; R/W)

Where "n" is the decision filter.

Field	Bits	Initial Value	Description
Unicast AND	0	0b <sup>1</sup>	Unicast Controls the inclusion of unicast address filtering in the manageability filter decision (AND section).
Broadcast AND	1	0b <sup>1</sup>	Broadcast Controls the inclusion of broadcast address filtering in the manageability filter decision (AND section).
VLAN AND	2	0b <sup>1</sup>	VLAN Controls the inclusion of VLAN address filtering in the manageability filter decision (AND section).
IP Address	3	0b <sup>1</sup>	IP Address Controls the inclusion of IP address filtering in the manageability filter decision (AND section).
Unicast OR	4	0b <sup>1</sup>	Unicast Controls the inclusion of unicast address filtering in the manageability filter decision (OR section).
Broadcast OR	5	0b <sup>1</sup>	Broadcast Controls the inclusion of broadcast address filtering in the manageability filter decision (OR section).



Multicast AND	6	0b <sup>1</sup>	Multicast Controls the inclusion of Multicast address filtering in the manageability filter decision (AND section). Broadcast packets are not included by this bit. The packet must pass some L2 filtering to be included by this bit – either by the MANC.MCST_PASS_L2 or by some dedicated MAC address.
ARP Request	7	0b <sup>1</sup>	ARP Request Controls the inclusion of ARP Request filtering in the manageability filter decision (OR section).
ARP Response	8	0b <sup>1</sup>	ARP Response Controls the inclusion of ARP Response filtering in the manageability filter decision (OR section).
Neighbor Discovery	9	0b <sup>1</sup>	Neighbor Discovery Controls the inclusion of Neighbor Discovery filtering in the manageability filter decision (OR section). The neighbor types accepted by this filter are types 86h, 87h, 88h & 89h
Port 0x298	10	0b <sup>1</sup>	Port 0x298 Controls the inclusion of Port 0x298 filtering in the manageability filter decision (OR section).
Port 0x26F	11	0b <sup>1</sup>	Port 0x26F Controls the inclusion of Port 0x26F filtering in the manageability filter decision (OR section).
Flex port	27:12	00h <sup>1</sup>	Flex port Controls the inclusion of Flex port filtering in the manageability filter decision (OR section). Bit 12 corresponds to flex port 0, etc.
Flex TCO	31:28	00h <sup>1</sup>	Flex TCO Controls the inclusion of Flex TCO filtering in the manageability filter decision (OR section). Bit 28 corresponds to Flex TCO filter 0, etc.

1. Loaded from the EEPROM.

## 14.7.7 Manageability IP Address Filter - MIPAF (0x58B0-0x58EC; RW)

The Manageability IP Address Filter register stores IP addresses for manageability filtering. The MIPAF register can be used in two configurations, depending on the value of the MANC. EN\_IPv4\_FILTER bit:

- EN\_IPv4\_FILTER = 0b: the last 128 bits of the register store a single IPv6 address (IPV6ADDR3)
- EN\_IPv4\_FILTER = 1b: the last 128 bits of the register store four IPv4 addresses (IPV4ADDR[3:0])

The initial values for these registers can be loaded from the EEPROM after power-up reset. The registers are written by the BMC and not accessible to the host for writing.

Reset - The registers are cleared on Internal\_Power\_On\_Reset only.

The MIPAF registers value should be configured to the register in host order.

EN\_IPv4\_FILTER = 0b:

DWORD#	Address	31	0
0	58B0h	IPV6ADDR0	
1	58B4h		
2	58B8h		
3	58BCh		



4	58C0h	IPV6ADDR1
5	58C4h	
6	58C8h	
7	58CCh	
8	58D0h	IPV6ADDR2
9	58D4h	
10	58D8h	
11	58DCh	
12	58E0h	IPV6ADDR3
13	58E4h	
14	58E8h	
15	58ECh	

Field	Dword #	Address	Bit(s)	Initial Value	Description
IPV6ADDR0	0	58B0h	31:0	X	IPv6 Address 0, bytes 1-4 (least significant byte is first on the wire)
	1	58B4h	31:0	X	IPv6 Address 0, bytes 5-8
	2	58B8h	31:0	X	IPv6 Address 0, bytes 9-12
	3	58BCh	31:0	X	IPv6 Address 0, bytes 16-13
IPV6ADDR1	0	58C0h	31:0	X	IPv6 Address 1, bytes 1-4 (least significant byte is first on the wire)
	1	58C4h	31:0	X	IPv6 Address 1, bytes 5-8
	2	58C8h	31:0	X	IPv6 Address 1, bytes 9-12
	3	58CCh	31:0	X	IPv6 Address 1, bytes 16-13
IPV6ADDR2	0	58D0h	31:0	X	IPv6 Address 2, bytes 1-4 (least significant byte is first on the wire)
	1	58D4h	31:0	X	IPv6 Address 2, bytes 5-8
	2	58D8h	31:0	X	IPv6 Address 2, bytes 9-12
	3	58DCh	31:0	X	IPv6 Address 2, bytes 16-13
IPV6ADDR3	0	58E0h	31:0	X	IPv6 Address 3, bytes 1-4 (least significant byte is first on the wire)
	1	58E4h	31:0	X	IPv6 Address 3, bytes 5-8
	2	58E8h	31:0	X	IPv6 Address 3, bytes 9-12
	3	58ECh	31:0	X	IPv6 Address 3, bytes 16-13

EN\_IPv4\_FILTER = 1b:

DWORD#	Address	31	0
0	58B0h	IPV6ADDR0	
1	58B4h		
2	58B8h		
3	58BCh		
4	58C0h	IPV6ADDR1	
5	58C4h		
6	58C8h		



7	58CCh	IPV6ADDR2
8	58D0h	
9	58D4h	
10	58D8h	
11	58DCh	IPV4ADDR0
12	58E0h	
13	58E4h	
14	58E8h	
15	58ECh	IPV4ADDR3

Field	Dword #	Address	Bit(s)	Initial Value	Description
IPV6ADDR0	0	58B0h	31:0	X	IPv6 Address 0, bytes 1-4 (least significant byte is first on the wire)
	1	58B4h	31:0	X	IPv6 Address 0, bytes 5-8
	2	58B8h	31:0	X	IPv6 Address 0, bytes 9-12
	3	58BCh	31:0	X	IPv6 Address 0, bytes 16-13
IPV6ADDR1	0	58C0h	31:0	X	IPv6 Address 1, bytes 1-4 (least significant byte is first on the wire)
	1	58C4h	31:0	X	IPv6 Address 1, bytes 5-8
	2	58C8h	31:0	X	IPv6 Address 1, bytes 9-12
	3	58CCh	31:0	X	IPv6 Address 1, bytes 16-13
IPV6ADDR2	0	58D0h	31:0	X	IPv6 Address 2, bytes 1-4 (least significant byte is first on the wire)
	1	58D4h	31:0	X	IPv6 Address 2, bytes 5-8
	2	58D8h	31:0	X	IPv6 Address 2, bytes 9-12
	3	58DCh	31:0	X	IPv6 Address 2, bytes 16-13
IPV4ADDR0	0	58E0h	31:0	X	IPv4 Address 0 (least significant byte is first on the wire)
IPV4ADDR1	1	58E4h	31:0	X	IPv4 Address 1 (least significant byte is first on the wire)
IPV4ADDR2	2	58E8h	31:0	X	IPv4 Address 2 (least significant byte is first on the wire)
IPV4ADDR3	3	58ECh	31:0	X	IPv4 Address 3 (least significant byte is first on the wire)

Field	Bit(s)	Initial Value	Description
IP_ADDR 4 bytes	31:0	X	Four bytes of IP (v6 or v4) address i mod 4 = 0 → bytes 1 - 4 i mod 4 = 1 → bytes 5 - 8 i mod 4 = 0 → bytes 9 - 12 i mod 4 = 0 → bytes 13 - 16 where i div four is the index of IP address (0..3).



## 14.7.8 Manageability MAC Address Low - MMAL (5910h + 8\*n[n=0..3]; RW)

These registers contain the lower bits of the 48 bit Ethernet address. The MMAL registers are written by the BMC and not accessible to the host for writing. The registers are used to filter manageability packets.

Reset - The MMAL registers are cleared on Internal\_Power\_On\_Reset only. The initial values for this register can be loaded from the EEPROM by the management firmware after power-up reset.

The MMAL value should be configured to the register in host order.

Field	Bit(s)	Initial Value	Description
MMAL	31:0	X	Manageability MAC Address Low The lower 32 bits of the 48 bit Ethernet address.

## 14.7.9 Manageability MAC Address High - MMAH (0x5914 + 8\*n[n=0..3]; RW)

These registers contain the upper bits of the 48 bit Ethernet address. The complete address is {MMAH, MMAL}. The MMAH registers are written by the BMC and not accessible to the host for writing. The registers are used to filter manageability packets.

Reset - The MMAH registers are cleared on Internal\_Power\_On\_Reset only. The initial values for this register can be loaded from the EEPROM by the management firmware after power-up reset or firmware reset.

The MMAH value should be configured to the register in host order.

Field	Bit(s)	Initial Value	Description
MMAH	15:0	X	Manageability MAC Address High The upper 16 bits of the 48 bit Ethernet address.
Reserved	31:16	00h	Reserved Reads as 00h. Ignored on writes.

## 14.7.10 Flexible TCO Filter Table Registers - FTFT (09400h-097FCh; RW)

Each of the Four Flexible TCO Filters Table (FTFT) registers contains a 128-byte pattern and a corresponding 128-bit mask array. If enabled, the first 128 bytes of the received packet are compared against the non-masked bytes in the FTFT register.



Each 128-byte filter is composed of 32 Dword entries, where each two Dwords are accompanied by an 8-bit mask, one bit per filter byte. The bytes in each two Dwords are written in network order. For example, byte0 written to bits [7:0], byte1 to bits [15:8] etc. The mask field is set so that bit0 in the mask masks byte0, bit 1 masks byte 1 etc. A value of one in the mask field means that the appropriate byte in the filter should be compared to the appropriate byte in the incoming packet.

**Note:** The mask field must be 8 bytes aligned even if the length field is not 8 bytes aligned as the hardware implementation compares 8 bytes at a time so it should get extra masks until the end of the next Qword. Any mask bit that is located after the length should be set to zero indicating no comparison should be done.

In case the actual length, which is defined by the length field register and the mask bits, is not 8 bytes aligned there might be a case that a packet which is shorter than the actual required length pass the flexible filter. This can happen due to comparison of up to 7 bytes that come after the packet but are not a real part of the packet.

The last Dword of each filter contains a length field defining the number of bytes from the beginning of the packet compared by this filter. If actual packet length is less than the length specified by this field, the filter fails. Otherwise, it depends on the result of actual byte comparison. The value should not be greater than 128.

The initial values for the FTFT registers can be loaded from the EEPROM after power-up reset. The FTFT registers are written by the BMC and not accessible to the host for writing. The registers are used to filter manageability packets.

Reset - The FTFT registers are cleared on Internal\_Power\_On\_Reset only.

31	8	31	8	7	0	31	0	31	0
Reserved		Reserved		Mask [7:0]		Dword 1		Dword 0	
Reserved		Reserved		Mask [15:8]		Dword 3		Dword 2	
Reserved		Reserved		Mask [23:16]		Dword 5		Dword 4	
Reserved		Reserved		Mask [31:24]		Dword 7		Dword 6	

.....

31	8	31	8	7	0	31	0	31	0
Reserved		Reserved		Mask [127:120]		Dword 29		Dword 28	
Length		Reserved		Mask [127:120]		Dword 31		Dword 30	

Field	Dword	Address	Bit(s)	Initial Value
Filter 0 Dword0	0	09400h	31:0	X
Filter 0 Dword1	1	09404h	31:0	X
Filter 0 Mask[7:0]	2	09408h	7:0	X
Reserved	3	0940Ch		X
Filter 0 Dword2	4	09410h	31:0	X
...				
Filter 0 Dword30	60	094F0h	31:0	X
Filter 0 Dword31	61	094F4h	31:0	X
Filter 0 Mask[127:120]	62	094F8h	7:0	X
Length	63	094FCh	6:0	X



## 14.7.11 Legacy Sensor Polling Mask 1...8 Register (F8h:FFh)

This register provides software an interface for the 8 legacy sensor polling data masks.

Register	Description
F8h	Legacy Sensor Polling Mask #1.
F9h	Legacy Sensor Polling Mask #2.
FAh	Legacy Sensor Polling Mask #3.
FBh	Legacy Sensor Polling Mask #4.
FCh	Legacy Sensor Polling Mask #5.
FDh	Legacy Sensor Polling Mask #6.
FEh	Legacy Sensor Polling Mask #7.
FFh	Legacy Sensor Polling Mask #8.

Each polling mask has the following format:

Bits	Name	Type	Description / Function	Default
7:0	POLL_MSK	R/W	Polling Mask for Polling Descriptor #N This register is used to read and write the data mask for Legacy Sensor Polling Descriptor #N.	0

These registers are initialized to 0b after all EPROM reload events.

## 14.8 PCIe\* Registers

### 14.8.1 PCIe\* Control - GCR (05B00h; R)

Field	Bit(s)	Initial Value	Description
Reserved	31	0b	Reserved
Self_Test_Result	30	0b	If set, self test result finished successfully (after an Internal_Power_On_Reset).
GIO_Good_10s	29	0b	Force good PCIe* L0s training (after an Internal_Power_On_Reset).
GIO_Dis_Rd_Err	28	0b	Disable running disparity error of PCIe* 108b decoders (after an Internal_Power_On_Reset).
L1_Act_Without_L0s_Rx	27	0b	If set, enables the 82575 to enter ASPM L1 active without any correlation of L0s_rx (after an Internal_Power_On_Reset).
L1_Entry_Latency (RO)	26:25	11b	Determines the idle time of the PCIe* link in L0s state before initiating a transition to L1 state. Initial value is loaded from the EEPROM. 00b - 64 μs 01b - 256 μs 10b - 1 ms 11b - 4 ms





L0s_Entry_Lat	24	0b	L0s Entry Latency Set to 0b to indicate L0s entry latency is the same as L0s exit latency. Set to 1b to indicate L0s entry latency is (L0s exit latency/4).
Reserved	23	0b	Reserved
Reserved	22	1b	Reserved Must be set to 1b.
hdr_log Inversion	21	0b	If set, the header log in error reporting is written as 31:0 to log1, 63:643 in log2. If not set, the header is written as 127:96 in log1 95:64 in log 2 .....
PBA_CL_DEAS	20	0b	If cleared, PBA is cleared on de-assertion of MSI-X request.
g_sa_250_2ph_en	19	0b	Enables probed-data speed reduction to enable slow pads reflect 250 Mbaud signals by splitting them into two phases, each 62.5 Mbaud. Effective only in GIO analog standalone mode. 1b = enable (default). 0b = disabled.
PCIe* Capability Version (RO)	18	0b	Reports the PCIe* Capability Version Supported 0b = Capability version = 1h. 1b = Capability version = 2h.
Completion_ Timeout_Disable (RO or RW1)	17	0b	Indicates if PCIe* Completion Timeout is Supported (after an Internal_Power_On_Reset) 0b = Completion timeout enabled. 1b = Completion timeout disabled.
Completion_ Timeout_Resend	16	1b	When set, enables to resend a request once the completion timeout expired 0b = Do not resend request on completion timeout. 1b = Resend request on completion timeout. This bit is used no matter which timeout mechanism is used.



Completion_Timeout_Value (RO or RW1)	15:12	0h	<p>Indicates the selected value for completion timeout (after an Internal_Power_On_Reset).</p> <p>Decoding of this field depends on the PCIe* capability version:</p> <p>Capability version = 1 (bits 13:12):</p> <p>00b = 50 <math>\mu</math>s to 10 ms (default)</p> <p>01b = 10 ms to 200 ms</p> <p>10b = 200 ms to 4 s</p> <p>11b = 4 s to 64 s</p> <p>Bits 15:14 are reserved</p> <p>Capability version = 2:</p> <p>0000b = 50 <math>\mu</math>s to 50 ms</p> <p>0001b = 50 <math>\mu</math>s to 100 <math>\mu</math>s</p> <p>0010b = 1 ms to 10 ms</p> <p>0011b = Reserved</p> <p>0100b = Reserved</p> <p>0101b = 16 ms to 55 ms</p> <p>0110b = 65 ms to 210 ms</p> <p>0111b = Reserved</p> <p>1000b = Reserved</p> <p>1001b = 260 ms to 900 ms</p> <p>1010b = 1 s to 3.5 s</p> <p>1011b = Reserved</p> <p>1100b = Reserved</p> <p>1101b = 4 s to 13 s</p> <p>1110b = 17 s to 64 s</p> <p>1111b = Reserved</p>
Reserved	11:10	00b	Reserved
Rx_L0s_Adjustment	9	1b	<p>If set, the replay timer always adds the required L0s adjustment (after an Internal_Power_On_Reset).</p> <p>When set to 0b, adds it only when Tx L0s are active (after an Internal_Power_On_Reset).</p>
FW_Self_Test_Enable	8	0b	When set, firmware should perform a self test (after an Internal_Power_On_Reset).
Reserved	7:3	0h	Reserved
CBDE (RO)	2	0b	<p>Data Movement Engine Transfer Enabled</p> <p>Reflects the transfer enable bit received from the CB_RESPONSE message.</p>
Field	Bit(s)	Initial Value	Description
CBA (RO)	1	0b	<p>Data Movement Engine Active</p> <p>This bit is set to 1b following reception of the response VDM sent by the data movement engine.</p> <p>If the I/OAT fuse is fused out, then this bit remains reset to 0b.</p>
CBDB (WO)	0	0b	<p>Data Movement Engine Doorbell</p> <p>This bit is used by the software device driver to trigger sending the data movement engine.</p>



## 14.8.2 Function Tag - FUNCTAG (05B08h; R/W)

Field	Bit(s)	Initial Value	Description
cnt_0_tag	4:0	0h	Tag number for event 6/1D, if located in counter 0.
cnt_0_func	7:5	0h	Function number for event 6/1D, if located in counter 0.
cnt_1_tag	12:8	0h	Tag number for event 6/1D, if located in counter 2.
cnt_1_func	15:13	0h	Function number for event 6/1D, if located in counter 1.
cnt_2_tag	20:16	0h	Tag number for event 6/1D, if located in counter 2.
cnt_2_func	23:21	0h	Function number for event 6/1D, if located in counter 2.
cnt_3_tag	28:24	0h	Tag number for event 6/1D, if located in counter 3.
cnt_3_func	31:29	0h	Function number for event 6/1D, if located in counter 3.

## 14.8.3 PCIe\* Statistics Control #1 - GSCL\_1 (05B10h; R)

Field	Bit(s)	Initial Value	Description
GIO_COUNT_START	31	0b	Start indication of PCIe* statistic counters.
GIO_COUNT_STOP	30	0b	Stop indication of PCIe* statistic counters.
GIO_COUNT_RESET	29	0b	Reset indication of PCIe* statistic counters.
GIO_64_BIT_EN	28	0b	Enable two 64-bit counters instead of four 32-bit counters.
GIO_COUNT_TEST	27	0b	Test Bit Firmware counters for testability.
Reserved	26:4	0b	Reserved.
GIO_COUNT_EN_3	3	0b	Enable PCIe* Statistic Counter Number 3.
GIO_COUNT_EN_2	2	0b	Enable PCIe* Statistic Counter Number 2.
GIO_COUNT_EN_1	1	0b	Enable PCIe* Statistic Counter Number 1.
GIO_COUNT_EN_0	0	b0	Enable PCIe* Statistic Counter Number 0.

## 14.8.4 PCIe\* Statistics Control #2 - GSCL\_2 (05B14h; R)

This counter contains the mapping of an event (which counter counts what event).



Field	Bit(s)	Initial Value	Description
GIO_EVENT_NUM_3	31:24	0b	Event number that counter 3 counts.
GIO_EVENT_NUM_2	23:16	0b	Event number that counter 2 counts.
GIO_EVENT_NUM_1	15:8	0b	Event number that counter 1 counts.
GIO_EVENT_NUM_0	7:0	0b	Event number that counter 0 counts.

Table 92 lists the encoding of the events.

**Table 92. Event Encodings**

Transaction Layer Events	Event Mapping (Hex)	Description
Dwords of transaction layer packet transmitted (transferred to the physical layer), include payload and header.	0	Each 125 MHz cycle, the counter increases by one (1 dw) or 2 (2 dw). Counted: completion, memory, message (not replied)
All types of transmitted packets.	1	Only TLP packets. Each cycle, the counter increases by one if TLP packet was transmitted to the link. Counted: completion, memory, message (not replied)
Transmit TLP Packets of function #0	2	Each cycle, the counter increases by one, if the packet was transmitted. Counted: memory, message of function 0 (not replied)
Transmit TLP Packets of function #1	3	Each cycle, the counter increases by one, if the packet was transmitted Counted: memory, message of function 1 (not replied)
Non posted Transmit TLP packets of function #0	4	Each cycle, the counter increases by one, if the packet was transmitted Counted: memory (np) of function 0 (not replied)
Non posted Transmit TLP packets of function #1	5	Each cycle, the counter increases by one, if the packet was transmitted Counted: memory (np) of function 1 (not replied)
Transmit TLP Packets of function X and tag Y, according to FUNC_TAG register	6	Each cycle, the counter increases by one, if the packet was transmitted Counted: memory, message for a given func# and tag# (not replied)
All types of received packets (TLP only)	1A	Each cycle, the counter increases by one, if the packet was received Counted: completion (only good), memory, I/O, config
Receive TLP Packets of function #0	1B	Each cycle, the counter increases by one, if the packet was transmitted. Counted: good completions of func#0
Receive TLP Packets of function #1	1C	Each cycle, the counter increases by one, if the packet was transmitted Counted: good completions of func#1
Receive Completion Packets	1D	Each cycle, the counter increases by one, if the packet was received. Counted: good completions for a given func# and tag#



Clock counter	20	Counts GIO cycles.
Bad TLP from LL	21	Each cycle, the counter increases by one, if bad TLP is received (bad crc, error reported by AL, misplaced special char, reset in thI of received tlp).
Header dwords of Transaction layer packet transmitted.	25	Only TLP, each 125 MHz cycle the counter increases by one (1 dw of header) or 2 (2 dw of header). Counted: completion, memory, message (not replied)
Header dwords of Transaction layer packet received.	26	Only TLP, each 125 MHz cycle the counter increases by one (1 dw of header) or 2 (2 dw of header). Counted: completion, memory, message
Transaction layer stalls transmitting due to lack of flow control credits of the next part.	27	The counter counts the number of times Transaction layer Stop transmitting because of this (per packet). Counted: completion, memory, message
Retransmitted packets.	28	The Counter increases for each retransmitted packet. Counted: completion, memory, message
Stall due to retry buffer full	29	The counter counts the number of times Transaction layer stop transmitting because Retry buffer is full (per packet). Counted: completion, memory, message
Retry buffer is under threshold	2A	Threshold specified by software, Retry buffer is under threshold per packet. Counted: completion, memory, message
PRH (posted request header) flow control credits (of the next part) below threshold	2B	Threshold specified by software. The counter increases each time number of the specific flow control credits is lower than threshold. Counted: According to credit type
PRD (posted request data) flow control credits (of the next part) below threshold	2C	
NPRH (non posted request header) flow control credits (of the next part) below threshold	2D	
CPLH (completion header) flow control credits (of the next part) below threshold	2E	
CPLD (completion data) flow control credits (of the next part) below threshold	2F	
PRH (posted request header) flow control credits (of local part) get to 0.	30	Threshold specified by software. The counter increases each time number of the specific flow control credits is get the value 0 (The period that the credit is 0 not counted). Counted: According to credit type
NPRH (non posted request header) flow control credits (of local part) get to 0.	31	
PRD (posted request data) flow control credits (of local part) get to 0.	32	
NPRD (non posted request data) flow control credits (of local part) get to 0.	33	
Dwords of Transaction layer packet received, include payload and header.	34	Each 125 MHz cycle the counter increases by one (1 dw) or 2 (2 dw). Counted: completion, memory, message, I/O, config
Messages packets received	35	Each 125 MHz cycle the counter increases by one Counted: messages (only good)
Received packets to func_logic.	36	Each 125 MHz cycle the counter increases by one Counted: memory, I/O, config (only good)



Average latency of read request – from initialization until end of completions. Estimated latency is ~5 μs.	40 + 41	The software will select the client need to be tested. The statistic counter will count the number of read request of the required client. In addition, the accumulated time of all requests will be saved in a time accumulator. The average time for read request will be [Accumulated time / Number of read requests] (Event 41 is for the counter)
Average latency of read request RTT– from initialization until the first completion is arrived (Round Trip Time). Estimated latency is 1uSec	42 + 43	The software will select the client need to be tested. The statistic counter will count the number of read request of the required client. In addition, the accumulated time of all RTT will be saved in a time accumulator. The average time for read request will be [Accumulated time / Number of read requests] (Event 43 is for the counter)
Requests that reached Time Out.	44	Number of requests that reached Time Out.
Completion Latency above Threshold	45 + 46	The software will select the client need to be tested. The software will program the required threshold (in GSCL_4 – units of 96 ns). One statistic counter will count the time from the beginning of the request until end of completions. The other counter will count the number of events. If the time is above threshold – add 1 to the event counter. (Event 46 is for the counter)
Completion Latency above Threshold – for RTT	47 + 48	The software will select the client need to be tested. The software will program the required threshold (in GSCL_4 – units of 96 ns). One statistic counter will count the time from the beginning of the request until first completion arrival. The other counter will count the number of events. If the time is above threshold – add 1 to the event counter. (Event 48 is for the counter)
Dwords of packet transmitted (transferred to the physical layer), include payload and header.	50	Include DLLP (Link layer packets) and TLP (transaction layer packets transmitted). Each 125 MHz cycle the counter increase in 1 (1 dw) or 2 (2 dw).
Dwords of packet received (transferred to the physical layer), include payload and header.	51	Include DLLP (Link layer packets) and TLP (transaction layer packets transmitted). Each 125 MHz cycle the counter increase in 1 (1 dw) or 2 (2 dw).
All types of DLLP packets transmitted from link layer.	52	Each cycle, the counter increases by one, if DLLP packet was transmitted.
Flow control DLLP transmitted from link layer.	53	Each cycle, the counter increases by one, if message was transmitted
Ack DLLP transmitted.	54	Each cycle, the counter increases by one, if message was transmitted.
All types of DLLP packets received.	55	Each cycle, the counter increases by one, if DLLP was received.



Flow control DLLP received in Link layer.	56	Each cycle, the counter increases by one, if message was received.
Ack DLLP received.	57	Each cycle, the increases by one, if message was received.
Nack DLLP received.	58	Each cycle, the counter increases by one, if message was transmitted

### 14.8.5 PCIe\* Statistics Control #3 - GSCL\_3 (05B18h; R/W)

This counter holds the threshold values needed for some of the event counting. The event increases only after the value passes the threshold boundary.

Field	Bit(s)	Initial Value	Description
Reserved	31:28	0b	Reserved.
GIO_FC_TH_1	27:16	0b	Threshold of flow control credits. Optional values: 0 - (256-1).
Reserved	15:12	0b	Reserved.
GIO_FC_TH_0	11:0	0b	Threshold of flow control credits. Optional values: 0 - (256-1).

### 14.8.6 PCIe\* Statistics Control #4 - GSCL\_4 (05B1Ch; R/W)

This counter holds the threshold values needed for some of the event counting. The event increases only after the value passes the threshold boundary.

Field	Bit(s)	Initial Value	Description
Reserved	31:16	0b	Reserved.
GIO_RB_TH	15:10	0b	Retry buffer threshold.
GIO_COML_TH	9:0	0b	Completions latency threshold.

### 14.8.7 PCIe\* Counter #0 - GSCN\_0 (05B20h; R/W)

31	0
Event Counter	

### 14.8.8 PCIe\* Counter #1 - GSCN\_1 (05B24h; R/W)

31	0
Event Counter	



## 14.8.9 PCIe\* Counter #2 - GSCN\_2 (05B28h; R/W)

31

0

Event Counter
---------------

## 14.8.10 PCIe\* Counter #3 - GSCN\_3 (05B2Ch; R/W)

31

0

Event Counter
---------------

## 14.8.11 Function Active and Power State to MNG - FACTPS (05B30h; R)

Firmware uses this register for configuration.

Field	Bit(s)	Initial Value	Description
PM State Changed	31	0b	Indication that one or more of the functions power states had changed. This bit is also a signal to the MNG unit to create an interrupt. This bit is cleared on read, and is not set for at least 8 cycles after it was cleared.
LAN Function Sel	30	0b	When both LAN ports are enabled and the LAN Function Sel equals 0b, LAN 0 is routed to PCIe* Function 0 and LAN 1 is routed to PCIe* Function 1. If the LAN Function Sel equals 1b, LAN 0 is routed to PCIe* Function 1 and LAN 1 is routed to PCIe* Function 0. If any of the LAN functions are disabled, the other one is routed to PCIe* Function 0 regardless of the LAN Function Sel. This bit is initiated by EEPROM word 21h.
MNGCG	29	0b	MNG Clock Gated When set, indicates that the manageability clock is gated.
Reserved	28:10	0h	Reserved
Func1 Aux_En	9	0b	Function 1 Auxiliary (AUX) Power PM Enable bit shadow from the configuration space.
LAN1 Valid	8	0b	LAN 1 Enable When set to 0b, it indicates that the LAN 0 function is disabled. When the function is enabled, the bit is set to 1b. The LAN 0 enable is set by the LAN 1 Enable / TEST_POINT[3] strapping pin.
Func1 Power State	7:6	00b	Power state indication of Function 1 00b -> DR 01b -> D0u 10b -> D0a 11b -> D3
Reserved	5:4	0b	Reserved.



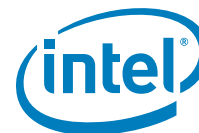

Func0 Aux_En	3	0b	Function 0 Auxiliary (AUX) Power PM Enable bit shadow from the configuration space.
LAN0 Valid	2	0b	LAN 0 Enable When set to 0b, it indicates that the LAN 0 function is disabled. When the function is enabled, the bit is set to 1b. The LAN 0 enable is set by the LAN 0 Enable / TEST_POINT[2] strapping pin.
Func0 Power State	1:0	00b	Power state indication of Function 0 00b -> DR 01b -> D0u 10b -> D0a 11b -> D3

### 14.8.12 SerDes/CCM/PCIe\* CSR - GIOANACTLO (05B34h; R/W)

Firmware uses this register for analog circuit configuration.

Field	Bit(s)	Initial Value	Description
Done Indication	31	1b	When a write operation completes this bit is set to 1b indicating that new data can be written. This bit is over written to 0b by new data.
Reserved	30:16	0b	Reserved.
Address	15:8	0b	Address to SerDes.
Data	7:0	0b	Data to SerDes.

### 14.8.13 SerDes/CCM/PCIe\* CSR - GIOANACTL1 (05B38h; R/W)

Firmware uses this register for analog circuit configuration.

Field	Bit(s)	Initial Value	Description
Done Indication	31	1b	When a write operation completes this bit is set to 1b indicating that new data can be written. This bit is over written to 0b by new data.
Reserved	30:16	0b	Reserved.
Address	15:8	0b	Address to SerDes.
Data	7:0	0b	Data to SerDes.

### 14.8.14 GIOANACTL2 (05B3Ch; R/W)

Firmware uses this register for analog circuit configuration.

Field	Bit(s)	Initial Value	Description
Done Indication	31	1b	When a write operation completes this bit is set to 1b indicating that new data can be written. This bit is over written to 0b by new data.



Reserved	30:16	0b	Reserved.
Address	15:8	0b	Address to SerDes.
Data	7:0	0b	Data to SerDes.

### 14.8.15 GIOANACTL3 (05B40h; R/W)

Firmware uses this register for analog circuit configuration.

Field	Bit(s)	Initial Value	Description
Done Indication	31	1b	When a write operation completes this bit is set to 1b indicating that new data can be written. This bit is over written to 0b by new data.
Reserved	30:16	0b	Reserved.
Address	15:8	0b	Address to SerDes.
Data	7:0	0b	Data to SerDes.

### 14.8.16 SerDes/CCM/PCIe\* CSR - GIOANACTLALL (05B44h; R/W)

Firmware uses this register for analog circuit configuration.

Field	Bit(s)	Initial Value	Description
Done Indication	31	1b	When a write operation completes this bit is set to 1b indicating that new data can be written. This bit is over written to 0b by new data.
Reserved	30:16	0b	Reserved.
Address	15:8	0b	Address to SerDes.
Data	7:0	0b	Data to SerDes.

### 14.8.17 SerDes/CCM/PCIe\* CSR - CCMCTL (05B48h; R/W)

Firmware uses this register for analog circuit configuration.

Field	Bit(s)	Initial Value	Description
Done Indication	31	1b	When a write operation completes this bit is set to 1b indicating that new data can be written. This bit is over written to 0b by new data.
Reserved	30:16	0b	Reserved.
Address	15:8	0b	Address to SerDes.
Data	7:0	0b	Data to SerDes.

### 14.8.18 SerDes/CCM/PCIe\* CSR - SCCTL (05B4Ch; R/W)

Firmware uses this register for analog circuit configuration.



Field	Bit(s)	Initial Value	Description
Done Indication	31	1b	When a write operation completes this bit is set to 1b indicating that new data can be written. This bit is over written to 0b by new data.
Reserved	30:16	0b	Reserved.
Address	15:8	0b	Address to SerDes.
Data	7:0	0b	Data to SerDes.

### 14.8.19 Software Semaphore - SWSM (05B50h; R/W)

Field	Bit(s)	Initial Value	Description
Reserved	31:4	0h	Reserved
EEUR	3	0h	EEPROM Update Request EEPROM request update from firmware. Software should clear this bit after the <i>FWSMFW_valid</i> bit is set.
WMNG (SC)	2	0h	Wake MNG clock When this bit is set, hardware wakes the MNG clock (if gated). Asserting this bit does not clear the CFG_DONE bit in the EEMNGCTL register. This bit is self cleared on writes.
SWESMBI	1	0h	Software EEPROM Semaphore bit This bit should be set only by the device driver (read only to firmware). The bit is not set if bit 0 in the FWSM register is set. The device driver should set this bit and then read it to see if it was set. If it was set, it means that the device driver can read/write from/to the EEPROM. The device driver should clear this bit after completing EEPROM access. Hardware clears this bit on PCIe* reset.
SMBI (RS)	0	0h	Semaphore Bit This bit is set by hardware when this register is read by the device driver and cleared when the HOST driver writes a 0b to it. The first time this register is read, the value is 0b. In the next read the value is 1b (hardware mechanism). The value remains 1b until the software device driver clears it. This bit can be used as a semaphore between the two device's drivers in the 82575. This bit is cleared on PCIe* reset.

### 14.8.20 Firmware Semaphore - FWSM (05B58h; R/WS)

Field	Bit(s)	Initial Value	Description
Reserved	31:29	0h	Reserved.
Unlock_EEP	28	0h	Unlock EEPROM Set to 1b by software in order to allow re-writing to EEPROM word 12h (EEPROM Sizing and Protection). Cleared by firmware once EEPROM word 12h is unlocked.



PHY_SERDES1_Config_Err_Ind	27	0h	PHY/SerDes1 configuration error indication Set to 1b by firmware when it fails to configure LAN1 PHY/SerDes. Cleared by firmware upon successful configuration of LAN1 PHY/SerDes.
PHY_SERDES0_Config_Err_Ind	26	0h	PHY/SerDes0 configuration error indication Set to 1b by firmware when it fails to configure LAN0 PHY/SerDes. Cleared by firmware upon successful configuration of LAN0 PHY/SerDes.
PCIe*_Config_Err_Ind	25	0h	PCIe* configuration error indication Set to 1b by firmware when it fails to configure PCIe* interface. Cleared by firmware upon successful configuration of PCIe* interface.
<b>Field</b>	<b>Bit(s)</b>	<b>Initial Value</b>	<b>Description</b>
Ext_Err_Ind	24:19	0h	External error indication Firmware writes here the reason that the firmware has reset / clock gated. For example, EEPROM, flash, patch corruption, etc. Possible values: 00h: No Error 01h: Invalid EEPROM checksum 02h: Unlocked secured EEPROM 03h: Clock Off host command 04h: Invalid FLASH checksum 05h: C0 checksum failed 06h: C1 checksum failed 07h: C2 checksum failed <sup>1</sup> 08h: C3 checksum failed 09h: TLB table exceeded 0Ah: DMA load failed 0Bh: Bad hardware version in patch load 0Ch: Flash device not supported 0Dh: Unspecified Error 3Fh: Reserved - max error value.
Reset_Cnt	18:16	0h	Reset Counter Firmware increments the count at every reset.
FW_Val_Bit	15	0h	Firmware Valid Bit Hardware clears this bit in reset de-assertion so software can know firmware mode (bits 1-5) is invalid. Firmware should set this bit to 1b when it is ready (end of boot sequence).
Reserved	14:7	0h	Reserved
EEP_Reload_Ind	6	0h	EEPROM reloaded indication Set to 1b after firmware reloads the EEPROM. Cleared by firmware once the "Clear Bit" host command is received from host software.



Reserved	5:4	00b	Reserved
FW_Mode	3:1	0h	Firmware Mode Indicates the firmware mode as follows: 000b = No MNG. 010b = PT mode. 011b = Reserved. 100b = Host Interface enable only.
EEP_FW_Semaphore	0	0h	EEPROM Firmware Semaphore Firmware should set this bit to 1b before accessing the EEPROM. If software using the SWSM does not lock the EEPROM, firmware is able to set this bit to 1b. Firmware should set this bit to 0b after completing EEPROM access.

**Notes:**

1. This register should be written only by the manageability firmware. The device driver should only read this register.
2. Firmware ignores the EEPROM semaphore in operating system hung states.
3. Bits 15:0 are cleared on firmware reset.

## 14.8.21 Software-Firmware Synchronization - SW\_FW\_SYNC (05B5Ch; R/WS)

This register is used to synchronize software and firmware. Note that this register is common to both ports 0 and 1.

Field	Bit(s)	Initial Value	Description
SW_EEP_SM	0	0b	When set to 1b, EEPROM access is owned by software.
SW_PHY_SM0	1	0b	When set to 1b, PHY 0 access is owned by software.
SW_PHY_SM1	2	0b	When set to 1b, PHY 1 access is owned by software.
SW_MAC_CSR_SM	3	0b	When set to 1b, software owns access to shared CSRs.
Reserved	15:4	00h	Reserved
FW_EEP_SM	16	0b	When set to 1b, EEPROM access is owned by firmware.
FW_PHY_SM0	17	0b	When set to 1b, PHY 0 access is owned by firmware.
FW_PHY_SM1	18	0b	When set to 1b, PHY 1 access is owned by firmware.
FW_MAC_CSR_SM	19	0b	When set to 1b, firmware owns access to shared CSRs.
Reserved	31:20	0b	Reserved for future use.

### 14.8.21.1 Using the Software-Firmware Synchronization Register

Under reset conditions:

- The software-controlled bits (15:0) are reset as any other CSR (for example, on global resets, D3hot exit, software reset, and forced TCO). Software is expected to clear the bits on entry to D3 state.
- The firmware-controlled bits (31:16) are reset after an Internal\_Power\_On\_Reset and firmware reset.



Software and firmware synchronize accesses to shared resources in the 82575 through a semaphore mechanism and a shared configuration register. The *SWESMBI* bit in the Software Semaphore Register (SWSM) and the *EEP\_FW\_semaphore* bit in the Firmware Semaphore Register (FWSM) serve as a semaphore mechanism between software and firmware. Once software or firmware takes control over the semaphore, it might access the Software-Firmware Synchronization Register (SW\_FW\_SYNC) and claim ownership of a specific resource. The Software-Firmware Synchronization Register includes pairs of bits (one owned by software and the other by firmware), where each pair of bits control a different resource. A resource is owned by software or firmware when the respective bit is set. Note that programmers cannot set both bits in a pair set at the same time.

When software or firmware gains control over the Software-Firmware Synchronization Register, it checks if a certain resource is owned by the other (the bit is set). If not, it might set its bits for that resource, taking ownership of the resource. The same process (claiming the semaphore and accessing the Software-Firmware Synchronization Register) is done when a resource is freed up.

The following example shows how software can use this mechanism to own a resource (firmware accesses are done in an analogous manner):

1. Software takes control over the software/firmware semaphore
  - a. Software writes a 1b to the *SWESMBI* bit in the Software Semaphore Register (SWSM)
  - b. Software then reads the *SWESMBI*. If set, software owns the semaphore. If cleared, this is an indication that firmware currently owns the semaphore. Software should retry the previous step after some delay.
2. Software reads the Software-Firmware Synchronization Register (SW\_FW\_SYNC) and checks the firmware bit in the pair of bits that control the resource is requests to own.
  - a. If the bit is cleared (firmware does not own the resource), software sets the software bit in the pair of bits that control the resource is requests to own.
  - b. If the bit is set (firmware owns the resource), go to step 4.
3. Software releases the software/firmware semaphore by clearing the *SWESMBI* bit in the Software Semaphore Register (SWSM).
4. Software did not succeed in owning the resource (continued from step 2b) - software repeats the process after some delay.

The following example shows how software can use this mechanism to release a resource (firmware accesses are done in an analogous manner):

1. Software takes control over the software/firmware semaphore
  - a. Software writes a 1b to the *SWESMBI* bit in the Software Semaphore Register (SWSM).
  - b. Software then reads the *SWESMBI* bit. If set, software owns the semaphore. If cleared, this is an indication that firmware currently owns the semaphore. software should retry the previous step after some delay.
2. Software writes a 0b to the software bit in the pair of bits that control the resource is requests to release.
3. Software releases the software/firmware semaphore by clearing the *SWESMBI* bit in the Software Semaphore Register (SWSM).
4. Software waits some delay before attempting to control the semaphore again

**Note:** There are distinct bits for each PHY port.



## 14.8.22 Mirrored Revision ID - MREVID (05B64h; R/W)

Field	Bit(s)	Initial Value	Description
Reserved	7:0	01h <sup>1</sup>	Reserved
Default RevID	15:8	02h	Mirroring of Default Rev ID before an EEPROM load. Set to 02h.
Reserved	31:16	00h	Reserved

1. Loaded from the EEPROM.

## 14.8.23 MSI-X PBA Clear - PBACL (05B68h; R/W1C)

Field	Bit(s)	Initial Value	Description
PENBIT	9:0	0h	MSI-X Pending bits Clear Writing a 1b to any bit clears the corresponding MSIXPBA bit; writing a 0b has no effect. Reading this register returns zeros.
Reserved	31:10	0h	Reserved

## 14.8.24 DCA Requester ID Information - DCA\_ID (05B70h; R/W)

The DCA requester ID field, composed of Device ID, Bus #, and Function # is set up in MMIO space for software to program the DCA Requester ID Authentication register.

Field	Bit(s)	Initial Value	Description
Function Number	2:0	000B	Function Number Function number assigned to the function based on BIOS/OS enumeration.
Device Number	7:3	0h	Device Number Device number assigned to the function based on BIOS/OS enumeration.
Bus Number	15:8	0h	Bus Number Bus number assigned to the function based on BIOS/OS enumeration.
Reserved	31:16	0h	Reserved



## 14.8.25 DCA Control - DCA\_CTRL (05B74h; R/W)

Field	Bit(s)	Initial Value	Description
DCA_DIS	0	1b	DCA Disable 0b = DCA tagging is enabled for this port. 1b = DCA tagging is disabled for this port.
DCA_MODE	4:1	0h	DCA Mode 000b = Data movement engine 1 is supported. The TAG field in the TLP header is based on the following coding: bit 0 is DCA enable; bits 3:1 are CPU ID). 001b = Data movement engine 2 is supported. When DCA is disabled for a given message, the TAG field is 0000,0000b. If DCA is enabled, the TAG is set per queue as programmed in the relevant DCA Control register. All other values are undefined.
Reserved	31:5	0h	Reserved

**Note:** The DCA tag disabled value in data movement engine 2 mode in the 82575 A0 is 11111b.

## 14.9 Statistics Registers

All Statistics registers reset when read. In addition, they stick at FFFF\_FFFFh when the maximum value is reached.

For the receive statistics it should be noted that a packet is indicated as received if it passes the 82575's filters and is placed into the packet buffer memory. A packet does not have to be transferred to host memory in order to be counted as received.

Due to divergent paths between interrupt-generation and logging of relevant statistics counts, it might be possible to generate an interrupt to the system for a noteworthy event prior to the associated statistics count actually being incremented. This is extremely unlikely due to expected delays associated with the system interrupt-collection and ISR delay, but might be observed as an interrupt for which statistics values do not quite make sense. Hardware guarantees that any event noteworthy of inclusion in a statistics count is reflected in the appropriate count within 1  $\mu$ s; a small time-delay prior to a read of statistics might be necessary to avoid the potential for receiving an interrupt and observing an inconsistent statistics count as part of the ISR.

### 14.9.1 CRC Error Count - CRCERRS (04000h; RC)

Counts the number of receive packets with CRC errors. In order for a packet to be counted in this register, it must pass address filtering and must be 64 bytes or greater (from <Destination Address> through <CRC>, inclusively) in length. If receives are not enabled, then this register does not increment.

**Note:** This counter also includes the alignment errors counted by the ALGNERRC register.

Field	Bit(s)	Initial Value	Description
CEC	31:0	0b	CRC error count





## 14.9.2 Alignment Error Count - ALGNERRC (04004h; RC)

Counts the number of receive packets with alignment errors (the packet is not an integer number of bytes in length). In order for a packet to be counted in this register, it must pass address filtering and must be 64 bytes or greater (from <Destination Address> through <CRC>, inclusively) in length. If receives are not enabled, then this register does not increment. This register is valid only in MII mode during 10/100 Mb/s operation.

Field	Bit(s)	Initial Value	Description
AEC	31:0	0b	Alignment error count

## 14.9.3 Symbol Error Count - SYMERRS (04008h; RC)

Counts the number of symbol errors between reads. The count increases for every bad symbol received, whether or not a packet is currently being received and whether or not the link is up. When working in SerDes/SGMII mode these statistics can be read from the SCVPC register.

Field	Bit(s)	Initial Value	Description
SYMERRS	31:0	0b	Symbol Error Count

## 14.9.4 RX Error Count - RXERRC (0400Ch; RC)

Counts the number of packets received in which RX\_ER was asserted by the PHY. In order for a packet to be counted in this register, it must pass address filtering and must be 64 bytes or greater (from <Destination Address> through <CRC>, inclusively) in length. If receives are not enabled, then this register does not increment.

Field	Bit(s)	Initial Value	Description
RXEC	31:0	0b	RX error count

## 14.9.5 Missed Packets Count - MPC (04010h; RC)

Counts the number of missed packets. Packets are missed when the receive FIFO has insufficient space to store the incoming packet. This can be caused because of too few buffers allocated, or because there is insufficient bandwidth on the PCI bus. Events setting this counter cause RXO, the Receiver Overrun Interrupt, to be set. This register does not increment if receives are not enabled.

These packets are also counted in the Total Packets Received register as well as in Total Octets Received.

Field	Bit(s)	Initial Value	Description
MPC	31:0	0b	Missed Packets Count



### 14.9.6 Single Collision Count - SCC (04014h; RC)

This register counts the number of times that a successfully transmitted packet encountered a single collision. This register only increments if transmits are enabled and the 82575 is in half-duplex mode.

Field	Bit(s)	Initial Value	Description
SCC	31:0	0b	Number of times a transmit encountered a single collision.

### 14.9.7 Excessive Collisions Count - ECOL (04018h; RC)

When 16 or more collisions have occurred on a packet, this register increments, regardless of the value of collision threshold. If collision threshold is set below 16, this counter won't increment. This register only increments if transmits are enabled and the 82575 is in half-duplex mode.

Field	Bit(s)	Initial Value	Description
ECC	31:0	0b	Number of packets with more than 16 collisions.

### 14.9.8 Multiple Collision Count - MCC (0401Ch; RC)

This register counts the number of times that a transmit encountered more than one collision but less than 16. This register only increments if transmits are enabled and the 82575 is in half-duplex mode.

Field	Bit(s)	Initial Value	Description
MCC	31:0	0b	Number of times a successful transmit encountered multiple collisions.

### 14.9.9 Late Collisions Count - LATECOL (04020h; RC)

Late collisions are collisions that occur after one slot time. This register only increments if transmits are enabled and the 82575 is in half-duplex mode.

Field	Bit(s)	Initial Value	Description
LCC	31:0	0b	Number of packets with late collisions.

### 14.9.10 Collision Count - COLC (04028h; RC)

This register counts the total number of collisions seen by the transmitter. This register only increments if transmits are enabled and the 82575 is in half-duplex mode. This register applies to clear as well as secure traffic.

Field	Bit(s)	Initial Value	Description
CCC	31:0	0b	Total number of collisions experienced by the transmitter.



### 14.9.11 Defer Count - DC (04030h; RC)

This register counts defer events. A defer event occurs when the transmitter cannot immediately send a packet due to the medium being busy either because another device is transmitting, the IPG timer has not expired, half-duplex deferral events, reception of XOFF frames, or the link is not up. This register only increments if transmits are enabled. This counter does not increment for streaming transmits that are deferred due to TX IPG.

Field	Bit(s)	Initial Value	Description
CDC	31:0	0b	Number of defer events.

### 14.9.12 Transmit with No CRS - TNCRS (04034h; RC)

This register counts the number of successful packet transmission in which the CRS input from the PHY was not asserted within one slot time of start of transmission from the MAC. Start of transmission is defined as the assertion of TX\_EN to the PHY.

The PHY should assert CRS during every transmission. Failure to do so might indicate that the link has failed, or the PHY has an incorrect link configuration. This register only increments if transmits are enabled. This register is not valid in SGMII mode and is only valid when the 82575 is operating at half duplex.

Field	Bit(s)	Initial Value	Description
TNCRS	31:0	0b	Number of transmissions without a CRS assertion from the PHY.

### 14.9.13 Receive Length Error Count - RLEC (04040h; RC)

This register counts receive length error events. A length error occurs if an incoming packet passes the filter criteria but is undersized or oversized. Packets less than 64 bytes are undersized. Packets over 1518/1522/1526 bytes (according to the number of VLAN tags present) are oversized if Long Packet Enable (LPE) is 0b. If LPE is 1b, then an incoming, packet is considered oversized if it exceeds the size defined in RLPML.PML field.

If receives are not enabled, this register does not increment. These lengths are based on bytes in the received packet from <Destination Address> through <CRC>, inclusively.

Field	Bit(s)	Initial Value	Description
RLEC	31:0	0b	Number of packets with receive length errors.

### 14.9.14 XON Received Count - XONRXC (04048h; RC)

This register counts the number of valid XON packets received. XON packets can use the global address, or the station address. This register only increments if receives are enabled.



Field	Bit(s)	Initial Value	Description
XONRXC	31:0	0b	Number of XON packets received.

### 14.9.15 XON Transmitted Count - XONTXC (0404Ch; RC)

This register counts the number of XON packets transmitted. These can be either due to a full queue or due to software initiated action (using TCTL.SWXOFF). This register only increments if transmits are enabled.

Field	Bit(s)	Initial Value	Description
XONTXC	31:0	0b	Number of XON packets transmitted.

### 14.9.16 XOFF Received Count - XOFRXC (04050h; RC)

This register counts the number of valid XOFF packets received. XOFF packets can use the global address or the station address. This register only increments if receives are enabled.

Field	Bit(s)	Initial Value	Description
XOFRXC	31:0	0b	Number of XOFF packets received.

### 14.9.17 XOFF Transmitted Count - XOFTXC (04054h; RC)

This register counts the number of XOFF packets transmitted. These can be either due to a full queue or due to software initiated action (using TCTL.SWXOFF). This register only increments if transmits are enabled.

Field	Bit(s)	Initial Value	Description
XOFTXC	31:0	0b	Number of XOFF packets transmitted.

### 14.9.18 FC Received Unsupported Count - FCRUC (04058h; RC)

This register counts the number of unsupported flow control frames that are received.

The FCRUC counter increments when a flow control packet is received that matches either the reserved flow control multicast address (in FCAH/L) or the MAC station address, and has a matching flow control type field match (to the value in FCT), but has an incorrect opcode field. This register only increments if receives are enabled.

Field	Bit(s)	Initial Value	Description
FCRUC	31:0	0b	Number of unsupported flow control frames received.



### 14.9.19 Packets Received (64 Bytes) Count - PRC64 (0405Ch; RC)

This register counts the number of good packets received that are exactly 64 bytes (from <Destination Address> through <CRC>, inclusively) in length. Packets that are counted in the Missed Packet Count register are not counted in this register. Packets sent to the manageability engine are included in this counter. This register does not include received flow control packets and increments only if receives are enabled.

Field	Bit(s)	Initial Value	Description
PRC64	31:0	0b	Number of packets received that are 64 bytes in length.

### 14.9.20 Packets Received (65-127 Bytes) Count - PRC127 (04060h; RC)

This register counts the number of good packets received that are 65-127 bytes (from <Destination Address> through <CRC>, inclusively) in length. Packets that are counted in the Missed Packet Count register are not counted in this register. Packets sent to the manageability engine are included in this counter. This register does not include received flow control packets and increments only if receives are enabled.

Field	Bit(s)	Initial Value	Description
PRC127	31:0	0b	Number of packets received that are 65-127 bytes in length.

### 14.9.21 Packets Received (128-255 Bytes) Count - PRC255 (04064h; RC)

This register counts the number of good packets received that are 128-255 bytes (from <Destination Address> through <CRC>, inclusively) in length. Packets that are counted in the Missed Packet Count register are not counted in this register. Packets sent to the manageability engine are included in this counter. This register does not include received flow control packets and increments only if receives are enabled.

Field	Bit(s)	Initial Value	Description
PRC255	31:0	0b	Number of packets received that are 128-255 bytes in length.

### 14.9.22 Packets Received (256-511 Bytes) Count - PRC511 (04068h; RC)

This register counts the number of good packets received that are 256-511 bytes (from <Destination Address> through <CRC>, inclusively) in length. Packets that are counted in the Missed Packet Count register are not counted in this register. Packets sent to the manageability engine are included in this counter. This register does not include received flow control packets and increments only if receives are enabled.



Field	Bit(s)	Initial Value	Description
PRC511	31:0	0b	Number of packets received that are 256-511 bytes in length.

### 14.9.23 Packets Received (512-1023 Bytes) Count - PRC1023 (0406Ch; RC)

This register counts the number of good packets received that are 512-1023 bytes (from <Destination Address> through <CRC>, inclusively) in length. Packets that are counted in the Missed Packet Count register are not counted in this register. Packets sent to the manageability engine are included in this counter. This register does not include received flow control packets and increments only if receives are enabled.

Field	Bit(s)	Initial Value	Description
PRC1023	31:0	0b	Number of packets received that are 512-1023 bytes in length.

### 14.9.24 Packets Received (1024 to Max Bytes) Count - PRC1522 (04070h; RC)

This register counts the number of good packets received that are from 1024 bytes to the maximum (from <Destination Address> through <CRC>, inclusively) in length. The maximum is dependent on the current receiver configuration (for example, LPE, etc.) and the type of packet being received. If a packet is counted in Receive Oversized Count, it is not counted in this register (see [Section 14.9.34](#)). This register does not include received flow control packets and only increments if the packet has passed address filtering and receives are enabled. Packets sent to the manageability engine are included in this counter.

Due to changes in the standard for maximum frame size for VLAN tagged frames in 802.3, the 82575 accepts packets that have a maximum length of 1522 bytes. The RMON statistics associated with this range has been extended to count 1522 byte long packets. If CTRL.Extended\_VLAN is set, packets up to 1526 bytes are counted by this counter.

Field	Bit(s)	Initial Value	Description
PRC1522	31:0	0b	Number of packets received that are 1024-Max bytes in length.

### 14.9.25 Good Packets Received Count - GPRC (04074h; RC)

This register counts the number of good packets received of any legal length. The legal length for the received packet is defined by the value of Long Packet Enable (CTRL.LPE) (see [Section 14.9.34](#)). This register does not include received flow control packets and only counts packets that pass filtering. This register only increments if receives are enabled. This register does not count packets counted by the Missed Packet Count (MPC) register. Packets sent to the manageability engine are included in this counter.

**Note:** GPRC can count packets interrupted by a link disconnect although they have a CRC error.



Field	Bit(s)	Initial Value	Description
GPRC	31:0	0b	Number of good packets received (of any length).

## 14.9.26 Broadcast Packets Received Count - BPRC (04078h; RC)

This register counts the number of good (no errors) broadcast packets received. This register does not count broadcast packets received when the broadcast address filter is disabled. This register only increments if receives are enabled. This register does not count packets counted by the Missed Packet Count (MPC) register. Packets sent to the manageability engine are included in this counter.

Field	Bit(s)	Initial Value	Description
BPRC	31:0	0b	Number of broadcast packets received.

## 14.9.27 Multicast Packets Received Count - MPRC (0407Ch; RC)

This register counts the number of good (no errors) multicast packets received. This register does not count multicast packets received that fail to pass address filtering nor does it count received flow control packets. This register only increments if receives are enabled. This register does not count packets counted by the Missed Packet Count (MPC) register. Packets sent to the manageability engine are included in this counter.

Field	Bit(s)	Initial Value	Description
MPRC	31:0	0b	Number of multicast packets received.

## 14.9.28 Good Packets Transmitted Count - GPTC (04080h; RC)

This register counts the number of good (no errors) packets transmitted. A good transmit packet is considered one that is 64 or more bytes in length (from <Destination Address> through <CRC>, inclusively) in length. This does not include transmitted flow control packets. This register only increments if transmits are enabled. The register counts clear as well as secure packets.

Field	Bit(s)	Initial Value	Description
GPTC	31:0	0b	Number of good packets transmitted.



## 14.9.29 Good Octets Received Count - GORCL (04088h; RC)/GORCH (0408Ch; RC)

These registers make up a 64-bit register that counts the number of good (no errors) octets received. This register includes bytes received in a packet from the <Destination Address> field through the <CRC> field, inclusively. This register resets each time the upper 32 bits are read (GORCH).

In addition, it sticks at FFFFh\_FFFFh\_FFFFh\_FFFFh when the maximum value is reached. Only octets of packets that pass address filtering are counted in this register. This register does not count octets of packets counted by the Missed Packet Count (MPC) register. Octets of packets sent to the manageability engine are included in this counter. This register only increments if receives are enabled.

These octets do not include octets of received flow control packets.

Field	Bit(s)	Initial Value	Description
GORCL	31:0	0b	Number of good octets received – lower 4 bytes.
GORCH	31:0	0b	Number of good octets received – upper 4 bytes.

## 14.9.30 Good Octets Transmitted Count - GOTCL (04090h; RC)/ GOTCH (04094; RC)

These registers make up a 64-bit register that counts the number of good (no errors) packets transmitted. This register must be accessed using two independent 32-bit accesses. This register resets each time the upper 32 bits are read (GOTCH).

In addition, it sticks at FFFF\_FFFF\_FFFF\_FFFFh when the maximum value is reached. This register includes bytes transmitted in a packet from the <Destination Address> field through the <CRC> field, inclusively. This register counts octets in successfully transmitted packets that are 64 or more bytes in length. This register only increments if transmits are enabled. The register counts clear as well as secure octets.

These octets do not include octets in transmitted flow control packets.

Field	Bit(s)	Initial Value	Description
GOTCL	31:0	0b	Number of good octets transmitted – lower 4 bytes.
GOTCH	31:0	0b	Number of good octets transmitted – upper 4 bytes.

## 14.9.31 Receive No Buffers Count - RNBC (040A0h; RC)

This register counts the number of times that frames were received when there were no available buffers in host memory to store those frames (receive descriptor head and tail pointers were equal). The packet is still received if there is space in the FIFO. This register only increments if receives are enabled.

This register does not increment when flow control packets are received.





Field	Bit(s)	Initial Value	Description
RNBC	31:0	0b	Number of receive no buffer conditions.

### 14.9.32 Receive Undersize Count - RUC (040A4h; RC)

This register counts the number of received frames that passed address filtering, and were less than minimum size (64 bytes from <Destination Address> through <CRC>, inclusively), and had a valid CRC. This register only increments if receives are enabled.

Field	Bit(s)	Initial Value	Description
RUC	31:0	0b	Number of receive undersize errors.

### 14.9.33 Receive Fragment Count - RFC (040A8h; RC)

This register counts the number of received frames that passed address filtering, and were less than minimum size (64 bytes from <Destination Address> through <CRC>, inclusively), but had a bad CRC (this is slightly different from the Receive Undersize Count register). This register only increments if receives are enabled.

Field	Bit(s)	Initial Value	Description
RFC	31:0	0b	Number of receive fragment errors.

### 14.9.34 Receive Oversize Count - ROC (040ACh; RC)

This register counts the number of received frames with valid CRC field that passed address filtering, and were greater than maximum size. Packets over 1522 bytes are oversized if LongPacketEnable (RCTL.LPE) is 0b. If LongPacketEnable is 1b, then an incoming packet is considered oversized if it exceeds 16384 bytes.

If receives are not enabled, this register does not increment. These lengths are based on bytes in the received packet from <Destination Address> through <CRC>, inclusively.

**Note:** The maximum size of a packet when LPE is 0b is fixed according to the CTRL\_EXT.Extended\_VLAN bit and the detection of a VLAN tag in the packet.

Field	Bit(s)	Initial Value	Description
ROC	31:0	0b	Number of receive oversize errors.

### 14.9.35 Receive Jabber Count - RJC (040B0h; R)

This register counts the number of received frames that passed address filtering, and were greater than maximum size and had a bad CRC (this is slightly different from the Receive Oversize Count register).



Packets over 1518/1522/1526 bytes are oversized if LPE is 0b. If LPE is 1b, then an incoming packet is considered oversized if it exceeds RLPML.LPML bytes.

If receives are not enabled, this register does not increment. These lengths are based on bytes in the received packet from <Destination Address> through <CRC>, inclusively.

**Note:** The maximum size of a packet when LPE is 0b is fixed according to the CTRL\_EXT.Extended\_VLAN bit and the detection of a VLAN tag in the packet.

Field	Bit(s)	Initial Value	Description
RJC	31:0	0b	Number of receive jabber errors.

### 14.9.36 Management Packets Received Count - MNGPRC (040B4h; RC)

This register counts the total number of packets received that pass the management filters as described in the Total Cost of Ownership (TCO) System Management Bus Interface Application Note. Any packets with errors are not counted, except packets that are dropped because the management receive FIFO is full.

Field	Bit(s)	Initial Value	Description
MNGPRC	31:0	0b	Number of management packets received.

### 14.9.37 Management Packets Dropped Count - MPDC (040B8h; RC)

This register counts the total number of packets received that pass the management filters as described in the Total Cost of Ownership (TCO) System Management Bus Interface Application Note and then are dropped because the management receive FIFO is full. Management packets include any packet directed to the manageability console (for example, BMC and ARP packets).

Field	Bit(s)	Initial Value	Description
MPDC	31:0	0b	Number of management packets dropped.

### 14.9.38 Management Packets Transmitted Count - MNGPTC (040BCh; RC)

This register counts the total number of transmitted packets originating from the manageability path.

Field	Bit(s)	Initial Value	Description
MPTC	31:0	0b	Number of management packets transmitted.



## 14.9.39 Total Octets Received - TORL (040C0h; RC) / TORH (040C4h; RC)

These registers make up a logical 64-bit register which counts the total number of octets received. This register must be accessed using two independent 32-bit accesses. This register resets each time the upper 32 bits are read (TORH). In addition, it sticks at FFFF\_FFFF\_FFFF\_FFFFh when the maximum value is reached.

All packets received have their octets summed into this register, regardless of their length, whether they are erred, or whether they are flow control packets. This register includes bytes received in a packet from the <Destination Address> field through the <CRC> field, inclusively. This register only increments if receives are enabled.

**Note:** Broadcast rejected packets are counted in this counter (as opposed to all other rejected packets that are not counted).

Field	Bit(s)	Initial Value	Description
TORL	31:0	0b	Number of total octets received – lower 4 bytes.
TORH	31:0	0b	Number of total octets received – upper 4 bytes.

## 14.9.40 Total Octets Transmitted - TOTL (040C8h; RC) / TOTH (040CCh; RC)

These registers make up a 64-bit register that counts the total number of octets transmitted. This register must be accessed using two independent 32-bit accesses. This register resets each time the upper 32 bits are read (TOTH). In addition, it sticks at FFFF\_FFFF\_FFFF\_FFFFh when the maximum value is reached.

All transmitted packets have their octets summed into this register, regardless of their length or whether they are flow control packets. This register includes bytes transmitted in a packet from the <Destination Address> field through the <CRC> field, inclusively.

Octets transmitted as part of partial packet transmissions (for example, collisions in half-duplex mode) are not included in this register. This register only increments if transmits are enabled.

Field	Bit(s)	Initial Value	Description
TOTL	31:0	0b	Number of total octets transmitted – lower 4 bytes.
TOTH	31:0	0b	Number of total octets transmitted – upper 4 bytes.

## 14.9.41 Total Packets Received - TPR (040D0h; RC)

This register counts the total number of all packets received. All packets received are counted in this register, regardless of their length, whether they have errors, or whether they are flow control packets. This register only increments if receives are enabled.

**Note:** Broadcast rejected packets are counted in this counter (as opposed to all other rejected packets that are not counted).

TPR can count packets interrupted by a link disconnect although they have a CRC error.



Field	Bit(s)	Initial Value	Description
TPR	31:0	0b	Number of all packets received.

#### 14.9.42 Total Packets Transmitted - TPT (040D4h; RC)

This register counts the total number of all packets transmitted. All packets transmitted are counted in this register, regardless of their length, or whether they are flow control packets.

Partial packet transmissions (collisions in half-duplex mode) are not included in this register. This register only increments if transmits are enabled. This register counts all packets, including standard packets, secure packets, packets received over the SMBus.

Field	Bit(s)	Initial Value	Description
TPT	31:0	0b	Number of all packets transmitted.

#### 14.9.43 Packets Transmitted (64 Bytes) Count - PTC64 (040D8h; RC)

This register counts the number of packets transmitted that are exactly 64 bytes (from <Destination Address> through <CRC>, inclusively) in length. Partial packet transmissions (collisions in half-duplex mode) are not included in this register. This register does not include transmitted flow control packets (which are 64 bytes in length). This register only increments if transmits are enabled. This register counts all packets, including standard packets, secure packets

Field	Bit(s)	Initial Value	Description
PTC64	31:0	0b	Number of packets transmitted that are 64 bytes in length.

#### 14.9.44 Packets Transmitted (65-127 Bytes) Count - PTC127 (040DCh; RC)

This register counts the number of packets transmitted that are 65-127 bytes (from <Destination Address> through <CRC>, inclusively) in length. Partial packet transmissions (for example, collisions in half-duplex mode) are not included in this register. This register only increments if transmits are enabled. This register counts all packets, including standard packets, secure packets, packets received over the SMBus.

Field	Bit(s)	Initial Value	Description
PTC127	31:0	0b	Number of packets transmitted that are 65-127 bytes in length.



### 14.9.45 Packets Transmitted (128-255 Bytes) Count - PTC255 (040E0h; RC)

This register counts the number of packets transmitted that are 128-255 bytes (from <Destination Address> through <CRC>, inclusively) in length. Partial packet transmissions (collisions in half-duplex mode) are not included in this register. This register only increments if transmits are enabled. This register counts all packets, including standard packets, secure packets.

Field	Bit(s)	Initial Value	Description
PTC255	31:0	0b	Number of packets transmitted that are 128-255 bytes in length.

### 14.9.46 Packets Transmitted (256-511 Bytes) Count - PTC511 (040E4h; RC)

This register counts the number of packets transmitted that are 256-511 bytes (from <Destination Address> through <CRC>, inclusively) in length. Partial packet transmissions (for example, collisions in half-duplex mode) are not included in this register. This register only increments if transmits are enabled. This register counts all packets, including standard and secure packets. Management packets must never be more than 200 bytes.

Field	Bit(s)	Initial Value	Description
PTC511	31:0	0b	Number of packets transmitted that are 256-511 bytes in length.

### 14.9.47 Packets Transmitted (512-1023 Bytes) Count - PTC1023 (040E8h; RC)

This register counts the number of packets transmitted that are 512-1023 bytes (from <Destination Address> through <CRC>, inclusively) in length. Partial packet transmissions (for example, collisions in half-duplex mode) are not included in this register. This register only increments if transmits are enabled. This register counts all packets, including standard and secure packets. Management packets must never be more than 200 bytes.

Field	Bit(s)	Initial Value	Description
PTC1023	31:0	0b	Number of packets transmitted that are 512-1023 bytes in length.

### 14.9.48 Packets Transmitted (1024 Bytes or Greater) Count - PTC1522 (040ECh; RC)

This register counts the number of packets transmitted that are 1024 or more bytes (from <Destination Address> through <CRC>, inclusively) in length. Partial packet transmissions (for example, collisions in half-duplex mode) are not included in this register. This register only increments if transmits are enabled.



Due to changes in the standard for maximum frame size for VLAN tagged frames in 802.3, the 82575 transmits packets that have a maximum length of 1522 bytes. The RMON statistics associated with this range has been extended to count 1522 byte long packets. This register counts all packets, including standard and secure packets (management packets must never be more than 200 bytes). If CTRL.Extended\_VLAN is set, packets up to 1526 bytes are counted by this counter.

Field	Bit(s)	Initial Value	Description
PTC1522	31:0	0b	Number of packets transmitted that are 1024 or more bytes in length.

### 14.9.49 Multicast Packets Transmitted Count - MPTC (040F0h; RC)

This register counts the number of multicast packets transmitted. This register does not include flow control packets and increments only if transmits are enabled. Counts clear as well as secure traffic.

Field	Bit(s)	Initial Value	Description
MPTC	31:0	0b	Number of multicast packets transmitted.

### 14.9.50 Broadcast Packets Transmitted Count - BPTC (040F4h; RC)

This register counts the number of broadcast packets transmitted. This register only increments if transmits are enabled. This register counts all packets, including standard and secure packets (management packets must never be more than 200 bytes).

Field	Bit(s)	Initial Value	Description
BPTC	31:0	0b	Number of broadcast packets transmitted count.

### 14.9.51 TCP Segmentation Context Transmitted Count - TSCTC (040F8h; RC)

This register counts the number of TCP segmentation offload transmissions and increments once the last portion of the TCP segmentation context payload is segmented and loaded as a packet into the on-chip transmit buffer. Note that it is not a measurement of the number of packets sent out (covered by other registers). This register only increments if transmits and TCP segmentation offload are enabled.

This counter only counts pure TSO transmissions.

Field	Bit(s)	Initial Value	Description
TSCTC	31:0	0b	Number of TCP Segmentation contexts transmitted count.



### 14.9.52 Interrupt Assertion Count - IAC (04100h; RC)

This counter counts the total number of LAN interrupts generated in the system. In case of MSI-X systems, this counter reflects the total number of MSI-X messages that are emitted.

Field	Bit(s)	Initial Value	Description
IAC	31:0	0b	This is a count of all the LAN interrupt assertions that have occurred.

### 14.9.53 Rx Packets to Host Count - RPHTC (04104h; RC)

Field	Bit(s)	Initial Value	Description
RPHTC	31:0	0b	This is a count of all the received packets sent to the host.

### 14.9.54 Transmit Queue Empty Count - TXQEC (04118h; RC)

Field	Bit(s)	Initial Value	Description
TXQEC	31:0	0b	This is a count of the transmit queue empty events.

### 14.9.55 Receive Descriptor Minimum Threshold Count - RXDMTC (04120h; RC)

Field	Bit(s)	Initial Value	Description
RXDMTC	31:0	0b	This is a count of the receive descriptor minimum threshold events.

### 14.9.56 Interrupt Cause Receiver Overrun Count - ICRXOC (04124h; RC)

Field	Bit(s)	Initial Value	Description
ICRXOC	31:0	0b	This is a count of the receive overrun interrupt events that have generated interrupts.



## 14.9.57 SerDes/SGMII Code Violation Packet Count - SCVPC (04228h; R/WS)

This register contains the number of code violation packets received on a particular GbE port. Code violation is defined as a invalid received code in the middle of a packet.

Field	Bit(s)	Initial Value	Description
CODEVIO	31:0	X	Code Violation Packet Count At any point of time this field specifies the number of unknown protocol packets received. Valid only in SGMII/SerDes mode.

## 14.10 Diagnostics Registers

The 82575 contains several diagnostic registers. These registers enable software to directly access the contents of the 82575's internal Packet Buffer Memory (PBM), also referred to as FIFO space. These registers also give software visibility into what locations in the PBM that the hardware currently considers to be the "head" and "tail" for both transmit and receive operations.

### 14.10.1 Receive Data FIFO Head Register - RDFH (02410h; RO)

This register stores the head of the on-chip receive data FIFO. Since the internal FIFO is organized in units of 64-bit words, this field contains the 64-bit offset of the current Receive FIFO Head. So a value of "8h" in this register corresponds to an offset of 8 Qwords into the Receive FIFO space. This register is available for diagnostic purposes only, and should not be written during normal operation.

Field	Bit(s)	Initial Value	Description
FIFO Head	12:0	0b	Receive FIFO Head pointer.
Reserved	30:13	0b	Reads as 0b. Should be written to 0b for future compatibility.
FIFO Full	31	0b	Rx Memory Full Signal

### 14.10.2 Receive Data FIFO Tail Register - RDFT (02418h; RO)

This register stores the tail of the on-chip receive data FIFO. Since the internal FIFO is organized in units of 64-bit words, this field contains the 64-bit offset of the current Receive FIFO Tail. So a value of "8h" in this register corresponds to an offset of eight Qwords or into the Receive FIFO space. This register is available for diagnostic purposes only, and should not be written during normal operation.

Field	Bit(s)	Initial Value	Description
FIFO Tail	12:0	0b	Receive FIFO Tail pointer.
Reserved	31:13	0b	Reads as 0b. Should be written to 0b for future compatibility.





### 14.10.3 Receive Data FIFO Head Saved Register - RDFHS (02420h; RO)

This register stores a copy of the Receive Data FIFO Head register in case the internal register needs to be restored. This register is available for diagnostic purposes only, and should not be written during normal operation.

Field	Bit(s)	Initial Value	Description
FIFO Head	12:0	0b	A "saved" value of the Receive FIFO Head pointer.
Reserved	31:13	0b	Reads as 0b. Should be written to 0b for future compatibility.

### 14.10.4 Receive Data FIFO Tail Saved Register - RDFTS (02428h; RO)

This register stores a copy of the Receive Data FIFO Tail register in case the internal register needs to be restored. This register is available for diagnostic purposes only, and should not be written during normal operation.

Field	Bit(s)	Initial Value	Description
FIFO Tail	12:0	0b	A "saved" value of the Receive FIFO Tail pointer.
Reserved	31:13	0b	Reads as 0b. Should be written to 0b for future compatibility.

### 14.10.5 Receive Data FIFO Packet Count - RDFPCQ (02430h + 4 \* n [n=0..3]; RO)

These registers reflect the number of receive packets that are currently in the Receive FIFO that are dedicated to a given queue.

This counter is reset when the Rx path is enabled by asserting RCTL.RXEN.

- Queue 0 - RDFPCQ0 (02430h; R/W)
- Queue 1 - RDFPCQ1 (02434h; R/W)
- Queue 2 - RDFPCQ2 (02438h; R/W)
- Queue 3 - RDFPCQ3 (0243Ch; R/W)

Field	Bit(s)	Initial Value	Description
RX FIFO Packet Count	11:0	0b	The number of received packets currently in the Rx FIFO.
Reserved	31:12	0b	Reads as 0b. Should be written to 0b for future compatibility.



## 14.10.6 PB Descriptor Read Pointers - PBDESCRP (02454h; RO)

Field	Bit(s)	Initial Value	Description
rx_desc_rd_ptr	15:0	0h	Rx descriptor read pointer value.
Reserved	31:16	0h	Reserved.

## 14.10.7 Packet Buffer Diagnostic - PBDIAG (02458h; R/W)

Field	Bit(s)	Initial Value	Description
Rx_win_threshold	11:0	600h	Threshold in (qwords) of Rx FIFO for arbitration. If the Rx FIFO has more data than this threshold then the Rx logic wins the arbitration for writing a header to the header FIFO. 24 KB is the default.
Reserved	15:12	-	Reserved.
Reserved	19:16	0010b	Reserved.
DBU_empty (RO)	20	-	All FIFOs (Rx and Tx) are empty.
Cfg_rx_wait	21	0b	Stop reading data from the receive data buffer to the DMA Rx machine. Diagnostic only.
Cfg_tx_wait	22	0b	Stop reading data from the transmit data buffer towards the TX MAC. Diagnostic only
Far End Loopback	23	0b	Enable far end loopback at the packet buffer. 0b = Disable. 1b = Enable.
Reserved	25:24	00b	Reserved Always set to 00b.
Reserved	28:26	000b	Reserved Must be written with 000b.
STAT_SEL	31:29	0h	

## 14.10.8 Transmit Data FIFO Head Register - TDFH (03410h; RO)

This register stores the head of the on-chip transmit data FIFO. Since the internal FIFO is organized in units of 64-bit words, this field contains the 64-bit offset of the current Transmit FIFO Head. A value of 8h in this register corresponds to an offset of 8 Qwords into the Transmit FIFO space. This register is available for diagnostic purposes only, and should not be written during normal operation.

Field	Bit(s)	Initial Value	Description
-------	--------	---------------	-------------



FIFO Head	12:0	0b	Transmit FIFO Head pointer. Note that the initial value equals PBA.RXA times 128.
Reserved	30:13	10000h	Reads as 0b. Should be written to 0b for future compatibility.
Tx Memory Full	31	0b	Tx FIFO memory full indication.

### 14.10.9 Transmit Data FIFO Tail Register - TDFT (03418h; R/WS)

This register stores the head of the on-chip transmit data FIFO. Since the internal FIFO is organized in units of 64-bit words, this field contains the 64-bit offset of the current Transmit FIFO Tail. A value of 8h in this register corresponds to an offset of 8 Qwords into the Transmit FIFO space. This register is available for diagnostic purposes only, and should not be written during normal operation.

Field	Bit(s)	Initial Value	Description
FIFO Tail	12:0	0h	Transmit FIFO tail pointer. Note that after reset, the initial value is 0b. After Tx is enabled, the initial value equals PBA.RXA times 64.
Reserved	31:13	0h	Reads as 0b. Should be written to 0b for future compatibility.

### 14.10.10 Transmit Data FIFO Head Saved Register - TDFHS (03420h; R/WS)

This register stores a copy of the Transmit Data FIFO Head register in case that internal register needs to be restored. This register points to the header of the last packet in the packet buffer, even if it was already transmitted. This register is available for diagnostic purposes only, and should not be written during normal operation.

Field	Bit(s)	Initial Value	Description
FIFO Head	12:0	0b	Transmit FIFO Last Packet Header Pointer Note that after reset, the initial value is 0b. After Tx is enabled, initial value equals PBA.RXA times 64.
Reserved	31:13	0b	Reads as 0b. Should be written to 0b for future compatibility.

### 14.10.11 Transmit Data FIFO Tail Saved Register - TDFTS (03428h; R/WS)

This register stores a copy of the Transmit Data FIFO Tail register in case the internal register needs to be restored. This register points to the tail of the last packet in the packet buffer, even if it was already transmitted. This register is available for diagnostic purposes only, and should not be written during normal operation.

Field	Bit(s)	Initial Value	Description
FIFO Tail	12:0	0b	Transmit FIFO Last Packet Tail Pointer Note that after reset, the initial value is 0b. After Tx is enabled, initial value equals PBA.RXA times 64.
Reserved	31:13	0b	Reads as 0b. Should be written to 0b for future compatibility.



## 14.10.12 Transmit Data FIFO Packet Count - TDFPC (03430h; RO)

This register reflects the number of packets to be transmitted that are currently in the Transmit FIFO. This register is available for diagnostic purposes only, and should not be written during normal operation.

This counter is reset when the Tx path is enabled by asserting TCTL.EN.

Field	Bit(s)	Initial Value	Description
TX FIFO Packet Count	11:0	0h	The number of packets to be transmitted that are currently in the TX FIFO.
Reserved	31:12	0h	Reads as 0b. Should be written to 0b for future compatibility.

## 14.10.13 Packet Buffer ECC Error Inject - PBEEI (03438h; RO)

Field	Bit(s)	Initial Value	Description
Tx Header Injection Enable	0	0b	Inject an Error on Tx Buffer on Header Line When this bit is set an error is injected in the next write cycle to a header line of the Tx buffer. Auto cleared by hardware when an error is injected.
Tx Data Injection Enable	1	0b	Inject an Error on Tx Buffer on Data Line When this bit is set an error is injected in the next write cycle to a data line of the Tx buffer. Auto cleared by hardware when an error is injected.
Rx Header Injection Enable	2	0b	Inject an Error on Rx Buffer on Header Line When this bit is set an error is injected in the next write cycle to a header line of the Rx buffer. Auto cleared by hardware when an error is injected.
Rx Data Injection Enable	3	0b	Inject an Error on Rx Buffer on Data Line When this bit is set an error is injected in the next write cycle to a data line of the Rx buffer. Auto cleared by hardware when an error is injected.
Reset Data	4	0b	Reset Data Clears all bits in the data line on which the error is inserted.
Reserved	15:5	0h	Reserved
Error1 Bit Location	23:16	FFh	No Error Injection on This Bit Maximum allowed value is 135 for error injection.
Error2 Bit Location	31:24	FFh	No Error Injection on This Bit Maximum allowed value is 135 for error injection.

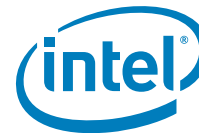

## 14.10.14 Tx Descriptor Handler ECC Error Inject - TDHEEI (035F8h; R/W)

Field	Bit(s)	Initial Value	Description
Descriptor Fetch Injection Enable	0	0b	Descriptor Fetch Injection Enable When this bit is set, an error is injected the next time the Tx descriptor handler fetches a descriptor for DMA processing. This bit is auto cleared by hardware when an error is injected.
Descriptor Writeback Injection Enable (WC)	1	0b	Descriptor Writeback Injection Enable When this bit is set, an error is injected the next time the Tx descriptor handler fetches a descriptor for DMA processing. This bit is auto cleared by hardware when an error is injected.
Reset Data	2	0b	Reset Data Clears all bits in the data line on which the error is inserted.
Reserved	15:3	0h	Reserved
Error1 Bit Location	23:16	FFh	No Error Injection on This Bit Maximum allowed value is 135 for error injection.
Error2 Bit Location	31:24	FFh	No Error Injection on This Bit Maximum allowed value is 135 for error injection.

## 14.10.15 Rx Descriptor Handler ECC Error Inject - RDHEEI (025F8h; R/W)

Field	Bit(s)	Initial Value	Description
Descriptor Fetch Injection Enable	0	0b	Descriptor Fetch Injection Enable When this bit is set, an error is injected the next time the Rx descriptor handler fetches a descriptor for DMA processing. This bit is auto cleared by hardware when an error is injected.
Descriptor Writeback Injection Enable (WC)	1	0b	Descriptor Writeback Injection Enable When this bit is set, an error is injected the next time the Rx descriptor handler fetches a descriptor for DMA processing. This bit is auto cleared by hardware when an error is injected.
Reset Data	2	0b	Reset Data Clears all bits in the data line on which the error is inserted.
Reserved	15:3	0h	Reserved
Error1 Bit Location	23:16	FFh	No Error Injection on This Bit Maximum allowed value is 135 for error injection.
Error2 Bit Location	31:24	FFh	No Error Injection on This Bit Maximum allowed value is 135 for error injection.



## 14.10.16 Packet Buffer Memory - PBM (10000h - 10FFCh; R/W)

All PBM (FIFO) data is available to diagnostics. Locations can be accessed as 32-bit or 64-bit words.

The packet buffer line is 128 bits. In order to write to the packet buffer programmers should write four times in a row (for example, to addresses 10000h, 10004h, 10008h, and 1000Ch). Only after writing the last address can data be loaded and the new value read.

The internal PBM is 48 KB in size. Software can configure the amount of PBM space that is used as the transmit FIFO versus the receive FIFO. The default is 14 KB of transmit FIFO space and 34 KB of receive FIFO space. Regardless of the individual FIFO sizes that software configures, the Rx FIFO is located first in the memory mapped PBM space. For the default FIFO configuration, the Rx FIFO occupies the first 34 KB of the packet buffer while the Tx FIFO occupies the last 14 KB of the packet buffer.

**Note:** The packet buffer is accessible by pages of 4 KB. This accessed page is set in the PBMPN register.

Field	Bit(s)	Initial Value	Description
FIFO Data	31:0	X	Packet Buffer Data

## 14.10.17 Packet Buffer Memory Page NPBMPN Register Bit Description

Field	Bit(s)	Initial Value	Description
Page	5:0	0h	Packet Buffer Accessed Page (4 KB) Allowed values for the 82575 are 00h:0Bh
Reserved	31:6	0h	Reserved

## 14.10.18 Rx Descriptor Handler Memory Page Number - RDHMP (025FCh; R/W)

Field	Bit(s)	Initial Value	Description
Page	3:0	0h	Rx Descriptor Handler Accessed Page (4KB) Only allowed value for the 82575 is zero.
Reserved	27:4	0h	Reserved



Freeze	28	0b	Stop Descriptor Handler When set, the descriptor handler stops at the next stable point. This allows reading of coherent values of all registers.
Reserved	29	0b	Reserved
Queue Depth	31:30	00b	Defines the number of descriptors (per queue) in the cache. 00b = 64 descriptors 01b = 32 descriptors 10b = 16 descriptors 11b = 8 descriptors

**Note:** The queue depth field must be updated before the receive queues are enabled (before writing to any CSR that controls the queues).

### 14.10.19 Tx Descriptor Handler Memory Page Number - TDHMP (035FCh; R/W)

Field	Bit(s)	Initial Value	Description
Page	3:0	0h	Tx Descriptor Handler Accessed Page (4KB) Only allowed value for the 82575 is zero.
Reserved	27:4	0h	Reserved
Freeze	28	0b	Stop Descriptor Handler When set, the descriptor handler stops at the next stable point. This allows reading of coherent values of all registers.
Reserved	29	0b	Reserved
Queue Depth	31:30	00b	Defines the number of descriptors (per queue) in the cache. 00b = 64 descriptors 01b = 32 descriptors 10b = 16 descriptors 11b = 8 descriptors

**Note:** The queue depth field must be updated before the receive queues are enabled (before writing to any CSR that controls the queues).



## 14.10.20 Packet Buffer ECC Status - PBECCSTS (0245Ch; R/W)

Field	Bit(s)	Initial Value	Description
Corr_err_cnt	7:0	0h	Correctable Error Count This counter is increment every time a correctable error is detected; the counter stops after reaching FFh. These bits are cleared by reads.
Uncorr_err_cnt	15:8	0h	Uncorrectable Error Count This counter is increment every time an uncorrectable error is detected; the counter stops after reaching FFh. These bits are cleared by reads.
ECC Enable (RW)	16	1b	ECC Enable for Packet Buffer
Reserved	25:17	0b	Reserved
Pb_cor_err_sta	26	0b	Status of PB Correctable Error This bit is cleared by a read.
Pb_uncor_err_sta	27	0b	Status of PB Uncorrectable Error This bit is cleared by a read.
rx_desch_cor_err_sts	28	0b	Status of Rx Descriptor Handler Correctable Error This bit is cleared by a read.
rx_desch_uncor_err_sts	29	0b	Status of Rx Descriptor Handler Uncorrectable Error This bit is cleared by a read.
tx_desch_cor_err_sts	30	0b	Status of Tx Descriptor Handler Correctable Error This bit is cleared by a read.
tx_desch_uncor_err_sts	31	0b	Status of Tx Descriptor Handler Uncorrectable Error This bit is cleared by a read.

## 14.10.21 Rx Descriptor Handler ECC Status - RDHESTS (02468h; R/W)

Field	Bit(s)	Initial Value	Description
Corr_err_cnt	7:0	0h	Correctable Error Count This counter is increment every time a correctable error is detected in the Rx descriptor handler memory; the counter stops after reaching FFh. These bits are cleared by reads.
Uncorr_err_cnt	15:8	0h	Uncorrectable Error Count This counter is increment every time a correctable error is detected in the Rx descriptor handler memory; the counter stops after reaching FFh. These bits are cleared by reads.
RDHECC Enable	16	1b	Rx Descriptor Handler ECC Enable
Reserved	31:17	0b	Reserved





## 14.10.22 Tx Descriptor Handler ECC Status - TDHESTS (0246Ch; R/W)

Field	Bit(s)	Initial Value	Description
Corr_err_cnt	7:0	0h	Correctable Error Count This counter is increment every time a correctable error is detected in the Tx descriptor handler memory; the counter stops after reaching FFh. These bits are cleared by reads.
Uncorr_err_cnt	15:8	0h	Uncorrectable Error Count This counter is increment every time a correctable error is detected in the Tx descriptor handler memory; the counter stops after reaching FFh. These bits are cleared by reads.
TDHECC Enable	16	1b	Tx Descriptor Handler ECC Enable
Reserved	31:17	0b	Reserved

## 14.11 Packet Generator Registers

This section contains detailed descriptions for those registers associated with the 82575's packet generator capabilities.

### 14.11.1 Packet Generator Destination Address Low - PGDAL (04280h; R/W)

Field	Bit(s)	Initial Value	Description
DA	31:0	0h	Packet Generator Destination Address Low The lower 32 bits of the 48 bit Ethernet destination address used for packets sent by the packets generator.

### 14.11.2 Packet Generator Destination Address High - PGDAH (04284h; R/W)

Field	Bit(s)	Initial Value	Description
DA	15:0	0h	Packet Generator Destination Address High The higher 16 bits of the 48-bit Ethernet destination address used for packets sent by the packets generator.
Reserved	31:16	0h	Reserved



### 14.11.3 Packet Generator Source Address Low - PGSAL (04288h; R/W)

Field	Bit(s)	Initial Value	Description
DA	31:0	0h	Packet Generator Source Address Low The lower 32 bits of the 48-bit Ethernet destination address used for packets sent by the packets generator.

### 14.11.4 Packet Generator Source Address High - PGSAH (0428Ch; R/W)

Field	Bit(s)	Initial Value	Description
DA	15:0	0h	Packet Generator Source Address High The higher 16 bits of the 48-bit Ethernet destination address used for packets sent by the packets generator.
Reserved	31:16	0h	Reserved

### 14.11.5 Packet Generator Inter Packet Gap - PGIPG (04290h; R/W)

Field	Bit(s)	Initial Value	Description
Min IPG	15:0	0h	Minimum IPG Minimum gap between packets sent by the packet generator.
Max IPG	31:16	0h	Maximum IPG Maximum gap between packets sent by the packet generator. Any configuration below 22 (20 if CRC is not added) results in the minimum IPG on the line.

The actual gap between consecutive packets is a random value between min IPG and max IPG determined according to a 16 bit LFSR.

The LFSR polynomial used is  $X^{16} + X^{10} + X^7 + X^1$ . Seed: 16'hFFFF

In order to get a constant rate, min IPG should be equal to max IPG.

Min IPG should always be smaller or equal to max IPG.



## 14.11.6 Packet Generator Packet Length - PGPL (04294h; R/W)

Field	Bit(s)	Initial Value	Description
Min Data Length	15:0	0h	Minimum Data Length The minimum size of the data in packets sent by the packet generator. The minimum value allowed for this field is 1.
Max Data Length	31:16	0h	Maximum Data Length The maximum size of the data in packets sent by the packet generator. The maximum value allowed for this field is 9 KB.

The actual boundaries for the packet size are the sizes defined in this registers + 16 bytes of header (DA, SA, Length, 00).

The actual size for a given packet data is a value between min data length and max data length determined by PGCTL.length\_mode.

When using an LFSR, the polynomial used is  $X^{16} + X^{10} + X^7 + X^1$ . Seed: 16'hFFFF

In order to get a constant size, min data length should be equal to max data length.

Min data length should always be smaller or equal to max data length.

If padding is enabled by TCTL.PSP, the minimum packet size on the network is 64 bytes.

## 14.11.7 Packet Generator Number of Packets - PGNP (04298h; R/W)

Field	Bit(s)	Initial Value	Description
Number of Packets	15:0	0h	Number of Packets to Send A value of FFFFh equals packets continuously sent.
LFSR_LEN_SIZE	20:16	0h	LFSR Length Size Number of bits used for LFSR pseudo random generator used to generate the packet length.
Reserved	22:21	00b	Reserved
LFSR_IPG_SIZE	27:23	0h	LFSR IPG Size Number of bits used for LFSR pseudo random generator used to generate the inter packet gap.
Reserved	28	0b	Reserved
Stop	29	0b	Stop Stop to send packets - useful when the number of packets is unlimited.
Start Tx (SC)	30	0b	Start Tx Start to send packets.
Start Rx (SC)	31	0b	Start Rx Start to receive packets.



## 14.11.8 Packet Generator StaPGSTS Bit Description

Field	Bit(s)	Initial Value	Description
Fail Data	0	0b	Fail Data The data received is different than the data expected.
Fail Header	1	0b	Fail Header The header received is different than the header expected (DA and SA).
Fail Length	2	0b	Fail Header The length field received is different than the length field expected.
Receive Done	3	0b	Receive Done Receive process done. Cleared when PGNP.Start is set.
Transmit Done	4	0b	Transmit Done Transmit process done. Cleared when PGNP.Start is set.
Reserved	15:5	0h	Reserved
NRCVPK	31:16	0h	Number of Received Packets

## 14.11.9 Packet Generator ContPGCTL Bit Description

Field	Bit(s)	Initial Value	Description
PG Mode	0	0b	Packet Generator Mode When set, the source of packets sent to the network is the packet generator. When cleared, the packets from the host or manageability are used to feed the MAC.
Add CRC	1	1b	Add CRC 1b = Added by MAC. 0b = No CRC added.
Destination	3:2	00b	Destination of Packets 00b = Send To MAC. 01b = Reserved. 10b = Send to MAC and MNG. 10b = Send to MNG.
Length	4	0b	Length Mode Defines the algorithm used to determine the packet length. 0b = Incremental. 1b = Use LFSR output.



Data Mode	6:5	00b	Data Mode Defines the algorithm used to determine the data content: 00b = Constant: All the data is equal to PGCTL.data_const field. 01b = Incremental: Each word is incremented by 1 relative to the previous word. The value of the first word of the packet is the packet index modulo 65356 (where the index of the first packet sent after start is asserted is zero). 10b = Use 16-bit LFSR output. The polynomial of the LFSR is $X^{16} + X^{10} + X^7 + X^1$ and the seed is 16'hFFFF. The LFSR is shifted every 4th word and provides the value for the next four words (for example, each four consecutive words have the same value). The LFSR is reset when PGNP.Start is asserted, but is not reset between packets. 11b = Reserved.
Stop on Error	7	0b	Stop on Error Stop sending packets when an error is found by the receive side.
Reserved	15:8	0h	Reserved
Constant Data	31:16	0h	Constant Data The data used when Data Mode = 00b.

## 14.12 MSI-X Registers

These registers are used to configure the MSI-X mechanism. The address and upper address registers sets the address for each of the vectors. The message register sets the data sent to the relevant address. The vector control registers are used to enable specific vectors.

The pending bit array register indicates which vectors have pending interrupts.

The structure is listed in [Table 93](#).

**Table 93. MSI-X Table Structure**

DWORD3	DWORD2	DWORD1	DWORD0		
Vector Control	Msg Data	Msg Upper Addr	Msg Addr	Entry 0	Base
Vector Control	Msg Data	Msg Upper Addr	Msg Addr	Entry 1	Base + 1*16
Vector Control	Msg Data	Msg Upper Addr	Msg Addr	Entry 2	Base + 2*16
...	...	...	...	...	...
Vector Control	Msg Data	Msg Upper Addr	Msg Addr	Entry (N-1)	Base + (N-1) *16

**Note:** N = 10.

63:0

Pending Bits 0 through 63	QWORD0	Base
Pending Bits 64 through 127	QWORD1	Base+1*8
...	...	...
Pending Bits ((N-1) div 64)*64 through N-1	QWORD((N-1) div 64)	BASE + ((N-1) div 64)*8

**Note:** N = 10. As a result, only QWORD0 is implemented.



### 14.12.1 MSI-X Table Entry Lower Address - MSIXTADD (00000h - 00090h; R/W)

Field	Bit(s)	Initial Value	Description
Message Address LSB (RO)	1:0	0h	For proper DWORD alignment, software must always write 0b's to these two bits. Otherwise, the result is undefined.
Message Address	31:2	0h	System-Specific Message Lower Address For MSI-X messages, the contents of this field from an MSI-X table entry specifies the lower portion of the DWORD-aligned address for the memory write transaction.

### 14.12.2 MSI-X Table Entry Upper Address - MSIXTUADD (BAR3: 0004h + n\*10h [n=0..9]; RW)

Field	Bit(s)	Initial Value	Description
Message Address	31:0	0h	System-Specific Message Upper Address

### 14.12.3 MSI-X Table Entry Message - MSIXTMSG (BAR3: 0008h + n\*10h [n=0..9]; RW)

Field	Bit(s)	Initial Value	Description
Message Data	31:0	0h	System-Specific Message Data For MSI-X messages, the contents of this field from an MSI-X table entry specifies the data written during the memory write transaction. In contrast to message data used for MSI messages, the low-order message data bits in MSI-X messages are not modified by the function.

### 14.12.4 MSI-X Table Entry Vector Control - MSIXVCTRL (BAR3: 000Ch + n\*10h [n=0..9]; RW)

Field	Bit(s)	Initial Value	Description
Mask	0	1b	When this bit is set, the function is prohibited from sending a message using this MSI-X table entry. However, any other MSI-X table entries programmed with the same vector are still capable of sending an equivalent message unless they are also masked.
Reserved	31:1	0h	Reserved

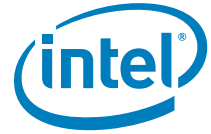

## 14.12.5 MSI-X Pending Bit Array - MSI XPBA Bit Description

Field	Bit(s)	Initial Value	Description
Pending Bits	9:0	0h	For each pending bit that is set, the function has a pending message for the associated MSI-X Table entry. Pending bits that have no associated MSI-X table entry are reserved.
Reserved	31:10	0h	Reserved

§ §



**NOTE:**        *This page intentionally left blank.*





## 15.0 Diagnostics and Testability

---

### 15.1 Diagnostics

To assist in test and debug of device-driver software, a set of software-usable features have been provided in the 82575. These features include controls for specific test-mode usage, as well as some registers for verifying device internal state against what the device-driver might be expecting.

The 82575 provides software visibility (and controllability) into certain major internal data structures, including all of the transmit & receive FIFO space. However, interlocks are not provided for any operations, so diagnostic accesses may only be performed under very controlled circumstances.

The 82575 also provides software-controllable support for certain loopback modes, to allow a device-driver to test transmit and receive flows to itself. Loopback modes can also be used to diagnose communication problems and attempt to isolate the location of a break in the communications path.

#### 15.1.1 FIFO Pointer Accessibility

The 82575's internal pointers into its transmit and receive data FIFOs are visible through the head and tail diagnostic data FIFO registers listed in Section 13. Diagnostics software can read these FIFO pointers to confirm expected hardware state following a sequence of operation(s). Diagnostic software can further write to these pointers as a partial-step to verify expected FIFO contents following specific operation, or to subsequently write data directly to the data FIFOs.

#### 15.1.2 FIFO Data Accessibility

The 82575's internal transmit and receive data FIFOs contents are directly readable and writable through the PBM register. The specific locations read or written are determined by the values of the FIFO pointers, which may be read and written. When accessing the actual FIFO data structures, locations must be accessed as 32-bit words. See section 13.

#### 15.1.3 Loopback Operations

Loopback operations are supported by the 82575 to assist with system and 82575 debug. Loopback operations can be used to test transmit and receive aspects of software device drivers, as well as to verify electrical integrity of the connections between the 82575 and the system (PCIe\* bus connections, etc.). Loopback operations are supported as follows:

Configuration for loopback operations vary depending on the link configuration being used.



- MAC Loopback while operating with the internal PHY.
- MAC Loopback, by setting the *LBM* bits in RCTL register to 11b.
- Loopback - 10/100/1000BASE-T PHY: To configure for loopback operation when using internal PHY mode or 10/100/1000BASE-T mode, the RCTL.LBM should remain configured as for normal operation (set = 00b). The PHY must be programmed, using MDIO accesses to its MII management registers, to perform loopback within the PHY.
- Loopback - SerDes: To configure for loopback operation when operating the MAC in SerDes, the RCTL.LBM should be set = 11b. For external SerDes interface operation, this LBM encoding asserts the EWRAP output pin, which should be connected to the SerDes so as to enable loopback in the SerDes when asserted.

**Note:** All loopback modes are only allowed when the 82575 is configured for full duplex operation. MAC loopback is not functional when the MAC is configured to work at 10 Mb/s.

## 15.2 Testability

The 82575 uses full Boundary Scan/IEEE 1149.1 JTAG standard test methods. The TAP controller supports EXTEST, SAMPLE/PRELOAD, IDCODE, and BYPASS instructions.

### 15.2.1 EXTEST Instruction

This instruction allows testing of off-chip circuitry and board level interconnections. Data is typically loaded onto the latched parallel outputs of the boundary-scan shift register stages using the SAMPLE/PRELOAD instruction prior to selection of the EXTEST instruction.

### 15.2.2 SAMPLE/PRELOAD Instruction

In SAMPRE, the boundary scan cells latch values from the 82575 external balls, enabling a programmer to shift them out through JTAG TDO. Unlike the IEEE standard specification, the 82575 does not support SAMPLE command and does not enable a snapshot of the normal operation of the component to be taken and examined. Therefore, in SAMPRE command pads, bidirectional buffers become inputs.

### 15.2.3 IDCODE Instruction

The IDCODE instruction provides information on the base component. When the 82575 identification register is included in a component design, the IDCODE instruction is forced into the instruction register's parallel output latches.

**Note:** IDCODE is the default instruction after JTAG FSM is reset.

For example, the 82575's ID is determined and derived from the manufacturer as follows:

Component Product Code	Ver	V	Product	Gen	Model	Manf ID	1	ID Code (hex)
82575	0000	0	001000	0101	01010	00000001001	1	010aa13



## 15.2.4 BYPASS Instruction

This instruction is the only instruction defined by the standard that causes operation of the bypass register. The bypass register contains a single-shift register stage and is used to provide a minimum length serial path between the TDI and TDO pins of a component when no test operation of that component is required. This allows more rapid movement of test data to and from other components on a board that are required to perform test operations.

§ §

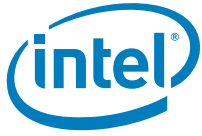

**NOTE:**      *This page intentionally left blank.*

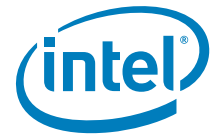

## 16.0 Statistics

The 82575 supports different statistics counters as described in [Section 14.0](#). The statistics can be used to create statistics reports according to different standards. The 82575 statistics allows support for the following standards:

- IEEE 802.3 clause 30 management - DTE section
- NDIS 6.0 OID\_GEN\_STATISTICS
- RFC 2819 - RMON Ethernet statistics group
- Linux Kernel (version 2.6) net\_device\_stats

The following section describes the matching between the internal statistics and the counters requested by the different standards.

### 16.1 IEEE 802.3 Clause 30 Management

The 82575 supports the Basic and Mandatory Packages defined in clause 30 of the IEEE 802.3 specification. The following table lists the matching between the internal statistics and the counters requested by these packages.

Mandatory Package Capability	82575 Counter	Notes and Limitations
FramesTransmittedOK	GPTC	The 82575 doesn't include flow control packets.
SingleCollisionFrames	SCC	
MultipleCollisionFrames	MCC	
FramesReceivedOK	GPRC	The 82575 doesn't include flow control packets.
FrameCheckSequenceErrors	CRCERRS, ALGNERRC	CRCERRS also includes alignment errors. In order to obtain FrameCheckSequenceErrors, ALGNERRC should be subtracted from CRCERRS.
AlignmentErrors	ALGNERRC	

In addition, part of the recommended package is also implemented as listed in the following table:

Recommended Package Capability	82575 Counter	Notes and Limitations
OctetsTransmittedOK	GOTCH/GOTCL	The 82575 also counts the DA/SA/LT/CRC as part of the octets. The 82575 doesn't count flow control packets.
FramesWithDeferredXmissions	DC	
LateCollisions	LATECOL	
FramesAbortedDueToXSColls	ECOL	



FramesLostDueToIntMACXmitError	HTDMPC	The 82575 counts the excessive collisions in this counter, while 802.3 increments no other counters, while this counter is incremented
CarrierSenseErrors	TNCRS	The 82575 doesn't count cases of CRS de-assertion in the middle of the packet. However, such cases are not expected when the internal PHY is used.
OctetsReceivedOK	TORL+TORH	The 82575 also counts the DA/SA/LT/CRC as part of the octets. The 82575 doesn't count flow control packets.
FramesLostDueToIntMACRcvError	RNBC	
SQETestErrors	N/A	
MACControlFramesTransmitted	N/A	
MACControlFramesReceived	N/A	
UnsupportedOpCodesReceived	FCURC	
PAUSEMACCtrlFramesTransmitted	XONTXC + XOFTXC	
PAUSEMACCtrlFramesReceived	XONRXC + XOFRXC	

A part of the optional package is also implemented as listed in the following table:

Optional Package Capability	82575 Counter	Notes
MulticastFramesXmittedOK	MPTC	The 82575 doesn't count flow control packets.
BroadcastFramesXmittedOK	BPTC	
MulticastFramesReceivedOK	MPRC	The 82575 doesn't count flow control packets.
BroadcastFramesReceivedOK	BPRC	
InRangeLengthErrors	LENERRS	
OutOfRangeLengthField	N/A	These packets are parsed as Ethernet II packets.
FrameTooLongErrors	ROC + RJC	

## 16.2 OID\_GEN\_STATISTICS

The 82575 supports the part of the OID\_GEN\_STATISTICS as defined by Microsoft\* NDIS 6.0 specification. The following table lists the matching between the internal statistics and the counters requested by this structure.

OID Entry	82575 Counters	Notes
ifInDiscards;	CRCERRS + RLEC + RXERRC + MPC + RNBC	
ifInErrors;	CRCERRS + RLEC + RXERRC	
ifHCInOctets;	GORCL/GOTCL	
ifHCInUcastPkts;	GPRC - MPRC - BPRC	
ifHCInMulticastPkts;	MPRC	
ifHCInBroadcastPkts;	BPRC	
ifHCOctets;	GOTCL/GOTCH	
ifHCOUcastPkts;	GPTC - MPTC - BPTC	
ifHCOUmulticastPkts;	MPTC	
ifHCOUbroadcastPkts;	BPTC	
ifOutErrors;	ECOL + LATECOL	



ifOutDiscards;	ECOL	
ifHCInUcastOctets;	N/A	
ifHCInMulticastOctets;	N/A	
ifHCInBroadcastOctets;	N/A	
ifHCOUcastOctets;	N/A	
ifHCOMulticastOctets;	N/A	
ifHCOBroadcastOctets;	N/A	

## 16.3 RMON

The 82575 supports the part of the RMON Ethernet statistics group as defined by IETF RFC 2819. The following table lists the matching between the internal statistics and the counters requested by this group.

RMON Statistic	82575 Counters	Notes
etherStatsDropEvents	MPC + RNBC	
etherStatsOctets	TOTL + TOTH	
etherStatsPkts	TPR	
etherStatsBroadcastPkts	BPRC	
etherStatsMulticastPkts	MPRC	The 82575 doesn't count flow control packets.
etherStatsCRCAlignErrors	CRCERRS	
etherStatsUndersizePkts	RUC	
etherStatsOversizePkts	ROC	
etherStatsFragments	RFC	Should count bad aligned fragments as well.
etherStatsJabbers	RJC	Should count bad aligned jabbers as well.
etherStatsCollisions	COLC	
etherStatsPkts64Octets	PRC64	RMON counts bad packets as well.
etherStatsPkts65to127Octets	PRC127	RMON counts bad packets as well.
etherStatsPkts128to255Octets	PRC255	RMON counts bad packets as well.
etherStatsPkts256to511Octets	PRC511	RMON counts bad packets as well.
etherStatsPkts512to1023Octets	PRC1023	RMON counts bad packets as well.
etherStatsPkts1024to1518Octets	PRC1522	RMON counts bad packets as well.

## 16.4 Linux net\_device\_stats

The 82575 supports part of the net\_device\_stats as defined by Linux Kernel version 2.6 (defined in <linux/netdevice.h>). The following table lists the matching between the internal statistics and the counters requested by this structure.

net_device_stats Field	82575 Counters	Notes
rx_packets	GPRC	The 82575 doesn't count flow control packets.
tx_packets	GPTC	The 82575 doesn't count flow control packets.
rx_bytes	GORCL + GORCH	



tx_bytes	GOTCL + GOTCH	
rx_errors	CRCERRS + RLEC + RXERRC	
tx_errors	ECOL + LATECOL	
rx_dropped	N/A	
tx_dropped	N/A	
multicast	MPTC	
collisions	COLC	
rx_length_errors	RLEC	
rx_over_errors	N/A	
rx_crc_errors	CRCERRS - ALGNERRC	
rx_frame_errors	ALGNERRC	
rx_fifo_errors	HRMPC	
rx_missed_errors	MPC	
tx_aborted_errors	ECOL	
tx_carrier_errors	N/A	
tx_fifo_errors	N/A	
tx_heartbeat_errors	N/A	
tx_window_errors	LATECOL	
rx_compressed	N/A	
tx_compressed	N/A	

§ §



## Free Manuals Download Website

<http://myh66.com>

<http://usermanuals.us>

<http://www.somanuals.com>

<http://www.4manuals.cc>

<http://www.manual-lib.com>

<http://www.404manual.com>

<http://www.luxmanual.com>

<http://aubethermostatmanual.com>

Golf course search by state

<http://golfingnear.com>

Email search by domain

<http://emailbydomain.com>

Auto manuals search

<http://auto.somanuals.com>

TV manuals search

<http://tv.somanuals.com>