

# Intel® Express 535T Switch

*Quick Start and User Guide*



Copyright © 2000, Intel Corporation. All rights reserved.  
Intel Corporation, 5200 NE Elam Young Parkway, Hillsboro OR 97124-6497

Intel Corporation assumes no responsibility for errors or omissions in this manual. Nor does Intel make any commitment to update the information contained herein.

英特尔公司对于此手册中的错误或遗漏不负任何责任，也不负责更新此手册的信息。

Intel Corporation은 이 설명서에 포함된 오류나 생략된 내용에 대해 책임이 없습니다. 또한 Intel은 이 정보를 업데이트할 의무가 없습니다.

Intel Corporation décline toute responsabilité en cas d'erreur ou d'omission dans ce manuel. Intel ne s'engage nullement à mettre à jour les informations comprises dans ce document.

Intel non si assume alcuna responsabilità per eventuali errori e omissioni presenti in questo manuale, né si assume alcun impegno ad aggiornare le informazioni ivi contenute.

Die Intel Corporation übernimmt keine Verantwortung für Fehler oder Auslassungen in diesem Handbuch. Auch verpflichtet sich Intel nicht, die hierin enthaltenen Informationen zu aktualisieren.

La corporación Intel no asume ninguna responsabilidad por los errores u omisiones que pueda haber en este manual. Además, Intel tampoco se compromete a actualizar la información aquí contenida.

\* Other product and corporate names may be trademarks of other companies and are used only for explanation and to the owners' benefit, without intent to infringe.

**Second Edition**

**September 2000**

**A30582-001**

# Contents

---

<b>Quick Starts</b>	<b>2</b>
English .....	2
Chinese .....	4
Korean .....	6
French .....	8
Italian .....	10
German .....	12
Spanish .....	14
<b>User Guide</b>	<b>17</b>
Overview .....	17
Features .....	17
LEDs .....	18
Connecting to Devices .....	19
Connection Guidelines .....	19
Stacking with 530T Switches .....	20
Stacking Capabilities .....	20
Workgroup Example .....	22
Cabling Devices .....	23
Media Requirements .....	23
Straight-through vs. Crossover Cables .....	23
FAQs/Troubleshooting .....	25
Regulatory Information and Warnings .....	26
Limited Hardware Warranty .....	29
<b>Intel Customer Support</b>	<b>35</b>

# Quick Start

## 1 Install the Switch

- Remove the switch and parts from the box.
- Attach the enclosed brackets if you plan to mount the switch in a rack.
- Install the Intel® Express 535T Switch in a rack or on a shelf.
- Plug in the power cord.

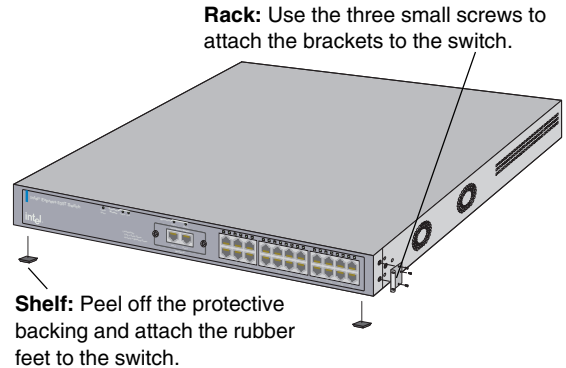

Figure 1: Install the Switch

## 2 Connect the Devices

- All ports automatically detect the speed and duplex-mode of any connected device.
- Connect PCs and print servers to the switch with straight-through cables.
- Use a crossover cable to connect a switch to another switch or hub.
- Use only CAT 5 UTP cable to connect 100Mbps devices. To connect 10Mbps devices, use CAT 3, 4, or 5 UTP cable.

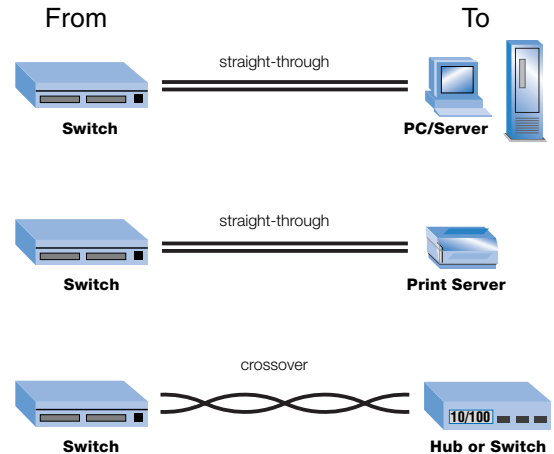

Figure 2: Connect the Devices

## 3 Check the Connections

- Check the port LEDs to confirm the link status.
- A solid green LED indicates a valid link.

**Port LED (Green)**  
Solid Green = Link  
Blinking Green = Activity

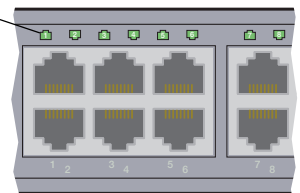

Figure 3: Check the Connections

# Optional Information

## 4 Stack the Switch

- Unplug all power cords and use the included stacking cable to attach the 535T switch to one of the ports on the Intel® Express Stack Matrix Module installed in the 530T switch.
- Attach up to three switches to the module for a total stack height of four switches (one 530T and three 535T switches).
- The 535T switch must be connected to a stack matrix module (in a 530T switch) in order to form a stack. You cannot stack two 535T switches together.
- The 530T or 535T switches do not stack with the Intel® Express 510T or 520T Switches or the Intel® Express 550F or 550T Routing Switches.

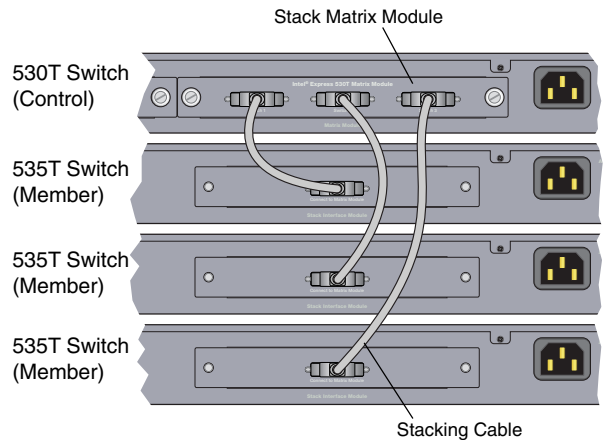

Figure 4: Connect switches to the stack matrix module

**Note:** You cannot use the stacking cables or stacking modules from the 510T, 520T, 550T, and 550F switches to connect the 530T and 535T switches together.

## 5 Add Optional Modules

- Use optional modules to provide 100FX connectivity for the stack, or to extend the network beyond 100 meters.
- Unplug the power cord and remove the 10/100Base-TX module from the Module A expansion slot on the front of the switch.
- Align the new module with the card guides inside the switch and slide the module into the slot. Press firmly to connect the module.
- Secure the module using the retaining screws and plug in the power cord.

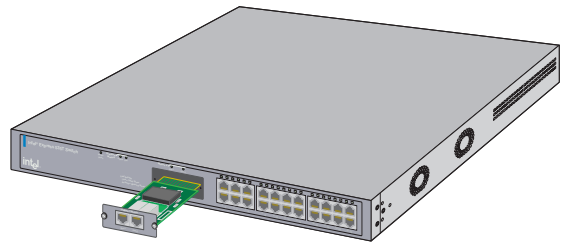

Figure 5: Install optional modules in the 535T switch. Remove the 10/100 Module before installing a 100FX module in the Module A slot on the 535T switch.



Fiber Module (SC connector) for Express 535T Switch (ES535MFXSC)



Fiber Module (MTRJ connector) for Express 535T Switch (ES535MFXRJ)

# 快速起步

## 1 安装交换器

- 从盒中取出交换器和零件。
- 如果要将交换器安装在机柜中，请将附带的托架固定到交换器上
- 将 Intel® Express 535T 交换器安装到机架或机柜上。
- 插入电源线。



图 1：安装交换器

## 2 连接设备

- 所有端口自动检测所有与之相连设备的速度和双工模式。
- 用直通电缆将计算机和打印服务器与交换器连接。
- 用交叉电缆将交换器与另一交换器或集线器连接。
- 只能用 CAT 5 UTP 电缆连接 100Mbps 设备。如果要连接 10Mbps 设备，可使用 CAT 3、4 或 5 UTP 电缆。

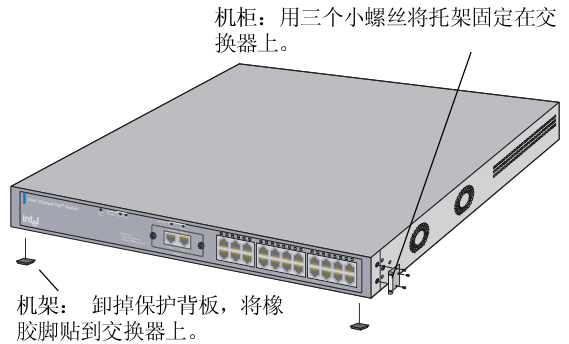

图 2：连接设备

## 3 检查连接

- 检查端口的LED以确认链接状态。
- LED 呈持续绿色表示有效链接。

端口 LED (绿色)  
持续绿色 = 链接  
闪烁绿色 = 活动

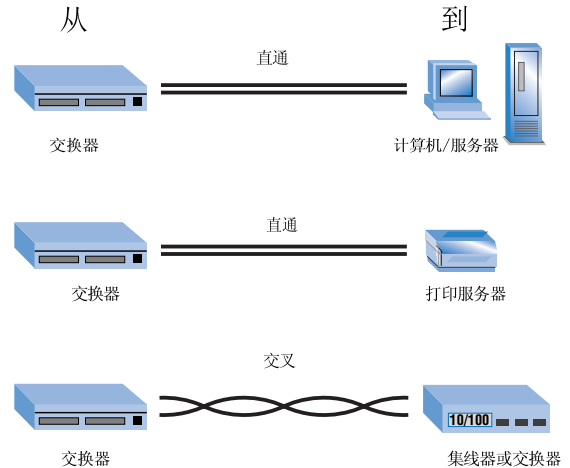

图 3：检查连接

# 可选项信息

## 4 堆叠交换器

- 拔去所有电源线, 使用 530T 交换器附带的堆叠连接电缆将 535T 交换器连接到安装在 530T 交换器上的 Intel® Express Stack Matrix (堆叠阵列) 模块的一个端口。
- 最多可将三台交换器连接到该模块, 使整个堆叠装置达到四台交换器 (一台 530T 交换器加三台 535T 交换器) 的高度。
- 535T 交换器必须连接到堆叠阵列模块 (安装在 530T 交换器上) 才能形成一个堆叠装置。不能将两台 535T 交换器堆叠在一起。
- 530T 或 535T 交换器不能与 Intel® Express 510T 或 520T 交换器堆叠, 也不能与 Intel® Express 550F 或 550T 路由交换器堆叠。

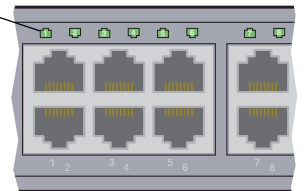

图 4: 将交换器连接到堆叠阵列模块

注意: 不能来自 510T、520T、550T 和 550F 交换器的堆叠连接电缆或堆叠连接模块将 530T 和 535T 交换器连接在一起。

## 5 添加可选模块

- 使用可选模块为交换器堆叠装置提供 100FX 的连接性, 或将网络延伸到 100 米以上。
- 拔去电源线, 从交换器前板的模块 A 扩展插槽中取出 10/100Base-TX 模块。
- 将新模块与交换器内部的插卡导轨对齐, 并将模块滑入插槽。用力按入模块使之连接。
- 使用固定螺丝固定模块, 然后插入电源线。

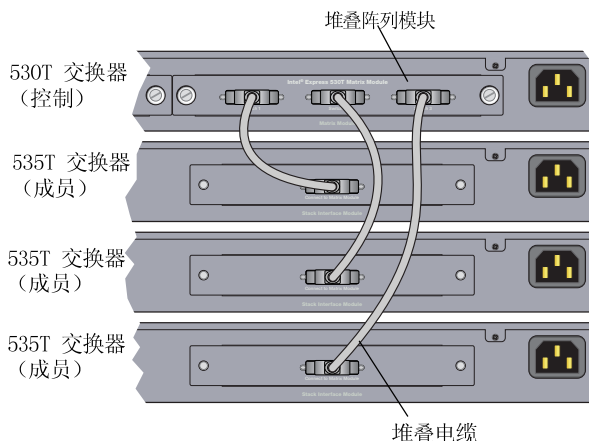

图 5: 在 535T 交换器中安装可选模块。先从 535T 交换器的模块 A 插槽中取出 10/100 模块, 然后再安装 100FX 模块。



用于 Express 535T 交换器的光纤模块 (SC 连接器) (ES535MFXS)

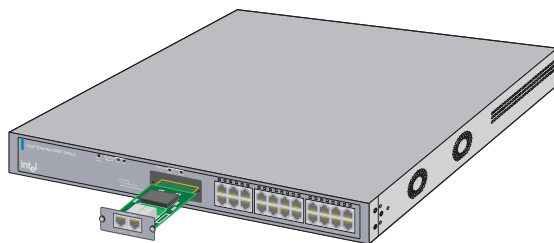

用于 Express 535T 交换器的光纤模块 (MTRJ 连接器) (ES535MFXRJ)

# 빠른 시작

## 1 스위치 설치

- 상자에서 스위치와 부품을 꺼냅니다.
- 스위치를 랙에 탑재하려면 포함되어 있는 브래킷을 연결합니다.
- 랙이나 쉘프에 Intel® Express 535T 스위치를 설치합니다.
- 전원을 연결합니다.

**랙(Rack):** 세 개의 작은 나사를 사용하여 브래킷을 스위치에 연결합니다.

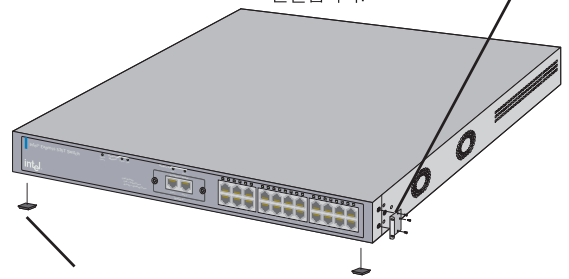

**셸프(Shelf):** 보호커버를 제거한 다음 고무 받침을 스위치에 연결합니다.

그림 1: 스위치 설치

## 2 장치 연결

- 모든 포트는 연결된 장치의 속도와 이중 모드를 자동으로 검색합니다.
- 스위치를 PC와 인쇄 서버에 연결하려면 직선 케이블을 사용합니다.
- 스위치를 다른 스위치나 허브에 연결하려면 교차 케이블을 사용합니다.
- 100Mbps 장치를 연결하려면 CAT 5 UTP 케이블만 사용하고, 10Mbps 장치를 연결하려면 CAT 3, 4 또는 5 UTP 케이블을 사용합니다.



그림 2: 장치 연결

## 3 연결 확인

- 연결 상태를 확인하려면 포트의 LED를 점검합니다.
- 제대로 연결되어 있으면 LED가 안정된 녹색으로 보입니다.

포트 LED (녹색)  
안정된 녹색 = 연결  
깜박이는 녹색 = 작동

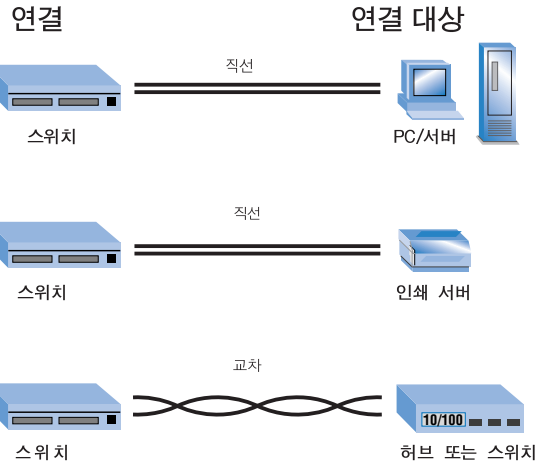

그림 3: 연결 확인



## 4 스위치 스택

- 전원 코드를 모두 빼고 포함된 스택 케이블로 530T 스위치에 설치된 Intel® Express 스택 매트릭스 모듈의 포트 중 하나에 535T 스위치를 연결합니다.
- 총 스택 높이가 스위치 네 개인 모듈에 스위치를 세 개까지 연결합니다(530T 한 개와 535T 스위치 세 개).
- 스택을 형성하려면 535T 스위치를 530T 스위치의 스택 매트릭스 모듈에 연결해야 합니다. 두 개의 535T 스위치를 함께 연결할 수 없습니다.
- 530T 또는 535T 스위치는 Intel® Express 510T 또는 520T 스위치 또는 Intel® Express 550F 또는 550T 라우팅 스위치에 연결할 수 없습니다.

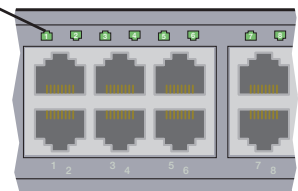

그림 4: 스택 매트릭스 모듈에 스위치 연결

**참고:** 510T, 520T, 550T, 550F 스위치로부터 스택 케이블 또는 스택 모듈을 사용하여 530T 및 535T 스위치를 함께 연결할 수 없습니다.

## 5 옵션 모듈 추가

- 스택에 100FX 연결을 제공하거나 네트워크를 100m 이상 확장하려면 옵션 모듈을 사용합니다.
- 전원 코드를 빼고 스위치 앞면의 모듈 A 확장 슬롯에서 10/100Base-TX 모듈을 제거합니다.
- 새 모듈을 스위치 내부의 카드 가이드에 맞춘 다음 슬롯에 밀어 넣습니다. 모듈을 단단히 눌러 연결합니다.
- 고정 나사를 사용하여 모듈을 고정하는 다음 전원을 연결합니다.

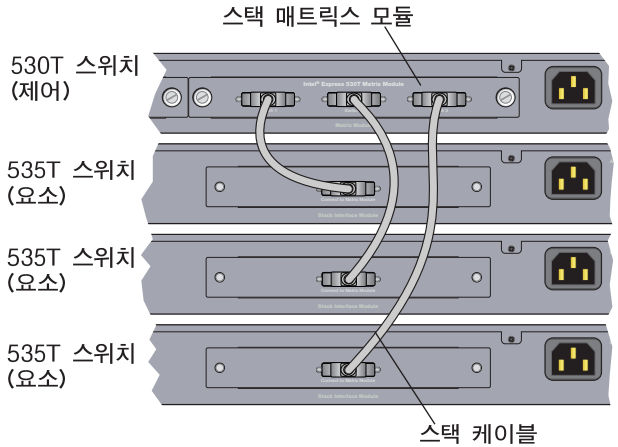

그림 5: 535T 스위치에 옵션 모듈 설치

535T 스위치의 모듈 A 슬롯에 100FX 모듈을 설치하려면 우선 10/100 모듈을 제거해야 합니다.



Express 535T 스위치 (ES535MFXSC)용 광섬유 모듈 (SC 커넥터)

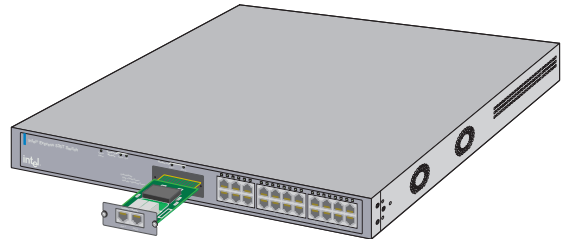

Express 535T 스위치 (ES535MFXRJ)용 광섬유 모듈 (MTRJ 커넥터)

# Démarrage rapide

## 1 Installez le commutateur

- Sortez le commutateur et les pièces de la boîte.
- Fixez les supports livrés avec l'appareil si vous avez l'intention de le monter en armoire.
- Installez le commutateur Intel® Express 535T dans une armoire ou sur une étagère.
- Branchez le câble d'alimentation.

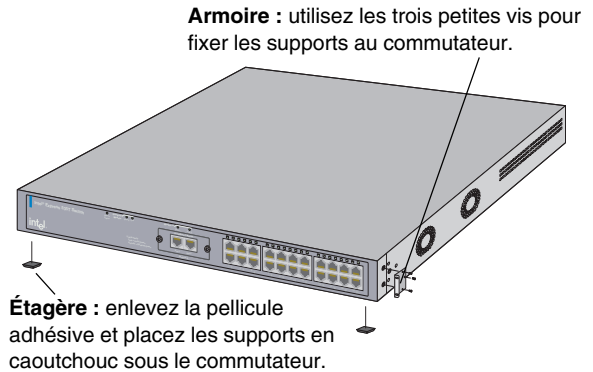

Figure 1 : installation du commutateur

## 2 Connectez les périphériques

- Tous les ports sont configurés de manière à détecter automatiquement la vitesse et le mode duplex du périphérique connecté.
- Connectez les PC et les serveurs d'impression au commutateur à l'aide de câbles directs.
- Utilisez un câble croisé pour connecter le commutateur à un autre commutateur ou à un concentrateur.
- Utilisez uniquement un câble CAT 5 UTP pour connecter des périphériques 100 Mbps. Pour connecter des périphériques 10 Mbps, utilisez un câble CAT 3, 4 ou 5 UTP.

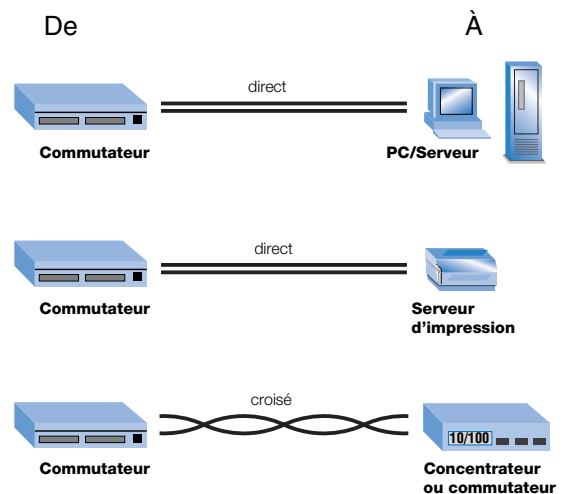

Figure 2 : connexion des périphériques

## 3 Vérifiez les connexions

- Vérifiez les diodes du port pour confirmer l'état de la liaison.
- Si le voyant vert est allumé en permanence, la liaison est valable.

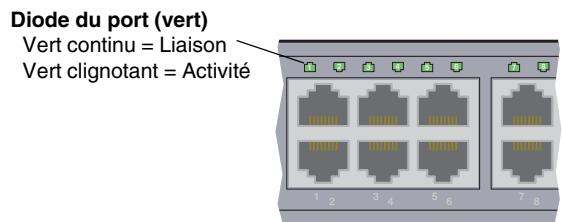
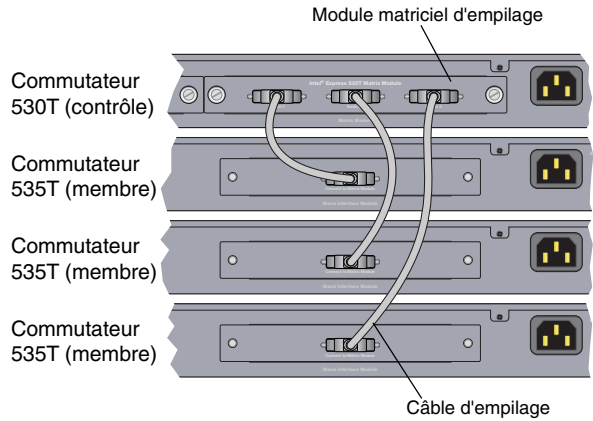

Figure 3 : vérification des connexions

# Informations facultatives

## 4 Empilez le commutateur

- Débranchez tous les câbles d'alimentation et, à l'aide du câble d'empilage fourni, connectez le commutateur 535T à l'un des ports du module matriciel d'empilage Intel® Express installé dans le commutateur 530T.
- Vous pouvez connecter jusqu'à trois commutateurs au module : la plus grande pile comprend donc quatre commutateurs (un commutateur 530T et trois 535T).
- Le commutateur 535T doit être connecté à un module matriciel d'empilage (dans un commutateur 530T) pour faire partie d'une pile. Vous ne pouvez pas empiler deux commutateurs 535T.
- Les commutateurs 530T ou 535T ne peuvent pas être empilés avec les commutateurs Intel® Express 510T ou 520T ni avec les commutateurs avec routage Intel® Express 550F ou 550T.

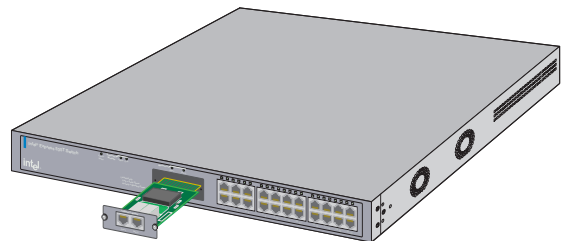

**Figure 4 : connexion de commutateurs au module matriciel d'empilage**

**Remarque :** vous ne pouvez pas utiliser les câbles d'empilage ni les modules d'empilage des commutateurs 510T, 520T, 550T et 550F pour connecter entre eux les commutateurs 530T et 535T.

## 5 Ajoutez des modules optionnels

- À l'aide des modules optionnels, vous pouvez fournir à la pile une connectivité 100FX ou étendre le réseau au-delà de 100 mètres.
- Débranchez le câble d'alimentation et retirez le module 10/100Base-TX du logement d'extension du Module A situé sur la face avant du commutateur.
- Alignez le nouveau module sur les guides à l'intérieur du commutateur et insérez-le en appuyant fermement pour le connecter.
- Vissez le module en utilisant les vis de fixation et branchez le câble d'alimentation.



**Figure 5 : installation des modules optionnels dans le commutateur 535T.**

Retirez le module 10/100Base-TX avant d'installer un module 100FX dans le logement du Module A situé sur le commutateur 535T.



Module fibre (connecteur SC) pour le commutateur Express 535T (ES535MFXSC)



Module fibre (connecteur MTRJ) pour le commutateur Express 535T (ES535MFXRJ)

# Introduzione rapida

## 1 Installazione dello switch

- Rimuovere lo switch e le altre parti dalla confezione.
- Se si intende montare lo switch a rack, fissare i supporti allegati.
- Installare lo switch Intel® Express 535T in un rack o su un ripiano.
- Collegare il cavo di alimentazione.

**A rack:** Usare le tre viti piccole per fissare i supporti allo switch.

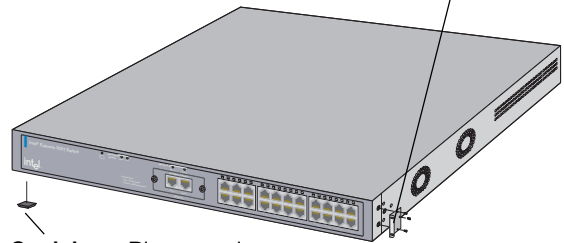

**Su ripiano:** Rimuovere la protezione dell'autoadesivo dai piedini in gomma e farli aderire allo switch.

Figura 1: Installazione dello switch

## 2 Connessione dei dispositivi

- Tutte le porte sono in grado di rilevare la velocità e la modalità duplex dei dispositivi collegati.
- Connettere i PC e i server di stampa utilizzando un cavo diretto.
- Utilizzare un cavo incrociato per connettere uno switch a un altro switch o hub.
- Utilizzare solo cavi UTP CAT 5 per collegare i dispositivi a 100Mbps. Per collegare dispositivi a 10Mbps, utilizzare un cavo UTP CAT 3, 4 e 5.



Figura 2: Connessione dei dispositivi

## 3 Controllo dei collegamenti

- Controllare le spie LED delle porte per individuare lo stato del collegamento.
- Una spia LED verde costante indica un collegamento valido.

**LED porta (Verde)**  
Verde costante = Collegamento  
Verde lampeggiante = Attività

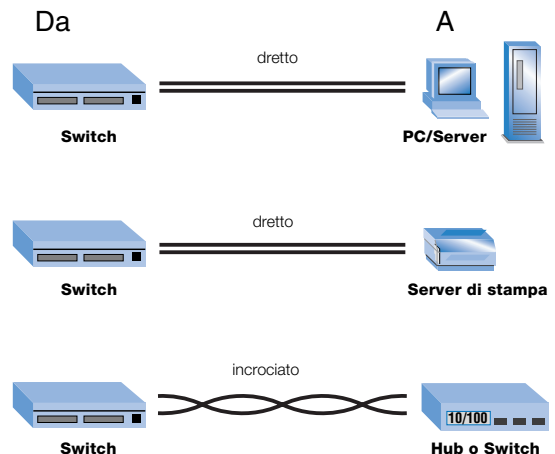

Figura 3: Controllo dei collegamenti

# Opzioni di gestione

## 4

### Installazione di uno stack di switch

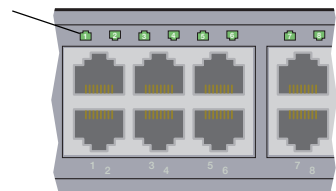
- Disconnettere tutti i cavi di alimentazione e utilizzare il cavo di stack fornito per collegare lo switch 535T a una delle porte del modulo Intel® Express Stack Matrix Module installato nello switch 530T.
- Collegare al modulo fino a tre switch per un'altezza totale dello stack di quattro switch (uno switch 530T e tre switch 535T).
- Collegare lo switch 535T al modulo a matrice di stack (in uno switch 530T) per formare uno stack. Non è possibile eseguire lo stack di due switch 535T.
- Non è inoltre possibile eseguire lo stack di switch 530T o 535T con switch Intel® Express 510T o 520T oppure con routing switch Intel® Express 550F o 550T.

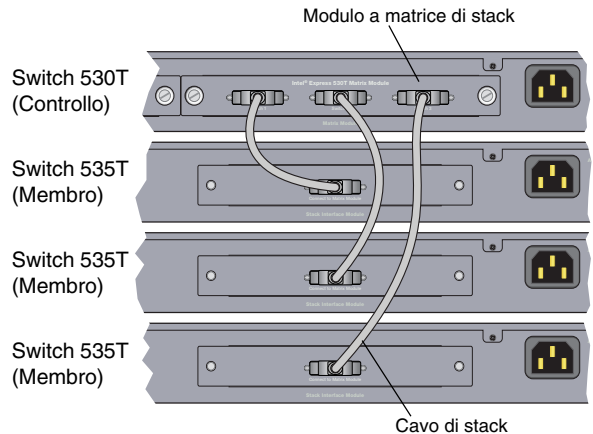

**Figura 4: Collegamento di switch al modulo a matrice di stack**

**Nota:** non è possibile utilizzare cavi o moduli di stack di switch 510T, 520T, 550T e 550F per collegare switch 530T e 535T.

## 5

### Aggiunta di moduli opzionali

- Utilizzare i moduli opzionali per fornire allo stack una connettività 100FX oppure per estendere la rete oltre i 100 metri.
- Disconnettere il cavo di alimentazione e rimuovere il modulo 10/100Base-TX dallo slot di espansione nella parte frontale dello switch (Modulo A).
- Allineare il nuovo modulo con le guide all'interno dello switch e inserire il modulo nello slot. Premere fermamente per connettere il modulo.
- Utilizzare le viti di ritenzione per fissare il modulo, quindi collegare il cavo di alimentazione.

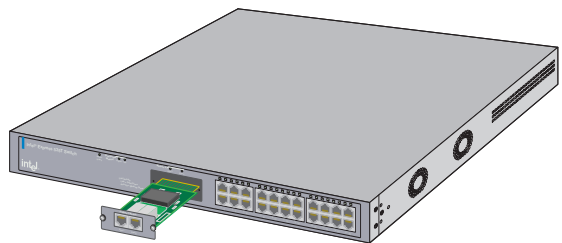

**Figura 5: Installazione di moduli opzionali nello switch 535T.**

Rimuovere il modulo 10/100 prima di procedere all'installazione del modulo 100FX nello slot di espansione (Modulo A) dello switch 535T.



Modulo fibre ottiche (connettore SC) per switch Express 535T (ES535MFXSC)



Modulo fibre ottiche (connettore MTRJ) per switch Express 535T (ES535MFXRJ)

# Schnellstart

## 1 Installieren des Switches

- Entfernen Sie den Switch und die Bauteile aus der Schachtel.
- Befestigen Sie die enthaltenen Klammern, wenn Sie den Switch in einem Gestell montieren möchten.
- Installieren Sie den Intel® Express 535T Switch in einem Gestell oder Regal.
- Schließen Sie das Stromkabel an.

**Gestell:** Befestigen Sie die Klammern mit den drei kleinen Schrauben am Switch.

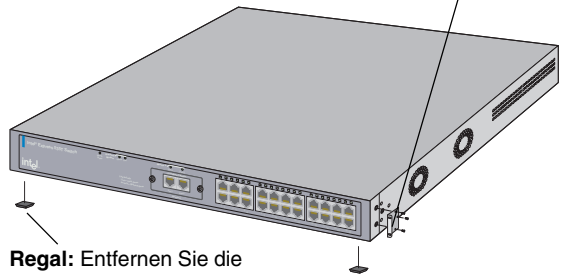

**Regal:** Entfernen Sie die Schutzfolie, und befestigen Sie die Gummifüße am Switch.

Abbildung 1: Installieren des Switches

## 2 Anschließen der Geräte

- Alle Anschlüsse stellen automatisch die Geschwindigkeit und den Duplexmodus der angeschlossenen Geräte fest.
- Schließen Sie PCs und Druckerserver über direkte Kabelverbindungen an.
- Verwenden Sie zur Verbindung des Switches mit einem Hub oder einem anderen Switch ein Crossover-Kabel.
- Verwenden Sie für den Anschluß von 100Mbps-Geräten ausschließlich CAT 5 UTP Kabel. Verwenden Sie für den Anschluß von 10Mbps-Geräten CAT 3, 4 oder 5 UTP Kabel.



Abbildung 2: Anschließen der Geräte

## 3 Überprüfen der Verbindungen

- Überprüfen Sie die Anschluß-LEDs, um den Verbindungsstatus zu bestätigen.
- Eine ununterbrochen grün aufleuchtende LED signalisiert eine gültige Verbindung.

### Anschluß-LED (grün)

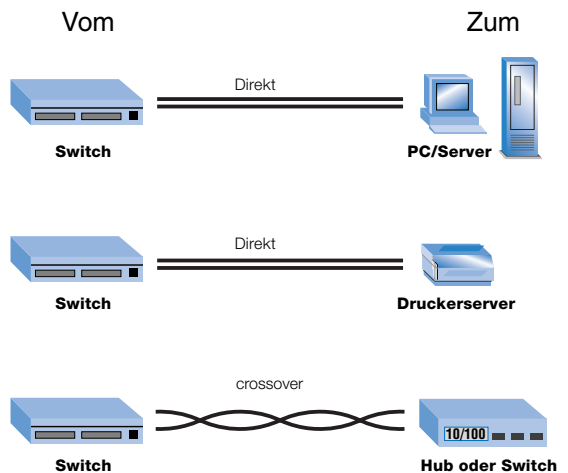
Ununterbrochen grün = Verbindung  
Blinkend grün = Aktivität



Abbildung 3: Überprüfen der Verbindungen

# Zusätzliche Informationen

## 4 Stapeln des Switches

- Ziehen Sie alle Stromkabel ab, und schließen Sie den 535T Switch mit dem beiliegenden Stapelkabel an einen der Anschlüsse am Intel® Express Stack Matrix Modul an, das im 530T Switch installiert ist.
- Schließen Sie bis zu drei Switches am Modul an. Damit sollten maximal vier Switches aufeinander gestapelt sein (ein 530T und drei 535T Switches).
- Der 535T Switch muß an ein Stapelmatrixmodul (in einem 530T Switch) angeschlossen werden. Es ist nicht möglich, zwei 535T Switches zusammen zu stapeln.
- Die 530T oder 535T Switches lassen sich nicht mit den Intel® Express 510T oder 520T Switches oder den Intel® Express 550F oder 550T Routing Switches stapeln.

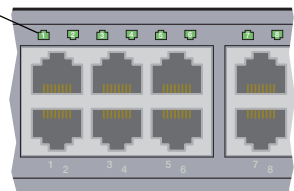

Abbildung 4: Anschließen der Switches an das Stapelmatrixmodul

**Hinweis:** Die Stapelkabel bzw. Stapelmodule von den 510T, 520T, 550T und 550F Switches sind ungeeignet, um die 530T und 535T Switches zu verbinden.

## 5 Hinzufügen weiterer Module

- Fügen Sie nach Wunsch weitere Module hinzu, um 100FX-Konnektivität für den Stapel herzustellen oder das Netzwerk über 100 m hinaus zu erweitern.
- Ziehen Sie das Stromkabel ab, und entfernen Sie das 10/100Base-TX Modul vom Erweiterungssteckplatz für Modul A an der Vorderseite des Switches.
- Richten Sie das neue Modul an den Kartenführungen innerhalb des Switches aus, und schieben Sie es in den Steckplatz. Drücken Sie kräftig, um das Modul anzuschließen.
- Befestigen Sie das Modul mit den Halteschrauben, und stecken Sie den Netzstecker ein.

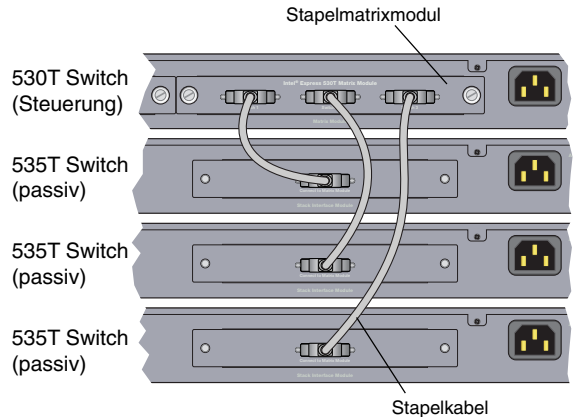

Abbildung 5: Wahlweise Installation weiterer Module im 535T Switch.

Entfernen Sie das 10/100 Modul, bevor Sie ein 100FX Modul in den Steckplatz für Modul A am 535T Switch installieren.



Glasfasermodul (SC-Stecker) für Express 535T Switch (ES535MFXSC)

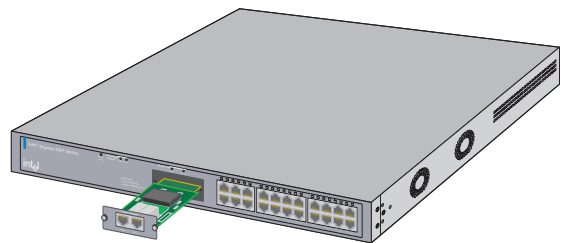

Glasfasermodul (MTRJ-Stecker) für Express 535T Switch (ES535MFXRJ)

# Guía de instalación rápida

## 1 Instalación del Switch

- Extraiga el Switch y las piezas de la caja.
- Coloque las abrazaderas que se incorporan si va a montar el Switch en un bastidor.
- Instale el Intel® Express 535T Switch en un bastidor o en una estantería.
- Conecte el cable de alimentación.

**Bastidor:** utilice los tres tornillos pequeños para atornillar las abrazaderas al Switch.

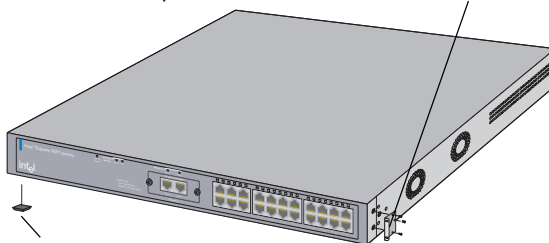

**Estantería:** despegue el respaldo protector y colóquelo el pie de goma al Switch.

Figura 1: Instalación del Switch

## 2 Conexión de los dispositivos

- Todos los puertos detectan de manera automática la velocidad y la modalidad dúplex de todos los dispositivos conectados.
- Conecte los servidores de PC y de impresión al Switch con cables planos.
- Utilice un cable cruzado para conectar un Switch con otro Switch o con un nudo de conexiones.
- Utilice sólo un cable UTP de categoría 5 para conectar dispositivos a 100Mbps. Para conectar dispositivos 10Mbps, utilice un cable UTP de categoría 3, 4 ó 5.



Figura 2: Conexión de los dispositivos

## 3 Comprobación de las conexiones

- Compruebe los indicadores luminosos (*LEDs*) del puerto para confirmar el estado del enlace.
- Un LED verde constante indica que el enlace es válido.

**Puerto LED (verde)**  
Verde constante = Enlace  
Verde parpadeante = Actividad

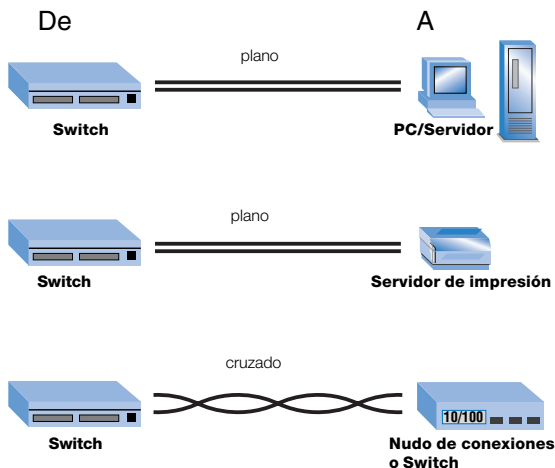

Figura 3: Comprobación de las conexiones



# Información opcional

## 4

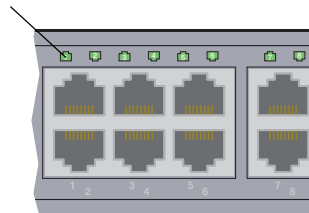
### Apilamiento del Switch

- Desconecte todos los cables de alimentación y utilice el cable de apilamiento que se adjunta para conectar el Switch 535T a uno de los puertos del módulo matriz de apilamiento Intel® Express instalado en el Switch 530T.
- Conecte hasta tres Switches al módulo para un total de altura de apilamiento de cuatro Switches (un Switch 530T y tres 535T)
- Cada Switch 535T tiene que estar conectado a un módulo matriz de apilamiento (dentro del Switch 530T) para poder formar un apilamiento. No puede apilar juntos dos Switches 535T.
- Los Switches 530T ó 535T no se pueden apilar con los Switches Intel® Express 510T ó 520T, o con los Switches de ruta Intel® Express 550F ó 550T.

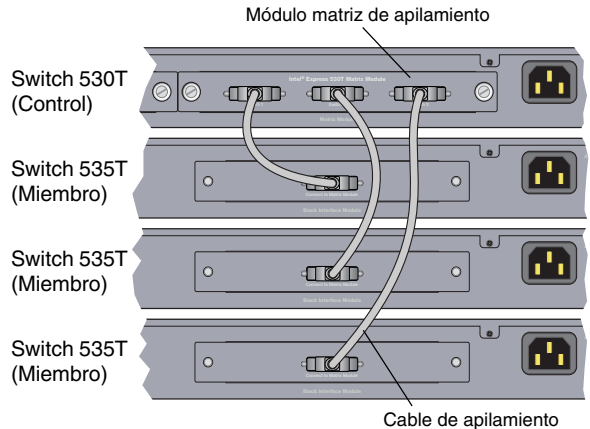

**Figura 4: Conexión de Switches al módulo matriz de apilamiento**

**Nota:** No pueden utilizar los cables de apilamiento o los módulos de apilamiento desde los Switches 510T, 520T, 550T y 550F para interconectar los Switches 530T y 535T entre sí.

## 5

### Adición de módulos opcionales

- Utilice módulos opcionales para proporcionar conectividad 100FX para el apilamiento o para extender la red más allá de 100 metros.
- Desconecte el cable de alimentación y retire el módulo 10/100Base-TX de la ranura de expansión del Módulo A situada en la parte frontal del Switch.
- Alinee el nuevo módulo con las guías de tarjeta que encontrará dentro del Switch y deslice el módulo en la ranura. Presione firmemente para conectar el módulo.
- Utilice el resto de los tornillos para asegurar el módulo y, a continuación, enchufe el cable de alimentación.

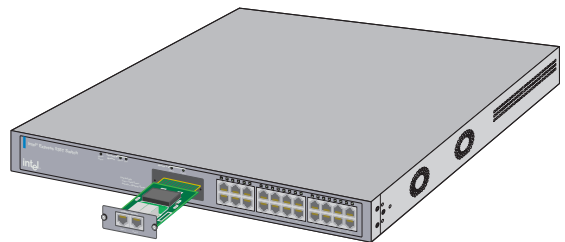

**Figura 5: Instalación de módulos opcionales en el Switch 535T.**

Retire el módulo 10/100 antes de instalar un módulo 100FX en la ranura del Módulo A del Switch 535T.



Módulo de fibra (conector SC) para el Switch Express 535T (ES535MFXSC)



Módulo de fibra (conector MTRJ) para el Switch Express 535T (ES535MFXRJ)



# User Guide - Overview

---

## Features

This guide covers the Intel® Express 535T Switch.

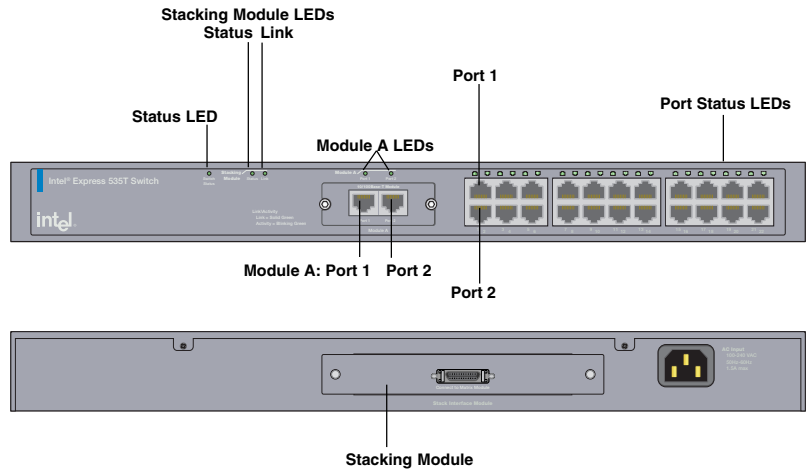

- 
- Autonegotiates speed—10Mbps or 100Mbps *per port*.
  - Autonegotiates flow control.
  - Can be used alone as an unmanaged switch, or as a managed switch in a stack with up to two additional 535T switches and a 530T (control) switch.
-

# LEDs

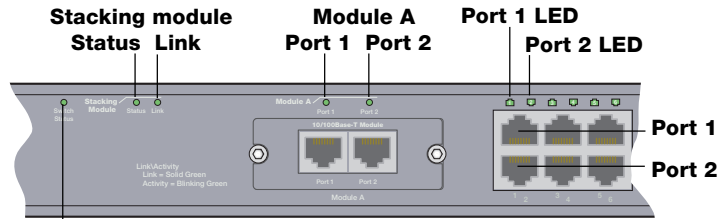

Switch status

## Switch Status LED

LED	Status	Meaning
Switch Status	Solid green	Power.
	Off	No power.

## Stacking Module LEDs

LED	Status	Meaning
Status	Solid green	Module present.
	Off	No module present.
Link	Solid green	Device linked.
	Off	No link detected.

## Module A LEDs (10/100 TX, 100FX)

LED	Status	Meaning
Ports 1/2	Solid green	Device linked.
	Blinking green	Receiving traffic on that port.
	Off	No link detected.

## Port LEDs

LED	Status	Meaning
Left/Right	Solid green	Device linked.
	Blinking green	Receiving traffic on that port.
	Off	No link detected.

# Connecting to Devices

---

## Connection Guidelines

### General

- The copper ports of the 535T switches are capable of autonegotiating port speed and can operate at 10Mbps or 100Mbps per port. The switch matches the highest possible speed of an attached device.
- The 535T's fiber modules always operate at 100Mbps.
- The 535T switches are capable of autonegotiating port duplex and can operate at half- or full-duplex.
- Configure the network so devices that talk primarily to each other are on the same segment. Each port is a single segment.

### Cabling

- Use Category 5 unshielded twisted-pair (CAT 5 UTP) cable when connecting 100Mbps devices to the switch.
- Use Category 3, 4, or 5 unshielded twisted-pair (CAT 3, 4, or 5 UTP) cable when connecting 10Mbps devices to the switch.
- Limit the cable length between devices to 100 meters (328 feet).
- Use a straight-through cable to connect the switch to a server or workstation. For more information on cabling, see "Cabling Devices."
- To connect to another switch or hub use crossover cables.
- To connect a device to one of the fiber ports, use 62.5/125  $\mu\text{m}$  multimode cabling. This cabling can be a maximum of 2,000m when operating at full-duplex, and 160m (to a hub) or 400m (to a router, switch, or PC) when operating at half-duplex.

# Stacking with 530T Switches

## Stacking Capabilities

The 535T can be used alone or in a stack. Stacking the 535T allows it to become a managed switch.

### About a stack

- To stack two or more 535T switches, you must have a 530T switch with the Stack Matrix Module installed.
- 535Ts can only be stacked with other 535Ts (and one 530T).
- A stack can consist of up to three 535Ts and one 530T.
- In a stack, the 535T switches are the member switches and the 530T is the control switch.
- The member switches are all managed through the console switch's management interface.
- The entire stack has one IP address (the control switch's IP address).

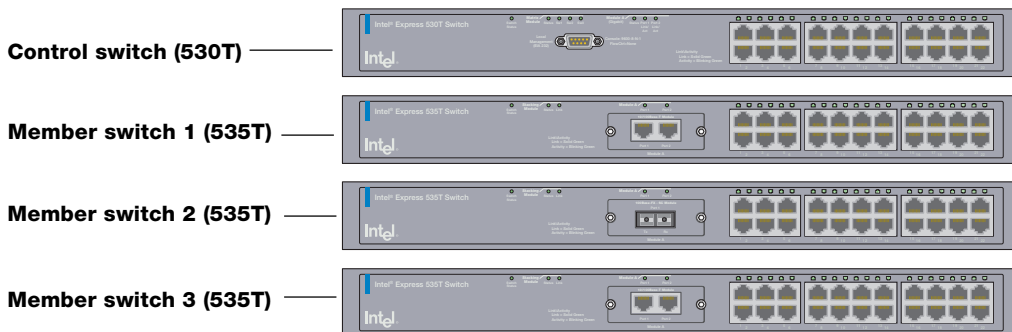

---

## Assemble a stack

To stack 535Ts with a 530T, you need to purchase a Stack Matrix Module for the 530T.

- 1 Insert the Stack Matrix Module into the slot in the back of the 530T, labeled Matrix Module, and tighten the screws.
- 2 Run a cable from the slot in the back of the 535T, labeled Stack Interface Module, to the control switch's Stack Matrix Module, where it reads "Switch 1." This connection makes this 535T switch Member 2 in the stack.
- 3 Repeat step 2 until you have added all member switches (535Ts) to the stack. You can have a total of three member switches.
- 4 Power on the control switch.

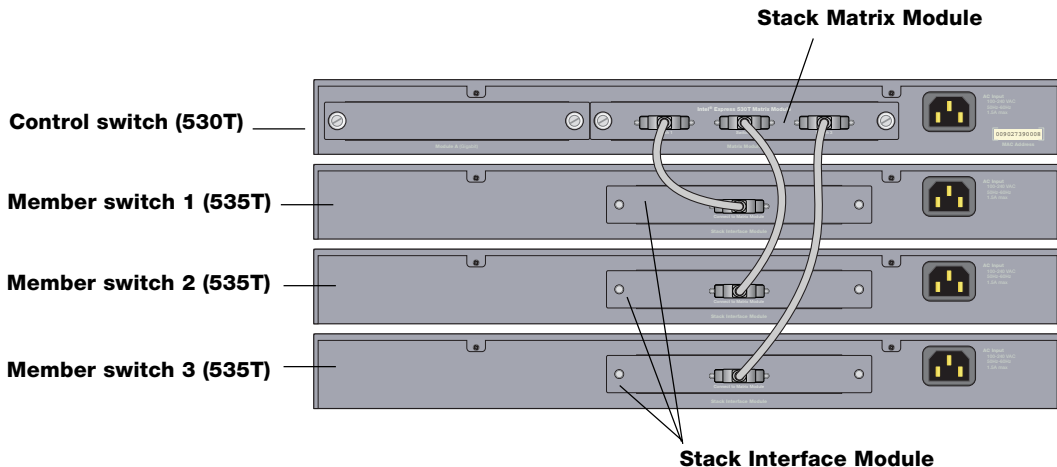

# Workgroup Example

The example below shows a sample network. The Intel® NetStructure™ 480T Routing Switch serves as the backbone of the network, and the stacks of 530T/535T switches provide the connection between the 480T and the users on each of the floors.

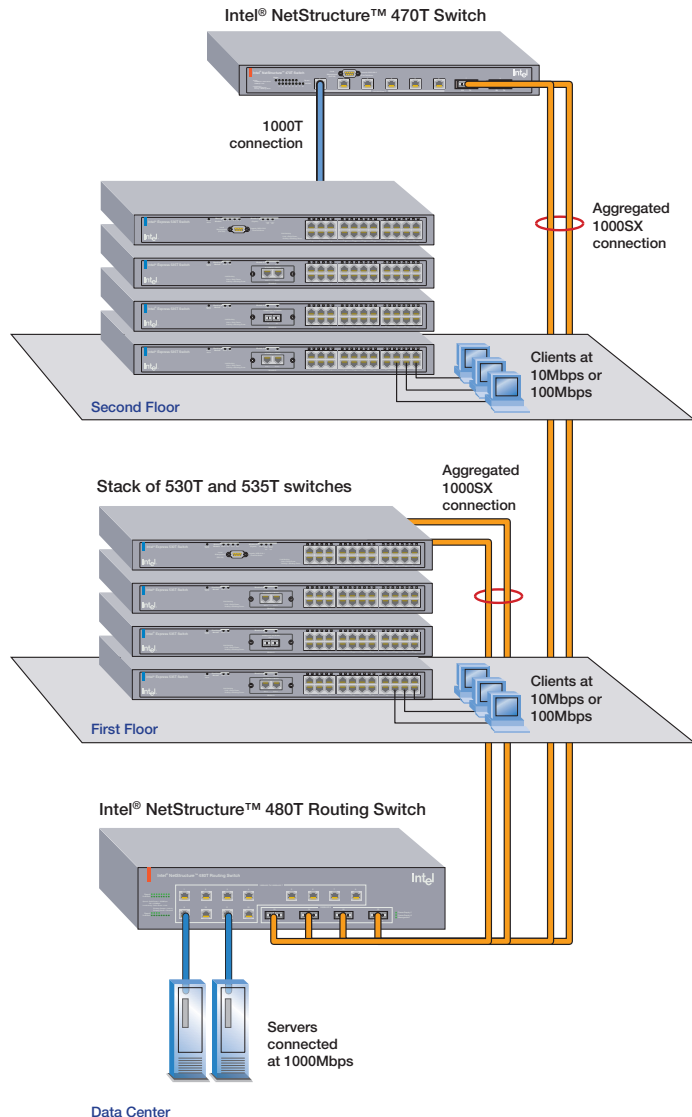



# Cabling Devices

---

## Media Requirements

Incorrect cabling is often the cause of network performance problems. The next two pages discuss the requirements.

### 100Base-TX

The 100Base-TX Fast Ethernet specification requires that you use CAT 5 UTP cabling to operate at 100Mbps. You're limited to 100 meters between any two devices. If you use lower grade cabling (CAT 3 or CAT 4), you may get a connection, but will soon experience data loss or slow performance.

### 10Base-T

The 10Base-T Ethernet specification allows you to use CAT 3, CAT 4, or CAT 5 UTP cabling. You're limited to 100 meters of cable between any two devices.

### 100Base-FX

The fiber ports of the 535T switch let you connect to a switch up to 400 meters (hubs up to 160m) away at half-duplex or up to 2 km at full-duplex. Use 62.5/125 $\mu$ m multimode fiber optic cable with an SC-type or MTRJ fiber optic connector.

## Straight-through vs. Crossover Cables

Switch ports are wired MDI-X, so use a straight-through cable when connecting to a workstation or server. (Network adapter cards are wired MDI, not MDI-X.) For direct connection to another MDI-X port, use a crossover cable. Here are the pin arrangements for the switch's Ethernet port and the typical RJ-45 connector.

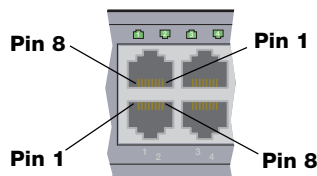

Ethernet Port

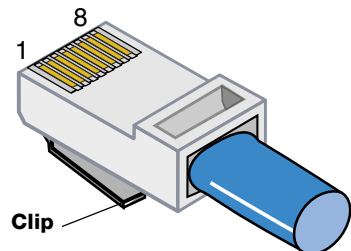

RJ-45 Connector

---

## Straight-through UTP cable

Hub (MDI-X)

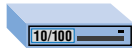

Adapter (MDI)

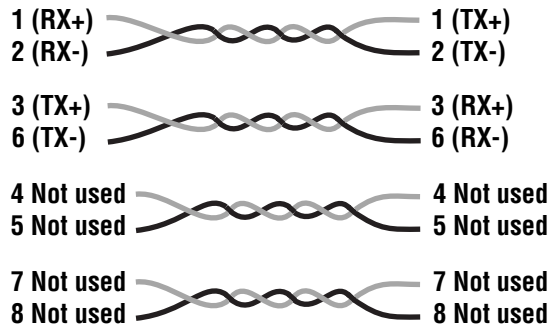

## Crossover UTP cable

Hub (MDI-X)

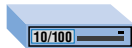

Switch (MDI-X)

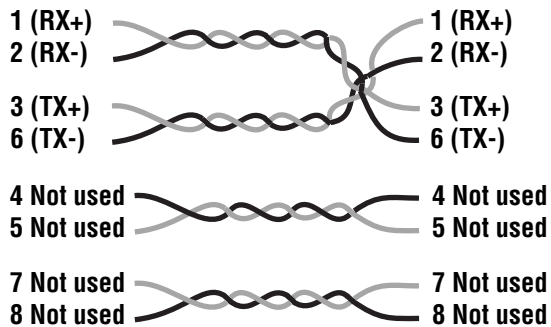

# FAQs/Troubleshooting

---

## **I've connected the cable but the port LED is off. Why?**

- Remove the cable and plug it in again. Wait up to six seconds for a link.
- Make sure you're using the correct type of cable (straight-through or crossover) for the device you want to connect to. If you're using the wrong cable, the link LED will not come on.
- Make sure the device you've connected to a port is a 10Base-T or 100Base-TX device. The Express 535T Switch doesn't support 100Base-T4 devices running at 100Mbps. However, they do support T4 devices running at 10Mbps.
- Check the speed and duplex settings on the PC's network adapter.
- The cable is defective.

## **I keep getting an intermittent loss of link (or data is not being transmitted). Why?**

- You may be using the wrong grade of cable. The wrong cable can cause erratic performance and you may eventually lose the connection between the port and the attached device.
- A cable segment somewhere in your collision domain may be too long. Make sure no segment of your UTP cabling is longer than 100 meters.
- Check the Ethernet cable pairs. The TX pairs (pins 1 and 2) and the RX pairs (pins 3 and 6) should be twisted pairs. See diagram on page 24.

## **How can I set the speed or duplex on individual ports?**

Normally the switch handles all connections automatically. If you need to force speed or duplex, ( to accommodate older devices that don't support autonegotiation) the 535T switch will need to be part of a stack so you can use the Local Management on the Intel® Express 530T Switch to configure the port.

# Regulatory Information and Warnings

## FCC Part 15 Compliance Statement

This product has been tested and found to comply with the limits for a Class A digital device pursuant to Part 15 of the FCC rules. These limits are designed to provide reasonable protection against harmful interference when the equipment is operated in a commercial environment.

This product generates, uses, and can radiate radio frequency energy and, if not installed and used in accordance with the instruction manual, may cause harmful interference to radio communications. However, there is no guarantee that interference will not occur in a particular installation. If this equipment does cause harmful interference to radio or television reception, which can be determined by turning this equipment off and on, the user is encouraged to try to correct the interference by one or more of the following measures:

- Change the direction of the radio or TV antenna.
- To the extent possible, relocate the radio, TV, or other receiver away from the product.
- Plug the product into a different electrical outlet so that the product and the receiver are on different branch circuits.

If these suggestions don't help, consult your dealer or an experienced radio/TV repair technician for more suggestions.

**NOTE** This device complies with Part 15 of the FCC Rules. Operation is subject to the following two conditions: (1) This device may not cause harmful interference, and (2) this device must accept any interference received, including interference that may cause undesired operation.

**CAUTION** If you make any modification to the equipment not expressly approved by Intel, you could void your authority to operate the equipment.

## Canada Compliance Statement (Industry Canada)

Cet appareil numérique respecte les limites bruits radioélectriques applicables aux appareils numériques de Classe A prescrites dans la norme sur le matériel brouilleur: "Appareils Numériques", NMB-003 édictée par le Ministre Canadien des Communications.

This digital apparatus does not exceed the Class A limits for radio noise emissions from digital apparatus set out in the interference-causing equipment standard entitled: "Digital Apparatus," ICES-003 of the Canadian Department of Communications.

## Manufacturer Declaration

This certifies that the Intel® Express 535T Switch complies with the EU Directive 89/336/EEC, using the EMC standards EN55022 (Class A) and EN55024. This product also meets or exceeds EN 60950 (safety) requirements. These products have been tested and verified to meet CISPR 22 Class A requirements.

## Australia Statement



## Taiwan Class A EMI Statement

警告使用者：  
這是甲類的資訊產品，在居住的環境中使用時，可能造成射頻干擾，在這種情況下，使用者會被要求採取某些適當的對策。

## VCCI Statement

### Class A ITE

この装置は、情報処理装置等電波障害自主規制協議会（VCCI）の基準に基づくクラスA情報技術装置です。この装置を家庭環境で使用すると電波妨害を引き起こすことがあります。この場合には使用者が適切な対策を講ずるよう要求されることがあります。

This is a Class A product based on the standard of the Voluntary Control Council for Interference by Information Technology Equipment (VCCI). If this equipment is used in a domestic environment, radio disturbance may arise. When such trouble occurs, the user may be required to take corrective actions.

## Warnings

### WARNING

This is a Class A product. In a domestic environment this product may cause radio interference in which case the user may be required to take adequate measures. Internal access to Intel® Express 535T Switch is intended only for qualified service personnel. Do not remove any covers.

### WARNING

The system is designed to operate in a typical office environment. Choose a site that is:

- Clean and free of airborne particles (other than normal room dust).
- Well ventilated and away from sources of heat including direct sunlight.
- Away from sources of vibration or physical shock.
- Isolated from strong electromagnetic fields produced by electrical devices.
- In regions that are susceptible to electrical storms, we recommend you plug your system into a surge suppressor and disconnect telecommunication lines to your modem during an electrical storm.
- Provided with a properly grounded wall outlet.

Do not attempt to modify or use the supplied AC power cord if it is not the exact type required.

Ensure that the system is disconnected from its power source and from all telecommunications links, networks, or modems lines whenever the chassis cover is to be removed. Do not operate the system with the cover removed.

## AVERTISSEMENT

Le système a été conçu pour fonctionner dans un cadre de travail normal. L'emplacement choisi doit être:

- Propre et dépourvu de poussière en suspension (sauf la poussière normale).
- Bien aéré et loin des sources de chaleur, y compris du soleil direct.
- A l'abri des chocs et des sources de vibrations.
- Isolé de forts champs magnétiques générés par des appareils électriques.
- Dans les régions sujettes aux orages magnétiques il est recommandé de brancher votre système à un supresseur de surtension, et de débrancher toutes les lignes de télécommunications de votre modem durant un orage.
- Muni d'une prise murale correctement mise à la terre.

Ne pas utiliser ni modifier le câble d'alimentation C. A. fourni, s'il ne correspond pas exactement au type requis.

Assurez vous que le système soit débranché de son alimentation ainsi que de toutes les liaisons de télécommunication, des réseaux, et des lignes de modem avant d'enlever le capot. Ne pas utiliser le système quand le capot est enlevé.

## WARNUNG

Das System wurde für den Betrieb in einer normalen Büroumgebung entwickelt. Der Standort sollte:

- sauber und staubfrei sein (Hausstaub ausgenommen);
- gut gelüftet und keinen Heizquellen ausgesetzt sein (einschließlich direkter Sonneneinstrahlung);
- keinen Erschütterungen ausgesetzt sein;
- keine starken, von elektrischen Geräten erzeugten elektromagnetischen Felder aufweisen;
- in Regionen, in denen elektrische Stürme auftreten, mit einem Überspannungsschutzgerät verbunden sein; während eines elektrischen Sturms sollte keine Verbindung der Telekommunikationsleitungen mit dem Modem bestehen;
- mit einer geerdeten Wechselstromsteckdose ausgerüstet sein.

Versuchen Sie nicht, das mitgelieferte Netzkabel zu ändern oder zu verwenden, wenn es sich nicht um genau den erforderlichen Typ handelt.

Das System darf weder an eine Stromquelle angeschlossen sein noch eine Verbindung mit einer Telekommunikationseinrichtung, einem Netzwerk oder einer Modem-Leitung haben, wenn die Gehäuseabdeckung entfernt wird. Nehmen Sie das System nicht ohne die Abdeckung in Betrieb.

## AVVERTENZA

Il sistema è progettato per funzionare in un ambiente di lavoro tipico. Scegliere una postazione che sia:

- Pulita e libera da particelle in sospensione (a parte la normale polvere presente nell'ambiente).
- Ben ventilata e lontana da fonti di calore, compresa la luce solare diretta.
- Al riparo da urti e lontana da fonti di vibrazione.
- Isolata dai forti campi magnetici prodotti da dispositivi elettrici.
- In aree soggette a temporali, è consigliabile collegare il sistema ad un limitatore di corrente. In caso di temporali, scollegare le linee di comunicazione dal modem.
- Dotata di una presa a muro correttamente installata.

Non modificare o utilizzare il cavo di alimentazione in c. a. fornito dal produttore, se non corrisponde esattamente al tipo richiesto.

Prima di rimuovere il coperchio del telaio, assicurarsi che il sistema sia scollegato dall'alimentazione, da tutti i collegamenti di comunicazione, reti o linee di modem. Non avviare il sistema senza aver prima messo a posto il coperchio.

## ADVERTENCIAS

El sistema está diseñado para funcionar en un entorno de trabajo normal. Escoja un lugar:

- Limpio y libre de partículas en suspensión (salvo el polvo normal)
- Bien ventilado y alejado de fuentes de calor, incluida la luz solar directa.
- Alejado de fuentes de vibración.
- Aislado de campos electromagnéticos fuertes producidos por dispositivos eléctricos.
- En regiones con frecuentes tormentas eléctricas, se recomienda conectar su sistema a un eliminador de sobrevoltage y desconectar el módem de las líneas de telecomunicación durante las tormentas.
- Previsto de una toma de tierra correctamente instalada.

No intente modificar ni usar el cable de alimentación de corriente alterna, si no se corresponde exactamente con el tipo requerido.

Asegúrese de que cada vez que se quite la cubierta del chasis, el sistema haya sido desconectado de la red de alimentación y de todos los enlaces de telecomunicaciones, de red y de líneas de módem. No ponga en funcionamiento el sistema mientras la cubierta está quitada

---

## Wichtige Sicherheitshinweise

1. Bitte lesen Sie sich diese Hinweise sorgfältig durch.
2. Heben Sie diese Anleitung für den spätem Gebrauch auf.
3. Vor jedem Reinigen ist das Gerät vom Stromnetz zu trennen. Verwenden Sie keine Flüssig- oder Aerosolreiniger. Am besten dient ein angefeuchtetes Tuch zur Reinigung.
4. Um eine Beschädigung des Gerätes zu vermeiden sollten Sie nur Zubehörteile verwenden, die vom Hersteller zugelassen sind.
5. Das Gerät ist vor Feuchtigkeit zu schützen.
6. Bei der Aufstellung des Gerätes ist auf sichern Stand zu achten. Ein Kippen oder Fallen könnte Verletzungen hervorrufen. Verwenden Sie nur sichere Standorte und beachten Sie die Aufstellhinweise des Herstellers.
7. Die Belüftungsöffnungen dienen zur Luftzirkulation die das Gerät vor Überhitzung schützt. Sorgen Sie dafür, daß diese Öffnungen nicht abgedeckt werden.
8. Beachten Sie beim Anschluß an das Stromnetz die Anschlußwerte.
9. Die Netzanschlußsteckdose muß aus Gründen der elektrischen Sicherheit einen Schutzleiterkontakt haben.
10. Verlegen Sie die Netzanschlußleitung so, daß niemand darüber fallen kann. Es sollte auch nichts auf der Leitung abgestellt werden.
11. Alle Hinweise und Warnungen die sich am Geräten befinden sind zu beachten.
12. Wird das Gerät über einen längeren Zeitraum nicht benutzt, sollten Sie es vom Stromnetz trennen. Somit wird im Falle einer Überspannung eine Beschädigung vermieden.
13. Durch die Lüftungsöffnungen dürfen niemals Gegenstände oder Flüssigkeiten in das Gerät gelangen. Dies könnte einen Brand bzw. Elektrischen Schlag auslösen.
14. Öffnen Sie niemals das Gerät. Das Gerät darf aus Gründen der elektrischen Sicherheit nur von autorisiertem Servicepersonal geöffnet werden.
15. Wenn folgende Situationen auftreten ist das Gerät vom Stromnetz zu trennen und von einer qualifizierten Servicestelle zu überprüfen:
  - a— Netzkabel oder Netzstecker sind beschädigt.
  - b— Flüssigkeit ist in das Gerät eingedrungen.
  - c— Das Gerät war Feuchtigkeit ausgesetzt.
  - d— Wenn das Gerät nicht der Bedienungsanleitung entsprechend funktioniert oder Sie mit Hilfe dieser Anleitung keine Verbesserung erzielen.
  - e— Das Gerät ist gefallen und/oder das Gehäuse ist beschädigt.
  - f— Wenn das Gerät deutliche Anzeichen eines Defektes aufweist.
16. Bei Reparaturen dürfen nur Originalersatzteile bzw. den Originalteilen entsprechende Teile verwendet werden. Der Einsatz von ungeeigneten Ersatzteilen kann eine weitere Beschädigung hervorrufen.
17. Wenden Sie sich mit allen Fragen die Service und Reparatur betreffen an Ihren Servicepartner. Somit stellen Sie die Betriebssicherheit des Gerätes sicher.
18. Zum Netzanschluß dieses Gerätes ist eine geprüfte Leitung zu verwenden, Für einen Nennstrom bis 6A und einem Gerätegewicht größer 3kg ist eine Leitung nicht leichter als H05VV-F, 3G, 0.75mm<sup>2</sup> einzusetzen.

# Limited Hardware Warranty

---

Intel warrants to the original owner that the hardware product delivered in this package will be free from defects in material and workmanship for three (3) years following the latter of: (i) the date of purchase only if you register by returning the registration card as indicated thereon with proof of purchase; or (ii) the date of manufacture; or (iii) the registration date if by electronic means provided such registration occurs within thirty (30) days from purchase. This warranty does not cover the product if it is damaged in the process of being installed. Intel recommends that you have the company from whom you purchased this product install the product.

INTEL RESERVES THE RIGHT TO FILL YOUR ORDER WITH A PRODUCT CONTAINING NEW OR REMANUFACTURED COMPONENTS. THE ABOVE WARRANTY IS IN LIEU OF ANY OTHER WARRANTY, WHETHER EXPRESS, IMPLIED OR STATUTORY, INCLUDING, BUT NOT LIMITED TO, ANY WARRANTY OF NONINFRINGEMENT OF INTELLECTUAL PROPERTY, MERCHANTABILITY, FITNESS FOR A PARTICULAR PURPOSE, OR ANY WARRANTY ARISING OUT OF ANY PROPOSAL, SPECIFICATION, SAMPLE OR OTHERWISE.

This warranty does not cover replacement of products damaged by abuse, accident, misuse, neglect, alteration, repair, disaster, improper installation or improper testing. If the product is found to be otherwise defective, Intel, at its option, will replace or repair the product at no charge except as set forth below, provided that you deliver the product along with a return material authorization (RMA) number either to the company from whom you purchased it or to Intel (North America only). If you ship the product, you must assume the risk of damage or loss in transit. You must use the original container (or the equivalent) and pay the shipping charge. Intel may replace or repair the product with either new or remanufactured product or parts, and the returned product becomes Intel's property. Intel warrants the repaired or replaced product to be free from defects in material and workmanship for a period of the greater of: (i) ninety (90) days from the return shipping date; or (ii) the period of time remaining on the original three (3) year warranty.

This warranty gives you specific legal rights and you may have other rights which vary from state to state. All parts or components contained in this product are covered by Intel's limited warranty for this product; the product may contain fully tested, recycled parts, warranted as if new. For warranty information call one of the numbers below.

## Returning a Defective Product (RMA)

Before returning any product, contact an Intel Customer Support Group and obtain an RMA number by calling:

**North America only:** (916) 377-7000  
**Other locations:** Return the product to the place of purchase.

If the Customer Support Group verifies that the product is defective, they will have the Return Material Authorization Department issue you an RMA number to place on the outer package of the product. Intel cannot accept any product without an RMA number on the package.

## LIMITATION OF LIABILITY AND REMEDIES

INTEL SHALL HAVE NO LIABILITY FOR ANY INDIRECT OR SPECULATIVE DAMAGES (INCLUDING, WITHOUT LIMITING THE FOREGOING, CONSEQUENTIAL, INCIDENTAL AND SPECIAL DAMAGES) ARISING FROM THE USE OF OR INABILITY TO USE THIS PRODUCT, WHETHER ARISING OUT OF CONTRACT, NEGLIGENCE, TORT, OR UNDER ANY WARRANTY, IRRESPECTIVE OF WHETHER INTEL HAS ADVANCE NOTICE OF THE POSSIBILITY OF ANY SUCH DAMAGES, INCLUDING, BUT NOT LIMITED TO LOSS OF USE, INFRINGEMENT OF INTELLECTUAL PROPERTY, BUSINESS INTERRUPTIONS, AND LOSS OF PROFITS, NOTWITHSTANDING THE FOREGOING, INTEL'S TOTAL LIABILITY FOR ALL CLAIMS UNDER THIS AGREEMENT SHALL NOT EXCEED THE PRICE PAID FOR THE PRODUCT. THESE LIMITATIONS ON POTENTIAL LIABILITIES WERE AN ESSENTIAL ELEMENT IN SETTING THE PRODUCT PRICE. INTEL NEITHER ASSUMES NOR AUTHORIZES ANYONE TO ASSUME FOR IT ANY OTHER LIABILITIES.

Some states do not allow the exclusion or limitation of incidental or consequential damages, so the above limitations or exclusions may not apply to you.

**Critical Control Applications:** Intel specifically disclaims liability for use of the hardware product in critical control applications (including, for example only, safety or health care control systems, nuclear energy control systems, or air or ground traffic control systems) by Licensee or Sublicensees, and such use is entirely at the user's risk. Licensee agrees to defend, indemnify, and hold Intel harmless from and against any and all claims arising out of use of the hardware product in such applications by Licensee or Sublicensees.

**Software:** Software provided with the hardware product is not covered under the hardware warranty described above. See the applicable software license agreement which shipped with the hardware product for details on any software warranty.

---

## Limited Hardware Warranty (Europe only)

Intel warrants to the original owner that the hardware product delivered in this package will be free from defects in material and workmanship for three (3) years following the latter of: (i) the date of purchase only if you register by returning the registration card as indicated thereon with proof of purchase; or (ii) the date of manufacture; or (iii) the registration date if by electronic means provided such registration occurs within thirty (30) days from purchase. This warranty does not cover the product if it is damaged in the process of being installed. Intel recommends that you have the company from whom you purchased this product install the product.

INTEL RESERVES THE RIGHT TO FILL YOUR ORDER WITH A PRODUCT CONTAINING NEW OR REMANUFACTURED COMPONENTS. THE ABOVE WARRANTY IS IN LIEU OF ANY OTHER WARRANTY, WHETHER EXPRESS, IMPLIED OR STATUTORY, INCLUDING, BUT NOT LIMITED TO, ANY WARRANTY OF NONINFRINGEMENT OF INTELLECTUAL PROPERTY, SATISFACTORY QUALITY, FITNESS FOR A PARTICULAR PURPOSE, OR ANY WARRANTY ARISING OUT OF ANY PROPOSAL, SPECIFICATION, SAMPLE OR OTHERWISE.

This warranty does not cover replacement of products damaged by abuse, accident, misuse, neglect, alteration, repair, disaster, improper installation or improper testing. If the product is found to be otherwise defective, Intel, at its option, will replace or repair the product at no charge except as set forth below, provided that you deliver the product along with a return material authorization (RMA) number either to (a) the company from whom you purchased it or (b) to Intel, North America only (if purchased in Europe you must deliver the product to “(a)”). If you ship the product, you must assume the risk of damage or loss in transit. You must use the original container (or the equivalent) and pay the shipping charge. Intel may replace or repair the product with either new or remanufactured product or parts, and the returned product becomes Intel’s property. Intel warrants the repaired or replaced product to be free from defects in material and workmanship for a period of the greater of: (i) ninety (90) days from the return shipping date; or (ii) the period of time remaining on the original three (3) year warranty.

This warranty gives you specific legal rights and you may have other rights which vary from state to state. All parts or components contained in this product are covered by Intel’s limited warranty for this product; the product may contain fully tested, recycled parts, warranted as if new. For warranty information call one of the numbers below.

### Returning a Defective Product (RMA)

Before returning any product, contact an Intel Customer Support Group and obtain an RMA number by calling the non-toll free numbers below:

Country	Number	Language
France	+33 (0) 1 41 91 85 29	French
Germany	+49 (0) 69 9509 6099	German
Italy	+39 (0) 2 696 33276	Italian
UK	+44 (0) 870 607 2439	English

If the Customer Support Group verifies that the product is defective, they will have the Return Material Authorization Department issue you an RMA number to place on the outer package of the product. Intel cannot accept any product without an RMA number on the package.

### LIMITATION OF LIABILITY AND REMEDIES

INTEL SHALL HAVE NO LIABILITY FOR ANY INDIRECT OR SPECULATIVE DAMAGES (INCLUDING, WITHOUT LIMITING THE FOREGOING, CONSEQUENTIAL, INCIDENTAL AND SPECIAL DAMAGES) ARISING FROM THE USE OF OR INABILITY TO USE THIS PRODUCT, WHETHER ARISING OUT OF CONTRACT, NEGLIGENCE, TORT, OR UNDER ANY WARRANTY, IRRESPECTIVE OF WHETHER INTEL HAS ADVANCE NOTICE OF THE POSSIBILITY OF ANY SUCH DAMAGES, INCLUDING, BUT NOT LIMITED TO LOSS OF USE, INFRINGEMENT OF INTELLECTUAL PROPERTY, BUSINESS INTERRUPTIONS, AND LOSS OF PROFITS, NOTWITHSTANDING THE FOREGOING, INTEL’S TOTAL LIABILITY FOR ALL CLAIMS UNDER THIS AGREEMENT SHALL NOT EXCEED THE PRICE PAID FOR THE PRODUCT. THESE LIMITATIONS ON POTENTIAL LIABILITIES WERE AN ESSENTIAL ELEMENT IN SETTING THE PRODUCT PRICE. INTEL NEITHER ASSUMES NOR AUTHORIZES ANYONE TO ASSUME FOR IT ANY OTHER LIABILITIES.

**Critical Control Applications:** Intel specifically disclaims liability for use of the hardware product in critical control applications (including, for example only, safety or health care control systems, nuclear energy control systems, or air or ground traffic control systems) by Licensee or Sublicensees, and such use is entirely at the user’s risk. Licensee agrees to defend, indemnify, and hold Intel harmless from and against any and all claims arising out of use of the hardware product in such applications by Licensee or Sublicensees.

**Software:** Software provided with the hardware product is not covered under the hardware warranty described above. See the applicable software license agreement which shipped with the hardware product for details on any software warranty.

This limited hardware warranty shall be governed by and construed in accordance with the laws of England and Wales. The courts of England shall have exclusive jurisdiction regarding any claim brought under this warranty.



## Limitation de garantie du matériel (Europe)

Intel garantit au propriétaire original que le produit matériel livré dans le présent coffret est exempt de défaut matériel ou de fabrication pour une période de trois (3) ans à compter de la plus récente des dates suivantes : (i) la date d'achat uniquement si vous vous êtes inscrit en renvoyant la carte d'inscription de la façon indiquée, avec une preuve d'achat ; (ii) la date de fabrication ou (iii) la date d'inscription électronique à condition qu'elle ait lieu dans les 30 jours suivant l'achat. La présente garantie sera nulle si le produit matériel est endommagé lors de son installation. Intel recommande de faire installer le produit matériel par la société auprès de laquelle il a été acheté.

INTEL SE RESERVE LE DROIT DE VOUS LIVRER UN PRODUIT CONTENANT DES COMPOSANTS NOUVEAUX OU REPARÉS. CETTE GARANTIE REMPLACE TOUTES LES AUTRES GARANTIES, EXPRESSES, TACITES OU LEGALES, Y COMPRIS, MAIS SANS QUE CETTE ENUMERATION SOIT LIMITATIVE, LES GARANTIES CONCERNANT LE NON RESPECT DE LA PROPRIÉTÉ INTELLECTUELLE, LA QUALITÉ SATISFAISANTE, L'ADEQUATION POUR UN USAGE PARTICULIER, OU TOUTE AUTRE GARANTIE ISSUE DE TOUT AUTRE PROPOSITION, SPECIFICATION, ECHANTILLON OU AUTRE.

La présente garantie ne couvre pas le remplacement de produits matériels endommagés par abus, accident, mauvaise utilisation, négligence, altération, réparation, catastrophe, installation ou tests incorrects. Si le produit matériel s'avère défectueux pour une autre raison, Intel décidera de le remplacer ou de le réparer gratuitement, à l'exception des cas énumérés ci-après, à condition que le produit soit renvoyé avec un numéro d'autorisation de retour du matériel (ARM) à (a) la société auprès de laquelle il a été acheté ou (b) à Intel, en Amérique du Nord seulement (si l'achat a eu lieu en Europe vous devez le renvoyer à "(a)"). Si vous expédiez le produit matériel, vous devez assumer le risque de dégâts ou de perte pendant le transport. Vous devez utiliser le coffret original (ou l'équivalent) et payer les frais de transport. Intel peut réparer le produit matériel ou le remplacer par un produit neuf ou remis à neuf, le produit renvoyé devenant la propriété d'Intel. Intel garantit que le produit matériel réparé ou de remplacement est exempt de défaut matériel ou de fabrication pendant la plus longue des périodes suivantes: (i) quatre-vingt-dix (90) jours à compter de la date de retour; ou (ii) la période encore couverte par la garantie originale de trois (3) ans.

La présente garantie vous accorde des droits juridiques spécifiques et vous pouvez également disposer d'autres droits variant d'un Etat à l'autre. Tous les composants ou pièces du produit matériel sont couverts par la garantie limitée d'Intel relative à ce dernier ; il peut contenir des pièces recyclées, entièrement testées et garanties comme neuves. Pour plus d'informations sur la garantie, appelez l'un des numéros énumérés ci-après.

### Retour d'un produit défectueux (ARM)

Avant de retourner un produit matériel, contactez le service d'assistance à la clientèle Intel pour obtenir un numéro ARM.

Pays	Numéro	Langue
France	+33 (0) 1 41 91 85 29	Français
Allemagne	+49 (0) 69 9509 6099	Allemand
Italie	+39 (0) 2 696 33276	Italien
R.U.	+44 (0) 870 607 2439	Anglais

Si le service d'assistance confirme que le produit est défectueux, il demandera au Département d'autorisation de retour de matériel de vous attribuer un numéro ARM à indiquer sur l'emballage externe. Intel ne peut accepter aucun produit sans numéro ARM.

### LIMITATION DE RESPONSABILITE ET DE RECOURS

INTEL DECLINE TOUTE RESPONSABILITE RELATIVE A DES DOMMAGES INDIRECTS OU SPECULATIFS (Y COMPRIS, SANS LIMITATION DES ELEMENTS CI-DESSUS, LES DOMMAGES CONSECUTIFS, ACCIDENTELS ET SPECIAUX) DECOULANT DE L'UTILISATION OU DE L'INCAPACITE D'UTILISER CE PRODUIT, DUS A UN CONTRAT, UNE NEGLIGENCE, UN TORT OU COUVERTS PAR TOUTE GARANTIE, MEME SI LA POSSIBILITE D'UN TEL DOMMAGE A DEJA ETE PORTEE A LA CONNAISSANCE D'INTEL, Y COMPRIS, MAIS SANS QUE CETTE ENUMERATION SOIT LIMITATIVE, UNE PRIVATION DE JOUISSANCE, UN NON RESPECT DE LA PROPRIETE INTELLECTUELLE, UNE INTERRUPTION DES ACTIVITES ET UN MANQUE A GAGNER . NONOBTANT LA DECLARATION QUI PRECEDE, LA RESPONSABILITE GLOBALE DE INTEL CONCERNANT TOUS LES LITIGES RELATIFS AU PRESENT ACCORD NE SERA PAS SUPERIEURE AU PRIX PAYE POUR LE PRODUIT. CES LIMITATIONS DE RESPONSABILITE POTENTIELLE ONT CONSTITUE UN FACTEUR DETERMINANT LORS DE LA FIXATION DU PRIX DU PRODUIT. INTEL N'ASSUME AUCUNE AUTRE RESPONSABILITE ET N'AUTORISE QUICONQUE A LE FAIRE EN SON NOM.

**Applications de contrôle critique:** Intel décline toute responsabilité en cas d'utilisation du produit matériel dans le cadre d'applications de contrôle critique (y compris et pour ne citer que des exemples, les systèmes de contrôle de sécurité ou de services médicaux, les systèmes de contrôle d'énergie nucléaire, ou de trafic terrestre ou aérien) par le licencié ou le sous-licencié, l'utilisateur encourt entièrement les risques d'une telle utilisation. Le titulaire de la licence accepte de défendre, d'indemniser et de garantir Intel de toute réclamation survenant par suite de l'utilisation du produit matériel dans de telles applications par le licencié ou le sous-licencié.

**Logiciel:** Le logiciel fourni avec le produit matériel n'est pas couvert par la garantie du matériel décrite ci-dessus. Consultez l'accord de licence du logiciel qui accompagne le produit matériel pour obtenir des détails sur la garantie du logiciel.

La garantie limitée du matériel est régie et interprétée par les lois en vigueur en Angleterre et au Pays de Galles. Les tribunaux anglais jouissent d'une juridiction exclusive en matière de litige concernant cette garantie.

## Garanzia limitata sull'hardware (valida solo in Europa)

Intel garantisce al proprietario originale che il prodotto hardware incluso in questo pacchetto è privo di difetti in materiale e in lavorazione per un periodo di tre (3) anni a partire dall'ultima data tra: (i) la data di acquisto, solo nel caso in cui l'utente effettua la registrazione tramite la scheda di registrazione, come indicato, accompagnata dalla prova di acquisto; oppure (ii) la data di fabbricazione; oppure (iii) la data di registrazione, se effettuata per via elettronica, a condizione che tale registrazione avvenga entro trenta (30) giorni dall'acquisto. Questa garanzia non copre il prodotto nel caso questo fosse danneggiato durante l'installazione. Intel raccomanda di fare installare il prodotto dall'azienda da cui il prodotto è stato acquistato.

INTEL SI RISERVA IL DIRITTO DI ONORARE L'ORDINAZIONE CON UN PRODOTTO CONTENENTE PARTI NUOVE O RIFABBRICATO. LA GARANZIA QUI SOPRA SOSTITUISCE QUALSIASI ALTRA GARANZIA, SIA QUELLA ESPLICITA, IMPLICITA O STATUTORIA, INCLUSO, MA NON LIMITATO A, QUALSIASI GARANZIA DI NON VIOLAZIONE DI PROPRIETÀ INTELLETTUALE, QUALITÀ SODDISFACENTE, IDONEITÀ A QUALSIASI SCOPO PARTICOLARE O QUALSIASI GARANZIA DERIVANTE DA PROPOSTA, SPECIFICAZIONI, CAMPIONI O ALTRO.

Questa garanzia non include la sostituzione di prodotti danneggiati a causa di abuso, incidente, uso inappropriato, negligenza, alterazione, riparazione, disastro, installazione o controllo inadeguati. Se il prodotto viene considerato difettoso per altri motivi, Intel, a sua discrezione, sostituirà o riparerà il prodotto, a proprie spese, eccetto nei casi qui sotto menzionati, a condizione che il prodotto venga consegnato congiuntamente al numero di autorizzazione per la restituzione del materiale (RMA, Return Material Authorization) (a) all'azienda da cui si è acquistato il prodotto, oppure (b) a Intel, solo quando in Nord America (se il prodotto è stato acquistato in Europa, sarà necessario consegnare il prodotto seguendo le modalità indicate in "(a)"). Se il prodotto viene inviato, il mittente si assume la responsabilità in caso di danni o di perdita durante il tragitto. È necessario utilizzare l'imballaggio originale del prodotto (o un suo equivalente) e pagare le spese di spedizione. Intel sostituirà o riparerà il prodotto (o la parte) con uno nuovo o uno rifabbricato, e il prodotto restituito diventerà proprietà di Intel. Intel garantisce che il prodotto riparato o sostituito sarà privo di difetti in materiale e in lavorazione per un periodo comunque non superiore: (i) a novanta (90) giorni dalla data di spedizione all'utente; oppure (ii) al periodo rimanente nella garanzia originale di tre (3) anni.

Questa garanzia dà all'utente diritti legali specifici; potrebbero esistere altri diritti, variabili da stato a stato. Tutte le parti e i componenti contenuti in questo prodotto sono coperti dalla garanzia limitata di Intel relativa a questo prodotto; il prodotto potrebbe contenere parti riciclate, completamente collaudate e garantite come nuove. Per maggiori informazioni sulla garanzia, chiamare uno dei numeri indicati qui sotto.

### Restituzione di prodotti difettosi (RMA)

Prima di restituire un prodotto, contattare l'assistenza tecnica di Intel e richiedere un numero RMA; i numeri verdi sono qui sotto elencati:

Paese	Numero	Lingua
Francia	+33 (0) 1 41 91 85 29	Francese
Germania	+49 (0) 69 9509 6099	Tedesco
Italia	+39 (0) 2 696 33276	Italiano
Regno Unito	+44 (0) 870 607 2439	Inglese

Se il gruppo di supporto alla clientela determina che il prodotto è difettoso, richiederà l'emissione di un numero di autorizzazione per la restituzione del materiale (RMA) da porre all'esterno dell'imballaggio del prodotto. Intel non accetterà prodotti sprovvisti di tale numero visibile sull'imballaggio.

### LIMITAZIONI DI RESPONSABILITÀ E RIMEDI

INTEL NON POTRÀ ESSERE CONSIDERATA RESPONSABILE DI ALCUN DANNO, DIRETTO O SPECULATIVO (INCLUSI, SENZA LIMITAZIONI COME INDICATO IN PRECEDENZA, I DANNI CONSEGUENZIALI, INCIDENTALI E SPECIALI) DERIVANTI DALL'USO O DALLA IMPOSSIBILITÀ DI UTILIZZARE QUESTO PRODOTTO, PER MOTIVI NON CONTEMPLATI NEL CONTRATTO, O DOVUTI A NEGLIGENZA, TORTO O SOTTO QUALSIASI GARANZIA, INDIPENDENTEMENTE DAL FATTO CHE INTEL SIA A CONOSCENZA O MENO DELLA POSSIBILITÀ DI TALI DANNI, INCLUSI, MA NON LIMITATI ALLA PERDITA D'USO, VIOLAZIONE DI PROPRIETÀ INTELLETTUALE, INTERRUZIONI D'AFFARI E PERDITA DI PROFITTI, NONOSTANTE QUANTO DETTO IN PRECEDENZA. LA RESPONSABILITÀ TOTALE DI INTEL NEI CONFRONTI DEI RECLAMI, SECONDO QUESTO ACCORDO, NON ECCEDEDERÀ IL PREZZO PAGATO PER IL PRODOTTO. QUESTE LIMITAZIONI SULLE RESPONSABILITÀ POTENZIALI SONO STATE FATTORE DECISIVO NELLA DETERMINAZIONE DEL PREZZO DEL PRODOTTO. INTEL NON ASSUME, NÉ AUTORIZZA ALCUNO AD ASSUMERE PER SÉ, NESSUN'ALTRA RESPONSABILITÀ.

**Applicazioni di controllo di situazioni critiche:** Intel disconosce specificatamente la responsabilità nel caso di uso dell'hardware in applicazioni di controllo di situazioni critiche (inclusi, al solo scopo di esempio, sistemi di controllo della sicurezza o della salute, dell'energia nucleare, o sistemi di controllo aereo o terrestre) da parte dei licenziatari o dei sottolicenziatari, e tale uso fa parte completamente del rischio intrapreso dall'utente. Il licenziatario è d'accordo nel difendere, indennizzare e liberare Intel da ogni reclamo risultante dall'uso del prodotto hardware in tale applicazioni da parte del licenziatario o del sottolicenziatario.

**Software:** il software accluso al prodotto hardware non è coperto dalla garanzia dell'hardware sopra descritta. Per maggiori dettagli sulla garanzia del software, vedere l'accordo di licenza relativo al software, inviato assieme al prodotto hardware.

Questa garanzia limitata dell'hardware è governata da, ed è conforme a, le leggi di Inghilterra e Galles. Il tribunale di Inghilterra avrà la completa giurisdizione su qualsiasi reclamo presentato sotto questa garanzia.

## Beschränkte Hardwaregarantie (Nur für Europa)

Intel garantiert dem ursprünglichen Eigentümer, daß die in diesem Paket enthaltene Hardware keine Material- oder Herstellungsfehler aufweist. Diese Garantie gilt für drei (3) Jahre (a) nach dem Kaufdatum, wenn die ausgefüllte Registrierungskarte entsprechend den darauf enthaltenen Angaben zusammen mit einem Kaufnachweis eingesendet wurde; oder (b) nach dem Herstellungsdatum; oder (c) nach dem Registrierungsdatum, wenn die Registrierung innerhalb von 30 Tagen auf elektronischem Weg durchgeführt wird. Diese Garantie entfällt, wenn die Hardware bei der Installation beschädigt wird. Intel empfiehlt, die Installation durch den Verkäufer der Hardware durchführen zu lassen.

INTEL BEHÄLT SICH DAS RECHT VOR, IHREN AUFTRAG MIT EINEM PRODUKT ZU ERFÜLLEN, DAS NEUE ODER ERNEUERTE KOMPONENTEN ENTHÄLT. OBIGE GARANTIE GILT ANSTELLE ALLER ANDEREN AUSDRÜCKLICHEN, STILLSCHWEIGENDEN ODER GESETZLICH FESTGELEGTEN GARANTIEEN. AUSGESCHLOSSEN SIND DAMIT AUCH UNTER ANDEREM ALLE GARANTIEEN FÜR DIE VERKEHRSFÄHIGKEIT, DIE VERLETZUNG DER RECHTE VON DRITTEN, DIE EIGNUNG FÜR EINEN BESTIMMTEN ZWECK ODER GARANTIEEN, DIE IM ZUSAMMENHANG MIT EINEM ANGEBOU, EINER SPEZIFIKATION ODER EINEM MUSTER GEGEBEN WURDEN.

Diese Garantie schließt den Hardware-Ersatz bei Beschädigung aufgrund von Mutwilligkeit, Unfall, falscher Verwendung, Fahrlässigkeit, Umänderung, Reparatur, Katastrophen, falscher Installation oder unvorschriftsmäßigem Testen aus. Wenn das Hardwareprodukt aus anderen Gründen beschädigt ist, liegt die Entscheidung bei Intel, ob die Hardware mit Ausnahme der im folgenden beschriebenen Einschränkungen kostenlos ersetzt oder repariert wird. Hierzu müssen Sie das Produkt zusammen mit einer Rückgabenummer (RMA-Nummer, siehe unten) entweder (a) an den Verkäufer des Produkts oder (b) an Intel zurücksenden (bei Kauf in Europa muß das Produkt an "(a)" geliefert werden). Das Risiko des Verlusts oder der Beschädigung während des Transports liegt bei Ihnen als Käufer. Sie müssen zum Versenden die Originalverpackung (oder einen gleichwertigen Ersatz) verwenden und die Versandkosten übernehmen. Intel ersetzt die Hardware entweder durch ein neues oder ein neuwertiges Produkt. Das zurückgegebene Hardwareprodukt wird Eigentum von Intel. Intel garantiert, daß das reparierte oder ersetzte Hardwareprodukt für einen Zeitraum von: (i) neunzig (90) Tagen ab Rückgabedatum oder (ii) für die verbleibende Zeit der ursprünglichen Garantie von drei (3) Jahren frei von Material- und Herstellungsfehlern ist. Dabei gilt jeweils der längere Zeitraum.

Mit dieser Garantie erhalten Sie bestimmte Rechte, die je nach Staat durch weitere Rechte ergänzt werden können. Alle Teile oder Komponenten dieses Hardwareprodukts werden durch die beschränkte Hardwaregarantie von Intel abgedeckt. Das Hardwareprodukt kann vollständig getestete, wiederverwendete Teile enthalten, die derselben Garantie wie neue Produkte unterliegen. Informationen zur Garantie erhalten Sie unter einer der Intel Kundendienstnummern, die am Ende dieses Handbuchs zu finden sind.

### Rückgabe eines beschädigten Produkts (RMA)

Bevor Sie ein Hardwareprodukt zurücksenden, sollten Sie sich vom Intel Kundendienst eine sogenannte RMA-Nummer zuweisen lassen, indem Sie eine der folgenden gebührenpflichtigen Telefonnummern anrufen:

Land	Telefon	Sprache
Frankreich	+33 (0) 1 41 91 85 29	Französisch
Deutschland	+49 (0) 69 9509 6099	Deutsch
Italien	+39 (0) 2 696 33276	Italienisch
GB	+44 (0) 870 607 2439	Englisch

Nachdem die Beschädigung vom Kundendienst bestätigt worden ist, wird von der zuständigen Abteilung eine Rückgabenummer (RMA-Nummer) ausgegeben, die auf der äußeren Verpackung der Hardware angebracht werden muß. Intel akzeptiert kein Produkt ohne RMA-Nummer auf der Verpackung.

### Haftungsbeschränkung und Rechtsmittel

INTEL HAFTET NICHT FÜR INDIREKTE ODER SPEKULATIVE SCHÄDEN (EINSCHLIESSLICH ALLER FOLGESCHÄDEN SOWIE ALLER ZUFÄLLIGEN UND BESONDEREN SCHÄDEN), DIE DURCH DIE VERWENDUNG ODER NICHTVERWENDBARKEIT DIESES PRODUKTS ENTSTEHEN, SEI DIES IM ZUSAMMENHANG MIT EINER VERTRAGLICHEN VERPFLICHTUNG, AUFGUND VON FAHRLÄSSIGKEIT, DURCH UNERLAUBTE HANDLUNGEN ODER IM RAHMEN EINER GARANTIE. DIES GILT AUCH FÜR FÄLLE, IN DENEN INTEL ÜBER DIE MÖGLICHKEIT SOLCHER SCHÄDEN, DIE SICH UNTER ANDEREM DURCH NUTZUNGS-AUSFÄLLE, BETRIEBSUNTERBRECHUNGEN UND GEWINNVERLUSTE ERGEBEN KÖNNEN, IN KENNNTNIS GESETZT WURDE.

UNGEACHTET DER GEWÄHRTEN GARANTIE ÜBERSTEIGT DIE HAFTUNG VON INTEL IM RAHMEN DIESER VEREINBARUNG IN KEINEM FALL DEN KAUFPREIS DES HARDWAREPRODUKTS. DIESE HAFTUNGSBESCHRÄNKUNG IST EIN WESENTLICHER FAKTOR BEI DER FESTLEGUNG DES PREISES FÜR DAS HARDWAREPRODUKT. INTEL ÜBERNIMMT KEINE WEITERE HAFTUNG UND ERTEILT DRITTEN KEINERLEI BEFUGNIS, FÜR INTEL EINE WEITERE HAFTUNG ZU ÜBERNEHMEN.

**Steuer- und Überwachungsanwendung von hoher Wichtigkeit:** Intel schließt insbesondere die Haftung bei der Verwendung des Hardwareprodukts mit Steueranwendungen von hoher Wichtigkeit (z.B. Sicherheits- und Krankenversicherungssysteme, Steuersysteme für Nuklearanlagen sowie Verkehrsüberwachungssysteme für Boden- und Luftverkehr) durch den Lizenznehmer oder Unterlizenznehmer ab, und eine derartige Verwendung liegt ausschließlich in der Verantwortung des Benutzers. Der Lizenznehmer erklärt sich bereit, Intel zu verteidigen und schadlos zu halten bezüglich aller Klagen, die aus der Verwendung eines Hardwareprodukts für solche Zwecke vom Lizenznehmer oder Unterlizenznehmern erhoben werden.

**Software:** Die mit diesem Hardwareprodukt gelieferte Software wird von der oben beschriebenen Hardwaregarantie nicht abgedeckt. Bitte lesen Sie die entsprechende Softwarelizenzvereinbarung, die mit dem Hardwareprodukt geliefert wurde, um genaue Informationen zur Softwaregarantie zu erhalten.

Diese eingeschränkte Hardwaregarantie unterliegt den Gesetzen von England und Wales. Die englischen Gerichte sind Gerichtsstand für alle Klagen, die im Rahmen der Garantie erhoben werden.

## Garantía limitada de hardware (sólo para Europa)

Intel garantiza al propietario original que el producto de hardware entregado en este paquete no tendrá defectos de materiales ni fabricación durante tres (3) años contados a partir de la fecha que resulte más reciente de entre las opciones siguientes: (i) la fecha de compra, sólo si devuelve la tarjeta de registro con prueba de compra de la forma indicada al respecto para registrarse; o bien (ii) la fecha de fabricación; o (iii) la fecha de registro, si éste se ha producido por medios electrónicos y dentro de los treinta (30) días siguientes a la compra. Esta garantía no cubre los daños sufridos por el producto durante el proceso de instalación. Intel recomienda que sea la empresa a la que adquirió el producto la que se encargue de su instalación.

INTEL SE RESERVA EL DERECHO DE CUMPLIMENTAR EL PEDIDO CON UN PRODUCTO QUE CONTENGA COMPONENTES NUEVOS O REFRABRICADOS. LA GARANTÍA ANTERIOR PREVALECE SOBRE CUALQUIER OTRA GARANTÍA, YA SEA EXPLÍCITA, IMPLÍCITA O REGLAMENTARIA, INCLUIDAS, SIN LIMITACIÓN, CUALESQUIERA GARANTÍAS DE NO INFRINGIMIENTO DE LA PROPIEDAD INTELECTUAL, CALIDAD SATISFACTORIA, ADECUACIÓN PARA UNA FINALIDAD DETERMINADA O CUALQUIER GARANTÍA SURGIDA DE CUALQUIER PROPUESTA, ESPECIFICACIÓN, MUESTRA O DE OTRA CLASE.

Esta garantía no cubre la sustitución de productos dañados por abuso, accidente, mal uso, negligencia, alteración, reparación, desastre, instalación incorrecta o pruebas incorrectas. Si el producto tuviera cualquier otro defecto, Intel se reserva la opción de reemplazar o reparar el producto sin cargo alguno, excepto los descritos a continuación, siempre que el producto se entregue con un número de autorización de devolución de material (RMA), a (a) la empresa a la que se adquirió o (b) a Intel, sólo en América del Norte (si lo adquirió en Europa, debe entregar el producto a "(a)"). Si envía el producto, debe asumir el riesgo de daños o pérdida en el transporte. Debe utilizar el embalaje original (o equivalente) y costear los gastos de envío. Intel puede reemplazar o reparar el producto con piezas o productos nuevos o refabricados, y el producto devuelto pasa a ser propiedad de Intel. Intel garantiza que el producto reparado o reemplazado no tendrá defectos materiales ni de fabricación durante el periodo que resulte mayor de los siguientes: (i) noventa (90) días desde la fecha de envío; o (ii) el periodo de tiempo restante de la garantía original de tres (3) años.

Esta garantía le otorga derechos legales concretos y puede tener otros derechos que varían según la jurisdicción. Todas las piezas o componentes que contiene este producto están cubiertos por la garantía limitada de Intel sobre este producto; el producto puede contener piezas recicladas, completamente comprobadas, garantizadas como si de piezas nuevas se tratase. Si desea obtener más información sobre la garantía, puede llamar a uno de los números indicados a continuación.

### Devolución de productos defectuosos (RMA)

Antes de devolver cualquier producto, póngase en contacto con el grupo de Asistencia al cliente de Intel y obtenga un número RMA en uno de los siguientes números no gratuitos:

País	Número	Idioma
Francia	+33 (0) 1 41 91 85 29	Francés
Alemania	+49 (0) 69 9509 6099	Alemán
Italia	+39 (0) 2 696 33276	Italiano
Reino Unido	+44 (0) 870 607 2439	Inglés

Si el grupo de Asistencia al cliente comprueba que el producto es defectuoso, se podrá en contacto con el Departamento de autorización de devolución de material para que éste le envíe un número RMA que debe colocar en el envoltorio externo del producto. Intel no puede aceptar productos sin el número RMA en el paquete.

### LIMITACIÓN DE RESPONSABILIDAD Y REPARACIONES

INTEL NO SERÁ RESPONSABLE DE NINGÚN DAÑO INDIRECTO O ESPECULATIVO (INCLUIDOS, SIN LIMITAR A LOS ANTERIORES, LOS DAÑOS INDIRECTOS, INCIDENTALES Y ESPECIALES) PRODUCIDO POR EL USO O POR LA IMPOSIBILIDAD DEL USO DE ESTE PRODUCTO, YA PROVENGA DE CONTRATO, NEGLIGENCIA, AGRAVIO O BAJO CUALQUIER GARANTÍA, SIN IMPORTAR QUE INTEL HAYA RECIBIDO PREVIO AVISO DE LA POSIBILIDAD DE DICHOS DAÑOS, INCLUIDOS, AUNQUE NO LIMITADOS A, PÉRDIDAS DE USO, INFRINGIMIENTO DE LA PROPIEDAD INTELECTUAL, SUSPENSIÓN DEL EJERCICIO COMERCIAL Y PÉRDIDA DE BENEFICIOS. A PESAR DE LO ANTERIOR, TODA LA RESPONSABILIDAD DE INTEL SOBRE LAS RECLAMACIONES REALIZADAS BAJO ESTE ACUERDO NO EXCEDERÁ EL PRECIO PAGADO POR EL PRODUCTO. ESTAS LIMITACIONES SOBRE LAS RESPONSABILIDADES POTENCIALES HAN CONSTITUIDO UN ELEMENTO ESENCIAL A LA HORA DE DETERMINAR EL PRECIO DEL PRODUCTO. INTEL NO ASUME NI AUTORIZA QUE NINGUNA PERSONA ASUMA EN SU LUGAR NINGUNA OTRA RESPONSABILIDAD.

**Aplicaciones de control crítico:** Intel deniega específicamente la responsabilidad por el uso del producto de hardware en aplicaciones de control crítico (incluidos, sólo a modo de ejemplo, los sistemas de seguridad o atención sanitaria, sistemas de control de energía nuclear o sistemas de control de tráfico aéreo o rodado) por Receptores o Subreceptores de la Licencia, y dicho uso queda enteramente a riesgo del usuario. El Receptor de la Licencia acuerda defender, indemnizar y mantener la inocencia de Intel por y contra toda reclamación surgida del uso del producto de hardware en tales aplicaciones por parte del Receptor o Subreceptor de la Licencia.

**Software:** El software proporcionado con el producto de hardware no está cubierto por la garantía de hardware descrita anteriormente. Si desea obtener información detallada sobre las garantías de software, consulte el acuerdo de licencia correspondiente al software incluido con el producto de hardware.

Esta garantía limitada de hardware se regirá e interpretará de acuerdo con las leyes de Inglaterra y Gales. Los tribunales de Inglaterra tendrán la exclusiva jurisdicción sobre todas las reclamaciones presentadas bajo esta garantía.

# Intel Customer Support

---

You can purchase a range of support services including hardware, software, phone and on-site installation services. Services are designed and packaged for ease of ordering and provide reliable, flexible support for your networking equipment. For details about Intel® NetStructure<sup>SM</sup> Support Services, go to [www.intel.com/network/services](http://www.intel.com/network/services).

## **Worldwide Access to Technical Support**

Intel has technical support centers worldwide. Technicians who speak the local languages staff many of the centers. Visit our Web site at [support.intel.com](http://support.intel.com) or contact your local dealer/distributor.

## **United States and Canada only**

For support, call (800) 838-7136 or (916) 377-7000.

## **Japan only**

For support, call +81-298-47-0800.

## **Other areas**

### **(Access number + 800-838-7136)**

For support in other countries, use the following table to dial the toll-free support number. Using the table, locate the country from which you are calling, dial the access number, wait for the dial tone, and then dial 800-838-7136.

<b>Country</b>	<b>Access Number</b>
Australia	1-800-881-011
Austria <sup>1 4</sup>	022-903-011
Belgium <sup>1</sup>	0-800-100-10
China <sup>3</sup>	10811
Denmark	8001-0010
Finland <sup>1</sup>	9800-100-10
France (Includes Andorra)	19-0011
Germany	0130-0010
Hong Kong	800-1111
India <sup>5</sup>	000-117

---

Indonesia <sup>2</sup>	001-801-10
Italy (Includes Vatican City) <sup>1</sup>	172-1011
Korea <sup>1</sup>	0-911
Malaysia <sup>4</sup>	800-0011
Netherlands <sup>1</sup>	06-022-9111
New Zealand	000-911
Norway	800-190-11
Pakistan	0080001001
Philippines	105-11
Poland <sup>1 3</sup>	0-0-800-111-1111
Portugal <sup>3</sup>	05017-1-288
RSA (South Africa)	0-800-99-0123
Russia <sup>1 2 3</sup>	755-5042
Singapore	800-0111-111
Spain	900-99-00-11
Sri Lanka	430-430
Sweden	020-795-611
Switzerland <sup>1</sup>	0-800-550011
Taiwan <sup>1</sup>	0080-10288-0
Thailand <sup>5</sup>	0019-991-1111
United Kingdom (BT) <sup>3</sup>	0800-89-0011
United Kingdom (Mercury) <sup>3</sup>	0500-89-0011
Vietnam	12010288

---

**Notes:**

- 1 Public phones require coin deposit
- 2 Use phones allowing international access
- 3 May not be available from every phone
- 4 Public phones require local phone payment through the call duration
- 5 Not available from public phones

A30582-001

## Free Manuals Download Website

<http://myh66.com>

<http://usermanuals.us>

<http://www.somanuals.com>

<http://www.4manuals.cc>

<http://www.manual-lib.com>

<http://www.404manual.com>

<http://www.luxmanual.com>

<http://aubethermostatmanual.com>

Golf course search by state

<http://golfingnear.com>

Email search by domain

<http://emailbydomain.com>

Auto manuals search

<http://auto.somanuals.com>

TV manuals search

<http://tv.somanuals.com>