

The Intermec logo is displayed in a dark blue, sans-serif font. It is positioned to the left of a large, light gray graphic consisting of several overlapping circles and lines, resembling a stylized network or orbital diagram. A vertical red line runs down the page, starting from the level of the 'User's Manual' text and extending to the bottom.

User's Manual



**CK30 Handheld
Computer**

Intermec Technologies Corporation

Corporate Headquarters
6001 36th Ave. W.
Everett, WA 98203
U.S.A.

www.intermec.com

The information contained herein is proprietary and is provided solely for the purpose of allowing customers to operate and service Intermec-manufactured equipment and is not to be released, reproduced, or used for any other purpose without written permission of Intermec.

Information and specifications contained in this document are subject to change without prior notice and do not represent a commitment on the part of Intermec Technologies Corporation.

© 2003 by Intermec Technologies Corporation. All rights reserved.

The word Intermec, the Intermec logo, Norand, ArciTech, CrossBar, Data Collection Browser, dcBrowser, Duratherm, EasyCoder, EasyLAN, Enterprise Wireless LAN, EZBuilder, Fingerprint, i-gistics, INCA (under license), InterDriver, Intermec Printer Network Manager, IRL, JANUS, LabelShop, Mobile Framework, MobileLAN, Nor*Ware, Pen*Key, Precision Print, PrintSet, RoutePower, TE 2000, Trakker Antares, UAP, Universal Access Point, and Virtual Wedge are either trademarks or registered trademarks of Intermec Technologies Corporation.

Throughout this manual, trademarked names may be used. Rather than put a trademark (™ or ®) symbol in every occurrence of a trademarked name, we state that we are using the names only in an editorial fashion, and to the benefit of the trademark owner, with no intention of infringement.

Contents

Before You Begin	vii
Safety Summary	vii
Safety Icons	viii
Global Services and Support	ix
Who Should Read This Document?	x
Related Documents	xi
Patent Information	xi
Other Copyright Information	xi

1 Using the CK30 Handheld Computer	1
Introducing the CK30 Handheld Computer	2
Using the Battery	5
Charging and Installing the Battery	5
Maximizing Battery Life	7
Checking the Battery Status	7
Using the Keypad	8
The 42-Key Large Numeric and Function Keypad	9
The 50-Key Full Alphanumeric Keypad	10
The 52-Key Full Alphanumeric Keypad	11
Using the Color-Coded Keys	12
Capitalizing All Characters	13
Using the Alpha Key on the 42-Key Keypad	13
Using the Power (⏻) Key	14
Using the Screen	14
Understanding the Screen Icons	15
Using the Mouse Pointer	16
Repositioning a Window	17
Understanding the Status Lights	18
Understanding the Beeps	19
Scanning Bar Codes	20
Scanning With the Integrated Laser Scanner and 1D Linear Imager	21
Scanning With the 2D Area Imager	22
Attaching a Tethered Scanner	23

Contents

Using the SD Card	25
2 Configuring the CK30	27
How to Configure the CK30 Parameters	28
Configuring the CK30 With the Setup Assistant	29
Configuring the CK30 With the Configuration Utility	30
Configuring the CK30 by Scanning Bar Codes.....	34
Configuring the CK30 Through the Network	35
Configuring the CK30 for Your Network	39
Configuring Serial Communications	39
Configuring 802.11b/g Radio Communications.....	41
Configuring Ethernet Communications	44
Configuring Bluetooth Radio Communications	46
Configuring Security	48
Loading Certificates.....	48
Configuring WPA Security.....	49
Configuring 802.1x Security.....	52
Configuring Static WEP Security	53
Disabling Security	54
Saving Your Configuration Changes to Flash Memory.....	54
3 Developing and Installing Applications	57
Developing Applications for the CK30	58
Developing a New Application for the CK30	58
Developing a Web-Based Application	59
Converting a Trakker Antares Application to a CK30 Application.....	59
Installing Applications on the CK30	60
Installing Applications Using ActiveSync.....	61
Installing Applications Using Your SD Card.....	65
Installing Applications Using the FTP Server.....	65
Installing Applications Using Wavelink Avalanche.....	66
Launching Your Application Automatically	66
Customizing How Applications Load on the CK30	66

4	Managing the CK30	69
	Accessing the System Main Menu.....	70
	Managing Files on the CK30.....	71
	Running an Application From File Manager.....	71
	Deleting a File With File Manager.....	72
	Copying a File With File Manager.....	73
	Viewing the Properties of a File With File Manager.....	73
	Managing Applications on the CK30.....	74
	Viewing All Applications Currently Running on the CK30.....	74
	Closing an Application.....	75
	Switching Between Applications.....	75
	Viewing the Properties of an Application.....	76
	Setting or Changing the System Main Menu Password.....	76
	Backing Up Your Files.....	78
	Upgrading the Operating System.....	79
5	Running Diagnostics	81
	Using Diagnostics on the CK30.....	82
	Understanding the Diagnostics Screens.....	83
	Battery Information.....	83
	Bluetooth Console.....	84
	Bootcode Version.....	85
	Contrast Test.....	85
	Display Test.....	86
	Hardware Configuration Table.....	86
	Installed Fonts.....	87
	Intermec Value Add Information.....	88
	Keypad Test.....	88
	LED Test.....	89
	Memory Information.....	89
	Network Connection Test.....	89
	Network Interface Information.....	90
	Operating System Version.....	91
	Ping Utility.....	91
	PSC Utility.....	92

Contents

	Radio SSI Utility	92
	Read CPU Registers	93
	Sound Test.....	93
6	Troubleshooting and Maintaining the CK30.....	95
	Problems and Solutions	96
	Problems While Operating the CK30.....	96
	Problems While Configuring the CK30.....	97
	Problems While Configuring 802.1x Security.....	97
	Problems With Wireless Connectivity	99
	Problems Transmitting Data Through the Serial Port.....	100
	Problems While Scanning Bar Codes.....	100
	Booting the CK30	102
	Warm Booting the CK30	103
	Cold Booting the CK30	103
	Cleaning the Scanner Window and CK30 Screen	104
A	Appendix.....	105
	Physical and Environmental Specifications.....	106
	Accessories for the CK30	109
	Typing Characters Not Printed on the Keypad	111
	Default Configuration	115
I	Index.....	119

Before You Begin

This section provides you with safety information, technical support information, and sources for additional product information.

Safety Summary

Your safety is extremely important. Read and follow all warnings and cautions in this document before handling and operating Intermec equipment. You can be seriously injured, and equipment and data can be damaged if you do not follow the safety warnings and cautions.

Do Not Repair or Adjust Alone

Do not repair or adjust energized equipment alone under any circumstances. Someone capable of providing first aid must always be present for your safety.

First Aid

Always obtain first aid or medical attention immediately after an injury. Never neglect an injury, no matter how slight it seems.

Resuscitation

Begin resuscitation immediately if someone is injured and stops breathing. Any delay could result in death. To work on or near high voltage, you should be familiar with approved industrial first aid methods.

Energized Equipment

Never work on energized equipment unless authorized by a responsible authority. Energized electrical equipment is dangerous. Electrical shock from energized equipment can cause death. If you must perform authorized emergency work on energized equipment, be sure that you comply strictly with approved safety regulations.

Before You Begin

Safety Icons

This section explains how to identify and understand warnings, cautions, and notes that are in this document.



A warning alerts you of an operating procedure, practice, condition, or statement that must be strictly observed to avoid death or serious injury to the persons working on the equipment.

Avertissement: Un avertissement vous avertit d'une procédure de fonctionnement, d'une méthode, d'un état ou d'un rapport qui doit être strictement respecté pour éviter l'occurrence de mort ou de blessures graves aux personnes manipulant l'équipement.



A caution alerts you to an operating procedure, practice, condition, or statement that must be strictly observed to prevent equipment damage or destruction, or corruption or loss of data.

Attention: Une précaution vous avertit d'une procédure de fonctionnement, d'une méthode, d'un état ou d'un rapport qui doit être strictement respecté pour empêcher l'endommagement ou la destruction de l'équipement, ou l'altération ou la perte de données.



Note: Notes either provide extra information about a topic or contain special instructions for handling a particular condition or set of circumstances.

Global Services and Support

Warranty Information

To understand the warranty for your Intermec product, visit the Intermec web site at <http://www.intermec.com> and click **Service & Support > Service & Support. The Intermec Global Sales & Service page appears.** From the **Service & Support** menu, move your pointer over **Support**, and then click **Warranty**.

Disclaimer of warranties: The sample code included in this document is presented for reference only. The code does not necessarily represent complete, tested programs. The code is provided "as is with all faults." All warranties are expressly disclaimed, including the implied warranties of merchantability and fitness for a particular purpose.

Web Support

Visit the Intermec web site at <http://www.intermec.com> to download our current manuals in PDF format. To order printed versions of the Intermec manuals, contact your local Intermec representative or distributor.

Visit the Intermec technical knowledge base (Knowledge Central) at <http://intermec.custhelp.com> to review technical information or to request technical support for your Intermec product.

Before You Begin

Telephone Support

These services are available from Intermec by calling 1-800-755-5505 and choosing an option.

Service	Description	In the U.S.A. and Canada, choose this option
Factory Repair and On-site Repair	Request a return authorization number for authorized service center repair, or request an on-site repair technician.	1
Technical Support	Get technical support on your Intermec product.	2
Service Contract Status	Inquire about an existing contract, renew a contract, or ask invoicing questions.	3
Schedule Site Surveys or Installations	Schedule a site survey, or request a product or system installation.	4
Ordering Products	Talk to sales administration, place an order, or check the status of your order.	5

Outside the U.S.A. and Canada, contact your local Intermec representative. To search for your local representative, from the Intermec web site, click **Contact**.

Who Should Read This Document?

The *CK30 Handheld Computer User's Manual* provides you with information about the features of the CK30 and how to install, operate, maintain, and troubleshoot the CK30. Before you install and configure the CK30, you should be familiar with your network and general networking terms, such as IP address.

The *CK30 Command Reference Manual* is included with this manual on a CD or is available as a download from the Intermec web site. Please refer to this manual for help configuring your CK30. The reference manual contains information about all of the CK30 commands and contains pages of bar codes that you can print and scan when configuring supported commands.

Related Documents

The Intermec web site at <http://www.intermec.com> contains our documents that you can download in PDF format.

To order printed versions of the Intermec manuals, contact your local Intermec representative or distributor.

Patent Information

Product is covered by one or more of the following patents:

4,455,523; 5,627,360; 4,553,081; 5,657,317; 4,709,202; 5,671,436;
4,845,419; 5,684,290; 4,961,043; 5,777,309; 5,195,183; 5,793,604;
5,216,233; 5,805,807; 5,218,187; 5,818,027; 5,218,188; 5,821,523;
5,227,614; 5,828,052; 5,241,488; 5,831,819; 5,278,487; 5,834,753;
5,322,991; 5,841,121; 5,331,136; 5,844,222; 5,331,580; 5,883,492;
5,349,678; 5,883,493; 5,397,885; 5,886,338; 5,371,858; 5,889,386;
5,373,478; 5,898,162; 5,410,141; 5,969,328; 5,488,575; 5,986,435;
5,500,516; 6,075,340; 5,504,367; 6,109,528; 5,508,599; 6,158,661;
5,530,619; 6,234,395; 5,567,925; 6,244,512; 5,568,645; 6,330,975;
5,592,512; 6,431,451; 5,598,007; 6,497,368; 5,617,343; 6,538,413.

There may be other U.S. and foreign patents pending.

Other Copyright Information

Microsoft, Windows, and the Windows logo are registered trademarks of Microsoft Corporation in the United States and/or other countries.

Bluetooth is a trademark of Bluetooth SIG, Inc., U.S.A.

Wi-Fi is a registered certification mark of the Wi-Fi Alliance.

This product includes software developed by the OpenSSL Project for use in the OpenSSL Toolkit.
(<http://www.openssl.org/>)

This product includes cryptographic software written by Eric Young. (eay@cryptsoft.com)

This product uses Regex++, Index software during its operational phases. The owner of Regex++ has granted use of the software to anyone provided such use is accompanied by the following copyright and permission notice:

Regex++, Index. (Version 3.31, 16th Dec 2001)

Before You Begin

Copyright © 1998-2001 Dr John Maddock

Permission to use, copy, modify, distribute and sell this software and its documentation for any purpose is hereby granted without fee, provided that the above copyright notice appear in all copies and that both that copyright notice and this permission notice appear in supporting documentation. Dr John Maddock makes no representations about the suitability of this software for any purpose. It is provided “as is” without express or implied warranty.



1 Using the CK30 Handheld Computer

Use this chapter to familiarize yourself with the CK30 Handheld Computer. In this chapter you will find these sections:

- Introducing the CK30 Handheld Computer
- Using the Battery
- Using the Keypad
- Using the Screen
- Understanding the Status Lights
- Understanding the Beeps
- Scanning Bar Codes
- Using the SD Card

Introducing the CK30 Handheld Computer

The Intermec CK30 is an ergonomically designed handheld computer built on the Microsoft® Windows® CE .NET operating system. It is a lightweight, easy-to-use, reliable computer that runs client/server applications, terminal emulation applications, as well as browser-based applications.

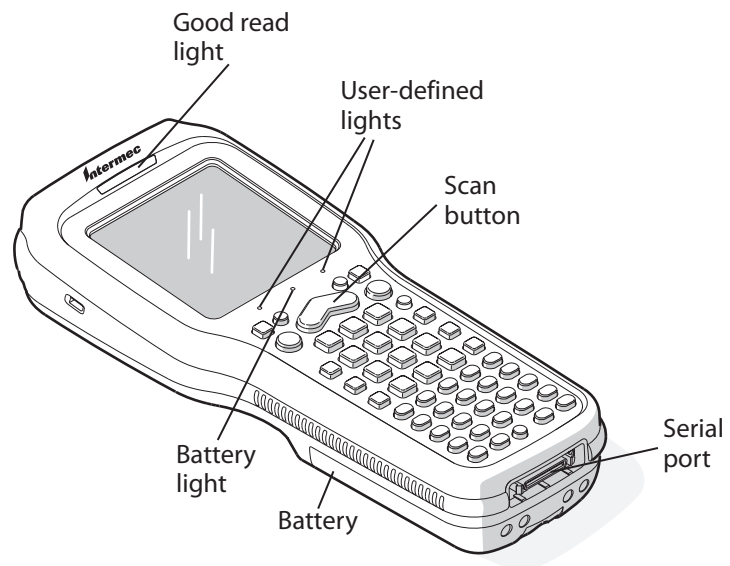

CK30 Handheld Computer



CK30 Handheld Computers with an IEEE 802.11b/g radio installed are Wi-Fi® certified for interoperability with other 802.11b/g wireless LAN devices.

The CK30 computer is available in three different models that offer several options. To find out which model of the CK30 you have, locate the configuration label on the back of the computer. The first five characters of the configuration number indicate the model of CK30 you ordered.

Chapter 1 — Using the CK30 Handheld Computer

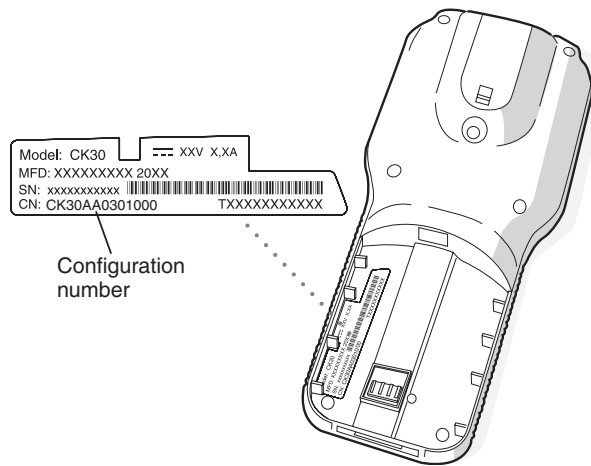

Configuration Label: The label in this illustration is for a CK30 Model A (CK30A).

Features Included With the Different Models of the CK30

Feature	CK30A	CK30B	CK30C
Ethernet (optional)	✓		
802.11b/g radio		✓	✓
*Bluetooth (optional)	✓	✓	✓
.NET Compact Framework			✓
Pocket Internet Explorer	✓	✓	
Internet Explorer 6, SQL Server CE			✓
iBrowse	✓	✓	
Color Display			✓
Monochrome Display	✓	✓	
32MB RAM/32MB Flash Memory	✓	✓	
64MB RAM/64MB Flash Memory			✓
200 MHz Processor	✓	✓	
400 MHz Processor			✓

*Bluetooth is a trademark owned by Bluetooth SIG, Inc., USA.

For a complete list of accessories, see “Accessories for the CK30” on page 109.

Chapter 1 — Using the CK30 Handheld Computer

These options are available for the CK30B and CK30C:

- TE 2000 terminal emulation application including 3270, 5250, and VT/ANSI as well as third-party TE applications
- 1D linear imager, standard, or advanced long-range scanner
- Data Collection Browser (dcBrowser™) application

This option is only available for the CK30C:

- 2D area imager

Use this manual to understand how to use the features and options available on the CK30. For additional help using terminal emulation, see the appropriate TE 2000 guide:

- *TE 2000 VT/ANSI Terminal Emulation Programmer's Guide* (P/N 977-055-005)
- *TE 2000 5250 Terminal Emulation Programmer's Guide* (P/N 977-055-004)
- *TE 2000 3270 Terminal Emulation Programmer's Guide* (P/N 977-055-003)

For additional help using dcBrowser, see the documentation that ships with the dcBrowser gateway software or the *Data Collection Browser Client User's Guide* (P/N 070011).

iBrowse is a locked-down web browser for Intermec devices that is compatible with Microsoft's Internet Explorer but does not allow the user to exit out of the browser or key in a URL to access a non-work related web site. For additional help using iBrowse, see the *iBrowse User's Guide* (P/N 961-055-015).

Using the Battery

The CK30 uses an AB1 lithium-ion battery as its main power source. You must fully charge the main battery before you can use the CK30. When you change the battery, a backup battery maintains your status, memory, and real-time clock for at least 10 minutes.



Warning

The lithium-ion battery pack that is used in this device may present a fire or chemical burn hazard if it is mistreated. Do not disassemble it, heat it above 100°C (212°F) or incinerate it.

Avertissement: Le paquet de piles d'ions de lithium qui est utilisé dans cet appareil peut présenter un risque feu ou un risque chimique de brûlure s'il est maltraité. Il ne faut pas le désassembler, le réchauffer à une température plus élevée que 100°C (212°F) ou l'incinérer.



Caution

If you fail to replace the battery immediately, you may lose important data or applications.

Attention: Si la batterie n'est pas remplacée immédiatement, des données ou applications importantes risquent d'être perdues.

Dispose of used battery packs promptly. Keep away from children. Contact your local Intermec sales representative for replacement batteries.

Several factors determine the life of your battery such as extreme temperatures, input devices, and your usage. For example, if you use a tethered scanner every day, you will need to replace your battery more often than someone who uses an internal scanner.

Charging and Installing the Battery

Make sure you fully charge the AB1 battery before you install it in your CK30.

Chapter 1 — Using the CK30 Handheld Computer

To charge the battery

- Either insert the battery into the AC1 4-slot battery charger or place the CK30 with battery installed in the AC2, AD1, or AD2. For more information on these accessories, see page 109.

Use the following table to understand how long it will take to charge your batteries in each of the CK30 charging or communications dock accessories.

Charging Times for CK30 Batteries

CK30 Accessory	Charging Time
AC1 4-Slot Battery Charger	5 hours
AC2 4-Bay Charging Dock	5 hours
AD1 1-Bay Communications Dock	3 hours
AD2 4-Bay Communications Dock	5 hours

To install the battery

- Insert the tabs on the bottom of the charged battery into the CK30 and snap the battery into place.

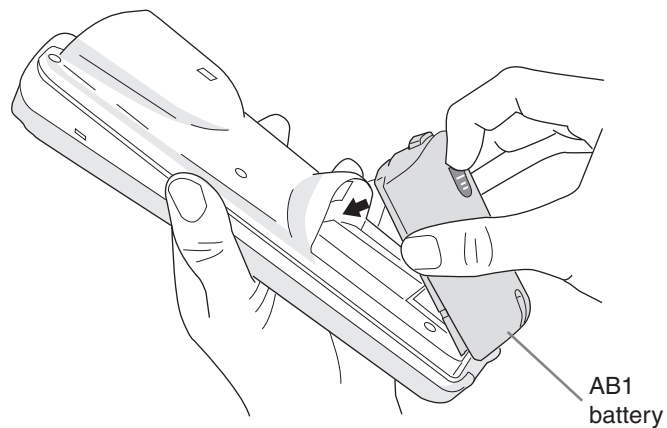

Maximizing Battery Life

There are several things that you can do to maximize the life of your battery.



Maximizing the Life of Your Battery

When You Want To:	Do This to Save Battery Power:
Operate the CK30 and the Low Battery status icon appears or the Battery light comes on.	<ol style="list-style-type: none"> 1 Press $\frac{1}{2}$ to turn off the CK30. 2 Remove the battery and insert another fully charged battery as quickly as possible or you may lose data. Or, you can insert the CK30 into a powered AC2, AD1, or AD2.
Stop using the CK30 for 5 minutes or longer.	<ol style="list-style-type: none"> 1 Make sure the low battery icon is not on the screen and that the Battery light is not turned on. 2 Press $\frac{1}{2}$ to turn off the CK30.
Store the CK30 for more than a day.	<ol style="list-style-type: none"> 1 Save your data and end your computer session. 2 Press $\frac{1}{2}$ to turn off the CK30. 3 Insert a fully charged battery.

Checking the Battery Status

The easiest way to tell the status of your battery is to look at the battery icon in the status bar of your CK30.

Battery Icon Status

Icon	Status
	Battery has a medium charge. You should be able to work for several more hours before changing batteries.
	Battery is low. You need to replace the battery soon.
	Battery is critically low. You need to replace the battery now.

You can also check the battery status by looking at the Battery Status light on the front of the CK30 or by using the battery diagnostics screen. For help using the Battery Status light, see “Understanding the Status Lights” on page 18 for more information. For help using the Battery Information diagnostic screen, see “Battery Information” on page 83.

Using the Keypad

Your CK30 has one of the following keypad overlay options:

- 42-key large numeric and function
- 50-key full alphanumeric
- 52-key full alphanumeric

You can order all versions of the CK30 keypad with an international overlay. The international overlay supports English and many Western European languages, such as French, German, Italian, Portuguese, and Spanish. You enter all of the characters and functions printed above the keys just like you would on a standard keypad.



Note: There are several hidden characters (such as { and }) on each CK30 keypad that require using the color-coded keys to access them. For more information on accessing these hidden characters, refer to “Typing Characters Not Printed on the Keypad” on page 111.

The CK30 supports TE 2000 VT100/220/320/340 and ANSI, TE 2000 5250, and TE 2000 3270. When you order the CK30 with a TE 2000 application, you must order the corresponding keypad overlay. Use the TE 2000 keypad overlays to enter the same keys that you can enter on a VT/ANSI keyboard, an IBM 5250 keyboard, or an IBM 3270 keyboard.

Like the standard CK30 keypad overlays, the TE 2000 keypad overlays let you enter all the characters printed on or above the keys. The terminal emulation keypads also come with the same color-coded keys that are on the standard overlay.

For more help using TE 2000 terminal emulation, see the appropriate TE 2000 programmer’s guide.

The 42-Key Large Numeric and Function Keypad

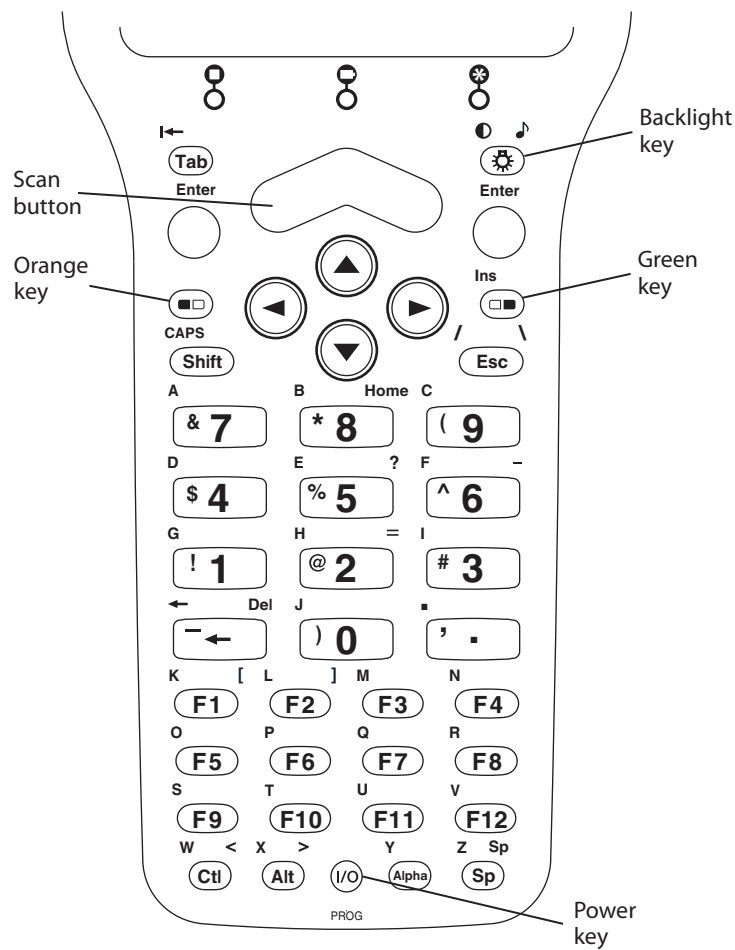

42-key large numeric and function keypad: This keypad is designed for applications that enter mainly numeric data (0-9) and that need dedicated function keys (F1- F12). This keypad also lets you enter the entire alphabet and special characters by pressing color-coded key sequences.

The 50-Key Full Alphanumeric Keypad

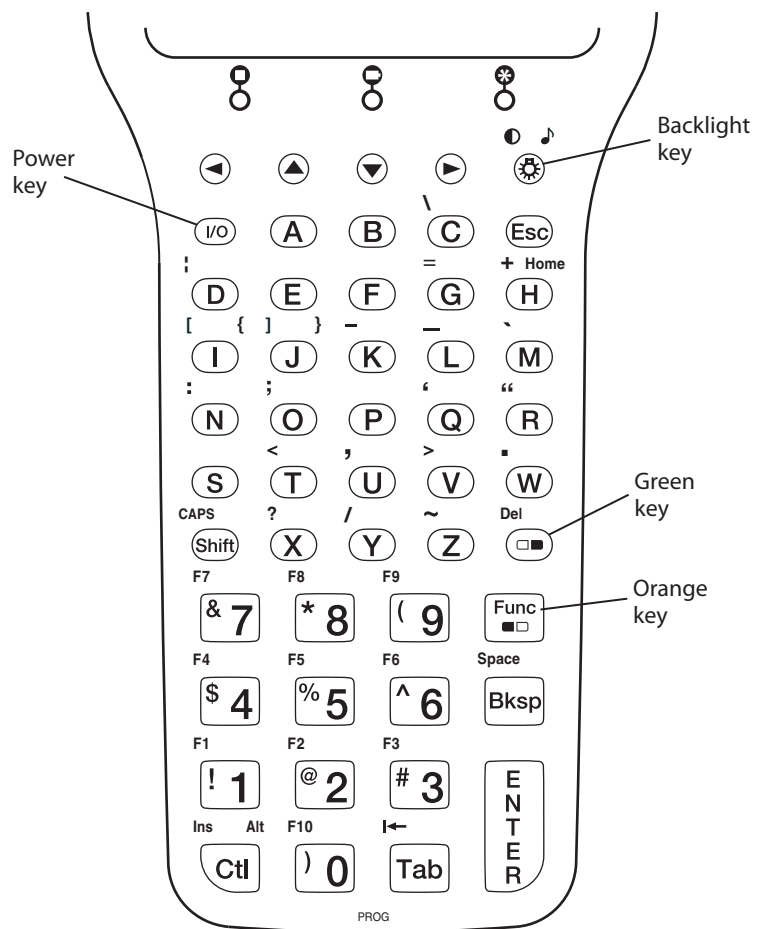

50-key full alphanumeric keypad: This keypad is designed for applications that enter mainly numeric data (0-9) and that may need to enter the entire alphabet. The keypad also provides shifted function keys (F1-F9) and special characters, symbols, and functions by pressing color-coded key sequences.



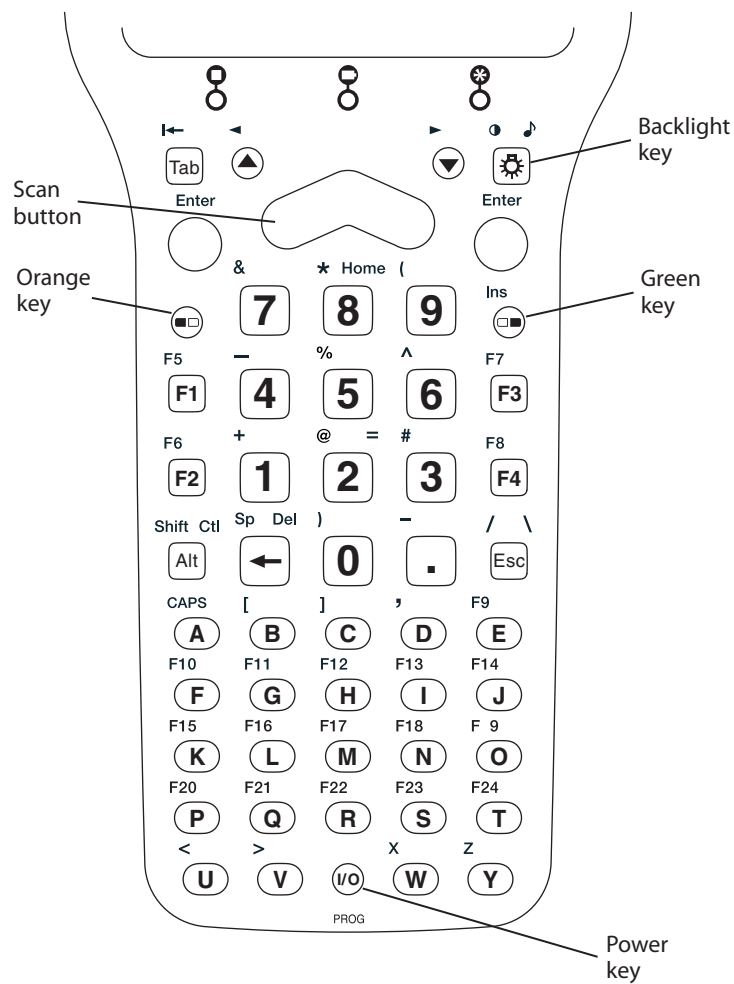

Note: The 50-key keypad does not have a scan key, because it was designed to work with the required AH1 handle that has a built-in scanner trigger.

The 52-Key Full Alphanumeric Keypad











52-key full alphanumeric keypad: This keypad is designed for applications that enter mainly numeric data (0-9) and that may need to enter the entire alphabet. The keypad also provides function keys (F1-F24) and special characters, symbols, and functions by pressing color-coded key sequences.

Using the Color-Coded Keys

Each keypad available for the CK30 provides color-coded keys to let you access additional characters, symbols, and functions printed on the keypad overlay. Once you understand how to use the color-coded keys and key sequences, you will know how to access all of the additional features printed on the keypad overlay. There are two color-coded modifier keys on the CK30: the orange  key and the green  key.

You press and release the first key and then press and release the second key to access the color-coded character or function printed above a key.

Using the Color-Coded Keys

You Want To:	Press:	Example
Use an orange character or function printed above a key	 key and then the key with character or function printed above it	Press  and then 2 to type the @ character on the 52-key keypad.
Use a green character or function printed above a key	 key and then the key with character or function printed above it	Press  and then J to type the } character on the 50-key keypad.
Use a blue character printed on a key (42-key and 50-key keypads only)	Shift key and then the key	Press Shift and then 4 to type the \$ character on the 42-key keypad.
Lock the orange, green, Ctrl , Alt , or Shift key to stay on	 ,  , Ctrl , Alt , or Shift key twice	
Unlock a green, orange, Ctrl , Alt , or Shift key	 ,  , Ctrl , Alt , or Shift key once	





Note: There are several hidden characters (such as { and }) on each CK30 keypad that require using the color-coded keys to access them. For more information on accessing these hidden characters, refer to “Typing Characters Not Printed on the Keypad” on page 111.

Capitalizing All Characters

To type all alphabetic characters as uppercase letters, you can enable the Caps Lock feature on the CK30 keypad.

To enable Caps Lock

- 1 Press the orange  key. The  icon appears on the status bar.
- 2 Press one of these keys:
 - On the 52-key keypad, press **A**.
 - On the 42-key and 50-key keypad, press **Shift**.

The Caps Lock icon () appears on the status bar.

- 3 Type an alphanumeric character. The letter appears as an uppercase character on the CK30 screen.

To disable Caps Lock

- Press the same key sequence you used to enable it.

Using the Alpha Key on the 42-Key Keypad

The 42-key keypad provides an **Alpha** key to allow you to enter alpha characters when necessary.

To enable the Alpha key

- 1 On the 42-key keypad, press the **Alpha** key. The Alpha icon () appears on the status bar.
- 2 Press a function or numeric key. The corresponding orange alpha letter appears on the screen.

To disable the Alpha key

- Press  or .

Using the Power (⏻) Key

When you press the **⏻** key to turn off the CK30, you actually put the CK30 in Suspend mode. In Suspend mode, the CK30 continues to supply power to all memory, but turns off power to most hardware. This power-saving feature is designed to prolong battery life.

When you press the **⏻** key to turn the CK30 back on, your computer resumes where it was when you turned it off.

If you are using WPA or 802.1x security, the computer may need to reauthenticate before it starts your application.

If the Battery light flashes and your CK30 does not resume after pressing **⏻**, your battery may be too low to supply power. Replace the battery. If replacing the battery does not solve the problem, see “Booting the CK30” on page 102.

Using the Screen

The CK30 can have either a color or monochrome display depending on the model. Both screens are 160 x 160 pixels. The work area is 160 x 140 pixels and the status bar is 160 x 20 pixels. In addition, the screens support Unicode characters, user-programmable fonts, and bitmap graphics.

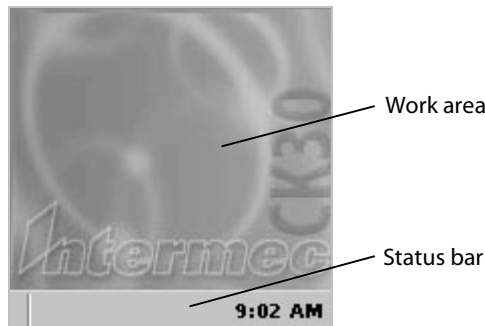

CK30 Start Screen

Understanding the Screen Icons

Use the screen icons on the status bar to see the battery status, network connections, and special keys or functions you may be using.

CK30 Screen Icons

Icon	Description
	Battery is half full. You should be able to work for several more hours before changing batteries.
	Battery is low. You need to replace the battery soon.
	Battery is critically low. You need to replace the battery now.
	Backup battery is low.
	Strong connection to the access point.
	Good connection to the access point.
	Weak connection to the access point.
	No connection to the access point.
	No Ethernet connection.
	Ethernet connection.
	Orange key is enabled.
	Green key is enabled.
	Orange key is locked.
	Green key is locked.
	Alt key is enabled.
	Ctrl key is enabled.
	Shift key is enabled.
	Caps Lock key is enabled.
	Alpha key is enabled.
	The CK30 is buffering (storing) data.
	You are in the password-protected area of the CK30.
	The CK30 is connected using ActiveSync.
	Mouse pointer is turned on.
	No UDP Plus connection.
	UDP Plus is transferring data.
	UDP Plus is connected.
	The window positioning feature is turned on.

Using the Mouse Pointer

If you need to use a mouse to perform an action, you can use the mouse pointer on your CK30.

To turn on the mouse pointer

- Press **Alt** and then **▼**.

The mouse pointer can simulate single-clicks, double-clicks, right mouse button, middle mouse button, and left mouse button functions.

Understanding the Mouse Pointer Keys

To Simulate This Function:	Press This Key on a Keypad:		
	42-key	50-key	52-key
Left mouse button	F2	X	B
Middle mouse button	F3	Y	C
Right mouse button	F4	Z	D
Single-click	5	5	5
Double-click	←	←	←
Press down on mouse button	0 (zero)	0 (zero)	0 (zero)
Release the mouse button	. (period)	Tab	. (period)

For example, to generate a left single-click with the 52-key keypad

- Press **B** and then **5**.

Moving the mouse pointer around the screen is very easy. You just need to press the appropriate number key that is associated with the direction you want the mouse pointer to move.

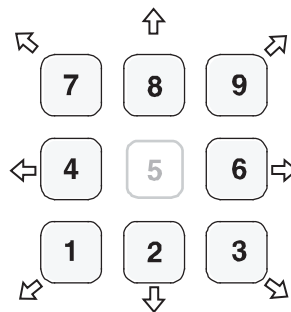

Use the numeric keypad to move the mouse pointer.

To click and drag an item on the screen

- 1 Position the mouse pointer on the part of the window you want to move.
- 2 Press the key for the left mouse button and then press **0** (zero).
- 3 Use the directional keys to drag the mouse pointer.
- 4 Release the mouse pointer by pressing **.**(period) or **Tab** depending on your keypad.



To turn off the mouse pointer

- Press **Alt** and then **▼**.

Repositioning a Window

If you need to move a window to see more of a screen, you can reposition the window without having to use the mouse pointer. When you turn on the positioning feature, the focus is on the top window. You can change the focus to another window by using the Task Manager to select a different task. See “Managing Applications on the CK30” on page 74.

To reposition a window

- 1 Press **Alt** and then . An icon () appears on the status bar.
- 2 Use the numeric keypad to move the window. See page 16 for an illustration of the numeric keypad and how to use the number keys as directional keys.

To recenter the window in the CK30 screen

- Press **5**.

To turn off the repositioning feature

- Press **Alt** and then .

Understanding the Status Lights

The status lights on the CK30 turn on to indicate the status of the battery, a successful decode of a bar code, or a user-defined function.

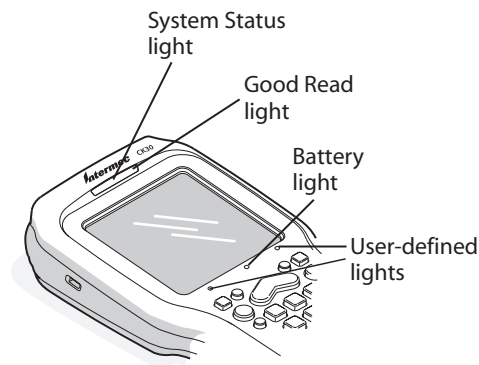

CK30 Status Lights

The battery light and the battery screen icons work with each other to alert you to the status of your battery. If the battery light comes on, check the status bar to see which battery icon appears on it. Use the CK30 Screen Icons table on page 15 to help determine when you need to replace your battery.

Understanding the CK30 Status Lights

Light Name	Light	Description						
User-Defined	■ ✱	Use the Software Developer's Kit (SDK) to program these lights to turn on and off for any task or error within your application. For help, see the <i>Intermec SDK User's Manual</i> available on the Intermec Developer's Library CD or the Intermec web site.						
Battery	■	<table border="0"> <thead> <tr> <th>Light Status</th> <th>What It Means</th> </tr> </thead> <tbody> <tr> <td>Off</td> <td>The battery is charged.</td> </tr> <tr> <td>On</td> <td>Battery is critically low. You need to replace the battery now.</td> </tr> </tbody> </table>	Light Status	What It Means	Off	The battery is charged.	On	Battery is critically low. You need to replace the battery now.
Light Status	What It Means							
Off	The battery is charged.							
On	Battery is critically low. You need to replace the battery now.							
Good Read		This light comes on when the CK30 successfully decodes a bar code.						
System Status		Reserved for future use.						

Understanding the Beeps

The CK30 uses beeps to provide you with audio feedback when it performs some functions. For example, you hear a beep each time you scan a valid bar code.

Understanding the CK30 Beeps

Beep Sequence	What it Means
High beep	You entered valid data or a valid command, the CK30 decoded a label, or the CK30 decoded the last row of a two-dimensional bar code.
Three low beeps	You entered or scanned an invalid command.
Click	You pressed a key.

You can change the beeper volume for your needs and environment. You can set the beeper volume to off, low (quiet), medium, high (loud - default), and very high (very loud). If necessary, you can also change the beep duration and beep frequency for good read, low, and high beeps.

Changing the Beeper Volume

Method	Procedure
Use the keypad.	Press □■ and then press ⌘ to increase the volume. There are five beep volumes on the CK30 including off. When you reach the loudest setting, the next setting is off. The volume starts with the lowest setting and goes up.
Use the Intermec Configuration menu.	From the System Main Menu, choose Configuration Utility > CK30 Settings > Beeper > Volume .
Use the Beeper Volume command.	For help, see “Beeper Volume” in the <i>CK30 Command Reference Manual</i> .

Scanning Bar Codes



Do not look directly into the window area or at a reflection of the laser beam while the laser is scanning. Long-term exposure to the laser beam can damage your vision.

Avertissement: Ne regardez pas directement la réflexion d'un rayon laser ou dans la fenêtre du laser lorsque celui-ci est en opération. Si vous regardez trop longtemps un rayon laser, cela peut endommager votre vue.

Use the scanner to scan and enter bar code data. The type of scanner you are using and the type of bar code you are decoding determines the way you scan the bar code. The CK30 supports the scanning of 1D linear bar codes and 2D images depending on your model of CK30. Plus, if you are using an integrated handle or a tethered scanner, the way you scan bar codes is different.

When you unpack the CK30, these bar code symbologies are enabled:

- Code 39
- UPC/EAN
- PDF417

If you are using bar code labels that are encoded in a different symbology, you need to enable the symbology on the computer. Use the Configuration Utility to enable and disable symbologies for your scanner. For help understanding how to use the Configuration Utility, see “Configuring the CK30 With the Configuration Utility” on page 30.

The next sections describe how to scan a bar code label with the integrated laser scanner, 1D linear imager, 2D area imager, and tethered scanner.

Scanning With the Integrated Laser Scanner and 1D Linear Imager

If the CK30 has a laser scanner or 1D linear imager, use the following procedure to practice how to scan a bar code. The linear imager can decode PDF417 bar codes as well as bar codes with high-density, wide-density, and poor quality in any lighting conditions.

To scan a bar code label with the laser scanner and 1D linear imager

- 1 Press $\frac{1}{6}$ to turn on the CK30.
- 2 Point the scanner window at the bar code label and hold the computer at a slight angle six to ten inches from the label.



Note: If you have an advanced long-range scanner, you may need to hold the computer further away from the label.

- 3 Press the **Scan** button on the keypad or pull the trigger on a handle and direct the red beam so that it falls across all bars in the bar code label.

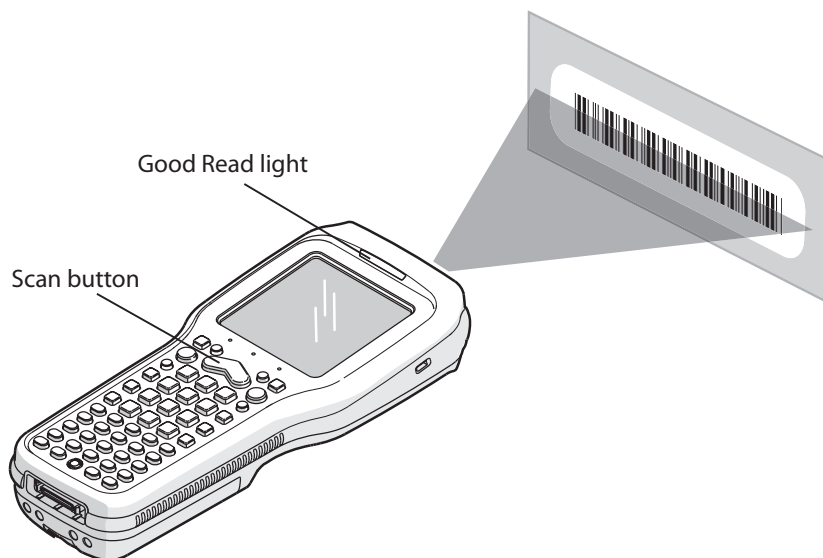

Scanning: Using the integrated laser scanner or 1D linear imager to scan a bar code label.

Chapter 1 — Using the CK30 Handheld Computer

When the CK30 successfully reads a bar code label, you hear a high beep and the green Good Read light turns on briefly.

- 4 Release the **Scan** button.

Scanning With the 2D Area Imager

The CK30C may have the 2D area imager option instead of the 1D linear imager or laser scanner. The 2D imager provides the ability to scan 2D bar code symbologies and supports omnidirectional (360°) scanning. Omnidirectional scanning means that you can position the CK30 in any orientation to scan a bar code label. Using the 2D area imager is very similar to taking a picture with a digital camera.

To scan a bar code label with the 2D area imager

- 1 Press **⏻** to turn on the CK30.
- 2 Point the scanner window at the bar code label and hold the CK30 steady a few inches from the label.
- 3 Press the **Scan** button on the keypad or pull the trigger on a handle and center the red aiming beam over the bar code label.

The imager flashes repeatedly while it is trying to read a bar code. The aiming beam is smaller when the imager is closer to the bar code and larger when it is further away.

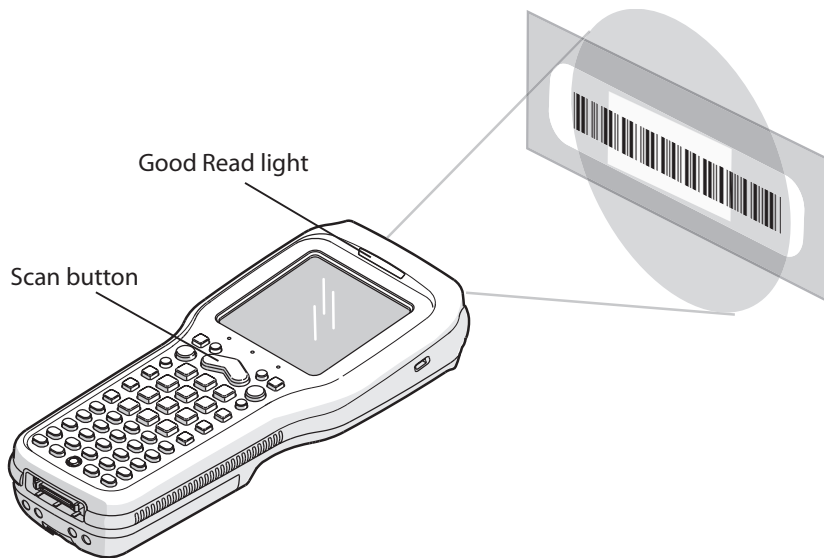

Scanning: Using the 2D imager to scan a bar code label.

When the CK30 successfully reads a bar code label, you hear a high beep and the green Good Read light turns on briefly.

- 4 Release the **Scan** button.

Attaching a Tethered Scanner

You can use a tethered scanner with the CK30 if you ordered it with a 10-pin tethered scanner port in place of the integrated scanner.

The following devices are currently supported by the CK30:

Supported Device	Required Cable
1550C	068419-001
1551E	3-606034-02
1553	3-606034-02
128X wand	069444-002
Wand emulation	3-606031-00

Supported 1550C series scanners include: 1550C0100, 1550C102, 1550C104, and 1550C105.

To attach a tethered scanner

- 1 Locate and remove the scanner port cover.

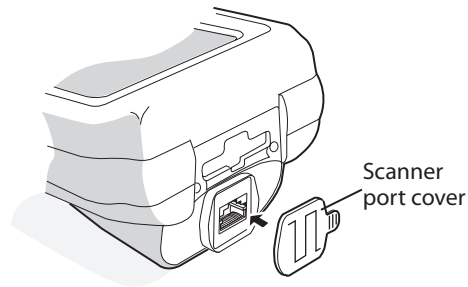

- 2 Insert the scanner 10-pin connector until it locks in place.

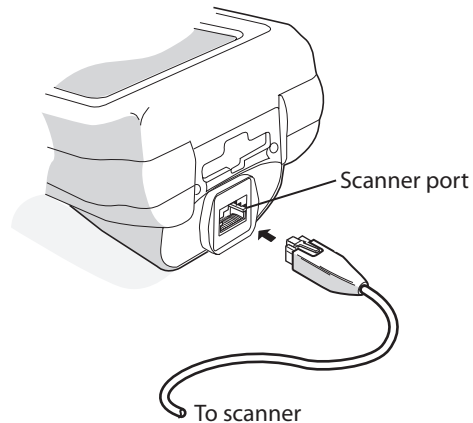

- 3 Configure the Scanner Model command and select the tethered device connected to the CK30. There are several ways to configure the scanner model:
 - Use the Configuration Utility. From the System Main Menu, choose **Configuration Utility > Scanners, Symbologies > CK30 Tethered Scanner > Scanner Model**.
 - Use one of the configuration methods discussed in “How to Configure the CK30 Parameters” on page 28.
- 4 Modify any scanner commands necessary to meet your needs. Use the Configuration Utility or one of the configuration methods discussed on page 28.

Using the SD Card

You can use a Secure Digital (SD) card to increase file storage and install software. The CK30 currently supports SanDisk SD cards only. The SD card slot is located on the top of the CK30 just above the laser scanner window.

To insert an SD card

- 1 Press **⏻** to turn off the CK30.
- 2 Remove the two screws on the SD card slot door and remove the door.
- 3 Gently insert the SD card into the CK30 with the printed side facing the keypad and screen side of the CK30.

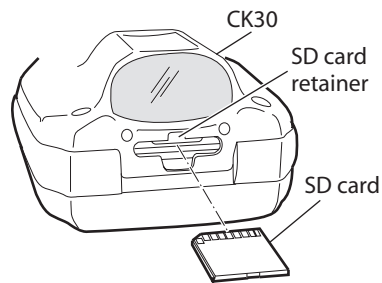

- 4 Push the card into the slot until it latches in place and the steel card retainer covers the end of the SD card.
- 5 Replace the door, making sure to insert the door catch into the slot above the steel card retainer.

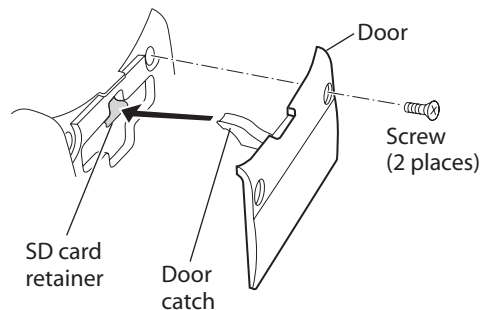

- 6 Replace the two screws.

Chapter 1 — Using the CK30 Handheld Computer

7 Press \mathbb{V} to turn on the CK30.

To remove the SD card

1 Press \mathbb{V} to turn off the CK30.

2 Remove the two screws on the SD card slot door and remove the door.

3 Push in on the SD card until you hear it unlatch. The card should eject far enough that you can easily remove it from the CK30.

If the card does not eject easily, you can use the door catch to remove it by turning the door upside down and using the catch to pull out the SD card.

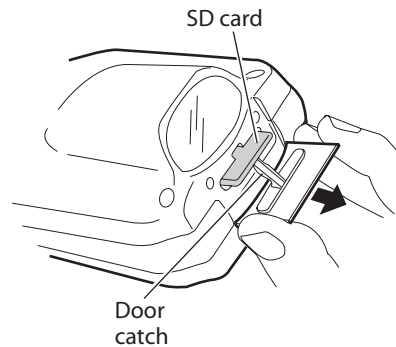

4 Remove the SD card from the CK30.



2 Configuring the CK30

Use this chapter to understand how to configure the CK30 to communicate in your network. In this chapter, you will find these sections:

- How to Configure the CK30 Parameters
- Configuring the CK30 for Your Network
- Configuring Security
- Saving Your Configuration Changes to Flash Memory

How to Configure the CK30 Parameters

You can configure many parameters on the CK30, such as the bar code symbologies it decodes or the network settings. These characteristics are controlled by configuration parameters. The values you set for these configuration parameters determine how the computer operates.

There are several ways to configure the CK30:

Use Setup Assistant on the CK30

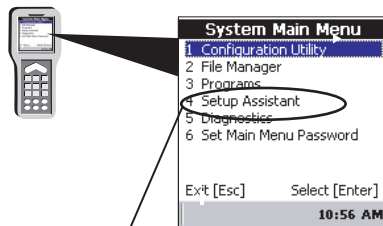

Use Setup Assistant to quickly enter network parameters.

Use Configuration Utility on the CK30

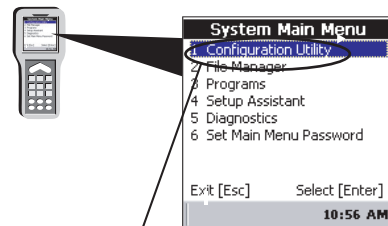

Use the Configuration Utility to set all parameters.

Scan Bar Codes



Scan bar codes to configure basic CK30 and data collection parameters.

Use Configuration Commands

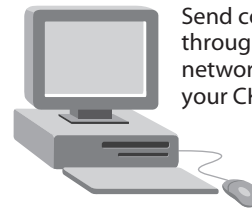

Send commands through the network to your CK30s.



Ethernet or Wireless Network

Configuring the CK30 With the Setup Assistant

When first setting up the CK30, use the Setup Assistant to set or enable basic network parameters and connect your CK30 to the network. The Setup Assistant guides you through setting the following basic network parameters:

- Date and time
- SSID (Network name)
- 802.1x security
- DHCP server or IP address, subnet mask, and default router
- Primary and secondary DNS addresses
- Primary and secondary WINS addresses
- Device name

To set other parameters, use the Configuration Utility or another configuration method. The Setup Assistant runs on the CK30 the first time you turn on the computer.

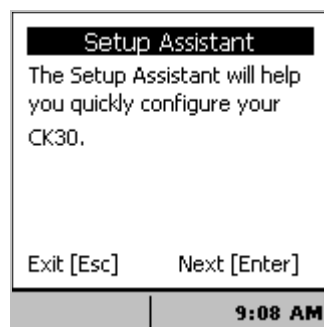

The Setup Assistant Start Screen

However, if you exit Setup Assistant before you are finished configuring the CK30, you can restart it from the System Main Menu. See the next section for information on how to access the System Main Menu.

After you complete the Setup Assistant, the CK30 should be communicating with your network.

Configuring the CK30 With the Configuration Utility

Use the menu-driven Configuration Utility to configure the CK30 and view system information. You can access the Configuration Utility while running any application.

To open the Configuration Utility

- 1 Press **□** and then **■**. The System Main Menu appears.

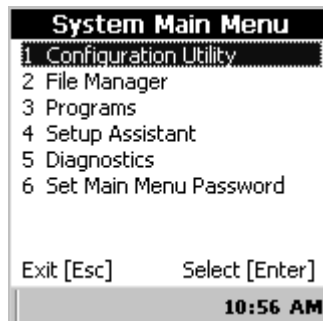

- 2 Select the **Configuration Utility**. The Configuration Utility main menu appears.

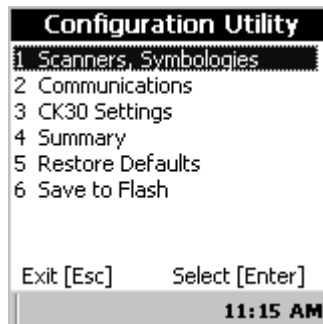

Refer to the next sections to understand your menu options, learn how to navigate and enter information, and learn how the menus are organized in the Configuration Utility.

Chapter 2 — Configuring the CK30

When using the Configuration Utility, you may not see a parameter until you enable or disable a value for another key field. For example, you will not see IP Settings unless you disable DHCP. You may also not see a parameter if your computer does not support a particular feature.

Use the following diagram to find the commands you need to use to configure your CK30s. These screens are do not represent the exact information you will see on your CK30. They have been modified to show you how the information is structured.

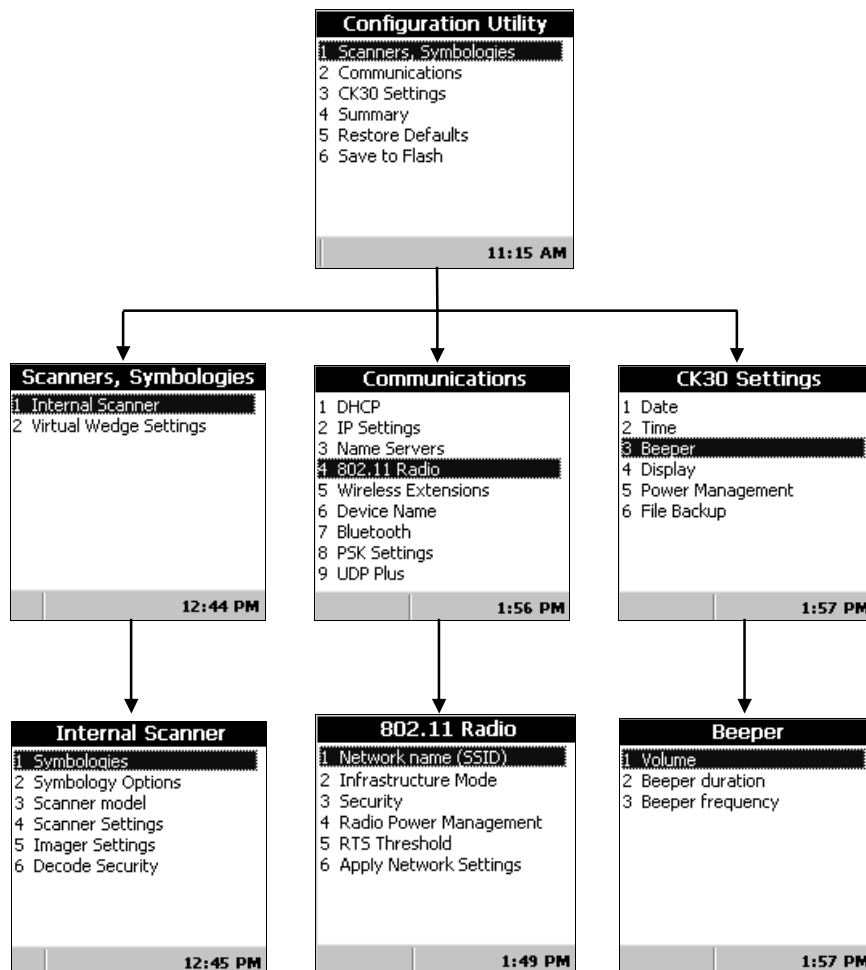

Configuration Utility Menus at a Glance

Chapter 2 — Configuring the CK30

Configuration Utility Menu Options

Menu Option	Description
Scanners, Symbologies	Configure scanner settings and bar code symbologies.
Communications	Set up network settings including the 802.11b/g radio and the Bluetooth radio.
CK30 Settings	Configure settings specific to the CK30 such as the date, time, beeper volume, and backlight timeout.
Summary	View a summary of all settings for the Scanners, Symbologies menu, the Communications menu, and the CK30 Settings menu.
Restore Defaults	Restore factory default settings on your CK30.
Save to Flash	Preserves configuration settings when you cold boot the CK30.

Use this table to understand how to navigate and enter information in the Configuration Utility.

Navigating in the Configuration Utility

To Do This:	Press:
Select an option	<ul style="list-style-type: none">• The number associated with the option• ▲ or ▼ to select an option and then press Enter• Tab to select an option and then press Enter
Save a setting	Enter key
Exit or return to a previous screen	Esc until you exit the application or return to a previous screen
Delete a character	□ key, Backspace (←) key
Delete all characters in a field when highlighted	Backspace (←) key
Return to the Configuration Utility main menu (Home)	On the 42-key and 52-key keypads: <ul style="list-style-type: none">• Press □ and then 8 On the 50-key keypad: <ul style="list-style-type: none">• Press □ and then H

Restoring Default Settings

You can restore the CK30 to factory default settings from the Configuration Utility. For a complete list of the default settings, see “Default Configuration” on page 114.



Note: Using the Restore Defaults option resets all network parameters. As a result, you may lose network communications. This option should only be used by network administrators or by Intermec support personnel.

To restore factory default settings

- 1 From the **Configuration Utility** menu, select **Restore Defaults**. The following Restore Defaults dialog box appears:

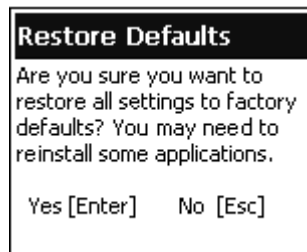

- 2 Press **Enter** to restore factory defaults.

Your CK30 performs a cold boot and returns all of your settings to the factory default settings. When the CK30 is done booting, the Start Screen appears.



Note: You may need to reinstall some applications after restoring the default settings because any settings that were modified for your application will be reset.

Exiting the Configuration Utility

You can exit the Configuration Utility at any time by pressing the **Esc** key.

To exit the Configuration Utility

- 1 Press **Esc** until you return to the System Main Menu. If you have made any changes to your configuration, the Save Settings dialog appears:

Chapter 2 — Configuring the CK30

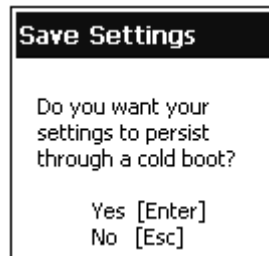

- 2 Press **Enter** to exit and save your changes through a cold boot. Press **Esc** to exit without saving your changes through a cold boot.

Configuring the CK30 by Scanning Bar Codes

You can change some of the configuration parameters of the CK30 by scanning Code 39 or Code 93 bar code labels containing configuration commands. This method is a fast and easy way to change just a few configuration parameters on a single CK30.

You can only change some of the configuration parameters by scanning bar codes. To configure all of the configuration parameters, use the Configuration Utility or send commands through the network to your CK30.

You can print and scan the bar code labels from the *CK30 Command Reference Manual* or you can create your own bar code labels. For help, see the *CK30 Command Reference Manual*.

You can also use Intermec's EasySet software to print configuration labels you can scan to change your configuration settings. For more information, see the EasySet online help. EasySet is available from the Intermec Data Capture web site.

For example, you can use the Beeper Volume configuration command to adjust the beep volume of the CK30. Scan this bar code label to set the volume to the lowest (quietest) level:

Beeper Volume Low



\$+BV1

Chapter 2 — Configuring the CK30

When you scan bar code configuration commands, the CK30 emits a series of beeps unless the volume is turned off. There are two beep sequences:

- One high beep means you scanned a valid configuration command.
- Three low beeps means you scanned an invalid configuration command.

Configuring the CK30 Through the Network

You can change the configuration parameters of the CK30 by sending commands through a host computer or through the network. If you are using a network, you can configure one or more CK30s at a time. You can remotely configure the wireless or Ethernet CK30 by sending a command from an application on the host computer. You cannot set all parameters through the network. You can only set those commands that have a syntax in the *CK30 Command Reference Manual*.



Note: You can continue running an application on the CK30 while configuring it from the host.

Configuring the CK30 in a UDP Plus Network

You can use the host computer to configure a CK30 in your wireless or Ethernet network. To send and receive configuration data or files, you need to write a host application that can communicate with the Intermec Gateway or DCS 30X.

For help, see the appropriate Intermec Gateway or DCS 30X user's manual. You use the Terminal Message Format (TMF) protocol to send and receive transactions between the host application and the CK30.

To set up the DCS 30X or Intermec Gateway

- Configure a peer-to-peer destination name for the host application. Create a transaction ID, \$NGCFGRSP, that will be routed to this destination name. The DCS 30X or Intermec Gateway uses the transaction ID to route responses from the CK30 back to the host application. \$NGCFGRSP is a special transaction ID that the server uses to forward configuration response data from a CK30.

Chapter 2 — Configuring the CK30

All configuration responses are routed with the \$NGCFGRSP transaction ID. The DCS 30X or Intermec Gateway cannot keep track of multiple applications sending reader or configuration commands. If you have two host applications sending reader or configuration commands, they must both be configured to receive the \$NGCFGRSP transactions, and therefore both will receive all responses from all CK30s.

To set up the host computer

- Verify that the host computer can communicate with the DCS 30X or Intermec Gateway.

To set up the application

- Prepare and write a host application that can communicate with the DCS 30X or Intermec Gateway and send transactions to and receive transactions from the CK30 in this format:

<i>transaction header</i>	<i>TMF field</i>	<i>commands</i>
---------------------------	------------------	-----------------

where:

transaction header is a 96-byte field containing the message number, date and time, source application ID, destinations application ID, transaction ID, and other information. You must set the system message (SYS\$MSG) flag to E in the transaction header. For help, see the DCS 30X or Intermec Gateway user's manual.

Chapter 2 — Configuring the CK30

<i>TMF field</i>	is a 2-byte field containing one of these values:
CG	Configuration Get request sent from the host application.
Cg	Configuration Get response sent from the CK30 to the host.
CS	Configuration Set request sent from the host application.
Cs	Configuration Set response sent from the CK30 to the host.

commands are the reader and configuration commands that you want to set on the CK30 or the current value you want to retrieve from the CK30. To save configuration changes in flash memory, send the reader command `. +1` as the last command.

For a list of all supported commands, see the *CK30 Command Reference Manual*.

To see an example of the host application transaction, see the example on page 38.

Configuring the CK30 in a TCP/IP Direct Connect Network

You can use the host computer to configure a wireless or Ethernet CK30 in your TCP/IP network.

To send and receive configuration data, you need to write a host application that can communicate with the CK30 directly through an access point or through the Ethernet network. You use the Terminal Message Format (TMF) protocol to send and receive transactions between the host application and the CK30.

To set up the host computer

- Verify that you can communicate with the CK30.

To set up the application

- Prepare and write a host application that can communicate with the CK30. Message transactions to and receive transactions from the CK30 on the network port must conform to the following format:

Chapter 2 — Configuring the CK30

<i>TMF field</i>	<i>commands</i>
------------------	-----------------

where:

TMF field is a 2-byte field containing one of these values:

- CG Configuration Get request sent from the host application.
- Cg Configuration Get response sent from the CK30 to the host.
- CS Configuration Set request sent from the host application.
- Cs Configuration Set response sent from the CK30 to the host.

commands are the reader and configuration commands that you want to set on the CK30 or the current value you want to retrieve from the CK30. To save configuration changes in flash memory, send the reader command `.+1` as the last command.

For a list of all commands, see the *CK30 Command Reference Manual*.

Example

In the host application, you want to get the current values of two configuration commands from the CK30. Send this transaction from the host application:

```
CG$+NABV
```



Note: The transaction header is not shown in this example. You do not need a transaction header for a host application in a TCP/IP network, but you do for a UDP Plus network.

where:

- CG is a TMF Configuration Get request.
- \$+ is the Change Configuration reader command.
- BV is the Beeper Volume configuration command.

The CK30 returns this transaction to the host application.

Cg\$+BV4

where:

Cg is a TMF Configuration Get response.

\$+ is the Change Configuration reader command.

BV4 means the Beep Volume configuration command is currently set to a value of 4, which is a very high beeper volume.

Configuring the CK30 for Your Network

The CK30 is a versatile handheld computer that you can easily add to your wired or wireless data collection network. You can connect your CK30 to your network using:

- Serial communications
- 802.11b/g radio communications
- Ethernet communications
- Bluetooth™ radio communications

Configuring Serial Communications

The CK30 has a serial port to transfer data to and receive data from another device via RS-232 communications. You can also insert the CK30 into a communications dock to transmit data to and receive data from a host computer or PC using RS-232 communications.

The serial cable and the communications dock are sold separately. For more information on accessories and how to order them, see page 109.

Chapter 2 — Configuring the CK30

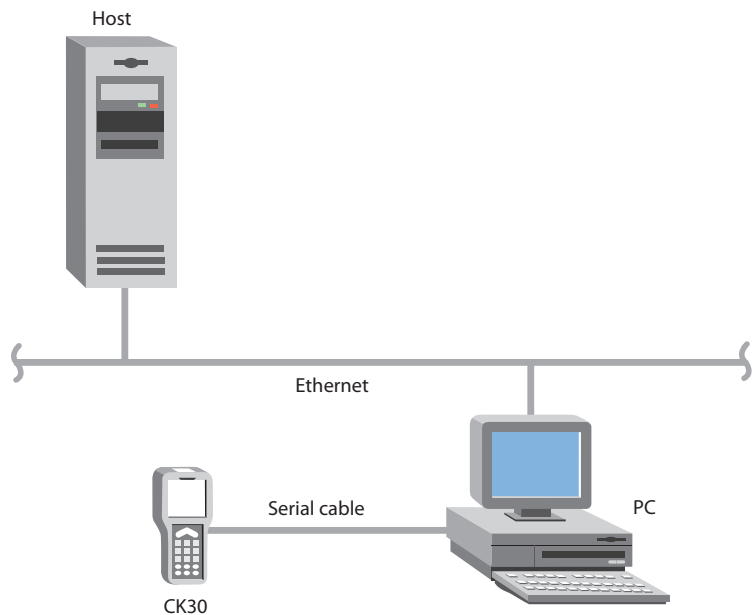

CK30 in a Serial Network

To use serial communications with your CK30

- 1** Turn off the CK30.
- 2** Connect the CK30 to the serial port of another device. You can do this in one of the following ways:
 - Connect the CK30 serial port to the serial port of the other device using the AA1 (26-pin to DB9-pin) serial cable adapter and a female-to-female null modem RS-232 cable.
 - Connect the AD1 or AD2 communications dock to the serial port of the other device using a DB9-pin to DB9-pin serial adapter cable. Insert the CK30 into the dock.
- 3** Turn on the CK30.

Configuring 802.11b/g Radio Communications



Make sure all components with antennas are at least 30 cm (1 ft) apart when power is applied. Failure to comply could result in equipment damage.

Attention: Assurez-vous que la distance entre tous les éléments avec antennes soit d'au moins 30 centimètres (un pied) avant de faire la connexion avec l'alimentation électrique, faute de quoi vous risquez d'endommager votre installation.

The wireless CK30 has an internal 802.11b/g radio to transfer data using wireless communications. This section of the manual assumes that you have already set up your wireless communications network including your access points. If you are using a UDP Plus network, you also need to have your Intermec Gateway or DCS 30X communicating with a host computer.

Your CK30 supports these network protocols:

- TCP/IP
- UDP Plus

The next sections explain the parameters you need to configure for the CK30 to work in your wireless network.

Configuring the Network Parameters for a TCP/IP Network

In a TCP/IP network, the CK30 communicates with a host computer directly using TCP/IP. The access point acts as a bridge to allow communications between the wired network and the wireless network.

Chapter 2 — Configuring the CK30

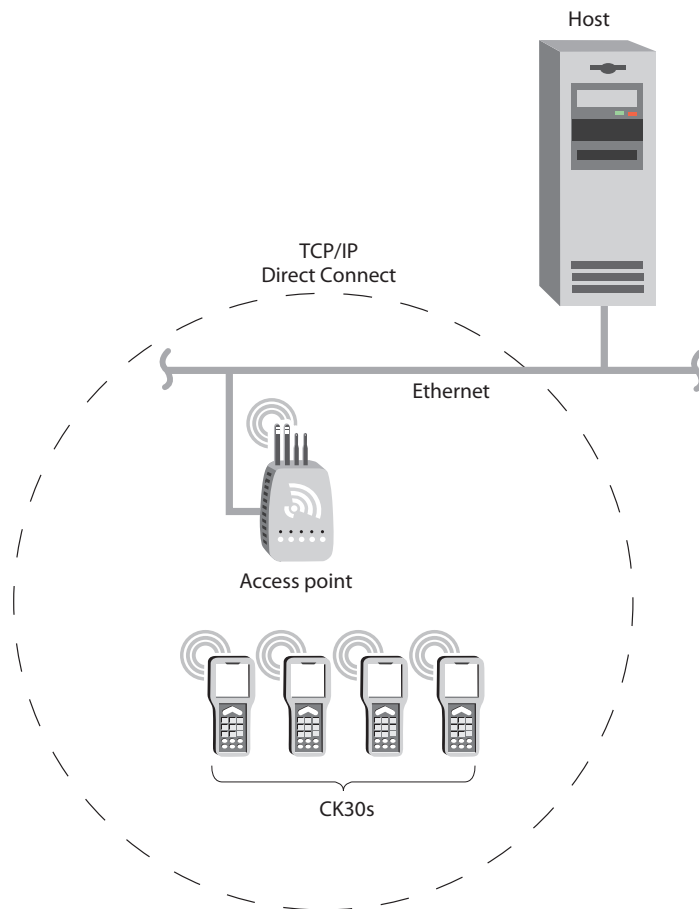

CK30 in a TCP/IP Direct Connect Network

To use wireless communications in a TCP/IP network

- 1 Configure these network parameters on each CK30 in the network:
 - Network Name (SSID)
 - Host IP Address
 - IP Settings (if not using DHCP)
 - Network Port
- 2 Configure security. For help, see “Configuring Security” on page 48.

Chapter 2 — Configuring the CK30

The easiest way to configure the network parameters on the CK30 is to use the Configuration Utility. For help, see “Configuring the CK30 With the Configuration Utility” on page 30.

Configuring the Network Parameters for a UDP Plus Network

In a UDP Plus network, the CK30 communicates with a host computer through the Intermecc Gateway or the DCS 30X.

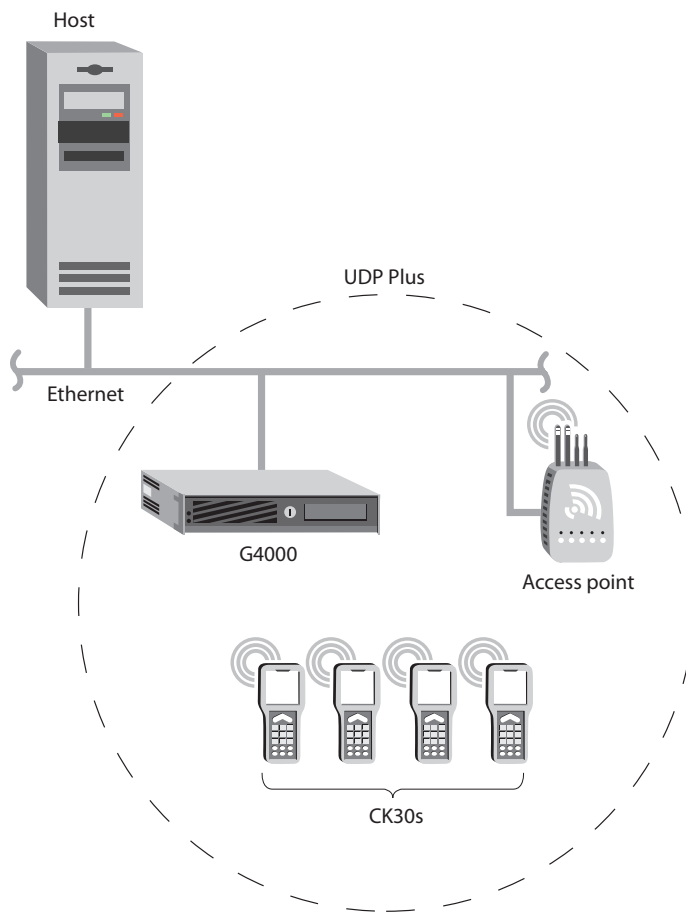

CK30 in a UDP Plus Network

Chapter 2 — Configuring the CK30

The Intermec Gateway or DCS 30X translate UDP Plus packets on the wireless network into TCP/IP packets on the wired network and vice versa. The access point acts as a bridge to allow communications between the wired network and the wireless network.

To use wireless communications in a UDP Plus network

- 1** Configure these network parameters on each CK30 in the network:
 - Network Name (SSID)
 - Controller IP Address
 - IP Settings (if not using DHCP)
 - Network Port
- 2** Configure the security. For help, see “Configuring Security” on page 48.

You can configure the network parameters on the CK30 with the Configuration Utility. For help, see “Configuring the CK30 With the Configuration Utility” on page 30.

Configuring Ethernet Communications

You can use the CK30 directly in an Ethernet network if you have ordered the Ethernet option on your CK30A and you insert it into an AD1 or AD2 Communications Dock. The communications dock has an Ethernet connector that makes it possible for the CK30 to communicate with your Ethernet network.

Chapter 2 — Configuring the CK30

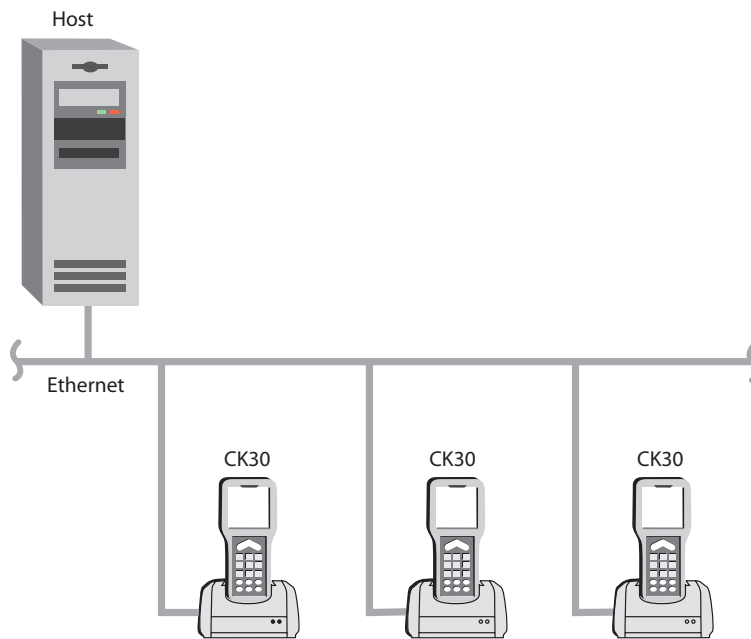

CK30s in an Ethernet Network

To use the CK30 in an Ethernet network

- 1 Configure these network parameters on each CK30 in the network:
 - Network Name (SSID)
 - Host IP Address
 - IP Settings (if not using DHCP)
 - Network Port
- 2 If required for your network, set these parameters on each CK30 in the network:
 - Primary and Secondary DNS Servers
 - Primary and Secondary WINS Servers

Configuring Bluetooth Radio Communications

You can send information to printers wirelessly using the Bluetooth qualified module by Socket Communications. The Bluetooth technology uses short-range radio links and allows for communications over a 5-meter (16.4 ft) range.

To configure the CK30 for wireless printing

- 1 Go to **Configuration Utility > Communications > Bluetooth**. The Bluetooth menu appears:



- 2 Select **Set Printer (Device Discovery)** to start the Bluetooth device discovery. A list of discovered devices appears in the Devices dialog box.

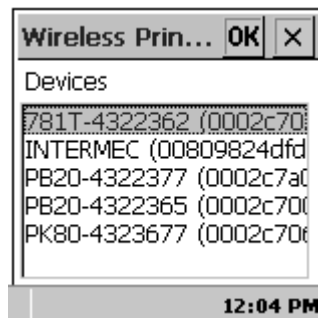

- 3 Select the device you want to use from the list and press **Enter**.

You are now ready to send information to the selected device.

Chapter 2 — Configuring the CK30

If devices are discovered, but your device is not displayed in the box, make sure your device and radio are turned on and try device discovery again.

Use this table to understand the commands you see in the Bluetooth menu.

Bluetooth Commands

Command	Description
Remote Device Name	Displays the name of the remote Bluetooth printer.
Remote Device Address	Displays the network address of the Bluetooth compatible printer.
Set Printer (Device Discovery)	Discovers Bluetooth compatible devices.
Set Printer (Device Manager)	Allows you to pick from printer information saved during earlier device discoveries.
Bluetooth Device Name	Displays the name assigned to your CK30.
Device Address	Displays the network address of your CK30.
Discoverable	Allows other Bluetooth devices to be able to discover your CK30 during a device discovery.
Connectable	Allows other Bluetooth devices to connect to your CK30.
Class of Device	Determines how the device appears to other devices during discovery.
Apply Bluetooth Changes	Saves changes made to the Discoverable and Connectable commands. If you do not select Apply Bluetooth changes, the changes are made the next time you turn the CK30 off and on or perform a warm boot.

For more information on using Bluetooth communications, see the *Wireless Printing Development Guide* available on the *Intermec Developer's Library CD* (P/N 235-114-001) or the Intermec web site.

Configuring Security

The CK30 provides three types of Wireless Local Area Network (WLAN) security:

- WiFi Protected Access (WPA)
- 802.1x
- WEP

Use the next sections to understand how to configure each type of security on your wireless CK30. If you choose not to use security, see “Disabling Security” on page 54 for help.

If you are using 802.1x security, this section also assumes that your authentication server and access points are properly configured.

Loading Certificates

If you choose to use transport layer security (TLS) with WPA or 802.1x security, you need to have a unique client certificate on the CK30 and a trusted root certificate authority (CA) certificate. If you choose to use PEAP, you need to load a root CA certificate. You can use a third-party CA to issue unique client certificates and a root certificate. If your CA is on your WLAN, you can use the CK30 Enroll application to obtain the certificates.

To load certificates on the CK30

- 1 Configure the network and radio settings for the CK30.
- 2 From the System Main Menu, choose **Programs > Command Prompt**.
- 3 Type `enroll -sserver_name`
where *server_name* is the name or IP address of the CA server

Chapter 2 — Configuring the CK30

The Network Password dialog box appears.



- 4 In the Network Password dialog box, enter the **User Name**, **Password**, and **Domain** to log in to the CA server.
- 5 Press **Enter**. A dialog box appears asking if you want to load the root certificate.
- 6 Press **Y** for yes. The root certificate and client certificate are automatically loaded.
- 7 Configure your CK30 for WPA or 802.1x security.

Configuring WPA Security

Wi-Fi Protected Access (WPA) is a strongly enhanced, interoperable Wi-Fi security that addresses many of the vulnerabilities of Wired Equivalent Privacy (WEP). Instead of WEP, WPA uses Temporal Key Integrity Protocol (TKIP) for its data encryption method.

Currently, WPA satisfies some of the requirements in the IEEE 802.11i draft standard. When the standard is finalized, WPA will maintain forward compatibility. WPA runs in Enterprise (802.1x) mode or PSK (Pre-Shared Key) mode.

In Enterprise mode, WPA provides user authentication using 802.1x and the Extensible Authentication Protocol (EAP). That is, an authentication server (such as a RADIUS server) must authenticate each device before the device can communicate with the WLAN.

In PSK mode, WPA provides user authentication using a shared key between the access point and the CK30. WPA-PSK is a good solution for small offices or home offices that do not want to use an authentication server.

Chapter 2 — Configuring the CK30

To use WPA security, you need:

- An authentication server



Note: You can also use a MobileLAN access point with software release 1.80 or later as an authentication server. For help, see the *MobileLAN access System Manual* (P/N 067150).

- An access point with an 802.11b/g radio that supports WPA
- CK30 with the 802.11b/g radio and the 802.1x/WPA security option

To enable WPA security on your CK30

- 1 Make sure you have configured the communications and radio parameters on your CK30.
- 2 Press and then to open the System Main Menu.
- 3 Choose **Configuration Utility > Communications > 802.11 Radio > Security**.
- 4 For Network Authentication, choose **WPA**.
- 5 For Data Encryption, choose **TKIP**.
- 6 For 802.1x Authentication, choose either **TLS** or **PEAP**.

If you choose TLS:

- a Select **Properties** and choose the **Select** button.
- b Select your certificate from the list and press **Enter**.

If you choose PEAP:

- a Select **Properties** and clear the **Validate Server** checkbox by tabbing to it and then pressing **V**.

Chapter 2 — Configuring the CK30

- b** Press **Enter**. Once the radio starts to authenticate, the Network Password dialog box appears:

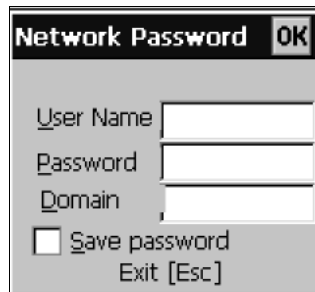

- c** Enter a **User Name** and **Password** and select the **Save Password** checkbox.
- d** (Optional) In the Domain field, enter the domain that you need to access to obtain the certificates.
- e** Press **Enter**. You return to the **Communications** menu.
- 7** Exit the Configuration Utility.

To enable WPA-PSK security on your CK30

- 1 Press **□■** and then **■□** to open the System Main Menu.
- 2 Choose **Configuration Utility > Communications > 802.11 Radio > Security**.
- 3 For Network Authentication, choose **WPA-PSK**.
- 4 For Network Key Value, enter a pass phrase or pre-shared key.

The pass phrase must be a value between 8 to 63 ASCII characters. The pre-shared key must be a value of 32 Hex pairs. The pre-shared key must be preceded by 0x. The value must match the key value on the access point.

- 5 Exit the Configuration Utility.

Configuring 802.1x Security

802.1x security provides centralized user authentication using an authentication server, authenticators (access points), and supplicants. These components communicate using an EAP authentication type, such as TLS (Transport Layer Security) or PEAP (Protected Extensible Authentication Protocol). 802.1x security provides data encryption using dynamic WEP key management.

To use 802.1x security, you need:

- An authentication server



Note: You can also use a MobileLAN access point with software release 1.80 or later as an authentication server. For help, see the *MobileLAN access System Manual* (P/N 067150).

- An access point with an 802.11b/g radio
- A CK30 with an 802.11b/g radio and the 802.1x/WPA security option

To enable 802.1x security on your CK30

- 1 Press **□■** and then **■□** to open the System Main Menu.
- 2 Choose **Configuration Utility > Communications > 802.11 Radio > Security**.
- 3 For Network Authentication, choose **Open**.
- 4 For Data Encryption, choose **WEP**.
- 5 For 802.1X Authentication, choose **TLS** or **PEAP**.

If you choose TLS:

- a Select **Properties** and choose the **Select** button.
- b Select your client certificate from the list and press **Enter**.

If you choose PEAP:

- a Select **Properties** and clear the **Validate Server** checkbox by tabbing to it and then pressing **V**.
- b Press **Enter**. Once the radio starts to authenticate, the Network Password dialog box appears:

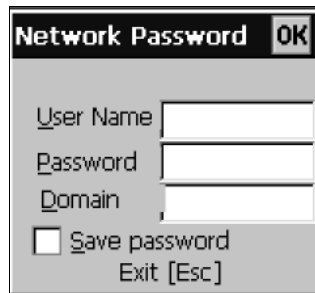

- c Enter a User Name and Password and select the **Save Password** checkbox.
 - d (Optional) In the Domain field, enter the domain that you need to access to obtain the certificates.
 - e Press **Enter**. You return to the **Communications** menu.
- 6 For Network Key Setting, choose **Automatic**.
 - 7 Exit the Configuration Utility.

Configuring Static WEP Security

The CK30 uses the Wired Equivalent Privacy (WEP) protocol to provide your wireless networks the same level of protection as a comparable wired network. WEP adds security to wireless local area networks (WLANs) based on the 802.11b standard.

To use WEP security, you need:

- A CK30 handheld computer with an 802.11b/g radio.

To enable WEP security on the CK30

- 1 Make sure you have configured the communications and radio parameters on your CK30.
- 2 Press **□■** and then **■□** to open the System Main Menu.

Chapter 2 — Configuring the CK30

- 3 Choose **Configuration Utility > Communications > 802.11 Radio > Security**.
- 4 For Network Authentication, choose **Open**.
Intermec recommends using Open.
- 5 For Data Encryption, choose **WEP**.
- 6 For Network Key Setting, choose **Enter Key and Index**.
- 7 For Network Key Value, enter an ASCII key or a hex key that is either 5 bytes or 13 bytes long depending on the capability of the radio.

Set a 5-byte value for 64-bit WEP or a 13-byte value for 128-bit WEP. Hex keys must be preceded by 0x and contain 5 or 13 hex pairs.
- 8 For Network Key Index, select the key you want to use for data transmission.
- 9 Exit the Configuration Utility.

Disabling Security

If you choose not to use security with your WLAN, you need to disable it on the CK30. By default, static WEP is enabled. Intermec recommends that you always set security in your network.

To disable security

- 1 For Network Authentication, choose **Open** or **Shared**.
- 2 For Data Encryption, choose **Disabled**.

Saving Your Configuration Changes to Flash Memory

If you want to save your configuration changes through a cold boot, you need to save your changes to the flash memory. You can save your changes to flash memory by:

- Using the Configuration Utility main menu.
- Scanning a bar code.
- Sending a reader command through the network.

To save configuration changes using the Configuration Utility

- 1 From the System Main Menu, select **Configuration Utility**.
- 2 From the Configuration Utility, select **Save to Flash**. The Save Settings dialog box appears:

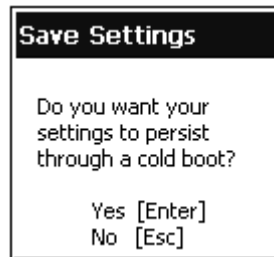

- 3 Press **Enter**.

An hourglass appears while the CK30 is saving your settings to flash. When the CK30 is done saving your changes, it returns you to the Configuration Utility menu.

- 4 Press **Esc** to return to the System Main Menu.

To save configuration changes by scanning a bar code

- Scan this bar code:
Save Configuration in Flash Memory



.+1

To save configuration changes by sending a command from the host

- Send .+1 as the last command from the host application.

Chapter 2 — Configuring the CK30



3 Developing and Installing Applications

In this chapter you will find guidelines for developing applications using the Software Developer's Kit (SDK) and converting existing Trakker Antares applications using the Programmer Software Kit (PSK). You will also find information on installing applications and automatically launching them.

In this chapter you will find these sections:

- Developing Applications for the CK30
- Installing Applications on the CK30
- Launching Your Application Automatically
- Customizing How Applications Load on the CK30

Developing Applications for the CK30

The CK30 Handheld Computers run applications programmed in Microsoft Embedded Visual C++. The CK30C can also run applications developed for the .NET Compact framework using Microsoft C# and Visual Basic.

Use this section to understand what you need to:

- Develop a new application for the CK30.
- Develop a web-based application for the CK30.
- Convert a Trakker Antares application to a CK30 application.

Developing a New Application for the CK30

Use the Intermec SDK to develop new applications to run on the CK30. The Intermec SDK is a library of C++ language functions you can use to create applications for the CK30.

See the SDK online user's manual for help developing your application. The *Intermec SDK User's Manual* contains hardware and software requirements, all of the functions that are supported by the CK30, and how to use these functions.

The SDK is part of the Intermec Developer's Library (IDL), which is available on CD (P/N 235-114-001) or as a download from the Intermec web site at www.intermec.com.

You need these hardware and software components to use the Intermec SDK:

- Pentium PC, 400 MHz or higher
- Windows 2000 (Service Pack 2 or later) or Windows XP (Home, Professional, or Server)
- For native C++ development, Microsoft eMbedded Visual C++ version 4.0
- For .NET Development and Compact Framework (C# and VB.NET), Microsoft Visual Studio .NET 2003
- 128MB RAM (196MB recommended)
- 360MB Hard drive space for minimum installation (720MB for complete)

Chapter 3 — Developing and Installing Applications

- CD-ROM drive compatible with multimedia PC specification
- VGA or higher-resolution monitor (Super VGA recommended)
- Microsoft Mouse or compatible pointing device

For more information on .NET development and the Compact Framework, see the .NET SDK documentation available as part of the Intermec Developer's Library (IDL) available on CD (P/N 235-114-001) or as a download from the Intermec web site and www.intermec.com.

Developing a Web-Based Application

You can develop web-based data collection applications for use on the CK30. For help, see any HTML source book. The CK30 ships with iBrowse (CK30A, CK30B) or IE Browser (CK30C).

To open iBrowse or IE Browser

- 1 Press **□■** and then **■□**. The System Main Menu appears.
- 2 Select **Programs**. The Programs menu appears.
- 3 Select either **iBrowse** or **IE Browser**.

For help using IE Browser, press F1. For help using iBrowse, see the *iBrowse User's Guide* (P/N 961-055-015).

Converting a Trakker Antares Application to a CK30 Application

If you have an existing Trakker Antares application that you would like to run on the CK30, you can use the PSK to convert it. The CK30 PSK is a set of libraries and tools that you use to convert your existing Trakker Antares C applications into C++ applications for use on the CK30 Handheld Computer.

The CK30 does not support all Trakker Antares PSK functions. You may need to rewrite parts of your application when converting it for use on the CK30. See the online *CK30 PSK User's Manual* for a list of functions that are not supported.

Chapter 3 — Developing and Installing Applications

You need these hardware and software components to use the PSK:

- PC with at least 1MB of free disk space running Microsoft Windows 2000/XP
- Microsoft eMbedded Visual C++ version 4.0 with Service Pack 2
- Intermec SDK and development tools
- Intermec PSK, which contains these files and utilities:
 - PSK functions library
 - Header files
 - Example files

The PSK is part of the Intermec Developer's Library (IDL), which is available on CD (P/N 235-114-001) or as a download from the Intermec web site at www.intermec.com.

Installing Applications on the CK30

There are several ways you can install applications on the CK30:

- You can package your application as a cabinet (CAB) file.
- If you have a simple application, you may only need to deliver the EXE file.
- You can copy a directory structure that contains the application, supporting files, DLLs, images, sound files, and data files.

Intermec recommends using CAB files to install your applications. The CK30 uses standard Windows CE CAB files and will install third-party CAB files. Before the CK30 executes a CAB file, it marks the file as read-only so that it will not be deleted after installation. After the CAB file is executed, the CK30 automatically saves any changes you have made to the registry or file system so that they will persist through a cold boot. This process means that you will not have to reinstall your applications when you perform a cold boot.

Chapter 3 — Developing and Installing Applications

Intermec advises you to store your applications in a folder specific to your application underneath the \PROGRAM FILES folder. Intermec recommends that you store your application data in one of these locations on the CK30:

- The SDMMC Disk folder
- The CK_FFS folder

If you have an SD card inserted in your CK30, it appears as the SDMMC Disk folder. This folder is the recommended location for placing your application install files.

The CK_FFS folder is an area of storage that is part of the CK30 flash memory. This storage area is not deleted during a cold boot.

There are several ways you can install files and applications on the CK30:

- ActiveSync
- SD Card
- FTP Server
- Wavelink Avalanche

The following sections explain how to use each one of these processes to install your application on the CK30.

Installing Applications Using ActiveSync

You can use ActiveSync to establish a connection between your PC and the CK30. ActiveSync allows you to transfer files, synchronize files, perform remote debugging, and other device management activities. ActiveSync is a free application available from the Microsoft web site.

To establish a partnership between your PC and the CK30, you will need:

- A USB cable or a female-to-female null modem serial cable.
- An AD1 communications dock.
- ActiveSync version 3.7.1 or later.

Installing ActiveSync and Establishing a Partnership

You can use either a USB cable or a serial cable to establish your initial partnership between the CK30 and your PC.

To install ActiveSync and establish a partnership

- 1 Download ActiveSync from the Microsoft web site and follow the onscreen instructions for installing it on your PC. When the installation process is complete, the Get Connected dialog box appears.



- 2 Connect the AD1 to your PC with the USB or serial cable.
- 3 If you are using a serial cable, from the CK30 System Main Menu, select **Programs > ActiveSync Serial**.
The default setting for ActiveSync on the CK30 is USB.
- 4 Click **Next** in the Get Connected dialog box. ActiveSync detects a device on the USB or serial port and prompts you to set up a new partnership.
- 5 In the Set Up a Partnership dialog box, click **Next**.
- 6 In the Select Number of Partnerships dialog box, select **Yes, I want to synchronize with only this computer** and then click **Next**.

Chapter 3 — Developing and Installing Applications

- 7 In the Select Synchronization Settings dialog box, check the items you want to synchronize and click **Next**.
- 8 In the Setup Complete dialog box, click **Finish**.

When the partnership has been established, the following screen appears on your PC showing the device name of your CK30 and the Connected status.

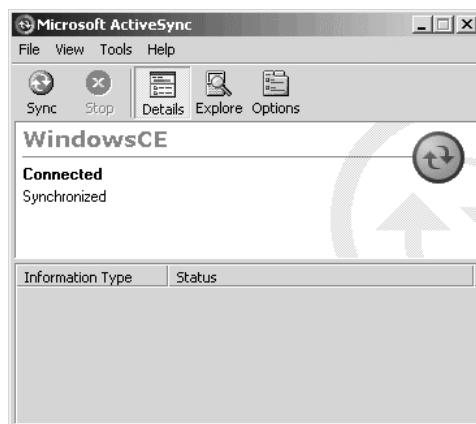

The Microsoft ActiveSync Screen

An ActiveSync icon (🔄) also appears on the CK30 status bar indicating that it has established an ActiveSync partnership with your PC.



Note: If ActiveSync does not establish a partnership on the first try, the Get Connected dialog box appears on your PC with the message “Your device was not detected.” Make sure all of your cables are securely connected and click **Next** on the Get Connected dialog box until your device is detected.

Now that the partnership has been established, ActiveSync initiates all future connections. To connect to your PC using ActiveSync in the future, simply place a CK30 in the AD1 communications dock, connect the CK30 serially to your PC, or turn on the CK30.

Using ActiveSync to Copy Files and Install Applications

You can use ActiveSync to copy files to the CK30 and to install applications. Use the following procedures to learn how to copy files and install applications on the CK30 using ActiveSync.

To install an application on the CK30 using ActiveSync

- 1 Connect the CK30 to your PC using ActiveSync. For help, see the previous section, “Installing ActiveSync and Establishing a Partnership.”
- 2 In the Microsoft ActiveSync screen, click **Explore**. Windows Explorer opens the Mobile Device window of your CK30.

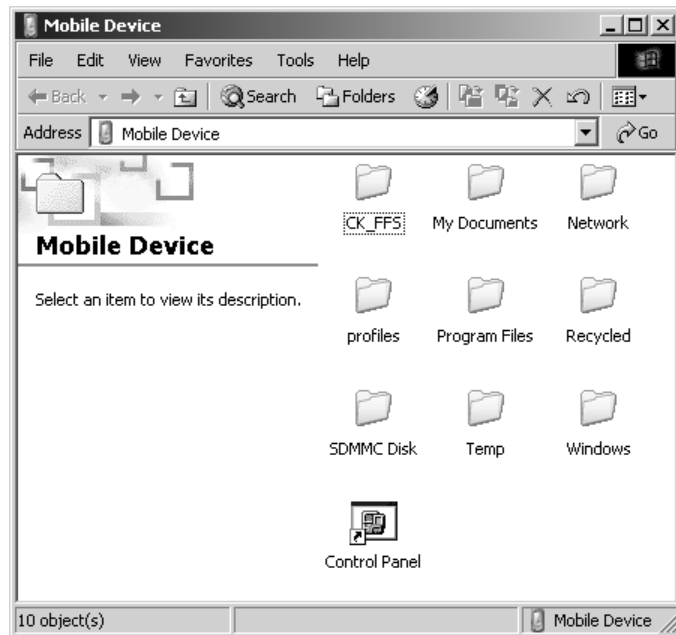

- 3 In Windows Explorer on your PC, browse to the file that you want to copy to your CK30.
- 4 Right-click the file and click **Copy**.
- 5 Place the cursor in the SDMMC Disk or CK_FFS folder of your CK30, right-click, and click **Paste**.

Chapter 3 — Developing and Installing Applications

The file has now been copied to the CK30 and you can see it using the CK30 File Manager.

- 6 Navigate to your application file and run it.

After your application is installed, you can run it from the Programs menu in the System Main Menu.

Installing Applications Using Your SD Card

If you have an SD card for your CK30, this is the best place for you to install applications.

To install applications using the SD card

- 1 If you are using an SD card reader, remove the SD card from the CK30 and place it in the reader. For help, see “Using the SD Card” on page 25.
- 2 Copy your application file to the SD card.
If you are using ActiveSync, an FTP server, or Wavelink Avalanche to copy the files to the SD card, place the application in the SDMMC Disk folder on the CK30.
- 3 If you are using an SD card reader, insert the SD card back into the CK30.
- 4 Navigate to the SDMMC Disk folder and run your application.

After your application is installed, you can run it from the Programs menu in the System Main Menu.

Installing Applications Using the FTP Server

The CK30 has a built-in FTP server that connects to a network through the 802.11b/g radio or Ethernet. You can use the server to transfer your application file to the CK30. Another benefit of using the FTP server is that you can create FTP scripts to automate the process of copying your files to the CK30.

This option is useful when you need to send files to a large number of CK30s.

Installing Applications Using Wavelink Avalanche

You can use the Wavelink Avalanche™ device management system to install applications on all of your wireless CK30s. The CK30 ships with the Avalanche Enabler already loaded on it.

Each time the Avalanche Enabler is activated (typically on a warm boot), the CK30 attempts to connect to the Avalanche Agent. When the CK30 connects to the agent, the Agent determines whether an update is available and immediately starts the software upgrade, file transfer, or configuration update.

To use Avalanche to remotely manage the CK30

- 1 Install software packages and updates for the CK30 using the Avalanche Administrative Console.
- 2 Schedule the CK30 updates or manually initiate an update using the Avalanche Administrative Console.

For more information on using Wavelink Avalanche, contact your local Intermec representative or visit the Wavelink web site at www.wavelink.com.

Launching Your Application Automatically

To launch your application automatically on the CK30 every time you perform a warm or cold boot, make sure your CAB file places a shortcut to your application in the \Windows\StartUp folder.

Customizing How Applications Load on the CK30

If you have several processes that you need to have run in a specific order as the CK30 turns on, you can use the AutoRun system to customize the way applications load. For compatibility with other Intermec computers, you can place a copy of AutoRun.exe in the same folder as your AutoRun.dat file but it is not required.

To create and install the AutoRun.dat file on your CK30

- 1 On the CK30, create a subfolder called 2577 on the SDMMC Disk or the CK_FFS folder.

Chapter 3 — Developing and Installing Applications

- 2 On your PC, open Notepad.
- 3 Write commands for AutoRun.dat using these supported script commands:

Script Command	Description
EXEC	Launches a specified program and waits (up to 10 minutes) for it to complete.
CALL	Processes a specified file of commands and returns. When you use the CALL command, the execution of the current file pauses while a new file that follows the same set of commands executes. Once the new file completes executing, AutoRun.exe continues processing the current file.
CHAIN	Processes a specified file of commands and does not return. This command allows you to call another file that follows the same set of commands and stop processing the current file.
RUN	Loads a specified program and executes it. Specifies the show window attribute so that the user interface is visible when the application launches.
LOAD	Loads a specified program and executes it. Specifies the hide window attribute so the user interface is hidden initially.

- 4 Save this Notepad file as AutoRun.dat.
- 5 Copy the AutoRun.dat file to the \2577 folder on your CK30.

During every boot, the system scans for AutoRun.dat in the \2577 folder on first the SDMMC Disk and then the CK_FFS folder. The CK30 executes the first AutoRun.dat file that it finds.

Here is a sample AutoRun.dat file that runs a dialer application, connects to a VPN, and establishes a TE 2000 session:

```
EXEC "\Program Files\My Dialer\Dialer.exe" 348-2600
EXEC "\Program Files\My VPN\Connect.exe" MyDomain
RUN "\Program Files\TE2000\TE2000.exe" MyServer
```

Chapter 3 — Developing and Installing Applications



4 Managing the CK30

Use this chapter to understand how to manage information on the CK30. In this chapter, you will find these sections:

- Accessing the System Main Menu
- Managing Files on the CK30
- Managing Applications on the CK30
- Setting or Changing the System Main Menu Password
- Backing Up Your Files
- Upgrading the Operating System

Accessing the System Main Menu

You need to access the System Main Menu to be able to use most of the tools for managing the CK30, such as File Manager and the Configuration Utility. You can set a password to protect access to the System Main Menu. For help setting the password, see “Setting or Changing the System Main Menu Password” on page 76.

To access the System Main Menu

- 1 From the CK30 start screen, press **□■** and then **■□**.
- 2 If you have set a password, enter it in the System Menu Access screen and press **Enter**.

The System Main Menu appears.

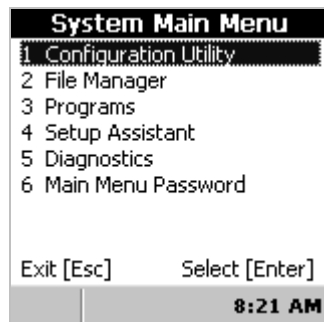

Note: If you have set a password to restrict access to the System Main Menu, an icon () appears on the status bar indicating that you are using the password-protected area of the CK30.

To exit the System Main Menu

- 1 If you are running a task that you do not want an unauthorized user to access, make sure you close it.
- 2 From the System Main Menu, press **Esc**.
- 3 When the Exit Main Menu screen appears, press **Enter**.

Managing Files on the CK30

You use File Manager to manage files on the CK30. File Manager not only lets you view all of the folders and files located on your CK30, it also lets you:

- Run an application.
- Delete a file.
- Copy a file.
- View the properties of a file.

To open File Manager

- From the System Main Menu, select **File Manager**.

The File Manager screen appears.

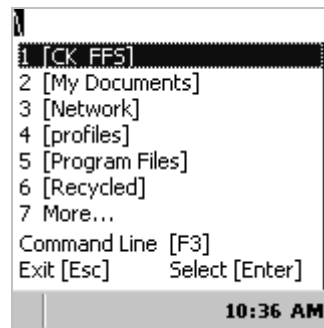

Running an Application From File Manager

You can run an application in File Manager by selecting a file and using the Run command or by using the Command Line prompt.

To run an application using the Run command

- 1 Navigate to the folder containing the application file.
- 2 Select the file by pressing the number before the file or by scrolling to it with the arrow keys and pressing **Enter**.

Chapter 4 — Managing the CK30

The following dialog box appears:



- 3 Select **Run** and press **Enter**. Your application runs.

To run an application from the Command Line

- 1 From any screen in the File Manager, press **F3**. The command line dialog box appears.

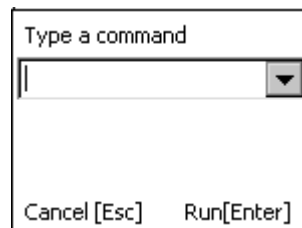

- 2 Type the path to the application and press **Enter**. Your application runs.



Note: You can also include parameters following the application name.

Deleting a File With File Manager

You can use the File Manager to delete files from your CK30.

To delete a file

- 1 Navigate to the folder containing the file you want to delete.
- 2 Select the file by pressing the number before the file or by scrolling to it and pressing **Enter**.
- 3 From the dialog box, select **Delete** and press **Enter**.
- 4 When the screen asks for confirmation that you want to delete the file, press **Enter**.

The file is deleted and you remain in the selected folder.

Copying a File With File Manager

You can use File Manager to make a copy of a file and place it in a different folder.

To copy a file

- 1 Navigate to the folder containing the file you want to copy.
- 2 Select the file by pressing the number before the file or by scrolling to it and pressing **Enter**.
- 3 From the dialog box, select **Copy**. The following dialog box appears.

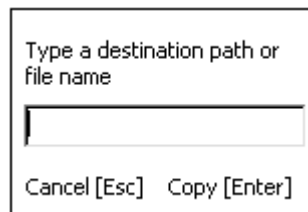

Type a destination path or
file name

Cancel [Esc] Copy [Enter]

- 4 Type the path to the folder where you want to copy the file and press **Enter**.

Viewing the Properties of a File With File Manager

You can use the File Manager to view properties about a file including the name, size, dated created, and date accessed.

To view the properties of a file

- 1 Navigate to the folder containing the file you want to view.
- 2 Select the file by pressing its associated number or by scrolling to it and pressing **Enter**.
- 3 From the dialog box, select **Properties** and press **Enter**. A screen appears showing you the details of the file.

Chapter 4 — Managing the CK30

For example, you should see something similar to this screen:

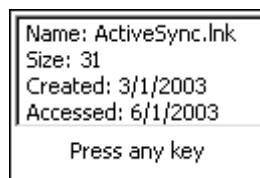

- 4 Press any key to return to the File Manager.

Managing Applications on the CK30

Task Manager provides information about applications running on the CK30. You do not need to use the System Main Menu to access Task Manager – you can access Task Manager at any time. If you have set a password to protect using the System Main Menu, you will not be able to close an application or view the properties of an application without logging in. Use Task Manager to perform these tasks:

- View all applications currently running on the CK30.
- Close an application.
- Switch between applications.
- View the properties of an application.

Viewing All Applications Currently Running on the CK30

If you want to close down an application while you are using a different application, or if you want to make sure that you have all applications closed before you close the System Main Menu, you can use the Task Manager to view all applications that are currently running on the CK30.

To view applications currently running on the CK30

- Press **Alt** and then **Tab**.

The **Task Manager** dialog box appears with the active application or task selected.

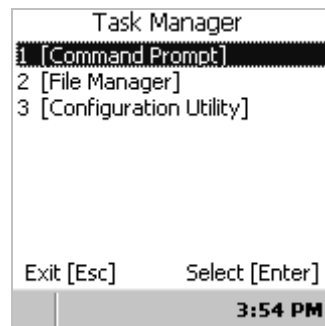

Closing an Application

You can use the Task Manager to close an application at any time. You can close the application you are currently using or another application that is running in the background.

To close an application

- 1 Select the application you want to close. A list box similar to the following appears.



- 2 Scroll to **End Task** and press **Enter**.

The application closes and you return to the System Main Menu.

Switching Between Applications

You can use the Task Manager to switch between applications without having to close down your current application.

Chapter 4 — Managing the CK30

To switch between applications

- 1 Select the application you want to switch to.
- 2 Select **Switch To** and press **Enter**.

The application you selected now appears on the screen.

Viewing the Properties of an Application

You can use the Task Manager to view two important properties of an application: the process ID and the file path to the application.

To view the properties of an application

- 1 Select the application you want to view.
- 2 Select **Properties** and press **Enter**. The Task Properties dialog box appears.

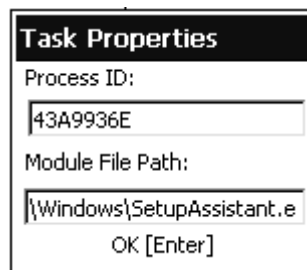

- 3 Press **Enter** to close the Task Properties dialog box.

Setting or Changing the System Main Menu Password

When you initially start the CK30, there is no password to protect access to the System Main Menu. Anyone can view and use powerful tools such as the Configuration Utility, File Manager, and Diagnostics. You may want to set a password to restrict access to the System Main Menu.

Setting a password does not restrict access to the Task Manager. However, if you have set a password, users who have not logged in will not be able to close an application or view the properties of an application.

To set a password

- 1 Press **□■** and then **■□**. The System Main Menu appears.
- 2 From the System Main Menu, select **Main Menu Password**. The Set Menu Password dialog box appears.

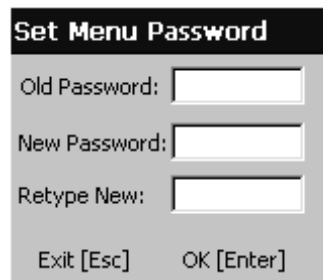

The image shows a dialog box titled "Set Menu Password". It contains three input fields: "Old Password:", "New Password:", and "Retype New:". At the bottom, there are two buttons: "Exit [Esc]" and "OK [Enter]".

- 3 Press **Tab** to move to the **New Password** field.
- 4 Type your new password, and then press **Tab** to move to the **Retype New** field.
- 5 Type your new password in again.
- 6 Press **Enter**. The screen displays a message reading "Password successfully changed."
- 7 Press **Enter** to clear the screen and return to the System Main Menu.

To change your password

- 1 Press **□■** and then **■□**.
- 2 In the **Password** field, type your password and press **Enter**.
- 3 From the System Main Menu, select **Main Menu Password**. The Set Main Menu dialog box appears.
- 4 Type your existing password in the **Old Password** field and press **Tab**.
- 5 Type your new password in the **New Password** field and then press **Tab**.
- 6 Type your new password again in the **Retype New** field.
- 7 Press **Enter**. The screen displays a message reading "Password successfully changed."

Chapter 4 — Managing the CK30

- 8 Press **Enter** to clear the screen and return to the System Main Menu.

To remove password protection

- 1 Press **□■** and then **■□**.
- 2 In the **Password** field, type your password and press **Enter**.
- 3 From the System Main Menu, select **Main Menu Password**. The Set Main Menu dialog box appears.
- 4 Type your existing password in the **Old Password** field and press **Tab**.
- 5 Leave the **New Password** field blank and then press **Tab**.
- 6 Leave the **Retype New** field blank and press **Enter**. The screen displays a message reading “Password successfully changed.”
- 7 Press **Enter** to clear the screen and return to the System Main Menu.

Backing Up Your Files

The CK30 makes it easy for you to make a backup copy of all files you have installed or modified on the computer that are not already located in the SDMMC Disk or CK_FFS folders. When you make a backup copy of the file system, the CK30 saves the file system to a folder called Persistent Copy. This folder and all of the files and subfolders it contains, are automatically restored when the CK30 cold boots.

You should back up your files any time you want to make permanent changes to the files in the Persistent Copy folder. You also need to back up the files when you want to permanently delete a file. When you install a CAB file, the CK30 automatically performs this backup process.

To back up your files

- 1 Press **□■** and then **■□**. The System Main Menu appears.
- 2 From the System Main Menu, go to **Configuration Utility > CK30 Settings > File Backup**.

- 3 Select **Backup Files Location** and choose the location where you want your files to be backed up.
- 4 Press **Enter** to save your selection.
- 5 Select **Backup the File System**.
A copy of all your files is saved to the \Persistent Copy folder in your desired location.
- 6 Press **Esc** until you exit the menu system.

Upgrading the Operating System

When you upgrade the operating system, you erase the current configuration and replace it with the new default configuration. You will need to set the network communications parameters on the wireless CK30 to reestablish communications with other devices in the wireless network. You may also need to reset the Ethernet parameters to communicate with other devices in your wired network.

To upgrade the operating system, you need:

- A Secure Digital (SD) card
- An SD card reader (optional)
- The latest operating system upgrade ZIP file available from the Intermec web site at www.intermec.com.

You can use any file transfer method (ActiveSync, FTP server, and so on) to copy the ZIP file to your SD card. Intermec recommends using an SD card reader.



Note: If you are using an SD card reader to copy files to your SD card, see “Using the SD Card” on page 25 for information on how to remove and insert the SD card.

Chapter 4 — Managing the CK30

To upgrade the operating system

- 1** Download the latest operating system upgrade ZIP file from the Intermec web site to your desktop PC.
- 2** Unzip the files on your desktop PC.
- 3** If you are using an SD card reader, remove the SD card from the CK30 and place it in the reader.
- 4** Copy all of the files to your SD card.

If you are using ActiveSync, an FTP server, or Wavelink Avalanche to copy the files to your CK30, place the files in the SDMMC Disk folder.

- 5** If you are using an SD card reader, insert the SD card into the CK30.
- 6** Perform a cold boot on the CK30. For help, see “Cold Booting the CK30” on page 103.



5 Running Diagnostics

Use the diagnostics on the CK30 to help analyze software and firmware problems, fix application problems, and view system information.

Diagnostic Test	Page Number
Battery Information	83
Bluetooth Console	84
Bootcode Version	85
Contrast Test	85
Display Test	86
Hardware Configuration Table	86
Installed Fonts	87
Intermec Value Add Information	88
Keypad Test	88
LED Test	89
Memory Information	89
Network Connection Test	89
Network Interface Information	90
Operating System Version	91
Ping Utility	91
PSC Utility	92
Radio SSI Utility	92
Read CPU Registers	93
Sound Test	93

Using Diagnostics on the CK30

You can access the System Main Menu and select Diagnostics at any time while running an application. The Diagnostics menu contains these options:

- Hardware Diagnostics
- Software Diagnostics
- System Diagnostics

Use the Hardware Diagnostics menu to run tests on the CK30 or view system information. For example, you can run an LED test to determine if your CK30 lights are working correctly or you can view how much of a charge you have left in your main battery.

Use the Software Diagnostics menu to view the version of your operating system, the bootcode version, and Intermec Value Add (IVA) information.

Use the System Diagnostics menu to help analyze network, system, or applications problems on the CK30. For example, you can run diagnostics to check the network communications.

To open the diagnostics menu

- 1 Press **□■** and then **■□**.
- 2 If you have set a password, enter it in the **System Menu Access** screen and press **Enter**. The System Main Menu appears.
- 3 Select **Diagnostics**.

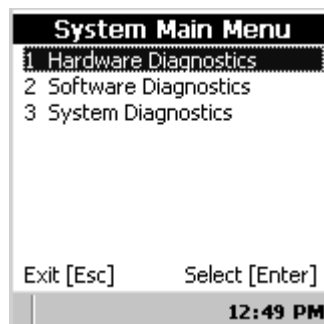

- 4 Choose the diagnostics menu you want to use.

To close the Diagnostics menu

- 1 Press **Esc** until you return to the System Main Menu.
- 2 From the System Main Menu, press **Esc**.
- 3 When the **Exit Main Menu** screen appears, press **Enter**.

When you exit the System Main Menu, the CK30 resumes the application you were running when you opened the diagnostics menu.

Understanding the Diagnostics Screens

This section lists all of the diagnostics screens in alphabetical order. You will see the following information for each diagnostics screen:

- Description, purpose, and definition
- Location of diagnostic in the System Main Menu
- A sample diagnostics screen

Battery Information

Use this diagnostic to view information on the CK30's main battery, backup battery, and AC power status.

The Main Battery section displays the percentage of battery power remaining in the battery. You can continue using the battery until the CK30 indicates that the battery is low: the battery light turns on and the low battery icon () appears on the status bar.

The Backup Battery section indicates the percentage of battery power remaining in the backup battery. The main battery charges the backup battery.

You can also use this screen to see the current volts and charging status.

From the System Main Menu:

- Go to **Diagnostics > Hardware Diagnostics > Battery Info**

Chapter 5 — Running Diagnostics

Sample Screen

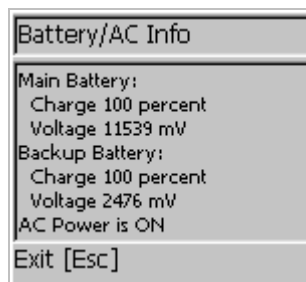

Bluetooth Console

The Bluetooth Console is a tool that helps to debug the Bluetooth driver.

You can use the Bluetooth console to perform several Bluetooth diagnostics, such as deciding whether Bluetooth hardware was recognized and initialized correctly, setting a PIN, and establishing an L2CAP connection between two Bluetooth devices. For more information on using the Bluetooth Console (or BDTC), visit the Microsoft web site.

From the System Main Menu:

- Go to **Diagnostics > System Diagnostics > Bluetooth Console**

Sample Screen

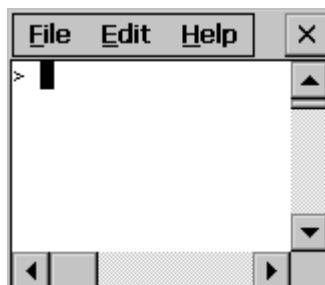

Bootcode Version

The Bootcode Version diagnostic displays the version of boot code loaded on your CK30.

From the System Main Menu:

- Go to **Diagnostics > Software Diagnostics > Bootcode Version**

Sample Screen

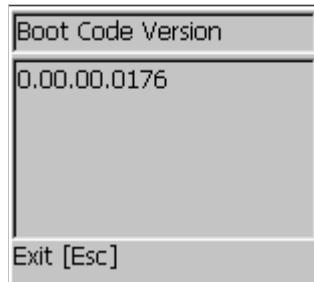

Contrast Test

Use the Contrast Test to make sure the different contrast settings are working correctly on your CK30. The test will run through all of the settings and return you to your original setting.

When you start the contrast test, the screen gradually gets darker until it is almost black and then it goes to the lightest setting which is almost white. The contrast test should take you through eight different levels of contrast. If your CK30 does not step through multiple levels of contrast, you may have a problem with your display. For help, contact your local Intermec representative.

From the System Main Menu:

- Go to **Diagnostics > Hardware Diagnostics > Contrast Test**

Chapter 5 — Running Diagnostics

Sample Screen

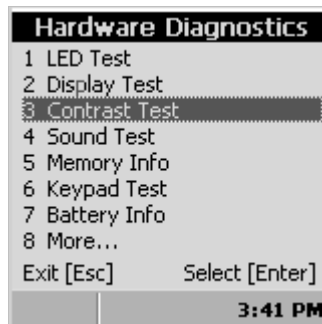

Display Test

Use the Display Test to make sure that every pixel on the CK30 screen is working correctly. For example, you may want to test the screen if you do not see complete characters on the screen. The Display Test turns all pixels on, displays horizontal stripes, displays vertical stripes, and then turns all pixels off.

From the System Main Menu:

- Go to **Diagnostics > Hardware Diagnostics > Display Test**

Sample Screen

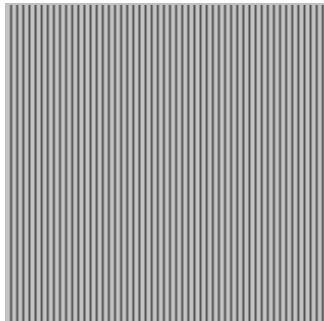

Hardware Configuration Table

Use the HW Config Table to view important information about your CK30 such as the serial number, configuration number, model, software options, and the scanner type.

Chapter 5 — Running Diagnostics

You can use this information to tell the Intermec representative information on the hardware and software that were installed at the Intermec factory.

From the System Main Menu:

- Go to **Diagnostics > Hardware Diagnostics > HW Config Table**

Sample Screen

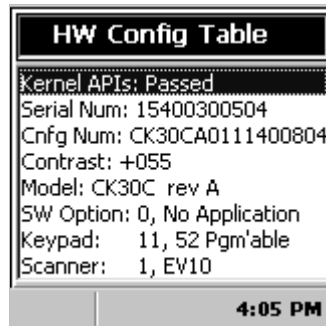

Installed Fonts

Use this screen to view all of the fonts installed on your CK30.

From the System Main Menu

- Go to **Diagnostics > Software Diagnostics > Installed Fonts**

Sample Screen

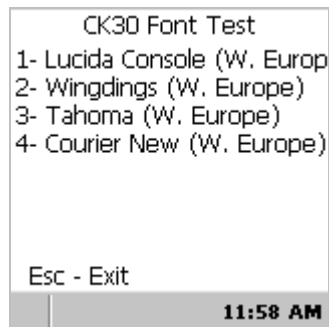

Intermec Value Add Information

Use this screen to see the versions of Intermec Value Add (IVA) products on your CK30.

From the System Main Menu:

- Go to **Diagnostics > Software Diagnostics > IVA Info**

Sample Screen



Keypad Test

A developer can use the Keypad Test to quickly find the hex value for any key on the keypad. You can also test to make sure the keypad is operating correctly.

From the System Main Menu:

- Go to **Diagnostics > Hardware Diagnostics > Keypad Test**

Sample Screen

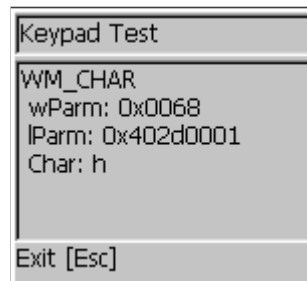

LED Test

Use the LED Test to make sure that your LEDs (lights) are operating correctly. The LED Test turns all of the lights on the CK30 on in this sequence: Good Read light, the user-defined lights, and then the System Status light. The lights blink one time each and then they blink five times each.

From the System Main Menu:

- Go to **Diagnostics > Hardware Diagnostics > LED Test**

Memory Information

Use the Memory Info diagnostic to see how much RAM and flash memory is available on the CK30. You can also see the Flash Part ID.

From the System Main Menu:

- Go to **Diagnostics > Hardware Diagnostics > Memory Info**

Sample Screen

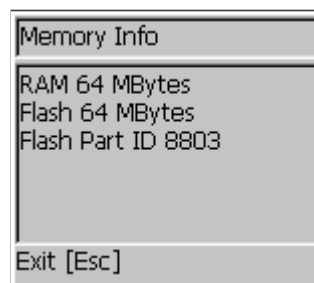

Network Connection Test

Use the Net Connect Test to test the network interface connection if you are using DHCP. The Net Connect Test searches for a DHCP server first. When the test finds a server, press **Enter** to send the Ping command. If you do not have DHCP enabled, you need to enter the IP address of the host to ping and then press **Enter**. The test sends the ping command four times and displays the results. If you receive a result other than ping OK, the test failed.

Chapter 5 — Running Diagnostics

From the System Main Menu:

- Go to **Diagnostics > System Diagnostics > Net Connect Test**

Sample Screen

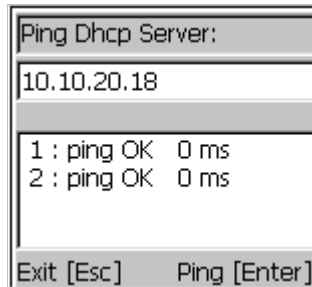

Network Interface Information

Use the Net Interface Information diagnostic screen to view the DHCP server IP address, the CK30 device address, and the MAC address.

From the System Main Menu:

- Go to **Diagnostics > System Diagnostics > Net Interface Info**

Sample Screen

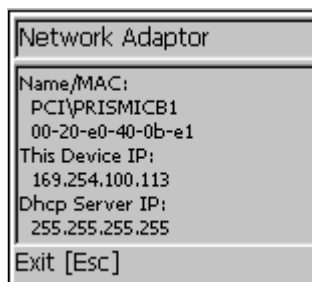

Operating System Version

Use the OS Version diagnostic screen to view the operating system software version and whether you have the Standard or Premium version loaded on the CK30.

From the System Main Menu:

- Go to **Diagnostics > Software Diagnostics > OS Version**

Sample Screen

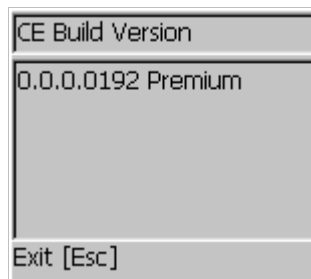

Ping Utility

Use the Ping Utility to test the network interface connection. Enter the IP address of the host to ping and then press **Enter**. The test sends the ping command four times and displays the results. If you receive a result other than `ping OK`, the test failed.

From the System Main Menu:

- Go to **Diagnostics > System Diagnostics > Ping Utility**

Sample Screen

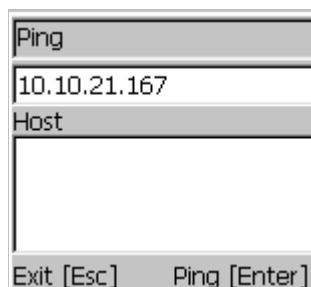

PSC Utility

The PSC (Power Supply Controller) Utility provides detailed information about the system power.

From the System Main Menu:

- Go to **Diagnostics > Hardware Diagnostics > PSC Utility**

Sample Screen

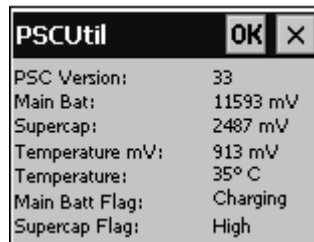

Radio SSI Utility

The radio signal strength indicator (SSI) utility displays the radio signal quality being received by the CK30. You can use this diagnostic tool to perform a site survey and determine the best locations for placing access points.

From the System Main Menu:

- Go to **Diagnostics > System Diagnostics > Radio SSI Utility**

Sample Screen

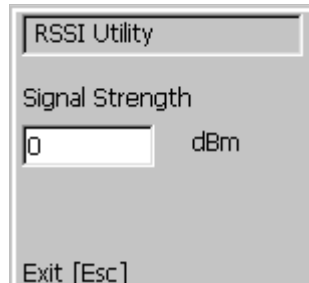

Read CPU Registers

The Read CPU Registers diagnostic reads every register in the x-scale processor chip and displays the values.

From the System Main Menu:

- Go to **Diagnostics > Hardware Diagnostics > Read CPU Registers**

Sample Screen



```
Read Registers
-----
General Purpose I/O:
GPLR0=0x092D15BF
GPLR1=0x8F43CFBF
GPLR2=0x00C0F003
GPDR0=0xC3E3A840
GPDR1=0xFCBEABC2
GPDR2=0x0001FFFF
GRER0=0x00080020
Exit [Esc]
```

Sound Test

Use the Sound Test to make sure the entire beeper volume range and beep frequency range are available and working correctly. The Sound Test can also help you choose a beeper volume and frequency that you can hear in your working environment.

When you select the test, the CK30 sounds a series of beeps from the default beep through the entire range of quiet to loud beeps. After it sounds the beeper volume, it cycles through the beeps starting with low frequency up through the highest frequency supported.

From the System Main Menu:

- Go to **Diagnostics > Hardware Diagnostics > Sound Test**

Chapter 5 — Running Diagnostics



6 Troubleshooting and Maintaining the CK30

Use this chapter to solve problems you may encounter while using the CK30. You will also find information on booting the computer and routine maintenance.

If you have any problems using the CK30, look in this chapter to find a possible solution. This chapter consists of the following sections:

Sections	Page
Problems While Operating the CK30	96
Problems While Configuring the CK30	97
Problems While Configuring 802.1x Security	97
Problems With Wireless Connectivity	99
Problems Transmitting Data Through the Serial Port	100
Problems While Scanning Bar Codes	100
Booting the CK30	102
Cleaning the Scanner Window and CK30 Screen	104

Problems and Solutions

You can also use the CK30 diagnostics to help analyze and solve problems. For help, see Chapter 5, “Running Diagnostics,” on page 81. If you have problems with the TE 2000 terminal emulation applications, see the appropriate TE 2000 guide.

If you send the CK30 in for service, it is your responsibility to save the computer data and configuration. Intermec is responsible only for ensuring that the keypad and other hardware features match the original configuration when repairing or replacing your computer.

Problems While Operating the CK30

Problem	Solution
You press ⏻ to turn on the CK30 and nothing happens.	<p>Make sure the contrast is not set all the way to the darkest or lightest setting. Press ⏻ and then ⏮ repeatedly until you reach the desired contrast level.</p> <p>If you have a CK30 with a color screen, make sure the backlight is on by pressing ⏮.</p> <p>Make sure you have a charged battery installed correctly. For help, see “Charging and Installing the Battery” on page 5.</p> <p>The battery may be discharged. Replace the battery with a spare charged battery, or charge the battery and try again.</p>
The Battery light is on.	<p>The battery charge is low. You have a few minutes of power left. Immediately replace the battery with a spare charged battery, or charge the battery.</p>
The computer appears to be locked up and you cannot enter data.	<ul style="list-style-type: none"> • (CK30 with an 802.11b/g radio only) Wait at least 10 seconds and try again. If the CK30 is still connecting to the DCS 30X or Intermec Gateway or the host, it ignores any input from the keypad or scanner. • Press ⏻ to turn off the CK30 and then press ⏻ again to turn on the CK30. • Press and hold the ⏻ button for five seconds to warm boot the CK30. • Perform a cold boot on the CK30. For help, see “Cold Booting the CK30” on page 103. • Try reloading the firmware. For help, see “Upgrading the Operating System” on page 79. • If the CK30 will not boot or reset, contact your local Intermec service representative for help.

Problems While Configuring the CK30

Problem	Solution
You scan a configuration command, such as Beeper Volume, and you hear three low beeps.	If you are working in the CK30 System Main Menu , you cannot scan configuration commands. Use the Configuration Utility to change the CK30 configuration, or exit the system menu to scan configuration commands.
You scan or enter an option for the Scanner Model configuration command and you hear three low beeps.	You may have scanned or entered a Scanner Model command that does not apply to the type of scanner that you have installed. Try scanning or entering the Scanner Model command again and select an option for the type of device you are using.
You cannot type a character on the keypad or you can only type uppercase or lowercase letters.	You may have accidentally locked a modifier key on the keypad. Check the CK30 status bar to see if it contains an icon with a locked symbol. Press the necessary key sequence to unlock the key. For help, see “Using the Keypad” on page 12.

Problems While Configuring 802.1x Security

If you have trouble configuring the computer for 802.1x security, check these problems and possible solutions.

Problems While Configuring 802.1x Security



Problem	Solution
The CK30 indicates that it is authenticated, but it does not communicate with the host.	<p>Make sure that the CK30 IP address, host IP address, subnet mask, and default router are properly configured for your network.</p> <p> Note: Do not cold boot the CK30. Cold booting the computer resets the time and date.</p>
The CK30 does not appear to be authenticating and a network connection icon does not appear on the status bar.	<p>The CK30 may not be communicating with your access point. Make sure the network name on the CK30 is the same as the network name (SSID) of the access point that you are trying to communicate with. The default network name is “INTERMEC.”</p> <p>The 802.1x security network may not be active. Make sure that the server software is properly loaded and configured on the server PC. For help, see the documentation that shipped with your server software.</p>

Chapter 6 — Troubleshooting and Maintaining the CK30

Problems While Configuring 802.1x Security (continued)

Problem	Solution
A network connection icon appears in the status bar, but it disappears.	<p>The CK30 may not be communicating with the access point that you want it to communicate with. Make sure that the network name on the CK30 is the same as the network name of the access point that you are trying to communicate with. The default network name is “INTERMEC.”</p> <p>The access point that you are trying to communicate with may not be communicating with the server. Make sure your access point is turned on, properly configured, and has 802.1x security enabled.</p>
The CK30 indicates that it is not authenticated.	<p>Make sure that:</p> <ul style="list-style-type: none">• The User Name and Password parameters on your CK30 match the user name and password on your authentication server. You may need to re-enter the password on both your CK30 and the authentication server.• On your authentication server, the user and group are allowed and the group policy is allowed to log in to the server. For help, see the documentation that shipped with your authentication server software.• The IP address and secret key for your access point must match the IP address and secret key on your authentication server. You may need to re-enter the IP address and secret key on both your access point and authentication server.• Your authentication server is active and that it can communicate with your access point. You can use the PING utility to determine communications. Go to Diagnostics > System Diagnostics > Ping Utility• The authentication server software is running on the server PC.
You are setting up multiple access points in a network, with different SSIDs, and the connection fails.	<p>The CK30 does not save WEP key values when you change the SSID. Re-enter the WEP key value after you change the SSID and select Apply Network Settings from the 802.11 Radio menu. You should now be able to connect to the different access points.</p>
You receive a message saying “The server certificate has expired or your system date is incorrect” after you cold boot the CK30.	<p>The date and time on the CK30 are not saved through a cold boot. You need to re-enter the date and time and then select Apply Network Settings from the 802.11 Radio menu.</p>

Problems With Wireless Connectivity

Problem	Solution
<p>When you turn on the CK30 after it was suspended for a while (10-15 minutes or longer), it can no longer send or receive messages over the network.</p>	<p>The host may have deactivated or lost your current terminal emulation session. In a TCP/IP direct connect network, you need to turn off the “Keep Alive” message (if possible) from the host so that the TCP session is maintained while a CK30 is suspended.</p>
<p>The no network connection icon () appears on the status bar. The CK30 is not communicating with the access point.</p>	<p>The CK30 is not connected to the access point. Make sure the access point is turned on and operating. You may also be using the CK30 out of range of an access point. Try moving closer to an access point to re-establish communications.</p> <p>Make sure the CK30 is configured correctly for your network. The radio parameters on the CK30 must match the values set for all access points the CK30 may communicate with. For help, see “Configuring 802.11b/g Radio Communications ” on page 41.</p> <p>If you have an 802.11b radio, the radio initialization process may have failed. Try resetting the CK30. See “Booting the CK30” on page 102.</p> <p>If you have tried these possible solutions and the no network connection icon still appears, you may have a defective radio card. For help, contact your local Intermec service representative.</p>
<p>The CK30 is connected to the DCS 30X or Intermec Gateway or host computer and you move to a new site to collect data. The network connection icon was visible but now the no network connection icon () is visible.</p>	<p>You may have gone out of range of an access point. Try moving closer to an access point or to a different location to re-establish communications. Once you are in range again, the network connection icon appears again. Any data you collected while out of range is transmitted over the network.</p>
<p>The network connection icon is in the status bar, but you cannot establish a terminal emulation session with the host computer.</p>	<p>There may be a problem with the host computer, a problem with the connection between the DCS 30X or Intermec Gateway and the host computer, or a problem with the connection between the access point and the host computer. Check with your network administrator to make sure the host is running and allowing users to login to the system.</p>

Chapter 6 — Troubleshooting and Maintaining the CK30

Problems With Wireless Connectivity (continued)

Problem	Solution
The network connection icon is in the status bar, but the host computer is not receiving any data from the CK30.	<p>In a UDP Plus network, there may be a problem with the connection between the DCS 30X or Intermec Gateway and the host computer. Check with your network administrator or see the user's manual for the DCS 30X or Intermec Gateway.</p> <p>In a TCP/IP network, there may be a problem with the connection between the access point and the host computer. Check with your network administrator or use your access point user's manual.</p>

Problems Transmitting Data Through the Serial Port

If you are having problems sending or receiving data through the integrated serial port on the CK30, check these possible problems:

- Make sure the CK30 is connected to the PC, host computer, or RS-232 serial device using the appropriate cable adapter and null modem cable.
- If the CK30 is in a communications dock, make sure that the communications dock is connected to the serial device using the appropriate cable.

For more information on using the serial port, see “Configuring Serial Communications” on page 39.

Problems While Scanning Bar Codes

Problem	Solution
You cannot see a red beam of light from the scanner when you press the Scan button and aim the scanner at a bar code label.	<p>There are two possible problems:</p> <ul style="list-style-type: none">• You may be too far away from the bar code label. Try moving closer to the bar code label and scan it again.• You may be scanning the bar code label “straight on.” Change the scanning angle and try again. <p>You can test the effective range of the scanner. Move within 2 feet of a wall and test the scanner. You need to be within the scanning range to scan bar code labels. For help scanning bar codes, see “Scanning Bar Codes” on page 20.</p>

Chapter 6 — Troubleshooting and Maintaining the CK30

Problems While Scanning Bar Codes (continued)

Problem	Solution
When you release the Scan button or handle trigger, the Good Read light does not turn off.	The Good Read light will remain on if you configure the CK30 to use continuous/edge triggering. If you configure the CK30 for level triggering and the Good Read light remains on, there may be a problem. Press the Scan button or pull the trigger again without scanning a bar code label. If the light is still on, contact your local Intermec service representative.
You have an input device attached to the CK30 and it cannot read any bar codes.	You may not be using an input device that is supported with the CK30. Make sure you are using one of the supported input devices and that you have selected the correct scanner model using the Configuration Utility.
The input device attached to the computer does not appear to work well or read bar code labels very quickly.	Try setting the Scanner Model command to the specific input device you have attached. Check the bar code symbologies you have enabled on the CK30. Enable only the symbologies that you are using.
The scanner will not read the bar code label.	<p>Make sure you aim the scanner beam so it crosses the entire bar code label in one pass.</p> <p>The angle you are scanning the bar code label may not be working well, or you may be scanning the label “straight on.” Try scanning the bar code label again, but vary the scanning angle.</p> <p>The bar code label print quality may be poor or unreadable. To check the quality of the bar code label, try scanning a bar code label that you know will scan. Compare the two bar code labels to see if the bar code quality is too low. You may need to replace the label that you cannot scan.</p> <p>Make sure the bar code symbology you are scanning is enabled. Use the Configuration Utility to check the symbologies. On the Symbologies Menu, each symbology that is enabled has a check mark (✓) next to the name of the symbology. If your bar code symbology is disabled, enable it and then try scanning the bar code label again.</p> <p>Make sure that the application you are running on the computer is expecting input from a bar code. You may need to type this information instead of scanning it.</p>
The scanner does not read the bar code labels quickly, or the scanning beam seems to be faint or obscured.	The scanner window may be dirty. Clean the window with a solution of ammonia and water. Wipe dry. Do not allow abrasive material to touch the window.

Chapter 6 — Troubleshooting and Maintaining the CK30

Problems While Scanning Bar Codes (continued)

Problem	Solution
You scan a valid bar code label to enter data for your application. The data decoded by the scan module does not match the data encoded in the bar code label.	<p>The computer may have decoded the bar code label in a symbology other than the label's actual symbology. Try scanning the bar code label again. Make sure you scan the entire label.</p> <p>To operate the computer quickly and efficiently, you should enable only the bar code symbologies that you are going to scan.</p>
You receive a message reading "Scanner Communication Failure" when trying to connect a 1551E or 1553 decoded scanner.	<p>Make sure that:</p> <ul style="list-style-type: none">• You are using the correct cable (P/N 3-606034-02).• The scanner cable is attached correctly. When you attach the scanner to the port, it should emit a single power up beep.• Try enabling the port state. Go to Scanners, Symbologies > CK30 Tethered Scanner > Port State.• Try upgrading the scanner firmware.• Select ASCII as the scanner model.
Your 1551E or 1553 scanner was working fine, but after changing the port setting you cannot change the configuration.	<p>The 1551E or 1553 scanner must be using the correct RS-232 settings to allow configuration from the Configuration Utility. Try disabling and then enabling the scanner port state.</p>
The configuration settings in the Configuration Utility do not match the settings on your 1551E or 1553.	<p>Try disabling and then enabling the scanner port state to synchronize the CK30 settings with the scanner.</p>

Booting the CK30

You seldom need to warm or cold boot the CK30. The CK30 uses the configuration currently saved in flash memory during the boot process.

You need to boot the CK30 when an application is locked up and will not respond, when you upgrade the firmware, or when you reflash the computer. The next instructions explain how you warm and cold boot the CK30.

Warm Booting the CK30

If your charged CK30 does not resume after pressing $\mathbf{V_o}$, or if the computer or an application is locked up, you may need to warm boot it.

To warm boot the CK30

- Press and hold $\mathbf{V_o}$ for 5 seconds. The CK30 tells you it is performing a warm boot and the screen comes back up to the start screen.

Cold Booting the CK30

If the CK30 or application is locked up and does not respond to a warm boot, follow this procedure to perform a cold boot. When you perform a cold boot, all data in your RAM storage is deleted. To make a backup copy of everything in your RAM-based storage system, see “Backing Up Your Files” on page 78.

To cold boot the CK30

- 1 Remove the battery.
- 2 Using a small pointed device (such as the end of a paper clip or pen), press the reset switch on the backside of the CK30.

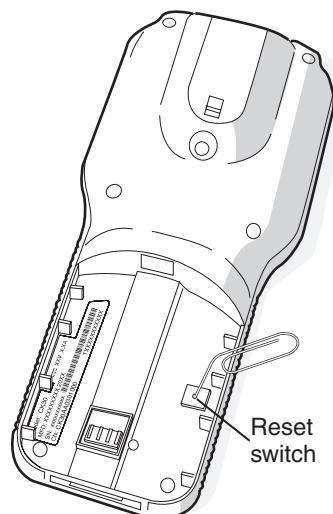



Do not use force or a sharp object when pressing the reset switch. You may damage the reset switch.

Attention: N'employez pas la force ou un objet pointu quand appuyant sur le remettez à zéro le bouton . Vous pouvez endommager le remettez à zéro le bouton.

3 Replace the battery.

The battery light on the CK30 blinks three times and the CK30 starts the power on sequence.



Note: Date and time settings are not saved through a cold boot. You will need to reset the time and date.

Cleaning the Scanner Window and CK30 Screen

To keep the computer in good working order, you may need to perform these minor maintenance tasks:

- Clean the scanner window.
- Clean the CK30 screen.

Clean the scanner window and CK30 screen as often as needed for the environment in which you are using the computer. To clean the CK30, use a solution of ammonia and water.



There are no user-serviceable parts inside the CK30. Opening the unit will void the warranty and may cause damage to the internal components.

Attention: Le CK30 ne contient pas de pièces réparables par l'utilisateur. Le fait d'ouvrir l'unité annule la garantie et peut endommager les pièces internes.

To clean the scanner window and computer screen

- 1 Press **Vo** to turn off the CK30.
- 2 Dip a clean towel or rag in the ammonia solution and wring out the excess. Wipe off the scanner window and screen. Do not allow any abrasive material to touch these surfaces.
- 3 Wipe dry.



A Appendix

Physical and Environmental Specifications

Use this section to locate technical information about the CK30 and its available features and options.

Physical Dimensions

Length:	20.3 cm (8.0 in)
Width:	8.9 cm (3.5 in)
Depth:	5.5 cm (2.15 in) with standard case, 6.2 cm (2.45 in) with wide case
Weight:	476 g (16.8 oz)

Power Specifications

Operating:	Rechargeable 2200 mAh lithium-ion battery
Backup:	Super Cap supplies 10 minutes bridge time while replacing the main battery

Electrical Specifications

Models:	CK30A, CK30B, CK30C
Electrical rating:	7.4 to 12 VDC; 500 mA peak

Temperature and Humidity Specifications

Operating temperature:	0°C to 50°C (32°F to 122°F)
Operating humidity:	10 to 90% non-condensing
Storage temperature:	-20°C to 60°C (-4°F to 140°F)
Storage humidity:	0 to 95% relative humidity, non-condensing

Screen Specifications

- 160 x 160 pixels
- 7.9 cm (3.12 in) diagonal square active area
- Contrast: eight settings
- CK30A, CK30B: electroluminescent backlight with on/off control
- CK30C: LED backlight with high and low settings

Keypad Options

- 42-key large numeric and function keypad, available with programmable, international, 3270 TE/5250 TE, and VT/ANSI TE overlays
- 50-key full alphanumeric keypad, available with programmable, international, 3270 TE/5250 TE, and VT/ANSI TE overlays
- 52-key full alphanumeric keypad, available with programmable, international, 3270 TE/5250 TE, and VT/ANSI TE overlays

Bar Code Symbolologies

- Codabar
- Codablock
- Code 11
- Code 2 of 5
- Code 39
- Code 93
- Code 128
- Interleaved 2 of 5
- Matrix 2 of 5
- Micro PDF417
- MSI
- PDF417
- Plessey
- Telepen
- RSS
- UPC/EAN

Standard Range Laser Scanner Optical Parameters

Bar Code Specification	Depth of Field / Scanning Range	
5.0 mil code	9.4 to 15.7 cm	3.7 to 6.2 in
10 mil code	7.4 to 30.5 cm	2.9 to 12.0 in
20 mil code	10.2 to 63.5 cm	4.0 to 25.0 in
30 mil code	10.2 to 86.4 cm	4.0 to 34.0 in
40 mil code	12.7 to 99.0 cm	5.0 to 39.0 in
55 mil code	19.1 to 126 cm	7.5 to 49.0 in
55 mil code, retroreflective	105 to 151 cm	41.0 to 59.0 in
100 mil code, retroreflective	113 to 227 cm	44.0 to 89.0 in

Appendix A

Advanced Long-Range Laser Scanner Optical Parameters

Bar Code Specification	Depth of Field / Scanning Range	
13 mil code**	7.52 to 9.76 m	2.47 to 3.2 ft
15 mil code	6.25 to 11.28 m	2.05 to 3.70 ft
30 mil code	10.82 to 22.71 m	3.55 to 7.45 ft
55 mil code	7.01* to 25.5 m	2.3* to 8.37 ft
70 mil code, retroreflective	29.11* to 58.27 m	9.55* to 19.12 ft
100 mil code, retroreflective	31.9* to 82.15 m	10.47* to 26.95 ft

*Near fields are governed by the width of the bar code. This number is based on a single digit Code 39 label.

**UPC only.

ID Linear Imager Reading Distances

Reading distance on the 1D line

Symbology	Density (mm)	Density (mil)	Min (mm)	Max (mm)	Min (inch)	Max (inch)
Code 39	0.1	4	95	136	3.7	5.4
	0.3	12	45	240	1.8	9.4
	0.5	20	44	300	1.7	11.8
	1	39	120	400	4.7	15.7
EAN	0,33 mm/ 100% contrast	13 mils/ 100% contrast	45	240	1.8	9.4
	0,33 mm/ 25% contrast	13 mils/ 25% contrast	61	157	2.4	6.2

Reading distances on the 2D line

Symbology	Density (mm)	Density (mil)	Min (mm)	Max (mm)	Min (inch)	Max (inch)
Code 39	0.125	5	95	146	3.7	5.7
EAN	0,33 mm/ 100% contrast	13 mils/ 100% contrast	60	205	2.4	8.1

2D Area Imager Reading Distances

Bar Code Specification	Minimum	Maximum
7.5 mil	10.2 cm (4.00 in)	21.6 cm (8.50 in)
10 mil	5.7 cm (2.25 in)	24.8 cm (9.75 in)
100% UPC	4.4 cm (1.75 in)	34.9 cm (13.75 in)
15 mil	3.8 cm (1.50 in)	39.4 cm (15.5 in)
20 mil	3.8 cm (1.50 in)	48.3 cm (19.00 in)
40 mil	8.3 cm (3.25 in)	84.5 cm (33.25 in)
55 mil	10.8 cm (4.25 in)	104.1 cm (41.00 in)
70 mil	30.5 cm (12.00 in)	182.9 cm (72.00 in)
100 mil*	45.7 cm (18.00 in)	213.4 cm (84.00 in)

*Code 39 retroreflective

Accessories for the CK30

You can use these accessories (sold and ordered separately) with the CK30. To order accessories, contact your local Intermec sales representative.

AA1 Serial Adapter

The serial adapter is a 26-pin dual-row connector to DB-9 connector that connects directly to the bottom of the CK30.

AB1 Battery

Use the lithium-ion battery to provide main power to the computer.

AC1 4-Slot Battery Charger

Use the AC1 to charge up to four AB1 batteries at a time. The battery charger is designed to sense when a battery is fully charged and not overcharge it, ensuring long and consistent battery life.

AC2 4-Bay Battery Charging Dock

Use the AC2 to charge up to four AB1 batteries without having to remove them from the CK30. You can insert up to four CK30s with batteries installed making it easy to remember to charge your batteries overnight.

Appendix A

AD1 Communications Dock

Use the AD1 to charge your AB1 battery and provide power to your CK30 while still having the ability to communicate via a serial, Ethernet, or USB port.

AD2 4-Bay Communications Dock

Use the AD2 to hold up to four CK30s with a battery installed. The AD2 dock charges the batteries, provides power to the computer, provides one Ethernet connector, and provides a serial port for each inserted CK30.

AG1 Protective Case

The protective case provides a clear vinyl covering to protect the screen and keypad area.

AG2 Protective Boot

The protective boot provides additional ruggedness for the CK30.

AH1 Handle

The handle works with all models of the CK30 and provides a convenient scanning trigger.

AL1 Holster and Belt

The holster and belt provide an easy way for you to carry the CK30 while not using it. The holster and belt support either right or left-handed use and you can use it to carry a CK30 with or without a handle. You can only use this accessory with a CK30 that has either the 1D linear imager or the 2D imager.

AL2 Handstrap

The removable and adjustable handstrap make it easy for you to hold and use the CK30 without tiring your hand.

AL3 Swiveling Belt Clip

Use the swiveling belt clip to store your CK30 while not in use. Once you have attached the belt clip, it is easy to insert and remove the CK30 as necessary.

AV1 Vehicle Cradle

Use the AV1 vehicle to attach your CK30 to a vehicle, such as a forklift. The vehicle cradle provides protection from vibrations that exceed the level the CK30 can withstand alone.

073573 Power Supply

Provides power to all of the communication docks and chargers.

Typing Characters Not Printed on the Keypad

All of the keypads use hidden key sequences to access characters not printed on the keypad overlay. Use the following tables to understand how to access these hidden characters on the different keypads.

Typing Hidden Characters on the Standard Keypads

To Type:	Press This Key Sequence on One of the Keypads:	
	42-Key	52-Key
\$	Not hidden	☐ and then 6
`	☐ and then F9	☐ and then G
!	Not hidden	☐ and then I
“	☐ and then F6	☐ and then K
'	☐ and then F7	☐ and then L
{	☐ and then F11	☐ and then N
}	☐ and then F12	☐ and then O
:	☐ and then F3	☐ and then P
;	☐ and then F4	☐ and then Q
	☐ and then F8	☐ and then R
?	Not hidden	☐ and then S
~	☐ and then F10	☐ and then T

Appendix A

Typing Hidden Characters on the International Keypads

To Type:	Press This Key Sequence on One of the Keypads:		
	42-Key	50-Key	52-Key
\$	Not hidden	Not hidden	□ and then 6
{	□ and then ^	□ and then S	□ and then 9
}	□ and then v	□ and then T	□ and then 0
<	□ and then ◀	Not hidden	Not hidden
>	□ and then ▶	Not hidden	Not hidden
]	□ and then 9	Not hidden	Not hidden
[□ and then Tab	Not hidden	Not hidden

Typing Hidden Characters on the 3270/5250 TE Keypads

To Type:	Press This Key Sequence on One of the Keypads:	
	42-Key	52-Key
\$	Not hidden	□ and then 6
<	□ and then ◀	Not hidden
>	□ and then ▶	Not hidden
]	□ and then Alpha	Not hidden
[□ and then Tab	Not hidden
`	Not applicable	□ and then G
!	Not hidden	□ and then I
«	Not applicable	□ and then K
‘	Not applicable	□ and then L
{	□ and then ^	□ and then N
}	□ and then v	□ key and then O
:	Not applicable	□ and then P
;	Not applicable	□ and then Q
?	Not hidden	□ and then R
~	Not applicable	□ and then T

Typing Hidden Characters on the VT/ANSI TE Keypads

To Type:	Press This Key Sequence on One of the Keypads:		
	42-Key	50-Key	52-Key
\$	Not hidden	Not hidden	□ and then 6
`	Not applicable	Not hidden	□ and then G
!	Not hidden	Not hidden	□ and then I
«	Not applicable	Not hidden	□ and then K
‘	Not applicable	Not hidden	□ and then L
{	□ and then F5	Not hidden	□ and then N
}	□ and then F6	Not hidden	□ key and then O
:	Not applicable	Not hidden	□ and then P
?	Not hidden	Not hidden	□ and then R

If you are using the VT/ANSI 42-key keypad for any applications besides terminal emulation, you need to press a different key sequence to access some of the hidden characters. Although you may see some of these characters on the keypad overlay, they have been reassigned to a different keypad location when you are running an application other than terminal emulation. Use this table to understand which keys you need to press to type a character that has been reassigned to a hidden location.



Note: On the VT/ANSI 42-key keypad, the left **Enter** key only functions when running the terminal emulation application.

Typing Hidden Characters on the VT/ANSI 42-Key Keypad

To Type	Press This Key Sequence on the 42-Key Keypad
?	□ and then 5
]	□ and then Alpha
[□ and then Tab
<	■ and then ◀
>	■ and then ▶
{	■ and then ▲
}	■ and then ▼
Enter	Right Enter

Default Configuration

Use the following tables to see the default configuration settings of the CK30. If you restore the CK30 to factory default settings, it will use these values. The tables are organized according to the options in the Configuration Utility. The options you see on your CK30 depend on which decode algorithm you have enabled. See the *CK30 Command Reference Manual* for more information.

Default Scanner Configuration

Symbology	Default Value
Codabar	Disabled
Codablock	Disabled
Code 11	Disabled
Code 2 of 5	Disabled
Code 39	Enabled
Code 93	Disabled
Code 128	Disabled
Interleaved 2 of 5	Disabled
Matrix 2 of 5	Disabled
Micro PDF417	Disabled
MSI	Disabled
PDF417	Enabled
Plessey	Disabled
RSS	Disabled
Telepen	Disabled
UPC/EAN	Enabled

Symbology Options	Default Value
Preamble	No characters (disabled)
Postamble	No characters (disabled)
Global Symbology ID	Disable

Appendix A

Scanner Model	Default Value
Depends on internal scanner option or tethered scanner	Depends on internal scanner option or tethered scanner

Scanner Settings	Default Value
Triggering Mode	Level
Scanner Data Buffering	Enable
Hardware Trigger	Enable
Turn Off After Good Read	Enable/One-shot

Scanner Port Settings	Default Value
Baud Rate	9600 bps
Data Bits	7 bits
Parity	Even
Stop Bits	2 stop bit
Flow Control	None

Imager Settings	Default Value
1D Omni-directional Decode Enable	Enable
Lighting Mode	Illum LED Priority
Lighting Goal	20
Image Dimension	
Top Position	0
Bottom Position	479
Aimer LED Duration	0 ms
Sticky Aimer LED Duration	0 ms

Decode Security Settings	Default Value
Decode Security	Moderate
Scanner Redundancy	None
Consecutive Data Validation	0
Identical Consecutive Timeout	300 ms
Different Consecutive Timeout	0 ms

Appendix A

Virtual Wedge Settings	Default Value
Virtual Wedge Enable	Enable
Grid	Null
Code Page	1252

Default Communications Configuration

Communication Settings	Default Value
DHCP	Enable
Device Name	WindowsCE

Name Server Settings	Default Value
Primary DNS	0.0.0.0
Secondary DNS	0.0.0.0
Primary WINS	0.0.0.0
Secondary WINS	0.0.0.0

802.11 Radio Settings	Default Value
Network Name	INTERMEC
Infrastructure Mode	Infrastructure
Security	
Network Authentication	Open
Data Encryption	Disabled
Network Key Setting	Automatic
Network Key Index	Key 1
802.1x Authentication	Disabled
Radio Power Management	Maximum
RTS Threshold	2347 octets

Wireless Extensions Settings	Default Value
Receive Window Size	8192 bytes
Initial Round Trip Time	3000 ms
Delayed ACK Time	200 ms

Appendix A

PSK Settings	Default Value
Protocol Selection	TCP/IP
Remote Connection	
Host IP	0.0.0.0
Host Port	23
Controller IP	0.0.0.0
Controller Port	23
Serial Port	
Baud Rate	115200 bps
Parity	Even
Data Bits	7 bits
Stop Bits	1 stop bit
Flow Control	None
Protocol	Configurable
EOM1	0x03
EOM2	No characters
SOM	0x02
Reader Command	Enabled without TMF
LRC	Disable
Handshake	0x00
Timeout	10 sec

UDP Plus Settings	Default Value
UDP Plus Activate	Disable
Controller IP	0.0.0.0
Controller Port	5555
Ack Delay Upper Limit	5000 ms
Ack Delay Lower Limit	300 ms
Retries	7
Send Timer	20 s
Receive Timer	45 s

Appendix A

Default CK30 Settings Configuration

CK30 Settings	Default Value
Date	June 6, 2003
Time	Time of current update
Beeper Volume	Medium
Beeper Duration	
Good Read Beep	150 ms
Low Beep	100 ms
High beep	150 ms
Beeper Frequency	
Good Read Beep	1950 Hz
Low Beep	512 Hz
High beep	1950 Hz
Backlight Timeout	1 minute
Display Contrast	Level 3
Auto Shutoff	3 minutes



Index

Symbols and Numbers

□■ key. *See* green key

■□ key. *See* orange key

¼ key, using, 14

.NET SDK, using to develop applications, 59

073573 power supply, described, 111

1D linear imager reading distances, 108

1D linear imager, scanning, 21

2D area imager reading distances, 109

2D area imager scanning, 22

3270/5250 TE keypads, typing hidden characters, 112

42-key keypad
using the Alpha key, 13
illustration, 9

4-bay battery charging dock, AC2
accessory, 109

4-bay communications dock,
accessory, 110

4-slot battery charger , AC1 accessory, 109

50-key keypad, illustration, 10

52-key keypad, illustration, 11

802.11b/g radio communications,
configuring, 41

802.1x security
configuring, 52
troubleshooting, 97

A

AA1 serial adapter accessory,
described, 109

AB1 battery
described, 109
using, 5

AC1 4-slot battery charger accessory,
described, 109

AC2 4-bay battery charging dock
accessory, described, 109

access points, determining best
locations, 92

accessing, System Main Menu, 70

accessories, described, 109

ActiveSync
installing and establishing a
partnership, 62
using to copy and install files, 64

using to install applications, 61
using to upgrade operating system, 79

AD1 communications dock,
described, 110

AD2 4-bay communications dock,
described, 110

advanced long range laser scanner
parameters, 108

AG1 protective case, described, 110

AG2 protective boot, described, 110

AH1 handle, described, 110

AL1 holster and belt, described, 110

AL2 handstrap, described, 110

AL3 swiveling belt clip, described, 110

Alpha key, using on the 42-key keypad, 13

Antares, Trakker, applications,
converting, 59

application

closing with Task Manager, 75

converting a Trakker Antares, 59

customizing how they load, 66

developing

a web-based, 59

with .NET SDK, 59

with SDK, 58

installing

using Avalanche, 66

with ActiveSync, 61

with FTP server, 65

with SD card, 65

launching automatically, 66

managing, 74

running from File Manager, 71

running from the Command Line, 72

storing on the CK30, 61

switching between, 75

viewing all currently running, 74

viewing properties, 76

area imager, scanning, 22

audio feedback. *See* beeps

authentication, troubleshooting 802.1x
security, 97

automatically launching your
application, 66

AutoRun system, using to customize how
applications load, 66

- AutoRun.dat file
 - sample file, 67
 - writing commands, 66
- AutoRun.exe, 66
- AV1 vehicle cradle, described, 111
- Avalanche, using to remotely manage the CK30, 66
- B**
- backing up files, to Persistent Copy folder, 78
- backup battery, power percentage remaining, 83
- bar codes
 - scanning, 20
 - to configure the CK30, 34
 - troubleshooting, 100
 - supported symbologies, 107
 - symbologies, default, 20
- battery
 - AB1 accessory, 109
 - charger, AC1 accessory, 109
 - charging times, 6
 - checking status, 7
 - information, diagnostics screen, 83
 - installing, 6
 - maximizing life, 7
 - status icons, 7
 - using, 5
- beeper volume, changing, 19
- beeps
 - testing, 93
 - understanding, 19
- belt clip, AL3 swiveling, accessory, 110
- Bluetooth
 - commands, described, 47
 - Console, diagnostics tool, 84
 - wireless printing, configuring, 46
- boot, protective, AG2, 110
- Bootcode Version, diagnostic screen, 85
- booting
 - CK30, 102
 - cold, 103
 - warm, 103
- C**
- CAB file, using to install applications, 60
- cables, supported scanner, 23
- capitalizing characters, 13
- Caps Lock, using, 13
- card, SD
 - inserting or removing, 25
 - using
 - to install applications, 65
 - to store applications, 61
 - to upgrade operating system, 79
- certificates, loading for security, 48
- changing your password, 77
- characters not printed on keypad, typing, 111
- charging dock, 4-bay battery, 109
- charging times, battery, 6
- CK_FFS folder, using to store applications, 61
- CK30
 - Command Reference Manual, described, x
 - default configuration settings, 114–118
 - description, 2
 - model features, 3
 - troubleshooting, guide to, 95
- cleaning
 - scanner window, 104
 - screen, 104
- click and drag, with mouse pointer, 17
- closing an application, 75
- cold boot, 103
 - preserving files through, 78
 - saving configuration changes through, 54
- color-coded keys, using, 12
- Command Line, using to run an application, 72
- Command Reference Manual, CK30, described, x
- communications dock
 - AD1 accessory, 110
 - AD2 accessory, 110
- communications
 - 802.11b/g radio, configuring, 41
 - Bluetooth radio, configuring, 46
 - configuration options, 28
 - default configuration settings, 117
 - serial, configuring, 39

Index

- configuration
 - default settings, 114–118
 - saving changes to flash, 54
 - configuration commands,
 - bar codes, scanning to configure, 34
 - sending through the network, 35
 - troubleshooting, 97
 - configuration number
 - finding with Hardware Configuration Table diagnostic, 86
 - locating on the configuration label, 2
 - Configuration Utility
 - exiting, 33
 - menu options, described, 32
 - menu structure, illustrated, 31
 - navigating within, 32
 - opening, 30
 - configuring
 - 802.11b/g radio communications, 41
 - 802.1x security, 52
 - troubleshooting, 97–98
 - Bluetooth wireless printing, 46
 - by scanning bar codes, 34
 - Ethernet communications, 44
 - example, through the network, 38
 - parameters, 28
 - security, 48
 - serial communications, 39
 - static WEP security, 53
 - TCP/IP network parameters, 41
 - through the network, 35
 - UDP Plus network parameters, 43
 - using EasySet configuration labels, 34
 - using Setup Assistant, 29
 - using the Configuration Utility, 30
 - WPA security, 49
 - contacting Intermec by phone, x
 - Contrast Test, diagnostic screen, 85
 - converting a Trakker Antares application, 59
 - copy files
 - to CK30 using ActiveSync, 64
 - using File Manager, 73
 - copyright information, xi
 - CPU Register, reading, 93
 - customizing how applications load on the CK30, 66
- ## D
- dcBrowser documentation, 4
 - default configuration
 - restoring, 33
 - settings, 114–118
 - deleting a file, 72
 - developing applications
 - using the .NET SDK, 59
 - using the SDK, 58
 - web-based, 59
 - device IP address, viewing, 90
 - DHCP server IP address, viewing, 90
 - diagnostics
 - Battery Information, 83
 - Bluetooth Console, 84
 - Bootcode Version, 85
 - Contrast Test, 85
 - Display Test, 86
 - Hardware Configuration Table, 86
 - Installed Fonts, 87
 - IVA Versions, 88
 - Keypad Test, 88
 - LED Test, 89
 - Memory Information, 89
 - Net Connect Test, 89
 - Net Interface Information, 90
 - Operating System Version, 91
 - Ping Utility, 91
 - PSC Utility, 92
 - Radio SSI Utility, 92
 - Read CPU Registers, 93
 - Sound Test, 93
 - using, 82
 - diagram, Configuration Utility, 31
 - dimensions, physical, 106
 - disabling security, 54
 - Display Test, diagnostics screen, 86
 - dock, communications
 - AD1, described, 110
 - AD2, described, 110

E

- EasySet, using to print configuration bar codes, 34
- electrical specifications, 106
- environmental specifications, 106
- Ethernet
 - communications, configuring, 44
 - icons, defined, 15
 - network diagram, 45
- exiting
 - Configuration Utility, 33
 - System Main Menu, 70

F

- factory default settings, restoring, 33
- features, CK30, 3
- File Manager
 - opening, 71
 - using
 - copy a file, 73
 - delete a file, 72
 - run an application, 71
 - view file properties, 73
- files
 - backing up, 78
 - copying with File Manager, 73
 - deleting with File Manager, 72
 - managing, 71
 - viewing the properties, 73
- flash memory, saving configuration changes, 54
- fonts, viewing installed, 87
- FTP server
 - using to install applications, 65
 - using to upgrade operating system, 79
- function keys, using, 12

G, H

- Good Read light
 - described, 18
 - troubleshooting, 101
- green key, using, 12
- gun. *See* CK30
- handle, AH1 accessory, 110
- handstrap, AL2 accessory, 110
- Hardware Configuration Table,
 - diagnostics screen, 86

- Hardware Diagnostics menu, 82
- hidden characters, typing, 111
- holster and belt, AL1 accessory, 110
- host computer not receiving data,
 - troubleshooting, 100
- HTML application, developing, 59
- humidity, specifications, 106

I

- iBrowse
 - described, 4
 - opening, 59
- icons
 - battery status, 7
 - understanding screen, 15
- IE Browser, opening, 59
- imager
 - 1D linear reading distances, 108
 - 2D area reading distances, 109
- inserting, SD card, 25
- Installed Fonts, diagnostics screen, 87
- installing
 - ActiveSync, 62
 - applications
 - using the FTP server, 65
 - using the SD card, 65
 - with Avalanche, 66
 - battery, 6
- Intermec Developer's Library (IDL),
 - 58, 60
- international keypads
 - typing hidden characters, 112
 - using, 8
- IVA Versions, diagnostics screen, 88

K, L

- keypad
 - 42-key, illustration, 9
 - 50-key, illustration, 10
 - 52-key, illustration, 11
 - international, 8
 - options, 107
 - terminal emulation, 8
 - typing hidden characters, 111
 - using, 8–14
 - using color-coded keys, 12
- Keypad Test, diagnostic screen, 88

Index

- laser scanner
 - advanced long range parameters, 108
 - scanning bar codes, 21
 - standard range parameters, 107
- launching applications automatically, 66
- LED Test, diagnostics screen, 89
- lights
 - status, 18
 - testing, 89
- loading applications, customizing, 66
- loading certificates for security, 48
- locking a key, 12

M

- MAC address, viewing, 90
- main menu
 - accessing, 70
 - exiting, 70
- managing
 - applications using Task Manager, 74
 - files with File Manager, 71
- manuals, downloading from web, ix
- maximizing battery life, 7
- Memory Information, diagnostics screen, 89
- memory, viewing available, 89
- menu structure, Configuration Utility, 31
- models, CK30, 3
- mouse
 - moving a window, 17
 - using, 16
- moving a window, 17

N, O

- navigating in the Configuration Utility, 32
- Net Connect Test, diagnostics screen, 89
- Net Interface Information, diagnostics screen, 90
- .NET SDK, using to develop applications, 59
- network
 - connection, testing, 89
 - protocols supported, 41
 - using to send configuration commands, 35
- no network connection icon, troubleshooting, 99

- Operating System Version, diagnostics screen, 91
- operating system, upgrading, 79
- operating the CK30
 - humidity range, 106
 - temperature range, 106
 - troubleshooting, 96
- optical parameters, specifications, 107
- options
 - CK30, 4
 - keypad, 107
- orange key, using, 12

P

- parameters, configuring CK30, 28
- password
 - changing the System Main Menu, 77
 - removing, 78
 - setting System Main Menu, 76
- patent information, xi
- persistence through a cold boot, configuration changes, 54
- Persistent Copy folder, backing up files, 78
- physical
 - dimensions, 106
 - specifications, 106
- Ping command
 - using to test network communications, 91
 - using to test network connection, 89
- Ping Utility, diagnostics screen, 91
- pointer, mouse, 16
- Power key. *See* **Vo** key
- power specifications, 106
- power supply
 - accessory, 111
 - controller utility, 92
- printing, configuring Bluetooth wireless, 46
- problems, finding and solving, 96
 - See also* troubleshooting
- programs. *See* applications
- properties
 - viewing applications, 76
 - viewing file, 73
- Protected Extensible Authentication Protocol (PEAP), described, 52

protective boot, AG2 accessory, 110
 protective case, AG1 accessory, 110
 PSC Utility, diagnostics screen, 92
 PSK, using to convert Trakker Antares applications, 59

R

radio
 communications, configuring, 41
 configuring 802.11b/g, 41
 configuring Bluetooth, 46
 signal, using to place access points, 92
 SSI Utility, diagnostics screen, 92
 Read CPU Registers, diagnostics screen, 93
 reading distances
 1D linear imager, 108
 2D area imager, 109
 register, displaying values, 93
 remotely managing the CK30, using
 Avalanche, 66
 removing password protection, 78
 removing, SD card, 26
 repositioning a window, 17
 reset switch, 103
 restoring default settings, 33
 RS-232 communications, configuring, 39
 RSSI Utility, diagnostic screen, 92
 Run command, using to run an application, 71
 running applications from File Manager, 71

S

safety
 icons, viii
 summary, vii
 saving changes to flash, 54
 Scan button, troubleshooting, 100
 scanner
 attaching a tethered, 23
 default configuration settings, 114–116
 list of supported devices and cables, 23
 troubleshooting, 100
 window, cleaning, 104
 scanning
 1D linear imager, 21
 2D area imager, 22
 bar codes, 20

bar codes to configure the CK30, 34
 laser scanner, 21
 screen
 cleaning, 104
 specifications, 106
 understanding icons, 15
 using, 14
 SD card
 inserting or removing, 25
 using
 install applications, 65
 store applications, 61
 upgrade operating system, 79
 SDK, using to develop applications, 58
 SDMMC disk, using to store applications, 61
 Secure Digital card. See SD card
 security
 configuring, 48
 802.1x, 52
 WEP, 53
 WPA, 49
 disabling, 54
 loading certificates, 48
 sending configuration commands through the network, 35
 serial adapter, AA1 accessory, 109
 serial communications
 configuring, 39
 network diagram, 40
 troubleshooting, 100
 setting a password, System Main Menu, 76
 settings, restoring default, 33
 Setup Assistant, using to configure CK30, 29
 site survey, using Radio SSI Utility to perform, 92
 Software Diagnostics menu, 82
 software version, viewing, 91
 sound test, 93
 specifications
 electrical, 106
 humidity, 106
 power, 106
 screen, 106
 temperature, 106

Index

- standard range laser scanner
 - parameters, 107
 - status
 - bar, described, 14
 - beeps, 19
 - troubleshooting, 97
 - checking battery, 7
 - lights, understanding, 18
 - storing your application on the CK30, 61
 - support, calling Intermec, x
 - switch, reset, 103
 - switching applications, 75
 - symbolologies, bar code
 - default, 20
 - supported, 107
 - System Diagnostics menu, 82
 - System Main Menu
 - accessing, 70
 - changing the password, 77
 - exiting, 70
 - removing password, 78
 - setting a password to protect, 76
 - system power, information on, 92
- T**
- Task Manager, using
 - close an application, 75
 - manage applications, 74
 - switch applications, 75
 - view all applications running, 74
 - view application properties, 76
 - TCP/IP
 - network diagram, 42
 - network, configuring parameters, 41
 - TE 2000. *See* terminal emulation
 - technical support, accessing on web, ix
 - telephone support, x
 - temperature, specifications, 106
 - terminal emulation
 - keypad, typing hidden characters, 112
 - keypad options, 8
 - programmer's guides, 4
 - session, problems establishing, 99
 - terminal message format (TMF), 35
 - testing
 - contrast, 85
 - display, 86
 - keypad, 88
 - LEDs, 89
 - network connection, 89
 - sound, 93
 - tethered scanner, attaching, 23
 - TKIP, using with WPA, 49
 - TMF field, defined, 37, 38
 - Trakker Antares application,
 - converting, 59
 - transaction header, defined, 36
 - transaction ID, creating, 35
 - Transport Layer Security (TLS),
 - described, 52
 - troubleshooting
 - bar code symbolologies, 102
 - configuring 802.1x security, 97
 - guide to finding solutions, 95
 - input device, 101
 - operating the CK30, 96
 - preventive maintenance, 104
 - scanning bar codes, 100
 - serial communications, 100
 - wireless connectivity, 99
 - typing hidden characters, 111
- U**
- UDP Plus
 - icons, defined, 15
 - network diagram, 43
 - network, configuring parameters, 43
 - settings, default, 117
 - understanding
 - screen icons, 15
 - status lights, 18
 - upgrading, operating system, 79
 - uppercase letters, typing, 13
 - user-defined lights, 18
 - using
 - ⌘ key, 14
 - battery, 5
 - Caps Lock, 13
 - diagnostics, 82
 - green key, 12
 - keypad, 8–14
 - mouse pointer, 16
 - orange key, 12
 - screen, 14

Index

V, W

vehicle cradle, AV1 accessory, 111
version, boot code, finding, 85
volume, beeper, changing, 19
VT/ANSI keypad, typing hidden
 characters, 113
warm booting, 103
warranty information, ix
Wavelink, Avalanche. *See* Avalanche
web-based application, developing, 59

WEP security, configuring, 53
wireless
 communications, configuring, 41
 communications, troubleshooting, 99
 icons, defined, 15
 printing, configuring, 46
work area of screen, 14
WPA security, configuring, 49
WPA-PSK security, configuring, 49

Index



Corporate Headquarters
6001 36th Avenue West
Everett, Washington 98203
U.S.A.

tel 425.348.2600

fax 425.355.9551

www.intermec.com

CK30 Handheld Computer User's Manual



P/N 073528-001

Free Manuals Download Website

<http://myh66.com>

<http://usermanuals.us>

<http://www.somanuals.com>

<http://www.4manuals.cc>

<http://www.manual-lib.com>

<http://www.404manual.com>

<http://www.luxmanual.com>

<http://aubethermostatmanual.com>

Golf course search by state

<http://golfingnear.com>

Email search by domain

<http://emailbydomain.com>

Auto manuals search

<http://auto.somanuals.com>

TV manuals search

<http://tv.somanuals.com>