**GEMINI SERIES
TELEPHONE
MODEL IQ331**

OPERATING INSTRUCTIONS

INTERQUARTZ[®]

CONTENTS

1. FEATURES	3
2. GENERAL CONTROLS AND INDICATORS	4
MULTIFUNCTIONAL INDICATOR LIGHT	5
RINGER PITCH CONTROL	5
RINGER VOLUME SWITCH	5
ALPHA-NUMERIC KEYPAD	5
CRADLE SWITCH	5
TONE / PULSE SWITCH	6
RECALL KEY	6
BASIC OPERATION	6
REDIAL KEY	6
SAVE KEY	7
PAUSE FUNCTION	7
HANDSET POLARITY SWITCH AND USING A HEADSET	8
3. ADVANCED NETWORK OPERATION	9
PAUSE FUNCTION WHEN DIALING	9
HOLDING AND TRANSFERRING CALLS	9
USING THE MEMORIES	9
4. MEMORY FEATURE OPERATION	10
STORING A NUMBER	10
DIALING A NUMBER	10
CASCADE DIALING	10
MEMORY RETENTION	10
DIGIT CAPACITY	10
5. INSTALLATION	11
UNPACKING	11
SETTING THE FLASH TIME	11
GENERAL SETTING-UP	11
LOCATION	11
WALL MOUNTING	12

LINE CONNECTION	15
HANDSET POLARITY SWITCH	15
6. GENERAL CARE AND MAINTENANCE	16
CLEANING	16
FAILURE TO OPERATE AND SERVICE DIFFICULTIES	16
7. THUNDERSTORMS	17
8. WARRANTY - 3 YEARS	17
9. SERVICE CENTRES	18

1. FEATURES

- Tone / pulse dialing
- 10 one touch memory keys
- Super bright LED ringer lamp allows visual ringing indication
- Handset Polarity Switch to suit both common (“normal” and “reversed”) Handset wiring modes allows the use of headsets configured to suit the two common wiring modes.
- Built-in Message Waiting neon type message waiting system AND Ericsson BP250 Message Waiting (other system types optional)
- User selectable ringer volume and pitch
- Redial and Pause functions
- Save function
- Switchable Recall facility with two flash time settings (100mS, 600mS) to suit the host telephone system
- Compatible with direct lines, intelligent networks, PABXs and any analog line
- Call Waiting compatible
- Telstra Customnet compatible
- Line powered, unaffected by mains power interruption
- REN (Ringer Equivalence Number) = 0.68 allows multiple parallel devices on the same line without loading incoming ring
- Alpha-numeric keypad allows full access to services that require the entering of numerals and letters
- Fully modular connection provides maximum ease of installation on desk or wall
- 3 Year warranty
- Hearing aid compatibility

2. GENERAL CONTROLS AND INDICATORS

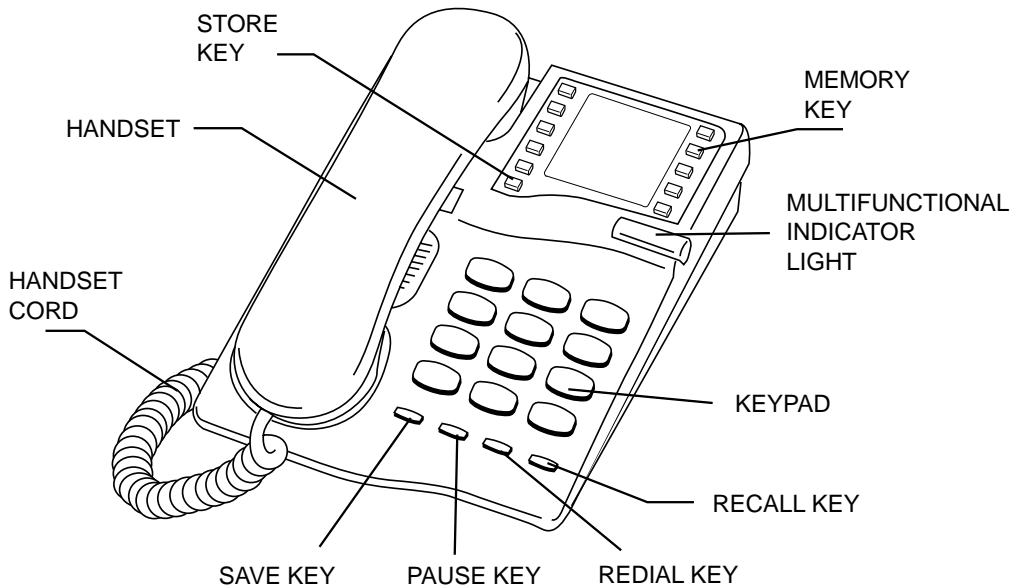

FIGURE 1 : TOP VIEW

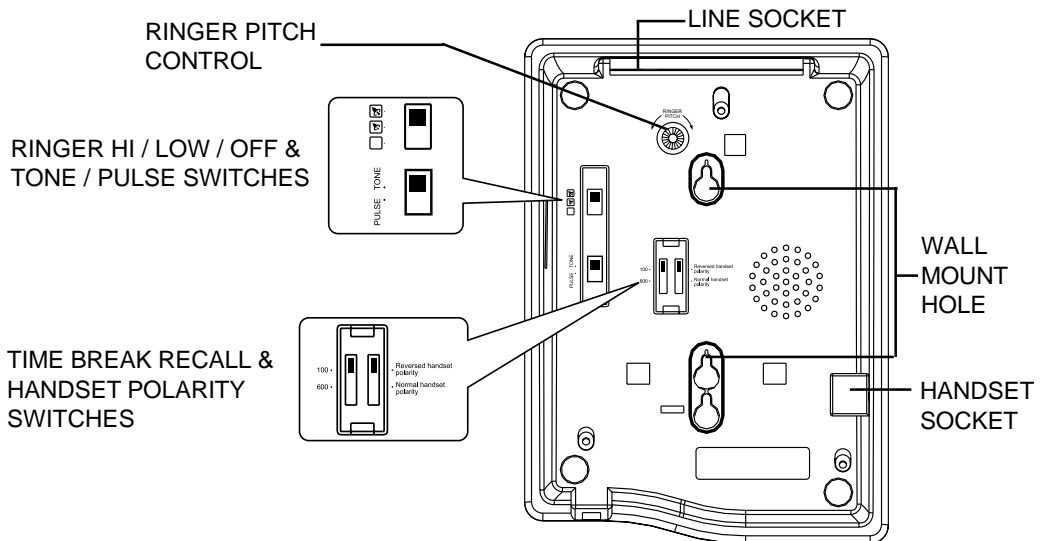

FIGURE 1 : BOTTOM VIEW

MULTIFUNCTIONAL INDICATOR LIGHT

There are two different functions:

Ring Indicator: Flashes when the telephone rings with an incoming call

Message-Waiting Indicator: Illuminates when a message is waiting in your voicemail system (depends on system compatibility). The built-in Message Waiting option suits any neon (80 VDC) type message waiting system and also the telephone has Ericsson BP250 Message Waiting built-in (other system types are optional extras).

RINGER PITCH CONTROL

The pitch of the ringing sound may be altered by rotating the control.

RINGER VOLUME SWITCH

The three available positions allow selection of OFF (no sound), LOW volume, and HIGH volume of the telephone's ringing sound during an incoming call.

ALPHA-NUMERIC KEYPAD

The standard numeric digits are available for normal dialing. The alphabetic characters are provided to allow full access to services that require the entering of numerals and letters.

CRADLE SWITCH

Located in the handset cradle, this plastic lever is depressed by the handset (when placed in the cradle) to cut off the line. Note: Depressing this cradle lever too briefly when intending to terminate a call may result in an accidental "hookflash" that will inadvertently place the call on hold. This is known as "phantom calls" because the held call will probably ring again at your extension within a few minutes (the other party will have hung up, so it will seem as if you were called by a phantom, hence the name "phantom calls"). If you experience this problem, when terminating your call please depress the cradle lever a little longer before making/receiving your next call (i.e. it is not a system or telephone fault).

TONE / PULSE SWITCH

Used to select the dialing mode, either TONE (DTMF) or PULSE (Decadic). The correct mode depends on the telephone network. If in any doubt, contact your authorised Interquartz dealer.

RECALL KEY

For use with host telephone systems to invoke special network facilities such as call-hold or call-transfer available in your system.

For further details please consult your host system manuals or user training service. Please see the INSTALLATION section for details to adjust the telephone's Flash time, to ensure that the key functions correctly.

BASIC OPERATION

This telephone can be used as a normal telephone; lift the HANDSET to answer an incoming call, or lift the HANDSET and dial on the KEYPAD to commence an outgoing call. Please refer to the appropriate sections to learn more about advanced operating instructions.

REDIAL KEY

Press to redial the last manual number previously dialed, which may be up to 32 digits long. Dialing more than 32 digits during one call will cause erasure of the entire number from the REDIAL memory.

TO REDIAL LAST NUMBER

1. Lift HANDSET
2. Press REDIAL .

SAVE KEY

The save key can be used either to save the redial memory by simply pressing the save key after a number is dialed and before hanging up the phone.

To use the save key as a notepad during a call:

1. press the store key
2. enter the desired number (up to 32 digits)
3. press the save key before hanging up the phone.

PAUSE FUNCTION

The Pause command may be needed if your phone is connected to certain types of PABX or to any network where a pause is required (e.g. between internal and external dial tones).

For manual dialing:

1. Lift HANDSET
2. Dial any digits required before the pause
3. Press PAUSE
4. Dial the remaining digits.

For memory usage (storage procedure):

1. Lift HANDSET
2. Press STORE
3. Dial digits required e.g.number line access code before dialing the pause
4. Press PAUSE
5. Dial remaining digits
6. Press STORE
7. Select and press desired MEMORY button
8. Replace HANDSET

When dialed, this stored number will Pause at the appropriate place in the dialing sequence.

HANDSET POLARITY SWITCH

Located on the underside of the telephone, this switch provides compatibility with the two handset wiring standards - normal or reversed (see section 5 and figure 4)

Set handset polarity switch to normal to use handset, or set the switch to reversed position if you are using a headset that is wired to suit this setting.

USING A HEADSET

A headset may be plugged into the handset socket on the side of the telephone. Headset cords are commonly wired in one of two ways, so this telephone has been equipped with a special switch to ensure compatibility with your headset. By testing the headset in both positions, the correct position can be easily found.

To use the telephone to make a call with a headset:

1. Connect the headset (see above) and wear it.
2. Lift the handset.
3. Dial the desired number.
4. To terminate the call, replace the handset in the cradle.

3. ADVANCED NETWORK OPERATION

Where this telephone is used on an intelligent network such as Easycall, Customnet, Centel, a PABX or other network the following information may be useful.

PAUSE FUNCTION WHEN DIALING

Depending on your telephone system, this may or may not be required. If in doubt, check with your system supplier or Interquartz dealer, as failure to observe your system's requirements may lead to difficulty in making outgoing external calls. If you have determined that a pause is required by your host system, please refer to the PAUSE Function section to ensure correct usage of the PAUSE button.

HOLDING AND TRANSFERRING CALLS

The method used for these functions is dependent on your system type, so you will need to check your system's Extension User Guide. The RECALL KEY is typically used to transfer calls. It is affected by the setting of the adjustment switches described in the INSTALLATION section of this manual. They must be correctly set to suit your system for correct operation.

USING THE MEMORIES

Many different numbers and codes can be stored. You may find it useful to store some of your favourite network facility commands in the telephone for fast, convenient access to those facilities (e.g. diversion, call forward, call back etc). Consult your system User Guide for the codes that you need to store.

4. MEMORY FEATURE OPERATION

Located at the top of the keyboard, the **ONE-TOUCH MEMORY** Keys provide easy dialing of often-used numbers. Each memory can store 16 digits and can store *, #, Pause and commands.

STORING A NUMBER :

1. Lift HANDSET
2. Press STORE
3. Enter the telephone number
4. Press Store
5. Press desired memory key location
6. Replace HANDSET

DIALING A NUMBER :

1. Lift HANDSET
2. Press desired memory key location.

CASCADE DIALING

The contents of any memory can be "cascaded" or added together with additional manual dialing or other memories. In cascade dialing, make sure that each dialing sequence is completed before activating the next.

MEMORY RETENTION

The telephone is capable of retaining its memory contents for up to 5 YEARS even when the telephone line had been disconnected. The telephone can retain its memory contents for up to 30 minutes when unplugged from its line cord.

DIGIT CAPACITY

All memories can store up to 16 digits each. The memories can store digits 1-9, 0, *, and #.

5. INSTALLATION

UNPACKING

The carton contains the following :

- Telephone body and handset
- Coiled cord and line cord
- This User Manual.

SETTING THE FLASH TIME

Set the TBR TIMING SWITCH to suit the PABX or host system's required flash time. This setting is needed to ensure correct operation of the Recall key on the top panel. The settings available are - 100mS, 600mS. (see figure 4)

GENERAL SETTING-UP

1. Fit the COILED CORD to the appropriate sockets in the HANDSET and the telephone base
2. Fit the LINE CORD to the rear socket and to your telephone network outlet
3. Set the Ringer Volume and Ringer Pitch controls
4. See following sections to complete the installation.
5. Set handset polarity switch "normal" to use the handset, or set the switch to "reversed" position if you are using a headset that is wired to suit this setting.

LOCATION

The telephone should be placed on a desk, table or shelf where it is not likely to be pushed off. If the unit is to be wall mounted, it should be seated securely on the WALL MOUNTING BRACKET. Avoid excessive heat, damp, dust, direct sunlight, vibration, and other appliances or devices that may transmit or emit electrical or electromagnetic radio frequency noise or signals (e.g. computers, welders, pagers).

WALL MOUNTING

1. Fit the WALL MOUNT BRACKET (optional, not supplied) to the wall and attach the WALL MOUNT BRACKET to the underside of telephone (see Figure 2)
2. To enable the HANDSET to be supported in the cradle, follow the procedure shown in (Figure 2) to reverse the HANDSET RETAINER.
3. NOTE: The WALL MOUNT BRACKET and MODULAR WALL JACK illustrated in (Figure 2) are available from your authorised Interquartz dealer and can be ordered as "Wall Mount Kit No.3".

1. Use your thumb to press the HANDSET RETAINER

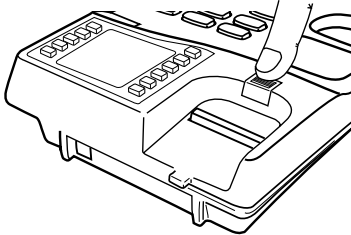

2. Push the HANDSET RETAINER out of the slot.

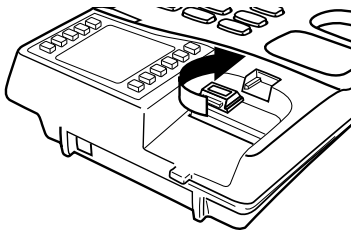
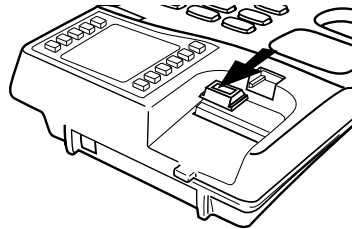

3. Rotate the HANDSET RETAINER by 180°

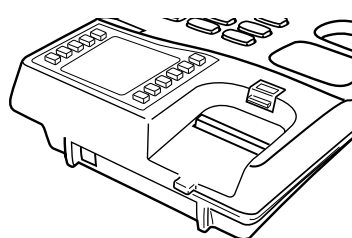

4. Insert the HANDSET RETAINER back into its slot.

FIGURE 2: WALL MOUNTING

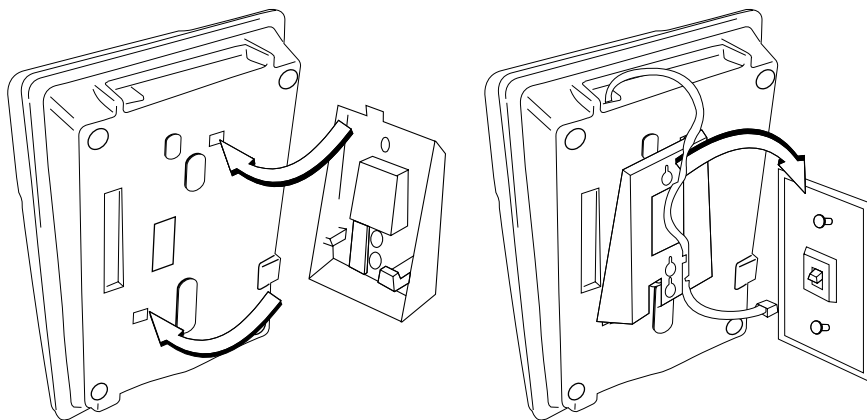
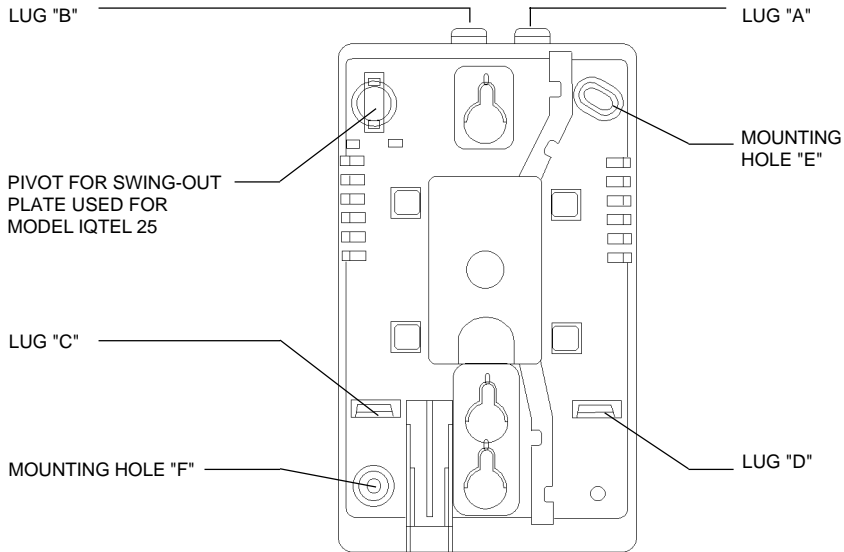

FIGURE 2 : WALL MOUNT BRACKET

WALL-MOUNT BRACKET (OPTIONAL NOT INCLUDED WITH PHONE)



Please note:

1. This wall bracket may be secured onto the wall by using mounting holes "E" and "F"
2. Lugs to break off before wall mounting the phone.

TELEPHONE MODELS		BREAK OFF LUGS
IQ 90 IQ 150 IQ 250 IQ 260 IQ 360 IQ 350 IQ 450 IQ 550 IQ E2 IQ E3	IQTEL 80 IQTEL 300 IQTEL 500 IQTEL E1 IQTEL E2 IQTEL E3 IQTEL ET STUDIO 20 GEMINI IQ33X SERIES	"B" and "D"
IQTEL 25		"A" and "C"
IQ 300 9853 XT 9835 MKII 9836 9837		"A" ONLY

FIGURE 3

LINE CONNECTION

This telephone is supplied with a RJ45 Plug as the wall plug, with the centre pair being reserved for speech and signaling. Other types of plugs and cords are available on request.

HANDSET POLARITY SWITCH

Located on the underside of the telephone, this switch provides compatibility with the two handset wiring standards (normal and reversed)

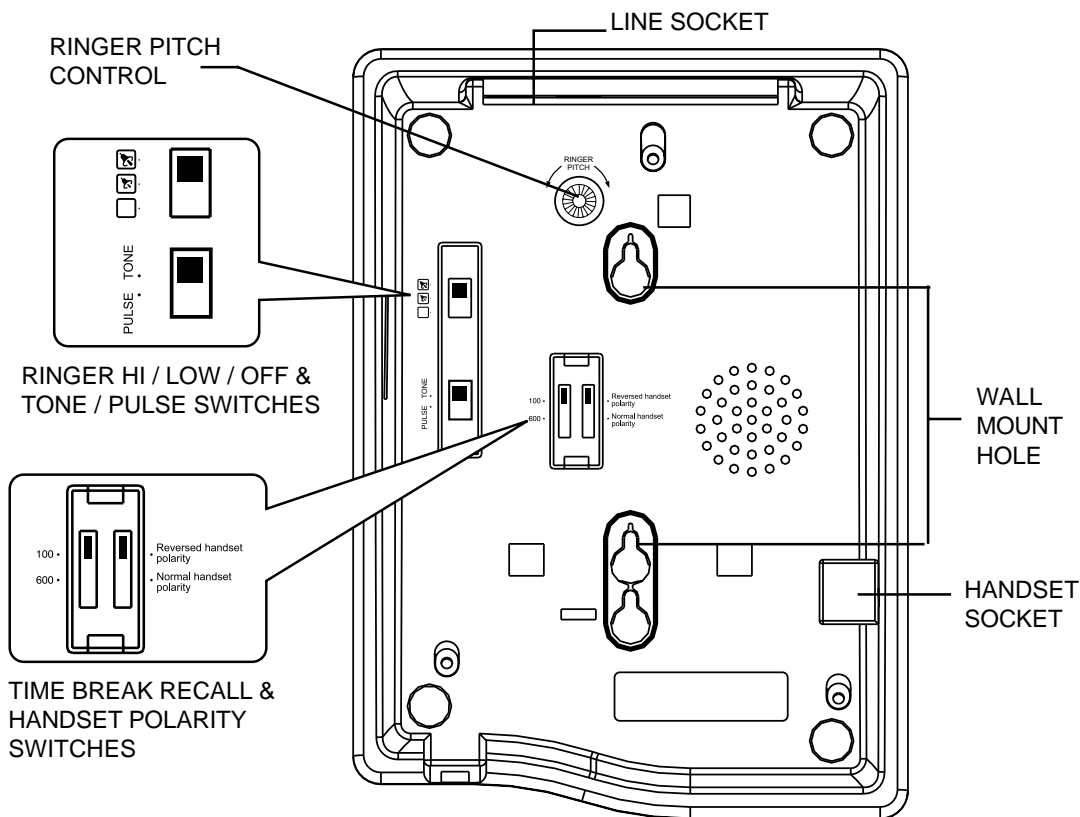

FIGURE 4

6. GENERAL CARE AND MAINTENANCE

This telephone is a precision electronic instrument. While in use and storage, care should be taken to avoid rough handling, extreme temperature, and damp or dirty environments.

CLEANING

NEVER use aerosol sprays or other chemical agents or substances that leaves a residue (furniture polish for example).

Use a mild detergent and a damp, clean cloth when cleaning. Do not allow moisture to enter the telephone's interior - damage may result!

FAILURE TO OPERATE AND SERVICE DIFFICULTIES

If telephone service problems occur at any time, it is recommended that the installation procedure described in this manual be re-checked. If a fault occurs, try to determine if the fault is with the telephone, or with the network or system to which the telephone is connected : Disconnect the "suspect" telephone, and test the line with a substitute telephone. If the telephone service then operates satisfactorily, the fault is in the "suspect" telephone. Test the "suspect" telephone on a known good line. If the fault still occurs, the fault is in the "suspect" telephone.

Consult your Interquartz dealer for further advice if necessary.

7. THUNDERSTORMS



The telephone, in common with household electrical appliances, can be a source of electric and acoustic shock during thunderstorms. The possibility of a telephone user experiencing a shock is minimal. Nevertheless, customers should be aware of some simple precautions to follow during thunderstorms:

Use your telephone only for calls of the utmost urgency. Keep these calls brief.

Whilst using your telephone keep clear of electrical appliances and metal fixtures such as : stoves, air conditioners, refrigerators, window frames and sinks.

8. WARRANTY - 3 YEARS

Interquartz (A'Asia) Pty Ltd warrants the original purchaser against failure, under normal usage and in the environment and network for which it was designed, resulting from defective material and workmanship at time of manufacture for a period of THREE YEARS from the date of purchase. Proof of purchase and date of purchase are required for determining validity of this warranty. This warranty does not cover defects or damage due to normal wear and tear, negligence, accidents, exposure to radiation, misuse, obsolescence, incompatibility, improper maintenance, lightning strikes or unauthorised repairs or modifications and excludes freight or postage costs to/from your local authorised service centre unless otherwise arranged. Consequential loss not included. Notification of any defect must be made within the warranty period before a warranty repair can be effected. This guarantee is in addition to all other Warranties or Guarantees expressed or implied by the Trade Practices Act or other Commonwealth or State laws and all other obligations and liabilities on the part of Interquartz (A'Asia) Pty. Ltd.

9. SERVICE CENTRES

Please call 1800 6 IQTEL (1800 647 835) from anywhere in Australia to arrange service or repair of your telephone.

Manufactured by
International Quartz Limited

A Subsidiary of Chiaphua Industries Ltd.
©Copyright INTERNATIONAL QUARTZ LTD. 2002

3CT30001-03B

Free Manuals Download Website

<http://myh66.com>

<http://usermanuals.us>

<http://www.somanuals.com>

<http://www.4manuals.cc>

<http://www.manual-lib.com>

<http://www.404manual.com>

<http://www.luxmanual.com>

<http://aubethermostatmanual.com>

Golf course search by state

<http://golfingnear.com>

Email search by domain

<http://emailbydomain.com>

Auto manuals search

<http://auto.somanuals.com>

TV manuals search

<http://tv.somanuals.com>