USER GUIDE

GEMINI SERIES

TELEPHONE

MODEL IQ333

By

INTERQUARTZ[®]

CONTENTS

1. FEATURES	3
2. GENERAL CONTROLS AND INDICATORS	4
BASIC OPERATION	6
MULTIFUNCTIONAL INDICATOR LIGHT	6
RINGER VOLUME SWITCH	6
ALPHA-NUMERIC KEYPAD	6
CRADLE SWITCH (and the Interquartz anti-ring back feature)	7
ELECTRONIC VOLUME CONTROL	7
RECALL KEY	7
HANDSFREE / HEADSET KEY AND INDICATOR (with auto-detection)	7
MUTE KEY AND INDICATOR	8
REDIAL / PAUSE KEY	8
HEARING-AID COMPATIBILITY	9
3. HANDSFREE OPERATION	9
HANDSFREE MICROPHONE	9
USING THE HANDSFREE / HEADSET KEY	9
CHANGING FROM HANDSFREE TO HANDSET DURING A CALL	10
CHANGING FROM HANDSET TO HANDSFREE DURING A CALL	10
OUTGOING CALLS USING HANDSFREE (MANUAL OR MEMORY DIALLING)	10
HINTS FOR HANDSFREE OPERATION	10
4. HEADSET OPERATION	11
BASIC OPERATION	11
HANDSFREE / HEADSET AND HANDSET MODES	11
TRAINEE / SUPERVISOR MODE	12
TRAINEE MODE	12
SUPERVISOR MODE	12
SILENT RINGING FEATURE	12
VOLUME CONTROL	13

5. ADVANCED NETWORK OPERATIONS	13
PAUSE FUNCTION WHEN DIALLING	13
HOLDING AND TRANSFERRING CALLS	14
USING THE MEMORIES	14
6. MEMORY FEATURE OPERATION	14
STORING A NUMBER	14
DIALLING A NUMBER	15
CASCADE DIALLING	15
MEMORY STORAGE TIME	15
7. INSTALLATION	15
UNPACKING	15
GENERAL SETTING-UP	15
LOCATION	16
WALL MOUNTING	16
HEADSET	16
LINE CONNECTION	16
TECHNICAL ADJUSTMENTS – FOR CORRECT OPERATION	19
MESSAGE WAITING LIGHT COMPATIBILITY	19
HEADSET MIC ADJUST CONTROL	19
HEADSET POLARITY SWITCH	20
8. GENERAL CARE AND MAINTENANCE	22
CLEANING	22
FAILURE TO OPERATE AND SERVICE DIFFICULTIES	22
9. THUNDERSTORMS	23
10. WARRANTY – 3 YEARS	23

1. FEATURES

- Tone dialling
- Handsfree speakerphone
- Built-in headset socket to suit a wide range of headset types
- 10 one-touch memory keys (non-volatile memories)
- Push-button electronic volume control for Handsfree / Headset / Handset speakers
- Mute key and indicator - for privacy on Handset, Handsfree and Headset microphones
- Headset microphone sensitivity adjustment to suit both high gain and low gain headset microphones
- Headset cable polarity switch to suit both common headset plug wiring modes (normal and reversed modes)
- Mid-call mode change feature (change from Handsfree to Headset to Handset in any order during a call)
- Trainee / Supervisor mode allows both a handset user and a headset user to be online simultaneously without the need for a headset training cord or adaptor
- "Silent Ringing" feature for headset users allows the ringing to be heard in the headset only (keeps call center noise levels down by eliminating the sound of ringing)
- Super bright LED ringer lamp allows visual ringing indication
- Built-in Message Waiting Light option to suit any neon (80 VDC) type message waiting light system (other system types optional)
- User selectable ringer volume (Hi / Low / Off)
- Redial and Pause functions
- Recall facility (at 600ms flash timing)
- Compatible with direct lines, intelligent networks, PABX and any analog line
- Call Waiting compatible
- Line powered, unaffected by mains power interruption
- Hearing aid compatibility

- REN (Ringer Equivalence Number) = 0.68 allows multiple parallel devices on the same line
- Alphanumeric keypad allows full access to services that require the entering of numerals and letters
- Fully modular connection provides maximum ease of installation on desk or wall
- 3 year warranty

2. GENERAL CONTROLS AND INDICATORS

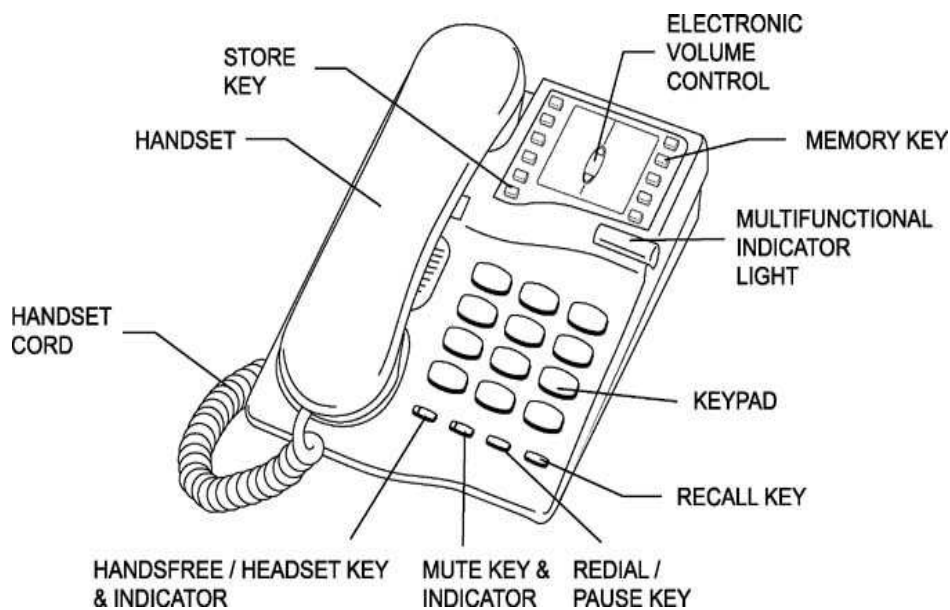

FIGURE 1: TOP VIEW

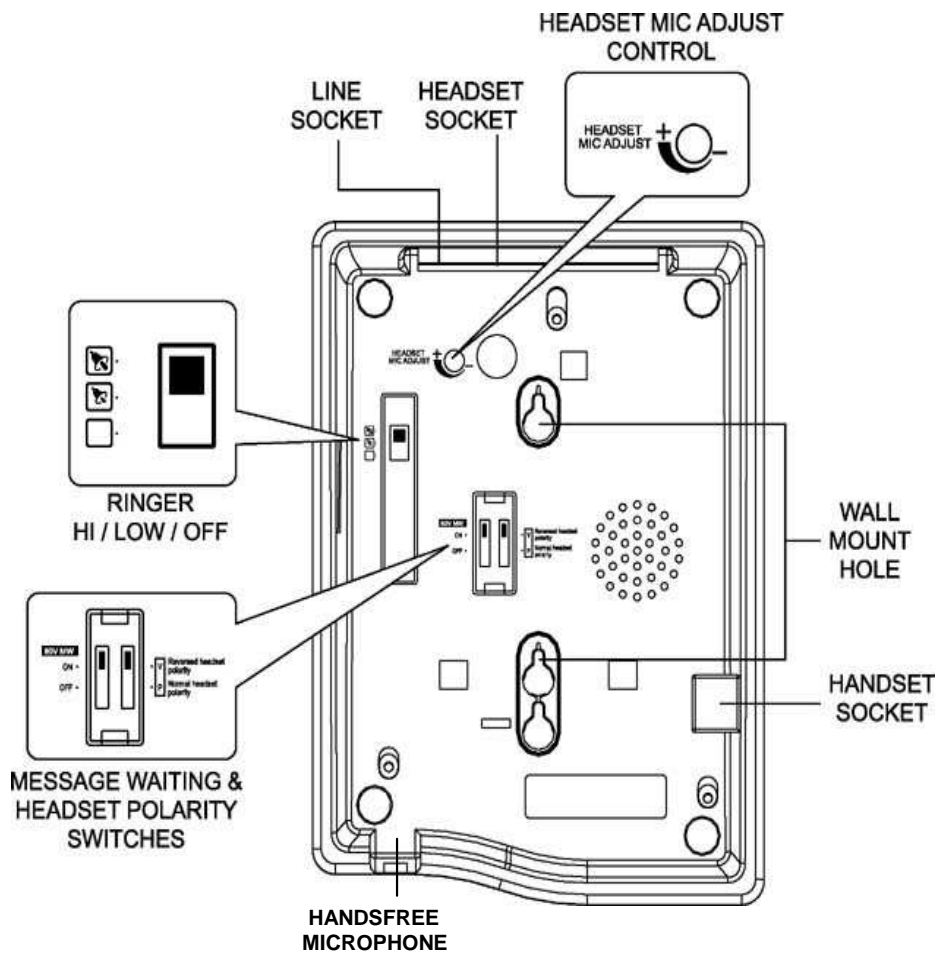

FIGURE 1: BOTTOM VIEW

BASIC OPERATION

This telephone can be used as a normal telephone; lift the HANDSET to answer an incoming call, or lift the HANDSET and dial on the KEYPAD to commence an outgoing call. Please refer to the appropriate sections to learn more about advanced operating instructions.

MULTIFUNCTIONAL INDICATOR LIGHT

There are two different functions:

Ring Indicator function:

Flashes when the telephone rings with an incoming call

Message-Waiting Indicator function:

This Message-Waiting Indicator Light is not compatible to the NZ Telecom voicemail system. However when connected to a compatible PBX system this light will illuminate when a message is waiting in your voicemail system. The built-in Message-Waiting Light suits any neon type (80 VDC) message waiting system (other system types require modification to the telephone and are subject to variable modification cost depending on the system type).

RINGER VOLUME SWITCH

The three available positions allow selection of OFF (no sound), LOW volume, and HIGH volume of the telephone's ringing sound during an incoming call.

ALPHA-NUMERIC KEYPAD

The standard numeric digits are available for normal dialling. The alphabetic characters are provided to allow full access to services that require the entering of numerals and letters.

CRADLE SWITCH (and the Interquartz anti-ring back feature)

The cradle switch is the plastic lever in the middle of the handset cradle, when the handset is placed in the cradle it depresses this plastic lever to hang-up and cut-off the telephone line.

The Interquartz Anti-Ring Back feature avoids those annoying “ring backs” or sometimes referred to as “phantom calls”. A “phantom call” is when the telephone rings immediately after you think you have just hung-up. However when you answer there is neither anyone nor any dial tone there; hence a phantom call. This happens because of an unintentional PBX (or exchange) recall; PBX recall is also referred to as hook-flash (that is, one quick tap of the cradle switch lever). Having the Interquartz Anti-Ring Back feature means that you cannot tap the cradle switch lever (i.e. the hook-flash action) to recall the PBX (thus no unintentional recall or hook-flash). The cradle switch lever is for hang-up only. You can recall the PBX (or exchange) via the PBX RECALL key. PBX means Private Branch Exchange.

ELECTRONIC VOLUME CONTROL

These two push-buttons are used to adjust the 4-steps hearing volume levels of the HANDSET, HEADSET or HANDSFREE speaker.

Press (vol+) or (vol-) to adjust the volume up or down. Adjusting this control does not affect your outgoing voice level.

RECALL KEY

This key is for use with the host telephone system to invoke a system recall prior to activating a system facility such as call-hold or call-transfer.

HANDSFREE / HEADSET KEY AND INDICATOR (with auto-detection)

When the HANDSFREE / HEADSET KEY is pressed the red indicator on the key will glow to indicate that the HANDSFREE mode is activated (or HEADSET mode is activated). The telephone automatically detects if a headset is attached to the telephone and engages the HEADSET mode instead of the HANDSFREE mode.

MUTE KEY AND INDICATOR

When pressed, the Mute key cuts off transmission from the handset, handsfree and headset microphones to allow user privacy. The red indicator on the Mute key will glow to indicate that the mute condition is active. Press the Mute key again to release the mute condition. The red indicator on the key will stop glowing.

REDIAL / PAUSE KEY

Redial Function

Press to redial the last number previously dialled, provided that the last number dialled was 32 digits or less. Dialling more than 32 digits during one call will cause erasure of the entire number from the redial memory.

EXAMPLE: TO REDIAL LAST NUMBER

1. Lift HANDSET, or press HANDSFREE / HEADSET KEY
2. Press REDIAL.

Pause Function

The Pause function may be needed in a dialling sequence if your telephone is connected to any network where a pause is required (e.g. between internal and external dial tones).

For manual dialling:

1. Lift HANDSET
2. Dial any digits required before the pause
3. Press PAUSE
4. Dial the remaining digits

For memory usage (storage procedure):

1. Lift HANDSET, or press HANDSFREE / HEADSET KEY
2. Press STORE
3. Dial digits required before dialling the pause e.g. number or line access code

4. Press PAUSE
5. Dial remaining digits
6. Press STORE
7. Select and press desired MEMORY key
8. Replace HANDSET or press HANDSFREE / HEADSET KEY

When dialled, this stored number will pause at the appropriate place in the dialling sequence.

HEARING-AID COMPATIBILITY

This is a standard feature in the handset for users with a "T switch" type hearing aid.

3. HANDSFREE OPERATION

HANDSFREE MICROPHONE

The Handsfree microphone is located at the front of the telephone (see Figure 1 Bottom View). While your telephone is in HANDSFREE mode it will pick up and transmit your voice as you speak to the other party. Positioning of the telephone, and therefore the microphone, is important to ensure the best pick-up and transmission of your voice.

USING THE HANDSFREE / HEADSET KEY

To commence a Handsfree call press the HANDSFREE KEY; the telephone will activate the line, the SPEAKER, the HANDSFREE MICROPHONE and the INDICATOR will switch on to provide confirmation. Dialling and speech can then commence. Pressing this key again will terminate the call.

Incoming calls using HANDSFREE:

1. Telephone rings
2. Press HANDSFREE / HEADSET KEY
3. Commence your Handsfree conversation

Changing from HANDSFREE to HANDSET during a call

Lift the HANDSET and resume your conversation; the HANDSFREE function will switch off automatically.

Changing from HANDSET to HANDSFREE during a call

1. Press HANDSFREE / HEADSET KEY
2. Replace HANDSET
3. Resume your conversation using the Handsfree function.

Outgoing calls using HANDSFREE (manual or memory dialling)

1. Press HANDSFREE / HEADSET KEY
2. Dial the required number on the alphanumeric keypad or via the MEMORY keys
3. Commence your Handsfree conversation when connected

HINTS FOR HANDSFREE OPERATION

As a courtesy, tell the other party that you are using the Handsfree function. He / She may or may not want people other than yourself to hear the conversation. A quiet environment ensures best Handsfree performance. If you are in a noisy room or near a noise-generating device (for example, a TV set) all or part of the conversation may be interrupted and cannot be heard. To eliminate this problem try to lower the noise level in the room.

During the handsfree conversation, your telephone will give priority to the person who speaks louder when both people are talking simultaneously. Speak only after the other person pauses or stops.

If the other person complains about poor transmission, talk directly at your telephone and from a closer distance as necessary, or lower the speaker volume.

4. HEADSET OPERATION

This telephone can be configured to suit many different headsets - please consult the INSTALLATION section for details to get the best performance from your headset.

(Warning: Only use NZ Telecom Telepermit Approved headsets with this telephone)

BASIC OPERATION

To receive or make a call using the headset:

(Please ensure that the headset is connected to the telephone correctly and that you are wearing the headset correctly)

- To receive calls simply press the HANDSFREE / HEADSET key and speak into the headset microphone. To hang-up press the HANDSFREE / HEADSET key again.
- To make calls simply press the HANDSFREE / HEADSET key and you should hear the dial tone. Dial the number you are calling either using a pre-stored memory key or dial using the keypad. To hang-up press the HANDSFREE / HEADSET key again.

HANDSFREE / HEADSET AND HANDSET MODES

A call can be switched between the Handsfree / Headset mode and the Handset mode by pressing the HANDSFREE / HEADSET KEY or by lifting the handset.

The HANDSFREE / HEADSET KEY has auto-detection function. When a headset is correctly connected to the telephone, the Handsfree function is automatically disabled to allow the HANDSFREE / HEADSET KEY to work in Headset mode. You can unplug the headset from the telephone to revert back to Handsfree mode (even during a call).

Lifting the handset during headset mode will change to handset mode operation. To revert back to headset mode operation from handset mode simply press the HANDSFREE / HEADSET KEY and if appropriate replace the handset to the cradle.

TRAINEE / SUPERVISOR MODE

In this mode you are using the handset and the headset in tandem. This allows a supervisor to monitor a trainee's progress during a call, or "take over" a call. The following procedures assume that the trainee is wearing the headset and a call is in progress.

Trainee Mode

This mode allows a supervisor to monitor a trainee during a call.

1. During a trainee's call the supervisor may lift the handset (the HANDSFREE / HEADSET indicator will turn off and the telephone will automatically go into the handset mode).
2. Quickly press the HANDSFREE / HEADSET key (and the indicator will illuminate) to return the telephone back to the headset mode.
3. The trainee may continue the conversation with the supervisor only listening to the call via the handset.

Supervisor Mode

This mode allows a supervisor to "take over" a call between a trainee and another party.

1. During a call, the supervisor may lift the handset and use it to continue a normal conversation with the other party, while the trainee listens to its progress through the headset
2. To return the call to the trainee, simply press the HANDSFREE / HEADSET key and if appropriate replace the handset in the cradle.

SILENT RINGING FEATURE

Designed for Call Centers or any application where call-related noise is to be kept to a minimum, this feature allows incoming calls to ring quietly in the headset receiver (speaker); the headset user can hear the incoming call, but the telephone does not ring and add to the room noise.

To use the telephone in Silent Ringing mode:

1. Set the RINGER VOLUME SWITCH to the OFF position (signified by the square symbol without a bell symbol inside it)
2. Put your headset on and wait for the next incoming call
3. When a call arrives, the MULTIFUNCTIONAL INDICATOR will flash and the operator will hear the ringing tone at a low level in the headset
4. Press the HANDSFREE / HEADSET key to answer the call.

VOLUME CONTROL

To adjust the sound volume in the headset earpiece, press the up or down volume buttons located in the middle of the memory card.

5. ADVANCED NETWORK OPERATION

Where this telephone is used on an intelligent network such as a PABX or other networks such as Telecom Smartphone services, Centrex or TelstraClear Gateway the following information may be useful.

PAUSE FUNCTION WHEN DIALLING

Depending on your telephone system, this may or may not be required. If in doubt, check with your system supplier or Interquartz dealer, as failure to observe your system's requirements may lead to difficulty in making outgoing external calls. If you have determined that a pause is required by your host system, please refer to the PAUSE Function section to ensure correct usage of the PAUSE button.

HOLDING AND TRANSFERRING CALLS

The methods used for these functions are dependent on your system type, so you will need to check your system's Extension User Guide. The RECALL KEY is typically used to initiate holding and/or transferring calls.

USING THE MEMORIES

You can store many different numbers and/or codes in the memories. For example it might be useful to store some of your favourite network facility commands in the telephone for fast and convenient access to those facilities (e.g. call diversion, call forward, call back etc). Consult your system's Extension User Guide for the codes to these facilities.

6. MEMORY FEATURE OPERATION

Located at the top of the keypad, the ONE-TOUCH MEMORY keys provide easy dialling of often-used numbers and/or network facility commands. Each memory can store up to 32 digits including digits 0 to 9, the *, # , Pause and Recall commands. While in the memory storing process the dial tone may change to disconnect tone before completing the storing procedure. You can ignore this disconnect tone and continue to complete the storing procedure.

STORING A NUMBER:

1. Lift HANDSET or press HANDSFREE / HEADSET KEY
2. Press STORE
3. Enter the telephone number or the network facility command code
4. Press STORE
5. Press desired memory key
6. Replace HANDSET or press HANDSFREE / HEADSET KEY

DIALLING A NUMBER:

1. Lift HANDSET or press HANDSFREE / HEADSET KEY
2. Press desired memory key.

CASCADE DIALLING

The contents of any memory can be "cascaded" or added together with additional manual dialling or other memories. In cascade dialling, make sure that each dialling sequence has completed before activating the next.

MEMORY STORAGE TIME

All memories are retained permanently without batteries (non-volatile memories). To remove or over-write current memory contents simply store new data onto that memory key.

7. INSTALLATION

UNPACKING

The carton contains the following:

- The telephone base unit and the handset
- A coiled handset cord and a line cord
- This User Guide

GENERAL SETTING-UP

1. Fit the COILED HANDSET CORD to the appropriate sockets in the HANDSET and to the side of the telephone base. Then place the handset in the handset cradle
2. Fit the LINE CORD to the socket of the telephone base marked LINE and the other end to your telephone network outlet

3. Set the Ringer Volume (OFF / Low / Hi)
4. See following sections to complete the installation

LOCATION

The telephone should be placed on a desk, table or shelf where it is not likely to be pushed off. If the unit is to be wall mounted, it should be attached securely on the WALL MOUNTING BRACKET. Avoid excessive heat, damp, dust, direct sunlight, vibration, and other appliances or devices that may transmit or emit electrical or electromagnetic radio frequency noise or signals (e.g. computers, welders, and pagers).

WALL MOUNTING

1. To enable the HANDSET to be supported in the cradle, follow the procedure shown in Figure 2 to reverse the HANDSET RETAINER in the cradle.
2. Fit the WALL MOUNT BRACKET (optional, not supplied) to the wall and attach the WALL MOUNT BRACKET to the underside of telephone (see Figures 2 and 3)
3. NOTE: The WALL MOUNT BRACKET illustrated in Figure 2 is available from your authorised Interquartz dealer. The MODULAR WALL JACK illustrated is not applicable to New Zealand.

HEADSET

Connect the headset to the headset socket of the telephone base marked HEADSET, and set the HEADSET POLARITY SWITCH and HEADSET MIC ADJUST CONTROL described later in this section.

LINE CONNECTION

This telephone is normally supplied with an RJ45-Plug terminated line cord as the wall plug, with the center pair being reserved for speech and signaling. Other types of plugs and cords are available on request.

1. Use your thumb to press the HANDSET RETAINER

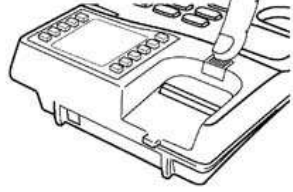

2. Push the HANDSET RETAINER out of the slot.

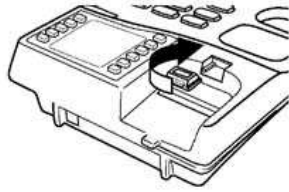
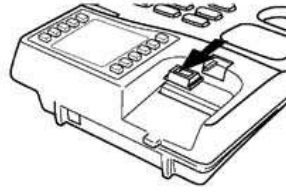

3. Rotate the HANDSET RETAINER by 180°

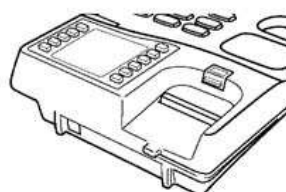

4. Insert the HANDSET RETAINER back into its slot.

FIGURE 2: WALL MOUNTING
(Repositioning the cradle handset retainer)

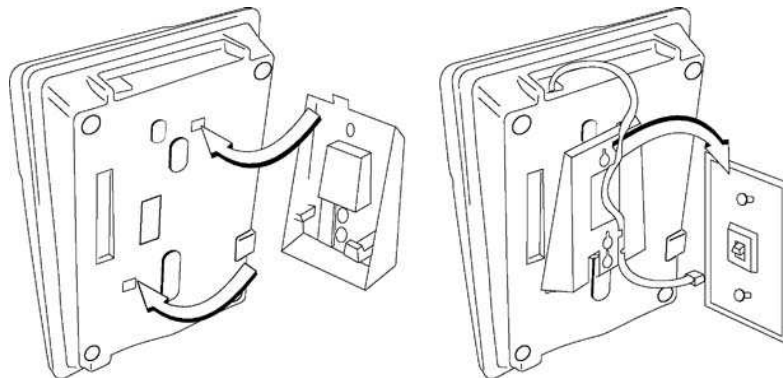
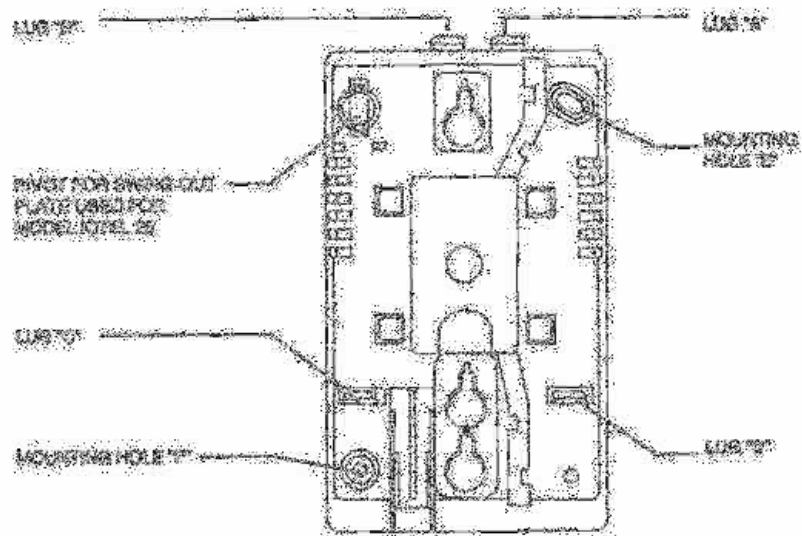

FIGURE 2: WALL MOUNTING
(Attaching the telephone to the wall mount bracket)

WALL-MOUNT BRACKET (OPTIONAL, NOT INCLUDED WITH PHONE)



Please Note:
 1. This wall bracket may be installed onto the wall by using mounting holes 1, 2, and 3.
 2. Lug 16 break-off before using mounting the phone.

TELEPHONE MODELS		BREAK-OFF LUGS
10195 10196 10197 10198 10199 10200 10201 10202 10203 10204 10205 10206 10207 10208 10209 10210 10211 10212 10213 10214 10215 10216 10217 10218 10219 10220 10221 10222 10223 10224 10225 10226 10227 10228 10229 10230 10231 10232 10233 10234 10235 10236 10237 10238 10239 10240 10241 10242 10243 10244 10245 10246 10247 10248 10249 10250 10251 10252 10253 10254 10255 10256 10257 10258 10259 10260 10261 10262 10263 10264 10265 10266 10267 10268 10269 10270 10271 10272 10273 10274 10275 10276 10277 10278 10279 10280 10281 10282 10283 10284 10285 10286 10287 10288 10289 10290 10291 10292 10293 10294 10295 10296 10297 10298 10299 10300	10195 10196 10197 10198 10199 10200 10201 10202 10203 10204 10205 10206 10207 10208 10209 10210 10211 10212 10213 10214 10215 10216 10217 10218 10219 10220 10221 10222 10223 10224 10225 10226 10227 10228 10229 10230 10231 10232 10233 10234 10235 10236 10237 10238 10239 10240 10241 10242 10243 10244 10245 10246 10247 10248 10249 10250 10251 10252 10253 10254 10255 10256 10257 10258 10259 10260 10261 10262 10263 10264 10265 10266 10267 10268 10269 10270 10271 10272 10273 10274 10275 10276 10277 10278 10279 10280 10281 10282 10283 10284 10285 10286 10287 10288 10289 10290 10291 10292 10293 10294 10295 10296 10297 10298 10299 10300	1, 2, 3, 4, 5, 6, 7, 8, 9, 10, 11, 12, 13, 14, 15, 16, 17, 18, 19, 20, 21, 22, 23, 24, 25, 26, 27, 28, 29, 30, 31, 32, 33, 34, 35, 36, 37, 38, 39, 40, 41, 42, 43, 44, 45, 46, 47, 48, 49, 50, 51, 52, 53, 54, 55, 56, 57, 58, 59, 60, 61, 62, 63, 64, 65, 66, 67, 68, 69, 70, 71, 72, 73, 74, 75, 76, 77, 78, 79, 80, 81, 82, 83, 84, 85, 86, 87, 88, 89, 90, 91, 92, 93, 94, 95, 96, 97, 98, 99, 100
10295-10300		1, 2, 3, 4, 5, 6, 7, 8, 9, 10, 11, 12, 13, 14, 15, 16, 17, 18, 19, 20, 21, 22, 23, 24, 25, 26, 27, 28, 29, 30, 31, 32, 33, 34, 35, 36, 37, 38, 39, 40, 41, 42, 43, 44, 45, 46, 47, 48, 49, 50, 51, 52, 53, 54, 55, 56, 57, 58, 59, 60, 61, 62, 63, 64, 65, 66, 67, 68, 69, 70, 71, 72, 73, 74, 75, 76, 77, 78, 79, 80, 81, 82, 83, 84, 85, 86, 87, 88, 89, 90, 91, 92, 93, 94, 95, 96, 97, 98, 99, 100
10301-10310		1, 2, 3, 4, 5, 6, 7, 8, 9, 10, 11, 12, 13, 14, 15, 16, 17, 18, 19, 20, 21, 22, 23, 24, 25, 26, 27, 28, 29, 30, 31, 32, 33, 34, 35, 36, 37, 38, 39, 40, 41, 42, 43, 44, 45, 46, 47, 48, 49, 50, 51, 52, 53, 54, 55, 56, 57, 58, 59, 60, 61, 62, 63, 64, 65, 66, 67, 68, 69, 70, 71, 72, 73, 74, 75, 76, 77, 78, 79, 80, 81, 82, 83, 84, 85, 86, 87, 88, 89, 90, 91, 92, 93, 94, 95, 96, 97, 98, 99, 100

Figure 3

TECHNICAL ADJUSTMENTS - FOR CORRECT OPERATION

MESSAGE WAITING LIGHT COMPATIBILITY

Located in the Multifunctional Indicator Light, the Message Waiting Light can be optionally configured at time of order to be compatible with most host telephone systems. The standard factory fitted Message Waiting Light is a neon style circuit suitable for minimum 80V DC signaling and is compatible with NEC, FUJITSU, ALCATEL and NORTEL PABX systems. The Message Waiting Light switch is located on the telephone's underside for enabling or disabling the light, and is factory set in the "ON" position. Please note that when this telephone is configured to the "Message Waiting" mode it is only for use with PABX systems (contact your vendor for clarification). For direct line use, please disable the Message Waiting Light feature by setting the switch to the "OFF" position. This Message Waiting Light is not compatible to the NZ Telecom voicemail system.

HEADSET MIC ADJUST CONTROL

By adjusting this control the telephone can match the sensitivity of the headset's microphone thus allowing many different types of headsets on the New Zealand market to function correctly with the telephone. The control is a white knob with a slot in the center. It is located on the underside of the telephone (do not mistake this knob as a hold down screw). This knob has a maximum 270 degrees rotation between extremes. In order to avoid damaging this control please do not rotate the knob beyond the rotational extremes (the limits). You can use a small screwdriver or similar implement that will fit into the slot to gently rotate it and make the adjustment. Rotate clockwise for higher sensitivity and anti-clockwise for lower sensitivity. Please see Table 1 as a guide to the appropriate settings for most popular headsets. Please follow these simple steps to make a headset mic adjustment:

1. Put the headset on and lift the HANDSET to your other ear and make an out-going call
2. While speaking to the other party swap between HANDSET and HEADSET mode a few times by pressing the HANDSFREE / HEADSET key (the HANDSFREE / HEADSET key indicator will illuminate to signify HEADSET mode is in use)

3. With the called party's help decide if your voice level is the same when using the HANDSET and HEADSET.

If you sound too loud on the headset, adjust the microphone sensitivity (turn anti-clockwise) so that your voice level when using the HEADSET matches that of the HANDSET.

HEADSET POLARITY SWITCH

Located on the underside of the telephone, this switch provides compatibility with the two commonly used headset-wiring modes. Position "V" suits Plantronics Vista Cords and other Headsets wired in the same configuration (also known as "reversed" wiring mode).

Position "P" suits Plantronics P cords and other Headsets wired in the same configuration (also known as "normal" wiring mode).

Please see Table 1 as a guide to the appropriate settings for most popular headsets.

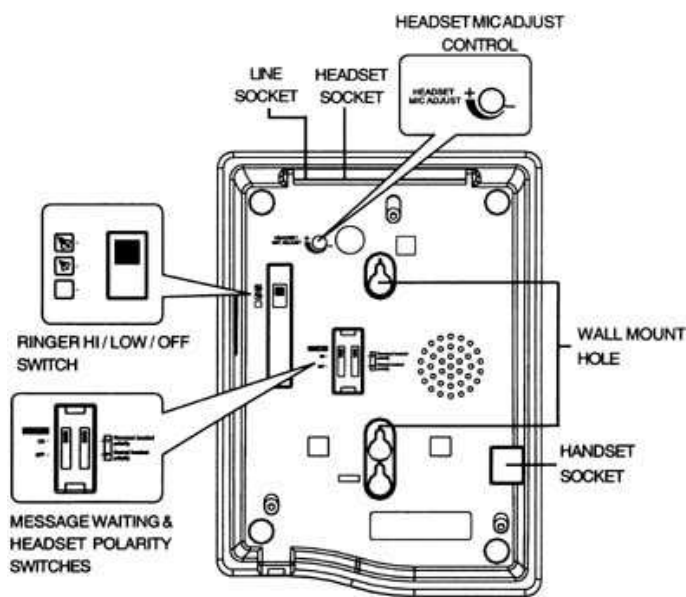





















FIGURE 4

Headset Model	Headset Mic Adjustment Control	Headset Polarity Switch
ACS Orator	 50%	P
ACS stratos	 50%	P
Addcom Elite	 100%	P
Addcom Contour	 100%	P
BTC GHA-M201	 100%	P
BTC GHA M201N	 100%	P
Claria	 100%	P
Claria Alert	 100%	P
Crest II	 100%	P
GN Netcom Profile III Flex	 75%	P
GN Netcom Optima	 100%	P
GN Netcom Advantage	 100%	P
GN Netcom Shades	 100%	P
Plantronics H series with V cord	 100%	V
Plantronics P series with P cord	 100%	P
THW LS1-A	 100%	P
THW Crown	 100%	P
Unex Flexpro F100 NTN	 100%	P
Unex Flexpro F200 NTN	 100%	P
Please Note: Information above applies to headsets with cord, supplied for use without an amplifier.		

Explanation of Headset Mic Adjustment control settings in table:





-  100% = Fully Clockwise (loudest mic setting).
-  100% = Fully Anti-Clockwise (softest mic setting).
-  50% = Halfway (mid mic level)
-  75% = Three quarters Clockwise (loud mic level)

TABLE 1

8. GENERAL CARE AND MAINTENANCE

This telephone is a precision electronic instrument. While in use and storage, care should be taken to avoid rough handling, extreme temperature and damp or dirty environments.

CLEANING

NEVER use aerosol sprays or other chemical agents or substances that leaves a residue (never use furniture polish for example).

Use a mild detergent and a damp clean cloth when cleaning. Do not allow moisture to enter the telephone's interior - damage may result!

FAILURE TO OPERATE AND SERVICE DIFFICULTIES

If telephone service problems occur at any time, it is recommended that you first re-check the installation procedure described in this user guide.

If the telephone still fails to operate correctly, try to determine if the fault is with the telephone, or with the network or system to which the telephone is connected:

Disconnect the "suspect" telephone, and test the line with a substitute (known to be good) telephone. If the telephone service then operates satisfactorily, the fault is most likely in the "suspect" telephone.

Test the "suspect" telephone on a known good line. If the fault still occurs, the fault is in the "suspect" telephone.

Consult your Interquartz dealer for further advice if necessary.

9. THUNDERSTORMS



The telephone, in common with household electrical appliances, can be a source of electric and acoustic shock during thunderstorms. The possibility of a telephone user experiencing a shock is minimal. Nevertheless, customers should be aware of some simple precautions to follow during thunderstorms:

Use your telephone only for calls of the utmost urgency. Keep these calls brief.

Whilst using your telephone keep clear of electrical appliances and metal fixtures such as: stoves, air conditioners, refrigerators, window frames and sinks.

10. WARRANTY - 3 YEARS

Interquartz (NZ) Limited warrants the original purchaser against failure (under normal usage and in the environment and network for which it was designed) resulting from defective material and workmanship at time of manufacture for a period of THREE YEARS from the date of purchase. Proof of purchase together with date of purchase is required for determining validity of this warranty. This warranty does not cover defects or damage due to normal wear and tear, negligence, accidents, exposure to radiation, misuse, obsolescence, incompatibility, improper maintenance, lightning strikes or unauthorised repairs or modifications and excludes freight or postage costs to/from your local authorised service center unless otherwise arranged. Consequential loss is not included. Notification of any defect must be made within the warranty period before a warranty repair can be effected.

Free Manuals Download Website

<http://myh66.com>

<http://usermanuals.us>

<http://www.somanuals.com>

<http://www.4manuals.cc>

<http://www.manual-lib.com>

<http://www.404manual.com>

<http://www.luxmanual.com>

<http://aubethermostatmanual.com>

Golf course search by state

<http://golfingnear.com>

Email search by domain

<http://emailbydomain.com>

Auto manuals search

<http://auto.somanuals.com>

TV manuals search

<http://tv.somanuals.com>