

IMPORTANT SAFETY RULES

Read, Understand, and Follow all Instructions Carefully before Installing and using this Product.

Krystal Clear™ Model 634 Filter Pump

220 - 240 V~, 50 Hz, 360 W
Hmax 1.5 m, H min 0.19 m, IPX4
Max. Water Temperature 35 °C



For illustrative purposes only.

Don't forget to try these other fine Intex products: Pools, Pool Accessories, Inflatable Pools and In-Home Toys, Airbeds and Boats available at fine retailers or visit our website.



©2006 Intex Marketing Ltd. - Intex Development Co. Ltd. - Intex Recreation Corp. All rights reserved/Tous droits réservés/Todos los derechos reservados/Alle Rechte vorbehalten.

Printed in China/Imprimé en Chine/Impreso en China/Gedruckt in China.

©™ Trademarks used in some countries of the world under license from/©™ Marques utilisées dans certains pays sous licence de/Marcas registradas utilizadas en algunos países del mundo bajo licencia de/Warenzeichen verwendet in einigen Ländern der Welt in Lizenz von/Intex Marketing Ltd. to/à/a/an Intex Development Co. Ltd., 8th Floor, Dah Sing Financial Centre, 108 Gloucester Road, Wanchai, Hong Kong & Intex Recreation Corp., P.O. Box 1440, Long Beach, CA 90801 • Distributed in the European Union by/Distribué dans l'Union Européenne par/Distribuido en la unión Europea por/Vertrieb in der Europäischen Union durch/Intex Trading B.V., P.O. Box nr. 1075 - 4700 BB Roosendaal - The Netherlands

110**-A0-0701

TABLE OF CONTENTS

Warnings..... 3

Parts List & Reference..... 4-6

Set Up Instructions..... 7-8

Operating Instructions..... 9-10

Filter Pump Stationary Mounting Option..... 10

Pool Care and Chemicals..... 11

Long Term Storage..... 12

Troubleshooting Guide..... 13

Common Pool Problems..... 14

General Aquatic Safety..... 15

Limited Warranty..... 16

Intex Service Center Locations..... 17

IMPORTANT SAFETY RULES

Read, Understand and Follow All Instructions Carefully Before Installing and Using this Product.

READ AND FOLLOW ALL INSTRUCTIONS**⚠ WARNING**







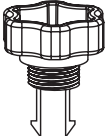

- To reduce the risk of injury, do not permit children to use this product. Always supervise children and those with disabilities.
- Risk of electric shock. Connect this product only to a grounding type receptacle protected by a ground-fault circuit interrupter (GFCI) or residual current device (RCD). Contact a qualified electrician if you cannot verify that the receptacle is protected by a GFCI/RCD. Use a qualified electrician to install the GFCI/RCD, which has a maximum rate of 30mA. Do not use a portable residual current device (PRCD).
- Do not bury electrical cord. Locate cord where it will not be damaged by lawn mowers, hedge trimmers, and other equipment.
- If the supply cord is damaged, it must be replaced by the manufacturer, its service agent or similarly qualified persons in order to avoid a hazard.
- To reduce the risk of electric shock, do not use extension cords, timers, plug adaptors or converter plugs to connect unit to electric supply; provide a properly located outlet.
- Assembly and disassembly by adults only.
- Do not attempt to plug in or unplug this product while standing in water or when your hands are wet.
- Position this product away from pool to prevent a child from climbing on pump to access the pool.
- Children must stay away from this product and electrical cord(s).
- Do not operate this product when pool is occupied.
- Always unplug this product from the electrical outlet before removing, cleaning, servicing or making any adjustment to the product.
- This product is for use with storable pools only. Do not use with permanently installed pools. A storable pool is constructed so that it may be readily disassembled for storage and reassembled to its original configuration.
- Keep this product more than 2m away from the pool.
- Keep this product more than 3.5m away from the pool (for France only).
- Keep the plug of this product more than 3.5m away from the pool.
- The plug shall be accessible after product installed.
- This product is intended to be used only for the purposes described in the manual!

FAILURE TO FOLLOW THESE WARNINGS MAY RESULT IN PROPERTY DAMAGE, ELECTRIC SHOCK, ENTANGLEMENT OR OTHER SERIOUS INJURY OR DEATH.

These product warnings, instructions and safety rules provided with the product represent some common risks of water recreation devices and do not cover all instances of risk and danger. Please use common sense and good judgement when enjoying any water activity.

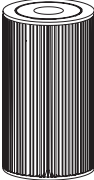
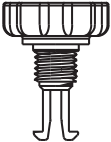
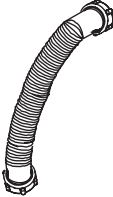
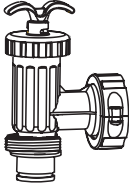
PARTS LIST

PARTS LIST

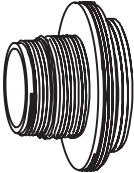
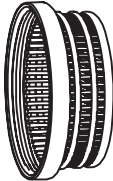
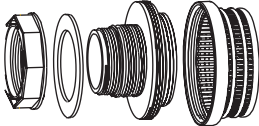
| | | |
|---|---|---|
| 1  | 2  | 3  |
| 4  | 5  | 6  |
| 7  | 8  | 9  |
| 10  | 11  | 12  |
| 13  | 14  | 15  |
| 16  | | |

NOTE: Drawings for illustration purpose only. May not reflect actual product. Not to scale.

SAVE THESE INSTRUCTIONS

PARTS REFERENCE

Before assembling your product, please take a few minutes to check the contents and become familiar with all the parts.

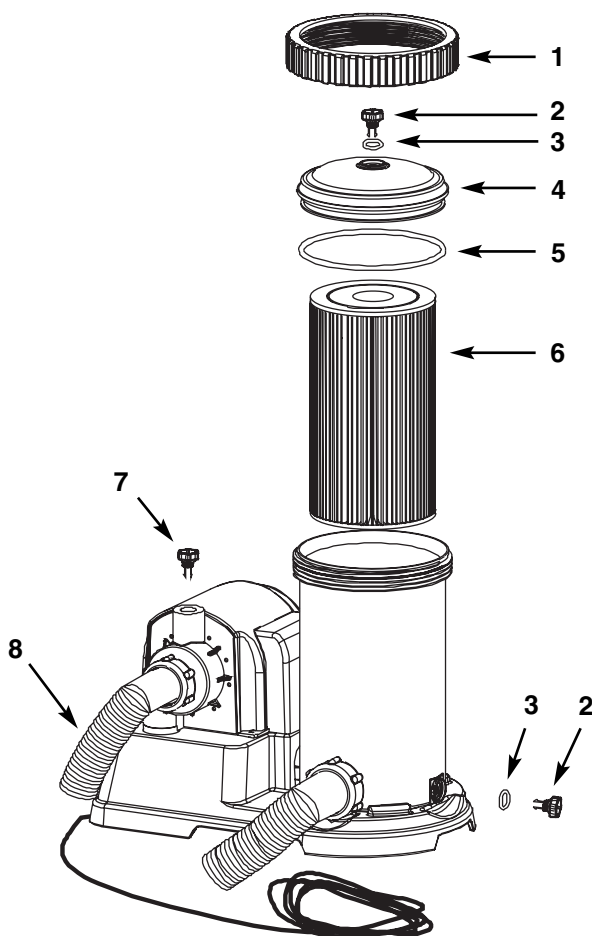

NOTE: Drawings for illustration purpose only. May not reflect actual product. Not to scale.

| REF. NO. | DESCRIPTION | QTY. | SPARE PART NO. |
|----------|--|------|----------------|
| 1 | THREADED FILTER HOUSING COLLAR | 1 | 10491 |
| 2 | AIR RELEASE VALVE/SEDIMENT RELEASE VALVE | 2 | 10460 |
| 3 | VALVE O-RING | 2 | 10264 |
| 4 | FILTER HOUSING COVER | 1 | 10490 |
| 5 | FILTER HOUSING O-RING | 1 | 10492 |
| 6 | FILTER CARTRIDGE (59905) | 1 | |
| 7 | AIR RELEASE VALVE B (WITH O-RING) | 1 | 10725 |
| 8 | PUMP HOSE WITH NUTS | 2 | 10494 |

When ordering parts, be sure to quote the model number and part numbers.

PARTS REFERENCE (continued)

Before assembling your product, please take a few minutes to check the contents and become familiar with all the parts.

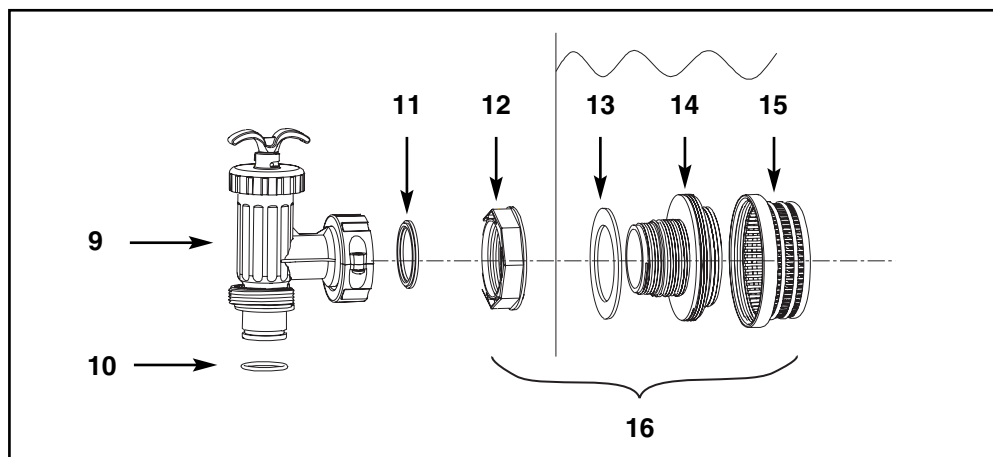

NOTE: Drawings for illustration purpose only. May not reflect actual product. Not to scale.

| REF. NO. | DESCRIPTION | QTY. | SPARE PART NO. |
|----------|--|------|----------------|
| 9 | PLUNGER VALVE (HOSE O-RING & STEP WASHER INCLUDED) | 2 | 10747 |
| 10 | HOSE O-RING | | 10262 |
| 11 | STEP WASHER | | 10745 |
| 12 | STRAINER NUT | | 10256 |
| 13 | FLAT STRAINER RUBBER WASHER | | 10255 |
| 14 | THREADED STRAINER CONNECTOR | | 10744 |
| 15 | STRAINER GRID | | 10253 |
| 16 | LARGE STRAINER (COMBINATION OF STRAINER NUT, FLAT STRAINER RUBBER WASHER, THREADED STRAINER CONNECTOR & STRAINER GRID) | 2 | 10746 |

STRAINER & PLUNGER VALVE SET-UP

The Krystal Clear™ filter pump assembly includes two strainer-control mechanisms that are to be installed in the pool liner's two pre-cut holes. The strainer grid prevents large objects from jamming and/or damaging the filter pump and the plunger valve assembly prevents water from flowing into the filter pump while the filter cartridge is being placed or cleaned. For Easy Set™ Pools, install the strainer and plunger valve before inflating the pool liner top ring.

1. Grasp the strainer and plunger valve mechanism.
2. In a counter-clockwise motion unscrew plunger valve union from the threaded strainer connector (14). Be careful not to lose the step rubber washer (11). Place the plunger valve on the ground in a safe place (see drawing 1).
3. In a counter-clockwise motion unscrew the strainer nut (12) from the threaded connector (14). Leave the flat washer (13) on the connector (14).
4. From the inside of the pool liner insert the connector (14) into one of the pre-cut holes with the washer remaining on the connector to be placed against the inside of the liner wall.
5. With the flat side of the strainer nut (12) facing the outside wall of the liner in a clockwise motion screw the strainer nut (12) back onto the threaded connector (14) (see drawing 2). Before assembly, lubricate the threads with a petroleum jelly.
6. Finger tighten the strainer grid (15) and the strainer nut (12) onto the threaded connector (14).
7. Grasp the plunger valve assembly. Make sure the step washer (11) is in place.
8. In a clockwise motion screw the plunger valve union back onto the threaded connector (14) (see drawing 3).
9. Examine the plunger valve to see if the handle is pushed fully down to the "0/1" position. If not, then grasp the handle at the top and push down turning the handle in a clockwise direction until the plastic protruding notch anchors in the "0/1" position. This will prevent water from flowing out during filling (see drawings 4.1 & 4.2).
10. Repeat steps 1 through 9 for the 2nd liner pre-cut hole.
11. The pool liner is now ready to fill with water. Consult the above-ground-pool owner's manual for filling instructions.

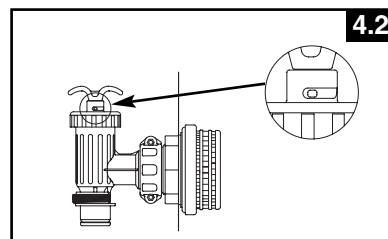
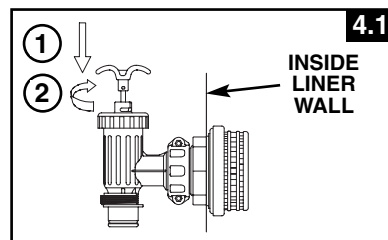
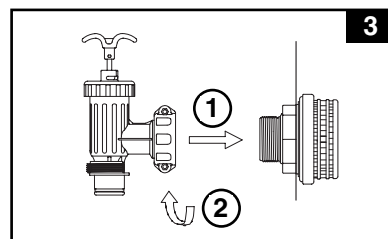
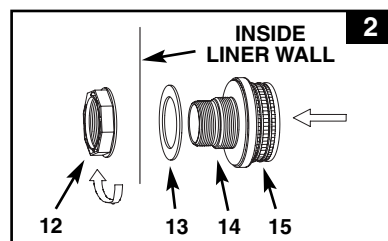
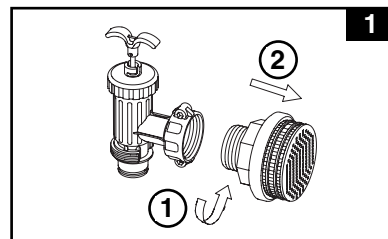

FILTER PUMP HOSE CONNECTION SET UP

1. Remove the Krystal Clear™ filter pump and hoses from the packaging.
2. Place the filter pump in a location for hose (8) connections to the plunger valve assemblies.
Note: Some regional regulations may require the filter pump to be mounted on a stationary platform. There are two mounting holes located in the pump base for this reason. Consult your local authorities for filter-pump mounting requirements.
3. Grasp the two pump hoses (8) and connect the hose nuts to the filter pump.
4. In a counter-clockwise motion unscrew the threaded filter housing collar (1) from the filter housing. Place it in a safe place.
5. The Filter Pump is an airtight system. In a counter-clockwise motion turn both air release valves (2 & 7) 1 - 2 turns to open. **DO NOT remove air release valves as water will expel with force if the motor is turned on and injury may occur.**
6. Grasp and remove the filter housing cover (4). Check to see if a cartridge is inside the housing. If yes, replace the cover, finger tighten the housing collar (1) back onto the filter housing.
7. Gently finger tighten the sediment release valve located at the bottom of the housing to be sure that water does not leak out.
8. When the pool is filled connect the hose from the bottom of the filter housing to the highest strainer assembly. The hose connection is made at the bottom of the plunger valve assembly. Use the hose nut to attach the hose.
9. Connect the 2nd hose to the middle of the motor housing and to the remaining liner connection.

⚠ WARNING

Position this product away from pool to prevent a child from climbing the pool.

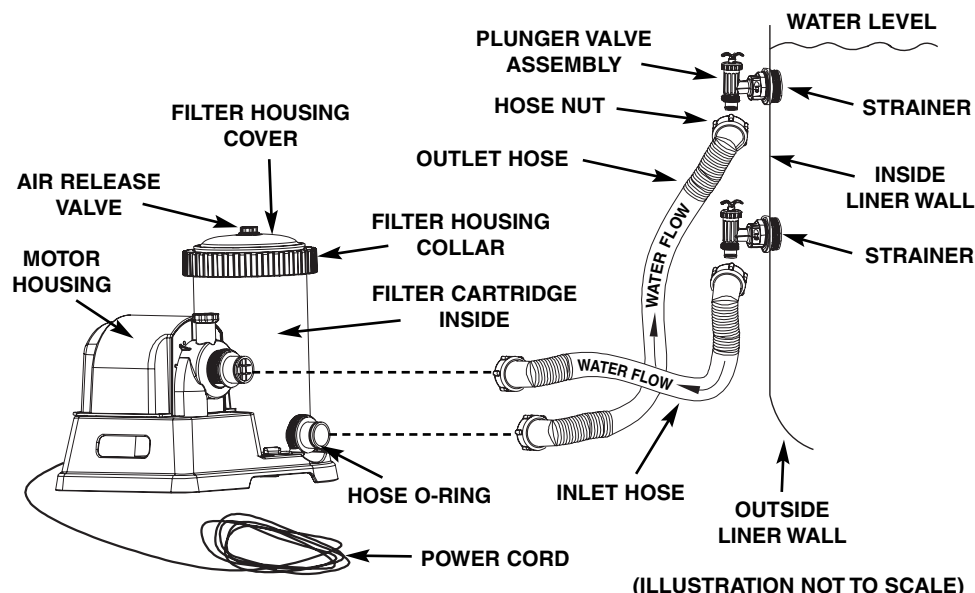

OPERATING INSTRUCTIONS

1. Make sure the filter pump switch is "OFF". The switch is located on the motor housing.
2. Connect the power cord to a GFCI protected electrical outlet.

WARNING

Risk of electric shock. Connect this product only to a grounding type receptacle protected by a ground-fault circuit interrupter (GFCI) or residual current device (RCD). Contact a qualified electrician if you cannot verify that the receptacle is protected by a GFCI/RCD. Use a qualified electrician to install the GFCI/RCD, which has a maximum rate of 30mA. Do not use a portable residual current device (PRCD).

IMPORTANT

To prevent air lock, open the lower plunger valve (connected inlet hose) first and then the upper plunger valve (connected outlet hose). Open air release valves, wait until water starts to flow out of the air release valves, close air release valves.

3. Grasp a plunger valve handle. Turn the handle counter-clockwise, pull up until it stops, and then turn it clockwise until the metal protruding notch anchors in the "0/1" position. Repeat for the 2nd plunger valve. This opens the valves to allow water to flow into the filter pump.
4. With water flowing into filter pump, the water pressure will allow the air trapped inside to escape from the air release valves **(2 & 7)**. When all the air has escaped water will flow out of the valves **(2 & 7)**. When this occurs gently finger tighten the valves **(2 & 7)** in a clockwise direction.
5. Turn the switch "ON". The filter pump is now filtering the water.
6. Operate the filter pump until the desired water clarity is obtained.

FILTER CARTRIDGE CLEANING OR REPLACEMENT

It is recommended that the filter cartridge be replaced at least every 2 weeks.

1. Make sure the filter pump is turned off, and disconnect the power cord from the electrical outlet.
2. Grasp a plunger valve handle. Turn the handle counter-clockwise, push down until it stops and then turn it clockwise until the plastic protruding notch anchors in the "0/1" position. Repeat for the 2nd plunger valve. This prevents the water from flowing out of the pool.
3. Gently turn the top air release valve 1-2 turns in a counter-clockwise direction. This will allow the housing cover to be easily removed.
4. In a counter-clockwise direction remove the filter housing collar **(1)**. Place it in a safe location.
5. Remove the housing cover **(4)**.

FILTER CARTRIDGE CLEANING OR REPLACEMENT (continued)

6. Remove the "OLD" filter cartridge.
7. Examine the inside of the filter housing.
8. If dirt or sediment is located on the bottom of the housing then:
 - A. In a counter-clockwise motion gently unscrew and remove the sediment valve (2) located at the bottom of the housing. Place it in a safe place.
 - B. With a bucket of water or a garden hose pour water into the housing flushing out the sediment.
 - C. In a gentle clockwise motion return the sediment valve (2) to its location. Do not over-tighten.
9. Place a new cartridge filter in the housing.
10. Return the housing cover (4) to its position and in a clockwise direction rescrew the housing collar (1) onto the filter housing.
11. Turn both plunger valve handles in a counter-clockwise direction, pull up until they stop, and then turn them clockwise until the metal protruding notch anchors in the "0/1" position.
12. When the trapped air has escaped through the air release valve gently retighten the valve (2) in a clockwise direction.
13. Reconnect the power cord.
14. Turn the pump "ON".

FILTER PUMP STATIONARY MOUNTING OPTION

Some countries, especially in the European community, require the filter-pump to be secured to the ground or to a base in a permanent upright position. Check your local authorities to determine if there is a regulation in your area regarding above-the-ground swimming pool filter-pumps. If yes, then the filter-pump can be mounted to a platform using the two holes located in the base. See drawing below.

The filter-pump can be mounted on a cement base or onto a wooden platform to prevent accidental falling over. Total assembly must exceed 18kg. The European norm EN 60335-2-41 requires this product be secured to the ground or to a base.

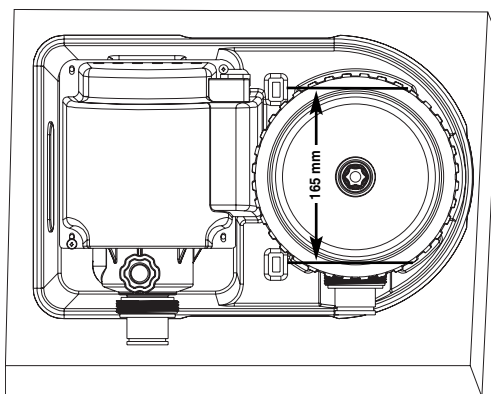

1. The mounting holes are 6.4 mm in diameter and spaced 165 mm apart.
2. Use two bolts and lock nuts with a maximum of 6.4 mm in diameter.

POOL CARE AND CHEMICALS

- All pools require care to keep the water clear and hygienically clean. With proper chemical control, your filter will help attain this objective. Consult your pool supply dealer for instructions regarding the proper use of chlorine, algaecide and other chemical agents required for sparkling clear water.
- Keep pool chemicals away from children.
- Do not replenish chemicals in pool while pool is occupied. Skin or eye irritations could occur.
- Daily pH checking and chemical treatment of the water is very important and can not be overemphasized. Chlorine, algaecide and maintenance of proper pH levels are required when filling the pool as well as during the season. Consult your local swimming pool supply store for instructions.
- The season's first filling of the pool may have brackish water requiring extra water additives and extra filter changes. Do not allow swimming in pool until the pH level is balanced. Consult your local swimming pool supply store for instructions.
- Keep spare filter cartridges on hand. Replace cartridges every two weeks.
- Chlorinated water may damage lawns, gardens or shrubbery as children play in the pool and splash water outside the pool. Lawn areas underneath the pool liner will be destroyed. Note that some types of grass may grow through the liner but function is not affected.
- Filter run time depends on pool size, weather and usage level. Experiment with various run times so as to produce clean clear water.

CAUTION

Concentrated chlorine solutions may damage the pool liner. Always follow the chemical manufacturer's directions, and the health and hazard warnings.

LONG TERM STORAGE

1. Before emptying your pool for long term storage, or relocation, be sure the water is directed towards an acceptable drain water receptacle away from the house. Check local regulations for specific directions regarding disposal of swimming pool water.
2. Disconnect power cord from electrical outlet.
3. After pool is empty of all water disconnect all hoses from pump and plunger valves and remove strainers from pool wall.
4. Drain all water from inside filter pump.
5. Leave filter pump pieces & hoses outside to thoroughly air dry.
6. Twist the plunger collar counter-clockwise removing the water flow control mechanism from the plunger housing.
7. Coat the following O-rings and washers with petroleum jelly for long term storage:
 - Air release valve & sediment O-rings **(3)**.
 - Filter housing cover O-ring **(5)**.
 - Pump hose O-rings **(10)**.
 - Strainer valve assembly step washers **(11)**.
 - Flat strainer rubber washers **(13)**.
8. Discard "OLD" used filter cartridge. Have 1-2 new cartridges available for next season's use.
9. Place all dry pieces in the original packaging for storage or place in an airtight plastic bag.
10. Store the filter pump and accessories in a dry, cool storage location.

TROUBLESHOOTING GUIDE

| TROUBLE | CHECK | POSSIBLE SOLUTIONS |
|--|---|---|
| FILTER MOTOR FAILS TO START | <ul style="list-style-type: none"> • Not plugged in. • Fuse box needs checking. • GFCI/RCD circuit breaker tripped. | <ul style="list-style-type: none"> • Filter cord must be plugged into a 3 wire outlet that is protected by a Class A Ground Fault Circuit Interrupter, or RCD. • Reset circuit breaker. If circuit breaker trips repeatedly, your electrical system may have a defect. Turn off circuit breaker and call an electrician to correct the problem. • Motor too hot and overload protection shut motor off. Let motor cool down. |
| FILTER DOESN'T CLEAN POOL | <ul style="list-style-type: none"> • Improper chlorine or pH levels. • Filter cartridge dirty. • Cartridge damaged. • Excessively dirty pool. • Strainer screen restricting flow. | <ul style="list-style-type: none"> • Adjust chlorine and pH level. Consult your local swimming pool supply stores. • Clean or replace cartridge. • Check for holes in cartridge. Replace if damaged. • Operate filter for longer periods. • Clean strainer screen at pool wall inlet. |
| FILTER DOESN'T PUMP WATER OR FLOW IS VERY SLOW | <ul style="list-style-type: none"> • Inlet/discharge clogged. • Air leak on intake line. • Scale or buildup on cartridge. • Excessively dirty pool. • Filter cartridge dirty. | <ul style="list-style-type: none"> • Look for obstructions in intake hose or discharge hose inside pool wall. • Tighten hose nuts, check hoses for damage, check pool water level. • Replace cartridge. • Clean cartridge more often. • Clean inside plunger valve. • Pull valve handle to full upright position. |
| PUMP DOESN'T WORK | <ul style="list-style-type: none"> • Low water level. • Strainer screen plugged up. • Air leak on intake hose. • Faulty motor or impeller jammed. • Air lock inside cartridge chamber. | <ul style="list-style-type: none"> • Fill pool to correct water level. • Clean strainer screens at pool inlet. • Tighten hose nuts, check hose for damage. • Check & clear any sticks or leaves in intake to pump. • Turn & pull valve handle to full upright position. |
| TOP COVER LEAKING | <ul style="list-style-type: none"> • O-ring missing. • Cover not tight. • Filter cartridge dirty. | <ul style="list-style-type: none"> • Remove cover & check for O-ring. • Tighten cover (Manually). • Replace or clean cartridge. |
| HOSE LEAKING | <ul style="list-style-type: none"> • Hose nuts. | <ul style="list-style-type: none"> • Tighten/reinstall hose nut. |
| AIR LOCK | <ul style="list-style-type: none"> • Pump housing and inlet hose air trapped. • Inlet and outlet hoses connection reversed. | <ul style="list-style-type: none"> • Open air release valves, wait until water starts to flow out of the air release valves, close air release valves. • Lower position of pool outlet connect to filter pump water inlet, upper position of pool inlet connect to filter pump water outlet. |

IMPORTANT

If you continue to experience difficulty, please contact our Consumer Service Department for assistance. See back cover for contact information.

COMMON POOL PROBLEMS

| PROBLEM | DESCRIPTION | CAUSE | REMEDY |
|---------------------------|---|---|---|
| ALGAE | <ul style="list-style-type: none"> • Greenish water. • Green or black spots on pool liner. • Pool liner is slippery and/or has a bad odor. | <ul style="list-style-type: none"> • Chlorine and pH levels need adjustment. | <ul style="list-style-type: none"> • Super chlorinate with shock treatment. Correct pH to your pool store's recommended level. • Vacuum pool bottom. • Maintain proper chlorine level. |
| COLORED WATER | <ul style="list-style-type: none"> • Water turns blue, brown, or black when first treated with chlorine. | <ul style="list-style-type: none"> • Copper, iron or manganese in water being oxidized by the added chlorine. Common. | <ul style="list-style-type: none"> • Adjust pH to recommended level. • Run filter until water is clear. • Clean cartridge frequently. |
| SUSPENDED MATTER IN WATER | <ul style="list-style-type: none"> • Water is cloudy or milky. | <ul style="list-style-type: none"> • "Hard water" caused by pH level being too high. • Chlorine content is low. • Foreign matter in water. | <ul style="list-style-type: none"> • Correct pH. Check with pool dealer for water treatment. • Check for proper chlorine level. • Clean or replace your filter. |
| CHRONIC LOW WATER LEVEL | <ul style="list-style-type: none"> • Level is lower than on previous day. | <ul style="list-style-type: none"> • Rip or hole in pool liner or hoses. Tighten caps. | <ul style="list-style-type: none"> • Repair with patch kit. • Finger tighten all caps. |
| SEDIMENT ON POOL BOTTOM | <ul style="list-style-type: none"> • Dirt or sand on pool floor. | <ul style="list-style-type: none"> • Heavy use, getting in and out of pool. | <ul style="list-style-type: none"> • Use Intex pool vacuum to clean bottom of pool. |
| SURFACE DEBRIS | <ul style="list-style-type: none"> • Leaves, insects etc. | <ul style="list-style-type: none"> • Pool too close to trees. | <ul style="list-style-type: none"> • Use Intex pool skimmer. |

GENERAL AQUATIC SAFETY

Water recreation is both fun and therapeutic. However, it involves inherent risks of injury and death. To reduce your risk of injury, read and follow all product, package and package insert warnings and instructions. Remember, however, that product warnings, instructions and safety guidelines cover some common risks of water recreation, but do not cover all instances or risk and or danger.

For additional safeguards, also familiarize yourself with the following general guidelines as well as guidelines provided by nationally recognized Safety Organizations:

- Demand constant supervision.
- Learn to swim.
- Take the time to learn CPR and first aid.
- Instruct anyone who is watching your children about potential pool hazards and about the use of protective devices such as locked doors, barriers, etc.
- Teach children what to do in case of an emergency.
- Always use common sense and good judgement when enjoying any water activity.
- Supervise, Supervise, Supervise.

LIMITED WARRANTY

Your Krystal Clear™ Filter-Pump has been manufactured using the highest quality materials and workmanship. All Intex products have been inspected and found free of defects prior to leaving the factory. This Limited Warranty applies only to the Krystal Clear™ Filter-Pump.

The provisions of this Limited Warranty apply only to the original purchaser and is not transferable. This Limited Warranty is valid for a period of one (1) year from the date of the initial retail purchase. Keep your original sales receipt with this manual, as proof of purchase will be required and must accompany warranty claims or the Limited Warranty is invalid.

If a manufacturing defect is found within this one (1) year period, please contact the appropriate Intex Service Center listed in this manual. The Service Center will determine the validity of the claim.

IMPLIED WARRANTIES ARE LIMITED TO THE TERMS OF THIS WARRANTY AND IN NO EVENT SHALL INTEX, THEIR AUTHORIZED AGENTS OR EMPLOYEES BE LIABLE TO THE BUYER OR ANY OTHER PARTY FOR DIRECT OR CONSEQUENTIAL DAMAGES OR LIABILITIES.

This Limited Warranty does not apply if the Krystal Clear™ Filter-Pump is subject to negligence, abnormal use or operation, accident, improper operation, improper voltage or current contrary to operating instructions, or to damage by circumstances beyond Intex's control, including but not limited to, ordinary wear and tear and damage caused by exposure to fire, flood, freezing, rain, or other external environmental forces. This Limited Warranty applies only to those parts and components sold by Intex. The Limited Warranty does not cover unauthorized alterations, repairs or disassembly by anyone other than Intex Service Center personnel.

The costs associated with the loss of pool water, chemicals or water damage are not covered by this warranty. Injury or damage to any property or person is not covered by this warranty.

For service questions or to order replacement parts, please contact the appropriate office listed below or visit www.intexdevelopment.com for answers to most frequently asked questions.

| AREAS | LOCATION | AREAS | LOCATION |
|-------------------------|--|---|---|
| • ASIA | INTEX DEVELOPMENT CO. LTD. 8TH FLOOR, DAH SING FINANCIAL CENTRE, 108 GLOUCESTER ROAD, WANCHAI, HONG KONG TEL: 852-28270000 FAX: 852-23118200 E-mail: xmservicesupport@intexcorp.com.cn Website: www.intexdevelopment.com | • CHILE / ARGENTINA / PERU / URUGUAY | COMEXA S.A SAN IGNACIO 0201, PARQUE INDUSTRIAL PORTEZUELO, QUILICURA, SANTIAGO, CHILE TEL: 56-2-339 9000 FAX: 56-2-339 9022 E-mail: generalsilfa@silfa.cl |
| • EUROPE | INTEX TRADING B.V. POSTBUS 1075, 4700 BB ROOSENDAAL, THE NETHERLANDS TEL: 31-(0)165-593939 FAX: 31-(0)165-593969 E-mail: service@intexcorp.nl Website: www.intexcorp.nl | • SAUDI ARABIA | SAUDI ARABIAN MARKETING & AGENCIES CO. LTD. PRINCE AMIR MAJED STREET, AL-SAFA DISTRICT, JEDDAH, KINGDOM OF SAUDI ARABIA TEL: 966-2-693 8496 FAX: 966-2-271 4084 E-mail: abid.syed@samaco.com.sa |
| • FRANCE | INTEX SERVICE (FRANCE) SAS 52, ROUTE NATIONALE 39190 BEAUFORT, FRANCE TEL: 08 90 71 20 39 (0.15 TTC/min) FAX: 03 84 25 18 09 E-mail: sav@intexcorp.com.fr Website: www.intex.fr | • AUSTRIA | STEINBACH GMBH AUSTRIA AISTINGERSTRASSE 2 4311 SCHWERTBERG TEL: 0800 468397665 FAX: 07262 61439-0 E-mail: service@intexcorp.at |
| • GERMANY | STEINBACH GMBH GERMANY AN DER WELLE 4 60322 FRANKFURT TEL: 0800 468397665 FAX: 07262 61439-0 E-mail: service@intexcorp.de Website: www.intexcorp.de | • CZECH REPUBLIC / EASTERN EUROPE | INTEX TRADING S.R.O. BENESOVSKA 23, 101 00 PRAHA 10 CZECH REPUBLIC TEL: 420-2-717 32247 FAX: 420-2-673 12552 E-mail: info@intexcorp.cz |
| • ITALY | A & A MARKETING SERVICE OFFICE: VIA DEI MESTIERI 8, 20049 CONCOREZZO, MILANO - ITALY TEL: 39-039-6886260 FAX: 39-039-6043603 E-mail: intex@aeamarketingservice.com Website: www.intexitalia.com | • BELGIUM | N.V. NICOTOY S.A. MOESKROENSENSTEENWEG 383 C, 8511 AALBEKE TEL: 0800 92088 FAX: 32-56.20.37.61 E-mail: intex@nicotoy.be |
| • UK | WAREHOUSE: C/O ALVI, VIALE DELLA REPUBBLICA 10 - 27100 PAVIA - ITALY TOY BROKERS LTD MARKETING HOUSE, BLACKSTONE ROAD HUNTINGDON, CAMBS. PE29 6EE, UK TEL: 01480 414361 FAX: 01480 414761 E-mail: sales@toybrokers.com Website: www.toybrokers.com | • DENMARK | K.E. MATHIASEN A/S SINTRUPVEJ 12 DK-8220 BRABRAND DENMARK TEL: +45 89 44 22 00 FAX: +45 86 24 02 39 E-mail: intex@keleg.dk |
| • SWITZERLAND | GWM AGENCY GARTEN-U. WOHNMOBEL RAFFELSTRASSE 25 POSTFACH CH-8045 ZURICH/SWITZERLAND TEL: + 41 - (0)900 - 455 456 FAX: 41 44 455 50 65 E-mail: gwm@gwm.ch Website: www.gwm.ch | • SWEDEN | LEKSAM AB BRANDSVIGSGATAN 6, S-262 73 ÄNGELHOLM, SWEDEN TEL: +46 431 44 41 20 FAX: +46 431 190 35 E-mail: kundtjanst@leksam.se |
| • SPAIN / PORTUGAL | KOKIDO BVI LIMITED C/PLOMO 5-7, NAVE 19 POLIGONO INDUSTRIAL AIMAYR SAN MARTIN DE LA VEGA 28330 MADRID SPAIN TEL: 34-90-2351045 FAX: 34-91-6912709 E-mail: belen@kokido.com E-mail: info@kokido.com | • NORWAY | NORSTAR AS PINDSLEVEIEN 1 N-3221 SANDEFJORD NORWAY TEL: +47 33 48 74 10 FAX: +47 33 48 74 11 E-mail: intex@norstar.no |
| • AUSTRALIA | HUNTER OVERSEAS PTY LTD LEVEL 1, 225 BAY STREET, BRIGHTON, VICTORIA AUSTRALIA TEL: 61-3-9596-2144 or 1800-224-094 FAX: 61-3-9596-2188 E-mail: enquiries@hunteroverseas.com.au | • FINLAND | NORSTAR OY RUUKINTIE 20 FIN-02330 ESPOO FINLAND TEL: +358 9 8190 5330 FAX: +358 9 8190 5335 E-mail: info@norstar.fi |
| • NEW ZEALAND | HAKA NEW ZEALAND LIMITED UNIT 5, SENTINEL PARK, 25 AIRBORNE ROAD, ALBANY PO BOX 302171, NORTH HARBOUR, AUCKLAND 1330 NEW ZEALAND TEL: 649-4159213 FAX: 649-4159212 E-mail: geoff@hakanz.co.nz | • RUSSIA | LLC BAUER KIEVSKAYA STR., 20, 121165 MOSCOW, RUSSIA TEL: 095-249-9400/8626/9802 FAX: 095-742-8192 E-mail: intex@rdm.ru |
| • MIDDLE EAST REGION | FIRST GROUP TRADING AL MOOSA GROUP BUILDING, 1ST FLOOR, OFFICE 102 & 103, UMM HURAIR ROAD, KARAMA, DUBAI, UAE TEL: 00971-4-3373322 FAX: 00971-4-3375115 E-mail: info@firstgrouptrading.com Website: www.firstgrouptrading.com | • POLAND | KATHAY HASTER UL. LUTYCKA 3, 60-415 POZNAN TEL: +48 61 8498 381/380 FAX: +48 61 8474 487 E-mail: inx@kathay.com.pl |
| • SOUTH AFRICA | WOOD & HYDE 15-17 PACKER AVENUE, INDUSTRIA 2, CAPE TOWN, SOUTH AFRICA 7460 TEL: 27-21-0800-204-692 FAX: 27-21-505-5600 E-mail: ygoldman@thumb.co.za | • HUNGARY | RECONTRA LTD. H-113 BUDAPEST, DARÓCZI ÚT 1-3, HUNGARY TEL: +361 372 5200/113 FAX: +361 209 2634 E-mail: gizi@recontra.hu |
| | | • BRAZIL | KONESUL MARKETING & SALES LTDA RUA INACIO BORBA, 835 - CEP. 04715-020, CHACARA SANTO ANTONIO - SÃO PAULO - SP - BRASIL TEL: 55 (11) 5183 8866 FAX: 55 (11) 5183 8866 E-mail: konesulintex@uol.com.br |

Free Manuals Download Website

<http://myh66.com>

<http://usermanuals.us>

<http://www.somanuals.com>

<http://www.4manuals.cc>

<http://www.manual-lib.com>

<http://www.404manual.com>

<http://www.luxmanual.com>

<http://aubethermostatmanual.com>

Golf course search by state

<http://golfingnear.com>

Email search by domain

<http://emailbydomain.com>

Auto manuals search

<http://auto.somanuals.com>

TV manuals search

<http://tv.somanuals.com>